

THE
ENCYCLOPEDIA
BRITANNICA

ELEVENTH
EDITION

VOL. XXV
SHU TO SUB



THE ENCYCLOPÆDIA BRITANNICA

ELEVENTH EDITION

FIRST	edition, published in three	volumes,	1768—1771.
SECOND	„ „ ten	„	1777—1784.
THIRD	„ „ eighteen	„	1788—1797.
FOURTH	„ „ twenty	„	1801—1810.
FIFTH	„ „ twenty	„	1815—1817.
SIXTH	„ „ twenty	„	1823—1824.
SEVENTH	„ „ twenty-one	„	1830—1842.
EIGHTH	„ „ twenty-two	„	1853—1860.
NINTH	„ „ twenty-five	„	1875—1889.
TENTH	„ ninth edition and eleven		
	supplementary volumes,		1902—1903.
ELEVENTH	„ published in twenty-nine volumes,		1910—1911.

COPYRIGHT
in all countries subscribing to the
Bern Convention
by
THE CHANCELLOR, MASTERS AND SCHOLARS
of the
UNIVERSITY OF CAMBRIDGE

All rights reserved

THE
ENCYCLOPÆDIA BRITANNICA

A
DICTIONARY
OF
ARTS, SCIENCES, LITERATURE AND GENERAL
INFORMATION

ELEVENTH EDITION

VOLUME XXV
SHUVÁLOV to SUBLIMINAL SELF



Cambridge, England:
at the University Press
New York, 35 West 32nd Street
1911

AE 5
E 3
R

Copyright, in the United States of America, 1911,
by
The Encyclopædia Britannica Company

BRITANNICA
ENCYCLOPEDIA

INITIALS USED IN VOLUME XXV. TO IDENTIFY INDIVIDUAL
CONTRIBUTORS,¹ WITH THE HEADINGS OF THE
ARTICLES IN THIS VOLUME SO SIGNED.

A. B. G.	REV. ALEXANDER BALLOCH GROSART, LL.D., D.D. See the biographical article: GROSART, ALEXANDER BALLOCH.	{ Stirling, William Alexander, Earl of (<i>in part</i>).
A. C. McG.	ARTHUR CUSHMAN MCGIFFERT, M.A., PH.D., D.D. Professor of Church History, Union Theological Seminary, New York. Author of <i>History of Christianity in the Apostolic Age</i> ; &c. Editor of the <i>Historia Ecclesiae</i> of Eusebius.	{ Socrates (<i>Church Historian</i>) (<i>in part</i>); Sozomen (<i>in part</i>).
A. D.	HENRY AUSTIN DOBSON, LL.D., D.C.L. See the biographical article: DOBSON, H. AUSTIN.	{ Steele, Sir Richard (<i>in part</i>); Sterne, Laurence (<i>in part</i>).
A. De.	ARTHUR DENDY, D.Sc., F.R.S., F.Z.S., F.L.S. Professor of Zoology in King's College, London. Zoological Secretary of the Linnean Society of London. Author of memoirs on systematic zoology, comparative anatomy, embryology, &c.	{ Sponges.
A. E. H.	A. E. HOUGHTON. Formerly Correspondent of the <i>Standard</i> in Spain. Author of <i>Restoration of the Bourbons in Spain</i> .	{ Spain: <i>History</i> (<i>in part</i>).
A. E. S.	ARTHUR EVERETT SHIPLEY, M.A., D.Sc., F.R.S. Master of Christ's College, Cambridge. Reader in Zoology, Cambridge University. Joint-editor of the <i>Cambridge Natural History</i> .	{ Sipunculoidea; Smith, William Robertson.
A. F. E.	ALLEN F. EVERETT. Commander, R.N. Formerly Superintendent of the Signal School, H.M.S. "Victory," Portsmouth.	{ Signal: <i>Marine Signalling</i> (<i>in part</i>).
A. F. P.	ALBERT FREDERICK POLLARD, M.A., F.R.HIST.SOC. Fellow of All Souls College, Oxford. Professor of English History in the University of London. Assistant Editor of the <i>Dictionary of National Biography</i> , 1893-1901. Author of <i>England under the Protector Somerset</i> ; <i>Life of Thomas Cranmer</i> ; &c.	{ Somerset, Edward Seymour, Duke of.
A. Go.*	REV. ALEXANDER GORDON, M.A. Lecturer in Church History in the University of Manchester.	{ Socinus.
A. Ha.	ADOLF HARNACK, D.PH. See the biographical article: HARNACK, ADOLF.	{ Socrates (<i>Church Historian</i>) (<i>in part</i>); Sozomen (<i>in part</i>).
A. H. S.	REV. ARCHIBALD HENRY SAYCE, LITT.D., LL.D. See the biographical article: SAYCE, A. H.	{ Sippara.
A. J. G.	REV. ALEXANDER JAMES GRIEVE, M.A., B.D. Professor of New Testament and Church History at the United Independent College, Bradford. Sometime Registrar of Madras University and Member of Mysore Educational Service.	{ Smyth, John.
A. Ma.	ALEXANDER MACALISTER, M.A., LL.D., M.D., D.Sc., F.R.S. Professor of Anatomy in the University of Cambridge, and Fellow of St John's College. Formerly Professor of Zoology in the University of Dublin. Author of <i>Text-Book of Human Anatomy</i> ; &c.	{ Stigmatization.
A. Mel.	ARTHUR MELLOR. Of Messrs J. & T. Brocklehurst & Sons, Silk Manufacturers, Macclesfield.	{ Silk: <i>Spinning of "Silk Waste"</i> .
A. M. C.	AGNES MARY CLERKE. See the biographical article: CLERKE, AGNES M.	{ Smyth, Charles Piazzl; Stone, Edward James.
A. M. F.*	ARTHUR MOSTYN FIELD, F.R.S., F.R.A.S., F.R.G.S., F.R.MET.S. Vice-Admiral, R.N. Admiralty Representative on Port of London Authority. Hydrographer of the Royal Navy, 1904-1909.	{ Sounding.

¹ A complete list, showing all individual contributors, appears in the final volume.

- A. M.-Fa.** ALFRED MOREL-FATIO.
Professor of Romance Languages at the Collège de France, Paris. Member of the Institute of France; Chevalier of the Legion of Honour. Secretary of the École des Chartes, 1885-1906; &c. Author of *L'Espagne au XVI^e et au XVII^e siècles*.
- A. N.** ALFRED NEWTON, F.R.S.
See the biographical article: NEWTON, ALFRED.
- A. P. H.** ALFRED PETER HILLIER, M.D., M.P.
Author of *South African Studies; The Commonwealth*; &c. Served in Kaffir War, 1878-1879. Partner with Dr L. S. Jameson in medical practice in South Africa till 1896. Member of Reform Committee, Johannesburg, and Political Prisoner at Pretoria, 1895-1896. M.P. for Hitchin division of Herts, 1910.
- A. S.*** ARTHUR SCHUSTER, F.R.S., PH.D., D.Sc.
Professor of Physics at the University of Manchester, 1888-1907. President of the International Association of Seismology. Author of *Theory of Optics* and papers in the *Proceedings and Transactions* of the Royal Society.
- A. So.** ALBRECHT SOCIN, PH.D. (1844-1899).
Formerly Professor of Semitic Philology in the Universities of Leipzig and Tübingen. Author of *Arabische Grammatik*; &c.
- A. S. E.** ARTHUR STANLEY EDDINGTON, M.A., M.Sc., F.R.A.S.
Chief Assistant at the Royal Observatory, Greenwich. Fellow of Trinity College, Cambridge.
- A. S. P.-P.** ANDREW SETH PRINGLE-PATTISON, M.A., LL.D., D.C.L.
Professor of Logic and Metaphysics in the University of Edinburgh. Gifford Lecturer in the University of Aberdeen, 1911. Fellow of the British Academy. Author of *Man's Place in the Cosmos; The Philosophical Radicals*; &c.
- A. W. H.*** ARTHUR WILLIAM HOLLAND.
Formerly Scholar of St John's College, Oxford. Bacon Scholar of Gray's Inn, 1900.
- A. W. P.** ALFRED WALLIS PAUL, C.I.E.
Member of the Indian Civil Service, 1870-1895. Political Officer, Sikkim Expedition. British Commissioner under Anglo-Chinese Convention of 1890. Deputy Commissioner of Darjeeling.
- B. B. A.** BRAMAN BLANCHARD ADAMS.
Associate Editor of the *Railway Age Gazette*, New York.
- B. K.*** BENJAMIN KIDD, D.C.L.
Author of *Social Evolution; Principles of Western Civilization*; &c.
- B. W. G.** BENEDICT WILLIAM GINSBURG, M.A., LL.D.
St Catharine's College, Cambridge. Barrister-at-Law of the Inner Temple. Formerly Editor of the *Navy*, and Secretary of the Royal Statistical Society. Author of *Hints on the Legal Duties of Shipmasters*; &c.
- C. A. G. B.** SIR CYPRIAN ARTHUR GEORGE BRIDGE, G.C.B.
Admiral R.N. Commander-in-Chief, China Station, 1901-1904. Director of Naval Intelligence, 1889-1894. Author of *The Art of Naval Warfare; Sea-Power and other Studies*; &c.
- C. B.*** CHARLES BÉMONT, LITT.D. (OXON.).
See the biographical article: BÉMONT, CHARLES.
- C. D. W.** HON. CARROLL DAVIDSON WRIGHT.
See the biographical article: WRIGHT, HON. CARROLL DAVIDSON.
- C. F. A.** CHARLES FRANCIS ATKINSON.
Formerly Scholar of Queen's College, Oxford. Captain, 1st City of London (Royal Fusiliers). Author of *The Wilderness and Cold Harbor*.
- C. H.*** SIR CHARLES HOLROYD, LITT. D.
See the biographical article: HOLROYD, SIR CHARLES.
- C. H. Ha.** CARLTON HUNTLEY HAYES, A.M., PH.D.
Assistant Professor of History in Columbia University, New York. Member of the American Historical Association.
- C. L. K.** CHARLES LETHBRIDGE KINGSFORD, M.A., F.R.HIST. SOC., F.S.A.
Assistant Secretary to the Board of Education. Author of *Life of Henry V*. Editor of *Chronicles of London* and *Stow's Survey of London*.
- C. P.*** CARL PULFRICH, PH.D.
On the staff of the Carl Zeiss Factory, Jena. Formerly Privatdozent at the University of Bonn. Member of the Astronomical Societies of Brussels and Paris.
- C. Pa.** CESARE PAOLI.
See the biographical article: PAOLI, CESARE.
- C. Pf.** CHRISTIAN PFISTER, D. ÈS L.
Professor at the Sorbonne, Paris. Chevalier of the Legion of Honour. Author of *Études sur le règne de Robert le Pieux; Le Duché merovingien d'Alsace et la légende de Sainte-Odile*.
- C. R. B.** CHARLES RAYMOND BEAZLEY, M.A., D.LITT., F.R.G.S., F.R.HIST.S.
Professor of Modern History in the University of Birmingham. Formerly Fellow of Merton College, Oxford, and University Lecturer in the History of Geography. Lothian prizeman, Oxford, 1889. Lowell Lecturer, Boston, 1908. Author of *Henry the Navigator; The Dawn of Modern Geography*; &c.
- Spain: Language (in part), and Literature (in part).**
- Siskin; Skimmer; Skua; Snake-bird; Snipe; Sparrow; Spoonbill; Stilt; Stork.**
- South Africa: History (in part).**
- Spectroscopy.**
- Sinai: The Biblical Mount Sinai.**
- Star.**
- Spinoza.**
- Sidmouth, Viscount.**
- Sikkim.**
- Signal: Army Signalling (in part), and Railway Signalling (in part).**
- Sociology.**
- Steamship Lines.**
- Signal: Marine Signalling (in part).**
- Sorel, Albert.**
- Strikes and Lock-outs: United States.**
- Spanish Succession, War of (in part).**
- Strang, William.**
- Sixtus IV.; Stilicho, Flavius.**
- Somerset, Edmund Beaufort, Duke of.**
- Stereoscope.**
- Siena (in part).**
- Sigebert, King.**
- Simon of St Quentin; Sindbad the Sailor, Voyages of.**

- C. S. S.** CHARLES SCOTT SHERRINGTON, M.A., D.Sc., M.D., F.R.S., LL.D.
Professor of Physiology in the University of Liverpool. Author of *The Integrative Action of the Nervous System*. } **Spinal Cord: Physiology.**
- C. W. W.** SIR CHARLES WILLIAM WILSON, K.C.B., K.C.M.G., F.R.S. (1836-1907).
Major-General, Royal Engineers. Secretary to the North American Boundary Commission, 1858-1862. British Commissioner on the Servian Boundary Commission. Director-General of the Ordnance Survey, 1886-1894. Director-General of Military Education, 1895-1898. Author of *From Korti to Khartoum*; *Life of Lord Clive*; &c. } **Sivas (in part).**
- D. F. T.** DONALD FRANCIS TOVEY.
Author of *Essays in Musical Analysis*: comprising *The Classical Concerto*, *The Goldberg Variations*, and analyses of many other classical works. } **Sonata Forms;
Spohr, Ludwig.**
- D. G. H.** DAVID GEORGE HOGARTH, M.A.
Keeper of the Ashmolean Museum, Oxford. Fellow of Magdalen College, Oxford. Fellow of the British Academy. Excavated at Paphos, 1888; Naucratis, 1899 and 1903; Ephesus, 1904-1905; Assiut, 1906-1907. Director, British School at Athens, 1897-1900. Director, Cretan Exploration Fund, 1899. } **Side; Sis;
Sivas (in part);
Smyrna (in part);
Soli (Asia Minor).**
- D. H.** DAVID HANNAY.
Formerly British Vice-Consul at Barcelona. Author of *Short History of the Royal Navy*; *Life of Emilio Castelar*; &c. } **Sluys, Battle of;
Spain: History (in part);
Spanish Succession, War of:
Naval and Military Operations;
Spinola, Ambrose.**
- D. M. W.** SIR DONALD MACKENZIE WALLACE, K.C.I.E., K.C.V.O.
Extra Groom of the Bedchamber to H.M. King George V. Director of the Foreign Department of *The Times*, 1891-1899. Member of Institut de Droit International and Officier de l'Instruction Publique of France. Joint-editor of the New Volumes (10th ed.) of the *Encyclopaedia Britannica*. Author of *Russia*; *Egypt and the Egyptian Question*; *The Web of Empire*; &c. } **Shuvalov, Count.**
- E. A.** EDWARD ARBER, D.LITT., F.S.A.
See the biographical article: ARBER, EDWARD. } **Smith, John (1579-1631).**
- E. A. F.** EDWARD AUGUSTUS FREEMAN, LL.D., D.C.L.
See the biographical article: FREEMAN, E. A. } **Sicily: History (in part).**
- E. C. B.** RT. REV. EDWARD CUTHBERT BUTLER, O.S.B., M.A., D.LITT.
Abbot of Downside Abbey, Bath. Author of "The Lausiac History of Palladius" in *Cambridge Texts and Studies*. } **Silvestrines;
Simeon Stylites, St.**
- E. G.** EDMUND GOSSE, LL.D.
See the biographical article: GOSSE, EDMUND. } **Song (Literary);
Stanley, Thomas;
Stevenson, Robert Louis;
Style.**
- E. H. M.** ELLIS HOVELL MINNS, M.A.
University Lecturer in Palaeography, Cambridge. Lecturer and Assistant Librarian at Pembroke College, Cambridge. Formerly Fellow of Pembroke College. } **Slavs;
Slovaks;
Slovenes; Sorbs.**
- Ed. M.** EDUARD MEYER, PH.D., D.LITT., LL.D.
Professor of Ancient History in the University of Berlin. Author of *Geschichte des Alterthums*; *Geschichte des alten Aegyptens*; *Die Israeliten und ihre Nachbarstämme*. } **Smerdis.**
- E. Ma.** EDWARD MANSON.
Barrister-at-Law. Joint-editor of the *Journal of Comparative Legislation*. Author of *Law of Trading Companies*; *Practical Guide to Company Law*; &c. } **Stocks and Shares.**
- E. M. S.** ELEANOR MILDRED SIDGWICK (MRS HENRY SIDGWICK), D.LITT., LL.D.
Principal of Newnham College, Cambridge, 1892-1910. Hon. Secretary to the Society for Psychical Research. Author of Papers in the *Proceedings* of the Society for Psychical Research. } **Spiritualism.**
- E. M. T.** SIR EDWARD MAUNDE THOMPSON, G.C.B., I.S.O., D.C.L., LITT.D., LL.D.
Director and Principal Librarian, British Museum, 1898-1909. Sanders Reader in Bibliography, Cambridge University, 1895-1896. Hon. Fellow of University College, Oxford. Author of *Handbook of Greek and Latin Palaeography*. Editor of the *Chronicon Angliae*. Joint-editor of publications of the Palaeographical Society, the New Palaeographical Society, and of the Facsimile of the Laurentian Sophocles. } **Stichometry.**
- E. O.*** EDMUND OWEN, F.R.C.S., LL.D., D.Sc.
Consulting Surgeon to St Mary's Hospital, London, and to the Children's Hospital, Great Ormond Street, London. Chevalier of the Legion of Honour. Author of *A Manual of Anatomy for Senior Students*. } **Skull: Cranial Surgery
Spinal Cord (Surgery);
Stomach.**
- E. Pr.** EDGAR PRESTAGE.
Special Lecturer in Portuguese Literature in the University of Manchester. Comendador, Portuguese Order of S. Thiago. Corresponding Member of Lisbon Royal Academy of Sciences and Lisbon Geographical Society; &c. } **Silva, Antonio J. da;
Souza, Luiz de.**
- E. W. H.** ERNEST WILLIAM HOBSON, M.A., D.Sc., F.R.S., F.R.A.S.
Fellow and Tutor in Mathematics, Christ's College, Cambridge. Stokes Lecturer in Mathematics in the University. } **Spherical Harmonics.**
- F. A. B.** FRANCIS ARTHUR BATHER, M.A., D.Sc., F.R.S., F.R.G.S.
Assistant Keeper of Geology, British Museum. Rolleston Prizeman, Oxford, 1892. Author of "Echinoderma" in *A Treatise on Zoology; Triassic Echinoderms of Bakony*; &c. } **Starfish.**

- F. C. S. S.** FERDINAND CANNING SCOTT SCHILLER, M.A., D.Sc.
Fellow and Tutor of Corpus Christi College, Oxford. Author of *Riddles of the Sphinx*; *Studies in Humanism*; &c. } **Spencer, Herbert.**
- F. G. M. B.** FREDERICK GEORGE MEESON BECK, M.A.
Fellow and Lecturer in Classics, Clare College, Cambridge. } **Sigurd;**
Strathclyde.
- F. G. P.** FREDERICK GYMER PARSONS, F.R.C.S., F.Z.S., F.R.ANTHROP.INST.
Vice-President, Anatomical Society of Great Britain and Ireland. Lecturer on Anatomy at St Thomas's Hospital and the London School of Medicine for Women, London. Formerly Hunterian Professor at the Royal College of Surgeons. } **Skeleton;**
Skin and Exoskeleton;
Skull;
Spinal Cord (in part).
- F. J. H.** FRANCIS JOHN HAVERFIELD, M.A., LL.D., F.S.A.
Camden Professor of Ancient History in the University of Oxford. Fellow of Brasenose College. Formerly Censor, Student, Tutor and Librarian of Christ Church. Ford's Lecturer, 1906-1907. Fellow of the British Academy. Author of Monographs on Roman History, especially Roman Britain; &c. } **Silures;**
Spain: History, Ancient.
- F. J. S.** FREDERICK JOHN SNELL, M.A.
Balliol College, Oxford. Author of *The Age of Chaucer*; &c. } **Spenser, Edmund (in part).**
- F. LL. G.** FRANCIS LEWELLYN GRIFFITH, M.A., PH.D., F.S.A.
Reader in Egyptology, Oxford University. Editor of the Archaeological Survey and Archaeological Reports of the Egypt Exploration Fund. Fellow of Imperial German Archaeological Institute. Author of *Stories of the High Priests of Memphis*; &c. } **Sphinx (in part).**
- F. L. L.** LADY LUGARD.
See the biographical article: LUGARD, SIR F. J. D. } **Sokoto.**
- F. N. M.** COLONEL FREDERIC NATUSCH MAUDE, C.B.
Lecturer in Military History, Manchester University. Author of *War and the World's Policy*; *The Leipzig Campaign*; *The Jena Campaign*. } **Strategy.**
- F. Po.** SIR FREDERICK POLLOCK, BART., LL.D., D.C.L.
See the biographical article: POLLOCK: *Family*. } **Stephen, Sir J. F., Bart.**
- F. R. C.** FRANK R. CANA.
Author of *South Africa from the Great Trek to the Union*. } **Siwa; Sobat (in part);**
Somaliland;
South Africa: Geography and
Statistics; History (in part),
and Bibliography;
Stanley, Sir Henry.
- F. W.*** FRANK WARNER.
President of the Silk Association of Great Britain and Ireland; Hon. Secretary of the Ladies' National Silk Association. Chairman of the Silk Section, London Chamber of Commerce, and of the Council of the Textile Institute. } **Silk (in part).**
- F. W. R.*** FREDERICK WILLIAM RUDLER, I.S.O., F.G.S.
Curator and Librarian of the Museum of Practical Geology, London, 1879-1902. President of the Geologists' Association, 1887-1889. } **Sinter;**
Spinel;
Spodumene.
- G. A. C.*** REV. GEORGE ALBERT COOKE, D.D.
Oriel Professor of the Interpretation of Holy Scripture, Oxford, and Fellow of Oriel College. Canon of Rochester. Hon. Canon of St Mary's Cathedral, Edinburgh. Author of *Text-Book of North Semitic Inscriptions*; &c. } **Sidon.**
- G. A. Gr.** GEORGE ABRAHAM GRIERSON, C.I.E., PH.D., D.LITT.
Member of the Indian Civil Service, 1873-1903. In charge of the Linguistic Survey of India, 1898-1902. Gold Medallist, Royal Asiatic Society, 1909. Vice-President of the Royal Asiatic Society. Formerly Fellow of Calcutta University. Author of *The Languages of India*; &c. } **Sindhi and Lahnda.**
- G. C. L.** GEORGE COLLINS LEVEY, C.M.G.
Member of the Board of Advice to the Agent-General of Victoria. Formerly Editor and Proprietor of the *Melbourne Herald*. Secretary, Colonial Committee of Royal Commission to Paris Exhibition, 1900. Secretary, Adelaide Exhibition, 1887. Secretary, Royal Commission, Hobart Exhibition, 1894-1895. Secretary to Commissioners for Victoria at the Exhibitions in London, Paris, Vienna, Philadelphia and Melbourne. } **Stawell, Sir William.**
- G. C. W.** GEORGE CHARLES WILLIAMSON, LITT.D.
Chevalier of the Legion of Honour. Author of *Portrait Miniatures; Life of Richard Cosway, R.A.*; *George Engleheart*; *Portrait Drawings*; &c. Editor of new edition of Bryan's *Dictionary of Painters and Engravers*. } **Smart, John.**
- G. E. H.** GEORGE ELLERY HALE, LL.D., SC.D.
Director of the Mt. Wilson Solar Observatory of the Carnegie Institution of Washington at Pasadena, California. Director of the Yerkes Observatory, Chicago, 1895-1905. Foreign Member of the Royal Society of London. Inventor of the Spectroheliograph. Author of Papers on solar and stellar physics in the *Astrophysical Journal*; &c. } **Spectroheliograph.**
- G. G. B.** VERY REV. GEORGE GRANVILLE BRADLEY, D.D.
See the biographical article: BRADLEY, GEORGE GRANVILLE. } **Stanley, Dean (in part).**
- G. G. C.** GEORGE GOUDIE CHISHOLM, M.A.
Lecturer on Geography in the University of Edinburgh. Secretary of the Royal Scottish Geographical Society. Author of *Handbook of Commercial Geography*. Editor of Longman's *Gazetteer of the World*. } **Sicily: Geography and**
Statistics (in part).
- G. G. S.** GEORGE GREGORY SMITH, M.A.
Professor of English Literature, Queen's University of Belfast. Author of *The Days of James IV.*; *The Transition Period*; *Specimens of Middle Scots*; &c. } **Stirling, William Alexander,**
Earl of (in part).

- G. J. T.** GEORGE JAMES TURNER.
Barrister-at-Law, Lincoln's Inn. Editor of *Select Pleas of the Forests* for the Selden Society. } **Soke.**
- G. Mo.** GAETANO MOSCA.
Professor of Constitutional Law, University of Turin. } **Sicily: Geography and Statistics (in part).**
- G. Sa.** GEORGE SAINTSBURY, D.C.L., LL.D.
See the biographical article: SAINTSBURY, GEORGE E. B. } **Staël, Madame de.**
- G. W. T.** REV. GRIFFITHES WHEELER THATCHER, M.A., B.D.
Warden of Camden College, Sydney, N.S.W. Formerly Tutor in Hebrew and Old Testament History at Mansfield College, Oxford. } **Sibawaihi.**
- H. Br.** HENRY BRADLEY, M.A., PH.D.
Fellow of the British Academy. Joint-editor of the *New English Dictionary* (Oxford). Author of *The Story of the Goths*; *The Making of English*; &c. } **Slang.**
- H. Cl.** SIR HUGH CHARLES CLIFFORD, K.C.M.G.
Colonial Secretary, Ceylon. Fellow of the Royal Colonial Institute. Formerly Resident, Pahang. Colonial Secretary, Trinidad and Tobago, 1903-1907. Author of *Studies in Brown Humanity*; *Further India*, &c. Joint-author of *A Dictionary of the Malay Language*. } **Singapore; Straits Settlements.**
- H. E. S.*** HORACE ELISHA SCUDDER (d. 1902).
Formerly Editor of the *Atlantic Monthly*. Author of *Life of James Russell Lowell*; *History of the United States*; &c. } **Stowe, Mrs Beecher.**
- H. F. G.** HANS FRIEDRICH GADOW, M.A., F.R.S., PH.D.
Strickland Curator and Lecturer on Zoology in the University of Cambridge. Author of "Amphibia and Reptiles" in the *Cambridge Natural History*; &c. } **Snakes; Song: Of Birds; Sphenodon.**
- H. H. F.** H. HAMILTON FYFE.
Special Correspondent of the *Daily Mail*; Dramatic critic of *The World*. Author of *A Modern Aspsasia*; *The New Spirit in Egypt*; &c. } **Stepniak, Sergius.**
- H. Ja.** HENRY JACKSON, M.A., LITT.D., LL.D., O.M.
Regius Professor of Greek in the University of Cambridge, and Fellow of Trinity College. Fellow of the British Academy. Author of *Texts to illustrate the History of Greek Philosophy from Thales to Aristotle*. } **Socrates; Sophists; Speusippus.**
- H. M. R.** HUGH MUNRO ROSS.
Formerly Exhibitioner of Lincoln College, Oxford. Editor of *The Times Engineering Supplement*. Author of *British Railways*. } **Signal: Army Signalling (in part) and Railway Signalling (in part).**
- H. M. Wo.** HAROLD MELLOR WOODCOCK, D.Sc.
Assistant to the Professor of Proto-Zoology, London University. Fellow of University College, London. Author of "Haemoflagellates" in Sir E. Ray Lankester's *Treatise of Zoology*, and of various scientific papers. } **Sporozoa.**
- H. O. F.** HENRY OGG FORBES, LL.D., F.R.G.S., F.G.S., F.Z.S.
Director of Museums to the Corporation of Liverpool. Reader in Ethnography in the University of Liverpool. Explorer of Mount Owen Stanley, New Guinea, Chatham Islands and Sokotra. Author of *A Naturalist's Wanderings in the Eastern Archipelago*; Editor and part-author of *Natural History of Sokotra and Abd-el-Kuri*; &c. } **Sokotra (in part).**
- H. R. T.** HENRY RICHARD TEDDER, F.S.A.
Secretary and Librarian of the Athenaeum Club, London. } **Societies, Learned.**
- H. St.** HENRY STURT, M.A.
Author of *Idola Theatri*; *The Idea of a Free Church*; *Personal Idealism*. } **Space and Time.**
- H. S. J.** HENRY STUART JONES, M.A.
Formerly Fellow and Tutor of Trinity College, Oxford, and Director of the British School at Rome. Member of the German Imperial Archaeological Institute. Author of *The Roman Empire*; &c. } **Strabo.**
- H. W. C. D.** HENRY WILLIAM CARLESS DAVIS, M.A.
Fellow and Tutor of Balliol College, Oxford. Fellow of All Souls' College, Oxford, 1895-1902. Author of *England under the Normans and Angevins*; *Charlemagne*. } **Simeon of Durham; Stephen, King of England.**
- I. A.** ISRAEL ABRAHAMS, M.A.
Reader in Talmudic and Rabbinic Literature in the University of Cambridge. Formerly President, Jewish Historical Society of England. Author of *A Short History of Jewish Literature*; *Jewish Life in the Middle Ages*; *Judaism*; &c. } **Simon Ben Yoḥai; Singer, Simeon; Smolenskin, Perez; Steinschneider, M.**
- J. A. Co.** HON. SIR JOHN ALEXANDER COCKBURN, K.C.M.G., M.D.
Knight of Grace of the Order of St John of Jerusalem. Premier and Chief Secretary, South Australia, 1889-1890; Minister of Education and Agriculture, 1893-1898; Agent-General in London, 1898-1901. Author of *Australian Federation*; &c. } **South Australia: History.**
- J. A. E.** JAMES ALFRED EWING, C.B., LL.D., F.R.S., M.INST.C.E.
Director of (British) Naval Education. Hon. Fellow of King's College, Cambridge. Professor of Mechanism and Applied Mechanics in the University of Cambridge, 1890-1903. Author of *The Strength of Materials*; &c. } **Siemens, Sir William; Steam Engine; Strength of Materials.**
- J. A. H.** JOHN ALLEN HOWE.
Curator and Librarian of the Museum of Practical Geology, London. Author of *Geology of Building Stones*. } **Silurian.**
- J. B.** JAMES BONAR, M.A., LL.D.
Master of the Royal Mint, Ottawa. Senior Examiner to the Civil Service Commission, 1895-1907. Author of *Malthus and his Work*; *Philosophy and Political Economy*; &c. } **Socialism.**

- J. Bra.** JOSEPH BRAUN, S.J.
Author of *Die Liturgische Gewandung*; &c. { **Stole.**
- J. Bt.** JAMES BARTLETT.
Lecturer on Construction, Architecture, Sanitation, Quantities, &c., at King's College, London. Member of Society of Architects. Member of Institute of Junior Engineers. { **Staircase: Construction; Steel Construction; Stone.**
- J. C. Br.** JOHN CASPER BRANNER, PH.D., LL.D., F.G.S.
Vice-President and Professor of Geology in Leland Stanford University, California. Director of the Branner-Agassiz Expedition to Brazil, 1899. State Geologist of Arkansas, 1887-1893. Author of numerous works on the geology of Brazil, Arkansas and California. { **South America.**
- J. D. B.** JAMES DAVID BOURCHIER, M.A., F.R.G.S.
King's College, Cambridge. Correspondent of *The Times* in South-Eastern Europe. Commander of the Orders of Prince Danilo of Montenegro and of the Saviour of Greece, and Officer of the Order of St Alexander of Bulgaria. { **Silistria; Sofia; Stambolov, Stefan.**
- J. F.-K.** JAMES FITZMAURICE-KELLY, LITT.D., F.R.HIST.S.
Gilmour Professor of Spanish Language and Literature, Liverpool University. Norman McColl Lecturer, Cambridge University. Fellow of the British Academy. Member of the Royal Spanish Academy. Knight Commander of the Order of Alphonso XII. Author of *A History of Spanish Literature*; &c. { **Spain: Language (in part). and Literature (in part).**
- J. G. C. A.** JOHN GEORGE CLARK ANDERSON, M.A.
Censor and Tutor of Christ Church, Oxford. Formerly Fellow of Lincoln College. Craven Fellow, Oxford, 1896. Conington Prizeman, 1893. { **Sinope.**
- J. G. M.** JOHN GRAY MCKENDRICK, M.D., LL.D., F.R.S., F.R.S. (Edin.).
Emeritus Professor of Physiology in the University of Glasgow. Professor of Physiology, 1876-1906. Author of *Life in Motion*; *Life of Helmholtz*; &c. { **Sleep; Smell.**
- J. H. A. H.** JOHN HENRY ARTHUR HART, M.A.
Fellow, Theological Lecturer and Librarian, St John's College, Cambridge. { **Sibylline Oracles.**
- J. H. P.** JOHN HENRY POYNTING, D.Sc., F.R.S.
Professor of Physics and Dean of the Faculty of Science in the University of Birmingham. Formerly Fellow of Trinity College, Cambridge. Joint-author of *Text-Book of Physics*. { **Sound.**
- J. H. R.** JOHN HORACE ROUND, M.A., LL.D.
Balliol College, Oxford. Author of *Feudal England*; *Studies in Peerage and Family History*; *Peerage and Pedigree*; &c. { **Stafford: Family; Stanley: Family (in part).**
- J. Hl. R.** JOHN HOLLAND ROSE, M.A., LITT.D.
Christ's College, Cambridge. Lecturer on Modern History to the Cambridge University Local Lectures Syndicate. Author of *Life of Napoleon I.*; *Napoleonic Studies*; *The Development of the European Nations*; *The Life of Pitt*; &c. { **Sieyès, Emmanuel Joseph; Stein, Baron.**
- J. H. van't H.** JACOBUS HENDRICUS VAN'T HOFF, LL.D., D.Sc.,
See the biographical article VAN'T HOFF, JACOBUS HENDRICUS. { **Stereo-isomerism.**
- J. K. I.** JOHN KELLS INGRAM, LL.D.
See the biographical article: INGRAM, JOHN KELLS. { **Slavery (in part); Smith, Adam (in part).**
- J. L. M.** JOHN LINTON MYRES, M.A., F.S.A.
Wykeham Professor of Ancient History in the University of Oxford, and Fellow of Magdalen College. Formerly Gladstone Professor of Greek and Lecturer in Ancient Geography in the University of Liverpool, and Lecturer on Classical Archaeology in the University of Oxford. { **Soli (Cyprus).**
- J. L. N.** J. LANE-NOTTER, M.A., M.D., F.R.S.MED.
Colonel (retired), Royal Army Medical Corps. Formerly Professor of Military Hygiene, Army Medical School at Netley. Author of *The Theory and Practice of Hygiene*; &c. { **Soil: Soil and Disease.**
- J. M.** SIR JOHN MACDONELL, C.B., M.A., LL.D.
Master of the Supreme Court, London. Formerly Counsel to the Board of Trade and the London Chamber of Commerce. Quain Professor of Comparative Law, and Dean of the Faculty of Law, University College, London. Editor of *State Trials*; *Civil Judicial Statistics*; &c. Author of *Survey of Political Economy*; *The Land Question*; &c. { **Soversignty; Spheres of Influence.**
- J. M. M.** JOHN MALCOLM MITCHELL.
Sometime Scholar of Queen's College, Oxford. Lecturer in Classics, East London Collège (University of London). Joint-editor of Grote's *History of Greece*. { **Solon; Sphinx (in part); Strategus.**
- J. O. N.** REV. JAMES OKEY NASH, M.A.
Hertford College, Oxford. Headmaster of St John's College, Johannesburg. Formerly Missionary of the S.P.G. in Johannesburg. { **Sisterhoods.**
- J. Pe.** JOHN PERCIVAL, M.A.
St. John's College, Cambridge. Professor of Agricultural Botany at University College, Reading. Author of *Text-Book of Agricultural Botany*; &c. { **Soil.**
- J. P. E.** JEAN PAUL HIPPOLYTE EMMANUEL ADHÉMAR ESMEIN.
Professor of Law in the University of Paris. Officer of the Legion of Honour. Member of the Institute of France. Author of *Cours élémentaire d'histoire du droit français*; &c. { **States-General: France.**
- J. S. F.** JOHN SMITH FLETT, D.Sc., F.G.S.
Petrographer to the Geological Survey of the United Kingdom. Formerly Lecturer on Petrology in Edinburgh University. Neill Medallist of the Royal Society of Edinburgh. Bigsby Medallist of the Geological Society of London. { **Sill; Slate: Geology; Spherulites.**

- J. S. R.** JAMES SMITH REID, M.A., LL.M., LITT.D., LL.D.
Professor of Ancient History in the University of Cambridge and Fellow and Tutor of Gonville and Caius College. Hon. Fellow, formerly Fellow and Lecturer, of Christ's College. Editor of Cicero's *Academica*; *De Amicitia*; &c.
- J. T. Be.** JOHN THOMAS BEALBY.
Joint-author of Stanford's *Europe*. Formerly Editor of the *Scottish Geographical Magazine*. Translator of Sven Hedin's *Through Asia, Central Asia and Tibet*; &c.
- J. V. B.** JAMES VERNON BARTLET, M.A., D.D.
Professor of Church History, Mansfield College, Oxford. Author of *The Apostolic Age*; &c.
- J. W.** JAMES WILLIAMS, M.A., D.C.L., LL.D.
All Souls' Reader in Roman Law in the University of Oxford, and Fellow of Lincoln College. Barrister-at-Law of Lincoln's Inn. Author of *Law of the Universities*; &c.
- J. W. G.** JOHN WALTER GREGORY, D.Sc., F.R.S.
Professor of Geology in the University of Glasgow. Professor of Geology and Mineralogy in the University of Melbourne, 1900-1904. Author of *The Dead Heart of Australia*; &c.
- J. W. He.** JAMES WYCLIFFE HEADLAM, M.A.
Staff Inspector of Secondary Schools under the Board of Education. Formerly Fellow of King's College, Cambridge, and Professor of Greek and Ancient History at Queen's College, London. Author of *Bismarck and the Foundation of the German Empire*; &c.
- K. G. J.** KINGSLEY GARLAND JAYNE.
Sometime Scholar of Wadham College, Oxford. Matthew Arnold Prizeman, 1903. Author of *Vasco da Gama and his Successors*.
- K. L.** REV. KIRSOPP LAKE, M.A.
Lincoln College, Oxford. Professor of Early Christian Literature and New Testament Exegesis in the University of Leiden. Author of *The Text of the New Testament*; *The Historical Evidence for the Resurrection of Jesus Christ*; &c.
- K. S.** KATHLEEN SCHLESINGER.
Editor of the *Portfolio of Musical Archaeology*. Author of *The Instruments of the Orchestra*.
- L. C.** REV. LEWIS CAMPBELL, D.C.L., LL.D.
See the biographical article: CAMPBELL, LEWIS.
- L. D.*** LOUIS DUCHESNE.
See the biographical article: DUCHESNE, LOUIS M. O.
- L. J. S.** LEONARD JAMES SPENCER, M.A.
Assistant in Department of Mineralogy, British Museum. Formerly Scholar of Sidney Sussex College, Cambridge, and Harkness Scholar. Editor of the *Mineralogical Magazine*.
- L. W. Ch.** LAURENCE WENSLEY CHUBB.
Secretary of the Coal Smoke Abatement Society, and of the Commons and Footpaths Preservation Society.
- M. Ca.** MORITZ CANTOR, PH.D.
Honorary Professor of Mathematics in the University of Heidelberg. Hofrat of the German Empire. Author of *Vorlesungen über die Geschichte der Mathematik*; &c.
- M. G.** MOSES GASTER, PH.D.
Chief Rabbi of the Sephardic Communities of England. Ichester Lecturer at Oxford on Slavonic and Byzantine Literature, 1886 and 1891. President of the Folk-lore Society of England. Vice-President, Anglo-Jewish Association. Author of *History of Rumanian Popular Literature*; &c.
- M. Ja.** MORRIS JASTROW, PH.D.
Professor of Semitic Languages, University of Pennsylvania. Author of *Religion of the Babylonians and Assyrians*; &c.
- M. M.** MAX ARTHUR MACAULIFFE.
Formerly Divisional Judge in the Punjab. Author of *The Sikh Religion: its Gurus, Sacred Writings and Authors*; &c. Editor of *Life of Guru Nanak*, in the Punjabi language.
- M. N. T.** MARCUS NIEBUHR TOD, M.A.
Fellow and Tutor of Oriel College, Oxford. University Lecturer in Epigraphy. Joint-author of *Catalogue of the Sparta Museum*.
- M. O. B. C.** MAXIMILIAN OTTO BISMARCK CASPARI, M.A.
Reader in Ancient History at London University. Lecturer in Greek at Birmingham University, 1905-1908.
- N. M.** NORMAN MCLEAN, M.A.
Lecturer in Aramaic, Cambridge University. Fellow and Hebrew Lecturer, Christ's College, Cambridge. Joint-editor of the larger Cambridge *Septuagint*.
- O. A.** OSMUND AIRY, M.A., LL.D.
H.M. Divisional Inspector of Schools and Inspector of Training Colleges, Board of Education, London. Author of *Louis XIV. and the English Restoration*; *Charles II.*; &c. Editor of the *Lauderdale Papers*; &c.
- O. M.** DAVID ORME MASSON, M.A., D.Sc., F.R.S.
Professor of Chemistry, Melbourne University. Author of papers on chemistry in the transactions of various learned societies.

Silius Italicus;
Statius.Siberia (in part);
Sibirsk (in part);
Smolensk (in part);
Stavropol (in part).

Stephen, St.

Statute.

South Australia: Geology.

Stephan, Heinrich von.

Spain: Geography and
Statistics.

Soden, Hermann von.

Sistrum; Sordino; Spinet;
Stringed Instruments.

Sophocles.

Siricius;
Sixtus I.-III.Sillimanite; Smaltite;
Sodalite; Spene; Stannite;
Staurolite; Stephanite;
Stibnite; Stilbite; Strontianite.

Smoke (in part).

Stevinus, Simon.

Sturdza (family).

Sin (Moon-god).

Sikh;
Sikhism.

Sparta.

Sicyon.

Stephen Bar Šudhaile.

Sidney, Algernon;
Somers, Lord.

Smoke (in part).

INITIALS AND HEADINGS OF ARTICLES

- O. T.** OLDFIELD THOMAS, F.R.S., F.Z.S.
Senior Assistant, Natural History Department of the British Museum. Author of *Catalogue of Marsupialia in the British Museum.* { Skunk (*in part*).
- P. A. A.** PHILIP A. ASHWORTH, M.A., D. JURIS.
New College, Oxford. Barrister-at-Law. Translator of H. R. von Gneist's *History of the English Constitution.* { Simson, Martin E. von.
- P. A. K.** PRINCE PETER ALEXEIVITCH KROPOTKIN.
See the biographical article: KROPOTKIN, PRINCE P. A. { Siberia (*in part*);
Simbirsk (*in part*);
Smolensk (*in part*);
Stavropol (*in part*).
- P. C. M.** PETER CHALMERS MITCHELL, M.A., F.R.S., F.Z.S., D.Sc., LL.D.
Secretary of the Zoological Society of London. University Demonstrator in Comparative Anatomy and Assistant to Linacre Professor at Oxford, 1888-1891. Author of *Outlines of Biology*; &c. { Species.
- P. C. Y.** PHILIP CHESNEY YORKE, M.A.
Magdalen College, Oxford. Editor of *Letters of Princess Elizabeth of England* { Stafford.
- P. S.** PHILIP SCHIDROWITZ, PH.D., F.C.S.
Member of the Council, Institute of Brewing; Member of the Committee of Society of Chemical Industry. Author of numerous articles on the Chemistry and Technology of Brewing, Distilling, &c. { Spirits.
- P. VI.** PAUL VINOGRADOFF, D.C.L., LL.D.
See the biographical article: VINOGRADOFF, PAUL. { Socage.
- R.** LORD RAYLEIGH.
See the biographical article: RAYLEIGH, 3RD BARON. { Sky.
- R. A. S. M.** ROBERT ALEXANDER STEWART MACALISTER, M.A., F.S.A.
St John's College, Cambridge. Director of Excavations for the Palestine Exploration Fund. { Sodom and Gomorrah.
- R. D. H.** ROBERT DREW HICKS, M.A.
Fellow, formerly Lecturer in Classics, Trinity College, Cambridge. { Stoics.
- R. H. C.** REV. ROBERT HENRY CHARLES, M.A., D.D., D.LITT.
Grinfield Lecturer, and Lecturer in Biblical Studies, Oxford, and Fellow of Merton College. Fellow of the British Academy. Formerly Professor of Biblical Greek, Trinity College, Dublin. Author of *Critical History of the Doctrine of a Future Life*; *Book of Jubilees*; &c. { Solomon, The Psalms of.
- R. H. L.** ROBIN HUMPHREY LEGGE.
Principal Musical Critic for the *Daily Telegraph*. Author of *Annals of the Norwich Festivals*; &c. { Strauss, Richard.
- R. H. V.** ROBERT HAMILTON VETCH, C.B.
Colonel R.E. Employed on the defences of Bermuda, Bristol Channel, Plymouth Harbour and Malta, 1861-1876. Secretary of R.E. Institute, Chatham, 1877-1883. Deputy Inspector-General of Fortifications, 1889-1894. Author of *Gordon's Campaign in China*; *Life of Lieutenant-General Sir Gerald Graham*. Editor of the *R.E. Journal*, 1877-1884. { Strathnairn, Lord.
- R. I. P.** REGINALD INNES POCOCK, F.Z.S.
Superintendent of the Zoological Gardens, London. { Spiders.
- R. J. M.** RONALD JOHN McNEILL, M.A.
Christ Church, Oxford. Barrister-at-Law. Formerly Editor of the *St James's Gazette* (London). { Sidney, Sir Henry;
Simmel, Lambert;
Smith, Sir Henry;
Somerset, Earls and Dukes of;
Stone, Archbishop.
- R. L.*** RICHARD LYDEKKE, F.R.S., F.G.S., F.Z.S.
Member of the Staff of the Geological Survey of India, 1874-1882. Author of *Catalogue of Fossil Mammals, Reptiles and Birds in the British Museum*; *The Deer of all Lands*; *The Game Animals of Africa*; &c. { Sifaka; Sirenia;
Skunk (*in part*);
Soulik; Squirrel;
Squirrel Monkey.
- R. Mu.** ROBERT MUNRO, M.A., M.D., LL.D., F.R.S. (Edin.).
Dalrymple Lecturer on Archaeology in the University of Glasgow for 1910. Rhind Lecturer on Archaeology, 1888. Secretary of the Society of Antiquaries of Scotland, 1888-1899. Founder of the Munro Lectureship on Anthropology and Prehistoric Archaeology in the University of Edinburgh. Author of *The Lake-dwellings of Europe*; *Prehistoric Scotland, and its place in European Civilization*; &c. { Stonehenge;
Stone Monuments.
- R. M. B. F. K.** RICHARD MAKDOUGALL BRISBANE FRANCIS KELLY, D.S.O.
Colonel R.A. Commanding R.G.A., Southern Defences, Portsmouth. Served through the South African War, 1899-1902. Chief Instructor at the School of Gunnery, 1904-1908. { Sights.
- R. N. B.** ROBERT NISBET BAIN (d. 1909).
Assistant Librarian, British Museum, 1883-1909. Author of *Scandinavia: The Political History of Denmark, Norway and Sweden, 1513-1900*; *The First Romanovs, 1613-1725*; *Slavonic Europe: The Political History of Poland and Russia from 1409 to 1796*; &c. { Sigismund I., II. and III. of Poland;
Skarga, Piotr; Skram, Peder;
Skrzynecki, Jan Zygmunt;
Sophia Aleksyeevna;
Sprengporten, Count Göran;
Sprengporten, Jakob;
Stanislaus I. and II. of Poland;
Stephen I. and V. of Hungary;
Stephen Báthory;
Struensee, Johan F.;
Sture (*family*).

- R. P. S.** R. PHENÉ SPIERS, F.S.A., F.R.I.B.A.
Formerly Master of the Architectural School, Royal Academy, London. Past President of the Architectural Association. Associate and Fellow of King's College, London. Corresponding Member of the Institute of France. Editor of Fergusson's *History of Architecture*. Author of *Architecture: East and West*; &c.
- R. Sn.** RICHARD SNOW.
Examiner in Silk Throwing and Spinning for the City and Guilds of London Institute.
- R. S. C.** ROBERT SEYMOUR CONWAY, M.A., D.LITT.
Professor of Latin and Indo-European Philology in the University of Manchester. Formerly Professor of Latin in University College, Cardiff; and Fellow of Gonville and Caius College, Cambridge. Author of *The Italic Dialects*.
- S. A. C.** STANLEY ARTHUR COOK.
Lecturer in Hebrew and Syriac, and formerly Fellow, Gonville and Caius College, Cambridge. Editor for the Palestine Exploration Fund. Author of *Glossary of Aramaic Inscriptions*; *The Laws of Moses and the Code of Hammurabi*; *Critical Notes on Old Testament History*; *Religion of Ancient Palestine*; &c.
- S. Bl.** SIGFÜS BLÖNDAL.
Librarian of the University of Copenhagen.
- S. F. M.** SIR SHIRLEY FORSTER MURPHY, F.R.C.S.
Medical Officer of Health for the County of London.
- St G. S.** ST GEORGE STOCK, M.A.
Pembroke College, Oxford. Lecturer in Greek in the University of Birmingham.
- S. N.** SIMON NEWCOMB, D.Sc., LL.D.
See the biographical article: NEWCOMB, SIMON.
- T. As.** THOMAS ASHBY, M.A., D.LITT.
Director of the British School of Archaeology at Rome. Formerly Scholar of Christ Church, Oxford. Craven Fellow, 1897. Conington Prizeman, 1906. Member of the Imperial German Archaeological Institute. Author of *The Classical Topography of the Roman Campagna*.
- T. A. A.** THOMAS ANDREW ARCHER, M.A.
Author of *The Crusade of Richard I.*; &c.
- T. A. C.** TIMOTHY AUGUSTINE COGHLAN, I.S.O.
Agent-General for New South Wales. Government Statistician, New South Wales, 1886-1905. Honorary Fellow of the Royal Statistical Society. Author of *Wealth and Progress of New South Wales*; *Statistical Account of Australia and New Zealand*; &c.
- T. Ba.** SIR THOMAS BARCLAY.
Member of the Institute of International Law. Officer of the Legion of Honour. Author of *Problems of International Practice and Diplomacy*; &c. M.P. for Blackburn, 1910.
- T. F. C.** THEODORE FREYLINGHUYSEN COLLIER, PH.D.
Assistant Professor of History, Williams College, Williamstown, Mass.
- T. Se.** THOMAS SECCOMBE, M.A.
Balliol College, Oxford. Lecturer in History, East London and Birkbeck Colleges, University of London. Stanhope Prizeman, Oxford, 1887. Assistant Editor of *Dictionary of National Biography*, 1891-1901. Author of *The Age of Johnson*; &c.
- T. W.-D.** WALTER THEODORE WATTS-DUNTON.
See the biographical article: WATTS-DUNTON, WALTER THEODORE.
- T. W. F.** THOMAS WILLIAM FOX.
Professor of Textiles in the University of Manchester. Author of *Mechanics of Weaving*.
- T. W. R. D.** THOMAS WILLIAM RHYS DAVIDS, M.A., LL.D., PH.D.
Professor of Comparative Religion, Manchester University. President of the Pali Text Society. Fellow of the British Academy. Professor of Pali and Buddhist Literature, University College, London, 1882-1904. Secretary and Librarian of Royal Asiatic Society, 1885-1902. Author of *Buddhism*; *Sacred Books of the Buddhists*; *Early Buddhism*; *Buddhist India*; *Dialogues of the Buddha*; &c.
- V. W.** THE HON. LADY WELBY.
Formerly Maid of Honour to Queen Victoria. Author of *Links and Clues*; *Grains of Sense*; *What is Meaning?*
- W. A. B. C.** REV. WILLIAM AUGUSTUS BREVOORT COOLIDGE, M.A., F.R.G.S., PH.D.
Fellow of Magdalen College, Oxford. Professor of English History, St David's College, Lampeter, 1880-1881. Author of *Guide du Haut Dauphine*; *The Range of the Todi*; *Guide to Grindelwald*; *Guide to Switzerland*; *The Alps in Nature and in History*; &c. Editor of the *Alpine Journal*, 1880-1881; &c.
- W. A. G.** WALTER ARMSTRONG GRAHAM.
Adviser to His Siamese Majesty's Minister for Agriculture. Commander, Order of the White Elephant. Member of the Burma Civil Service, 1889-1903. Author of *The French Roman Catholic Mission in Siam*; *Kelantan, a Handbook*; &c.
- W. A. J. F.** WALTER ARMITAGE JUSTICE FORD.
Sometime Scholar of King's College, Cambridge. Teacher of Singing at the Royal College of Music, London.
- Stair;**
Staircase: *Architecture*;
Spire.
- Silk:** *Trade and Commerce.*
- Siculi (tribe).**
- Simeon;**
Solomon.
- Sigurðsson, Jón.**
- Slaughter-house.**
- Simon Magus.**
- Solar System.**
- Sicily: Geography and Statistics**
(in part), and *History (in part)*;
Siena (in part);
Signia; Soluntum;
Sora; Spoleto;
Stabia; Subiaco.
- Silvester II.**
- South Australia: Geography and Statistics.**
- Spy (in part);**
State.
- Sixtus V.**
- Smollett;**
Stephen, Sir Leslie.
- Sonnet.**
- Spinning.**
- Sigiri.**
- Signifies.**
- Simler, Josias;**
Simplon Pass; Sion (town);
Soleure (canton);
Soleure (town);
Splügen Pass; Stans;
Stumpf, Johann.
- Siam.**
- Song (in music).**

W. A. P.	WALTER ALISON PHILLIPS, M.A. Formerly Exhibitioner of Merton College and Senior Scholar of St John's College, Oxford. Author of <i>Modern Europe</i> ; &c.	Sir; Spain: <i>History (in part)</i> ; States-General; Stole (<i>in part</i>).
W. C. D. W.	WILLIAM CECIL DAMPIER WHETHAM, M.A., F.R.S. Fellow and Tutor of Trinity College, Cambridge. Author of <i>Theory of Solution</i> ; <i>Recent Development of Physical Science</i> ; <i>The Family and the Nation</i> ; &c.	Solution.
W. E. G.	SIR WILLIAM EDMUND GARSTIN, G.C.M.G. British Government Director, Suez Canal Co. Formerly Inspector-General of Irrigation, Egypt. Adviser to the Ministry of Public Works in Egypt, 1904-1908.	Sobat (<i>in part</i>).
W. Ho.	WYNNARD HOOPER, M.A. Clare College, Cambridge. Financial Editor of <i>The Times</i> , London.	Statistics; Stock Exchange.
W. Hu.	REV. WILLIAM HUNT, M.A., LITT.D. President of the Royal Historical Society, 1905-1909. Author of <i>History of the English Church, 597-1666</i> ; <i>The Church of England in the Middle Ages</i> ; &c.	Stubbs, William.
W. L. C.*	WILLIAM LEE CORBIN, A.M. Associate Professor of English, Wells College, Aurora, New York State.	Sparks, Jared.
W. L. G.	WILLIAM LAWSON GRANT, M.A. Professor of Colonial History, Queen's University, Kingston, Canada. Formerly Beit Lecturer in Colonial History, Oxford University. Editor of <i>Acts of the Privy Council (Canadian Series)</i> .	Strathcona and Mount Royal, Lord.
W. M.	WILLIAM MINTO, M.A. See the biographical article: MINTO, WILLIAM.	Spenser, Edmund (<i>in part</i>); Steele, Sir Richard (<i>in part</i>); Sterne, Laurence (<i>in part</i>).
W. MacC.	SIR WILLIAM MACCORMAC, BART. See the biographical article: MACCORMAC, SIR WILLIAM, BART.	Simon, Sir John.
W. McD.	WILLIAM MCDUGALL, M.A. Wilde Reader in Mental Philosophy in the University of Oxford. Formerly Fellow of St John's College, Cambridge.	Subliminal Self.
W. M. F. P.	WILLIAM MATTHEW FLINDERS PETRIE, F.R.S., D.C.L., LITT.D. See the biographical article: PETRIE, W. M. FLINDERS.	Sinai: <i>The Peninsula</i> .
W. M. R.	WILLIAM MICHAEL ROSSETTI. See the biographical article: ROSSETTI, DANTE GABRIEL.	Signorelli, Luca; Sodoma, Il.
W. M. Ra.	SIR WILLIAM MITCHELL RAMSAY, LL.D., D.C.L., D.LITT. See the biographical article: RAMSAY, SIR W. MITCHELL.	Smyrna (<i>in part</i>).
W. N. S.	WILLIAM NAPIER SHAW, M.A., LL.D., D.Sc., F.R.S. Director of the Meteorological Office, London. Reader in Meteorology in the University of London. President of Permanent International Meteorological Committee. Member of Meteorological Council, 1897-1905. Hon. Fellow of Emmanuel College, Cambridge. Fellow of Emmanuel College, 1877-1906; Senior Tutor, 1890-1899. Joint author of <i>Text Book of Practical Physics</i> ; &c.	Squall.
W. W. F.*	WILLIAM WARDE FOWLER, M.A. Fellow of Lincoln College, Oxford. Sub-rector, 1881-1904. Gifford Lecturer, Edinburgh University, 1908. Author of <i>The City-State of the Greeks and Romans</i> ; <i>The Roman Festivals of the Republican Period</i> ; &c.	Silvanus.

PRINCIPAL UNSIGNED ARTICLES

Sibyls.	Sodium.	Speaker.	Stem.
Sierra Leone.	Soissons.	Spectacles.	Stettin.
Sign-board.	Soianaceae.	Speranski, Count.	Stickleback.
Sikh Wars.	Solifitor.	Sphere.	Stirling.
Silesia.	Solomon Islands.	Spitsbergen.	Stirlingshire.
Silicon.	Somersetshire.	Springfield.	Stockholm.
Silver.	Somme.	Staff.	Stoichiometry.
Simony.	Somnambulism.	Stafford.	Stoien Goods.
Sind.	Sorbonne.	Staffordshire.	Strassburg.
Skating.	Southampton.	Stalaactites.	Stratford-on-Avon.
Ski.	South Carolina.	Stamford.	Straw and Straw Manufactures.
Skin Diseases.	South Dakota.	Stammering.	Strawberry.
Skye.	South Sea Bubbie.	Stamp.	Strontium.
Sligo.	Southwark.	Starch.	Strophanthus.
Smallpox.	Sowing.	Star-Chamber.	Strychnine.
Smithsonian Institution.	Spalato.	Staten Island.	Sturgeon.
Snail.	Spanish-American War.	State Rights.	Stuttgart.
Soap.	Spanish Reformed Church.	Steenkirk.	Styria.

ENCYCLOPÆDIA BRITANNICA

ELEVENTH EDITION

VOLUME XXV

SHUVÁLOV (sometimes written **SCHOUVALOFF**), **PETER ANDREIVICH**, COUNT (1827–1889), Russian diplomatist, was born in 1827 of an old Russian family which rose to distinction and imperial favour about the middle of the 18th century. Several of its members attained high rank in the army and the civil administration, and one of them may be regarded as the founder of the Moscow University and the St Petersburg Academy of the Fine Arts. As a youth Count Peter Andreivich showed no desire to emulate his distinguished ancestors. He studied just enough to qualify for the army, and for nearly twenty years he led the agreeable, commonplace life of a fashionable officer of the Guards. In 1864 Court influence secured for him the appointment of Governor-General of the Baltic Provinces, and in that position he gave evidence of so much natural ability and tact that in 1866, when the revolutionary fermentation in the younger section of the educated classes made it advisable to place at the head of the political police a man of exceptional intelligence and energy, he was selected by the emperor for the post. In addition to his regular functions, he was entrusted by his Majesty with much work of a confidential, delicate nature, including a mission to London in 1873. The ostensible object of this mission was to arrange amicably certain diplomatic difficulties created by the advance of Russia in Central Asia, but he was instructed at the same time to prepare the way for the marriage of the grand duchess Marie Alexandrovna with the duke of Edinburgh, which took place in January of the following year. At that time the emperor Alexander II. was anxious to establish cordial relations with Great Britain, and he thought this object might best be attained by appointing as his diplomatic representative at the British Court the man who had conducted successfully the recent matrimonial negotiations. Count Shuválov was accordingly appointed ambassador to London; and he justified his selection by the extraordinary diplomatic ability he displayed during the Russo-Turkish War of 1877–78 and the subsequent negotiations, when the relations between Russia and Great Britain were strained almost to the point of rupture. After the publication of the treaty of San Stefano, which astonished Europe and seemed to render a conflict inevitable, he concluded with Lord Salisbury a secret convention which enabled the two powers to meet in congress and find a pacific solution for all the questions at issue. In the deliberations and discussions of the congress he played a leading part, and defended the interests of his country with a dexterity which excited the admiration of his colleagues; but when it became known that the San Stefano arrangements were profoundly modified by the treaty of Berlin, public opinion in Russia con-

demned him as too conciliatory, and reproached him with having needlessly given up many of the advantages secured by the war. For a time Alexander II. resisted the popular clamour, but in the autumn of 1879, when Prince Bismarck assumed an attitude of hostility towards Russia, Count Shuválov, who had been long regarded as too amenable to Bismarckian influence, was recalled from his post as ambassador in London; and after living for nearly ten years in retirement, he died at St Petersburg in 1889. (D. M. W.)

SHUYA, a town in the government of Vladimir, 68 m. by rail N.E. of the town of Vladimir. It is one of the chief centres of the cotton and linen industries in middle Russia. It is built on the high left bank of the navigable Teza, a tributary of the Klyazma, with two suburbs on the right bank. Annalists mention princes of Shuya in 1403. Its first linen manufactures were established in 1755; but in 1800 its population did not exceed 1500. In 1882 it had 19,560 inhabitants, and 18,968 in 1897. Tanneries, especially for the preparation of sheepskins—widely renowned throughout Russia—still maintain their importance, although this industry has migrated to a great extent to the country districts. The cathedral (1799) is a large building, with five gilt cupolas. Nearly every village in the vicinity has a specialty of its own—bricks, pottery, wheels, toys, packing-boxes, looms and other weaving implements, house furniture, sieves, combs, boots, gloves, felt goods, candles, and so on. The manufacture of linen and cotton in the villages, as well as the preparation and manufacture of sheepskins and rough gloves, occupies about 40,000 peasants. The Shuya merchants carry on an active trade in these products all over Russia, and in corn, spirits, salt and other food stuffs, imported.

SHWEDO, a town and district in the Sagaing division of Upper Burma. The town is situated in the midst of a rice plain, 53 m. by rail N.E. from Mandalay; pop. (1901) 9626. It is of historic interest as the birthplace and capital of Alompra, the founder of the last Burmese dynasty. After British annexation it became an important military cantonment; but only the wing of a European regiment is now stationed here. The area of the district is 5634 sq. m.; pop. (1901) 286,891, showing an increase of 24% in the decade. It lies between the Katha, Upper and Lower Chindwin and Mandalay districts. The Irrawaddy forms the dividing line on the east. The physical features of the district vary considerably. The Minwun range runs down the whole eastern side, skirting the Irrawaddy. In the north it is a defined range, but at Sheinmaga, in the south, it sinks to an undulation. West of the Mu river, in the centre of the district, there is a gradual ascent to the hills which divide

Sagaing from the Upper Chindwin. Between these ranges and on both sides of the Mu is a plain, unbroken except for some isolated hills in the north and north-east and the low Sadaung-gyi range in the south-east. The greater part of this plain is a rice-growing tract, but on the sloping ground maize, millets, sesamum, cotton and peas are raised. A good deal of sugar is also produced from groves of the *tari* palm. The Mu river is navigable for three months in the year, from June to August, but in the dry season it can be forded almost anywhere. A good deal of salt is produced in a line which closely follows the railway. Coal has been worked at Letkokpin, near the Irrawaddy.

The Ye-u reserved forests are much more valuable than those to the east on the Minwun and the Mudein. Extensive irrigation works existed in Shwebo district, but they fell into disrepair in King Thibaw's time. Chief of these was the Mahananda Lake. The old works have recently been in process of restoration, and in 1906 the main canal was formally opened. The rainfall follows the valleys of the Mu and the Irrawaddy, and leaves the rest of the district comparatively dry. It varies from an average of 29 to 49 in. The average temperature is 90° in the hot season, and falls to 60° or 61° in the cold season, the maximum and minimum readings being 104° and 56°.

SIALKOT, or **SEALKOTE**, a town and district of British India, in the Lahore division of the Punjab. The town, which has a station on the North-Western railway, is 72 m. N.E. of Lahore. Pop. (1901) 57,956. It is a military cantonment, being the headquarters of a brigade in the 2nd division of the northern army. There are remains of a fort dating from about the 10th century; but the mound on which they stand is traditionally supposed to mark the site of a much earlier stronghold, and some authorities identify it with the ancient Sakala or Sagal. Other ancient buildings are the shrine of Baba Nanak, the first Sikh Guru, that of the Mahommedan Imam Ali-ul-hakk and Raja Tej Singh's temple. The town has an extensive trade, and manufactures of sporting implements, boots, paper, cotton, cloth and shawl-edging. There are Scottish and American missions, a Scottish mission training institution and an arts college.

The DISTRICT of SIALKOT has an area of 1991 sq. m. It is an oblong tract of country occupying the submontane portion of the Rechna (Ravi-Chenab) Doab, fringed on either side by a line of fresh alluvial soil, above which rise the high banks that form the limits of the river-beds. The Degh, which rises in the Jammu hills, traverses the district parallel to the Ravi, and is likewise fringed by low alluvial soil. The north-eastern boundary is 20 m. distant from the outer line of the Himalayas; but about midway between the Ravi and the Chenab is a high dorsal tract, extending from beyond the border and stretching far into the district. Sialkot is above the average of the Punjab in fertility. The upper portion is very productive; but the southern portion, farther removed from the influence of the rains, shows a marked decrease of fertility. The district is also watered by numerous small torrents; and several swamps or *jhils*, scattered over the face of the country, are of considerable value as reservoirs of surplus water for purposes of irrigation. Sialkot is reputed to be healthy; it is free from excessive heat, judged by the common standard of the Punjab; and its average annual rainfall varies from 35 in. near the hills to 22 in. in the parts farthest from them. The population in 1901 was 1,083,909, showing a decrease of 3% as against an increase of 11% in the previous decade. This is explained by the fact that Sialkot contributed over 100,000 persons to the Chenab colony (*q.v.*). The principal crops are wheat, barley, maize, millets and sugar-cane. The district is crossed by a branch of the North-Western railway from Wazirabad to Jammu.

The early history of Sialkot is closely interwoven with that of the rest of the Punjab. It was annexed by the British after the second Sikh war in 1849; since then its area has been considerably reduced, assuming its present proportions in 1867. During the Mutiny of 1857 the native troops plundered the treasury and destroyed all the records, when most of the European residents took refuge in the fort.

SIAM (known to its inhabitants as *Muang Thai*), an independent kingdom of the Indo-Chinese peninsula or Further India. It lies between 4° 20' and 20° 15' N. and between 96° 30' and 106° E., and is bounded N. by the British Shan States and by the French Laos country, E. by the French Laos country and by Cambodia, S. by Cambodia and by the Gulf of Siam, and W. by the Tenasserim and Pegu divisions of Burma. A part of Siam which extends down the Malay Peninsula is bounded E. by the Gulf of Siam and by the South China Sea, S. by British Malaya and W. by the lower part of the Bay of Bengal. The total area is about 220,000 sq. m. (For map, see INDO-CHINA.)

The country may be best considered geographically in four parts: the northern, including the drainage area of the four rivers which unite near Pak-Nam Po to form the Menam Chao Phaya; the eastern, including the drainage area of the Nam Mun river and its tributaries; the central, including the drainage area of the Meklong, the Menam Chao Phaya and the Bang Pakong rivers; and the southern, including that part of the country which is situated in the Malay Peninsula. Northern Siam is about 60,000 sq. m. in area. In general appearance it is a series of parallel ranges of hills, lying N. and S., merely gently sloping acclivities in the S., but rising into precipitous mountain masses in the N. Between these ranges flow the rivers Meping, Mewang, Meyom and Menam, turbulent shallow streams in their upper reaches, but slow-moving and deep where they near the points of junction. The longest of them is over 250 m. from its source to its mouth. The Meping and Mewang on the W., rising among the loftiest ranges, are rapid and navigable only for small boats, while the Meyom and Menam, the eastern pair, afford passage for large boats at all seasons and for deep draught river-steamers during the flood-time. The Menam is the largest, deepest and most sluggish of the four, and in many ways resembles its continuation, the Menam Chao Phaya lower down. On the W. the river Salween and its tributary the Thoug Yin form the frontier between the Siam and Burma for some distance, draining a part of northern Siam, while in the far north-east, for a few miles below Chieng Sen, the Mekong does the same. The districts watered by the lower reaches of the four rivers are fertile and are inhabited by a considerable population of Siamese. Farther north the country is peopled by Laos, scattered in villages along all the river banks, and by numerous communities of Shan, Karen, Kamoo and other tribes living in the uplands and on the hilltops.

Eastern Siam, some 70,000 sq. m. in area, is encircled by well-defined boundaries, the great river Mekong dividing it clearly from French Laos on the N. and E., the Pnom Dang Rek hill range from Cambodia on the S. and the Dom Pia Fai range from central Siam on the W. The right bank of the Mekong being closely flanked by an almost continuous hill range, the whole of this part of Siam is practically a huge basin, the bottom of which is a plain lying from 200 to 300 ft. above sea-level, and the sides hill ranges of between 1000 and 2000 ft. elevation. The plain is for the most part sandy and almost barren, subject to heavy floods in the rainy season, and to severe drought in the dry weather. The hills are clothed with a thin shadeless growth of stunted forest, which only here and there assumes the characteristics of ordinary jungle. The river Nam Mun, which is perhaps 200 m. long, has a large number of tributaries, chief of which is the Nam Si. The river flows eastward and falls into the Mekong at 15° 20' N. and 105° 40' E. A good way farther north two small rivers, the Nam Kum and the Nam Song Kram, also tributaries of the Mekong, drain a small part of eastern Siam. Nearly two million people, mixed Siamese, Lao and Cambodian, probably among the poorest peasantry in the world, support existence in this inhospitable region.

Central Siam, estimated at 50,000 sq. m. in area, is the heart of the kingdom, the home of the greater part of its population, and the source of nine-tenths of its wealth. In general appearance it is a great plain flanked by high mountains on its western border, inclining gently to the sea in the S. and round the inner Gulf of Siam, and with a long strip of mountainous sea-board stretching out to the S.E. The mountain range on the W. is a

continuation of one of the ranges of northern Siam, which, extending still farther southward, ultimately forms the backbone of the Malay Peninsula. Its ridge is the boundary between central Siam and Burma. The highest peak hereabouts is Mogadok, 5000 ft., close to the border. On the E. the Dom Pia Fai throws up a point over 4000 ft., and the south-eastern range which divides the narrow, littoral, Chantabun and Krat districts from Cambodia, has the Chemaio, Saidaio and Kmocho heights, between 3000 and 5000 ft. The Meklong river, which drains the western parts of central Siam, rises in the western border range, follows a course a little E. of S., and runs into the sea at the western corner of the inner gulf, some 200 m. distant from its source. It is a rapid, shallow stream, subject to sudden rises, and navigable for small boats only. The Bang Pakong river rises among the Wattana hills on the eastern border, between the Battambang province of Cambodia and Siam. It flows N., then W., then S., describing a semicircle through the fertile district of Pachim, and falls into the sea at the north-east corner of the inner gulf. The whole course of this river is about 100 m. long; its current is sluggish, but that of its chief tributary, the Nakhon Nayok river, is rapid. The Bang Pakong is navigable for steamers of small draught for about 30 m. The Menam Chao Phaya, the principal river of Siam, flows from the point where it is formed by the junction of the rivers of northern Siam almost due S. for 154 m., when it empties itself into the inner gulf about midway between the Meklong and Bang Pakong mouths. In the neighbourhood of Chainat, 40 m. below Paknam Poh, it throws off three branches, the Suphan river and the Menam Noi on the right, and the Lopburi river on the left bank. The latter two rejoin the parent stream at points considerably lower down, but the Suphan river remains distinct, and has an outlet of its own to the sea. At a point a little more than half-way down its course, the Menam Chao Phaya receives the waters of its only tributary, the Nam Sak, a good-sized stream which rises in the east of northern Siam and waters the most easterly part (the Pechabun valley) of that section of the country. The whole course of the Menam Chao Phaya lies through a perfectly flat country. It is deep, fairly rapid, subject to a regular rise and flood every autumn, but not to sudden freshets, and is affected by the tide 50 m. inland. For 20 m. it is navigable for vessels of over 1000 tons, and were it not for the enormous sand bar which lies across the mouth, ships of almost any size could lie at the port of Bangkok about that distance from the sea (see BANGKOK). Vessels up to 300 tons and 12 ft. draught can ascend the river 50 m. and more, and beyond that point large river-boats and deep-draught launches can navigate for many miles. The river is always charged with a great quantity of silt which during flood season is deposited over the surrounding plain to the great enhancement of its fertility. There is practically no forest growth in central Siam, except on the slopes of the hills which bound this section. The rest is open rice-land, alternating with great stretches of grass, reed jungle and bamboo scrub, much of which is under water for quite three months of the year.

Southern Siam, which has an area of about 20,000 sq. m., consists of that part of the Malay Peninsula which belongs to the Siamese kingdom. It extends from 10° N. southwards to 6° 35' N. on the west coast of the peninsula, and to 6° 25' N. on the east coast, between which points stretches the frontier of British Malaya. It is a strip of land narrow at the north end and widening out towards the south, consisting roughly of the continuation of the mountain range which bounds central Siam on the W., though the range appears in certain parts as no more than a chain of hillocks. The inhabitable part of the land consists of the lower slopes of the range with the valleys and small alluvial plains which lie between its spurs. The remainder is covered for the most part with dense forest containing several kinds of valuable timber. The coast both east and west is much indented, and is studded with islands. The rivers are small and shallow. The highest mountain is Kao Luang, an almost isolated projection over 5000 ft. high, round the base of which lie the most fertile lands of this section, and near which are

situated the towns of Bandon, Nakhon Sri Tammarat (Lakhon) and Patalung, as well as many villages.

Geology.—Very little is known of the geology of Siam. It appears to be composed chiefly of Palaeozoic rocks, concealed, in the plains, by Quaternary, and possibly Tertiary, deposits. Near Luang Prabang, just beyond the border, in French territory, limestones with *Productus* and *Schwagerina*, like the *Productus* limestone of the Indian Salt Range, have been found; also red clays and grauwacke with plants similar to those of the Raniganj beds; and violet clays with *Dicynodon*, supposed to be the equivalents of the Panche series of India. All these beds strike from north-east to south-west and must enter the northern part of Siam. Farther south, at Vientiane, the Mekong passes through a gorge cut in sandstone, arkose and schists with a similar strike; while at Lakhon there are steeply inclined limestones which strike north-west.

Climate.—Although enervating, the climate of Siam, as is natural from the position of the country, is not one of extremes. The wet season—May to October—corresponds with the prevalence of the south-west monsoon in the Bay of Bengal. The full force of the monsoon is, however, broken by the western frontier hills; and while the rainfall at Mergui is over 180, and at Moulmein 240 in., that of Bangkok seldom exceeds 54, and Chiangmai records an average of about 42 in. Puket and Chantabun, being both on a lee shore, in this season experience rough weather and a heavy rainfall; the latter, being farther from the equator, is the worse off in this respect. At this period the temperature is generally moderate, 65° to 75° F. at night and 75° to 85° by day; but breaks in the rains occur which are hot and steamy. The cool season begins with the commencement of the north-east monsoon in the China Sea in November. While Siam enjoys a dry climate with cool nights (the thermometer at night often falling to 40°–50° F., and seldom being over 90° in the shade by day), the eastern coast of the Malay Peninsula receives the full force of the north-easterly gales from the sea. This lasts into February, when the northerly current begins to lose strength, and the gradual heating of the land produces local sea breezes from the gulf along the coast-line. Inland, the thermometer rises during the day to over 100° F., but the extreme continental heats of India are not known. The comparative humidity of the atmosphere, however, makes the climate trying for Europeans.

Flora.—In its flora and fauna Siam combines the forms of Burma and the Shan States with those of Malaya, farther south, and of Cambodia to the south-east. The coast region is characterized by mangroves, *Pandanus*, rattans, and similar palms with long flexible stems, and the middle region by the great rice-fields, the coco-nut and areca palms, and the usual tropical plants of culture. In the temperate uplands of the interior, as about Luang Prabang, Himalayan and Japanese species occur—oaks, pines, chestnuts, peach and great apple trees, raspberries, honeysuckle, vines, saxifrages, *Cichoraceae*, anemones and *Violaceae*; there are many valuable timber trees—teak, sappan, eagle-wood, wood-oil (*Hopea*), and other *Dipterocarpaceae*, *Cedrelaceae*, *Pterocarpaceae*, *Xylia*, iron-wood and other dye-woods and resinous trees, these last forming in many districts a large proportion of the more open forests, with an undergrowth of bamboo. The teak tree grows all over the hill districts north of latitude 15°, but seems to attain its best development on the west, and on the east does not appear to be found south of 17°. Most of the so-called Burma teak exported from Moulmein is floated down from Siamese territory. Among other valuable forest products are thingan wood (*Hopea odorata*), largely used for boat-building; damar oil, taken throughout Indo-China from the *Dipterocarpus levis*; agilla wood, sapan, rosewood, iron-wood, ebony, rattan. Among the chief productions of the plains are rice (the staple export of the country); pepper (chiefly from Chantabun); sirihi, sago, sugar-cane, coco-nut and betel, Palmyra or sugar and attap palms; many forms of banyan and other fruit, such as durian, orange-pommelo, guava, bread-fruit, mango, jack fruit, pine-apple, custard-apple and mangosteen.

Fauna.—Few countries are so well stocked with big game as is Siam. Chief of animals is the elephant, which roams wild in large numbers, and is extensively caught and tamed by the people for transport. The tiger, leopard, fishing-cat, leopard-cat, and other species of wild-cat, as well as the honey-bear, large sloth-bear, and one- and two-horned rhinoceros, occur. Among the great wild cattle are the formidable gaur, or seladang, the banting, and the water-buffalo. The goat antelope is found, and several varieties of deer. Wild pig, several species of rats, and many bats—one of the commonest being the flying-fox, and many species of monkey—especially the gibbon—are also met with. Of snakes, 56 species are known, but only 12 are poisonous, and of these 4 are sea-snakes. The waters of Siam are particularly rich in fish. The crocodile is common in many of the rivers and estuaries of Siam, and there are many lizards. The country is rich in birds, a large number of which appear to be common to Burma and Cambodia.

¹ See E. Joubert in F. Garnier, *Voyage d'exploration en Indo-Chine* (Paris, 1873), vol. ii.; Counillon, *Documents pour servir à l'étude géologique des environs de Luang Prabang* (Cochinchine), *Comptes rendus* (1896), cxxiii. 1330–1333.

Inhabitants.—A census of the rural population was taken for the first time in 1905. The first census of Bangkok and its suburbs was taken in 1909. Results show the total population of the country to be about 6,230,000. Of this total about 3,000,000 are Siamese, about 2,000,000 Laos, about 400,000 Chinese, 115,000 Malay, 80,000 Cambodian and the rest Burmese, Indian, Mohn, Karen, Annamite, Kache, Lawa and others. Of Europeans and Americans there are between 1300 and 1500, mostly resident in Bangkok. Englishmen number about 500; Germans, 190; Danes, 160; Americans, 150, and other nationalities are represented in smaller numbers. The Siamese inhabit central Siam principally, but extend into the nearer districts of all the other sections. The Laos predominate in northern and eastern Siam, Malays mingle with the Siamese in southern Siam, and the Chinese are found scattered all over, but keeping mostly to the towns. Bangkok, the capital, with some 650,000 inhabitants, is about one-third Chinese, while in the suburbs are to be found settlements of Mohns, Burmese, Annamites and Cambodians, the descendants of captives taken in ancient wars. The Eurasian population of Siam is very small compared with that of other large cities of the East. Of the tribes which occupy the mountains of Siam some are the remnants of the very ancient inhabitants of the country, probably of the Mohn-Khmer family, who were supplanted by a later influx of more civilized Khmers from the south-east, the forerunners and part-ancestors of the Siamese, and were still farther thrust into the remoter hills when the Lao-Tai descended from the north. Of these the principal are the Lawa, Lamet, Ka Hok, Ka Yuen and Kamoo, the last four collectively known to the Siamese as Ka. Other tribes, whose presence is probably owing to immigration at remote or recent periods, are the Karens of the western frontier range, the Lu, Yao, Yao Yin, Meo and Musur of northern Siam. The Karens of Siam number about 20,000, and are found as far south as 13° N. They are mere offshoots from the main tribes which inhabit the Burma side of the boundary range, and are supposed by some to be of Burmo-Tibetan origin. The Lu, Yao, Yao Yin, Meo and Musur have Yunnanese characteristics, are met with in the Shan States north of Siam and in Yun-nan, and are supposed to have found their way into northern Siam since the beginning of the 19th century. In the mountains behind Chantabun a small tribe called Chong is found, and in southern Siam the Sakei and Semang inhabit the higher ranges. These last three have Negrito characteristics, and probably represent a race far older even than the ancient Ka.

The typical Siamese is of medium height, well formed, with olive complexion, darker than the Chinese, but fairer than the Malays, eyes well shaped though slightly inclined to the oblique, nose broad and flat, lips prominent, the face wide across the cheek-bones and the chin short. A thin moustache is common, the beard, if present, is plucked out, and the hair of the head is black, coarse and cut short. The lips are usually deep red and the teeth stained black from the habit of betel-chewing. The children are pretty but soon lose their charm, and the race, generally speaking, is ugly from the European standpoint. The position of women is good. Polygamy is permitted, but is common only among the upper classes, and when it occurs the first wife is acknowledged head of the household. In disposition the Siamese are mild-mannered, patient, submissive to authority, kindly and hospitable to strangers. They are a light-hearted, apathetic people, little given to quarrelling or to the commission of violent crime. Though able and intelligent cultivators they do not take kindly to any form of labour other than agricultural, with the result that most of the industries and trades of the country are in the hands of Chinese.

The national costume of the Siamese is the *panung*, a piece of cloth about 1 yd. wide and 3 yds. long. The middle of it is passed round the body, which it covers from the waist to the knees, and is hitched in front so that the two ends hang down in equal length before; these being twisted together are passed back between the legs, drawn up and tucked into the waist at the middle of the back. The *panung* is common to both sexes, the women supplementing it with a scarf worn round the body under the arms. Among the better classes both sexes wear also a jacket buttoned to the throat, stockings and shoes, and all the men, except servants, wear hats.

The staple food of the Siamese is rice and fish. Meat is eaten, but, as the slaughter of animals is against Buddhist tenets, is not often obtainable, with the exception of pork, killed by Chinese. The men smoke, but the women do not. Everybody chews betel. The principal pastimes are gambling, boat-racing, cock- and fish-fighting and kite-flying, and a kind of football.

Slavery, once common, has been gradually abolished by a series of laws, the last of which came into force in 1905. No such thing as caste exists, and low birth is no insuperable bar to the attainment of the highest dignities. There are no hereditary titles, those in use being conferred for life only and being attached to some particular office.

Towns.—There are very few towns with a population of over 10,000 inhabitants in Siam, the majority being merely scattered townships or clusters of villages, the capitals of the provinces (*muang*) being often no more than a few houses gathered round the market-place, the offices and the governor's residence. The more important places of northern Siam include Chieng Mai (*q.v.*), the capital of the north, Chieng Rai, [near the northern frontier; Lampun, also known as Labong (originally Haribunchai), the first Lao settlement in Siam; Lampang, Tern, Nan and Prè, each the seat of a Lao chief and of a Siamese commissioner; Utaradit, Pichai, Pichit, Pechabun and Raheng, the last of importance as a timber station, with Phitsnulok, Sukhotai, Swankalok, Kampeng Pet and Nakhon Sawan, former capitals of Khmer-Siamese kingdoms, and at present the headquarters of provincial governments. In eastern Siam the only towns of importance are Korat and Ubon, capitals of divisions, and Nong Kai, an ancient place on the Mekong river. In central Siam, after Bangkok and Ayuthia, places of importance on the Menam Chao Phaya are Pak-Nam at the river mouth, the seat of a governor, terminus of a railway and site of modern fortifications; Paklat, the seat of a governor, a town of Mohns, descendants of refugees from Pegu; Nontaburi, a few miles above Bangkok, the seat of a governor and possessing a large market; Pratoomtani, Angtong, Prom, Inburi, Chainat and Saraburi, all administrative centres; and Lopburi, the last capital before Ayuthia and the residence of kings during the Ayuthia period, a city of ruins now gradually reawakening as a centre of railway traffic. To the west of the Menam Chao Phaya lie Suphanburi and Ratburi, ancient cities, now government headquarters; Pechaburi (the Pipy of early travellers), the terminus of the western railway; and Phrapatoom, with its huge pagoda on the site of the capital of Sri Wichaiya, a kingdom of 2000 years ago, and now a place of military, agricultural and other schools. To the east, in the Bang Pakong river-basin and down the eastern shore of the gulf, are Pachim, a divisional headquarters; Petriou (*q.v.*); Bang Plaso, a fishing centre, with Rayong, Chantabun (*q.v.*) and Krat, producing gems and pepper. In southern Siam the chief towns are Chumpon; Bandon, with a growing timber industry; Nakhon Sri Tammarat (*q.v.*); Singora (*q.v.*); Puket (*q.v.*); Patani.

Communications.—Central Siam is supplied with an exceptionally complete system of water communications; for not only has it the three rivers with their tributaries and much-divided courses, but all three are linked together by a series of canals which, running in parallel lines across the plain from E. to W., make the farthest corners of this section of the kingdom easily accessible from the capital. The level of the land is so low, the soil so soft, and stone suitable for metal so entirely absent, that the making and upkeep of roads would here be ruinously expensive. Former rulers have realized this and have therefore confined themselves to canal making. Some of the canals are very old, others are of comparatively recent construction. In the past they were often allowed to fall into disrepair, but in 1903 a department of government was formed to control their upkeep, with the result that most of them were soon furnished with new locks, deepened, and made thoroughly serviceable. The boat traffic on them is so great that the collection of a small toll more than suffices to pay for all maintenance expenses. In northern and southern Siam, where the conditions are different, roads are being slowly made, but natural difficulties are great, and travelling in those distant parts is still a matter of much discomfort.

In 1909 there were 640 miles of railway open. All but 65 miles was under state management. The main line from Bangkok to the north had reached Pang Tong Phung, some distance north of Utaradit and 10 m. south of Meh Puak, which was selected as the terminus for the time being, the continuation to Chieng Mai, the original objective, being postponed pending the construction of another and more important line. This latter was the continuation through southern Siam of the line already constructed from Bangkok south-west to Petchaburi (110 m.), with funds borrowed, under a recent agreement, from the Federated (British) Malay States government, which work, following upon surveys made in 1907, was begun in 1909 under the direction of a newly constituted southern branch of the Royal Railways department. From Ban Paji on the main line a branch extends north-eastwards 110 m. to Korat. To the east of Bangkok the Bangkok-Petriew line (40 m.) was completed and open for traffic.

The postal service extends to all parts of the country and is fairly efficient. Siam joined the Postal Union in 1885. The inland telegraph is also widely distributed, and foreign lines communicate with Saigon, the Straits Settlements and Moulmein.

Agriculture.—The cultivation of paddy (unhusked rice) forms the

occupation of practically the whole population of Siam outside the capital. Primitive methods obtain, but the Siamese are efficient cultivators and secure good harvests nevertheless. The sowing and planting season is from June to August, and the reaping season from December to February. Forty or fifty varieties of paddy are grown, and Siam rice is of the best in the world. Irrigation is rudimentary, for no system exists for raising the water of the innumerable canals on to the fields. Water-supply depends chiefly, therefore, on local rainfall. In 1905 the government started preliminary surveys for a system of irrigation. Tobacco, pepper, coco-nuts and maize are other agricultural products. Tobacco of good quality supplies local requirements but is not exported; pepper, grown chiefly in Chantabun and southern Siam, annually yields about 900 tons for export. From coco-nuts about 10,000 tons of copra are made for export each year, and maize is used for local consumption only. Of horned cattle statistical returns show over two million head in the whole country.

Mining.—The minerals of Siam include gold, silver, rubies, sapphires, tin, copper, iron, zinc and coal. Tin-mining is a flourishing industry near Puket on the west coast of the Malay Peninsula, and since 1905 much prospecting and some mining has been done on the east coast. The export of tin in 1908 exceeded 5000 tons, valued at over £600,000. Rubies and sapphires are mined in the Chantabun district in the south-east. The Mining Department of Siam is a well-organized branch of the government, employing several highly-qualified English experts.

Timber.—The extraction of teak from the forests of northern Siam employs a large number of people. The industry is almost entirely in the hands of Europeans, British largely predominating. The number of teak logs brought out via the Salween and Menam Chao Phaya rivers average 160,000 annually, Siam being thus the largest teak-producing country of the world. A Forest Department, in which experienced officers recruited from the Indian Forest Service are employed, has for many years controlled the forests of Siam.

Technology.—The government has since 1903 given attention to sericulture, and steps have been taken to improve Siamese silk with the aid of scientists borrowed from the Japanese Ministry of Agriculture. Surveying and the administration of the land have for a long time occupied the attention of the government. A Survey Department, inaugurated about 1887, has completed the general survey of the whole country, and has made a cadastral survey of a large part of the thickly inhabited and highly cultivated districts of central Siam. A Settlement Commission, organized in 1901, decided the ownership of lands, and, on completion, handed over its work to a Land Registration Department. Thus a very complete settlement of much of the richest agricultural land in the country has been effected. The education of the youth of Siam in the technology of the industries practised has not been neglected. Pupils are sent to the best foreign agricultural, forestry and mining schools, and, after going through the prescribed course, often with distinction, return to Siam to apply their knowledge with more or less success. Moreover, a college under the control of the Ministry of Lands and Agriculture, which was founded in 1909, provides locally courses of instruction in these subjects and also in irrigation engineering, sericulture and surveying.

Commerce.—Rice-mills, saw-mills and a few distilleries of locally consumed liquor, one or two brick and tile factories, and here and there a shed in which coarse pottery is made, are all Siam has in the way of factories. All manufactured articles of daily use are imported, as is all ironware and machinery. The foreign commerce of Siam is very ancient. Her commerce with India, China and probably Japan dates from the beginning of the Christian era or earlier, while that with Europe began in the 16th century. Trade with her immediate neighbours is now insignificant, the total value of annual imports and exports being about £400,000; but sea-borne commerce is in a very flourishing condition. Bangkok, with an annual trade valued at £13,000,000, easily overtops all the rest of the country, the other ports together accounting for a total of imports and exports not exceeding £3,000,000. On both the east and west coasts of southern Siam trade is increasing rapidly, and is almost entirely with the Straits Settlements. The trade of the west coast is carried in British ships exclusively, that on the east coast by British and Siamese.

Art.—The Siamese are an artistic nation. Their architecture, drawing, goldsmith's work, carving, music and dancing are all highly developed in strict accordance with the traditions of Indo-Chinese art. Architecture, chiefly exercised in connexion with religious buildings, is clearly a decadent form of that practised by the ancient Khmers, whose architectural remains are among the finest in the world. The system of music is elaborate but is not written, vocalists and instrumentalists performing entirely by ear. The interval corresponding to the octave being divided into seven equal parts, each about $1\frac{1}{2}$ semitone, it follows that Siamese music sounds strange in Western ears. Harmony is unknown, and orchestras, which include fiddles, flutes, drums and harmonicons, perform in unison. The goldsmith's work of Siam is justly celebrated. Repoussé work in silver, which is still practised, dates from the most ancient times. Almost every province has its special patterns and processes, the most elaborate being those of Nakhon Sri Tammarat (Ligore), Chantabun and the Laos country. In the Ligore ware the hammered

ground-work is inlaid with a black composition of sulphides of baser metals which throws up the pattern with distinctness.

Government.—The government of Siam is an absolute monarchy. The heir to the throne is appointed by the king, and was formerly chosen from among all the members of his family, collateral as well as descendants. The choice was sometimes made early in the reign when the heir held the title of "Chao Uparach" or "Wang Na," mis-called "Second King" in English, and sometimes was left until the death of the king was imminent. The arrangement was fraught with danger to the public tranquillity, and one of the reforms of the last sovereign was the abolition of the office of "Chao Uparach" and a decree that the throne should in future descend from the king to one of his sons born of a queen, which decree was immediately followed by the appointment of a crown prince. There is a council consisting of the ten ministers of state—for foreign affairs, war, interior, finance, household, justice, metropolitan government, public works, public instruction and for agriculture—together with the general adviser. There is also a legislative council, of which the above are *ex officio* members, consisting of forty-five persons appointed by the king. The council meets once a week for the transaction of the business of government. The king is an autocrat in practice as well as in theory, he has an absolute power of veto, and the initiative of measures rests largely with him. Most departments have the benefit of European advisers. The government offices are conducted much on European lines. The Christian Sunday is observed as a holiday and regular hours are prescribed for attendance. The numerous palace and other functions make some demand upon ministers' time, and, as the king transacts most of his affairs at night, high officials usually keep late office hours. The Ministry of Interior and certain technical departments are recruited from the civil service schools, but many appointments in government service go by patronage. For administrative purposes the country is divided into seventeen *montons* (or divisions) each in charge of a high commissioner, and an eighteenth, including Bangkok and the surrounding suburban provinces, under the direct control of the minister for metropolitan government (see BANGKOK). The high commissioners are responsible to the minister of interior, and the *montons* are furnished with a very complete staff for the various branches of the administration. The *montons* consist of groups of the old rural provinces (*muang*), the hereditary chiefs of which, except in the Lao country in the north and in the Malay States, have been replaced by governors trained in administrative work and subordinate to the high commissioner. Each *muang* is subdivided into *ampurs* under assistant commissioners, and these again are divided into village circles under headmen (*kammans*), which circles comprise villages under the control of elders. The suburban provinces of the metropolitan *monton* are also divided as above. The policing of the seventeen *montons* is provided for by a gendarmerie of over 7000 men and officers (many of the latter Danes), a well-equipped and well-disciplined force. That of the suburban provinces is effected by branches of the Bangkok civil police.

Finance.—The revenue administration is controlled by the ministers of the interior, of metropolitan government and of finance, by means of well-organized departments and with expert European assistance. The total revenue of the country for 1908-1909 amounted to 58,000,000 ticals, or, at the prevailing rate of exchange, about £4,300,000, made up as follows:—

Farms and monopolies (spirits, gambling, &c.)	£783,000
Opium revenue	823,000
Lands, forests, mines, capitation.	1,330,000
Customs and octroi	653,000
Posts, telegraphs and railways	331,000
Judicial and other fees	270,000
Sundries	110,000
Total	£4,300,000

The unit of Siamese currency is the tical, a silver coin about equal in weight and fineness to the Indian rupee. In 1902, owing to the serious depreciation of the value of silver, the Siamese mint was closed to free coinage, and an arrangement was made providing for the gradual enhancement of the value of the tical until a suitable value should be attained at which it might be fixed. This measure was

successful, the value of the tical having thereby been increased from 11½d. in 1902 to 1s. 5½d. in 1909, to the improvement of the national credit and of the value of the revenues. A paper currency was established in 1902, and proved a financial success. In 1905 Siam contracted her first public loan, £1,000,000 being raised in London and Paris at 95½ and bearing 4½% interest. This sum was employed chiefly in railway construction, and in 1907 a second loan of £3,000,000 was issued in London, Paris and Berlin at 93¼ for the same purpose and for extension of irrigation works. A further sum of £4,000,000 was borrowed in 1909 from the government of the Federated (British) Malay States at par and bearing interest at 4%, also for railway construction.

Weights and Measures.—In accordance with the custom formerly prevalent in all the kingdoms of Further India, the coinage of Siam furnishes the standard of weight. The tical (*bahl*) is the unit of currency and also the unit of weight. Eighty ticals equal one *chang* and fifty *chang* equal one *haph*, equivalent to the Chinese *picul*, or 133½ lb avoirdupois. For the weighing of gold, gems, opium, &c., the *fuang*, equal to ½ tical, and the *salung*, equal to ¼ tical, are used. The unit of linear measure is the *wah*, which is subdivided into ¼ *wah* or *sauk*, ½ *wah* or *kup*, and into ⅓ *wah* or *niew*. Twenty *wah* equal one *sen* and 400 *sen* equal one *yote*. The length of the *wah* has been fixed at two metres. The unit of land measure is the *rai*, which is equal to 400 square *wah*, and is subdivided into four equal *ngan*. Measures of capacity are the *tang* or bucket, and the *sat* or basket. Twenty *tanan*, originally a half coco-nut shell, equal one *tang*, and twenty-five of the same measure equal one *sat*. The *tang* is used for measuring rice and the *sat* for paddy and other grain. One *sat* of paddy weighs 42½ lb avoirdupois.

Army and Navy.—By a law passed in 1903, the ancient system of recruiting the army and navy from the descendants of former prisoners of war was abolished in favour of compulsory service by all able-bodied men. The new arrangement, which is strictly territorial, was enforced in eight *monions* by the year 1909, resulting in a standing peace army of 20,000 of all ranks, in a marine service of about 10,000, and in the beginnings of first and second reserves. The navy, many of the officers of which are Danes and Norwegians, comprises a steel twin-screw cruiser of 2500 tons which serves as the royal yacht, four steel gunboats of between 500 and 700 tons all armed with modern quick-firing guns, two torpedo-boat destroyers and three torpedo boats, with other craft for river and coast work.

Justice.—Since the institution of the Ministry of Justice in 1892 very great improvements have been effected in this branch of the administration. The old tribunals where customary law was administered by ignorant satellites of the great, amid unspeakable corruption, have all been replaced by organized courts with qualified judges appointed from the Bangkok law school, and under the direct control of the ministry in all except the most outlying parts. The ministry is well organized, and with the assistance of European and Japanese officers of experience has drafted a large number of laws and regulations, most of which have been brought into force. Extra-territorial jurisdiction was for long secured by treaty for the subjects of all foreign powers, who could therefore only be sued in the courts maintained in Siam by their own governments, while European assessors were employed in cases where foreigners sued Siamese. An indication, however, foreshadowing the disappearance of extra-territorial rights, appeared in the treaty of 1907 between France and Siam, the former power therein surrendering all such rights where Asiatics are concerned so soon as the Siamese penal and procedure codes should have become law, and this was followed by a much greater innovation in 1909 when Great Britain closed her courts in Siam and surrendered her subjects under certain temporary conditions to the jurisdiction of the Siamese courts. When it is understood that there are over 30,000 Chinese, Annamese, Burmese and other Asiatic foreign subjects living in Siam, the importance to the country of this change will be to some extent realized.

Religion.—While the pure-blooded Malays of the Peninsula are Mahomedans, the Siamese and Lao profess a form of Buddhism which is tinged by Cingalese and Burmese influences, and, especially in the more remote country districts, by the spirit-worship which is characteristic of the imaginative and timid Ka and other hill peoples of Indo-China. In the capital a curious admixture of early Brahminical influence is still noticeable, and no act of public importance takes place without the assistance of the divinations of the Brahmin priests. The Siamese, as southern Buddhists, pride themselves on their orthodoxy; and since Burma, like Ceylon, has lost its independence, the king is regarded in the light of the sole surviving defender of the faith. There is a close connexion between the laity and priesthood, as the Buddhist rule, which prescribes that every man should enter the priesthood for at least a few months, is almost universally observed, even young princes and noblemen who have been educated in Europe donning the yellow robe on their return to Siam. A certain amount of scepticism prevails among the educated classes, and political motives may contribute to their apparent orthodoxy, but there is no open dissent from Buddhism, and those who discard its dogmas still, as a rule, venerate it as an ethical system. The accounts given by some writers as to the profligacy and immorality in the monasteries are grossly exaggerated. Many of the temples in the capital are under the direct supervision of the king, and in these a stricter rule of life is observed. Some of the

priests are learned in the Buddhist scriptures, and most of the Pali scholarship in Siam is to be found in monasteries, but there is no learning of a secular nature. There is little public worship in the Christian sense of the word. On the day set apart for worship (*Wan Phra*, or "Day of the Lord") the attendance at the temples is small and consists mostly of women. Religious or semi-religious ceremonies, however, play a great part in the life of the Siamese, and few weeks pass without some great function or procession. Among these the cremation ceremonies are especially conspicuous. The more exalted the personage the longer, as a rule, is the body kept before cremation. The cremations of great people, which often last several days, are the occasion of public festivities and are celebrated with processions, theatrical shows, illuminations and fireworks. The missionaries in Siam are entirely French Roman Catholics and American Protestants. They have done much to help on the general work of civilization, and the progress of education has been largely due to their efforts.

Education.—As in Burma, the Buddhist monasteries scattered throughout the country carry on almost the whole of the elementary education in the rural districts. A provincial training college was established in 1903 for the purpose of instructing priests and laymen in the work of teaching, and has turned out many qualified teachers whose subsequent work has proved satisfactory. By these means, and with regular government supervision and control, the monastic schools are being brought into line with the government educational organization. They now contain not far short of 100,000 pupils. In the metropolitan *monion* there are primary, secondary and special schools for boys and girls, affording instruction to some 10,000 pupils. There are also the medical school, the law school, the civil service school, the military schools and the agricultural college, which are entered by students who have passed through the secondary grade for the purpose of receiving professional instruction. Many of the special schools use the English language for conveying instruction, and there are three special schools where the whole curriculum is conducted in English by English masters. Two scholarships of £300 a year each for four years are annually competed for by the scholars of these schools, the winners of which proceed to Europe to study a subject of their own selection which shall fit them for the future service of their country. Most of the special schools also give scholarships to enable the best of their pupils to complete their studies abroad. The result of the widespread monastic school system is that almost all men can read and write a little, though the women are altogether illiterate.

History.

Concerning the origin of the name "Siam" many theories have been advanced. The early European visitors to the country noticed that it was not officially referred to by any such name, and therefore apparently conceived that the term must have been applied from outside. Hence the first written accounts give Portuguese, Malay and other derivations, some of which have continued to find credence among quite recent writers. It is now known, however, that "Siam" or "Sayam" is one of the most ancient names of the country, and that at least a thousand years ago it was in common use, such titles as Swankalok-Sukhotai, Shahr-i-nao, Dwarapuri, Ayuthia, the last sometimes corrupted to "Judea," by which the kingdom has been known at various periods of its history, being no more than the names of the different capital cities whose rulers in turn brought the land under their sway. The Siamese (Thai) call their country Muang Thai, or "the country of the Thai race," but the ancient name Muang Sayam has lately been revived. The gradual evolution of the Siamese (Thai) from the fusion of Lao-Tai and Khmer races has been mentioned above. Their language, the most distinctively Lao-Tai attribute which they have, plainly shows their very close relationship with the latter race and its present branches, the Shans (Tai Lông) and the Ahom of Assam, while their appearance, customs, written character and religion bear strong evidence of their affinity with the Khmers. The southward movement of the Lao-Tai family from their original seats in south-west China is of very ancient date, the Lao states of Luang Prabang and Wieng Chan on the Mekong having been founded at least two thousand years ago. The first incursions of Lao-Tai among the Khmers of northern Siam were probably later, for the town of Lampun (Labong or Haribunchai), the first Lao capital in Siam, was founded about A.D. 575. The fusion of races may be said to have begun then, for it was during the succeeding centuries that the kings of Swankalok-Sukhotai gradually assumed Lao characteristics, and that the Siamese language, written character and other racial peculiarities were in course of formation. But the finishing

touches to the new race were supplied by the great expulsion of Lao-Tai from south-west China by Kublai Khan in A.D. 1250, which profoundly affected the whole of Further India. Thereafter the north, the west and the south-west of Siam, comprising the kingdom of Swankalok-Sukhotai, and the states of Suphan and Nakhon Sri Tammarat (Ligore), with their sub-feudatories, were reduced by the Siamese (Thai), who, during their southern progress, moved their capital from Sukhotai to Nakhon Sawan, thence to Kampeng Pet, and thence again to Suvarnabhumi near the present Kanburi. A Sukhotai inscription of about 1284 states that the dominions of King Rama Kamheng extended across the country from the Mekong to Pechaburi, and thence down the Gulf of Siam to Ligore; and the Malay annals say that the Siamese had penetrated to the extremity of the peninsula before the first Malay colony from Menangkabu founded Singapore, *i.e.* about 1160. Meanwhile the ancient state of Lavo (Lopburi), with its capital at Sano (Sornau or Shahr-i-nao), at one time feudatory to Swankalok-Sukhotai, remained the last stronghold of the Khmer, although even here the race was much modified by Lao-Tai blood; but presently Sano also was attacked, and its fall completed the ascendancy of the Siamese (Thai) throughout the country. The city of Ayuthia which rose in A.D. 1350 upon the ruins of Sano was the capital of the first true Siamese king of all Siam. This king's sway extended to Moulmein, Tavoy, Tenasserim and the whole Malacca peninsula (where among the traders from the west Siam was known as Sornau, *i.e.* Shahr-i-nau, long after Sano had disappeared—Yule's *Marco Polo*, ii. 260), and was felt even in Java. This is corroborated by Javan records, which describe a "Cambodian" invasion about 1340; but Cambodia was itself invaded about this time by the Siamese, who took Angkor and held it for a time, carrying off 90,000 captives. The great southward expansion here recorded is confirmed by the Chinese annals of the period. The wars with Cambodia continued with varying success for some 400 years, but Cambodia gradually lost ground and was finally shorn of several provinces, her sovereign falling entirely under Siamese influence. This, however, latterly became displeasing to the French, now in Cochin China, and Siam was ultimately obliged to recognize the protectorate forced on Cambodia by that power. Vigorous attacks were also made during this period on the Lao states to the north-west and north-east, followed by vast deportation of the people, and Siamese supremacy was pretty firmly established in Chieng-mai and its dependencies by the end of the 18th century, and over the great eastern capitals, Luang Prabang and Vien-chang, about 1828. During the 15th and 16th centuries Siam was frequently invaded by the Burmese and Peguans, who, attracted probably by the great wealth of Ayuthia, besieged it more than once without success, the defenders being aided by Portuguese mercenaries, till about 1555, when the city was taken and Siam reduced to dependence. From this condition, however, it was raised a few years later by the great conqueror and national hero Phra Naret, who after subduing Laos and Cambodia invaded Pegu, which was utterly overthrown in the next century by his successors. But after the civil wars of the 18th century the Burmese, having previously taken Chieng-mai, which appealed to Siam for help, entered Tenasserim and took Mergui and Tavoy in 1764, and then advancing simultaneously from the north and the west captured and destroyed Ayuthia after a two years' siege (1767).

The intercourse between France and Siam began about 1680 under Phra Narain, who, by the advice of his minister, the Cephalonian adventurer Constantine Phaulcon, sent an embassy to Louis XIV. When the return mission arrived, the eagerness of the ambassador for the king's conversion to Christianity, added to the intrigues of Phaulcon with the Jesuits with the supposed intention of establishing a French supremacy, led to the death of Phaulcon, the persecution of the Christians, and the cessation of all intercourse with France. An interesting episode was the active intercourse, chiefly commercial, between the Siamese and Japanese governments from 1592 to 1632. Many Japanese settled in Siam, where they were much employed.

They were dreaded as soldiers, and as individuals commanded a position resembling that of Europeans in most eastern countries. The jealousy of their increasing influence at last led to a massacre, and to the expulsion or absorption of the survivors. Japan was soon after this, in 1636, closed to foreigners; but trade was carried on at all events down to 1745 through Dutch and Chinese and occasional English traders. In 1752 an embassy came from Ceylon, desiring to renew the ancient friendship and to discuss religious matters. After the fall of Ayuthia a great general, Phaya Takh Sin, collected the remains of the army and restored the fortunes of the kingdom, establishing his capital at Bangkok; but, becoming insane, he was put to death, and was succeeded by another successful general, Phaya Chakkri, who founded the present dynasty. Under him Tenasserim was invaded and Tavoy held for the last time by the Siamese in 1792, though in 1825, taking advantage of the Burmese difficulty with England, they bombarded some of the towns on that coast. The supremacy of China is indicated by occasional missions sent, as on the founding of a new dynasty, to Peking, to bring back a seal and a calendar. But the Siamese now repudiate this supremacy, and have sent neither mission nor tribute for sixty years, while no steps have been taken by the Chinese to enforce its recognition. The sovereign, Phra Paramendr Maha Mongkut, was a very accomplished man, an enlightened reformer and devoted to science; his death, indeed, was caused by fatigue and exposure while observing an eclipse. Many of his predecessors, too, were men of different fibre from the ordinary Oriental sovereign, while his son Chulalong Korn, who succeeded him in 1868, showed himself an administrator of the highest capacity. He died on the 23rd of October 1910.

Of European nations the Portuguese first established intercourse with Siam. This was in 1511, after the conquest of Malacca by D'Albuquerque, and the intimacy lasted over a century, the tradition of their greatness having hardly yet died out. They were supplanted gradually in the 17th century by the Dutch, whose intercourse also lasted for a similar period; but they have left no traces of their presence, as the Portuguese always did in these countries to a greater extent than any other people. English traders were in Siam very early in the 17th century; there was a friendly interchange of letters between James I. and the king of Siam, who had some Englishmen in his service, and, when the ships visited "Sia" (which was "as great a city as London") or the queen of Patani, they were hospitably received and accorded privileges—the important items of export being, as now, tin, varnish, deer-skins and "precious drugs." Later on, the East India Company's servants, jealous at the employment of Englishmen not in their service, attacked the Siamese, which led to a massacre of the English at Mergui in 1687, and the factory at Ayuthia was abandoned in 1688. A similar attack is said to have been made in 1719 by the governor of Madras. After this the trade was neglected. Pulo Penang, an island belonging to the Siamese dependency of Kedah, was granted on a permanent lease to the East India Company in 1786, and treaties were entered into by the sultan of Kedah with the company. In 1822 John Crawfurd was sent to Bangkok to negotiate a treaty with the suzerain power, but the mission was unsuccessful. In 1824, by treaty with the Dutch, British interests became paramount in the Malay Peninsula and in Siam, and, two years later, Captain Burney signed the first treaty of friendship and commerce between England and Siam. A similar treaty was effected with America in 1833. Subsequently trade with British possessions revived, and in time a more elaborate treaty with England became desirable. Sir J. Brooke opened negotiations in 1850 which came to nothing, but in 1855 Sir J. Bowring signed a new treaty whereby Siam agreed to the appointment of a British consul in Bangkok, and to the exercise by that official of full extra-territorial powers. Englishmen were permitted to own land in certain defined districts, customs and port dues and land revenues were fixed, and many new trade facilities were granted. This important arrangement was followed at intervals by similar treaties with the other powers, the last two being those with

Japan in 1898 and Russia in 1899. A further convention afterwards provided for a second British consular district in northern Siam, while England and France have both appointed vice-consuls in different parts of the country. Thus foreigners in Siam, except Chinese who have no consul, could only be tried for criminal offences, or sued in civil cases, in their own consular courts. A large portion of the work of the foreign consuls, especially the British, was consequently judicial, and in 1901 the office of judge was created by the British government, a special judge with an assistant judge being appointed to this post. Meanwhile, trade steadily increased, especially with Great Britain and the British colonies of Hong Kong and Singapore.

The peaceful internal development of Siam seemed also likely to be favoured by the events that were taking place outside her frontiers. For centuries she had been distracted by wars with Cambodians, Peguans and Burmans, but the incorporation of Lower Cochin China, Annam and Tongking by the French, and the annexation of Lower and Upper Burma successively by the British, freed her from all further danger on the part of her old rivals. Unfortunately, she was not destined to escape trouble. The frontiers of Siam, both to the east and the west, had always been vague and ill-defined, as was natural in wild and unexplored regions inhabited by more or less barbarous tribes. The frontier between Siam and the new British possessions in Burma was settled amicably and without difficulty, but the boundary question on the east was a much more intricate one and was still outstanding. Disputes with frontier tribes led to complications with France, who asserted that the Siamese were occupying territory that rightfully belonged to Annam, which was now under French protection. France, while assuring the British Government that she laid no claim to the province of Luang Prabang, which was situated on both banks of the upper Mekong, roughly between the 18th and 20th parallels, claimed that farther south the Mekong formed the true boundary between Siam and Annam, and demanded the evacuation of certain Siamese posts east of the river. The Siamese refused to yield, and early in 1893 encounters took place in the disputed area, in which a French officer was captured and French soldiers were killed. The French then despatched gunboats from Saigon to enforce their demands at Bangkok, and these made their way up to the capital in spite of an attempt on the part of the Siamese naval forces to bar their way. In consequence of the resistance with which they had met, the French now greatly increased their demands, insisting on the Siamese giving up all territory east of the Mekong, including about half of Luang Prabang, on the payment of an indemnity and on the permanent withdrawal of all troops and police to a distance of 25 kilometres from the right bank of the Mekong. Ten days' blockade of the port caused the Siamese government to accede to these demands, and a treaty was made, the French sending troops to occupy Chantabun until its provisions should have been carried out.

In 1895 lengthy negotiations took place between France and England concerning their respective eastern and western frontiers in Farther India. These negotiations bore important fruit in the Anglo-French convention of 1896, the chief provision of which was the neutralization by the contracting parties of the central portion of Siam, consisting of the basin of the river Menam, with its rich and fertile land, which contains most of the population and the wealth of the country. Neither eastern nor southern Siam was included in this agreement, but nothing was said to impair or lessen in any way the full sovereign rights of the king of Siam over those parts of the country. Siam thus has its independence guaranteed by the two European powers who alone have interests in Indo-China, England on the west and France on the east, and has therefore a considerable political interest similar to that of Afghanistan, which forms a buffer state between the Russian and British possessions on the north of India. Encouraged by the assurance of the Anglo-French convention, Siam now turned her whole attention to internal reform, and to such good purpose that, in a few years, improved government and expansion of trade aroused a general interest

in her welfare, and gave her a stability which had before been lacking. With the growth of confidence negotiations with France were reopened, and, after long discussion, the treaty of 1893 was set aside and Chantabun evacuated in return for the cession of the provinces of Bassac, Melupré, and the remainder of Luang Prabang, all on the right bank of the Mekong, and of the maritime district of Krat. These results were embodied in a new treaty signed and ratified in 1904.

Meanwhile, in 1899, negotiations with the British government led to agreements defining the status of British subjects in Siam, and fixing the frontier between southern Siam and the British Malay States, while in 1900 the provisions of Sir J. Bowring's treaty of 1855, fixing the rates of land revenue, were abrogated in order to facilitate Siamese financial reform.

In 1907 a further convention was made with France, Siam returning to the French protectorate of Cambodia the province of Battambang conquered in 1811, and in compensation receiving back from France the maritime province of Krat and the district of Dansai, which had been ceded in 1904. This convention also modified the extra-territorial rights enjoyed by France in Siam, and disclosed an inclination to recognize the material improvements of the preceding years. In 1907 also negotiations were opened with Great Britain, the objects of which were to modify the extra-territorial rights conceded to that power by the treaty of 1855, and to remove various restrictions regarding taxation and general administration, which, though diminished from time to time by agreement, still continued to hamper the government very much. These negotiations continued all through 1908 and resulted in a treaty, signed and ratified in 1909, by which Siam ceded to Great Britain her suzerain rights over the dependencies of Kedah, Kelantan, Trengganu and Perlis, Malay states situated in southern Siam just north of British Malaya, containing in all about a million inhabitants and for the most part flourishing and wealthy, and obtained the practical abolition of British jurisdiction in Siam proper as well as relief from any obligations which, though probably very necessary when they were incurred, had long since become mere useless and vexatious obstacles to progress towards efficient government. This treaty, a costly one to Siam, is important as opening up a prospect of ultimate abandonment of extra-territorial rights by all the powers. Administrative reform and an advanced railway policy have made of Siam a market for the trade of Europe, which has become an object of keen competition. In 1908 the British empire retained the lead, but other nations, notably Germany, Denmark, Italy and Belgium, had recently acquired large interests in the commerce of the country. Japan also, after an interruption of more than two hundred years, had resumed active commercial relations with Siam.

AUTHORITIES.—H. Alabaster, *Wheel of the Law* (London, 1871); Dr Anderson, *English Intercourse with Siam in the 17th Century* (London, 1890); W. J. Archer, *Journey in the Mekong Valley* (1892); C. Bock, *Temples and Elephants*; Sir John Bowring, *The Kingdom and People of Siam* (London, 1857); J. G. D. Campbell, *Siam in the Twentieth Century* (London, 1902); A. C. Carter, *The Kingdom of Siam* (New York, 1904); A. R. Colquhoun, *Amongst the Shans* (London, 1885); J. Crawford, *Journal of an Embassy to Siam* (London, 1829); Lord Curzon, *Nineteenth Century* (July, 1893); H.R.H. Prince Damrong, "The Foundation of Ayuthia," *Siam Society Journal* (1905); Diplomatic and Consular Reports for Bangkok and Chien Mai (1888-1907); Directory for Bangkok and Siam (*Bangkok Times Office Annual*); Francis Garnier, *Voyage d'exploration en Indo-Chine* (Paris, 1873); *Geographical Journal*, papers by J. S. Black, Lord Curzon, Lord Lamington, Professor H. Louis, J. M'Carthy, W. H. Smythe, Colonel G. E. Gerini, "The Tonsure Ceremony," "The Art of War in Indo-China"; "Siam's Intercourse with China," *Asiatic Quarterly Review* (1906); "Historical Retrospect of Junkceylon Island," *Siam Society's Journal* (1905); W. A. Graham, "Brief History of the R.C. Mission in Siam," *Asiatic Quarterly Review* (1901); Mrs Grindrod, *Siam: a Geographical Summary*; H. Hallet, *A Thousand Miles on an Elephant* (London, 1890); Captain Hamilton, *A New Account of the East Indies* (1688-1723); Prince Henri d'Orléans, *Around Tonquin and Siam* (London, 1894); Professor A. H. Keane, *Eastern Geography: Asia*; Dr Keith, *Journal Royal Asiatic Society* (1892); C. S. Leckie, *Journal Society of Arts* (1894), vol. xlii.; M. de la Loubere, *Description du royaume de Siam* (Amsterdam, 1714); Captain Low, *Journal Asiatic Society*,

vol. vii.; J. M'Carthy, *Surveying and Exploring in Siam* (London, 1900); Henri Mouhot, *Travels in Indo-China* (London, 1844); F. A. Neale, *Narrative of a Residence in Siam* (London, 1852); Sir H. Norman, *The Far East* (London, 1904); Bishop Pallegoix, *Description du royaume Thai ou Siam* (Paris, 1854); H. W. Smythe, *Five Years in Siam* (London, 1898); J. Thomson, *Antiquities of Cambodia, Malacca, Indo-China and China* (London, 1875); P. A. Thompson, *Lotus Land* (London, 1906); Turpin, *Histoire de Siam* (Paris, 1719); F. Vincent, *Land of the White Elephant*; E. Young, *The Kingdom of the Yellow Robe* (London, 1898).

Language and Literature.

Siamese belongs to the well-defined Tai group of the Siamese-Chinese family of languages. Its connexion with Chinese is clear though evidently distant, but its relationship with the other languages of the Tai group is very close. It is spoken throughout central Siam, in all parts of southern Siam except Patani Monton, in northern Siam along the river-banks as far up as Utaradit and Raheng, and in eastern Siam as far as the confines of the Korat Monton. In Patani the common language is still Malay, while in the upper parts of northern, and the outlying parts of eastern, Siam the prevailing language is Lao, though the many hill tribes which occupy the ranges of these parts have distinct languages of their own.

Originally Siamese was purely monosyllabic, that is, each true word consisted of a single vowel sound preceded by, or followed by, a consonant. Of such monosyllables there are less than two thousand, and therefore many syllables have to do duty for the expression of more than one idea, confusion being avoided by the tone in which they are spoken, whence the term "tonal," which is applied to all the languages of this family. The language now consists of about 15,000 words, of which compounds of two monosyllabic words and appropriations from foreign sources form a very large part. Bali, the ancient language of the kingdom of Magadha, in which the sacred writings of Buddhism were made, was largely instrumental in forming all the languages of Further India, including Siamese—a fact which accounts for the numerous connecting links between the Môn, Burmese and Siamese languages of the present time, though these are of quite separate origin. When intercourse with the West began, and more especially when Western methods of government and education were first adopted in Siam, the tendency to utilize European words was very marked, but recently there has been an effort to avoid this by the coining of Siamese or Bali compound words.

The current Siamese characters are derived from the more monumental Cambodian alphabet, which again owes its origin to the alphabet of the inscriptions, an offshoot of the character found on the stone monuments of southern India in the 6th and 8th centuries. The sacred books of Siam are still written in the Cambodian character.

The Siamese alphabet consists of 44 consonants, in each of which the vowel sound "aw" is inherent, and of 32 vowels all marked not by individual letters, but by signs written above, below, before or after the consonant in connexion with which they are to be pronounced. It may seem at first that so many as 44 consonants can scarcely be necessary, but the explanation is that several of them express each a slightly different intonation of what is practically the same consonant, the sound of "kh," for instance, being represented by six different letters and the sound of "t" by eight. Moreover, other letters are present only for use in certain words imported from Bali or Sanskrit. The vowel signs have no sound by themselves, but act upon the vowel sound "aw" inherent in the consonants, converting it into "a," "i," "o," "e," "ow," &c. Each of the signs has a name, and some of them produce modulations so closely resembling those made by another that at the present day they are scarcely to be distinguished apart. A hard-and-fast rule of pronunciation is that only vowel or diphthong sounds, or the letters "m," "n," "ng," "k," "t" and "p" are permissible at the end of words, and hence the final letter of all words ending in anything else is simply suppressed or is pronounced as though it were a letter naturally producing one or other of those sounds. Thus many of the words procured from foreign sources, not excluding Bali and Sanskrit, are more or less mutilated in pronunciation, though the entirely suppressed or altered letter is still retained in writing.

Siamese is written from left to right. In manuscript there is usually no space between words, but punctuation is expressed by intervals isolating phrases and sentences.

The greatest difficulty with the Siamese language lies in the tonal system. Of the simple tones there are five—the even, the circumflex, the descending, the grave and the high—any one of which when applied to a word may give it a quite distinct meaning. Four of the simple tones are marked in the written character by signs placed over the consonant affected, and the absence of a mark implies that the one remaining tone is to be used. A complication is caused by the fact that the consonants are grouped into three

classes, to each of which a special tone applies, and consequently the application of a tonal sign to a letter has a different effect, according to the class to which such letter belongs. Though many syllables have to do duty for the expression of more than one idea, the majority have only one or at most two meanings, but there are some which are used with quite a number of different inflections, each of which gives the word a new meaning. Thus, for example, the syllable *khao* may mean "they," "badly," "rice," "white," "old," or "news," simply according to the tone in which the word is spoken. Words are unchangeable and incapable of inflection. There is no article, and no distinction of gender, number or case. These, when it is necessary to denote them, are expressed by explanatory words after the respective nouns; only the dative and ablative are denoted by subsidiary words, which precede the nouns, the nominative being marked by its position before, the objective by its position after, the verb, and the genitive (and also the adjective) by its place after the noun it qualifies. Occasionally, however, auxiliary nouns serve that purpose. Words like "mother," "son," "water" are often employed in forming compounds to express ideas for which the Siamese have no single words, e.g. *lák cón*, "the son of hire," a labourer; *mê mü*, "the mother of the hand," the thumb. The use of class words with numerals obtains in Siamese as it does in Chinese, Burmese, Anamese, Malay and many other Eastern languages. As in these, so in Siamese the personal pronouns are mostly represented by nouns expressive of the various shades of superior or lower rank according to Eastern etiquette. The verb is, like the noun, perfectly colourless—person, number, tense and mood being indicated by auxiliary words only when they cannot be inferred from the context. Such auxiliary words are *yá*, "to be," "to dwell" (present); *dai*, "to have," *leas*, "end" (past); *cá*, "also" (future); the first and third follow, the second and fourth precede, the verb. *Hài*, "to give" (prefixed), often indicates the subjunctive. As there are compound nouns, so there are compound verbs; thus, e.g. *pai*, "to go," is joined to a transitive verb to convert it into an intransitive or neuter; and *thák*, "to touch," and *lóng*, "to be compelled," serve to form a sort of passive voice. The number of adverbs, single and compound, is very large. The prepositions mostly consist of nouns.

The construction of the sentence in Siamese is straightforward and simple. The subject of the sentence precedes the verb and the object follows it. The possessive pronoun follows the object. The adverb usually follows the verb. In compound sentences the verbs are placed together as in English, not separated by the object as in German. When an action is expressed in the past the word which forms with the verb the past tense is divided from the verb itself by the object. Examples are:—

Rao (We) dekhchai (boy) sam (three) kon (persons) cha (will) pai (go) chap (catch) pla (fish) samrap (for) hai (give) paw (father) kin (eat).
Mê (Mother) tan (you) yu (live) ti (place) nai (where), or "Where is your mother?"

Mê (Mother) pai (go) talat (bazaar) leao (finish), or "(My) mother has gone to the bazaar."

The difficulties of the Siamese language are increased by the fact that in addition to the ordinary language of the people there is a completely different set of words ordained for the use of royalty. This "Palace language" appears to have come into existence from a desire to avoid the employment in the presence of royalty of downright expressions of vulgarity or of words which might be capable of conveying an unpleasant or indelicate idea other than the meaning intended. In the effort to escape from the vulgar, words of Sanskrit origin have been freely adopted and many Cambodian words are also used. The language is so complete that the dog, pig, crow and other common or unclean animals are all expressed by special words, while the actions of royalty, such as eating, sleeping, walking, speaking, bathing, dying, are spoken of in words quite distinct from those used to describe similar actions of ordinary people.

The prose literature of Siam consists largely of mythological and historical fables, almost all of which are of Indian origin, though many of them have come to Siam through Cambodia. Their number is larger than is usually supposed, many of them being known to few beyond the writers who laboriously copy them and the professional "raconteurs" who draw upon them to replenish their stock-in-trade. The best known have all been made into stage-plays, and it is in this form that they usually come before the notice of the general public. Amongst them are *Ramakien*, taken from the great Hindu epic *Ramayana*; *Wetyasunyin*, the tale of a king who became an ascetic after contemplation of a withered tree; *Worawongs*, the story of a prince who loved a princess and was killed by the thrust of a magic spear which guarded her; *Chalawan*, the tale of a princess beloved by a crocodile; *Unarud*, the life story of Anuruddha, a demigod, the grandson of Krishna; *Phumhon*, the tale of a princess beloved by an elephant; *Prang tong*, a story of a princess who before birth was promised to a "yak" or giant in

return for a certain fruit which her mother desired to eat. *Mahasot* is an account of the wars of King Mahasot. *Nok Khum* is one of the theories of the genesis of mankind, the *Nok Khum* being the sacred goose or "Hansa" from whose eggs the first human beings were supposed to have been hatched. A considerable proportion of the romances are founded upon episodes in the final life, or in one of the innumerable former existences, of the Buddha. The *Pattama Sompothiyan* is the standard Siamese life of the Buddha. Many of the stories have their scene laid in Himaphan, the Siamese fairyland, probably originally the Himalaya.

A great many works on astrology and the casting of horoscopes, on the ways to secure victory in war, success in love, in business or in gambling, are known, as also works on other branches of magic, to which subject the Siamese have always been partial. On the practice of medicine, which is in close alliance with magic, there are several well-known works.

The *Niti* literature forms a class apart. The word *Niti* is from the Bali, and means "old saying," "tradition," "good counsel." The best known of such works are *Rules for the Conduct of Kings*, translated from the Bali, and *The Maxims of Phra Ruang*, the national hero-king, on whose wonderful sayings and doings the imagination of Siamese youth is fed.

In works on history the literature of Siam is unfortunately rather poor. There can be little doubt that, as in the case of all the other kingdoms of Further India, complete and detailed chronicles were compiled from reign to reign by order of her kings, but of the more ancient of these, the wars and disturbances which continued with such frequency down to quite recent times have left no trace. The *Annals of the North*, the *Annals of Krung Kao* (Ayuthia) and the *Book of the Lives of the Four Kings* (of the present dynasty) together form the only more or less connected history of the country from remote times down to the beginning of the present reign, and these, at least so far as the earlier parts are concerned, contain much that is inaccurate and a good deal which is altogether untrue. Foreign histories include a work on Pegu, a few tales of Cambodian kings and recently published class-books on European history compiled by the educational department.

The number of works on law is considerable. The *Laksana Phra Thamasa*, the *Phra Tamra*, *Phra Tamnon*, *Phra Racha Kamnot* and *Inthapat* are ancient works setting forth the laws of the country in their oldest form, adapted from the *Dharmacastra* and the *Classification of the Law of Manu*. These, and also many of the edicts passed by kings of the Ayuthia period which have been preserved, are now of value more as curiosities of literature and history than anything else, since, for all practical purposes, they have long been superseded by laws more in accordance with modern ideas. The laws of the sovereigns who have reigned at Bangkok form the most notable part of this branch of Siamese literature. They include a great number of revenue regulations, laws on civil matters such as mortgage, bankruptcy, rights of way, companies, &c., and laws governing the procedure of courts, all of which adhere to Western principles in the main. The latest addition is the Penal Code, a large and comprehensive work based upon the Indian, Japanese and French codes and issued in 1908.

Poetry is a very ancient art in Siam and has always been held in high honour, some of the best-known poets being, indeed, members of the royal family. There are several quite distinct forms of metre, of which those most commonly used are the *Klong*, the *Kap* and the *Klon*. The *Klong* is rhythmic, the play being on the inflection of the voice in speaking the words, which inflection is arranged according to fixed schemes; the rhyme, if it can so be called, being sought not in the similarity of syllables but of intonation. The *Kap* is rhythmical and also has rhyming syllables. The lines contain an equal number of syllables, and are arranged in stanzas of four lines each. The last syllable of the first line rhymes with the third syllable of the second line, the last of the second with the last of the third and also with the first of the fourth line, and the last syllable of the fourth line rhymes with the last of the second line of the next succeeding stanza. The number of poems in one or other of these two metres is very great, and includes verses on almost every theme. In the *Nirat* poetry, a favourite form of verse, both are often used, a stanza in *Klong* serving as a sort of argument at the head of a set of verses in *Kap*. This *Nirat* poetry takes the form of narrative addressed by a traveller to his lady-love, of a journey in which every object and circumstance serves but to remind the wanderer of some virtue or beauty of his correspondent. In most of such works the journey is of course imaginary, but in some cases it is a true record of travelling or campaigning, and has been found to contain information of value concerning the condition at certain times of outlying parts of the kingdom. Of the little love songs in *Klon* metre, called *Klon pet ton*, there are many hundreds. These follow a prescribed form, and consist of eight lines divided into two stanzas

of four lines each, every line containing eight syllables. The last syllable of the first line rhymes with the third syllable of the second, and the final of the second line with the final of the third. The songs treat of all the aspects of love. A fourth poetical metre is *Chan*, which, however, is not so much used as the others.

The introduction of printing in the Siamese character has revolutionized the literature of the country. Reading has become a general accomplishment, a demand for reading matter has arisen, and bookshops stocked with books have appeared to satisfy it. The historical works above referred to have been issued in many editions, and selections from the ancient fables and romances are continually being edited and reissued in narrative form or as plays. The educational department has done good work in compiling volumes of prose and verse which have found much favour with the public. All the laws, edicts and regulations at present in force are to be had in print at popular prices. Printing, in fact, has supplied a great incentive to the development of literature, the output has increased enormously, and will doubtless continue to do so for a long time to come.

SĪBAWAIHI [Abū Bishr, or Abū-l Ḥasan'Amr ibn'Uthmān ibn Qanbar, known as SĪBAWAIHI or SĪBŪYA] (c. 753-793), Arabian grammarian, was by origin a Persian and a freedman. Of his early years nothing is known. At the age of thirty-two he went to Baṣra, where he was a pupil of the celebrated grammarian Khalil. Later he went to Bagdad, but soon left, owing to a dispute with the Kufan grammarian Kisā'i, and returned to Persia, where he died at the age of about forty. His great grammar of Arabic, known simply as *The Book*, is not only the earliest systematic presentation of Arabic grammar, but is recognized among Arabs as the most perfect. It is not always clear, but is very full and valuable for its many illustrations from the Koran and the poets.

The Book was published by H. Derenbourg (2 vols., Paris, 1881-1889), and a German translation, with extracts from the commentary of Sirāfi (d. 978) and others, was published by G. Jahn (Berlin, 1895-1900). (G. W. T.)

SIBBALD, SIR ROBERT (1641-1722), Scottish physician and antiquary, was born in Edinburgh on the 15th of April 1641. Educated at Edinburgh, Leiden and Paris, he took his doctor's degree at Angers in 1662, and soon afterwards settled as a physician in Edinburgh. In 1667 with Sir Andrew Balfour he started the botanical garden in Edinburgh, and he took a leading part in establishing the Royal College of Physicians of Edinburgh, of which he was elected president in 1684. In 1685 he was appointed the first professor of medicine in the university. He was also appointed geographer-royal in 1682, and his numerous and miscellaneous writings deal effectively with historical and antiquarian as well as botanical and medical subjects. He died in August 1722.

Amongst Sibbald's historical and antiquarian works may be mentioned *A History Ancient and Modern of the Sheriffdoms of Fife and Kinross* (Edinburgh, 1710, and Cupar, 1803), *An Account of the Scottish Atlas* (folio, Edinburgh, 1683), *Scotia illustrata* (Edinburgh, 1684) and *Description of the Isles of Orkney and Shetland* (folio, Edinburgh, 1711 and 1845). The *Remains of Sir Robert Sibbald*, containing his autobiography, memoirs of the Royal College of Physicians, portion of his literary correspondence and account of his manuscripts, was published at Edinburgh in 1833.

SIBERIA. This name (Russ. *Sibir*) in the 16th century indicated the chief settlement of the Tatar khan Kuchum—Isker on the Irtysh. Subsequently the name was extended to include the whole of the Russian dominions in Asia. **Name and extent.** Geographically, Siberia is now limited by the Ural Mountains on the W., by the Arctic and North Pacific Oceans on the N. and E. respectively, and on the S. by a line running from the sources of the river Ural to the Tarbagatai range (thus separating the steppes of the Irtysh basin from those of the Aral and Balkash basins), thence along the Chinese frontier as far as the S.E. corner of Transbaikalia, and then along the rivers Argun, Amur and Usuri to the frontier of Korea. This wide area is naturally subdivided into West Siberia (basins of the Ob and the Irtysh) and East Siberia (the remainder of the region).

The inhabited districts are well laid down on the best maps; but the immense areas between and beyond them are mapped only along a few routes hundreds of miles apart. The intermediate spaces are filled in according to information derived from various hunters. With regard to a great many rivers we know only the position of their mouths and their approximate lengths estimated by natives in terms of a day's march. Even the **Orography.**

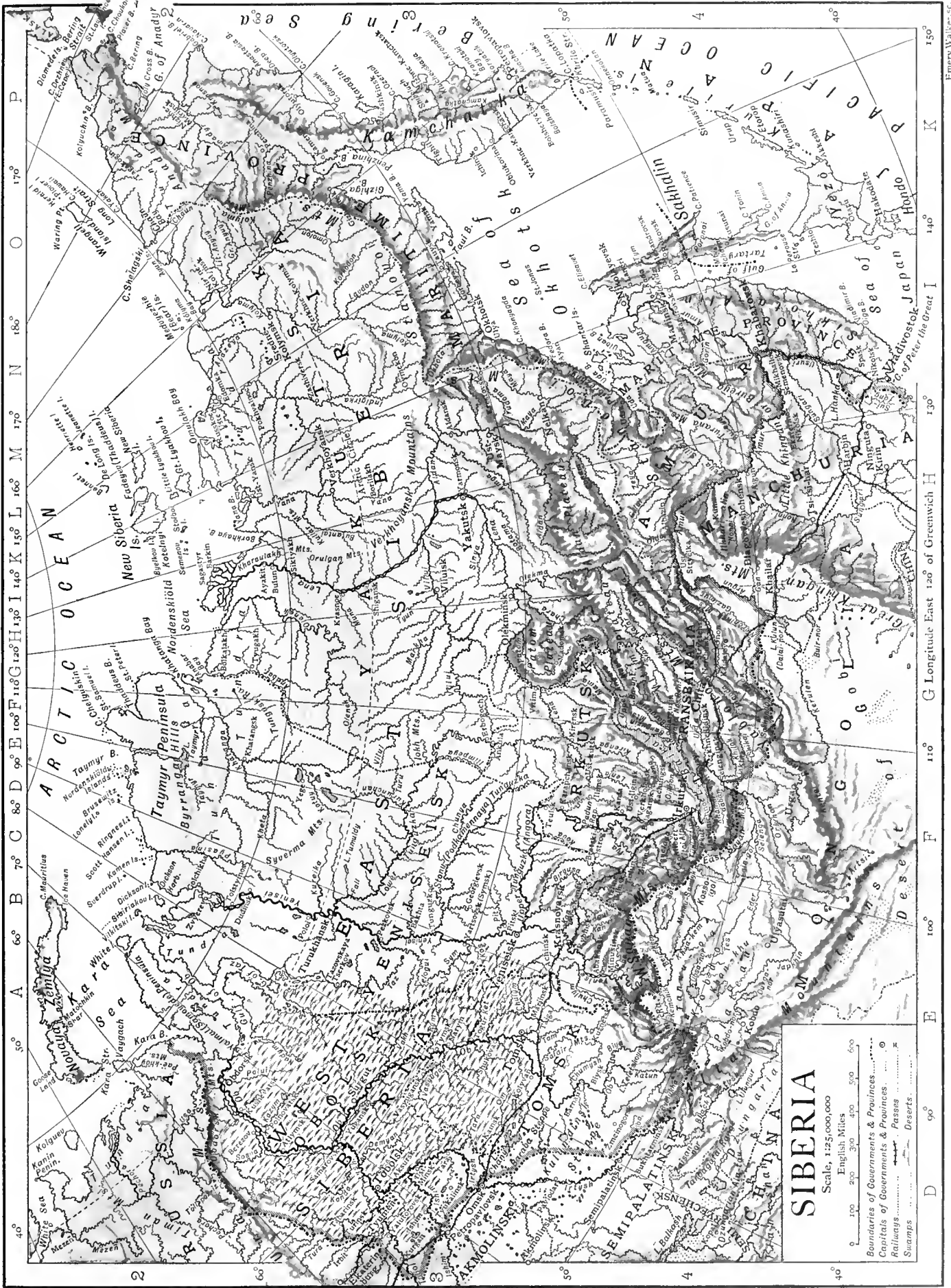

hydrographical network is very imperfectly known, especially in the uninhabited hilly tracts.¹

Like other plateaus, the great plateau of the centre of Asia, stretching from the Himalayas to Bering Strait,² has on its surface a number of gentle eminences (*angehäufte Gebirge* of K. Ritter), which, although reaching great absolute altitudes, are relatively low.³ These heights for the most part follow a north-easterly direction in Siberia. On the margins of the plateau there are several gaps or indentations, which can best be likened to gigantic trenches, like railway cuttings, as with an insensible gradient they climb to a higher level. These trenches have for successive geological periods been the drainage valleys of immense lakes (probably also of glaciers) which formerly extended over the plateau or fiords of the seas which surrounded it. And it is along these trenches that the principal commercial routes have been made for reaching the higher levels of the plateau itself. In the plateau there are in reality two terraces—a higher and a lower, both very well defined in Transbaikalia and in Mongolia. The Yablonoi range and its south-western continuation the Kentei are border-ridges of the upper terrace. Both rise very gently above it, but have steep slopes towards the lower terrace, which is occupied by the Nerchinsk steppes in Transbaikalia and by the great desert of Gobi in Mongolia (2000 to 2500 ft. above the sea). They rise 5000 to 7000 ft. above the sea; the peak of Sokhondo in Transbaikalia (111° E.) reaches nearly 8050 ft. Several low chains of mountains have their base on the lower terrace and run from south-west to north-east; they are known as the Nerchinsk Mountains in Transbaikalia, and their continuations reach the northern parts of the Gobi.⁴

The great plateau is fringed on the north-west by a series of lofty border-ranges, which have their southern base on the plateau and their northern at a much lower level. They may be traced from the Tian-shan to the Arctic Circle, and have an east-north-easterly direction in lower latitudes and a north-easterly direction farther north. The Alai range of the Pamir, continued by the Kokshaltau range and the Khan-tengri group of the Tian-shan, and the Saïlughem range of the Altai, which is continued in the unnamed border-range of West Sayan (between the Bei-kem and the Us), belong to this category. There are, however, among these border-ranges several breaches of continuity—broad depressions or trenches leading from Lake Balkash and Lake Zaisan to the upper parts of the plateau. On the other hand, there are on the western outskirts of the plateau a few mountain chains which take a direction at right angles to the above (that is, from north-west to south-east), and parallel to the great line of upheavals in south-west Asia. The Tarbagatai Mountains, on the borders of Siberia, as well as several chains in Turkestan, are instances. The border-ridges of the Alai Mountains, the Khan-tengri group, the Saïlughem range and the West Sayan contain the highest peaks of their respective regions. Beyond 102° E. the configuration is complicated by the great lateral indentation of Lake Baikal. But around and north-east of this lake the same well-marked ranges fringe the plateau and turn their steep north-western slope towards the valleys of the Irkut, the Barguzin, the Muya and the Chara, while their southern base lies on the plateaus of the Selenga (nearly 4000 ft. high) and the Vitim. The peaks of the Saïlughem range reach 9000 to 11,000 ft. above the sea, those of West Sayan about 10,000. In East Sayan is Munku-Sardyk, a peak 11,450 ft. high, together with many others from 8000 to 9000 ft. Farther east, on the southern shore of Lake Baikal, Khamar-daban rises to 6900 ft., and the bald dome-shaped summits of the Barguzin and southern Muya Mountains attain elevations of 6000 to 7000 ft. above sea-level. The orography of the Aldan region is little known; but travellers who journey from the Aldan (tributary of the Lena) to the Amur or to the Sea of Okhotsk have to cross the same plateau and its border-range. The former becomes narrower and barely attains an average altitude of 3200 ft.

A typical feature of the north-eastern border of the high plateau is a succession of broad longitudinal⁵ valleys along its outer base,

¹The wide area between the middle Lena and the Amur, as well as the hilly tracts west of Lake Baikal, and the Yeniseisk mining region are in this condition.

²The great plateau of North America, also turning its narrower point towards Bering Strait, naturally suggests the idea that there was a period in the history of our planet when the continents turned their narrow extremities towards the northern pole, as now they turn them towards the southern.

³See "General Sketch of the Orography of Siberia," with map and "Sketch of the Orography of Minusinsk, &c.," by Prince P. A. Kropotkin, in *Mem. Russ. Geogr. Soc.*, General Geography (vol. v., 1875).

⁴The lower terrace is obviously continued in the Tarim basin of East Turkestan; but in the present state of our knowledge we cannot determine whether the further continuations of the border-ridge of the higher terrace (Yablonoi, Kentei) must be looked for in the Great Altai or in some other range situated farther south. There may be also a breach of continuity in some depression towards Barkul.

⁵The word "longitudinal" is here used in an orographical, not a geological sense. These valleys are not synclinal foldings of rocks; they seem to be erosion-valleys.

shut in on the outer side by rugged mountains having a very steep slope towards them. Formerly filled with alpine lakes, these valleys are now sheeted with flat alluvial soil and occupied by human settlements, and are drained by rivers which flow along them before they make their way to the north through narrow gorges pierced in the mountain-walls. This conformation is seen in the valley of the Us in West Sayan, in that of the upper Oka and Irkut in East Sayan, in the valley of the Barguzin, the upper Tsipa, the Muya and the Chara, at the foot of the Vitim plateau, as also, probably, in the Aldan.⁶ The chains of mountains which border these valleys on the north-west contain the wildest parts of Siberia. They are named the Usinsk Mountains in West Sayan and the Tunka Alps in East Sayan; the latter, pierced by the Angara at Irkutsk, are in all probability continued north-east in the Baikal Mountains, which stretch from Irkutsk to Olkhon Island and the Svyatoi Nos peninsula of Lake Baikal, thus dividing the lake into two parts.⁷

An alpine region, 100 to 150 m. in breadth, fringes the plateau on the N. W., outside of the ranges just mentioned. This constitutes what is called in East Siberia the *taiga*: it consists of separate chains of mountains whose peaks rise 4800 to 6500 ft. above the sea, beyond the upper limits of forest vegetation; while the narrow valleys afford difficult means of communication, their floors being thickly strewn with boulders, or else swampy. The whole is clothed with impenetrable forest. The orography of this alpine region is very imperfectly known; but the chains have a predominant direction from south-west to north-east. They are described under different names in Siberia—the Altai Mountains in West Siberia, the Kuznetskiy Ala-tau and the Us and Oya Mountains in West Sayan, the Nizhne-Udinsk *taiga* or gold-mine district, several chains pierced by the Oka river, the Kitoi Alps in East Sayan, the mountains of the upper Lena and Kirenga, the Olekminsk gold-mine district, and the unnamed mountains which project north-east between the Lena and the Aldan.

Outside of these alpine regions comes a broad belt of elevated plains, ranging between 1200 and 1700 ft. above the sea. These plains, which are entered by the great Siberian highway about Tomsk and extend south-west to the Altai Mountains, are for the most part fertile, though sometimes dry, and are rapidly being covered with the villages of the Russian immigrants. About Kansk in East Siberia they penetrate in the form of a broad gulf south-eastwards as far as Irkutsk. Those on the upper Lena, having a somewhat greater altitude and being situated in higher latitudes, are almost wholly unfitted for agriculture. The north-western border of these elevated plains cannot be determined with exactitude. In the region between Viluis (on the Vilui) and Yeniseisk a broad belt of alpine tracts, reaching their greatest elevation in the northern Yeniseisk *taiga* (between the Upper Tunguzka and the Podkamennaya Tunguzka) and continued to the south-west in lower upheavals, separates the elevated plains from the lowlands which extend towards the Arctic Ocean. In West Siberia these high plains seem to form a narrower belt towards Barnaul and Semipalatinsk, and are bordered by the Aral-Caspian depression.

Farther to the north-west, beyond these high plains, comes a broad belt of lowlands. This vast tract, which is only a few dozen feet above the sea, and most probably was covered by the sea during the Post-Pliocene period, stretches from the Aral-Caspian depression to the lowlands of the Tobol, Irtysh and Ob, and thence towards the lower parts of the Yenisei and the Lena. Only a few detached mountain ranges, like the Byrranga on the Taymyr peninsula, the Syverma Mountains, the Verkhononk and the Kharaulakh (E. of the Lena) ranges, diversify these monotonous lowlands, which are covered with a thick sheet of black earth in the south and assume the character of barren tundras in the north.

The south-eastern slope of the great plateau of Asia cannot properly be reckoned to Siberia, although parts of the province of Amur and the Maritime Province are situated on it; they have quite a different character, climate and vegetation, and ought properly to be reckoned to the Manchurian region. To the east of the Yablonoi border-range lies the lower terrace of the high plateau, reaching 2000 to 2500 ft. in Transbaikalia and extending farther south-west through the Gobi to East Turkestan. The south-eastern edge of this lower terrace is fringed by a massive border-range—the Khingan—which runs in a north-easterly direction from the Great Wall of China to the sources of the Nonni-ula.

A narrow alpine region (40 to 50 m.), consisting of a series of short secondary chains parallel to the border-range, fringes this latter on its eastern face. Two such folds may be distinguished, corresponding on a smaller scale to the belt of alpine tracts which fringe the plateau on the north-west. The resemblance is further sustained by a broad belt of elevated plains, ranging from 1200 to 1700 ft., which

⁶The upper Bukhtarma valley in the Saïlughem range of the Altai system appears to belong to the same type.

⁷The deep fissure occupied by Lake Baikal would thus appear to consist of two longitudinal valleys connected together by the passage between Olkhon and Svyatoi Nos.

accompany the eastern edge of the plateau. The eastern Gobi, the occasionally fertile and occasionally sandy plains between the Nonni and the Sungari, and the rich plains of the Bureya and Silinji in the Amur province belong to this belt, 400 m. in breadth, the surface of which is diversified by the low hills of Ilkhuri-alin, Khuluñ and Turana. These high plains are bordered on the south-east by a picturesque chain—the Bureya Mountains, which are to be identified with the Little Khingan. It extends, with unaltered character, from Mukden and Kirin to Ulban Bay in the Sea of Okhotsk (close by the Shantar Islands), its peaks clothed from top to bottom with luxuriant forest vegetation, ascending 4500 to 6000 ft. A lowland belt about 200 m. broad runs in the same direction along the outer margin of the above chain. The lower Amur occupies the northern part of this broad valley. These lowlands, dotted over with numberless marshes and lakes, seem to have emerged from the sea at a quite recent geological period; the rivers that meander across them are still excavating their valleys.

Volcanic formations, so far as is known, occur chiefly along the north-western border-range of the great plateau. Ejections of *Vokanoes*, basaltic lava have been observed on the southern slope of this range, extending over wide areas on the plateau itself, over a stretch of more than 600 m.—namely, in East Sayan about Lake Kosso-gol and in the valley of the Tunka (river Irkut), in the vicinity of Selenginsk, and widely distributed on the Vitim plateau (rivers Vitim and Tsipa). Deposits of trap stretch for more than 1200 m. along the Tunguzka; they appear also in the Noril Mountains on the Yenisei, whence they extend towards the Arctic Ocean. Basaltic lavas are reported to have been found in the Aldan region. On the Pacific slope extinct volcanoes (mentioned in Chinese annals) have been reported in the Ilkhuri-alin mountains in northern Manchuria.

The mineral wealth of Siberia is considerable. Gold-dust is found in almost all the alpine regions fringing the great plateau. The principal gold-mining regions in these tracts are the *Mtaerals*. Altai, the upper (or Nizhne-Udinsk) and the lower (or Yeniseisk) *taigas*, and the Olekma region. Gold is found on the high plateau in the basin of the upper Vitim, on the lower plateau in the Nerchinsk district, and on the upper tributaries of the Amur (especially the Oldoi) and the Zeya, in the north-east continuation of the Nerchinsk Mountains. It has been discovered also in the Bureya range, and in its north-east continuation in the Amguñ region. Auriferous sands, but not very rich, have been discovered in the feeders of Lake Hanka and the Suifong river, as also on the smaller islands of the Gulf of Peter the Great. Mining is the next most important industry after agriculture. In East Siberia gold is obtained almost exclusively from gravel-washings, quartz mining being confined to three localities, one near Vladivostok and two in Transbaikalia. In West Siberia, however, quartz-mining is steadily increasing in importance: whereas in 1900 the output of gold from this source was less than 10,000 oz., in 1904 it amounted to close upon 50,000 oz. On the other hand gravel-washing gives a declining yield in West Siberia, for while in 1900 the output from this source was approximately 172,000 oz., in 1904 it was only 81,000 oz. The districts of Mariinsk and Achinsk are the most successful quartz-mining localities. Altogether West Siberia yields annually 130,000 oz. of gold. The gold-bearing gravels of East Siberia, especially those of the Lena and the Amur, are relatively more prolific than those of West Siberia. The total yield annually amounts to some 700,000 oz., the largest quantity coming from the Olekminsk district in the province of Yakutsk, and this district is followed by the Amur region, the Maritime province, and Nerchinsk and Transbaikalia. Silver and lead ores exist in the Altai and the Nerchinsk Mountains, as well as copper, cinnabar and tin. Iron-ores are known at several places on the outskirts of the alpine tracts (as about Irkutsk), as well as in the Selenginsk region and in the Altai. The more important iron-works of the Urals are situated on the Siberian slope of the range. Coal occurs in many Jurassic fresh-water basins, namely, on the outskirts of the Altai, in south Yeniseisk, about Irkutsk, in the Nerchinsk district, at many places in the Maritime province, and on the island of Sakhalin. Beds of excellent graphite have been found in the Kitoi Alps (Mount Alibert) and in the Turukhansk district in Yenisei. Rock-salt occurs at several places on the Lena and in Transbaikalia, and salt-springs are numerous—those of Ust-kutsk on the Lena and of Usole near Irkutsk being the most noteworthy. A large number of lakes, especially in Transbaikalia and in Tomsk, yield salt. Lastly, from the Altai region, as well as from the Nerchinsk Mountains, precious stones, such as jasper, malachite, beryl, dark quartz, and the like, are exported. The Ekaterinburg stone-polishing works in the Urals and those of Kolyvañ in the Altai are well known.

The orography sketched above explains the great development of the river-systems of Siberia and the uniformity of their course.

Rivers. The three principal rivers—the Ob, the Yenisei, and the Lena—take their rise on the high plateau or in the alpine regions fringing it, and, after descending from the plateau and piercing the alpine regions, flow for many hundreds of miles across the high plains and lowlands before they reach the Arctic Ocean. The three rivers of north-eastern Siberia—the Yana, Indigirka and Kolyma—have the same general character, their courses being, however, much shorter, as in these latitudes the plateau approaches

Water communication.

Water communication.

nearer to the Arctic Ocean. The Amur, the upper tributaries of which rise on the eastern border-range of the high plateau, is similar. The Shilka and the Arguñ, which form it, flow first towards the north-east along the windings of the lower terrace of the great plateau; from this the Amur descends, cutting through the Great Khingan and flowing down the terraces of the eastern versant towards the Pacific. A noteworthy feature of the principal Siberian rivers is that each is formed by the confluence of a pair of rivers. Examples are the Ob and the Irtysh, the Yenisei and the Angara (itself a double river formed by the Angara and the Lower Tunguzka), the Lena and the Vitim, the Arguñ and the Shilka, while the Amur in its turn receives a tributary as large as itself—the Sungari. Owing to this twinning and the general direction of their courses, the rivers of Siberia offer immense advantages for inland navigation, not only from north to south but also from west to east. It is this circumstance that facilitated the rapid invasion of Siberia by the Russian Cossacks and hunters; they followed the courses of the twin rivers in their advance towards the east, and discovered short portages which permitted them to transfer their boats from the system of the Ob to that of the Yenisei, and from the latter to that of the Lena, a tributary of which—the Aldan—brought them close to the Sea of Okhotsk. At the present day steamers ply from Tyumeñ, at the foot of the Urals, to Semipalatinsk on the border of the Kirghiz steppe and to Tomsk in the very heart of West Siberia. Uninterrupted water communication could readily be established from Tyumeñ to Yakutsk, Aldansk, and the gold-mines of the Vitim. Owing to the fact that the great plateau separates the Lena from the Amur, no easy water communication can be established between the latter and the other Siberian rivers. The tributaries of the Amur (the Shilka with its affluent the Ingoda) become navigable only on the lower terrace of the plateau. But the trench of the Uda, to the east of Lake Baikal, offers easy access for the Great Siberian railway up to and across the high plateau. Unfortunately all the rivers are frozen for many months every year. Even in lower latitudes (52° to 55° N.) they are ice-bound from the beginning of November to the beginning of May;¹ while in 65° N. they are open only for 90 to 120 days, and only for 100 days (the Yenisei) or even 70 days (the Lena) in 70° N. During the winter the smaller tributaries freeze to the bottom, and about 1st January Lake Baikal becomes covered with a solid crust of ice capable of bearing files of loaded sledges.

Lakes.

Numberless lakes occur in both East and West Siberia. There are wide areas on the plains of West Siberia and on the high plateau of East Siberia, which, virtually, are still passing through the Lacustrine period; but the total area now under water bears but a trifling proportion to the vast surface which the lakes covered even at a very recent period, when Neolithic man inhabited Siberia. All the valleys and depressions bear traces of immense post-Pliocene lakes. Even within historical times and during the 19th century the desiccation of the lakes has gone on at a very rapid rate.² The principal lake is Lake Baikal, more than 400 m. long, and 20 to 50 broad. Another great lake, Lake Kosso-gol, on the Mongolian frontier, is 120 m. long and 50 broad. Vast numbers of small lakes stud the Vitim and upper Selenga plateaus; the lower valley of the latter river contains the Goose Lake (Gusinoye). In the basin of the Amur are Lake Hanka (1700 sq. m.), connected with the Usuri; Lakes Kada and Kidzi, by which the lower Amur once flowed to the Pacific; and very many smaller ones on the left side of the lower Amur. Numerous lakes and extensive marshes diversify the low plains of West Siberia; the Baraba steppe is dotted with lakes and ponds—Lake Chany (1400 sq. m.) and the innumerable smaller lakes which surround it being but relatively insignificant remains of the former lacustrine basins; while at the confluence of the Irtysh and the Ob impassable marshes stretch over many thousands of square miles. Several alpine lakes, of which the picturesque Teletskoye may be specially mentioned, occupy the deeper parts of the valleys of the Altai.

Coasts and Islands.

The coast-line of Siberia is very extensive both on the Arctic Ocean and on the Pacific. The former ocean is ice-bound for at least ten months out of twelve; and, though Nordenskjöld and Captain Wiggins demonstrated (1874-1900) the possibility of navigation along its shores, it is exceedingly doubtful whether it can ever become a commercial route of any importance. The coast-line has few indentations, the chief being the double gulf of the Ob and the Taz, separated from the Sea of Kara by an elongated peninsula (Samoyede), and from the bay of the Yenisei by another. The immense peninsula of Taymyr—a barren tundra intersected by the wild Byrranga Hills—projects in Cape Chelyuskin as far north as $77^{\circ} 46'$ N. The bay of the Yana, east of the delta of the Lena, is a wide indentation sheltered on the north by the islands of New Siberia. The bays of the Kolyma, the Chaun and Kolyuchin are of little importance. The New Siberia islands are occasionally visited by hunters, as is also the small group of the Bear Islands opposite the mouth of the Kolyma. Wrangel or Kellett Island is still quite unknown. Bering Strait, at

¹ The Lena at Verkholsk is navigable for 170 days, at Yakutsk for 153 days: the Yenisei at Krasnoyarsk for 196 days.

² See Yadrintsev, in *Izvestia* of the Russian Geogr. Soc. (1886, No. 1, with maps).

the north-east extremity of Siberia, and Bering Sea between the land of the Chukchis and Alaska, with the Gulf of Anadyr, are often visited by seal-hunters, and the Commander Islands off Kamchatka are valuable stations for this pursuit. The Sea of Okhotsk, separated from the Pacific by the Kurile Archipelago and from the Sea of Japan by the islands of Sakhalin and Yezo, is notorious as one of the worst seas of the world, owing to its dense fogs and its masses of floating ice. The Shantar Islands in the bay of the Uda possess geological interest. The double bay of Gizhiga and Penzhina, as well as that of Taui, would be useful as harbours were they not frozen seven or eight months in the year and persistently shrouded in dense fogs in summer. The northern part of the Sea of Japan, which washes the Usuri region, has, besides the smaller bays of Olga and Vladimir, the beautiful Gulf of Peter the Great, on which stands Vladivostok, the Russian naval station on the Pacific. Okhotsk and Ayan on the Sea of Okhotsk, Petropavlovsk on the east shore of Kamchatka, Nikolayevsk, and Vladivostok on the Sea of Japan, and Dui on Sakhalin are the only ports of Siberia.

Climate.—The climate is extremely severe, even in the southern parts. This arises chiefly from the orographical structure; the vast plateau of Central Asia prevents the moderating influence of the sea from being felt. The extensive lowlands which stretch over more than one half of the area, as well as the elevated plains, lie open to the Arctic Ocean. Although attaining altitudes of 6000 to 10,000 ft., the mountain peaks of East Siberia do not reach the snow-line, which is found only on the Munku-Sardyk in East Sayan, above 10,000 ft. Patches of perpetual snow occur in East Siberia only on the mountains of the far north. On the Altai Mountains the snow-line runs at about 7000 ft. The air, after being chilled on the plateaus during the winter, drifts, owing to its greater density, down upon the lowlands; hence in the region of the lower Lena there obtains an exceedingly low temperature throughout the winter, and Verkhoyansk, in 67°N., is the pole of cold of the eastern hemisphere. The average temperature of winter (December to February) at Yakutsk is -40.2° F., at Verkhoyansk -53.1°. At the polar meteorological station of Sagastyr, in the delta of the Lena (73° 23' N.), the following average temperatures have been observed: January -34.3° F. (February -43.6°), July 40.8°, year 2.1°. The lowest average temperature of a day is -61.6° F. Nevertheless owing to the dryness of the climate, the unclouded sun fully warms the earth during the long summer days in those high latitudes, and gives a short period of warm and even hot weather in the immediate neighbourhood of the pole of cold. Frosts of -13° to -18° F. are not uncommon at Krasnoyarsk, Irkutsk and Nerchinsk; even in the warmer southern regions of West Siberia and of the Amur the average winter temperature is 2.4° F. and -10.2° respectively; while at Yakutsk and Verkhoyansk the thermometer occasionally falls as low as -75° and -85° F. The minimum temperatures recorded at these two stations are -84° F. and -90° respectively; the minimum at Krasnoyarsk is -67° F., at Irkutsk -51°, at Omsk -56°, and at Tobolsk -58° F. The soil freezes many feet deep over immense areas even in southern Siberia. More dreaded than the frosts are the terrible *burans* or snowstorms, which occur in early spring and destroy thousands of horses and cattle that have been grazing on the steppes throughout the winter. Although very heavy falls of snow take place in the alpine tracts—especially about Lake Baikal—on the other side, in the steppe regions of the Altai and Transbaikalia and in the neighbourhood of Krasnoyarsk, the amount of snow is so small that travellers use wheeled vehicles, and cattle are able to find food in the steppe. Spring sets in with remarkable rapidity and charm at the end of April; but in the second half of May come the "icy saints' days," so blighting that it is impossible to cultivate the apple or pear. After this short period of frost and snow summer comes in its full beauty; the days are very hot, and, although they are always followed by cold nights, vegetation advances at an astonishing rate. Corn sown about Yakutsk in the end of May is ripe in the end of August. Still, at many places night frosts set in as early as the second half of July. They become quite common in August and September. Nevertheless September is much warmer than May, and October than April, even in the most continental parts of Siberia. The isotherms are exceedingly interesting. That of 32° F. crosses the middle parts of West Siberia and the southern parts of East Siberia. The summer isotherm of 68° F., which in Europe passes through Cracow and Kaluga, traverses Omsk, Krasnoyarsk and Irkutsk, whence it turns north to Yakutsk, and then south again to Vladivostok. Even the mouths of the Ob, Yenisei, Lena and Kolyma in 70° N. have in July an average temperature of 40° to 50°. Quite contrary is the course of the January isotherms. That of 14° F., which passes in Europe through Uleåborg in Finland only touches the southern part of West Siberia in the Altai Mountains. That of -4° F., which crosses Novaya Zemlya in Europe, passes through Tobolsk, Tomsk, Krasnoyarsk and Irkutsk, and touches 45° N. at Urga in Mongolia, turning north in the Amur region and reaching the Pacific at Nikolayevsk. The isotherm of -22° F., which touches the north point of Novaya Zemlya, passes in Siberia through Turukhansk (at the confluence of the Lena and the Lower Tunguzka) and descends as low as 55° N. in Transbaikalia, whence it turns north to the Arctic Ocean.

Most rain falls in summer, especially in July and August. During the summer an average of 8 in. falls on a zone that stretches from Moscow and St Petersburg through Perm to Tobolsk and, after a dry belt as far as Tomsk, continues in a narrower strip as far as the S. end of Lake Baikal, then it broadens out so as to include the whole of the Amur basin, the total summer precipitation there being about 12 in. North of this zone the rainfall decreases towards the Arctic.

Flora.—The flora of Siberia presents very great local varieties, not only on account of the diversity of physical characteristics, but also in consequence of the intrusion of new species from the neighbouring regions, as widely different as the arctic littoral, the arid steppes of Central Asia, and the wet monsoon regions of the Pacific littoral. Siberia is situated for the most part in what Grisebach describes as the "forest region of the Eastern continent."¹ The northern limit of this region, must, however, be drawn nearer to the Arctic Ocean. A strip 60 to 200 m. wide is totally devoid of tree vegetation. The last trees which struggle for existence on the verge of the tundras are crippled dwarfs and almost without branches, and trees a hundred years old are only a few feet high and a few inches thick and thickly encrusted with lichens.² The following species, none of which are found in European Russia, are characteristic of the tundras—*Arbutus* (*Arctostaphylos alpina*), heaths or andromedas (*Cassiope tetragona* and *C. hypnoides*), *Phyllocladus taxifolia*, *Loiseleuria procumbens*, a species of *Latifolium*, a Polar azalea (*Osmothamnus fragrans*) and a Polar willow (*Salix arctica*). In Yakutsk the tundra vegetation consists principally of mosses of the genera *Polytrichum*, *Bryum* and *Hypnum*. Some two hundred species of flowering plants struggle for a precarious existence in the tundra region, the frozen ground and the want of humus militating against them more than the want of warmth.³ From this northern limit to the Aral-Caspian and Mongolian steppes stretches all over Siberia the forest region; the forests are, however, very unequally distributed, covering from 50 to 99% of the area in different districts. In the hill tracts and the marshy depression of the Ob they are unbroken, except by the bald summits of the loftier mountains (*goltsy*); they have the aspect of agreeable bosquets in the Baraba steppe, and they are thinly scattered through south-eastern Transbaikalia, where the dryness of the Gobi steppe makes its influence appreciably felt. Immense marshy plains covered with the dwarf birch take their place in the north as the tundras are approached. Over this immense area the trees are for the most part the same as we are familiar with in Europe. The larch becomes predominant chiefly in two new species (*Larix sibirica* and *L. dahurica*). The fir appears in the Siberian varieties *Picea obovata* and *P. ajanensis*. The silver fir (*Abies sibirica*, *Pinus pectinata*) and the stone-pine (*P. Cembra*) are quite common; they reach the higher summits, where the last-named is represented by a recumbent species (*Cembra pumila*). The birch in the loftier alpine tracts and plateaus becomes a shrub (*Betula nana*, *B. fruticosa*), and in Transbaikalia assumes a new and very elegant aspect with a dark bark (*B. daurica*). In the deeper valleys and on the lowlands of West Siberia the larches, pines and silver firs, intermingled with birches and aspens, attain a great size, and the streams are fringed with thickets of poplar and willow. The alpine rose (*Rhododendron dauricum*) clusters in masses on the higher mountains; juniper, spiraea, sorbus, the pseudo-acacia (*Caragana sibirica* and *C. arborescens*, *C. jubata* in some of the higher tracts), various Rosaceae—*Potentilla fruticosa* and *Cotoneaster uniflora*—the wild cherry (*Prunus Padus*), and many other shrubs occupy the spaces between the trees. Berry-yielding plants are found everywhere, even on the *goltsy*, at the upper limit of tree vegetation; on the lower grounds they are an article of diet. The red whortleberry or cowberry (*Vaccinium Vitis idaea*), the bog whortleberry (*V. uliginosum*), the bilberry (*V. myrtillus*) and the arctic bramble (*Rubus arcticus*) extend very far northward; raspberries and red and black currants form a luxuriant undergrowth in the forests, together with *Ribes dikusha* in East Siberia. The oak, elm, hazel, ash, apple, lime and maple disappear to the east of the Urals, but reappear in new varieties on the eastern slope of the border-ridge of the great plateau.⁴ There we encounter the oak (*Q. mongolica*), maple (*Acer ginala*, Max.), ash (*Fraxinus manchurica*), elm (*Ulmus montana*), hazel (*Corylus heterophylla*) and several other European acquaintances. Farther east, in the Amur region, a great number of new species of European

¹ According to A. Engler's *Versuch einer Entwicklungsgeschichte der Pflanzenwelt* (Leipzig, 1879-1882), we should have in Siberia (a) the arctic region; (b) the sub-arctic or coniferous region—north Siberian province; (c) the Central-Asian domain—Altai and Daurian mountainous regions; and (d) the east Chinese, intruding into the basin of the Amur.

² See Middendorff's observations on vegetable and animal life in the tundras, attractively told in vol. iv. of his *Sibirische Reise*.

³ Kjellmann, *Vega Expeditionens Vetenskapliga Iakttagelser* (Stockholm, 1872-1887) reckons their number at 182; 124 species were found by Middendorff on the Taymyr peninsula, 219 along the borders of the forest region of Olenek, and 344 species within the forest region of the same; 470 species were collected by Maack in the Vilui region.

⁴ Nowhere, perhaps, is the change better seen than on crossing the Great Khingan.

trees, and even new genera, such as the cork-tree (*Phellodendron amurense*, walnut (*Juglans manchurica*), acacia (*Maackia amurensis*), the graceful climber *Maximowiczia amurensis*, the Japanese *Trochostigma* and many others—all unknown to Siberia proper—are met with.

On the high plateau the larch predominates over all other species of conifers or deciduous trees; the wide, open valleys are thickly planted with *Betula nana* and *B. fruticosa* in the north and with thick grasses (poor in species) in the southern and drier parts. The Siberian larch predominates also in the alpine tracts fringing the plateau on the north, intermingled with the fir, stone-pine, aspen and birch. In the drier parts the Scotch fir (*Pinus sylvestris*) makes its appearance. In the alpine tracts of the north the narrowness of the valleys and the steep stony slopes strewn with débris, on which only lichens and mosses are able to grow, make every plot of green grass (even if it be only of *Carex*) valuable. For days consecutively the horse of the explorer can get no other food than the dwarf birch. But even in these districts the botanist and the geographer can easily distinguish between the *chern* or thick forest of the Altai and the *taiga* of East Siberia. The lower plateau exhibits, of course, new characteristics. Its open spaces are lovely prairies, on which the Daurian flora flourishes in full beauty. In spring the traveller crosses a sea of grass above which the flowers of the paeony, aconite, *Orobis*, *Carallia*, *Saussurea* and the like wave 4 or 5 ft. high. As the Gobi desert is approached the forests disappear, the ground becomes covered chiefly with dry Gramineae, and Salsolaceae make their appearance. The high plains of the west slope of the plateau are also rich prairies diversified with woods. Nearly all the species of plants which grow on these prairies are common to Europe (paeonies, *Hemerocallis*, asters, pinks, gentians, violets, *Cypripedium*, *Aquilegia*, *Delphinium*, aconites, irises and so on); but here the plants attain a much greater size; a man standing erect is often hidden by the grasses. The flora of Minusinsk—the Italy of Siberia—is well known; the prairies on the Ishim and of the Baraba steppe are adorned with the same rich vegetation, so graphically described by Middendorff and O. Finsch. Farther north we come to the *urmans* of West Siberia, dense thickets of trees often rising from a treacherous carpet of thickly interlaced grasses, which conceals deep marshes, where even the bear has learnt to tread circumspectly.

Fauna.—The fauna of Siberia is closely akin to that of central Europe; and the Ural Mountains, although the habitat of a few species which warrant the naturalist in regarding the southern Urals as a separate region, are not so important a boundary zoologically as they are botanically. As in European Russia, so in Siberia, three principal zones—the arctic, the boreal and the middle—may be distinguished, and these may be subdivided into several sub-regions. The Amur region shares the characteristics of the north Chinese fauna. On the whole, we may say that the arctic and boreal faunas of Europe extend over Siberia, with a few additional species in the Ural and Baraba region—a number of new species also appearing in East Siberia, some spreading along the high plateau and others along the lower plateau from the steppes of the Gobi. The arctic fauna is very poor. According to Nordenskjöld¹ it numbers only twenty-nine species of mammals, of which seven are marine and seventeen or eighteen may be safely considered as living beyond the forest limit. Of these, again, four are characteristic of the land of the Chukchis. The reindeer, arctic fox (*Canis lagopus*), hare, wolf, lemming (*Myodes obensis*), collar lemming (*Cuniculus torquatus*) and two species of voles (*Arvicolae*) are the most common on land. The avifauna is very rich in migratory water and marsh fowl (*Grallatores* and *Natatores*), which come to breed in the coast region; but only five land birds—the ptarmigan (*Lagopus alpinus*), snow-bunting, Iceland falcon, snow-owl and raven—are permanent inhabitants of the region. The boreal fauna is, of course, much more abundant; but here also the great bulk of the species, both mammals and birds, are common to Europe and Asia. The bear, badger, wolverine, polecat, ermine, common weasel, otter, wolf, fox, lynx, mole, hedgehog, common shrew, water-shrew and lesser shrew (*Sorex vulgaris*, *S. fodiens* and *S. pygmaeus*), two bats (the long-eared and the boreal), three species of *Vespertilio* (*V. daubentoni*, *V. nattereri* and *V. mystacinus*), the flying and the common squirrel (*Tamias striatus*), the brown, common, field and harvest mouse (*Mus decumanus*, *M. musculus*, *M. sylvaticus*, *M. agrarius* and *M. minutus*), four voles (*Arvicola amphibius*, *A. rufocanus*, *A. rutilus* and *A. schistocolor*), the beaver, variable hare, wild boar, roebuck, stag, reindeer, elk and *Phoca annelata* of Lake Baikal—all these are common alike to Europe and to Siberia; while the bear, musk-deer (*Moschus moschiferus*), ermine, sable, pouched marmot or souslik (*Spermophilus eversmani*), *Arvicola obscurus* and *Lagomys hyperboreus*, distributed over Siberia, may be considered as belonging to the arctic fauna. In addition to the above we find in East Siberia *Mustela alpina*, *Canis alpinus*, the sable antelope (*Aegocerus sibiricus*), several species of mouse (*Mus gregatus*, *M. oeconomicus* and *M. saxatilis*), two voles (*Arvicola russatus* and *A. macrotus*), *Syphneus aspalax* and the alpine *Lagomys* from the Central Asian plateaus; while the tiger makes incursions not only into the Amur region but occasionally as far as Lake Baikal. On the lower terrace of the great plateau we find an

admixture of Mongolian species, such as *Canis corsac*, *Felis manul*, *Spermophilus dauricus*, the jerboa (*Dipus jaculus*), two hamsters (*Cricetus songarus* and *C. furunculus*), three new voles (*Arvicolae*), the Tolai hare, Ogotona hare (*Lagomys ogotona*), *Aegocerus argali*, *Antelope gutturosa* and *Equus hemionus (jigitai)*. Of birds no less than 285 species have been observed in Siberia, but of these forty-five only are absent from Europe. In south-east Siberia there are forty-three new species belonging to the north Manchurian or Amur fauna; and in south-east Transbaikalia, on the borders of the Gobi steppe, only 103 species were found by G. F. R. Radde, among which the most numerous are migratory birds and the birds of prey which pursue them. The rivers and lakes of Siberia abound in fish; but little is known of their relations with the species of neighbouring regions.²

The insect fauna is very similar to that of Russia; but a few genera, as the *Tentyria*, do not penetrate into the steppe region of West Siberia, while the tropical *Colasposoma*, *Popilia* and *Languria* are found only in south-eastern Transbaikalia, or are confined to the southern Amur. On the other hand, several American genera (*Cephalon*, *Ophryastes*) extend into the north-eastern parts of Siberia.³ As in all uncultivated countries, the forests and prairies of Siberia become almost uninhabitable in summer because of the mosquitoes. East Siberia suffers less from this plague than the marshy Baraba steppe; but on the Amur and the Sungari large gnats are an intolerable plague. The dredgings of the "Vega" expedition in the Arctic Ocean disclosed an unexpected wealth of marine fauna, and those of L. Schrenck in the north of the Japanese Sea led to the discovery of no fewer than 256 species (Gasteropods, Brachiopods and Conchifers). Even in Lake Baikal Dybowski and Godlewski discovered no fewer than ninety-three species of Gammarides and twenty-five of Gasteropods.⁴ The Sea of Okhotsk is very interesting, owing to its local species and the general composition of its fauna (70 species of Molluscs and 21 of Gasteropods). The land Molluscs, notwithstanding the unfavourable conditions of climate, number about seventy species—Siberia in this respect being not far behind north Europe. The increase of many animals in size (becoming twice as large as in Europe); the appearance of white varieties among both mammals and birds, and their great prevalence among domesticated animals (Yakut horses); the migrations of birds and mammals over immense regions, from the Central Asian steppes to the arctic coast, not only in the usual rotation of the seasons but also as a result of occasional climacteric conditions are not yet fully understood (e.g. the migration of thousands and thousands of roebuck from Manchuria across the Amur to the left bank of the river, or the migration of reindeer related by Baron F. von Wrangel); the various coloration of many animals according to the composition of the forests they inhabit (the sable and the squirrel are well-known instances); the intermingling northern and southern faunas in the Amur region and the remarkable consequences of that intermixture in the struggle for existence;—all these render the study of the Siberian fauna most interesting. Finally, the laws of distribution of animals over Siberia cannot be made out until the changes undergone by its surface during the Glacial and Lacustrine periods are well established and the Post-Tertiary fauna is better known. The remarkable finds of Quaternary mammals about Omsk and their importance for the history of the *Equidae* are merely a slight indication of what may be expected in this field.

Population.—In 1906 the estimated population was 6,740,600. In 1897 the distribution was as follows. Geographically, though not administratively, the steppe provinces of Akmolinsk and Semipalatinsk belong to Siberia. They are described under STEPPES.

Governments and Provinces.	Area in sq. m.	Population in 1897.	Density per sq. m.	
Tobolsk	535,739	1,444,470	2.7	
Tomsk	327,173	1,947,021	5.1	
Irkutsk (general-government)	Yeniseisk	981,607	572,847	0.6
	Irkutsk	280,429	515,132	1.8
Far East (vicerealty)	Yakutsk	1,530,253	271,830	0.2
	Transbaikalia	229,520	676,407	3.0
	Amur	172,826	119,909	0.6
	Maritime (Sakhalin)	712,585	209,516	0.7
	14,700	27,250	1.9	
	4,784,832	5,784,382	Av. 1.2	

² Czekanowski (*Izvestia Sib. Geog. Soc.*, 1877) has described fifty species from the basin of the Amur; he considers that these constitute only two-thirds of the species inhabiting that basin.

³ See L. Schrenck, *Reisen und Forschungen im Amurlande* (1858–1891).

⁴ See *Mém. de l'académie des sciences de St-Petersbourg*, vol. xxii. (1876).

¹ In *Vega Exped. Vetensk. Iakttagelser.*, vol. ii.

Of the total in 1897, 81.4% were Russians, 8.3% Turko-Tatars, 5% Mongols and 0.6% "indigenous" races, *i.e.* Chukchis, Koryaks, Ghilyaks, Kamchadales and others. Only 8% of the total are classed as urban. The great bulk of the population are Russians, whose number increased with great rapidity during the 19th century; although not exceeding 150,000 in 1709 and 500,000 a century later, they numbered nearly 6,500,000 in 1904. Between 1870 and 1890 over half a million free immigrants entered Siberia from Russia, and of these 80% settled in the government of Tobolsk; and between 1890 and 1905 it is estimated that something like a million and a half free immigrants entered the country. These people came for the most part from the northern parts of the black earth zone of middle Russia, and to a smaller extent from the Lithuanian governments and the Ural governments of Perm and Vyatka. The Russians, issuing from the middle Urals, have travelled as a broad stream through south Siberia, sending branches to the Altai, to the Ili river in Turkestan and to Minusinsk, as well as down the chief rivers which flow to the Arctic Ocean, the banks of which are studded with villages 15 to 20 m. apart. As Lake Baikal is approached the stream of Russian immigration becomes narrower, being confined mostly to the valley of the Angara, with a string of villages up the Irkut; but it widens out again in Transbaikalia, and sends branches up the Selenga and its tributaries. It follows the course of the Amur, again in a succession of villages some 20 m. apart, and can be traced up the Usuri to Lake Khangka and Vladivostok, with a string of villages on the plains between the Zeya and the Silinji. Small Russian settlements are planted on a few bays of the North Pacific and the Sea of Okhotsk, as well as on Sakhalin.

Colonization.—Siberia has been colonized in two different ways. On the one hand, the government sent parties (1) of Cossacks to settle on the frontiers, (2) of peasants who were bound to settle at appointed places and maintain communication along the routes, (3) of *stryeltsy* (*i.e.* Moscow imperial guards) to garrison forts, (4) of *yamshiks*—a special organization of Old Russia entrusted with the maintenance of horses for postal communication, and finally (5) of convicts. A good deal of the Amur region was peopled in this way. Serfs in the imperial mines were liberated and organized in Cossack regiments (the Transbaikal Cossacks); some of these were settled on the Amur, forming the Amur and Usuri Cossacks. Other parts of the river were colonized by peasants who emigrated with government aid, and were bound to settle in villages, along the Amur, at spots designated by officials. As a rule, this kind of colonization has not produced the results that were expected. On the other hand, free colonization has been more successful and has been undertaken on a much larger scale. Soon after the first appearance (1580) of the Cossacks of Yermak in Siberia thousands of hunters, attracted by the furs, immigrated from north Russia, explored the country, traced the first footpaths and erected the first houses in the wilderness. Later on serfdom, religious persecutions and conscription were the chief causes which led the peasants to make their escape to Siberia and build their villages in the most inaccessible forests, on the prairies and even on Chinese territory. But the severe measures adopted by the government against such "runaways" were powerless to prevent their immigration into Siberia. While governmental colonization studded Siberia with forts, free colonization filled up the intermediate spaces. Since the emancipation of the serfs in 1861, it has been steadily increasing, the Russian peasants of a village often emigrating *en bloc*.¹

Siberia was for many years a penal colony. Exile to Siberia began in the first years of its discovery, and as early as 1658 we read of the Nonconformist priest Avvakum² following in chains the exploring party of Pashkov on the Amur. Raskolniks or Nonconformists in the second half of the 17th century, rebel *stryeltsy* under Peter the Great, courtiers of rank during the reigns of the empresses, Polish confederates under Catherine II., the "Decembrists" under Nicholas I., nearly 50,000 Poles after the insurrection of 1863, and later on whole generations of socialists were sent to Siberia; while the number of common-law convicts and exiles transported thither increased steadily from the end of the 18th century. No exact statistics of Siberian exile were kept before 1823. But it is known that in the first years of the 19th century nearly 2000 persons were transported every year to Siberia. This figure reached an average of 18,250 in 1873–1877, and from about 1880 until the discontinuance of the system in 1900 an average of 20,000 persons were annually exiled to Siberia. After liberation the hard-labour convicts are settled in villages; but nearly all are in a wretched condition, and more than one-third have disappeared without being accounted for. Nearly 20,000 men (40,000 according to other estimates) are living in Siberia the life of *brodyagi* (runaways or outlaws), trying to make their way through the forests to their native provinces in Russia.

Asiatic Races.—The Ural-Altaians consist principally of Turko-Tatars, Mongols, Tunguses, Finnish tribes and Samoyedes. The Samoyedes, who are confined to the province of Tobolsk, Tomsk

and Yeniseisk, do not exceed 12,000 in all. The Finns consist principally of Mordvinians (18,500), Ostiaks (20,000) and Voguls (5000). Survivals of Turkish blood, once much more numerous, are scattered all over south Siberia as far as Lake Baikal. Their territories are being rapidly occupied by Russians, and their settlements are cut in two by the Russian stream—the Baraba Tatars and the Yakuts being to the north of it, and the others having been driven back to the hilly tracts of the Altai and Sayan Mountains. In all they number nearly a quarter of a million. The Turkish stock of the Yakuts in the basin of the Lena numbers 227,400. Most of these Turkish tribes live by pastoral pursuits and some by agriculture, and are a most laborious and honest population.

The Mongols (less than 300,000) extend into West Siberia from the high plateau—nearly 20,000 Kalmucks living in the eastern Altai. In East Siberia the Buriats occupy the Selenga and the Uda, parts of Nerchinsk, and the steppes between Irkutsk and the upper Lena, as also the Baikal Mountains and the island of Orkhon; they support themselves chiefly by live-stock breeding, but some, especially in Irkutsk, are agriculturists. On the left of the Amur there are some 60,000 Chinese and Manchurians about the mouth of the Zeya, and 26,000 Koreans on the Pacific coast. The Tunguses (nearly 70,000) occupy as their hunting-grounds an immense region on the high plateau and its slopes to the Amur, but their limits are yearly becoming more and more circumscribed both by Russian gold-diggers and by Yakut settlers. In the Maritime Province, before the Boxer uprising of 1900, 26% of the population in the N. Usuri district and 36% in the S. Usuri district were Koreans and Chinese, and in the Amur province there were nearly 15,000 Manchus and Koreans. Jews number 32,650 and some 5000 gipsies wander about Siberia.

At first the indigenous populations were pitilessly deprived of their hunting and grazing grounds and compelled to resort to agriculture—a modification exceedingly hard for them, not only on account of their poverty but also because they were compelled to settle in the less favourable regions. European civilization made them familiar with all its worst sides and with none of its best. Taxed with a tribute in furs from the earliest years of the Russian conquest, they often revolted in the 17th century, but were cruelly reduced to obedience. In 1824 the settled indigenes had to pay the very heavy rate of 11 roubles (about £1) per head, and the arrears, which soon became equal to the sums levied, were rigorously exacted. On the other hand the severe measures taken by the government prevented the growth of anything like legalized slavery on Siberian soil; but the people, ruined as they were both by the intrusion of agricultural colonists and by the exactions of government officials, fell into what was practically a kind of slavery to the merchants. Even the best-intentioned government measures, such as the importation of corn, the prohibition of the sale of spirits, and so on, became new sources of oppression. The action of missionaries, who cared only about nominal Christianizing, had no better effect.

Social Features.—In West Siberia there exist compact masses of Russians who have lost little of their primitive ethnographical features: but the case is otherwise on the outskirts. M. A. Castrén characterized Obdorsk (mouth of the Ob) as a true Samoyedic town, although peopled with "Russians." The Cossacks of West Siberia have the features and customs and many of the manners of life of the Kalmucks and Kirghiz. Yakutsk is thoroughly Yakutic; marriages of Russians with Yakut wives are common, and in the middle of the 19th century the Yakut language was predominant among the Russian merchants and officials. At Irkutsk and in the valley of the Irkut the admixture of Tungus and Buriat blood is obvious, and still more in the Nerchinsk district and among the Transbaikal Cossacks settled on the Arguñ. They speak the Buriat language as often as Russian, and in a Buriat dress can hardly be distinguished from the Buriats. In different parts of Siberia, on the borders of the hilly tracts, intermarriage of Russians with Tatars was quite common. Of course it is now rapidly growing less, and the settlers who entered Siberia in the 19th century married Russian wives and remained thoroughly Russian. There are accordingly parts of Siberia, especially among the Raskolniks or Nonconformists, where the north Russian, the Great Russian and the Ukrainian (or southern) types have maintained themselves in their full purity, and only some differences in domestic architecture, in the disposition of their villages and in the language and character of the population remind the traveller that he is in Siberia. The special features of the language and partly also of the national character are due to the earliest settlers, who came mostly from northern Russia.

The natural rate of increase of population is very slow as a rule, and does not exceed 7 or 8 per 1000 annually. The great mortality, especially among the children, is one of the causes of this, the birth-rate being also lower than in Russia. The climate of Siberia, however, cannot be called unhealthy, except in certain localities where goitre is common, as it is on the Lena, in several valleys of Nerchinsk and in the Altai Mountains. The rapid growth of the actual population is chiefly due to immigration.

Towns.—Only 8.1% of the population live in towns (6.4% only in the governments of Tobolsk and Tomsk). There are seventeen towns with a population of 10,000 or more, namely, Tomsk (63,533

¹ See Yadrintsev, *Siberia as a Colony* (in Russian, 2nd ed., St Petersburg, 1892).

² The autobiography of the protopope Avvakum is one of the most popular books with Russian Nonconformists.

in 1900) and Irkutsk (49,106)—the capitals of West and East Siberia respectively; Blagovyeschensk (37,368), Vladivostok (38,000), Tyumen (29,651) in West Siberia, head of Siberian navigation; Barnaul (29,850), capital of the Altai region; Krasnoyarsk (33,337) and Tobolsk (21,401), both mere administrative centres; Biysk (17,206), centre of the Altai trade; Khabarovsk (15,082), administrative centre of the Amur region; Chita (11,480), the capital of Transbaikalia; Nikolsk (22,000); Irbit (20,064); Kolyvañ (11,703), the centre of the trade of southern Tomsk; Yeniseisk (11,539), the centre of the gold-mining region of the same name; Kurgan (10,579), a growing town in Tobolsk; and Minusinsk (10,255), in the southern part of the Yeniseisk province, trading with north-west Mongolia.

Education.—Education stands at a very low level. The chief town of every province is provided with a classical gymnasium for boys and a gymnasium or progymnasium for girls; but the education there received is not of a high grade, and the desire of the local population for "real schools" is not satisfied. Primary education is in a very unsatisfactory state, and primary schools very scarce. The petitions for a university at Irkutsk, the money required for which has been freely offered to the government, have been refused, and the imperative demands of the local tradesmen for technical instruction have likewise met with little response. The Tomsk University remains incomplete, and has only 560 students. There are nevertheless eighteen scientific societies in Siberia, which issue publications of great value. Twelve natural history and ethnological museums have been established by the exiles—the Minusinsk museum being the best. There are also twenty public libraries.

Agriculture.—Agriculture is the chief occupation both of the settled Russians and of the native population. South Siberia has a very fertile soil and yields heavy crops, but immense tracts of the country are utterly unfit for tillage. Altogether it is estimated that not more than 500,000 sq. m. are suitable for cultivation. The aggregate is thus distributed—192,000 sq. m. in West Siberia, 20,000 in Akmolinsk and Semipalatinsk, 100,000 in East Siberia, 85,000 in Transbaikalia, 40,000 in Amur, and 63,000 in Usuri. In the lowlands of West Siberia cultivation is carried on up to 61° N.¹ On the high plains fringing the alpine tracts on the north-west it can be carried on only in the south, farther north only in the valleys, reaching 62° N. in that of the Lena, and in the alpine tracts in only a few valleys, as that of the Irkut. On the high plateau all attempts to grow cereals have failed, the wide trenches alone (Uda, Selenga, Jida) offering encouragement to the agriculturist. On the lower plateau, in Transbaikalia, grain is successfully raised in the Nerchinsk region, with serious risks, however, from early frosts in the valleys. South-east Transbaikalia suffers from want of water, and the Buriats have to irrigate their fields. Although agriculture is carried on in the upper Amur, where land has been cleared from virgin forests, it really prospers only below Kumara and on the fertile plains of the Zeya and Silinji. In the depression between the Bureya range and the coast ranges it suffers greatly from the heavy July and August rains, and from inundations, while on the lower Amur the agriculturists barely maintain themselves by growing cereals in clearances on the slopes of the hills, so that the settlements on the lower Amur and Usuri continually require help from government to save them from famine. The chief grain-producing regions of Siberia are—the Tobol and Ishim region, the Baraba, the region about Tomsk and the outskirts of the Altai. The Minusinsk district, one of the richest in Siberia (45,000 inhabitants, of whom 24,000 are nomadic), has more than 45,000 acres under crops. Mining, the second industry in point of importance, is dealt with above.

Land Tenure.—Out of the total area of over 3,000,000,000 acres of land in Siberia, close upon 96% belong to the state, while the cabinet of the reigning emperor owns 114,700,000 acres (112,300,000 in the Altai and 2,400,000 in Nerchinsk) or nearly 4%. Private property is insignificant in extent—purchase of land being permitted only in the Amur region. (In West Siberia it was only temporarily permitted in 1860–1868.) Siberia thus offers an example of the nationalization of land unparalleled throughout the world. Any purchase of land within a zone 67 m. wide on each side of the trans-Siberian railway was absolutely prohibited in 1895, and the extent of crown lands sold to a single person or group of persons never exceeds 1080 acres unless an especially useful industrial enterprise is projected, and in that case the maximum is fixed at 2700 acres. The land is held by the Russian village communities in virtue of the right of occupation. Industrial surveys, having for their object the granting of land to the peasants to the extent of 40 acres per each male head, with 8 additional acres of wood and 8 acres as a reserve, were started many years ago, and after being stopped in 1887 were commenced again in 1898. At the present time the land allotments per male head vary greatly, even in the relatively populous region of southern Siberia. In the case of the peasants the allotments vary on an average from 32 to 102 acres (in some cases from 21.6 to 240 acres); the Transbaikalian Cossacks have about 111 acres per male head, and the indigenous population 108 to 154 acres.

¹ The northern limits of agriculture are 60° N. on the Urals, 62° at Yakutsk, 61° at Aldansk, 54° 30' at Udskoi, and 53° to 54° in the interior of Kamchatka (Middendorff, *Sibirische Reise*, vol. iv.).

The total cultivated area and the average area under crops every year have been estimated by A. Kaufmann as follows²:—

Province or Government.	Area cultivated, Acres.	Under Crops (Acres).		
		Total.	Average per Household.	Average per 100 Inhabitants.
Tobolsk . . .	5,670,000	3,270,000	13.2	243
Tomsk . . .	8,647,000	5,259,000	15.7	310
Yeniseisk . . .	1,830,000	977,000	13.0	267
Irkutsk . . .	1,800,000	910,000	13.2	265
Transbaikalia . . .	1,415,000	872,000	9.4	159
Yakutsk . . .	81,000	43,000	0.8	16
Amur (Russians)	143,000	143,000	19.4	275
South Usuri (peasants only)	151,000	151,000	24.0	375
	19,737,000	11,625,000

These figures are somewhat under-estimated, but the official figures are still lower, especially for Tomsk. Tillage is conducted on very primitive methods. After four to twelve years' cultivation the land is allowed to lie fallow for ten years or more. In the Baraba district it is the practice to sow four different grain crops in five to seven years and then to let the land rest ten to twenty-five years. The yield from the principal crops fluctuates greatly; indeed in a very good year it is almost three times that in a very bad one. The southern parts of Tobolsk, nearly all the government of Tomsk (exclusive of the Narym region), southern Yeniseisk and southern Irkutsk, have in an average year a surplus of grain varying from 35 to 40% of the total crop, but in bad years the crop falls short of the actual needs of the population. There is considerable movement of grain in Siberia itself, the populations of vast portions of the territory, especially of the mining regions, having to rely upon imported corn. The forest area under supervision is about 30,000,000 acres (in Tobolsk, Tomsk, Yeniseisk and Irkutsk), out of a total area of forest land of 63,000,000 acres.

As an independent pursuit, live-stock breeding is carried on by the Russians in eastern Transbaikalia, by the Yakuts in the province of Yakutsk, and by the Buriats in Irkutsk and Transbaikalia, but elsewhere it is secondary to agriculture. Both cattle-breeding and sheep-grazing are more profitable than dairying; but the Kirghiz herds are not well tended, being left to graze on the steppes all the year, where they perish from wild animals and the cold. The live stock includes some 180,000 camels.

Bee-keeping is widely carried on, especially in Tomsk and the Altai. Honey is exported to Russia. The seeds of the stone-pine are collected for oil in West Siberia.

Hunting.—Hunting is a profitable occupation, the male population of whole villages in the hilly and woody tracts setting out in October for a month's hunting. The sable, however, which formerly constituted the wealth of Siberia, is now exceedingly scarce. Squirrels, bears, foxes, arctic foxes, antelopes and especially deer in spring are the principal objects of the chase. The forests on the Amur yielded a rich return of furs during the first years of the Russian occupation, and the Amur sable, although much inferior to the Yakutsk and Transbaikalian, was largely exported.

Fishing.—Fishing is a valuable source of income on the lower courses of the great rivers, especially the Ob. The fisheries on Lake Baikal supply cheap food (the *omul*) to the poorer classes of Irkutsk and Transbaikalia. The native populations of the Amur—Golds and Gilyaks—support themselves chiefly by fishing, when the salmon enters the Amur and its tributaries in dense masses. Fish (e.g. the *keta*, salmon and sturgeon) are a staple article of diet in the north.

Manufactures.—Though Siberia has within itself all the raw produce necessary for prosperous industries, it continues to import from Russia all the manufactured articles it uses. Owing to the distances over which they are carried and the bad organization of trade, all manufactured articles are exceedingly dear, especially in the east. The manufactories of Siberia employ less than 25,000 workmen, and of these some 46% are employed in West Siberia. Nearly one-third of the total value of the output represents wine-spirit, 23% tanneries, 18% tallow-melting and a considerable sum cigarette-making.

It is estimated that about one-half of the Russian agricultural population supplement their income by engaging in non-agricultural pursuits, but not more than 18 to 22% carry on domestic trades, the others finding occupation in the carrying trade—which is still important, even since the construction of the railway—in hunting (chiefly squirrel-hunting) and in work in the mines. Domestic and petty trades are therefore developed only round Tyumen, Tomsk and Irkutsk. The principal of these trades are the weaving of carpets—about Tyumen; the making of wire sieves; the painting of ikons or sacred images; the making of wooden vessels and of the necessaries for the carrying trade about Tomsk (sledges, wheels, &c.);

² *Russian Encyclopaedic Dictionary*, vol. lix. (1900).

the preparation of felt boots and sheepskins; and the manufacture of dairy utensils and machinery. Weaving is engaged in for domestic purposes. But all these trades are sporadic, and are confined to limited areas, and often only to a few separate villages.

Commerce.—There are no figures from which even an approximate idea can be gained as to the value of the internal trade of Siberia, but it is certainly considerable. The great fair at Irbit retains its importance, and there are, besides, over 500 fairs in Tobolsk and over 100 in other parts of the region. The aggregate returns of all these are estimated at £2,643,000 annually. The trade with the natives continues to be mainly the sale of spirits.

In the external trade the exports to Russia consist chiefly of grain, cattle, sheep, butter and other animal products, furs, game, feathers and down. The production of butter for export began only in 1894, but grew with great rapidity. In 1902 some 1800 dairies were at work, the greater number in West Siberia, and 40,000 tons of butter were exported. The total trade between Russia and China amounts to about £5,500,000 annually, of which 87% stands for imports into Russia and 13% for exports to China. Tea makes up nearly one-half of the imports, the other commodities being silks, cottons, hides and wool; while cottons and other manufactured wares constitute considerably over 50% of the exports. Part of this commerce (textiles, sugar, tobacco, steel goods) is conveyed by sea to the Pacific ports. The principal centre for the remainder (textiles and petroleum), conveyed by land, is Kiakhta on the Mongolian frontier. Prior to the building of the trans-Siberian railway a fairly active trade was carried on between China and the Amur region; but since the opening of that railway (in 1902-1905) the Amur region has seriously and rapidly declined in all that concerns trade, industry, general prosperity and civilization. There is further an import trade amounting to between two and three-quarters and three millions sterling annually with Manchuria, to over one million sterling with the United States, and to a quarter to half a million sterling with Japan. As nearly as can be estimated, the total imports into Siberia amount approximately to £5,000,000, the amount having practically doubled between 1890 and 1902; the total exports average about £9,000,000. In the Far East the chief trade centres are Vladivostok and Nikolayevsk on the Amur, with Khabarovsk and Blagovyeshchensk, both on the same river. For some years a small trade was carried on by the British Captain Wiggins with the mouth of the river Yenisei through the Kara Sea, and after his death in 1905 the Russians themselves endeavoured to carry farther the pioneer work which he had begun.

Communications.—Navigation on the Siberian rivers has developed both as regards the number of steamers plying and the number of branch rivers traversed. In 1900, one hundred and thirty private and several crown steamers plied on the Ob-Irtysh river system as far as Sempalatinsk on the Irtysh, Biysk on the Ob, and Achinsk on the Chulym. The Ob-Yenisei canal is ready for use, but its actual usefulness is impaired by the scarcity of water in the smaller streams forming part of the system. On the Yenisei steamers ply from Minusinsk to Yeniseisk, and to Ghilghila at its mouth; on its tributary, the Angara, of which some rapids have been cleared, though the Padun rapids have still to be rounded by land; and on the Selenga. On the Lena and the Vitim there are steamers, and a small railway connects the Bodoibo river port with the Olekma gold-washings. In the Amur system, the Zeya, the Bureya and the Argun are navigated.

The main line of communication is the great Moscow road. It starts from Perm on the Kama, and, crossing the Urals, reaches Ekaterinburg—the centre of mining industry—and Tyumen on the Tura, whence steamers ply via Tobolsk to Tomsk. From Tyumen the road proceeds to Omsk, Tomsk, Krasnoyarsk and Irkutsk, sending off from Kolyva a branch south to Barnaul in the Altai and to Turkestan. From Irkutsk it proceeds to Transbaikalia, Lake Baikal being crossed either by steamer or (when frozen) on sledges, in either case from Listvinichnoe to Misovaya. A route was laid out about 1868 round the south shore of Lake Baikal in order to maintain communication with Transbaikalia during the spring and autumn, and in 1905 the great Siberian railway was completed round the same extremity of the lake. From Lake Baikal the road proceeds to Verkhne-udinsk, Chita and Stryetensk on the Shilka, whence steamers ply to the mouth of the Amur and up the Usuri and Sungacha to Lake Khangka. When the rivers are frozen communication is maintained by sledges on the Amur; but in spring and autumn the only continuous route down the Shilka and the Amur, to its mouth, is on horseback along a mountain path (very difficult across the Bureya range). On the lower Amur and on the Usuri the journey is also difficult even on horseback. When the water in the upper Amur is low, vessels are sometimes unable to reach the Shilka. Another route of importance before the conquest of the Amur is that which connects Yakutsk with Okhotsk or Ayan. Regular postal communication is maintained by the Russians between Kiakhta and Kalgan (close by Peking) across the desert of Gobi.

The first railway to reach Siberia was built in 1878, when a line was constructed between Perm, at which point travellers for Siberia used to strike off from the Kama eastwards, and Ekaterinburg, on the eastern slope of the Urals. In 1884 this line was continued as far as Tyumen, the head of navigation on the

Siberian rivers. It was supposed at that time that this line would form part of the projected trans-Siberian railway; but it was finally decided, in 1885, to give a more southerly direction to the railway and to continue the Moscow-Samara line to Ufa, Zlatoust in the Urals, and Chelyabinsk on the west Siberian prairies, at the head of one of the tributaries of the Ob. Thence the line was continued across the prairies to Kurgan and Omsk, and from there it followed the great Siberian highway to Krasnoyarsk and Irkutsk, and on round Lake Baikal to Chita and Stryetensk on the Shilka. From that place it was intended to push it down the Amur to Khabarovsk, and finally to proceed up the Usuri to Vladivostok. The building of the railway was begun at several points at once in 1892; it had, indeed, been started a year before that in the Usuri section. For reasons indicated elsewhere (see RUSSIA: Railways) it was found inadvisable to continue the railroad along the Shilka and the Amur to Khabarovsk, and arrangements were made in 1896 with the Chinese government for the construction of a trans-Manchurian railway. This line connects Kaidalovo, 20 m. below Chita, with Vladivostok, and sends off a branch from Kharbin, on the Sungari, to Dalny and Port Arthur. Those parts of it which run through Russian territory (in Transbaikalia 230 m.; in the neighbourhood of Vladivostok 67 m.) were opened in 1902, and also the trans-Manchurian line (1000 m.), although not quite completed. A line was constructed from Vladivostok to the Amur before it became known that the idea of following the latter part of the route originally laid down would have to be abandoned. This line, which has been in working order since 1898, is 479 m. long, and proceeds first to Grafskaya, across the fertile and populous south Usuri region, then down the Usuri to Khabarovsk at the confluence of that river with the Amur.

Returning westwards, Chelyabinsk has been connected with Ekaterinburg (153 m.); and a branch line has been built from the main Siberian line to Tomsk (54 m.). Altogether the entire railway system, including the cost of the Usuri line, the unfinished Amur line, the circum-Baikal line and the eastern Chinese railway, is put down at a total of £87,555,760, and the total distance, all branches included, is 5413 m., of which 1070 m. are in Chinese territory.

History.—The shores of all the lakes which filled the depressions during the Lacustrine period abound in remains dating from the Neolithic Stone period; and numberless *kurgans* (tumuli), furnaces and so on bear witness to a much denser population than the present. During the great migrations in Asia from east to west many populations were probably driven to the northern borders of the great plateau and thence compelled to descend into Siberia; succeeding waves of immigration forced them still farther towards the barren grounds of the north, where they melted away. According to Radlov, the earliest inhabitants of Siberia were the Yeniseians, who spoke a language different from the Ural-Altai; some few traces of them (Yeniseians, Sayan-Ostiaks, and Kottes) exist among the Sayan Mountains. The Yeniseians were followed by the Ugro-Samoyedes, who also came originally from the high plateau and were compelled, probably during the great migration of the Huns in the 3rd century B.C., to cross the Altai and Sayan ranges and to enter Siberia. To them must be assigned the very numerous remains dating from the Bronze period which are scattered all over southern Siberia. Iron was unknown to them; but they excelled in bronze, silver and gold work. Their bronze ornaments and implements, often polished, evince considerable artistic taste; and their irrigated fields covered wide areas in the fertile tracts. On the whole, their civilization stood much higher than that of their more recent successors. Eight centuries later the Turkish stocks of "Tukiu" (the Chinese spelling for "Turks"), Khagases and Ugurs—also compelled to migrate north-westwards from their former seats—subdued the Ugro-Samoyedes. These new invaders likewise left numerous traces of their sojourn, and two different periods may be easily distinguished in their remains. They were acquainted with iron, and learned from their subjects the art of bronze-casting, which they used for decorative purposes only, and to which they gave a still higher artistic stamp. Their pottery is much more perfect and more artistic than that of the Bronze period, and their ornaments are accounted among the finest of the collections at the St Petersburg museum of the Hermitage. This Turkish empire of the Khagases must have lasted until the 13th century, when the Mongols, under Jenghiz Khan, subdued them and destroyed their civilization. A decided decline is shown by the graves which have been discovered, until the country reached the low level at which it was found by the Russians on their arrival towards the close of the 16th century. In the beginning of the 16th century Tatar fugitives from Turkestan subdued the loosely associated tribes inhabiting the lowlands to the east of the Urals. Agriculturists, tanners, merchants and mollahs (priests) were called from Turkestan, and small principalities sprang up on the Irtysh and the Ob. These were united by Khan Ediger, and conflicts with the Russians who were then colonizing the Urals brought him into collision with Moscow; his envoys came to Moscow in 1555 and consented to a yearly tribute of a thousand sables. As early as the 11th century the Novgorodians had occasionally penetrated into Siberia; but the fall of the republic and the loss of its north-eastern dependencies checked the advance of the Russians across the Urals. On the defeat of the adventurer Stenka Razin (1667-1671) many who were unwilling to submit to the iron rule of Moscow made their way to the settlements of Stroganov in Perm,

and tradition has it that, in order to get rid of his guests, Stroganov suggested to their chief, Yermak, that he should cross the Urals into Siberia, promising to help him with supplies of food and arms. Yermak entered Siberia in 1580 with a band of 1636 men, following the Tagil and Tura rivers. Next year they were on the Tobol, and 500 men successfully laid siege to Isker, the residence of Khan Kuchum, in the neighbourhood of what is now Tobolsk. Kuchum fled to the steppes, abandoning his domains to Yermak, who, according to tradition, purchased by the present of Siberia to Ivan IV. his own restoration to favour. Yermak was drowned in the Irtysh in 1584 and the Cossacks abandoned Siberia. But new bands of hunters and adventurers poured every year into the country, and were supported by Moscow. To avoid conflicts with the denser populations of the south, they preferred to advance eastwards along higher latitudes; meanwhile Moscow erected forts and settled labourers around them to supply the garrisons with food. Within eighty years the Russians had reached the Amur and the Pacific. This rapid conquest is accounted for by the circumstance that neither Tatars nor Turks were able to offer any serious resistance. In 1607-1610 the Tunguses fought strenuously for their independence, but were subdued about 1623. In 1628 the Russians reached the Lena, founded the fort of Yakutsk in 1637, and two years later reached the Sea of Okhotsk at the mouth of the Ulya river. The Buriats offered some opposition, but between 1631 and 1641 the Cossacks erected several palisaded forts in their territory, and in 1648 the fort on the upper Uda beyond Lake Baikal. In 1643 Poyarkov's boats descended the Amur, returning to Yakutsk by the Sea of Okhotsk and the Aldan, and in 1649-1650 Khabarov occupied the banks of the Amur. The resistance of the Chinese, however, obliged the Cossacks to quit their forts, and by the treaty of Nerchinsk (1689) Russia abandoned her advance into the basin of the river. In 1852 a Russian military expedition under Muraviev explored the Amur, and by 1857 a chain of Russian Cossacks and peasants were settled along the whole course of the river. The accomplished fact was recognized by China in 1857 and 1860 by a treaty. In the same year in which Khabarov explored the Amur (1648) the Cossack Dejnev, starting from the Kolyma, sailed round the north-eastern extremity of Asia through the strait which was rediscovered and described eighty years later by Bering (1728). Cook in 1778, and after him La Pérouse, settled definitively the broad features of the northern Pacific coast. Although the Arctic Ocean had been reached as early as the first half of the 17th century, the exploration of its coasts by a series of expeditions under Ovtzyn, Minin, Pronchishev, Lasinius and Laptev—whose labours constitute a brilliant page in the annals of geographical discovery—was begun only in the 18th century (1735-1739).

The scientific exploration of Siberia, begun in the period 1733 to 1742 by Messerschmidt, Gmelin, and De Lisle de la Croyère, was followed up by Müller, Fischer and Georgi. Pallas, with several Russian students, laid the first foundation of a thorough exploration of the topography, fauna, flora and inhabitants of the country. The journeys of Hansteen and Erman (1828-1830) were a most important step in the exploration of the territory. Humboldt, Ehrenberg and Gustav Rose also paid in the course of these years short visits to Siberia, and gave a new impulse to the accumulation of scientific knowledge; while Ritter elaborated in his *Asien* (1832-1859) the foundations of a sound knowledge of the structure of Siberia. Middendorff's journey (1844-1845) to north-eastern Siberia—contemporaneous with Castrén's journeys for the special study of the Ural-Altaian languages—directed attention to the far north and awakened interest in the Amur, the basin of which soon became the scene of the expeditions of Akhte and Schwarz (1852), and later on (1854-1857) of the Siberian expedition to which we owe so marked an advance in our knowledge of East Siberia. The Siberian branch of the Russian Geographical Society was founded at the same time at Irkutsk, and afterwards became a permanent centre for the exploration of Siberia; while the opening of the Amur and Sakhalin attracted Maack, Schmidt, Glehn, Radde and Schrenck, whose works on the flora, fauna and inhabitants of Siberia have become widely known.

BIBLIOGRAPHY.—A. T. von Middendorff, *Sibirische Reise* (St Petersburg, 1848-1875); L. Schrenck, *Reisen und Forschungen im Amurgebiet* (St Petersburg, 1858-1891); *Trudy* of the Siberian expedition—mathematical part (also geographical) by Schwarz, and physical part by Schmidt, Glehn and Brylkin (1874, seq.); G. Kennan, *Tent Life in Siberia* (1870); Paplov, *Siberian Rivers* (1878); A. E. Nordenskjöld, *Voyage of the Vega* (1881) and *Vega Exped. Vetensk. Akttagelser* (5 vols., Stockholm, 1872-1887); P. P. Semenov, *Geogr. and Stat. Dictionary of the Russian Empire* (in Russian, 5 vols., St Petersburg, 1863-1884)—a most valuable source of information, with full bibliographical details under each article; *Picturesque Russia* (in Russian), ed. by P. Semenov, vol. xi. (West Siberia) and xii. (East Siberia); Scheglov, *Chronology of Sib. Hist. from 1032 to 1882*; Yadrintsev, *Siberia* (St Petersburg, 2nd ed., 1892, in Russian); Vagin, "Historical Documents on Siberia," in the collection *Sibir*, vol. i.; Yadrintsev, *Siberia as a Colony* (new ed., 1892); F. M. Dostoievsky's novel, *Buried Alive* (1881); Baron A. von Rosen, *Memoiren eines russischen Dekabristen* (Leipzig, 1870). Consult further *Materials for the Study of the Economic Conditions of West Siberia* (22 vols., St Petersburg, 1889-1898),

condensed in *Peasant Land-Tenure and Husbandry in Tobolsk and Tomsk* (St Petersburg, 1894), both in Russian. Similar *Materials* for the Altai region, published at St Petersburg by the Cabinet of the emperor, and for Irkutsk and Yeniseisk (12 fasc., Irkutsk, 1889-1893); *Materials* for Transbaikalia (16 vols., St Petersburg, 1898), summed up in *Transbaikalia*, by N. Razumov (St Petersburg, 1899). Other works deserving special mention are: Ermolov, *Siberia as a Colony* (3rd ed., 1894); Jarilow, *Ein Beitrag zur Landwirtschaft in Sibirien* (Leipzig, 1896). Among books of more recent publication must be mentioned G. Krahmer, *Russland in Asien* (3 vols., Leipzig, 1898-1900) and *Sibirien und die grosse sibirische Eisenbahn* (2nd ed., 1900); Wirt Gerrare, *Greater Russia* (London 1903); J. F. Fraser, *The Real Siberia* (London, 1902); P. Kropotkin, *Orographie de la Sibirie* (Brussels, 1904); P. Leroy-Beaulieu, *La Rénovation de l'Asie centrale* (Paris, 1900); J. Stading, *Through Siberia* (London, 1901); S. Turner, *Siberia* (London, 1906); G. F. Wright, *Asiatic Russia* (2 vols., London, 1903); L. Deutsch, *Sixteen Years in Siberia* (Eng. trans., London, 1905); V. Dolgorukov, *Guide through Siberia* (3rd ed., Tomsk, 1898, in Russian, with summaries in French); A. N. de Koulomzine, *Le Trans-sibérien* (Paris, 1904); Bishop of Norwich, *My Life in Mongolia and Siberia* (London, 1903); S. Patkanov, *Essai d'une statistique et d'une géographie des peuples paléosibériens de la Sibirie* (St Petersburg, 1903); M. P. de Semenov, *La Russie extra-européenne et polaire* (Paris, 1900); J. W. Bookwalter, *Siberia and Central Asia* (Springfield, Ohio, 1899); *Siberia and the Great Siberian Railway*, by Ministry of Finance (Eng. trans., ed. by J. M. Crawford, St Petersburg, 1893, vol. v. for flora). *Climatological Atlas of the Russian Empire*, by the Physical Observatory (St Petersburg, 1900), gives data and observations covering the period 1849-1899. A full bibliography will be found in the *Russian Encyclopaedic Dictionary*, as also in Mezhev, *Siberian Bibliography* (3 vols., St Petersburg, 1891-1892), and in A. Pypin's *History of Russian Ethnography*, vol. iv. (P. A. K.; J. T. BE.)

SIBI, a town and district of Baluchistan. The town is now an important junction on the Sind-Peshin railway, where the Harnai line and the Quetta loop line meet, near the entrance of the Bolan pass, 88 m. S.E. of Quetta. Pop. (1901) 4551. The district, which was constituted in 1903, has an area of 4152 sq. m.; pop. (1901) 74,555. The greater part became British territory by the treaty of Gandamak in 1879; the rest is administered under a perpetual lease from the khan of Kalat. Political control is also exercised over the Marri-Bugti country, with an additional area of 7129 sq. m.: pop. (1901) 38,919. Besides the town of Sibi, the district contains the sanatorium of Ziarat, the summer residence of the government.

See *Sibi District Gazetteer* (Bombay, 1907).

SIBONGA, a town of the province of Cebú, island of Cebú, Philippine Islands, on the E. coast, 30 m. S.W. of Cebú, the capital. Pop. (1903) 25,848. Sibonga is an agricultural town with a port for coasting vessels, and is served by a railway. The principal products are Indian corn and tobacco. The climate is hot, but healthy. The language is Cebú-Visayan.

SIBPUR, a town of British India, in the Hugli district of Bengal, on the right bank of the river Hugli, opposite Calcutta. It is a suburb of Howrah. It contains jute-mills, a flour-mill, rope-works, brick-works and other industrial establishments; the royal botanical garden; and the engineering college with electrical and mining departments and a boarding-house. The college, of gothic architecture, was originally built for a missionary institution, as the Bishop's College, in 1824. It has recently been decided to remove it to Ranchi, in Chota Nagpur.

SIBSAGAR, a town and district of British India, in eastern Bengal and Assam. The town is situated on the Dikhu river, about 9 m. from the left bank of the Brahmaputra, being picturesquely built round a magnificent tank, covering an area of 114 acres. Pop. (1901) 5712. In 1907 the transfer of the district headquarters to Jorhak (pop. 2899), on the Disai river, was sanctioned.

The DISTRICT OF SIBSAGAR has an area of 4996 sq. m. It consists of a level plain, much overgrown with grass and jungle, and intersected by numerous tributaries of the Brahmaputra. It is divided by the little river Disai into two tracts, which differ in soil and general appearance. The surface of the eastern portion is very flat, the general level being broken only by the long lines of embankments raised by the Ahom kings to serve both as roadways and as a protection against floods. The soil consists of a heavy loam of a whitish colour, which is well adapted for rice cultivation. West of the Disai, though the surface soil is of the same character, the general aspect is diversified

by the protrusion of the subsoil, which consists of a stiff clay abounding in iron nodules, and is furrowed by frequent ravines and water-courses, which divide the cultivable fields into innumerable small sunken patches or *holas*. The chief river is the Brahmaputra, which is navigable throughout the year by steamers. The tributaries of the Brahmaputra comprise the Dhaneswari, the Dihing, the Disang and the Dikhu, all flowing in a northerly direction from the Naga Hills. Included within the district is the island of Maguli, formed by the silt brought down by the Subansiri river from the Himalayas and deposited in the wide channel of the Brahmaputra. Coal, iron, petroleum and salt are found. The climate, like that of the rest of the Assam valley, is comparatively mild and temperate, and the annual rainfall averages about 94 in.

In 1901 the population was 597,969, showing an increase of 24% in the decade. Sibsagar is the chief centre of tea cultivation in the Brahmaputra valley, which was introduced by the Assam Company in 1852. It contains a large number of well-managed tea-gardens, which bring both men and money into the province. There are also several timber mills. The Assam-Bengal railway serves the southern part of the district, and a light railway connects this line with Kalikamukh on the Brahmaputra, itself an important highway of communication.

On the decline of the Ahom dynasty Sibsagar, with the rest of the Assam valley, fell into the hands of the Burmese. As a result of the first Burmese war (1824-1826) the valley was annexed to British India, and the country now forming Sibsagar district, together with the southern portion of Lakhimpur, was placed under the rule of Raja Purandhar Singh, on his agreeing to pay a tribute of £5000. Owing to the raja's misrule, Sibsagar was reduced to a state of great poverty, and, as he was unable to pay the tribute, the territories were resumed by the government of India, and in 1838 were placed under the direct management of a British officer.

See *Sibsagar District Gazetteer* (Allahabad, 1906).

SIBTHORP, JOHN (1758-1796), English botanist, was born at Oxford on the 28th of October 1758, and was the youngest son of Dr Humphrey Sibthorp (1713-1797), who from 1747 to 1784 was Sherardian professor of botany at Oxford. He graduated at Oxford in 1777, and then studied medicine at Edinburgh and Montpellier. In 1784 he succeeded his father in the Sherardian chair. Leaving his professional duties to a deputy he left England for Göttingen and Vienna, in preparation for a botanical tour in Greece (1786). Returning to England at the end of the following year he took part in the foundation of the Linnaean Society in 1788, and set to work on a flora of Oxfordshire, which was published in 1794 as *Flora Oxoniensis*. He made a second journey to Greece, but developed consumption on the way home and died at Bath on the 8th of February 1796. By his will he bequeathed his books on natural history and agriculture to Oxford university, where also he founded the Sibthorpean professorship of rural economy, attaching it to the chair of botany. He directed that the endowment should first be applied to the publication of his *Flora Graeca* and *Florae Graecae Prodrromus*, for which, however, he had done little beyond collecting some three thousand species and providing the plates. The task of preparing the works was undertaken by Sir J. E. Smith, who issued the two volumes of the *Prodrromus* in 1806 and 1813, and six volumes of the *Flora Graeca* between 1806 and 1828. The seventh appeared in 1830, after Smith's death, and the remaining three were produced by John Lindley between 1833 and 1840.

Another member of the family, RALPH WALDO SIBTHORP (1792-1879), a grandson of Dr Humphrey Sibthorp, was a well-known English divine. He was educated at Oxford and took Anglican orders in 1815. He became known as a prominent "evangelical" in London, but in 1841 was received into the Roman Church. Two years later he returned to the Anglican Church, though he was not readmitted to the ministry till 1857. Finally he re-entered the Roman communion in 1865, but on his death in 1879 he was, by his own request, buried according to the service of the English Church. His elder brother, COLONEL

CHARLES DE LAET WALDO SIBTHORP (1783-1855), represented Lincoln in parliament from 1826 until his death, except for a short period in 1833-1834, and was notorious for the vigour with which he expressed his opinions and for his opposition to the Catholic Emancipation Bill and the Reform Bill. The eldest son of Colonel Sibthorp, GERVAISE TOTTENHAM WALDO SIBTHORP (1815-1861), was also M.P. for Lincoln.

SIBYLLINE ORACLES, a collection of Apocalyptic writings, composed in imitation of the heathen Sibylline books (see SIBYLS) by the Jews and, later, by the Christians in their efforts to win the heathen world to their faith. The fact that they copied the form in which the heathen revelations were conveyed (Greek hexameter verses) and the Homeric language is evidence of a degree of external Hellenization, which is an important fact in the history of post-exilic Judaism. Such was the activity of these Jewish and Christian missionaries that their imitations have swamped the originals. Even Virgil in his fourth Eclogue seems to have used Jewish rather than purely heathen oracles.

The extant fragments and conglomeration of the Sibylline oracles, heathen, Jewish and Christian, were collected, examined, translated and explained by C. Alexandre in a monumental edition full of exemplary learning and acumen. On the basis of his results, as they have been scrutinized by scholars like Schürer and Geffcken, it is possible to disentangle some of the different strata with a certain degree of confidence.

1. Book III. contains Jewish oracles relative to the Golden Age established by Roman supremacy in the East about the middle of the 2nd century B.C. (especially 175-181: cf. 1 Macc. viii. 1-16). The evacuation of Egypt by Antiochus Epiphanes at the bidding of the Roman ambassadors suits the warning addressed to "Greece" (732-740) against overweening ambition and any attempt upon the Holy City, which is somewhat strangely enforced by the famous Greek oracle, "Let Camarina be, 'tis best unstirred." Older than these are the Babylonian oracle (97-154) and the Persian (381-387). A later Jewish oracle (46-62) refers to the wars of the second Triumvirate of Rome, and the whole compilation seems to come from a Christian redactor.

2. Book IV. is a definite attack upon the heathen Sibyl—the Jews and Christians did not attempt to pass off their "forgeries" as genuine—as the mouthpiece of Apollo by a Jew who speaks for the Great God and yet uses a Greek review (49-114) of ancient history from the Assyrian empire. There are references to the legendary escape of Nero to Parthia (119-124) and the destruction of Jerusalem in A.D. 70 (130-136).

3. Book V. contains a more developed form of the myth of *Nero redivivus* in which a panegyric on him (137-141) has been brought up to date by some Jew or Christian, and eulogies of Hadrian and his successors (48-51) side by side with the legend of the miserable death of Titus in quittance of his destruction of Jerusalem (411-413) which probably represents the hope of the zealots who survived it.

4. The remaining books appear to be Christian (some heretical) and to belong to the 2nd and 3rd centuries.

EDITIONS.—C. Alexandre (Paris, 1841, 2 vols.; 1869, 1 vol.); Rzach (Prague, 1891; text and appendix of sources); Geffcken (Leipzig, 1902; text with full apparatus of variants, sources and parallel passages); see also his *Komposition und Entstehungszeit des Oracula Sibyllina* (Leipzig, 1902). An annotated Eng. trans. was undertaken in 1910 by H. C. O. Lanchester. For references to modern literature see Schürer, *Geschichte des jüdischen Volkes*, iii. (4th ed.), 555-592. (J. H. A. H.)

SIBYLS¹ (*Sibyllae*), the name given by the Greeks and Romans to certain women who prophesied under the inspiration of a deity. The inspiration manifested itself outwardly in distorted features, foaming mouth and frantic gestures. Homer does not refer to a Sibyl, nor does Herodotus. The first Greek writer, so far as we know, who does so is Heraclitus (c. 500 B.C.). As to the number and native countries of the Sibyls much diversity of opinion prevailed. Plato only speaks of one, but in course of time the number increased to ten according to Lactantius

¹ The word is usually derived from *Σιο-βόλλα*, the Doric form of *Θεοῦ βουλή* (= will of God).

(quoting from Varro): the Babylonian or Persian, the Libyan, the Cimmerian, the Delphian, the Erythraean, the Samian, the Cumaean, the Hellespontine, the Phrygian and the Tiburtine. The Sibyl of whom we hear most is the Erythraean, generally identified with the Cumaean, whom Aeneas consulted before his descent to the lower world (*Aeneid*, vi. 10); it was she who sold to Tarquin the Proud the Sibylline books. She first offered him nine; when he refused them, she burned three and offered him the remaining six at the same price; when he again refused them, she burned three more and offered him the remaining three still at the same price. Tarquin then bought them (Dion. Halic. iv. 62). He entrusted them to the care of two patricians; after 367 B.C. ten custodians were appointed, five patricians and five plebeians; subsequently (probably in the time of Sulla) their number was increased to fifteen. These officials, at the command of the senate, consulted the Sibylline books in order to discover, not exact predictions of definite future events, but the religious observances necessary to avert extraordinary calamities (pestilence, earthquake) and to expiate prodigies in cases where the national deities were unable, or unwilling, to help. Only the interpretation of the oracle which was considered suitable to the emergency was made known to the public, not the oracle itself. An important effect of these books was the grecizing of Roman religion by the introduction of foreign deities and rites (worshipped and practised in the Troad) and the amalgamation of national Italian deities with the corresponding Greek ones (fully discussed in J. Marquardt, *Staatsverwaltung*, iii., 1885, pp. 42, 350, 382). They were written in hexameter verse and in Greek; hence the college of curators was always assisted by two Greek interpreters. The books were kept in the temple of Jupiter on the Capitol and shared the destruction of the temple by fire in 83. After the restoration of the temple the senate sent ambassadors in 76 to Erythrae to collect the oracles afresh and they brought back about 1000 verses; others were collected in Ilium, Samos, Sicily, Italy and Africa. In the year 12 B.C. Augustus sought out and burned a great many spurious oracles and subjected the Sibylline books to a critical revision; they were then placed by him in the temple of Apollo Patroüs on the Palatine, where we hear of them still existing in A.D. 363. They seem to have been burned by Stilicho shortly after 400. According to the researches of R. H. Klausen (*Aeneas und die Penaten*, 1839), the oldest collection of Sibylline oracles appears to have been made about the time of Solon and Cyrus at Gergis on Mount Ida in the Troad; it was attributed to the Hellespontine Sibyl and was preserved in the temple of Apollo at Gergis. Thence it passed to Erythrae, where it became famous. It was this very collection, it would appear, which found its way to Cumae and from Cumae to Rome.

Some genuine Sibylline verses are preserved in the *Book of Marvels* (*Περὶ θαυμασίων*) of Phlegon of Tralles (2nd century A.D.). See H. Diels, *Sibyllinische Blätter* (1890). On the subject generally see J. Marquardt as above; A. Bouché-Leclercq, *La Divination dans l'antiquité* (1879-1882); E. Maass, *De Sibyllarum indicibus* (1879); C. Schultess, *Die sibyllinischen Bücher in Rom* (1895; with references to authorities in notes).

SICANI, in ancient geography, generally regarded (together with the Elymi) as the oldest inhabitants of Sicily. Sicania (the country of the Sicani) and the Siculi (*q.v.*) or Siceli are mentioned in Homer (*Odyssey*, xx. 383, xxiv. 307), the latter apparently being known to the Greeks as slave-dealers. There existed considerable difference of opinion among the ancients as to the origin of the Sicani. From the similarity of name, it would be natural to identify them with the Siculi, but ancient authorities expressly state that they were two distinct peoples (see SICILY: *History*, *ad init.*). At first the Sicani occupied nearly the whole of the island, but were gradually driven by the Siceli into the interior and the N. and N.W. They lived chiefly in small towns and supported themselves by agriculture. These towns were not subject to a single king, but each had its own ruler and constitution. The most important of the towns to which a Sicanian origin can be with certainty assigned and whose site can be determined, are: Hyccara (*Muro di Carini*),

taken and plundered by the Athenians during the Sicilian expedition (415 B.C.); Omphakē, between Agrigentum (*Girgenti*) and Gela (*Terranova*); and Camicus (site unknown), the residence of the mythical Sicanian king Cocalus, constructed for him by Daedalus (*q.v.*), to whom he had given shelter when pursued by Minos, king of Crete.

SICARD, ROCH-AMBROISE CUCURRON (1742-1822), French abbé and instructor of deaf-mutes, was born at Le Fousseret, Haute-Garonne, on the 20th of September 1742. Educated as a priest, he was made principal of a school of deaf-mutes at Bordeaux in 1786, and in 1789, on the death of the Abbé de l'Épée (see *ÉPÉE*), succeeded him at Paris. His chief work was his *Cours d'instruction d'un sourd-muet de naissance* (1800). See DEAF AND DUMB. The Abbé Sicard managed to escape any serious harm in the political troubles of 1792, and became a member of the Institute in 1795, but the value of his educational work was hardly recognized till shortly before his death at Paris on the 10th of May 1822.

SICILY (Ital. *Sicilia*), an island of the Mediterranean Sea belonging to the kingdom of Italy, and separated from the nearest point of the mainland of Italy only by the Straits of Messina, which at their narrowest part are about 2 m. in width. It is nearly bisected by the meridian of 14° E., and by far the greater part lies to the south of 38° N. Its southernmost point, however, in 36° 38' N. is 40' to the north of Point Tarifa, the southernmost point of Spain and of the continent of Europe. In shape it is roughly triangular,¹ whence the ancient poetical name of *Trinacria*, referring to its three promontories of Pelorum (now Faro) in the north-east, Pachynum (now Passero) in the south-east, and Lilybaeum (now Boeo) in the west. Its area, exclusive of the adjacent small islands belonging to the *compartimento*, is, according to the calculations of the Military Geographical Institute of Italy, 9860 sq. m.; while the area of the whole *compartimento* is 9936 sq. m.

The island occupies that part of the Mediterranean in which the shallowing of the waters divides that sea into two basins, and in which there are numerous indications of frequent changes in a recent geological period. The channel between Cape Bon in Tunis and the south-west of Sicily (a distance of 80 m.) is, on the whole, shallower than the Straits of Messina, being for the most part under 100 fathoms in depth, and exceeding 200 fathoms only for a very short interval, while the Straits of Messina, have almost everywhere a depth exceeding 150 fathoms. The geological structure in the neighbourhood of this strait shows that the island must originally have been formed by a rupture between it and the mainland, but that this rupture must have taken place at a period long antecedent to the advent of man, so that the name Rhegium cannot be based even on the tradition of any such catastrophe. The mountain range that runs out towards the north-east of Sicily is composed of crystalline rocks precisely similar to those forming the parallel range of Aspromonte in Calabria, but both of these are girt about by sedimentary strata belonging in part to an early Tertiary epoch. That a subsequent land connexion took place, however, by the elevation of the sea-bed there is abundant evidence to show; and the occurrence of the remains of African Quaternary mammals, such as *Elephas meridionalis*, *E. antiquus*, *Hippopotamus penlandi*, as well as of those of still living African forms, such as *Elephas africanus* and *Hyaena crocuta*, makes it probable that there was a direct post-Tertiary connexion also with the African continent.

The north coast is generally steep and cliff-bound, and abundantly provided with good harbours, of which that of Palermo is the finest. In the west and south, and in the south part of the east side, the hills are much lower and recede farther from the sea. The coast is for the most part flat, more regular in outline and less favourable to shipping, while in the east,

¹ The name *Trinacria* was no doubt suggested by the *Θρινακρία* of Homer (which need not, however, be Sicily), and the geography was then fitted to the apparent meaning given to the name by the change. But of these three so-called promontories the last is not a true promontory, and it is more accurate to treat Sicily as having a fourth side on the west.

where the sea-bottom sinks rapidly down towards the eastern basin of the Mediterranean, steep rocky coasts prevail except opposite the plain of Catania. In the northern half of this coast the lava streams of Mount Etna stand out for a distance of about 20 m. in a line of bold cliffs and promontories. At various points on the east, north and west coasts there are evidences of a rise of the land having taken place within historical times, at Trapani on the west coast even within the 19th century. As in the rest of the Mediterranean, tides are scarcely observable; but at several points on the west and south coasts a curious oscillation in the level of the waters, known to the natives as the *marrobbio* (or *marobia*), is sometimes noticed, and is said to be always preceded by certain atmospheric signs. This consists in a sudden rise of the sea-level, occasionally to the height of 3 ft., sometimes occurring only once, sometimes repeated at intervals of a minute for two hours, or even, at Mazzara, where it is most frequently observed, for twenty-four hours together.

The surface of Sicily lies for the most part more than 500 ft. above the level of the sea. Caltanissetta, which occupies the middle point in elevation as well as in respect of geographical situation, stands 1900 ft. above sea-level. Considerable mountains occur only in the north, where the lower slopes of all the heights form one continuous series of olive-yards and orangeries. Of the rest of the island the greater part forms a plateau varying in elevation and mostly covered with wheat-fields. The only plain of any great extent is that of Catania, watered by the Simeto, in the east; to the north of this plain the active volcano of Etna rises with an exceedingly gentle slope to the height of 10,868 ft. from a base 400 sq. m. in extent. This is the highest elevation of the island. The steep and narrow crystalline ridge which trends north-eastwards, and is known to geographers by the name of the Peloritan Mountains, does not reach 4000 ft. The Nebrodi Mountains, a limestone range connected with the Peloritan range and having an east and west trend, rise to a somewhat greater height, and farther west, about the middle of the north coast, the Madonie (the only one of the groups mentioned which has a native name) culminate at the height of nearly 6500 ft. From the western end of the Nebrodi Mountains a lower range (in some places under 1500 ft. in height) winds on the whole south-eastwards in the direction of Cape Passaro. With the exception of the Simeto, the principal perennial streams—the Salso, the Platani and the Belice—enter the sea on the south coast.

Geology.¹—In general, the older beds occur along the northern coast, and progressively newer and newer beds are found towards the south. Folding, however, has brought some of the older beds to the surface in the hills which lie to the north and north-east of Sciacca. The Monti Peloritani at the north-eastern extremity of the island consists of gneiss and crystalline schists; but with this exception the whole of Sicily is formed of Mesozoic and later deposits, the Tertiary beds covering by far the greater part. Triassic rocks form a discontinuous band along the northern coast, and are especially well developed in the neighbourhood of Palermo. They rise again to the surface in the southern part of the island, in the hills which lie to the north of Sciacca and Bivona. In both areas they are accompanied by Jurassic, and occasionally by Cretaceous, beds; but of the latter there are only a few small patches. In the south-eastern part of the island there are also a few very small outcrops of Mesozoic beds. The Eocene and Oligocene form a broad belt along the northern coast, very much more continuous than the Mesozoic band, and from this belt a branch extends southwards to Sciacca. Another patch of considerable size lies to the east of Piazza-Armerina. Miocene and Pliocene deposits cover nearly the whole of the country south of a line drawn from Etna to Marsala; and there is also a considerable Miocene area in the north about Mistretta. Volcanic lavas and ashes of a recent geological period form not only the whole of Etna but also a large part of the Monti Iblei in the south. Small patches occur also at Pachino and in the hills north of Sciacca.

Climate.—The climate of Sicily resembles that of the other lands in the extreme south of Europe. As regards temperature, it has the warm and equable character which belongs to most of the Mediterranean region. At Palermo (where continuous observations have been made since 1791) the range of temperature between the mean of

the coldest and that of the hottest month is little greater than at Greenwich. The mean temperature of January (51½° F.) is nearly as high as that of October in the south of England, that of July (77° F.) about 13° warmer than the corresponding month at Greenwich. In only seven of the thirty years, 1871–1900, was the thermometer observed to sink below the freezing-point; frost thus occurs in the island even on the low grounds, though never for more than a few hours. On the coast snow is seldom seen, but it does fall occasionally. On the Madonie it lies till June, on Etna till July. The annual rainfall except on the higher mountains does not reach 30 in., and, as in other parts of the extreme south of Europe, it occurs chiefly in the winter months, while the three months (June, July and August) are almost quite dry. During these months the whole rainfall does not exceed 2 in., except on the slopes of the mountains in the north-east. Hence most of the streams dry up in summer. The chief scourge is the sirocco, which is experienced in its most characteristic form on the north coast, as an oppressive, parching, hot, dry wind, blowing strongly and steadily from the south, the atmosphere remaining through the whole period of its duration leaden-coloured and hazy in consequence of the presence of immense quantities of reddish dust. It occurs most frequently in April, and then in May and September, but no month is entirely free from it. Three days are the longest period for which it lasts. The same name is sometimes applied to a moist and not very hot, but yet oppressive, south-east wind which blows from time to time on the east coast. Malaria occurs in some parts of the island.

Flora.—The flora of Sicily is remarkable for its wealth of species; but, comparing Sicily with other islands that have been long separated from the mainland, the number of endemic species is not great. The orders most abundantly represented are the *Compositae*, *Cruciferae*, *Labiatee*, *Caryophyllaceae* and *Scrophulariaceae*. The *Rosaceae* are also abundantly represented, and among them are numerous species of the rose. The general aspect of the vegetation of Sicily, however, has been greatly affected, as in other parts of the Mediterranean, by the introduction of plants within historical times. Being more densely populated than any other large Mediterranean island, and having its population dependent chiefly on the products of the soil, it is necessarily more extensively cultivated than any other of the larger islands referred to, and many of the objects of cultivation are not originally natives of the island. Not to mention the olive, which must have been introduced at a remote period, all the members of the orange tribe, the agave and the prickly pear, as well as other plants highly characteristic of Sicilian scenery, have been introduced since the beginning of the Christian era. With respect to vegetation and cultivation three zones may be distinguished. The first reaches to about 1600 ft. above sea-level, the upper limit of the members of the orange tribe; the second ascends to about 3300 ft., the limit of the growth of wheat, the vine and the hardier evergreens; and the third, that of forests, reaches from about 3300 ft. upwards. But it is not merely height that determines the general character of the vegetation. The cultivated trees of Sicily mostly demand such an amount of moisture as can be obtained only on the mountain slopes, and it is worthy of notice that the structure of the mountains is peculiarly favourable to the supply of this want. The limestones of which they are mostly composed act like a sponge, absorbing the rain-water through their innumerable pores and fissures, and thus storing it up in the interior, afterwards to allow it to well forth in springs at various elevations lower down. In this way the irrigation which is absolutely indispensable for the members of the orange tribe during the dry season is greatly facilitated, and even those trees for which irrigation is not so indispensable receive a more ample supply of moisture during the rainy season. Hence it is that, while the plain of Catania is almost treeless and tree-cultivation is comparatively limited in the west and south, where the extent of land under 1600 ft. is considerable, the whole of the north and north-east coast from the Bay of Castellammare round to Catania is an endless succession of orchards, in which oranges, citrons and lemons alternate with olives, almonds, pomegranates, figs, carob trees, pistachios, mulberries and vines. The limit in height of the olive is about 2700 ft., and that of the vine about 3500 ft. The lemon is really grown upon a bitter orange tree, grafted to bear the lemon. A considerable silk production depends on the cultivation of the mulberry in the neighbourhood of Messina and Catania. Among other trees and shrubs may be mentioned the sumach, the date-palm, the plantain, various bamboos, cycads and the dwarf-palm, the last of which grows in some parts of Sicily more profusely than anywhere else, and in the desolate region in the south-west yields almost the only vegetable product of importance. The *Arundo Donax*, the tallest of European grasses, is largely grown for vine-stakes.

Population.—The area and population of the several provinces are shown in the table on the next page. Thus between 1881 and 1901 the population increased at the rate of 20.5%. The average density is extremely high for a country which lives almost exclusively by agriculture, and is much higher than the average for Italy in general, 293 per sq. m. In 1905 the population was 3,568,124, the rate of increase being only 4.4% per annum; the low rate is due to emigration.

¹ A general account of the geology of the island will be found in L. Baldacci, *Descrizione geologica dell' isola di Sicilia* (Rome, 1886), with map. For fuller and later information reference should be made to the publications of the Reale Comitato Geologico d'Italia.

Province.	Area in sq. m.	Population 1881.	Population 1901.	No. of Communes.	Density per sq. m. 1901.
Caltanissetta . . .	1263	266,379	329,449	28	262
Catania	1917	563,457	703,598	63	371
Girgenti	1172	312,487	380,666	41	317
Messina	1246	460,924	550,895	97	440
Palermo	1948	699,151	796,151	76	403
Syracuse	1442	341,526	433,796	32	296
Trapani	948	283,977	373,569	20	373
	9936	*2,927,901	3,568,124	357	Av. 352

* In 1861, 2,392,414; in 1871, 2,584,099.

The chief towns in each of these provinces, with their communal populations in 1901, are as follow: *Caltanissetta* (43,023), *Castrogiovanni* (26,081), *Piazza Armerina* (24,119), *Terranova* (22,019), *San Cataldo* (18,090); *Catania* (146,504), *Caltagirone* (44,527), *Acireale* (35,203), *Giarre* (26,194), *Paternò* (22,857), *Leonforte* (21,236), *Bronte* (20,166), *Vizzini* (18,013), *Agira* (17,634), *Nicosia* (15,811), *Grammichele* (15,017); *Girgenti* (24,872), *Canicattì* (24,687), *Sciacca* (24,645), *Licata* (22,993), *Favara* (20,403); *Messina* (147,106), *Racalmuto* (16,028), *Palma* (14,384), *Barcellona* (24,133), *Milazzo* (16,214), *Mistretta* (14,041); *Palermo* (305,716), *Partinico* (23,668), *Monreale* (23,556), *Termini Imerese* (20,633), *Bagheria* (18,329), *Corleone* (16,350), *Cefalù* (14,518); *Syracuse* (31,807), *Modica* (49,951), *Ragusa* (32,453), *Vittoria* (32,219), *Comiso* (25,837), *Noto* (22,284), *Lentini* (17,100), *Avola* (16,301), *Sicli* (16,220), *Palazzolo Acreide* (15,106); *Trapani* (61,448), *Marsala* (57,824), *Alcamo* (51,798), *Monte S. Giuliano* (29,824), *Castelvetrano* (24,510), *Castellammare del Golfo* (20,665), *Mazara del Vallo* (20,044), *Salemi* (17,159).

The archiepiscopal sees (the suffragan sees, if any, being placed after each in brackets) are Catania (Acireale), Messina (Lipari, Nicosia, Patti), Monreale (Caltanissetta, Girgenti), Palermo (Cefalù, Mazara, Trapani), Syracuse (Caltagirone, Noto, Piazza Armerina).

Agriculture.—Sicily, formerly called the granary of Italy, exported grain until the end of the 18th century. Now, although the island still produces every year some 15 million bushels, the supply barely suffices for the consumption of a population of which bread is almost the exclusive diet. The falling-off in the exportation of cereals is not a consequence of any decadence in Sicilian agriculture, but rather of the increase of population, which nearly doubled within the 19th century. Two types of agriculture prevail in Sicily—the extensive and the intensive. The former covers mainly the interior of the island and half the southern coast, while the latter is generally adopted on the eastern and northern coasts. Large holdings of at least 500 hectares (a hectare equals about 2½ acres) are indispensable to the profitable pursuit of extensive agriculture. These holdings are usually called *feudi* or *latifondi*. Their proprietors alternate the cultivation of wheat with that of barley and beans. During the years in which the soil is allowed to lie fallow, the grass and weeds which spring up serve as pasture for cattle, but the poverty of the pasture is such that at least two hectares are required for the maintenance of every animal. This poverty is due to the lack of rain, which, though attaining an annual average of 29 in. at Palermo, reaches only 21 in. at Syracuse on the east coast, and about 19½ in. at Caltanissetta, on the central high plateau. The system of extensive cultivation proper to the *latifondi* gives an annual average gross return of about 200 lire per hectare (£3. 4s. 5d. per acre).

Intensive agriculture in Sicily is limited to fruit trees and fruit-bearing plants, and is not combined with the culture of cereals and vegetables, as in central and parts of northern Italy. Originally the Sicilian system was perhaps due to climatic difficulties, but now it is recognized in most cases to be more rational than combined culture. Large extents of land along the coasts are therefore exclusively cultivated as vineyards, or as olive, orange, and lemon groves. Vineyards give an annual gross return of between £11 and £13 per acre, and orange and lemon groves between £32 and £48 per acre. The by-products of the citrus-essences, citrate of lime, &c. are also of some importance. Much damage is done by the olive fly. Vegetables are grown chiefly in the neighbourhood of large cities. Almonds are freely cultivated, and they seem to be the only trees susceptible also of cultivation upon the *latifondi* together with grain. A large export trade in almonds is carried on with north and central Europe. Hazel nuts are grown in woods at a level of more than 1200 ft. above the sea. These also are largely exported to central Europe for use in the manufacture of chocolate. The locust bean (used for forage), figs, and peaches are widely grown, while in certain special zones the pistachio and the manna-ash yield rich returns. On the more barren soil the sumach shrub, the leaves of which are used for tanning, and the prickly pear grow freely. The latter fruit constitutes, with bread, the staple food of the poorest part of the rural population for several months in the year. The cultivation of cotton, which spread during the American War of Secession, is now rare, since it has not been able to withstand the competition of more favoured countries. All these branches of

intensive cultivation yield a higher gross return than that of the extensive system. Along the coast landed property is as a rule broken up into small holdings, usually cultivated by their owners. There is possibility of great development of market-gardening.

Climatic conditions prevent cattle-raising in Sicily from being as prosperous an undertaking as in central Italy. The total number of bullocks in the island is calculated to be less than 200,000; and although the ratio of consumption of meat is low in proportion to the population, some of the cattle for slaughter have to be imported. Sheep and goats, which subsist more easily on scanty pasturage, are relatively more numerous, the total number being calculated at 700,000. Yet the wool harvest is scarce, and the production of butter a negligible quantity, though there

is abundance of the principal product of Sicilian pasture lands, cheese of various kinds, for which there is a lively local demand. The Sicilian race of horses would be good but that it is not prolific, and has degenerated in consequence of insufficient nourishment and overwork. A better breed of horses is being obtained by more careful selection, and by crossing with Arab and English stallions imported by the government. Donkeys and mules of various breeds are good, and would be better were they not so often weakened by heavy work before attaining full maturity.

Forests.—The absence of forests, which cover hardly 3% of the total area of the island, constitutes a serious obstacle to the prosperity of Sicilian pastoral and agrarian undertakings. The few remaining forests are almost all grouped around Etna and upon the high zone of the Madonian Mountains, a range which rises 40 m. west of Palermo, running parallel to the northern coast almost as far as Messina, and of which many peaks reach nearly 6000 ft. above the sea. Here they are chiefly composed of oaks and chestnuts.

In that part of the island which is cultivated intensively some 100 million gallons of wine are annually produced. Had not the phylloxera devastated the vineyards during the last decade of the 19th century, the production would be considerably higher; 7,700,000 gallons of olive oil and 2500 million oranges and lemons are also produced, besides the other minor products above referred to. The zone of the *latifondi*, or extensive culture, yields, besides wheat, nearly 8,000,000 bushels of barley and beans every year.

Mining.—The most important Sicilian mineral is undoubtedly sulphur, which is mined principally in the provinces of Caltanissetta and Girgenti, and in minor quantities in those of Palermo and Catania. Up to 1896 the sulphur industry was in a state of crisis due to the competition of pyrites, to the subdivision of the mines, to antiquated methods, and to a series of other causes which occasioned violent oscillations in and a continual reduction of prices. The formation of the Anglo-Italian sulphur syndicate arrested the downward tendency of prices and increased the output of sulphur, so that the amount exported in 1899 was 424,018 tons, worth £1,738,475, whereas some years previously the value of sulphur exported had hardly been £800,000. Nineteen-twentieths of the sulphur consumed in the world was formerly drawn from Sicilian mines, while some 50,000 persons were employed in the extraction, manufacture, transport and trade in the mineral. But the development of the United States sulphur industry at the beginning of the 20th century created considerable difficulties, including the practical loss of the United States market. In 1906, when the concession to the Anglo-Sicilian Sulphur Company was about to expire, the government decreed that it should be formed into an obligatory syndicate for a term of twelve years for the control of all sulphur produced in Sicily, and exempted from taxation and legal dues, foreign companies established in Italy to exploit industries in which sulphur is a principal element. The Bank of Sicily was further obliged to make advances to the sulphur industry up to four-fifths of the value of the sulphur deposited in the warehouses. The exports of sulphur in December 1906 were 17,534 tons, as compared with 40,713 tons in 1905; in the year 1904 the total production was 3,291,710 tons (value about £1,522,229) and the total exports 508,980 tons, as compared with 470,341 tons in 1905.

Another Sicilian mineral industry is that of common salt and rock-salt. The former is distilled from sea-water near Trapani, and the latter obtained in smaller quantities from mines. The two branches of the industry yielded in 1899 about 180,000 tons per annum, worth £80,000, while in 1906 about 200,000 tons were made at Trapani alone. About half this quantity is exported, principally to Norway. Besides salt, the asphalt mining industry may be mentioned. Its centre is the province of Syracuse. The value of the annual output is about £40,000, and the exports in 1906 amounted to nearly 103,000 tons. Pumice stone is also exported from Lipari (11,010 tons in 1904).

Other Industries.—Deep-sea fisheries give employment to some twenty thousand Sicilians, who exercise their calling not only off the coasts of their island, but along the north African shore, from Morocco to Tripoli. In 1894 (the last year for which accurate statistics have been issued) 350 fishing smacks were in active service, giving a catch of 2480 tons of fish. Approximately, the value of the annual catch may be reckoned at from £600,000 to £800,000. During 1904 the coral fisheries employed 98 vessels with 1138 men: the

profits were about £75,264, the expenses being £64,664. The sponge divers brought up sponges valued at £24,630. The estimated hauls of tunny fish were 5534 tons, valued at £110,324.

The majority of the scanty Sicilian industries are directly connected with various branches of agriculture. Such, for instance, is the preparation of the elements of citric acid, which is manufactured at an establishment at Messina. Older and more flourishing is the Marsala industry. Marsala wine is a product of the western vineyards situated slightly above sea-level. In 1899, wine was exported to the value of more than £120,000, while in 1906, 24,080 pipes of the value of £361,200 were shipped. The quantity consumed in Italy is far greater than that exported abroad.

Another flourishing Sicilian industry carried on by a large number of small houses is that of preserving vegetables in tins. Artichokes and tomato sauce are the principal of these products, of which several dozen million tins are annually exported from Sicily to the Italian mainland, to Germany and to South America. Manufactories of furniture, carriages, gloves, matches and leather exist in large number in the island. They are, as a rule, small in extent, and are managed by the owners with the help of five, ten or at most twenty workmen. There are several glass works at Palermo, a cotton dyeing works at Messina, and a large metal foundry at Palermo. Large shipbuilding yards and a yard for the construction of trams and railway carriages have been constructed in the latter city. There are dry docks both at Palermo and Messina.

Communications.—Before 1860 there was no railway in Sicily. The total length of Sicilian railways is now 890 m., all single lines. Their construction was rendered very costly by the mountainous character of the island. They formed a separate system (the Rete Sicula) until in 1906, like the rest of the railways of Italy, they passed into the hands of the state, with the exception of the line round Mount Etna and the line from Palermo to Corleone. Messina is connected with the railway system of the mainland by ferry-boats from Villa S. Giovanni and Reggio, on which the through carriages are conveyed across the straits. From Messina lines run along the northern coast to Palermo, and along the east coast via Catania to Syracuse: the latter line is prolonged along the south of the island (sometimes approaching, sometimes leaving the coast) via Canicatti as far as Aragona Caldare, Girgenti and Porto Empedocle. From Catania another line runs westward through the centre of the island via S. Caterina Xirbi (with a branch to Canicatti) to Roccapalumba (with a branch to Aragona Caldare) and thence northwards to Termini, on the line between Messina and Palermo. This is the direct route from Catania to Palermo. From Catania begins the line round Etna following its south, west and northern slopes, and ending at Giarre Riposto on the east coast railway. From Valsavoia (14 m. S. of Catania on the line to Syracuse) a branch line runs to Caltagirone. From Palermo a line runs southwards to Corleone and S. Carlo (whence there are diligences to Sciacca on the south coast) and another to Castelvetrano, Marsala and Trapani, going first almost as far as the south coast and then running first west and then north along the west coast. The only part of the coast of the island which has no railways is that portion of the south coast between Porto Empedocle and Castelvetrano (Sciacca lies about midway between these two points), where a road already exists, and a railway is projected, and the precipitous north coast between Palermo and Trapani. A steam tramway runs from Messina to the Faro at the north-east extremity of the island, and thence along the north coast to Barcelona, and another along the east coast from Messina to Giampiglieri: while the island is fairly well provided with high roads, but is very backward in rural communications, there being only 244 yds. of road per sq. m., as compared with 1480 yds. in north Italy. The communications by sea, however, are at least as important as those by land, even for passengers. A steamer leaves Naples every night for Palermo, and vice versa, the journey (208 m.) being done in 11 hours, while the journey by rail (438 m.), including the crossing of the Straits of Messina takes 19½ hours; and the weekly steamer from Naples to Messina (216 m.) takes 12 hours, while the journey by rail and ferry boat (292 m.) takes 14 hours. Palermo, Messina and Catania are the most important harbours, the former being one of the two headquarters (the other, and the main one, is Genoa) of the Navigazione Generale Italiana, and a port of call for the steamers from Italy to New York. Emigrants to the number of 37,638 left Palermo direct for New York in 1906, and no less than 46,770 in 1905, while others embarked at Messina and Naples.

The movement of trade in these three ports may be shown by the following table:—

		Palermo.	Messina. ¹	Catania.
1900	Tonnage of shipping	1,658,848	1,683,244	1,245,954
	" goods landed	398,718	213,624	235,575
1904	" shipping	2,298,054	2,265,381	1,593,678
	" goods landed	445,036	315,414	309,514
1906	" shipping	2,403,851 ²	2,574,872	1,542,520

¹ The high proportion of shipping entering Messina is due to its position in the Straits.

² Steamships only.

Of the other harbours, Porto Empedocle and Licata share with Catania most of the sulphur export trade, and the other ports of note are Marsala, Trapani, Syracuse (which shares with the roadstead of Mazzarelli the asphalt export trade). The total importation of coal in 1906 amounted to 519,478 tons, practically all British.

In 1904, 75,779 Sicilians were registered as seamen, and 110 steamships with a gross tonnage of 145,702 were registered in Sicily.

Economic, Intellectual, and Moral Conditions.—As a general rule, trade and the increase of production have not kept pace with the development of the ways of communication. The poverty of the Sicilian population is accentuated by the unequal distribution of wealth among the different classes of society. A small but comparatively wealthy class—composed principally of the owners of *latifondi*—resides habitually in the large cities of the island, or even at Naples, Rome or Paris. Yet even if all the wealthy landowners resided on their estates, their number would not be sufficient to enable them to play in local public life a part corresponding to that of the English gentry. On the other hand, the class which would elsewhere be called the middle class is in Sicily extremely poor. The origin of most of the abuses which vitiate Sicilian political life, and of the frequent scandals in the representative local administrations, is to be found in the straitened condition of the Sicilian middle classes.

Emigration only attained serious proportions within the last decade of the 19th century. In 1897 the permanent emigration from the island was 15,994, in 1898, 21,320, and in 1899, 24,604. Since then it has much increased: in 1905 the emigrants numbered 106,000, and in 1906, 127,000 (3.5% of the population). Of these about three-fourths would be adults; but the population has increased so fast as more than to cover the deficiency—with the disadvantage, however, that in three years 220,000 workers were replaced by 320,000 infants.

The moral and intellectual defects of Sicilian society are in part results of the economic difficulties, and in part the effect of bad customs introduced or maintained during the long period of Sicilian isolation from the rest of Europe. When, in 1860, Sicily was incorporated in the Italian kingdom, hardly a tenth of the population could read and write. Upon the completion of unity, elementary schools were founded everywhere; but, though education was free, the indigence of the peasants in some regions prevented them from taking full advantage of the opportunities offered. Thus, even now, 60% of the Sicilian conscripts come up for military service unable either to read or to write. Secondary and superior education is more diffused. The pupils of the secondary schools in Sicily number 3.94 per 1000, the maximum being 6.60 in Liguria and the minimum 1.65 in Basilicata.

Brigandage of the classical type has almost disappeared from Italy. The true brigands haunt only the most remote and most inaccessible mountains. Public security is better in the east than in the west portion of the island. Criminal statistics, though slowly diminishing, are still high—murders, which are the most frequent crimes, having been 27 per 100,000 inhabitants in 1897-1898 and 25.23 per 100,000 in 1903, as against 2.57 in Lombardy, 2.00 in the district of Venetia, 4.50 in Tuscany and 5.24 in Piedmont. Violent assaults with infliction of serious wounds are also frequent. This readiness to commit bloodshed is largely attributable to the sentiment of the Mafia (*q.v.*). (G. G. C.; G. Mo.; T. As.)

HISTORY

The geographical position of Sicily led almost as a matter of necessity to its historical position, as the meeting-place of the nations, the battle-field of contending races and creeds. For this reason, too, Sicily was never in historic times (nor, it seems, in prehistoric times either) the land of a single nation: her history exists mainly in its relation to the history of other lands. Lying nearer to the mainland of Europe and nearer to Africa than any other of the great Mediterranean islands, Sicily is, next to Spain, the connecting-link between those two quarters of the world. It stands also as a breakwater between the eastern and western divisions of the Mediterranean Sea. In prehistoric times those two divisions were two vast lakes, and Sicily is a surviving fragment of the land which once united the two continents. That Sicily and Africa were once joined we know only from modern scientific research; that Sicily and Italy were once joined is handed down in legend. Sicily then, comparatively near to Africa, but much nearer to Europe, has been a European land, but one specially open to invasion and settlement from Africa. It has been a part of western Europe, but a part which has had specially close relations with eastern Europe. It has stood at various times in close connexion with Greece, Africa and Spain; but its closest connexion has been with Italy. Still the history of Sicily should never be looked on as simply part of the history of Italy. Lying thus between Europe

and Africa, Sicily has been the battle-field of Europe and Africa. That is to say, it has been at two separate periods the battle-field of Aryan and Semitic man. In the later stage of the strife it has been the battle-field of Christendom and Islam. This history Sicily shares with Spain to the west of it and with Cyprus to the east. And with Spain the island has had several direct points of connexion. There was in all likelihood a near kindred between the earliest inhabitants of the two lands. In later times Sicily was ruled by Spanish kings, both alone and in union with other kingdoms. The connexion with Africa has consisted simply in the settlement of conquerors from Africa at two periods, first Phoenician, then Saracen. On the other hand, Sicily has been more than once made the road to African conquest and settlement, both by Sicilian princes and by the Roman masters of Sicily. The connexion with Greece, the most memorable of all, has consisted in the settlement of many colonies from old Greece, which gave the island the most brilliant part of its history, and which made the greater part practically Greek. This Greek element was strengthened at a later time by the long connexion of Sicily with the Eastern, the Greek-speaking, division of the Roman empire. And the influence of Greece on Sicily has been repaid in more than one shape by Sicilian rulers who have at various times held influence and dominion in Greece and elsewhere beyond the Adriatic. The connexion between Sicily and Italy begins with the primitive kindred between some of the oldest elements in each. Then came the contemporary Greek colonization in both lands. Then came the tendency in the dominant powers in southern Italy to make their way into Sicily also. Thus the Roman occupation of Sicily ended the struggle between Greek and Phoenician. Thus the Norman occupation ended the struggle between Greek and Saracen. Of this last came the long connexion between Sicily and southern Italy under several dynasties. Lastly comes the late absorption of Sicily in the modern kingdom of Italy. The result of these various forms of Italian influence has been that all the other tongues of the island have died out before the advance of a peculiar dialect of Italian. In religion again both Islam and the Eastern form of Christianity have given way to its Italian form. Like the British Isles, Sicily came under a Norman dynasty; under Norman rule the intercourse between the two countries was extremely close, and the last time that Sicily was the seat of a separate power it was under British protection.

The Phoenician, whether from old Phoenicia or from Carthage, came from lands which were mere strips of sea-coast with a boundless continent behind them. The Greek of old Hellas came from a land of islands, peninsulas and inland seas. So did the Greek of Asia, though he had, like the Phoenician, a vast continent behind him. In Sicily they all found a strip of sea-coast with an inland region behind; but the strip of sea-coast was not like the broken coast of Greece and Greek Asia, and the inland region was not a boundless continent like Africa or Asia. In Sicily therefore the Greek became more continental, and the Phoenician became more insular. Neither people ever occupied the whole island, nor was either people ever able to spread its dominion over the earlier inhabitants very far inland. Sicily thus remained a world of its own, with interests and disputes of its own, and divided among inhabitants of various nations. The history of the Greeks of Sicily is constantly connected with the history of old Hellas, but it runs a separate course of its own. The Phoenician element ran an opposite course, as the independent Phoenician settlements in Sicily sank into dependencies of Carthage. The entrance of the Romans put an end to all practical independence on the part of either nation. But Roman ascendancy did not affect Greeks and Phoenicians in the same way. Phoenician life gradually died out. But Roman ascendancy nowhere crushed out Greek life where it already existed, and in some ways it strengthened it. Though the Greeks never spread their dominion over the island, they made a peaceful conquest of it. This process was in no way hindered by the Roman dominion.

The question now comes, Who were the original inhabitants of Sicily? The island itself, *Σικελία*, *Sicilia*, plainly takes

its name from the Sicels (*Σικελοί*, *Siculi*), a people whom we find occupying a great part of the island, chiefly east of the river Gela. They appear also in Italy (see *SICULI*), in the toe of the boot, and older history or tradition spoke of them as having in earlier days held a large place in Latium and elsewhere in central Italy. They were believed to have crossed the strait into the island about 300 years before the beginning of the Greek settlements, that is to say in the 11th century B.C. They found in the island a people called Sicans (cf. *Odyssey*, xxiv. 306), who claimed to be *αὐτόχθονες* (i.e. to have originated in the island itself), but whose name, we are told, might pass for a dialectic form of their own, did not the ancient writers expressly affirm them to be a wholly distinct people, akin to the Iberians. Sicans also appear with the Ligurians among the early inhabitants of Italy (*Virg. Aen.* vii. 795, viii. 328, xi. 317, and Servius's note). That the Sicels spoke a tongue closely akin to Latin is plain from several Sichel words which crept into Sicilian Greek, and from the Sicheliot system of weights and measures—utterly unlike anything in old Greece. When the Greek settlements began, the Sicans, we are told, had hardly got beyond the life of villages on hill-tops (*Dion. Hal.* v. 6). Hyccara, on the north coast, is the one exception; it was probably a fishing settlement. The more advanced Sicels had their hill-forts also, but they had learned the advantages of the sea, and they already had settlements on the coast when the Greeks came. As we go on, we hear of both Sichel and Sican towns;¹ but we may suspect that any approach to true city life was owing to Greek influences. Neither people grew into any form of national unity. They were therefore partly subdued, partly assimilated, without much effort.

The investigations of Professor Orsi, director of the museum at Syracuse, have thrown much light on the primitive peoples of south-eastern Sicily. Of palaeolithic man hardly any traces are to be found; but, though western Sicily has been comparatively little explored, and the results hardly published at all, in several localities neolithic remains, attributable to the Sicani, have been discovered. The later Siculi do not appear to be a distinct race (cf. P. Orsi in *Notizie degli scavi*, 1898, 223), and probably both are branches of the Libyco-Iberian stock. Whereas other remains attributable to their villages or settlements are rare, their rock-hewn tombs are found by the thousand in the limestone cliffs of south-eastern Sicily. Those of the earliest period, the lower limit of which is put about 1500 B.C., are aeneolithic, metal being, however, rare and only found in the form of small ornaments; pottery with linear decoration is abundant. The second period (1500–1000 B.C.) shows a great increase in the use of bronze, and the introduction of gold and silver, and of imported Mycenaean vases. The chief cemeteries of this period have been found on Plemmyrium, the promontory south of Syracuse, at Cozzo Pantano, at Thapsus, at Pantalica near Palazzolo, at Cassibile, south of Syracuse, and at Molinello near Augusta. The third period (1000–500 B.C.) in its first phase (1000–700) shows a continual increase of the introduction of objects of Greek origin; the pottery is at first imported geometric, and then vases of local imitation appear. Typical cemeteries are those of Monte Finocchito near Noto, of Noto itself, of Pantalica and of Leontini. In the second phase (700–500 B.C.), sometimes called the fourth period, proto-Corinthian and Attic black figured vases are sometimes, though rarely, found, while local geometric pottery develops considerably. But the form of the tombs always remains the same, a small low chamber hewn in the rock, with a rectangular opening about 2 by 2½ ft., out of which open other chambers, each with its separate doorway; and inhumation is adopted without exception, whereas in a Greek necropolis a low percentage of cases of

¹ Leontini, Megara, Naxos, Syracuse, Zancle are all recorded as sites where the Sichel gave way to the Greek (in regard to Syracuse [*q.v.*] this has recently been proved to be true), while many other towns remained Sichel longer, among them Abacaenum, Agrigum, Assorus, Centuripae, Cephaloedium, Engyum, Hadranum, Halaesa, Henna, Herbessus, Herbata, Hybla Galeatis, Inessa, Kale Akte, Menaenum, Morgantina. The sites of several of these towns are doubtful.

cremation is always present. Typical cemeteries of this period have been found at Licodia Eubea, Ragusa and Grammichele. After the failure of Ducetius to re-establish the Sicel nationality, Greek civilization triumphed over that of the Sicels entirely, and it has not yet been possible to trace the survivals of the latter. See Orsi in *Römische Mitteilungen*, 1898, 305 sqq., and *Atti del Congresso Internazionale di Scienze Storiche* (Rome, April 1903); also *Archeologia* (Rome, 1904, 167-191).

In the north-west corner of the island we find a small territory occupied by a people who seem to have made much greater advances towards civilized life. The Elymi were a people of uncertain origin, but they claimed a mixed descent, partly Trojan, partly Greek. Thucydides, however, unhesitatingly reckons them among barbarians. They had considerable towns, as Segesta and Eryx, and the history, as well as the remains, of Segesta, shows that Greek influences prevailed among them very early, while at Eryx Phoenician influence was stronger.

But, as we have already seen, the Greeks were not the first colonizing people who were drawn to the great island. As in Cyprus and in the islands of the Aegean, the Phoenicians were before them. And it is from this presence of the highest forms of Aryan and of Semitic man that the history of Sicily draws its highest interest. Of Phoenician occupation there are

two, or rather three, marked periods. We must always remember that Carthage—the new city—was one of the latest of Phoenician foundations, and that the days of the Carthaginian dominion show us only the latest form of Phoenician life. Phoenician settlement in Sicily began before Carthage became great, perhaps before Carthage came into being. A crowd of small settlements from the old Phoenicia, settlements for trade rather than for dominion, factories rather than colonies, grew up on promontories and small islands all round the coast (Thuc. vi. 2). These were unable to withstand the Greek settlers, and the Phoenicians of Sicily withdrew step by step to form three considerable towns in the north-west corner of the island near to the Elymi, on whose alliance they relied, and at the shortest distance by sea from Carthage—Motya, Solous or Soluntum, and Panormus (see PALERMO).

Our earlier notices of Sicily, of Sicels and Sicans, in the Homeric poems and elsewhere, are vague and legendary. Both races appear as given to the buying and selling of slaves (*Od.* xx. 383, xxiv. 21). The intimate connexion between old Hellas and Sicily begins with the foundation of the Sicilian Naxos by Chalcidians of Euboea under Theocles, which is assigned to 735 B.C. (Thuc. v. 3-5). The site, a low promontory on the east coast, immediately below the height of Tauromenium, marks an age which had advanced beyond the hill-fortress and which thoroughly valued the sea. The next year Corinth began her system of settlement in the west: Corcyra, the path to Sicily, and Syracuse on the Sicilian coast were planted as parts of one enterprise. From this time, for about 150 years, Greek settlement in the island, with some intervals, goes steadily on. Both Ionian and Dorian colonies were planted, both from the older Greek lands and from the older Sicilian settlements. The east coast, nearest to Greece and richest in good harbours, was occupied first. Here, between Naxos and Syracuse, arose the Ionian cities of Leontini and Catana (728 B.C.), and the Dorian Megara Hyblaea (726 B.C.). Settlement on the south-western coast began about 688 B.C. with the joint Cretan and Rhodian settlement of Gela, and went on in the foundation of Selinus (the most distant Greek city on this side), of Camarina, and in 582 B.C. of the Geloan settlement of Acragas (Agrigentum, Girgenti), planted on a high hill, a little way from the sea, which became the second city of Hellenic Sicily. On the north coast the Ionian Himera (founded in 648 B.C.) was the only Greek city in Sicily itself, but the Cnidians founded Lipara in the Aeolian Islands. At the north-east corner, opposite to Italy, and commanding the strait, arose Zancle, a city of uncertain date (first quarter of the 7th century B.C.) and mixed origin, better known as Messana (Messene, Messina).

Thus nearly all the east coast of Sicily, a great part of the south coast, and a much smaller part of the north, passed into

the hands of Greek settlers—Sicelioti (*Σικελιώται*), as distinguished from the native Sicels. This was one of the greatest advances ever made by the Greek people. The Greek element began to be predominant in the island. Among the earlier inhabitants the Sicels were already becoming adopted Greeks. Many of them gradually sank into a not wholly unwilling subjection as cultivators of the soil under Greek masters. But there were also independent Sicel towns in the interior, and there was a strong religious intercommunion between the two races. Sicel Henna (Enna, Castrogiovanni) is the special seat of the worship of Demeter and her daughter.

The Phoenicians, now shut up in one corner of the island, with Selinus on one side and Himera on the other founded right in their teeth, are bitter enemies; but the time of their renewed greatness under the headship of Carthage ^{Prosperous Greek period.} has not yet come. The 7th century B.C. and the early part of the 6th were a time in which the Greek cities of Sicily had their full share in the general prosperity of the Greek colonies everywhere. For a while they outstripped the cities of old Greece. Their political constitutions were aristocratic; that is, the franchise was confined to the descendants of the original settlers, round whom an excluded body (*δημος* or *plebs*) was often growing up. The ancient kingship was perhaps kept on or renewed in some of the Siceliot and Italiot towns; but it is more certain that civil dissensions led very early to the rise of tyrants. The most famous if not the first¹ is Phalaris (*q.v.*) of Acragas (Agrigentum), whose exact date is uncertain, whose letters are now cast aside, and whose brazen bull has been called in question, but who clearly rose to power very soon after the foundation of Acragas. Under his rule the city at once sprang to the first place in Sicily, and he was the first Siceliot ruler who held dominion over two Greek cities, Acragas and Himera. This time of prosperity was also a time of intellectual progress. To say nothing of lawgivers like Charondas, the line of Siceliot poets began early, and the circumstances of the island, the adoption of many of its local traditions and beliefs—perhaps a certain intermingling of native blood—gave the intellectual life of Sicily a character in some things distinct from that of old Hellas. Stesichorus of Himera (*c.* 632-556 B.C.) holds a great place among the lyric poets of Greece, and some place in the political history of Sicily as the opponent of Phalaris. The architecture and sculpture of this age have also left some of their most remarkable monuments among the Greek cities of Sicily. The remains of the old temples of Selinus, with their archaic metopes, attributed to the 6th century B.C., show us the Doric style in its earlier state. In this period, too, begins the fine series of Sicilian coins (see NUMISMATICS: *Sicily*).

This first period of Sicilian history lasts as long as Sicily remains untouched from any non-Hellenic quarter outside, and as long as the Greek cities in Sicily remain as a rule independent of one another. A change begins in the 6th century ^{Growth of tyrannies.} and is accomplished early in the 5th. The Phoenician settlements in Sicily become dependent on Carthage, whose growing power begins to be dangerous to the Greeks of Sicily. Meanwhile the growth of tyrannies in the Greek cities was beginning to group several towns together under a single master, and thus to increase the greatness of particular cities at the expense of their freedom. Thus Thero of Acragas (488-472), who bears a good character there, acquired also, like Phalaris, the rule of Himera. One such power held dominion both in Italy and Sicily. Anaxilaus of Rhegium, by a long and strange tale of treachery, occupied Zancle and changed its name to Messana. But the greatest of the Siceliot powers, that of the Deinomenid dynasty, began at Gela in 505, and was in 485 translated by Gelo (*q.v.*) to Syracuse. That city now ^{Gelo.} became the centre of a greater dominion over both Greeks and Sicels than the island had ever before seen. But Gelo, like several later tyrants of Syracuse, takes his place—and it is the redeeming point in the position of all of them—as

¹ Panaetius of Leontini (608 B.C.) is said to have been the earliest tyrant in Sicily.

the champion of Hellas against the barbarian. The great double invasion of 480 B.C. was planned in concert by the barbarians of the East and the West (Diod. xi. 1; schol. on Pind., *Pyth.* i. 146; Grote v. 294). While the Persians threatened old Greece, Carthage threatened the Greeks of Sicily. There were Siceliot who played the part of the Medizers in Greece: Selinus was on the side of Carthage, and the coming of Hamilcar was immediately brought about by a tyrant of Himera driven out by Thero. But the united power of Gelo and Thero, whose daughter Damarete Gelo had married, crushed the invaders in the great battle of Himera, won, men said, on the same day as Salamis, and the victors of both were coupled as the joint deliverers of Hellas (Herod. vii. 165-167; Diod. xx. 20-25; Pind. *Pyth.* i. 147-156; Simonides, fr. 42; Polyaeus i. 27). But, while the victory of Salamis was followed by a long war with Persia, the peace which was now granted to Carthage stayed in force for seventy years. Gelo was followed by his brother Hiero (478-467), the

Hiero I.

special subject of the songs of Pindar. Acragas meanwhile flourished under Thero; but a war between him and Hiero led to slaughter and new settlement at Himera. These transplanting from city to city began under Gelo and went on under Hiero (*q.v.*). They made speakers in old Greece (Thuc. vi. 17) contrast the permanence of habitation there with the constant changes in Sicily.

None of these tyrannies was long-lived. The power of Thero fell to pieces under his son Thrasydaeus. When the power of Hiero passed in 467 B.C. to his brother Thrasybulus the freedom of Syracuse was won by a combined movement of Greeks and Sicels, and the Greek cities gradually settled down as they had been before the tyrannies, only with a change to democracy in their constitutions. The mercenaries who had received citizenship from the tyrants were settled at Messana. About fifty years of great prosperity followed. Art, science, poetry had all been encouraged by the tyrants. To these was added the special growth of freedom—the art of public speaking, in which the Sicilian Greeks became especially proficient, Corax being the founder of the rhetorical school of Sicily. Epicharmus (540-450), carried as a babe to Sicily, is a link between native Siceliot and the stranger's invited by Hiero; as the founder of the local Sicilian comedy, he ranks among Siceliot. After him Sophron of Syracuse gave the Sicilian *mimes* a place among the forms of Greek poetry. But the intellect of free Sicily struck out higher paths. Empedocles of Acragas is best known from the legends of his miracles and of his death in the fires of Aetna; but he was not the less philosopher, poet and physician, besides his political career. Gorgias (*q.v.*) of Leontini had a still more direct influence on Greek culture, as father of the technical schools of rhetoric throughout Greece. Architecture too advanced, and the Doric style gradually lost somewhat of its ancient massiveness. The temple at Syracuse, which is now the metropolitan church, belongs to the earlier days of this time. It is followed by the later temples at Selinus, among them the temple of Apollo, which is said to have been the greatest in Sicily, and by the wonderful series at Acragas (see AGRIGENTUM).

During this time of prosperity there was no dread of Carthaginian inroads. Diodorus's account of a war between Segesta and Lilybaeum is open to considerable suspicion. We have, on the other hand, Pausanias's evidence for the existence in his day at Olympia of statues offered by Acragas out of spoil won from Motya, assigned to Calamis, an artist of this period (Freeman ii. 552), and the evidence of contemporary

inscriptions (1) for a Selinuntine victory over some unknown enemy (possibly over Motya also), (2) for dealings between Athens and Segesta with reference to Halicyae, a Sican town. The latter is important as being the first appearance of Athens in Sicily. As early as 480 (Freeman iii. 8) indeed Themistocles seems to have been looking westward. Far more important are our notices of the earlier inhabitants. For now comes the great Sicel movement under Ducetius, who, between force and persuasion, came nearer towards uniting his people into one body than had ever been done before. From his native hill-top of Menae, rising above the lake dedicated to

the Palici, the native deities whom Sicels and Greeks alike honoured, he brought down his people to the new city of Palicae in the plain. His power grew, and Acragas could withstand him only by the help of Syracuse. Alternately victorious and defeated, spared by the Syracusans on whose mercy he cast himself as a suppliant (451), sent to be safe at Corinth, he came back to Sicily only to form greater plans than before. War between Acragas and Syracuse, which arose on account of his return, enabled him to carry out his schemes, and, with the help of another Sicel prince of Herbita, who bore the Greek name of Archonides, he founded Kale Akte on the northern coast. But his work was cut short by his death in 440; the hope of the Sicel people now lay in assimilation to their Hellenic neighbours. Ducetius's own foundation of Kale Akte lived on, and we presently hear of Sicel towns under kings and tyrants, all marking an approach to Greek life. Roughly speaking, while the Sicels of the plain country on the east coast became subject to Syracuse, most of those in other parts of the island remained independent. Of the Sicans we hear less; but Hyccara in the north-west was an independent Sican town on bad terms with Segesta. On the whole, setting aside the impassable barrier between Greek and Phoenician, other distinctions of race within the island were breaking down through the spread of the Hellenic element, but among the Greek cities themselves the distinction between the Dorian and the Ionian or Chalcidian settlements was still keenly felt.

Up to this time the Italiot and Siceliot Greeks have formed part of the general Greek world, while within that world they have formed a world of their own, and Sicily has again formed a world of its own within that. Wars and conquests between Greeks and Greeks, especially on the part of Syracuse, though not wanting, have been on the whole less constant than in old Greece. It is even possible to appeal to a local Sicilian patriotism (Thuc. vi. 64, 74). Presently this state of Sicilian isolation was broken in upon by the great Peloponnesian War. The Siceliot cities were drawn into alliance with one side or the other, till the main interest of Greek history gathers for a while round the Athenian attack on Syracuse. At the very beginning of the war the Lacedaemonians looked for help from the Dorian Siceliot. But the first active intervention came from the other side. Conquest in Sicily was a favourite dream at Athens (see PELOPONNESIAN WAR). But it was only in 427 an opportunity for Athenian interference was found in a quarrel between Syracuse and Leontini and their allies. Leontini craved help from Athens on the ground of Ionian kindred. Her envoy was Gorgias; his peculiar style of rhetoric was now first heard in old Greece (Diod. xii. 53, 54), and his pleadings were successful. For several years from this time (427-422) Athens plays a part, chiefly unsuccessful, in Sicilian affairs. But the particular events are of little importance, except as leading the way to the greater events that follow.

The far more memorable interference of Athens in Sicilian affairs in the year 415 was partly in answer to the cry of the exiles of Leontini, partly to a quite distinct appeal from the Elymian Segesta. That city, an ally of Athens, asked for Athenian help against its Greek neighbour Selinus. In a dispute, partly about boundaries, partly about the right of intermarriage between the Hellenic and the Hellenizing city, Segesta was hard pressed. She vainly asked for help at Acragas—some say at Syracuse (Diod. xii. 82)—and even at Carthage. The last appeal was to Athens.

The details of the great Athenian expedition (415-413) belong partly to the political history of Athens (*q.v.*), partly to that of Syracuse (*q.v.*). But its results make it a marked epoch in Sicilian history, and the Athenian plans, if successful, would have changed the whole face of the West. If the later stages of the struggle were remarkable for the vast number of Greek cities engaged on both sides, and for the strange inversion of relations among them on which Thucydides (vii. 57, 58) comments, the whole war was yet more remarkable for the large entrance of the barbarian element into the Athenian reckonings. The war was undertaken on behalf of Segesta;

Interference of Athens.

Athenian expedition.

Condition of Sicels and Sicans.

the Sicels gave Athens valuable help; the greater barbarian powers out of Sicily also came into play. Some help actually came from Etruria. But Carthage was more far-sighted. If Syracuse was an object of jealousy, Athens, succeeding to her dominion, creating a power too nearly alike to her own, would have provoked far greater jealousy. So Athens found no active support save at Naxos and Catana, though Acragas, if she would not help the invaders, at least gave no help to her own rival. But after the Spartan Gylippus came, almost all the other Greek cities of Sicily were on the side of Syracuse. The war is instructive in many ways. It reminds us of the general conditions of Greek seamanship when we find that Corcyra was the meeting-place for the allied fleet, and that Syracuse was reached only by a coasting voyage along the shores of Greek Italy. We are struck also by the low military level of the Sicilian Greeks. The Syracusan heavy-armed are as far below those of Athens as those of Athens are below those of Sparta. The quasi-continental character of Sicily causes Syracuse, with its havens and its island, to be looked on, in comparison with Athens, as a land power (*ἡπειρώται*, Thuc. vii. 21). That is to say, the Siceliot level represents the general Greek level as it stood before the wars in which Athens won and defended her dominion. The Greeks of Sicily had had no such military practice as the Greeks of old Greece; but an able commander could teach both Siceliot soldiers and Siceliot seamen to out-manceuvre Athenians. The main result of the expedition, as regards Sicily, was to bring the island more thoroughly into the thick of Greek affairs. Syracuse, threatened with destruction by Athens, was saved by the zeal of her metropolis Corinth in stirring up the Peloponnesian rivals of Athens to help her, and by the advice of Alcibiades after his withdrawal to Sparta. All chance of Athenian dominion in Sicily or elsewhere in the west came to an end. Syracuse repaid the debt by good service to the Peloponnesian cause, and from that time the mutual influence of Sicily and old Greece is far stronger than in earlier times.

But before the war in old Greece was over, seventy years after the great victory of Gelo (410), the Greeks of Sicily had to undergo barbarian invasion on a vaster scale than ever. The disputes between Segesta and Selinus called in these enemies also. Carthage, after a long period of abstention from intervention in Sicilian affairs, and the observance of a wise neutrality during the war between Athens and Syracuse, stepped in as the ally of Segesta, the enemy of her old ally Selinus. Her leader was Hannibal, grandson and avenger of the Hamilcar who had died at Himera. In 409, at the head of a vast mercenary host, he sailed to Sicily, attacked Selinus (*q.v.*), and stormed the town after a murderous assault of nine days. Thence he went to Himera, with the object of avenging his grandfather. By this time the other Greek cities were stirred to help, while Sicels and Sicans joined Hannibal. At last Himera was stormed, and 3000 of its citizens were solemnly slaughtered on the spot where Hamilcar had died. Hannibal then returned to Carthage after an absence of three months only. The Phoenician possessions in Sicily now stretched across the island from Himera to Selinus. The next victim was Acragas, against which another expedition sailed in 406 under Hannibal and Himilco; the town was sacked and the walls destroyed.

Meanwhile the revolutions of Syracuse affected the history of Sicily and of the whole Greek world. Dionysius (*q.v.*) the tyrant began his reign of thirty-eight years in the first months of 405. Almost at the same moment, the new Carthaginian commander, Himilco, attacked Gela and Camarina. Dionysius, coming to the help of Gela, was defeated, and was charged (no doubt with good ground) with treachery. He now made the mass of the people of both towns find shelter at Syracuse. But now a peace, no doubt arranged at Gela, was formally concluded (Freeman iii. 587). Carthage was confirmed in her possession of Selinus, Himera and Acragas, with some Sican districts which had opposed her. The people of Gela and Camarina were allowed to occupy their unwallied towns as tributaries of Carthage. Leontini, latterly a Syracusan fort, as

well as Messana and all the Sicels, were declared independent, while Dionysius was acknowledged as master of Syracuse (Diodorus xiii. 114). No war was ever more grievous to freedom and civilization. More than half Sicily was now under barbarian dominion; several of its noblest cities had perished, and a tyrant was established in the greatest. The 5th century B. C., after its central years of freedom and prosperity, ended in far deeper darkness than it had begun. The minuter account of Dionysius belongs to Syracusan history; but his position, one unlike anything that had been before seen in Sicily or elsewhere in Hellas, forms an epoch in the history of Europe. His only bright side is his championship of Hellas against the Phoenician, and this is balanced by his settlements of barbarian mercenaries in several Greek cities. Towards the native races his policy varied according to momentary interests; but on the whole his reign tended to bring the Sicels more and more within the Greek pale. His dominion is Italian as well as Sicilian; his influence, as an ally of Sparta, is important in old Greece; while, as a hirer of mercenaries everywhere, he had wider relations than any earlier Greek with the nations of western Europe. He further opened new fields for Greek settlement on both sides of the Adriatic. In short, under him Sicily became for the first time the seat of a great European power, while Syracuse, as its head, became the greatest of European cities. His reign was unusually long for a Greek tyrant, and his career furnished a model for other rulers and invaders of Sicily. With him in truth begins that wider range of Greek warfare, policy and dominion which the Macedonian kingdoms carry on.

The reign of Dionysius (405-367) is divided into marked periods by four wars with Carthage, in 398-397, 392, 383-378 and 368. Before the first war his home power was all but overthrown; he was besieged in Syracuse itself in 403; but he lived through the storm, and extended his dominion over Naxos, Catana and Leontini. All three perished as Greek cities. Catana was the first Siceliot city to receive a settlement of Campanian mercenaries, while others settled in non-Hellenic Entella. Naxos was settled by Sicels; Leontini was again merged in Syracuse. Now begin the dealings of Dionysius with Italy, where the Rhegines, kinsmen of Naxos and Catana, planned a fruitless attack on him in common with Messana. He then sought a wife at Rhegium, but was refused with scorn, while Locri gladly gave him Doris. The two cities afterwards fared accordingly. In the first war with Carthage the Greek cities under Carthaginian dominion or dependence helped him; so did Sicans and Sicels, which last had among them some stirring leaders; Elymian Segesta clave to Carthage. Dionysius took the Phoenician stronghold of Motye; but Himilco recovered it, destroyed Messana, founded the hill-town of Tauromenium above Naxos for Sicels who had joined him, defeated the fleet of Dionysius off Catana and besieged Syracuse. Between invasion and home discontent, the tyrant was all but lost; but the Spartan Pharacidas stood his friend; the Carthaginians again suffered from pestilence in the marshes of Lysimelia; and after a masterly combined attack by land and sea by Dionysius Himilco went away utterly defeated, taking with him his Carthaginian troops and forsaking his allies. Gela, Camarina, Himera, Selinus, Acragas itself, became subject allies of Dionysius. The Carthaginian dominion was cut down to what it had been before Hannibal's invasion. Dionysius then planted mercenaries at Leontini, conquered some Sicel towns, Henna among them, and made alliances with others. He restored Messana, peopling it with motley settlers, among whom were some of the old Messenians from Peloponnesus. But the Spartan masters of the old Messenian land grudged this possible beginning of a new Messenian power. Dionysius therefore moved his Messenians to a point on the north coast, where they founded Tyndaris. He clearly had a special eye to that region. He took the Sicel Cephaloedium (Cefalù), and even the old Phoenician border-fortress of Solous was betrayed to him. He beat back a Rhegine expedition; but his advance was checked by a failure to take the new Sicel settlement of Tauromenium. His enemies of all races now declared themselves.

His war with Carthage.

Many of the Sicels forsook him; Acragas declared herself independent; Carthage herself again took the field.

The Carthaginian war of 392-391 was not very memorable. Both sides failed in their chief enterprises, and the main interest of the story comes from the glimpses which we get of the Sicel states. Most of them joined the Carthaginian leader Mago; but he was successfully withstood at Agyrium by Agyris, the ally of Dionysius, who is described as a tyrant second in power to Dionysius himself. This way of speaking would imply that Agyrium had so far advanced in Greek ways as to run the usual course of a Greek commonwealth. The two tyrants drove Carthage to a peace by which she abandoned all her Sicel allies to Dionysius. This time he took Tauromenium and settled it with his mercenaries. For new colonists of this kind the established communities of all races were making way. Former transportations had been movements of Greeks from one Greek site to another. Now all races are confounded.

Dionysius, now free from Phoenician warfare, gave his mind to enterprises which raised his power to its greatest height. In the years 390-387 he warred against the Italic cities in alliance with their Lucanian enemies. Rhegium, Croton, the whole toe of the boot, were conquered. Their lands were given to Locri; their citizens were taken to Syracuse, sometimes as slaves, sometimes as citizens. The master of the barbarians fell below the lowest Hellenic level when he put the brave Rhegine general Phytton to a lingering death, and in other cases imitated the Carthaginian cruelty of crucifixion. Conqueror of southern Italy, he turned his thoughts yet further, and became the first ruler of Sicily to stretch forth his hands towards the eastern peninsula. In the Adriatic he helped Hellenic extension, desiring no doubt to secure the important trade route into central Europe. He planted directly and indirectly some settlements in Apulia, while Syracusan exiles founded the more famous Ancona. He helped the Parians in their settlements of Issa and Pharos; he took into his pay Illyrian warriors with Greek arms, and helped the Molossian Alcetas to win back part of his kingdom. He was even charged with plotting with his Epirot ally to plunder Delphi. This even Sparta would not endure; Dionysius had to content himself with sending a fleet along the west coast of Italy, to carry off the wealth of the great temple of Caere.

In old Greece men now said that the Greek folk was hemmed in between the barbarian Artaxerxes on the one side and Dionysius, master and planter of barbarians, on the other. These feelings found expression when Dionysius sent his embassy to the Olympic games of 384, and when Lysias bade Greece rise against both its oppressors. Dionysius vented his wrath on those who were nearest to him, banishing many, among them his brother Leptines and his earliest friend Philistus, and putting many to death. He was also once more stirred up to play the part of a Hellenic champion in yet another Punic war.

In this war (383-378) Dionysius seems for once to have had his head turned by a first success. His demand that Carthage should altogether withdraw from Sicily was met by a crushing defeat. Then came a treaty by which Carthage kept Selinus and part of the land of Acragas. The Halycus became the boundary. Dionysius had also to pay 1000 talents, which caused him to be spoken of as becoming tributary to the barbarians. In the last years of his reign we hear dimly of both Syracusan and Carthaginian operations in southern Italy. He also gave help to Sparta against Thebes, sending Gaulish and Iberian mercenaries to take part in Greek warfare. His last war with Carthage, which began with an invasion of western Sicily, and which was going on at his death in 367 B.C., was ended by a peace by which the Halycus remained the boundary.

The tyranny of Dionysius fell, as usual, in the second generation; but it was kept up for ten years after his death by the energy of Philistus, now minister of his son Dionysius the Younger. It fell with the coming back of the exile Dion in 357. The tyranny had lasted so long that it was less easy than at the overthrow of the elder tyrants to fall back on an earlier state of things. It had been a time of frightful changes throughout Sicily, full of breaking

up of old landmarks, of confusion of races, and of movements of inhabitants. But it also saw the foundation of new cities. Besides Tyndaris and Tauromenium, the foundation of Halaca marks another step in Sicel progress towards Hellenism, while the Carthaginians founded their strong town and fortress of Lilybaeum in place of Motya. Among these changes the most marked is the settlement of Campanian mercenaries in Greek and Sicel towns. Yet they too could be brought under Greek influences; they were distant kinsfolk of the Sicels, and the forerunners of Rome. They mark one stage of migration from Italy into Sicily.

The reign of Dionysius was less brilliant in the way of art and literature than that of Hiero. Yet Dionysius himself sought fame as a poet, and his success at Athens shows that his compositions did not deserve the full scorn of his enemies. The dithyrambic poet Philoxenus, by birth of Cythera, won his fame in Sicily, and other authors of lost poems are mentioned in various Siceliot cities. One of the greatest losses in all Greek history is that of the writings of Philistus (436-356), the Syracusan who had seen the Athenian siege and who died in the warfare between Dion and the younger Dionysius. Through the time of both tyrants, he was, next to the actual rulers, the first man in Sicily; but of his record of his own times we have only what filters through the recasting of Diodorus. But the most remarkable intellectual movement in Sicily at this time was the influence of the Pythagorean philosophy, which still lived on in southern Italy. It led, through Dion, to the several visits of Plato to Sicily under both the elder and the younger Dionysius.

The time following the Dionysian tyranny was at Syracuse a time full of the most stirring local and personal interest, under her two deliverers Dion and Timoleon. It is less easy to make out the exact effect on the rest of Sicily of the three years' career of Dion. Between the death of Dion in 354 and the coming of Timoleon in 344 we hear of a time of confusion in which Hellenic life seemed likely to die out. The cities, Greek and Sicel, were occupied by tyrants. The work of Timoleon (*q.v.*), whose headquarters were first at Tauromenium, then at Hadranum, was threefold—the immediate deliverance of Syracuse, the restoration of Sicily in general to freedom and Greek life, and the defence of the Greek cities against Carthage. The great victory of the Crimissus in 339 led to a peace with Carthage with the old frontier; but all Greek cities were to be free, and Carthage was to give no help to any tyrant. Timoleon drove out all the tyrants, and it specially marks the fusion of the two races that the people of the Sicel Agyrium were admitted to the citizenship of free Syracuse. From some towns he drove out the Campanians, and he largely invited Greek settlement, especially from the Italic towns, which were hard pressed by the Bruttians. The Corinthian deliverer gave, not only Syracuse, but all Greek Sicily, a new lease of life, though a short one.

We have unluckily no intelligible account of Sicily during the twenty years after the death of Timoleon (337-317). His deliverance is said to have been followed by great immediate prosperity, but wars and dissensions very soon began again. The Carthaginians played off one city and party against another, and Agathocles,¹ following the same policy, became in 317, by treachery and massacre, undisputed tyrant of Syracuse, and spread his dominion over many other cities. Acragas, strengthened by Syracusan exiles, now stands out again as the rival of Syracuse. The Carthaginian Hamilcar won many Greek cities to the Punic alliance. Agathocles, however, with Syracuse blockaded by a Carthaginian fleet, formed the bold idea of carrying the war into Africa.

For more than three years (310-307) each side carried on warfare in the land of the other. Carthage was hard pressed by Agathocles, while Syracuse was no less hard pressed by Hamilcar. The force with which Agathocles invaded Africa was far from being wholly Greek; but it was representatively European. Gauls, Samnites, Tyrrhenians, fought for him, while mercenary Greeks and Syracusan exiles fought for Carthage. He won many battles and towns; he quelled mutinies of his own

¹ See Tillyard, *Agathocles* (1908).

troops; by inviting and murdering Ophellas, lord of Cyrene, he doubled his army and brought Carthage near to despair. Meanwhile Syracuse, all but lost, had driven back Hamilcar, and had taken him prisoner in an unsuccessful attack on Euryelus, and slain him when he came again with the help of the Syracusan exile Deinocrates. Meanwhile Acragas, deeming Agathocles and the barbarians alike weakened, proclaimed freedom for the Sicilian cities under her own headship. Many towns, both Greek and Sikel, joined the confederacy. It has now become impossible to distinguish the two races; Henna and Herbessus are now the fellows of Camarina and Leontini. But the hopes of Acragas perished when Agathocles came back from Africa, landed at Selinus, and marched to Syracuse, taking one town after another. A new scheme of Sicilian union was taken up by Deinocrates, which cut short his dominion. But he now relieved Syracuse from the Carthaginian blockade; his mercenaries gained a victory over Acragas; and he sailed again for Africa, where fortune had turned against his son Archagathus, as it now did against himself. He left his sons and his army to death, bondage or Carthaginian service, and came back to Sicily almost alone. Yet he could still gather a force which enabled him to seize Segesta, to slay or enslave the whole population, and to settle the city with new inhabitants. This change amounts to the extinction of one of the elements in the old population of Sicily. We hear no more of Elymi; indeed Segesta has been practically Greek long before this. Deinocrates and Agathocles came to a kind of partnership in 304, and a peace with Carthage, with the old boundary, secured Agathocles in the possession of Syracuse and eastern Sicily (301).

At some stage of his African campaigns Agathocles had taken the title of king. Earlier tyrants were well pleased to be spoken of as kings; but no earlier rulers of Sicily put either their heads or their names on the coin. Agathocles now put his name, first without, and then with, the kingly title, though never his own likeness—Hiero II. was the first to do this. This was in imitation of the Macedonian leaders who divided the dominion of Alexander. The relations between the eastern and western Greek worlds are drawing closer. Agathocles in his old age took a wife of the house of Ptolemy; he gave his daughter Lanassa to Pyrrhus, and established his power east of Hadria, as the first Sicilian ruler of Corcyra. Alike more daring and more cruel than any ruler before him, he made the island the seat of a greater power than any of them.

On the death of Agathocles tyrants sprang up in various cities. Acragas, under its king Phintias, won back for the moment somewhat of its old greatness. By a new depopulation of Gela, he founded the youngest of Siceliot cities, Phintias, by the mouth of the southern Himeras. And Hellas was cut short by the seizure

of Messana by the disbanded Campanian mercenaries of Agathocles (c. 282), who proclaimed themselves a new people in a new city by the name of Mamertines, children of Mamers or Mars. Messana became an Italian town—"Mamertina civitas."

The Campanian occupation of Messana is the first of the chain of events which led to the Roman dominion in Sicily. As yet Rome has hardly been mentioned in Sicilian story.

Pyrrhus. The Mamertine settlement, the war with Pyrrhus, bring us on quickly. Pyrrhus (*q.v.*) came as the champion of the western Greeks against all barbarians, whether Romans in Italy or Carthaginians in Sicily. His Sicilian war (278–276)¹ was a mere interlude between the two acts of his war with Rome. As son-in-law of Agathocles, he claimed to be specially king of Sicily, and he held the Sicilian conquest of Corcyra as the dowry of Lanassa. With such a deliverer, deliverance meant submission. Pyrrhus is said to have dreamed of kingdoms of Sicily and of Italy for his two sons, the grandsons of Agathocles, and he himself reigned for two years in Sicily as a king who came to be no less hated than the tyrants. Still as Hellenic champion in Sicily he has no peer.

The Greek king, on his way back to fight for Tarentum against Rome, had to cut his way through Carthaginians and Mamertines

¹ For the ensuing years cf. *ROME: History*, II. "The Republic."

in Roman alliance. His saying that he left Sicily as a wrestling-ground for Romans and Carthaginians was the very truth of the matter. Very soon came the first war between Rome and Carthage (the "First Punic War"). It mattered much, now that Sicily was to have a barbarian master, whether that master should be the kindred barbarian of Europe or the barbarian of Asia transplanted to the shore of Africa.

Sicily in truth never had a more hopeful champion than Hiero II. of Syracuse. The established rule of Carthage in western Sicily was now something that could well be endured alongside of the robber commonwealth at **Hiero II.** Messana. The dominion of the freebooters was spreading. Besides the whole north-eastern corner of the island, it reached inland to Agyrium and Centoripa. The Mamertines leagued with other Campanian freebooters who had forsaken the service of Rome to establish themselves at Rhegium. But a new Syracusan power was growing up to meet them. Hiero, claiming descent from Gelo, pressed the Mamertines hard. He all but drove them to the surrender of Messana; he even helped Rome to chastise her own rebels at Rhegium. The wrestling-ground was thus opened for the two barbarian commonwealths. Carthaginian troops held the Messanian citadel against Hiero, while another party in Messana craved the help of the head of Italy. Rome, chastiser of the freebooters of Rhegium, saw Italian brethren in the freebooters of Messana.

The exploits of Hiero had already won him the kingly title (270) at Syracuse, and he was the representative of Hellenic life and independence throughout the island. Partly in this character, partly as direct sovereign, he was virtual ruler of a large part of eastern Sicily. But he could not aspire to the dominion of earlier Syracusan rulers. The advance of Rome after the retreat of Pyrrhus kept the new king from all hope of their Italian position. And presently the new kingdom exchanged independence for safety. When Rome entered Sicily as the ally of the Mamertines, Hiero became the ally of Carthage. But in the second year of the war (263) he found it needful to change sides. His alliance with Rome marks a great epoch in the history of the Greek nation. The kingdom of Hiero was the first-fruits out of Italy of the system by which alliance with Rome grew into subjection to Rome. He was the first of Rome's kingly vassals. His only burthen was to give help to the Roman side in war; within his kingdom he was free, and his dominions flourished as no part of Sicily had flourished since the days of Timoleon.

During the twenty-three years of the First Punic War (264–241) the rest of the island suffered greatly. The war for Sicily was fought in and round Sicily, and the Sicilian cities were taken and retaken by the contending powers (see PUNIC WARS). The highest calling of the Greek had now, in the western lands, passed to the Roman.

By the treaty which ended the war in 241 Carthage ceded to Rome all her possessions in Sicily. As that part of the island which kept a national Greek government became the first kingdom dependent on Rome, so the share of Carthage became the first Roman province. Messana alone remained an Italian ally of Rome on Sicilian soil.

We have no picture of Sicily in the first period of Roman rule. One hundred and seventy years later, several towns within the original province enjoyed various degrees of freedom, which they had doubtless kept from the beginning. Panormus, Segesta, with Centoripa, Halesa and Halikye, once Sikel but now Hellenized, kept the position of free cities (*liberae et immunes*, Cic. *Verr.* iii. 6). The rest paid tithe to the Roman people as landlord. The province was ruled by a praetor sent yearly from Rome. It formed, as it had even from the Carthaginian period, a closed customs district. Within the Roman province the new state of things called forth much discontent; but Hiero remained the faithful ally of Rome through a long life. On his death (216) and the accession of his grandson Hieronymus, his dynasty was swept away by the last revolution of Greek Syracuse. The result was revolt against Rome, the great siege and capture of the city, the addition of Hiero's kingdom to the

**First
Punic
War.**

**276-210
B.C.**

Roman province. Two towns only, besides Messana, which had taken the Roman side, Tauromenium and Netos, were admitted to the full privileges of Roman alliance. Tauromenium indeed was more highly favoured than Messana. Rome had a right to demand ships of Messana, but not of Tauromenium. Some towns were destroyed; the people of Henna were massacred. Acragas, again held for Carthage, was for four years (214-210) the centre of an active campaign. The story of Acragas ended in plunder, slaughter and slavery; three years later, the story of Agrigentum began.

The reign of Hiero was the last time of independent Greek culture in Sicily. His time marks the growth of a new form of local Sicilian genius. The spread of Hellenic culture among the Sicels had in return made a Greek home for many Sikel beliefs, traditions and customs. Bucolic poetry is the native growth of Sicily; in the hands of Theocritus it grew out of the germs supplied by Epicharmus and Sophron into a distinct and finished form of the art. The poet, himself of Syracuse, went to and fro between the courts of Hiero and Ptolemy Philadelphus; but his poetry is essentially Sicilian. So is that of his successors, both the Syracusan Moschus and Bion of Smyrna, who came to Sicily as to his natural school.

With the incorporation of the kingdom of Hiero into the Roman province independent Sicilian history comes to an end for many ages. In one part of the island the

Sicily Roman.

Roman people stepped into the position of Carthage, in another part into that of King Hiero. The allied cities kept their several terms of alliance; the free cities kept their freedom; elsewhere the land paid to the Roman people, according to the law of Hiero, the tithe which it had paid to Hiero. But, as the tithe was let out to *publicani*, oppression was easy. The praetor, after the occupation of Syracuse, dwelled there in the palace of Hiero, as in the capital of the island. But, as a survival of the earlier state of things, one of his two quaestors was quartered at Eryx, the other being in attendance on himself. Under the supreme dominion of Rome even the unprivileged cities kept their own laws, magistrates and assemblies, provision being made for suits between Romans and Sicilians and between Sicilians of different cities (*Verr.* ii. 16). In Latin the one name *Siculi* takes in all the inhabitants of the island; no distinction is drawn between Greek and Sikel, or even between Greek and Phoenician cities. It is assumed that all *Siculi* are Greeks (*Verr.* ii. 3, 29, 49, 52, 65; iii. 37, 40, 73). Even in Greek, *Σικελοί* is now sometimes used instead of *Σικελιώται*. All the persons spoken of by Cicero have Greek names save—a most speaking exception—Gaius Heius of *Mamertina civitas*. Inscriptions too from Sikel and Phoenician cities are commonly Greek, even when they commemorate men with Phoenician names, coupled perhaps with Greek surnames. The process of Hellenization which had been so long going on had at last made Sicily thoroughly Greek. Roman conquest itself, which everywhere carried a Greek element with it, would help this result. The corn of the fertile island was said even then to feed the Roman people. It was this character of Sicily which led to its one frightful piece of local

Slave revolts.

history. The wars of Rome, and the systematic piracy and kidnapping that followed them, filled the Mediterranean lands with slaves of all nations. Sicily stood out before the rest as the first land to be tilled by slave-gangs, on the estates both of rich natives and of Roman settlers. It became the granary of Rome and the free population naturally degenerated and died out. The slaves were most harshly treated, and even encouraged by their masters to rob. The land was full of disorder, and the praetors shrank from enforcing the law against offenders, many of whom, as Roman knights, might be their own judges. Of these causes came the two great slave-revolts of the second half of the 2nd century B.C. The first lasted from 134 to 132, the time of Tiberius Gracchus and the fall of Numantia. Enna and Tauromenium were the headquarters of the revolt. The second (the centre of which was Triocala, the modern S. Anna, 9 m. N.E. of Sciacca) lasted from 102 to 99, the time of the Cimbric invasion. At other times the power of Rome might have quelled the revolt more speedily.

The slave wars were not the only scourge that fell on Sicily. The pirates troubled the coast, and all other evils were outdone by the three years' government of Verres (73-70 B.C.). Besides the light which the great impeachment throws on the state of the island, his administration seems really to have dealt a lasting blow to its prosperity. The slave wars had not directly touched the great cities; Verres plundered and impoverished everywhere, removing anything of value, especially works of art, that took his fancy, and there is hardly a city that had not to complain of what it suffered at his hands. Another blow was the occupation of Messana by Sextus Pompeius in 43 B.C. He was master of Sicily for seven years, and during this period the corn supply of Rome was seriously affected, while Strabo (vi. 2, 4) attributed to this war the decayed state of several cities. To undo this mischief Augustus planted Roman colonies at Palermo, Syracuse, Tauromenium, Thermae, Tyndaris and Catana. The island thus received another Italian infusion; but, as elsewhere, Latin in no way displaced Greek; it was simply set up alongside of it for certain purposes. Roman tastes now came in; Roman buildings, especially amphitheatres, arose. The Mamertines were Roman citizens, and Netum, Centuripae and Segesta had become Latin, perhaps by a grant of Caesar himself, but in any case before the concession of Latin rights to the rest of Sicily; this was followed by M. Antonius's grant of full citizenship to the whole island. But Sicily never became thoroughly Roman; no roads were constructed, so that not a single Roman milestone has been found in the whole island. In the division of provinces between Augustus and the senate, Sicily fell to the latter. Under the empire it has practically no history. Few emperors visited Sicily; Hadrian was there, as everywhere, in A.D. 126, and ascended Etna, and Julian also (*C.D.* 10). In its provincial state Sicily fell back more than some other provinces. Ausonius could still reckon Catana and fourfold Syracuse ("quadruplices Syracusas") among the noble cities; but Sicily is not, like Gaul, rich in relics of later Roman life, and it is now Egypt rather than Sicily that feeds Rome. The island has no internal history beyond a very characteristic fact, a third revolt of slaves and bandits, which was quelled with difficulty in the days of Gallienus. External history there could be none in the central island, with no frontier open to Germans or Persians. There was a single Frankish attack under Probus (276-282). In the division of Constantine, when the word "province" had lost its meaning, when Italy itself was mapped out into provinces, Sicily became one of these last. Along with Africa, Raetia and western Illyricum, it became part of the Italian praefecture; along with the islands of Sardinia and Corsica, it became part of the Italian diocese. It was now ruled by a *corrector*, afterwards by a consular under the authority of the vicar of the Roman city (*Not. Imp.* 14, 5).

Sicilian history began again when the wandering of the nations planted new powers, not on the frontier of the empire, but at its heart. The powers between which Sicily now passed to and fro were Teutonic powers. The earlier stages of Teutonic advance could not touch Sicily. Alaric thought of a Sicilian expedition, but a storm hindered him. Sicily was to be reached only by a Teutonic power which made its way through Gaul, Spain and Africa. The Vandal now dwelt at Carthage instead of the Canaanite. Gaiseric (429-477) subdued the great islands for which Roman and Phoenician had striven. Along with Sardinia, Corsica and the Balearic Isles, Sicily was again a possession of a naval power at Carthage. Gaiseric made a treaty with Odoacer almost like that which ended the First Punic War. He gave up (Victor Vitensis i. 4) the island on condition of a tribute, which was hardly paid by Theodoric. Sicily was now ruled by a Gothic count, and the Goths claimed to have treated the land with special tenderness (*Procopius, Bell. Goth.* iii. 16). The island, like the rest of Theodoric's dominions, was certainly well looked after by the great king and his minister; yet we hear darkly of disaffection to Gothic rule (*Cass. Var.* i. 3). Theodoric gave back Lilybaeum to the Vandal king Thrasamund as the dowry

Later
Roman
rule in
Sicily.

Teutonic
masters.

of his sister Analafrida (Proc. *Bell. Vand.* i. 8). Yet Lilybaeum was a Gothic possession when Belisarius, conqueror of Africa, demanded it in vain as part of the Vandal possessions (Proc. *Bell. Vand.* ii. 5; *Bell. Goth.* i. 3). In the Gothic war Sicily was the first land to be recovered for the empire, and that with the good will of its people (535). Panormus alone was stoutly defended by its Gothic garrison. In 550 Totila took some fortresses, but the great cities all withstood him, and the Goths were driven out the next year.

Sicily was thus won back to the Roman dominion. Belisarius was Pyrrhus and Marcellus in one. For 430 years some part of Sicily, for 282 years the whole of it, again remained a Roman province. To the Gothic count again succeeded, under Justinian, a Roman praetor, in Greek *σπαρτηγός*. That was the official title; we often hear of a *patrician* of Sicily, but patrician (*q.v.*) was in strictness a personal rank. In the later mapping out of the empire into purely military divisions, the *theme* (*θέμα*) of Sicily took in both the island and the nearest peninsula of the mainland, the oldest Italy. The island itself was divided for financial purposes, almost as in the older times, into the two divisions of Syracuse and Lilybaeum. The revolutions of Italy hardly touched a land which looked steadily to the eastern Rome as its head. The Lombard and Frankish masters of the peninsula never fixed themselves in the island. When the Frank took the imperial crown of the west, Sicily still kept its allegiance to the Augustus who reigned at Constantinople, and was only torn away piecemeal from the empire by the next race of conquerors.

This connexion of Sicily with the eastern division of the empire no doubt largely helped to keep up Greek life in the island. This was of course strengthened by union with a power which had already a Greek side, and where the Greek side soon became dominant. Still the connexion with Italy was close, especially the ecclesiastical connexion. Some things tend to make Sicily look less Greek than it really was. The great source of our knowledge of Sicily in the century which followed the reconquest by Belisarius is the *Letters* of Pope Gregory the Great, and they naturally show the most Latin side of things. The merely official use of Latin was, it must be remembered, common to Sicily with Constantinople. Gregory's *Letters* are largely occupied with the affairs of the great Sicilian estates held by the Roman church, as by the churches of Milan and Ravenna. But they deal with many other matters. Saint Paul's visit to Syracuse naturally gave rise to many legends; but the Christian church undoubtedly took early root in Sicily. We hear of Manichaeans (*C.D.* 163); Jews were plentiful, and Gregory causes compensation to be made for the unlawful destruction of synagogues. Many Christian catacombs and Byzantine rock-cut villages, churches and tombs have been explored of recent years. See the comprehensive work by the late J. Führer and V. Schultze, "Die altchristlichen Grabstätte Siziliens" (Berlin, 1907, *Jahrbuch des K.D. archäologischen Instituts*, Ergänzungsheft vii.): and several articles by P. Orsi in the *Notizie degli scavi*, and in *Byzantinische Zeitschrift* (1898, 1; 1899, 613). Of paganism we find no trace, save that pagan slaves, doubtless not natives of the island, were held by Jews (*C.D.* 127). Herein is a contrast between Sicily and Sardinia, where, according to a letter from Gregory to the empress Constantina, wife of the emperor Maurice (594-595), praying for a lightening of taxation in both islands, paganism still lingered (*C.D.* 121). Sicily belonged to the Latin patriarchate; but we already (*C.D.* 103) see glimmerings of the coming disputes between the Eastern and Western Churches. Things were changed when Leo the Isaurian confiscated the Sicilian and Calabrian estates of the Roman Church (Theoph. i. 631).

In the 9th, 10th and 11th centuries the old drama of Sicily was acted again. The island is again disputed between Europe and Asia, transplanted to Africa between Greek and Semitic dwellers on her own soil. Panormus and Syracuse are again the headquarters of races and creeds, of creeds yet more than

of races. The older religious differences were small compared with the strife for life and death between Christendom and Islam. Gregory and Mahomet were contemporaries, and, though Saracen occupation did not begin in Sicily till more than two centuries after Gregory's death, Saracen inroads began much sooner. In 655 (Theoph. i. 532) part of Sicily was plundered, and its inhabitants carried to Damascus. Then came the strange episode of the visit of Constans II. (641-668), the first emperor, it would seem, who had set foot in Sicily since Julian. After a war with the Lombards, after twelve days' plunder of Rome, he came on to Syracuse, where his oppressions led to his murder in 668. Sicily now saw for the first time the setting up of a tyrant in the later sense. Mezetius, commander of the Eastern army of Constans, revolted, but Sicily and Roman Italy kept their allegiance to the new emperor Constantine Pogonatus, who came in person to destroy him. Then came another Saracen inroad from Alexandria, in which Syracuse was sacked (Paul. Diac. v. 13). Towards the end of the 8th century, though Sicily itself was untouched, its patricians and their forces play a part in the affairs of southern Italy as enemies of the Frankish power. Charlemagne himself was believed (Theoph. i. 736) to have designs on Sicily; but, when it came to Saracen invasion, the sympathies of both pope and Caesar lay with the invaded Christian land (*Mon. Car.* 323, 328).

In 813 a peace for ten years was made between the Saracens and the patrician Gregory. A few years after it expired Saracen settlement in the island began. About this time Crete was seized by Spanish adventurers. But the first Saracen settlers in Sicily were the African neighbours of Sicily, and they were called to the work by a home treason. The story has been tricked out with many romantic details (*Chron. Salern.* 60, ap. Pertz, iii. 498; Theoph. Cont. ii. 272; George Cedrenus, ii. 97); but it seems plain that Euphemius or Euthymius of Syracuse, supported by his own citizens, revolted against Michael the Stammerer (820-829), and, when defeated by an imperial army, asked help of Ziyādet Allah, the Aghlabite prince of Kairawān, and offered to hold the island of him. The struggle of 138 years now began. Euphemius, a puppet emperor, was led about by his Saracen allies much as earlier puppet emperors had been led about by Alaric and Ataulf, till he was slain in one of the many sieges. The second Semitic conquest of Sicily began in 827 at Mazzara on the old border of Greek and Phoenician. The advance of the invaders was slow. In two years all that was done was to occupy Mazzara and Mineum—the old Menae of Ducetius—strange points certainly to begin with, and seemingly to destroy Agrigentum, well used to destruction. Attacks on Syracuse failed; so did attacks on Henna—*Castrum Ennae*, now changing into *Castrum Johannis* (perhaps *Καστρο-ύαννη*), Castrogiovanni. The actual gain was small; but the invaders took seizin alike of the coast and of the island.

A far greater conquest followed when new invaders came from Spain and when Theodotus was killed in 830. The next year Panormus passed away for ever from Roman, for 230 years from Christian, rule. Syracuse was for fifty years, not only, as of old, the bulwark of Europe, but the bulwark of Christendom. By the conquest of Panormus the Saracens were firmly rooted in the island. It became the seat of the amir or lord of Sicily. We hear dimly of treasonable dealings with them on the part of the *strategos* Alexius, son-in-law of the emperor Theophilus; but we see more clearly that Saracen advance was largely hindered by dissensions between the African and the Spanish settlers. In the end the Moslem conquests in Sicily became an Aghlabite principality owning at best a formal superiority in the princes of Kairawān. With the Saracen occupation begins a new division of the island, which becomes convenient in tracing the progress of Saracen conquest. This is into three valleys, known in later forms of language as Val di Mazzara or Mazza in the N.W., Val di Noto in the S.E. and Val Demone (a name of uncertain origin) in the N.E. (see Amari, *Musulmani in Sicilia*, i. 465). The first Saracen settlement

Early
Saracen
inroads.

Saracen
conquest.

829-1060.

of Val di Mazzara answers roughly to the old Carthaginian possessions. From Panormus the amir or lord of Sicily, Mahommed ibn Abdallah, sent forth his plunderers throughout Sicily and even into southern Italy. There, however, they made no lasting settlements.

The chief work of the next ten years was the conquest of the Val di Noto, but the first great advance was made elsewhere. In 843 the Saracens won the Mamertine city, Messana, and thus stood in the path between Italy and Sicily. Then the work of conquest, as described by the Arabic writers, went on, but slowly. At last, in 859, the very centre of the island, the stronghold of Henna, was taken, and the main part of Val di Noto followed. But the divisions among the Moslems helped the Christians; they won back several towns, and beat off all attacks on Syracuse and Tauromenium. It is strange that the reign of Basil the Macedonian (867), a time of such renewed vigour in the empire, was the time of the greatest of all losses in Sicily. In Italy the imperial frontier largely advanced; in Sicily imperial fleets threatened Panormus. But in 875 the accession of Ibrāhīm ibn Ahmad in Africa changed the face of things. The amir in Sicily, Ja'far ibn Ahmad, received strict orders to act vigorously against the eastern towns. In 877 began the only successful Semitic siege of Syracuse. The next year the city passed for the first time under the yoke of strangers to the fellowship of Europe.

Thus in fifty-one years the imperial and Christian territory in Sicily was cut down to a few points on or near the eastern coast, to the Val Demone in short without Messana. But between Moslem dissension and Christian valour the struggle had still to be waged for eighty-seven years. Henna had been the chief centre of Christian resistance a generation earlier; its place was now taken by the small fort of Rametta not far from Messina. The Moslems of Sicily were busy in civil wars; Arabs fought against Berbers, both against the African overlord. In 900 Panormus had to be won by a son of Ibrāhīm from Moslem rebels provoked by his father's cruelty. But when Ibrāhīm himself came into Sicily, renewed efforts against the Christians led to the first taking of Tauromenium (908), of Rametta and of other points. The civil war that followed his death, the endless revolutions of Agrigentum, where the weaker side did not scruple to call in Christian help, hindered any real Saracen occupation of eastern Sicily. The emperors never gave up their claims to Sicily or their hopes of recovering it. Besides the struggle with the Christians in the island, there was often direct warfare between the empire and the Saracens; but such warfare was more active in Italy than in Sicily. In 956 a peace or truce was made by the emperor Constantine Porphyrogenitus. A few years later, Otho the Great, the restorer of the Western empire, looked to Sicily as a land to be won back for Christendom. It had not yet wholly passed away; but the day soon came. Strange to say, as Syracuse fell in the reign of Basil the Macedonian, the Saracen occupation was completed in the reign of Nikephoros Phokas (Nicephorus Phocas), the deliverer of Crete. In the year of his accession (963) Tauromenium was taken, and became for a hundred years a Mahommedan possession. Rametta was the last stronghold to fall (965).

Thus in 138 years the Arab did what the Canaanite had never done. The whole island was a Semitic, that is a Mahommedan, possession. Yet the complete Saracen possession of Sicily may seem a thing of a moment. Its first and longest period lasted only 73 years. In that time Mahommedan Sicily was threatened by a Western emperor; the Arabic writers claim

**Recon-
quest by
Eastern
Empire.**

the Saracen army by which Otho II. was beaten back in 982 as a Sicilian army. A mightier enemy was threatening in the East. Basil II. planned the recovery of Sicily in good earnest. In 1027 he sent a great army; but his death stopped their progress before they reached the island. But the great conqueror had left behind him men trained in his school, and eleven years later the eagles of the new Rome again marched to Sicilian victories. The ravages of the Sicilian Saracens in the Greek islands were more frightful than ever, and George Maniaces, the first captain of his time,

was sent to win back the lost land. He too was helped by Saracen dissensions. The amir Abul-afar became a Roman vassal, and, like Alaric of old, became *magister militum* in the Roman army. His brother and rival Abuḥafaṣ brought help from Africa; and finally all joined against the Christians. Four years of Christian victory (1038-1042) followed. In the host of Maniaces were men of all races—Normans, who had already begun to show themselves in south Italy, and the Varangian guard, the best soldiers of the empire, among whom Harold Hardrada himself is said to have held a place. Town after town was delivered, first Messana, then Syracuse, then a crowd of others. The exact extent of the reconquest is uncertain; Byzantine writers claim the deliverance of the whole island; but it is certain that the Saracens never lost Panormus. But court influence spoiled everything: Maniaces was recalled; under his successor Stephen, brother-in-law of the emperor Michael, the Saracens won back what they had lost. Messana alone held out, for how long a time is uncertain. But a conqueror came who had no empresses to thwart him. In 1060 began the thirty years' work of the first Roger.

Thus for 263 years the Christian people of some part or other of Sicily were in subjection to Moslem masters. But that subjection differed widely in different times and places. The land was won bit by bit. One town was taken by storm; another submitted on terms harsher or more favourable. The condition of the Christians varied from that of personal slaves to that of communities left free on the payment of tribute. The great mass were in the intermediate state usual among the non-Mahommedan subjects of a Mahommedan power. The *dhimmī* of Sicily were in essentially the same case as the *rayahs* of the Turk. While the conquest was going on, the towns that remained unconquered gained in point of local freedom. They became allies rather than subjects of the distant emperor. So did the tributary districts, as long as the original terms were kept. But, as ever, the condition of the subject race grew worse. After the complete conquest of the island, while the mere slaves had turned Mahommedans, there is nothing more heard of tributary districts. At the coming of the Normans the whole Christian population was in the state of *rayahs*. Still Christianity and the Greek tongue never died out; churches and monasteries received and held property; there still are saints and scholars. It would be rash to deny that traces of other dialects may not have lingered on; but Greek and Arabic were the two written tongues of Sicily when the Normans came. The Sicilian Saracens were hindered by their internal feuds from ever becoming a great power; but they stood high among Mahommedan nations. Their advance in civilization is shown by their position under the Normans, and above all by their admirable style of architecture (see PALERMO). They had a literature which Norman kings studied and promoted. The Normans in short came into the inheritance of the two most civilized nations of the time, and allowed them to flourish side by side.

The most brilliant time for Sicily as a power in the world begins with the coming of the Normans. Never before or after was the island so united or so independent. Some of the old tyrants had ruled out of Sicily; none had ruled over all Sicily. The Normans held all Sicily as the centre of a dominion which stretched far beyond it. The conquest was the work of one man, Count Roger of the house of Hauteville (see ROGER I.). The conquests of the Normans in Italy and Sicily form part of one enterprise; but they altogether differ in character. In Italy they overthrew the Byzantine dominion; their own rule was perhaps not worse, but they were not deliverers. In Sicily they were welcomed by the Christians as deliverers from infidel bondage.

As in the Saracen conquest of Sicily, as in the Byzantine recovery, so in the Norman conquest, the immediate occasion was given by a home traitor. Count Roger had already made a plundering attack, when Becumen of Catania, driven out by his brother, urged him to serious invasion. Messana was taken in 1060, and became for a while the Norman capital. The

in 1038.

*Sicily
under
Saracen
rule.*

*Norman
conquest.*

1060-1090.

Christians everywhere welcomed the conqueror. But at Troina they presently changed their minds, and joined with the Saracens to besiege the count in their citadel. At Catania Becumen was set up again as Roger's vassal, and he did good service till he was killed. Roger soon began to fix his eye on the Saracen capital. Against that city he had Pisan help, as the inscription on the Pisan *duomo* witnesses (cf. Geoff. Mal. ii. 34). But Palermo was not taken until 1071, and then only by the help of Duke Robert, who kept the prize to himself. Still its capture was the turning-point in the struggle. Taormina (Tauromenium) was won in 1078. Syracuse, under its amir Benarvet, held out stoutly. He retook Catania by the help of a Saracen to whom Roger had trusted the city, and whom he himself punished. Catania was won back by the count's son Jordan. But progress was delayed by Jordan's rebellion and by the absence of Roger in his brother's wars. In 1085 Syracuse was won. Next year followed Girgenti and Castrogiovanni, whose chief became a Christian. Noto held out till 1090. Then the whole island was won, and Roger completed his conquest by a successful expedition to Malta.

Like the condition of the Greeks under the Saracens, so the condition of the Saracens under the Normans differed in different places according to the circumstances of each conquest. **Saracens under Norman rule.** The Mahommedan religion was everywhere tolerated, in many places much more. But it would seem that, just as under the Moslem rule, conversions from Christianity to Islam were forbidden. On the other hand, conversions from Islam to Christianity were not always encouraged; Saracen troops were employed from the beginning, and Count Roger seems to have thought them more trustworthy when unconverted. At Palermo the capitulation secured to the Saracens the full enjoyment of their own laws; Girgenti was long mainly Saracen; in Val di Noto the Saracens kept towns and castles of their own. On the other hand, at Messina there were few or none, and we hear of both Saracen and Greek villeins, the latter doubtless abiding as they were in Saracen times. But men of both races were trusted and favoured according to their deserts. The ecclesiastical relations between Greeks and Latins are harder to trace. At the taking of Palermo the Greek bishop was restored; but his successors were Latins, and Latin prelates were placed in the bishoprics which Count Roger founded. Urban II. visited Sicily to promote the union of the church, and he granted to the count those special ecclesiastical powers held by the counts and kings of Sicily as hereditary legates of the Holy See which grew into the famous Sicilian monarchy (Geoff. Mal. iv. 29). But Greek worship went on; at Messina it lingered till the 15th century (Pirro, *Sicilia sacra*, i. 420, 431, 449), as it has been since brought back by the Albanian colonists. But the Greeks of Sicily have long been united Greeks, admitting the authority of the see of Rome.

In its results the Norman conquest of Sicily was a Latin conquest far more thorough than that which had been made by the Roman commonwealth. The Norman princes protected all the races, creeds and tongues of the island, Greek, Saracen and Jew. **Linguistic elements in Sicily.** But new races came to settle alongside of them, all of whom were Latin as far as their official speech was concerned. The Normans brought the French tongue with them; it remained the court speech during the 12th century, and Sicily was thrown open to all speakers of French, many of whom came from England. There was constant intercourse between the two great islands, both ruled by Norman kings, and many natives of England filled high places in Sicily. But French was only a language of society, not of business or literature. The languages of inscriptions and documents are Greek, Arabic and Latin, in private writings sometimes Hebrew. The kings understood Greek and Arabic, and their deeds and works were commemorated in both tongues. Hence comes the fact, at first sight so strange, that Greek, Arabic and French have all given way to a dialect of Italian. But the cause is not far to seek. The Norman conquest opened Sicily to settlers from Italy, above all from the Norman possessions in Italy. Under the name of Lombards,

they became an important, in some parts a dominant, element. Thus at Messina, where we hear nothing of Saracens, we hear much of the disputes between Greeks and Lombards. The Lombards had hardly a distinct language to bring with them. At the time of the conquest, it was already found out that French had become a distinct speech from Latin; Italian hardly was such. The Lombard element, during the Norman reign, shows itself, not in whole documents or inscriptions, but in occasional words and forms, as in some of the mosaics at Monreale. And, if any element, Latin or akin to Latin, had lingered on through Byzantine and Saracen rule, it would of course be attracted to the new Latin element, and would help to strengthen it. It was this Lombard element that had the future before it. Greek and Arabic were antiquated, or at least isolated, in a land which Norman conquest had made part of western Europe and Latin Christendom. They could grow only within the island; they could gain no strength from outside. Even the French element was in some sort isolated, and later events made it more so. But the Lombard element was constantly strengthened by settlement from outside. In the older Latin conquest, the Latin carried Greek with him, and the Greek element absorbed the Latin. Latin now held in western Europe the place which Greek had held there. Thus, in the face of Italian, both Greek and Arabic died out. Step by step, Christian Sicily became Latin in speech and in worship. But this was not till the Norman reigns were over. Till the end of the 12th century Sicily was the one land where men of divers creeds and tongues could live side by side.

Hence came both the short-lived brilliancy of Sicily and its later decay. In Sicily there were many nations all protected by the Sicilian king; but there was no Sicilian nation. Greek, Saracen, Norman, Lombard and Jew could not be fused into one people; it was the boast of Sicily that each kept his laws and tongue undisturbed. Such a state of things could live on only under an enlightened despotism; the discordant elements could not join to work out really free and national institutions. Sicily had parliaments, and some constitutional principles were well understood. But they were assemblies of barons, or at most of barons and citizens; they could only have represented the Latin elements, Norman and Lombard, in the island. The elder races, Greek and Saracen, stand outside the relations between the Latin king and his Latin subjects. Still, as long as Greek and Saracen were protected and favoured, so long was Sicily the most brilliant of European kingdoms. But its greatness had no groundwork of national life; for lack of it the most brilliant of kingdoms presently sank below the level of other lands.

Four generations only span the time from the birth of Count Roger, about 1030, to the death of the emperor Frederick II. in 1250. Roger, great count of Sicily, was, at his death in 1101, succeeded by his young son Simon, **Roger I.** and he in 1105 by the second Roger, the first king. He inherited all Sicily, save half Palermo—the other half had been given up—and part of Calabria. The rest of Palermo was soon granted; the Semitic capital became the abiding head of Sicily. On the death of his cousin Duke William of Apulia, Roger gradually founded (1127–1140) a great Italian dominion. To the Apulian duchy he added (1136) the Norman principality of Capua, Naples (1138), the last dependency of the Eastern empire in Italy, and (1140) the Abruzzi, an undoubted land of the Western empire. He thus formed a dominion which has been divided, united and handed over from one prince to another oftener than any other state in Europe, but whose frontier has hardly changed at all. In 1130 Roger was crowned at Palermo, by authority of the antipope Anacletus, taking the strange title of “king of Sicily and Italy.” This, on his reconciliation with Pope Innocent II., he exchanged for “king of Sicily and of the duchy of Apulia and of the principality of Capua.” By virtue of the old relations between the popes and the Normans of Apulia, he held his kingdom in fief of the Holy See, a position which on the whole strengthened the royal power. But his power, like that of Dionysius and Agathocles, was felt in more distant regions. His admiral George of Antioch, Greek by birth and creed, warred

against the Eastern empire, won Corfu (Korypho; the name of Korkyra is forgotten) for a season, and carried off the silk-workers from Thebes and Peloponnesus to Sicily. But Manuel Comnenus ruled in the East, and, if Roger threatened Constantinople, Manuel threatened Sicily. In Africa the work of Agathocles was more than renewed; Mahdia and other points were won and kept as long as Roger lived. These exploits won him the name of the "terror of Greeks and Saracens." To the Greeks, and still more to the Saracens, of his own island he was a protector and something more. His love for mathematical science, geography, &c., in which the Arabs excelled, is noteworthy.

Roger's son William, surnamed the Bad, was crowned in his father's lifetime in 1151. Roger died in 1154, and William's sole reign lasted till 1166. It was a time of domestic rebellions, chiefly against the king's unpopular ministers, and it is further marked by the loss of Roger's African conquests. After William the Bad came (1166-1189) his son William the Good. Unlike as were the two men in themselves, in their foreign policy they are hardly to be distinguished. The Bad William has a short quarrel with the pope; otherwise Bad and Good alike appear as zealous supporters of Alexander III. and as enemies of both empires. The Eastern warfare of the Good is stained by the frightful sack of Thessalonica; it is marked also by the formation of an Eastern state under Sicilian supremacy (1186). Corfu, the possession of Agathocles and Roger, with Durazzo, Cephalonia and Zante, was granted by William to his admiral Margarito with the strange title of king of the Epeirots. He founded a dynasty, though not of kings, in Cephalonia and Zante. Corfu and Durazzo were to be more closely connected with the Sicilian crown.

The brightest days of Sicily ended with William the Good. His marriage with Joanna, daughter of Henry of Anjou and

England, was childless, and William tried to procure the succession of his aunt Constance and her husband, King Henry VI. of Germany, son of the emperor Frederick I. But the prospect of German rule was unpopular, and on William's death the crown passed to Tancred, an illegitimate grandson of King Roger, who figures in English histories in the story of Richard III.'s crusade. In 1191 Henry, now emperor, asserted his claims; but, while Tancred lived, he did little, in Sicily nothing, to enforce them. On the death of Tancred (1194) and the accession of his young son William III., the emperor came and conquered Sicily and the Italian possessions, with an amount of cruelty which outdid any earlier war or revolution. First of four Western emperors who wore the Sicilian crown, Henry died in 1197, leaving the kingdom to his young son Frederick, heir of the Norman kings through his mother.

The great days of the Norman conquest and the Norman reigns have been worthily recorded by contemporary historians. For few times have we richer materials. The oldest is Aimé or Amato of Monte Cassino, who exists only in an Old-French translation. We have also for the Norman conquest the halting hexameters of William of Apulia, and for the German conquest the lively and partial verses of Peter of Eboli.¹ Of prose writers we have Geoffrey Malaterra, Alexander abbot of Telesia, Romuald archbishop of Salerno, Falco of Benevento, and above all Hugo Falcandus, one of the very foremost of medieval writers. Not one of these Latin writers was a native of the island, and we have no record from any native Greek. Occasional notices we of course have in the Byzantine writers, and Archbishop Eustathius's account of the taking of Thessalonica is more than occasional. And the close connexion between Sicily and England leads to many occasional references to Sicilian matters in English writers.

The relations between the various races of the islands are most instructive. The strong rule of Roger kept all in order. He called himself the defender of Christians; others, on account of his favour to the Saracens, spoke of him as a pagan. He certainly encouraged Saracen art and literature in every shape.

The relations between the various races of the islands are most instructive. The strong rule of Roger kept all in order. He called himself the defender of Christians; others, on account of his favour to the Saracens, spoke of him as a pagan. He certainly encouraged Saracen art and literature in every shape.

¹ *Petri Ansolini de Ebulo de rebus Siculis carmen* (republished in the new edition of Muratori's *Rerum Italicarum Scriptores*, by E. Rota, tom. xxxi., Città di Castello, 1904).

His court was full of eunuchs, of whom we hear still more under William the Bad. Under William the Good the Saracens, without any actual oppression, seem to be losing their position. Hitherto they had been one element in the land, keeping their own civilization alongside of others. By a general outbreak on the death of William the Good, the Saracens, especially those of Palermo, were driven to take shelter in the mountains, where they sank into a wild people, sometimes holding points of the island against all rulers, sometimes taking military service under them. The Jews too begin to sink into bondmen. Sicily is ceasing to be the land of many nations living side by side on equal terms.

The Germans who helped Henry to win the Sicilian crown did not become a new element in the island, but only a source of confusion during the minority of his son. Frederick —presently to be the renowned emperor Frederick II., *Emperor Frederick II.* "Fridericus stupor mundi et immutator mirabilis"—was crowned at Palermo in 1198; but the child, deprived of both parents, was held to be under the protection of his lord Pope Innocent III. During his minority the land was torn in pieces by turbulent nobles, revolted Saracens, German captains seeking settlements, the maritime cities of Italy, and professed French deliverers. In 1210 the emperor Otto IV., who had overrun the continental dominions, threatened the island. In 1212, just when Frederick was reaching an age to be of use in his own kingdom, he was called away to dispute the crown of Germany and Rome with Otto. Eight years more of disorder followed; in 1220 the emperor-king came back. He brought the Saracens of the mountains back again to a life in plains and cities, and presently planted a colony of them on the mainland at Nocera, when they became his most trusty soldiers. His necessary absences from Sicily led to revolts. He came back in 1233 from his crusade to suppress a revolt of the eastern cities, which seem to have been aiming at republican independence. A Saracen revolt in 1243 is said to have been followed by a removal of the whole remnant to Nocera. Some, however, certainly stayed or came back; but their day was over.

Under Frederick the Italian or Lombard element finally prevailed in Sicily. Of all his kingdoms Sicily was the best-beloved. He spoke all its tongues; he protected, as far as circumstances would allow, all its races. The heretic alone was persecuted; he was the domestic rebel of the church; Saracen and Jew were entitled to the rights of foreigners. Yet Frederick, patron of Arabic learning, suspected even of Moslem belief, failed to check the decline of the Saracen element in Sicily. The Greek element had no such forces brought against it. It was still a chief tongue of the island, in which Frederick's laws were put forth as well as in Latin. But it was clearly a declining element. Greek and Saracen were both becoming survivals in an island which was but one of the many kingdoms of its king. The Italian element advanced at the cost of all others. Frederick chose it as the court speech of Sicily, and he made it the speech of a new-born literature. Sicily, strangely enough, became the cradle of Italian song.

Two emperors had now held the Sicilian crown. On Frederick's death in 1250 the crown passed to his son Conrad, not emperor indeed, but king of the Romans. He was nominally succeeded by his son Conradin. The real ruler under both was Frederick's natural son Manfred. *Manfred.* In 1258, on a false rumour of the death of Conradin, Manfred was himself crowned king of Palermo. He had to found the kingdom afresh. Pope Innocent IV. had crossed into Sicily, to take advantage of the general discontent. The cities, whose growing liberties had been checked by Frederick's legislation, strove for practical, if not formal, independence, sometimes for dominion over their fellows. The 5th century B.C. seemed to have come back. Messina laid waste the lands of Taormina, because Taormina would not obey the bidding of Messina. Yet, among these and other elements of confusion, Manfred succeeded in setting up again the kingly power, first for his kinsmen and then for himself. His reign continued that of his father, so far as a mere king could continue the reign of such an emperor. The king of Sicily

was the first potentate of Italy, and came nearer than any prince since Louis II. to the union of Italy under Italian rule. He sought dominion too beyond the Adriatic: Corfu, Durazzo, and a strip of the Albanian coast became Sicilian possessions as the dowry of Manfred's Greek wife. But papal enmity was too much for him. His overlord claimed to dispose of his crown, and hawked it about among the princes of the West. Edmund of England bore the Sicilian title for a moment. More came of the grant of Urban IV. (1264) to Charles, count of Anjou, and

Charles of Anjou.

through his wife sovereign count of Provence. Charles, crowned by the pope in 1266, marched to take possession of his lord's grant. Manfred was defeated and slain at Benevento. The whole Sicilian kingdom became the spoil of a stranger who was no deliverer to any class of its people. The island sank yet lower. Naples, not Palermo, was the head of the new power; Sicily was again a province. But a province Sicily had no mind to be. In the continental lands Charles founded a dynasty; the island he lost after sixteen years. His rule was not merely the rule of a stranger king surrounded by stranger followers; the degradation of the island was aggravated by gross oppression, grosser than in the continental lands. The continental lands submitted, with a few slight efforts at resistance. The final result of the Angevin conquest of Sicily was its separation from the mainland.

Sicilian feeling was first shown in the support given to the luckless expedition of Conradin in 1268. Frightful executions in the island followed his fall. The rights of the Swabian house were now held to pass to Peter (Pedro), king of Aragon, husband of Manfred's daughter Constance. The connexion with Spain, which has so deeply affected the whole later history of Sicily, now begins. Charles held the Greek possessions of Manfred and had designs both on Epeiros and on Constantinople. The emperor Michael Palaeologus and Peter of Aragon became allies against Charles; the famous John of Procida acted as an agent between them; the costs of Charles's eastern warfare caused great discontent, especially in an island where some might still look to the Greek emperor as a natural deliverer. Peter and Michael were doubtless watching the turn of things in Sicily; but the tale of a long-hidden conspiracy between them and the whole Sicilian people has been set aside by Amari. The actual outbreak of 1282, the famous Sicilian Vespers, was stirred up by the wrongs of the moment. A gross case of insult offered by a Frenchman to a Sicilian woman led to the massacre at Palermo, and the like scenes followed elsewhere. The strangers were cut off; Sicily was left to its own people. The towns and districts left without a ruler by no means designed to throw off the authority of the overlord; they sought the good will of Pope Martin. But papal interests were on the side of Charles; and he went forth with the blessing of the church to win back his lost kingdom.

Angevin oppression had brought together all Sicily in a common cause. There was at last a Sicilian nation, a nation for a while capable of great deeds. Sicily now stands out as a main centre of European politics. But the land has lost its character; it is becoming the plaything of powers, instead of the meeting-place of nations. The tale, true or false, that Frenchmen and Provençals were known from the natives by being unable to frame the Italian sound of *c* shows how thoroughly the Lombard tongue had overcome the other tongues of the island. In Palermo, once city of threefold speech, a Greek, a Saracen, a Norman who spoke his own tongue must have died with the strangers.

Charles was now besieging Messina; Sicily seems to have put on some approach to the form of a federal commonwealth.

Peter of Aragon.

Meanwhile Peter of Aragon was watching and preparing. He now declared himself. To all, except the citizens of the great cities, a king would be acceptable; Peter was chosen with little opposition in a parliament at Palermo, and a struggle of twenty-one years began, of which Charles and Peter saw only the first stage. In fact, after Peter had helped the Sicilians to relieve Messina, he was very little in Sicily; he had to defend his kingdom of Aragon, which Pope

Martin had granted to another French Charles. He was represented by Queen Constance, and his great admiral Roger de Loria kept the war away from Sicily, waging it wholly in Italy, and making Charles, the son of King Charles, prisoner. In 1285 both the rival kings died. Charles had before his death been driven to make large legislative concessions to his subjects to stop the tendency shown, especially in Naples, to join the revolted Sicilians. By Peter's death Aragon and Sicily were separated; his eldest son Alphonso took Aragon, and his second son James took Sicily, which was to pass to the third son Frederick, if James died childless. James was crowned, and held his reforming parliament also. With the popes no terms could be made. Charles, released in 1288 under a deceptive negotiation, was crowned king of Sicily by Honorius IV.; but he had much ado to defend his continental dominions against James and Roger. In 1291 James succeeded Alphonso in the kingdom of Aragon, and left Frederick not king, according to the entail, but only his lieutenant in Sicily.

James.

Frederick was the real restorer of Sicilian independence. He had come to the island so young that he felt as a native. He defended the land stoutly, even against his brother.

Frederick.

For James presently played Sicily false. In 1295 he was reconciled to the church and released from all French claims on Aragon, and he bound himself to restore Sicily to Charles. But the Sicilians, with Frederick at their head, disowned the agreement, and in 1296 Frederick was crowned king. He had to defend Sicily against his brother and Roger de Loria, who forsook the cause, as did John of Procida. Hitherto the war had been waged on the mainland; now it was transferred to Sicily. King James besieged Syracuse as admiral of the Roman Church; Charles sent his son Robert in 1299 as his lieutenant in Sicily, where he gained some successes. But in the same year the one great land battle of the war, that of Falconaria, was won for Sicily. The war, chiefly marked by another great siege of Messina, went on till 1302, when both sides were thoroughly weakened and eager for peace. By a treaty, confirmed by Pope Boniface VIII. the next year, Frederick was acknowledged as king of Trinacria for life. He was to marry the daughter of the king of Sicily, to whom the island kingdom was to revert at his death. The terms were never meant to be carried out. Frederick again took up the title of king of Sicily, and at his death in 1337 he was succeeded

Peter.

by his son Peter. There were thus two Sicilian kingdoms and two kings of Sicily. The king of the mainland is often spoken of for convenience as king of Naples, but that description was never borne as a formal title save in the 16th century by Philip, king of England and Naples, and in the 19th by Joseph Buonaparte and Joachim Murat. The strict distinction was between Sicily on this side the Pharos (of Messina) and Sicily beyond it.

Thus the great island of the Mediterranean again became an independent power. And, as far as legislation could make it, Sicily became one of the freest countries in Europe. By the laws of Frederick parliaments were to be regularly held, and without their consent the king could not make war, peace or alliance. The treaty of 1302 was not confirmed by parliament, and in 1337 parliament called Peter to the crown. But Sicily never rose to the greatness of its Greek or its Norman days, and its old character had passed away. Of Greeks and Saracens we now hear only as a degraded remnant, to be won over, if it may be, to the Western Church. The kingdom had no foreign possessions; yet faint survivals of the days of Agathocles and Roger lingered on. The isle of Gerba off the African coast was held for a short time, and traces of the connexion with Greece went on in various shapes. If the kings of Sicily on this side the Pharos kept Corfu down to 1386, those beyond the Pharos became in 1311 overlords of Athens, when that duchy was seized by Catalan adventurers, disbanded after the wars of Sicily. In 1530 the Sicilian island of Malta became the shelter of the Knights of Saint John driven by the Turk from Rhodes, and Sicily has received several colonies of Christian Albanians, who have replaced Greek and Arabic by yet another tongue. (See NAPLES, KINGDOM OF.)

(E. A. F.; T. As.)

SICKINGEN, FRANZ VON (1481–1523), German knight, one of the most notable figures of the first period of the Reformation, was born at Ebernburg near Worms. Having fought for the emperor Maximilian I. against Venice in 1508, he inherited large estates on the Rhine, and increased his wealth and reputation by numerous private feuds, in which he usually posed as the friend of the oppressed. In 1513 he took up the quarrel of Balthasar Schlör, a citizen who had been driven out of Worms, and attacked this city with 7000 men. In spite of the imperial ban, he devastated its lands, intercepted its commerce, and only desisted when his demands were granted. He made war upon Antony, duke of Lorraine, and compelled Philip, landgrave of Hesse, to pay him 35,000 gulden. In 1518 he interfered in a civil conflict in Metz, ostensibly siding with the citizens against the governing oligarchy. He led an army of 20,000 men against the city, compelled the magistrates to give him 20,000 gold gulden and a month's pay for his troops. In 1518 Maximilian released him from the ban, and he took part in the war carried on by the Swabian League against Ulrich I., duke of Württemberg. In the contest for the imperial throne upon the death of Maximilian in 1519, Sickingen accepted bribes from Francis I., king of France, but when the election took place he led his troops to Frankfort, where their presence assisted to secure the election of Charles V. For this service he was made imperial chamberlain and councillor, and in 1521 he led an expedition into France, which ravaged Picardy, but was beaten back from Mezières and forced to retreat. About 1517 Sickingen became intimate with Ulrich von Hutten, and gave his support to Hutten's schemes. In 1519 a threat from him freed John Reuchlin from his enemies, the Dominicans, and his castles became in Hutten's words *a refuge for righteousness*. Here many of the reformers found shelter, and a retreat was offered to Martin Luther. After the failure of the French expedition, Sickingen, aided by Hutten, formed, or revived, a large scheme to overthrow the spiritual princes and to elevate the order of knighthood. He hoped to secure this by the help of the towns and peasants, and to make a great position for himself. A large army was soon collected, many nobles from the upper Rhineland joined the standard, and at Landau, in August 1522, Sickingen was formally named commander. He declared war against his old enemy, Richard of Greiffenklau, archbishop of Trier, and marched against that city. Trier was loyal to the archbishop, and the landgrave of Hesse and Louis V., count palatine of the Rhine, hastened to his assistance. Sickingen, who had not obtained the help he wished for, was compelled to fall back on his castle of Landstuhl, near Kaiserslautern, collecting much booty on the way. On the 22nd of October 1522 the council of regency placed him under the ban, to which he replied, in the spring of 1523, by plundering Kaiserslautern. The rulers of Trier, Hesse and the Palatinate decided to press the campaign against him, and having obtained help from the Swabian League, marched on Landstuhl. Sickingen refused to treat, and during the siege was seriously wounded. This attack is notable as one of the first occasions on which artillery was used, and by its aid breaches were soon made in an otherwise impregnable fortress. On the 6th of May 1523 he was forced to capitulate, and on the following day he died. He was buried at Landstuhl, and in 1889 a splendid monument was raised at Ebernburg to his memory and to that of Hutten.

His son Franz Conrad was made a baron of the empire (*Reichsfreiherr*) by Maximilian II., and a descendant was raised in 1773 to the rank of count (*Reichsgraf*). A branch of the family still exists in Austria and Silesia.

See H. Ulmann, *Franz von Sickingen* (Leipzig, 1872); F. P. Bremer, *Sickingens Fehde gegen Trier* (Strassburg, 1885); H. Prutz, "Franz von Sickingen" in *Der neue Plutarch* (Leipzig, 1880), and the "Flersheimer Chronik" in Hutten's *Deutsche Schriften*, edited by O. Waltz und Szamatolati (Strassburg, 1891).

SICKLES, DANIEL EDGAR (1825–), American soldier and diplomatist, was born in New York City on the 20th of October 1825. He learned the printer's trade, studied in the university of the City of New York (now New York University), was admitted to the bar in 1846, and was a member of the state Assembly in 1847. In 1853 he became corporation counsel of

New York City, but resigned soon afterward to become secretary of the U.S. legation in London, under James Buchanan. He returned to America in 1855, was a member of the state Senate in 1856–1857, and from 1857 to 1861 was a Democratic representative in Congress. In 1859 he was tried on a charge of murder, having shot Philip Barton Key, U.S. attorney for the District of Columbia, whom Sickles had discovered to have a liaison with his wife; but was acquitted after a dramatic trial lasting twenty days. At the outbreak of the Civil War Sickles was active in raising United States volunteers in New York, and was appointed colonel of a regiment. He became a brigadier-general of volunteers in September 1861, led a brigade of the Army of the Potomac with credit up to the battle of Antietam, and then succeeded to a divisional command. He took part with distinction in the battle of Fredericksburg, and in 1863 as a major-general commanded the III. army corps. His energy and ability were conspicuous in the disastrous battle of Chancellorsville (*q.v.*); and at Gettysburg (*q.v.*) the part played by the III. corps in the desperate fighting around the Peach Orchard was one of the most noteworthy incidents in the battle. Sickles himself lost a leg and his active military career came to an end. He was, however, employed to the end of the war, and in 1867 received the brevets of brigadier-general U.S.A. and major-general U.S.A. for his services at Fredericksburg and Gettysburg respectively. General Sickles was one of the few successful volunteer generals who served on either side. Soon after the close of the Civil War he was sent on a confidential mission to Colombia to secure its compliance with a treaty agreement (of 1846) permitting the United States to convey troops across the Isthmus of Panama. In 1866–1867 he commanded the department of the Carolinas. In 1866 he was appointed colonel of the 42nd infantry (Veteran Reserve Corps), and in 1869 he was retired with the rank of major-general. He was minister to Spain from 1869 to 1873, and took part in the negotiations growing out of the "Virginius Affair" (see SANTIAGO, CUBA). General Sickles was president of the New York State Board of Civil Service Commissioners in 1888–1889, was sheriff of New York in 1890, and was again a representative in Congress in 1893–1895.

SICULI, an ancient Sicilian tribe, which in historical times occupied the eastern half of the island to which they gave their name. It plays a large though rather shadowy part in the early traditions of pre-Roman Italy. There is abundant evidence that the Siculi once lived in Central Italy east and even north of Rome (*e.g.* Servius *ad Aen.* vii. 795; Dion. Hal. i. 9. 22; Thucydides vi. 2). Thence they were dislodged by the Umbro-Sabine tribes, and finally crossed to Sicily. Archaeologists are not yet agreed as to the particular stratum of remains in Italy to which the name of the Siculi should be attached (see for instance B. Modestov, *Introduction à l'histoire romaine*, Paris, 1907, pp. 135 sqq.). They were distinct from the *Sicani* (*q.v.*; Virg. *Aen.* viii. 328) who inhabited the western half of the island, and who according to Thucydides came from Spain, but whom Virgil seems to recognize in Italy. Both traditions may be true (*cf.* W. Ridgeway, *Who were the Romans?* London, 1908, p. 23). Of the language of the Siculi we know a very little from glosses preserved to us by ancient writers, most of which were collected by E. A. Freeman (*Sicily*, vol. i. App. note iv.), and from an inscription upon what is presumably an ornamental earthenware wine vessel, which has very much the shape of a tea-pot, preserved and transcribed by R. S. Conway in the Collection of the Grand Duke of Baden at Karlsruhe (Winnefeld, *Grossherzogl. vereinigte Sammlungen*, 1887, 120), which has been discussed by R. Thurneysen (Kuhn's *Zeitschrift*, xxxv. 214). The inscription was found at Centuripa, and the alphabet is Greek of the 5th or 6th century B.C. We have not enough evidence to make a translation possible, despite Thurneysen's valiant effort, but the recurrence of the phrase *hemiton esti durom* in a varied order (*durom hemiton esti*)—presumably a drinking song or proverb, "half a cup is sorry cheer," though it is possible that the sign read as *m* may really denote some kind of *s*—makes the division of these three words quite certain, and renders it highly probable that we have to do with an Indo-European language. None of

the groups of sounds occurring in the rest of the inscription, nor any of the endings of words so far as they may be guessed, present any reason for doubting this hypothesis; and the glosses already mentioned can one and all be easily connected with Greek or Latin words (e.g. *μῦλον*, *muluum*); in fact it would be difficult to rebut the contention that they should all be regarded as mere borrowings. (R. S. C.)

The towns of the Siculi, like those of the Sicani, formed no political union, but were under independent rulers. They played an important part in the history of the island after the arrival of the Greeks (see SICILY). Their agricultural pursuits and the volcanic nature of the island made them worshippers of the gods of the nether world, and they have enriched mythology with some distinctly national figures. The most important of these were the Palici, protectors of agriculture and sailors, who had a lake and temple in the neighbourhood of the river Symaethus, the chief seat of the Siceli; Adranus, father of the Palici, a god akin to Hephaestus, in whose temple a fire was always kept burning; Hybla (or Hyblaea), after whom three towns were named, whose sanctuary was at Hybla Gereatis. The connexion of Demeter and Kore with Henna (the rape of Proserpine) and of Arethusa with Syracuse is due to Greek influence. The chief Sicel towns were: Agyrium (*San Filippo d' Argirò*); Centuripa (or Centuripae; *Centorbi*); Henna (*Castrogiovanni*, a corruption of Castrum Hennae through the Arabic Casr-janni); Hybla, three in number, (a) Hybla Major, called Geleatis or Gereatis, on the river Symaethus, probably the Hybla famous for its honey, although according to others this was (b) Hybla Minor, on the E. coast N. of Syracuse, afterwards the site of the Dorian colony of Megara, (c) Hybla Heraea in the S. of the island.

For authorities see SICILY.

SICYON, or **SECYON** (the latter being the older form used by the natives), an ancient Greek city situated in northern Peloponnesus between Corinthia and Achaea. It was built on a low triangular plateau about 2 m. from the Corinthian Gulf, at the confluence of the Asopus and the Helisson, whose sunken beds protected it on E. and W. Between the city and its port lay a fertile plain with olive-groves and orchards. Sicyon's primitive name Aegialeia indicates that its original population was Ionian; in the *Iliad* it appears as a dependency of Agamemnon, and its early connexion with Argos is further proved by the myth and surviving cult of Adrastus. After the Dorian invasion the community was divided anew into the ordinary three Dorian tribes and an equally privileged tribe of Ionians, besides which a class of *κορνηφόροι* or *κατωνακοφόροι* lived on the land as serfs. For some centuries Sicyon remained subject to Argos, whence its Dorian conquerors had come; as late as 500 B.C. it acknowledged a certain suzerainty. But its virtual independence was established in the 7th century, when a line of tyrants arose and initiated an anti-Dorian policy. This dynasty, known after its founder Orthagoras as the Orthagoridae, exercised a mild rule, and therefore lasted longer than any other succession of Greek tyrants (about 665–565 B.C.). Chief of these rulers was the founder's grandson Cleisthenes—the uncle of the Athenian legislator of that name (see CLEISTHENES, 2). Besides reforming the city's constitution to the advantage of the Ionians and replacing Dorian cults by the worship of Dionysus, Cleisthenes gained renown as the chief instigator and general of the First Sacred War (590) in the interests of the Delphians. From Herodotus' famous account of the wooing of Agariste it may be inferred that he held intercourse with many commercial centres of Greece and south Italy. About this time Sicyon developed the various industries for which it was noted in antiquity. As the abode of the sculptors Dipoenus and Scyllis it gained pre-eminence in wood-carving and bronze work such as is still to be seen in the archaic metal facings found at Olympia. Its pottery, which resembled the Corinthian ware, was exported with the latter as far as Etruria. In Sicyon also the art of painting was supposed to have been "invented." After the fall of the tyrants their institutions survived till the end of the 6th century, when the Dorian supremacy was re-established, perhaps by the agency of Sparta, and the city was enrolled in the Peloponnesian League. Henceforth

its policy was usually determined either by Sparta or by its powerful neighbour Corinth. During the Persian wars Sicyon could place 3000 heavy-armed men in the field; its school of bronze sculptors still flourished, and produced in Canachus (*q.v.*) a master of the late archaic style. In the 5th century it suffered like Corinth from the commercial rivalry of Athens in the western seas, and was repeatedly harassed by flying squadrons of Athenian ships. In the Peloponnesian war Sicyon followed the lead of Sparta and Corinth. When these two powers quarrelled after the peace of Nicias it remained loyal to the Spartans; but the latter thought it prudent to stiffen the oligarchic government against a nascent democratic movement. Again in the Corinthian war Sicyon sided with Sparta and became its base of operations against the allied troops round Corinth. In 369 it was captured and garrisoned by the Thebans in their successful attack on the Peloponnesian League. On this occasion a powerful citizen named Euphron effected a democratic revolution and established himself tyrant by popular support. His deposition by the Thebans and subsequent murder freed Sicyon for a season, but new tyrants arose with the help of Philip II. of Macedon. Nevertheless during this period Sicyon reached its zenith as a centre of art: its school of painting gained fame under Eupompus and attracted the great masters Pamphilus and Apelles as students; its sculpture was raised to a level hardly surpassed in Greece by Lysippus and his pupils. After participating in the Lamian war and the campaigns of the Macedonian pretenders the city was captured (303) by Demetrius Polioretetes, who transplanted all the inhabitants to the Acropolis and renamed the site Demetrias. In the 3rd century it again passed from tyrant to tyrant, until in 251 it was finally liberated and enrolled in the Achaean League by Aratus (*q.v.*). The destruction of Corinth (146) brought Sicyon an acquisition of territory and the presidency over the Isthmian games; yet in Cicero's time it had fallen deep into debt. Under the empire it was quite obscured by the restored cities of Corinth and Patrae; in Pausanias' age (A.D. 150) it was almost desolate. In Byzantine times it became a bishop's seat, and to judge by its later name "Hellas" it served as a refuge for the Greeks from the Slavonic immigrants of the 8th century.

The village of Vasiliko which now occupies the site is quite insignificant. On the plateau parts of the ancient fortifications are still visible, including the wall between town and Acropolis near the southern apex. A little north of this wall are remains of a theatre and stadium, traces of aqueducts and foundations of buildings. The theatre, which was excavated by the American School of Archaeology in 1886–1887, 1891 and 1898, was built in the slope towards the Acropolis, probably in the first half of the 4th century, and measured 400 ft. in diameter; the stage was rebuilt in Roman times. The side entrances to the auditorium were covered in with vaults of Greek construction; a curious feature is a tunnel from below the stage into the middle of the auditorium.

AUTHORITIES.—Strabo, pp. 382, 389; Herodotus v. 67–68, vi. 92, ix. 28; Thucydides i. 108, 111; iv. 70, 101; v. 52, 82; Xenophon, *Hellenica*, iv., vi., vii.; Diodorus xviii. 11, xx. 102; Pausanias ii. 5–11; W. M. Leake, *Travels in the Morea* (London, 1830), iii. pp. 351–381; E. Curtius, *Peloponnesos* (Gotha, 1851), ii. pp. 482–505; *American Journal of Archaeology*, v. (1889) pp. 267–303, viii. (1893) pp. 288–400, xx. (1905) pp. 263–276; L. Dyer in the *Journal of Hellenic Studies* (1906), pp. 76–83; for coins, B. V. Head, *Historia numorum* (Oxford, 1887), pp. 345–346; also NUMISMATICS, section *Greek*, § "Patrae, Sicyon." (M. O. B. C.)

SIDDONS, SARAH (1755–1831), English actress, the eldest of twelve children of Roger Kemble, was born in the "Shoulder of Mutton" public-house, Brecon, Wales, on the 5th of July 1755. Through the special care of her mother in sending her to the schools in the towns where the company played, Sarah Kemble received a remarkably good education, although she was accustomed to make her appearance on the stage while still a child. She became attached to William Siddons, an actor of the company; but this was discountenanced by her parents, who wished her to accept the offer of a squire. Siddons was dismissed from the company, and she was sent to a situation as lady's maid to Mrs Greathead at Guy's Cliff in Warwickshire. Here she recited Shakespear, Milton and Rowe in the servants'

hall, and occasionally before aristocratic company, and here also she began to develop a capacity for sculpture which was subsequently developed (between 1789 and 1790), and of which she provided samples in busts of herself and of her son. The necessary consent to her union with Siddons was at last obtained, and the marriage took place at Trinity Church, Coventry, on the 26th of November 1773. It was while playing at Cheltenham in the following year that Mrs Siddons met with the earliest decided recognition of her powers as an actress, when by her representation of Belvidera in Otway's *Venice Preserved* she moved to tears a party of "people of quality" who had come to scoff. Her merits were made known by them to Garrick, who sent his deputy to Cheltenham to see her as Calista in Rowe's *Fair Penitent*, the result being that she was engaged to appear at Drury Lane at a salary of £5 a week. Owing to inexperience as well as other circumstances, her first appearances as Portia and in other parts were unfortunate, and when, after playing with success in Birmingham, she was about to return to town she received a note from the manager of Drury Lane stating that her services would not be required. Thus, in her own words, "banished from Drury Lane as a worthless candidate for fame and fortune," she again in the beginning of 1777 went on "the circuit" in the provinces. After a very successful engagement at Bath, beginning in 1778 and lasting five years, she again accepted an offer from Drury Lane, when her appearance as Isabella in Garrick's version of Southerne's *Fatal Marriage*, on the 10th of October 1782, was a triumph, only equalled in the history of the English stage by that of Garrick's first night at Drury Lane in 1741 and that of Edmund Kean's in 1814. In her earlier years it was in scenes of a tender and melting character that she exercised the strongest sway over an audience; but in the performance of Lady Macbeth, in which she appeared on the 2nd of February 1785 for the first time in London, it was the grandeur of her exhibition of the more terrible passions as related to one awful purpose that held them spellbound. In Lady Macbeth she found the highest and best scope for her gifts. It fitted her as no other character did, and as perhaps it will never fit another actress. Her extraordinary and peculiar physical endowments—tall and striking figure, brilliant beauty, powerfully expressive eyes, and solemn dignity of demeanour—enabled her to confer a weird majesty on the character which inexpressibly heightened the tragic awe surrounding her fate. After Lady Macbeth she played Desdemona, Rosalind and Ophelia, all with great success; but it was in Queen Catherine—which she first played on the occasion of her brother John Kemble's spectacular revival of *Henry VIII.* in 1788—that she discovered a part almost as well adapted to her peculiar powers as that of Lady Macbeth. As Volumnia in Kemble's version of *Coriolanus* she also secured a triumph. In her early life she had attempted comedy, but her gifts in this respect were very limited. It was of course inevitable that comparisons should be made between her and her only peer, Rachel, who undoubtedly excelled her in intensity and the portrayal of fierce passion, but was a less finished artist and lacked Mrs Siddons' dignity and pathos. Though Mrs Siddons' minute and systematic study perhaps gave a certain amount of stiffness to her representations, it conferred on them a symmetry and proportion to which Rachel never attained. Mrs Siddons formally retired from the stage in 1812, but occasionally appeared on special occasions even when advanced in years. Her last appearance was on the 9th of June 1819 as Lady Randolph in Home's *Douglas*, for the benefit of Mr and Mrs Charles Kemble. Her most striking impersonations, besides the rôles already mentioned, were those of Zara in Congreve's *Mourning Bride*, Constance in *King John*, Mrs Haller in *The Stranger*, and Elvira in *Pizarro*. In private life Mrs Siddons enjoyed the friendship and respect of many of the most eminent persons of her time. Horace Walpole at first refused to join the fashionable chorus of her praise, but he was ultimately won over. Dr Johnson wrote his name on the hem of her garment in the famous picture of the actress as the Tragic Muse by Reynolds (now in the Dulwich Gallery). "I would not lose," he said, "the honour this opportunity afforded to me for

my name going down to posterity on the hem of your garment." Mrs Siddons died in London on the 8th of June 1831, and was buried in Paddington churchyard.

On the 14th of June 1897 Sir Henry Irving unveiled at Paddington Green a marble statue of her by Chavalliaud, after the portrait by Reynolds. There is also a large statue by Chantry in Westminster Abbey. Portraits by Lawrence and Gainsborough are in the National Gallery, and a portrait ascribed to Gainsborough is in the Garrick Club, London, which also possesses two pictures of the actress as Lady Macbeth by George Henry Harlow.

See Thomas Campbell, *Life of Mrs Siddons* (2 vols., 1834); Fitzgerald, *The Kembles* (3 vols., 1871); Frances Ann Kemble, *Records of a Girlhood* (3 vols., 1878).

SIDE (mod. *Eski Adalia*), an ancient city on the Pamphylian coast about 12 m. E. of the mouth of the Eurymedon. Possessing a good harbour in the days of small craft, it was the most important place in Pamphylia. Alexander visited and occupied it, and there the Rhodian fleet defeated that of Antiochus the Great, and in the succeeding century the Cilician pirates established their chief seat. An inscription found on the site shows it to have had a considerable Jewish population in early Byzantine times. The great ruins, among the most notable in Asia Minor, have been re-occupied by some 200 families of Cretan Moslems. They cover a large promontory, fenced from the mainland by a ditch and wall which has been repaired in medieval times and is singularly perfect. Within this is a maze of structures out of which rises the colossal ruin of the theatre, built up on arches like a Roman amphitheatre for lack of a convenient hill-side to be hollowed out in the usual Greek fashion. The auditorium is little less perfect than that of Aspendus and very nearly as large; but the scena wall has collapsed over stage and proscenium in a cataract of loose blocks. The arches now afford shelter and stabling for the Cretans. Besides the theatres, three temples, an aqueduct and a nymphæum are noticeable.

See C. Lanckorowski, *Les Villes de la Pamphylie et de la Pisidie*, i. (1890). (D. G. H.)

SIDEBOARD, a high oblong table fitted with drawers, cupboards or pedestals, and used for the exposition or storage of articles required in the dining-room. Originally it was what its name implies—a side-table, to which the modern dinner-wagon very closely approximates. Then two- or three-tiered sideboards were in use in the Tudor period, and were perhaps the ancestors, or collaterals, of the court-cupboard, which in skeleton they much resembled. Early in the 18th century they began to be replaced by side-tables properly so called. They were one of the many revolutions in furniture produced by the introduction of mahogany, and those who could not afford the new and costly wood used a cheap substitute stained to resemble it. In the beginning these tables were entirely of wood and comparatively slight, but before long it became the fashion to use a marble slab instead of a wooden top, which necessitated a somewhat more robust construction; here again there was a field for imitation, and marble was sometimes replaced by scagliola. Many of the sideboard tables of this period were exceedingly handsome, with cabriole legs, claw or claw and bill feet, friezes of acanthus, much gadrooning and mask pendants. Many such tables came from Chippendale's workshops, but although that great genius beautified the type he found, he had no influence upon the evolution of the sideboard. That evolution was brought about by the growth of domestic needs. Save upon its surface, the sideboard-table offered no accommodation; it usually lacked even a drawer. Even, however, in the period of Chippendale's zenith separate "bottle cisterns" and "lavatories" for the convenience of the butler in washing the silver as the meals proceeded were, sparsely no doubt, in use. By degrees it became customary to place a pedestal, which was really a cellarette or a plate-warmer, at each end of the sideboard-table. One of them would contain ice and accommodation for bottles, the other would be a cistern. Sometimes a single pedestal would be surmounted by a wooden vase lined with metal and filled with water, and fitted with a tap. To whom is due the brilliant inspiration of attaching the

pedestals to the table and creating a single piece of furniture out of three components there is nothing to show with certainty. It is most probable that the credit is due to Shearer, who unquestionably did much for the improvement of the sideboard; Hepplewhite and the brothers Adam distinguished themselves in the same field. The pedestals, when incorporated as an integral part of the piece, became cupboards and the vases knife-boxes, and, with the drawers, which had been occasionally used much earlier, the sideboard, in what appears to be its final form, was completed. Pieces exist in which the ends have been cut away to receive the pedestals. If Shearer and Hepplewhite laid its foundations, it was brought to its full *floraison* by Sheraton. By the use of fine exotic woods, the deft employment of satin wood and other inlays, and by the addition of gracefully ornamented brass-work at the back, sometimes surmounted by candles to light up the silver, Sheraton produced effects of great elegance. But for sheer artistic excellence in the components of what presently became the sideboard, the Adams stand unrivalled, some of their inlay and brass mounts being almost equal to the first work of the great French school. By replacing the straight outline with a bombé front, Hepplewhite added still further to the grace of the late 18th-century sideboard. No art remains long at its apogee, and in less than a quarter of a century the sideboard lost its grace, and, influenced by the heavy feeling of the Empire manner, grew massive and dull. Since the end of the 18th century there has indeed been no advance, artistically speaking, in this piece of furniture.

SIDGWICK, HENRY (1838–1900), English philosopher, was born at Skipton in Yorkshire, where his father, the Rev. W. Sidgwick (d. 1841), was headmaster of the grammar-school, on the 31st of May 1838. He was educated at Rugby (where his cousin, subsequently his brother-in-law, E. W. Benson—afterwards archbishop—was a master), and at Trinity, Cambridge, where his career was a brilliant one. In 1859 he was senior classic, 33rd wrangler, chancellor's medallist and Craven scholar. In the same year he was elected to a fellowship at Trinity, and soon afterwards appointed to a classical lectureship there. This post he held for ten years, but in 1869 exchanged his lectureship for one in moral philosophy, a subject to which he had been turning his attention more and more. In the same year, finding that he could no longer declare himself a member of the Church of England, he resigned his fellowship. He retained his lectureship, and in 1881 was elected an honorary fellow. In 1874 he published his *Method of Ethics* (6th ed. 1901, containing emendations written just before his death), which first won him a reputation outside his university. In 1875 he was appointed pralector on moral and political philosophy at Trinity, in 1883 he was elected Knightbridge professor of moral philosophy, and in 1885, the religious test having been removed, his college once more elected him to a fellowship on the foundation. Besides his lecturing and literary labours, Sidgwick took an active part in the business of the university, and in many forms of social and philanthropic work. He was a member of the General Board of Studies from its foundation in 1882 till 1899; he was also a member of the Council of the Senate of the Indian Civil Service Board and the Local Examinations and Lectures Syndicate, and chairman of the Special Board for Moral Science. He was one of the founders and first president of the Society for Psychical Research, and was a member of the Metaphysical Society. None of his work is more closely identified with his name than the part he took in promoting the higher education of women. He helped to start the higher local examinations for women, and the lectures held at Cambridge in preparation for these. It was at his suggestion and with his help that Miss Clough opened a house of residence for students; and when this had developed into Newnham College, and in 1880 the North Hall was added, Mr Sidgwick, who had in 1876 married Eleanor Mildred Balfour (sister of A. J. Balfour), went with his wife to live there for two years. After Miss Clough's death in 1892 Mrs Sidgwick became principal of the college, and she and her husband resided there for the rest of his life. During this whole period Sidgwick took the deepest interest in the welfare of the college. In politics he was a Liberal, and

became a Liberal Unionist in 1886. Early in 1900 he was forced by ill-health to resign his professorship, and he died on the 28th of August of the same year.

Though in many ways an excellent teacher he was primarily a student, and treated his pupils as fellow-learners. He was deeply interested in psychical phenomena, but his energies were primarily devoted to the study of religion and philosophy. Brought up in the Church of England, he gradually drifted from orthodox Christianity, and as early as 1862 he described himself as a theist. For the rest of his life, though he regarded Christianity as "indispensable and irreplaceable—looking at it from a sociological point of view," he found himself unable to return to it as a religion. In political economy he was a Utilitarian on the lines of Mill and Bentham; his work was the careful investigation of first principles and the investigation of ambiguities rather than constructive. In philosophy he devoted himself to ethics, and especially to the examination of the ultimate intuitive principles of conduct and the problem of free will. He gave up the psychological hedonism of Mill, and adopted instead a position which may be described as ethical hedonism, according to which the criterion of goodness in any given action is that it produces the greatest possible amount of pleasure. This hedonism, however, is not confined to the self (egoistic), but involves a due regard to the pleasure of others, and is, therefore, distinguished further as universalistic. Lastly, Sidgwick returns to the principle that no man should act so as to destroy his own happiness, and leaves us with a somewhat unsatisfactory dualism.

His chief works are *Principles of Political Economy* (1883, 3rd ed. 1901); *Scope and Method of Economic Science* (1885); *Outlines of the History of Ethics* (1886, 5th ed. 1902), enlarged from his article ETHICS in the *Encyclopaedia Britannica*; *Elements of Politics* (1891, 2nd ed. 1897), an attempt to supply an adequate treatise on the subject starting from the old lines of Bentham and Mill. The following were published posthumously: *Philosophy; its Scope and Relations* (1902); *Lectures on the Ethics of T. H. Green, Mr Herbert Spencer and J. Martineau* (1902); *The Development of European Polity* (1903); *Miscellaneous Essays and Addresses* (1904); *Lectures on the Philosophy of Kant* (1905).

His younger brother, ARTHUR SIDGWICK, had a brilliant school and university career, being second classic at Cambridge in 1863 and becoming fellow of Trinity; but he devoted himself thenceforth mainly to work as a teacher. After being for many years a master at Rugby, he became in 1882 fellow and tutor of Corpus, Oxford; and from 1894 to 1906 was Reader in Greek in the university. He published a number of admirable classical school-books, including *Greek Prose* (1876) and *Greek Verse* (1882), and texts (*Virgil*, 1890; *Aeschylus*, 1880–1903), and was well known as a consummate classical scholar, remarkable for literary taste and general culture. In the college life of Corpus he took the deepest interest and had the most stimulating influence; and he also played an active part in social and political movements from an advanced Liberal point of view.

A *Memoir* of Henry Sidgwick, written by his brother with the collaboration of his widow, was published in 1906.

SIDI-BEL-ABBES, chief town of an arrondissement in the department of Oran, Algeria, 48 m. by rail S. of Oran, 1,552 ft. above the sea, on the right bank of the Mekerra. Pop. (1906) of the town, 24,404 (of whom three-fourths are French or Spaniards); of the commune, 29,088; of the arrondissement, which includes 17 communes, 98,309. The town, which occupies an important strategic position in the plain dominated by the escarpments of Mount Tessala, has barrack accommodation for 6000 troops, and is the headquarters of the 1^{er} régiment étranger, one of the two regiments known as the Foreign Legion. It is encircled by a crenellated and bastioned wall with a fosse, and has four gates, named after Oran, Daia, Mascara and Tlemçen respectively. Starting from the gates, two broad streets, shaded by plane trees, traverse the town east to west and north to south, the latter dividing the civil from the military quarters. There are numerous fountains fed by the Mekerra. Sidi-bel-Abbes is also an important agricultural centre, wheat, tobacco and alfa being the chief articles of trade. There are numerous vineyards and olive-

groves in the vicinity. The town, founded by the French, derives its name from the kubba (tomb) of a marabout named Sidi-bel-Abbes, near which a redoubt was constructed by General Bedeau in 1843. The site of the town, formerly a swamp, has been thoroughly drained. The surrounding country is healthy, fertile and populous.

SIDMOUTH, HENRY ADDINGTON, 1ST VISCOUNT (1757–1844), English statesman, son of Dr Anthony Addington, was born on the 30th of May 1757. Educated at Winchester College and Brasenose College, Oxford, he graduated in 1778, and took the chancellor's prize for an English essay in 1779. Owing to his friendship with William Pitt he turned his attention to politics, and after his election as member of parliament for Devizes in 1784 gave a silent but steady support to the ministry of his friend. By close attention to his parliamentary duties, he obtained a wide knowledge of the rules and procedure of the House of Commons, and this fact together with his intimacy with Pitt, and his general popularity, secured his election as Speaker in June 1789. Like his predecessors, Addington continued to be a partisan after his acceptance of this office, took part at times in debate when the house was in committee; and on one occasion his partiality allowed Pitt to disregard the authority of the chair. He enjoyed the confidence of George III., and in the royal interest tried to induce Pitt to withdraw his proposal for a further instalment of relief to Roman Catholics. Rather than give way on this question Pitt resigned office early in 1801, when both he and the king urged Addington to form a government. Addington consented, and after some delay caused by the king's illness, and by the reluctance of several of Pitt's followers to serve under him, became first lord of the treasury and chancellor of the exchequer in March 1801. The new prime minister, who was specially acceptable to George, was loyally supported by Pitt; and his first important work, the conclusion of the treaty of Amiens in March 1802, made him popular in the country. Signs, however, were not wanting that the peace would soon be broken, and Pitt, dissatisfied with the ministry for ignoring the threatening attitude of Napoleon, and making no preparations for a renewal of the war, withdrew his support. Addington then took steps to strengthen the forces of the crown, and suggested to Pitt that he should join the cabinet and that both should serve under a new prime minister. This offer was declined, and a similar fate befell Addington's subsequent proposal to serve under Pitt. When the struggle with France was renewed in May 1803, it became evident that as a war minister Addington was not a success; and when Pitt became openly hostile, the continued confidence of the king and of a majority in the House of Commons was not a sufficient counterpoise to the ministry's waning prestige. Although careful and industrious, Addington had no brilliant qualities, and his mediocrity afforded opportunity for attack by his enemies. Owing to his father's profession he was called in derision "the doctor," and George Canning, who wrote satirical verses at his expense, referred to him on one occasion as "happy Britain's guardian gander." Without waiting for defeat in the House he resigned office in April 1804, and became the leader of the party known as the "king's friends." Pitt, who now returned to office, was soon reconciled with his old friend; in January 1805 Addington was created Viscount Sidmouth, and became lord president of the council. He felt aggrieved, however, because his friends were not given a larger share of power, and when Pitt complained because some of them voted against the ministry, Sidmouth left the cabinet in July 1805. In February 1806 he became lord privy seal in the ministry of Fox and Grenville, but resigned early in 1807 when the government proposed to throw open commissions in the army and navy to Roman Catholics and Protestant dissenters; in 1812 he joined the cabinet of Spencer Perceval as lord president of the council, becoming home secretary when the ministry was reconstructed by the earl of Liverpool in the following June. The ten years during which he held this office coincided with much misery and unrest among the labouring classes, and the government policy, for which he was mainly responsible, was one of severe repression. In 1817 the Habeas Corpus Act

was suspended, and Sidmouth issued a circular to the lords-lieutenant declaring that magistrates might apprehend and hold to bail persons accused on oath of seditious libels. For this step he was severely attacked in parliament, and was accused of fomenting rebellion by means of his spies. Although shaken by the acquittal of William Hone on a charge of libel the government was supported by parliament; and after the "Manchester massacre" in August 1819 the home secretary thanked the magistrates and soldiers for their share in quelling the riot. He was mainly responsible for the policy embodied in the "Six Acts" of 1819. In December 1821 Sidmouth resigned his office, but remained a member of the cabinet without official duties until 1824, when he resigned owing to his disapproval of the recognition of the independence of Buenos Aires. Subsequently he took very little part in public affairs; but true to his earlier principles he spoke against Catholic emancipation in April 1829, and voted against the Reform Bill in 1832. He died at his residence in Richmond Park on the 15th of February 1844, and was buried at Mortlake. In 1781 he married Ursula Mary, daughter of Leonard Hammond of Cheam, Surrey, who died in 1811, leaving a son, William Leonard, who succeeded his father as Viscount Sidmouth, and four daughters. In 1823 he married secondly Marianne, daughter of William Scott, Baron Stowell (d. 1836), and widow of Thomas Townsend of Honington, Warwickshire. Sidmouth suffers by comparison with the great men of his age, but he was honest and courageous in his opinions, loyal to his friends, and devoted to church and state.

The 2nd Viscount Sidmouth (1794–1864) was a clergyman of the Church of England; he was succeeded as 3rd Viscount by his son, William Wells Addington (b. 1824).

See Hon. G. Pellet, *Life of Sidmouth* (London, 1847); Lord John Russell, *Life and Times of C. J. Fox* (London, 1859–1866); Earl Stanhope, *Life of Pitt* (London, 1861–1862); Sir G. C. Lewis, *Essays on the Administrations of Great Britain* (London, 1864); Spencer Walpole, *History of England* (London, 1878–1886). (A. W. H. *)

SIDMOUTH, a market town and watering-place in the Honiton parliamentary division of Devonshire, England, on the river Sid and the English Channel, 167 $\frac{3}{4}$ m. W. by S. of London, by the London & South-Western railway. Pop. of urban district (1901) 4201. Lying in a hollow, the town is shut in by hills which terminate in the forelands of Salcombe and High Peak, two sheer cliffs of a deep red colour. The shore line curves away, beyond these, westward to the Start and eastward to Portland—both visible from Sidmouth beach. The restored church of St Nicholas, dating from the 13th century, though much altered in the 15th, contains a window given by Queen Victoria in 1866 in memory of her father, the duke of Kent, who lived at Woolbrook Glen, close by, and died there in 1820. An esplanade is built along the sea-wall, and the town possesses golf links and other recreation grounds. The bathing is good, the climate warm. Formerly of some importance, the harbour can no longer be entered by large vessels, and goods are transhipped into flat-bottomed lighters for conveyance ashore. Fishing is extensively carried on and cattle fairs are held. In the 13th century Sidmouth was a borough governed by a port-reeve. Tradition tells of an older town buried under the sea; and Roman coins and other remains have been washed up on the beach. Traces of an ancient camp exist on High Peak.

SIDNEY (OR SYDNEY), **ALGERNON** (1622–1683), English politician, second son of Robert, 2nd earl of Leicester, and of Dorothy Percy, daughter of Henry, 9th earl of Northumberland, was born at Penshurst, Kent, in 1622. As a boy he showed much talent, which was carefully trained under his father's eye. In 1632 with his elder brother Philip he accompanied his father on his mission as ambassador extraordinary to Christian IV. of Denmark, whom he saw at Rendsburg. In May 1636 Sidney went with his father to Paris, where he became a general favourite, and from there to Rome. In October 1641 he was given a troop in his father's regiment in Ireland, of which his brother, known as Lord Lisle, was in command. In August 1643 the brothers returned to England. At Chester their horses were taken by the Royalists, whereupon they again put out to sea and landed at Liverpool. Here they were detained by the Parliamentary

commissioners, and by them sent up to London for safe custody. Whether this was intended by Sidney or no, it is certain that from this time he ardently attached himself to the Parliamentary cause. On the 10th of May 1644 he was made captain of horse in Manchester's army, under the Eastern Association. He was shortly afterwards made lieutenant-colonel, and charged at the head of his regiment at Marston Moor (2nd July), where he was wounded and rescued with difficulty. On the 2nd of April 1645 he was given the command of a cavalry regiment in Cromwell's division of Fairfax's army, was appointed governor of Chichester on 10th May, and in December was returned to parliament for Cardiff. In July 1646 he went to Ireland, where his brother was lord-lieutenant, and was made lieutenant-general of horse in that kingdom and governor of Dublin. Leaving London on 1st of February 1647, Sidney arrived at Cork on the 22nd. He was soon (8th April), however, recalled by a resolution of the House passed through the interest of Lord Inchiquin. On the 7th of May he received the thanks of the House of Commons. On the 13th of October 1648 he was made lieutenant of Dover castle, of which he had previously been appointed governor. He was at this time identified with the Independents as opposed to the Presbyterian party. He was nominated one of the commissioners to try Charles I., but took no part in the trial, retiring to Penshurst until sentence was pronounced. That Sidney approved of the trial, though not of the sentence, there can, however, be little doubt, for in Copenhagen he publicly and vigorously expressed his concurrence. On the 15th of May 1649 he was a member of the committee for settling the succession and for regulating the election of future parliaments. Sidney lost the governorship of Dover, however, in March 1651, in consequence, apparently, of a quarrel with his officers. He then went to the Hague, where he quarrelled with Lord Oxford at play, and a duel was only prevented by their friends. He returned to England in the autumn, and henceforward took an active share in parliamentary work. On the 25th of November Sidney was elected on the council of state and was evidently greatly considered. In the usurpation of Cromwell, however, he utterly refused all concurrence, nor would he leave his place in parliament except by force when Cromwell dispersed it on the 20th of April 1653. He immediately retired to Penshurst, where he was concerned chiefly with family affairs. In 1654 he again went to the Hague, and there became closely acquainted with De Witt. On his return he kept entirely aloof from public affairs, and it is to this period that the *Essay on Love* is ascribed.

Upon the restoration of the Long Parliament, in May 1659, Sidney again took his seat, and was placed on the council of state. He showed himself in this office especially anxious that the military power should be duly subordinated to the civil. In June he was appointed one of three commissioners to mediate for a peace between Denmark, supported by Holland, and Sweden. He was probably intended to watch the conduct of his colleague, Admiral Montagu (afterwards 1st earl of Sandwich), who was in command of the Baltic squadron. Of his character we have an interesting notice from Whitelocke, who refused to accompany him on the ground of his "overruling temper and height." Upon the conclusion of the treaty he went to Stockholm as plenipotentiary; and in both capacities he behaved with resolution and address. When the restoration of Charles II. took place Sidney left Sweden, on the 28th of June 1660, bringing with him from the king of Sweden a rich present in testimony of the estimation in which he was held. Sidney went first to Copenhagen, and then, being doubtful of his reception by the English court, settled at Hamburg. From there he wrote a celebrated letter vindicating his conduct, which will be found in the *Somers Tracts*. He shortly afterwards left Hamburg, and passed through Germany by way of Venice to Rome. His stay there, however, was embittered by misunderstandings with his father and consequent straits for money. Five shillings a day, he says, served him and two men very well for meat, drink and firing. He devoted himself to the study of books, birds and trees, and speaks of his natural delight in solitude being largely increased. In 1663 he left Italy, passed through Switzerland,

where he visited Ludlow, and came to Brussels in September, where his portrait was painted by van Egmond; it is now at Penshurst. He had thoughts of joining the imperial service, and offered to transport from England a body of the old Commonwealth men; but this was refused by the English court. It is stated that the enmity against him was so great that now, as on other occasions, attempts were made to assassinate him. On the breaking out of the Dutch war, Sidney, who was at the Hague, urged an invasion of England, and shortly afterwards went to Paris, where he offered to raise a rebellion in England on receipt of 100,000 crowns. Unable, however, to come to terms with the French government, he once more went into retirement in 1666,—this time to the south of France. In August 1670 he was again in Paris, and Arlington proposed that he should receive a pension from Louis; Charles II. agreed, but insisted that Sidney should return to Languedoc. In illustration of his austere principles it is related that, Louis having taken a fancy to a horse belonging to him and insisting on possessing it, Sidney shot the animal, which, he said, "was born a free creature, had served a free man, and should not be mastered by a king of slaves." His father was now very ill, and after much difficulty Sidney obtained leave to come to England in the autumn of 1677. Lord Leicester died in November; and legal business connected with other portions of the succession detained Sidney from returning to France as he had intended. He soon became involved in political intrigue, joining, in general, the country party, and holding close communication with Barillon, the French ambassador. In the beginning of 1679 he stood for Guildford, and was warmly supported by William Penn, with whom he had long been intimate, and to whom he is said (as is now thought, erroneously) to have afforded assistance in drawing up the constitution of Pennsylvania. He was defeated by court influence, and his petition to the House, complaining of an undue return, never came to a decision. His *Letters to Henry Savile*, written at this period, are of great interest. He was in Paris, apparently only for a short while, in November 1679. Into the prosecution of the Popish Plot Sidney threw himself warmly, and was among those who looked to Monmouth, rather than to Orange, to take the place of James in the succession, though he afterwards disclaimed all interest in such a question. He now stood for Bramber (Sussex), again with Penn's support, and a double return was made. He is reported on the 10th of August 1679 as being elected for Amersham (Buckingham) with Sir Roger Hill. When parliament met, however, in October 1680, his election was declared void. But now, under the idea that an alliance between Charles and Orange would be more hostile to English liberty than would the progress of the French arms, he acted with Barillon in influencing members of parliament in this sense, and is twice mentioned as receiving the sum of 500 guineas from the ambassador. Of this there is no actual proof, and it is quite possible that Barillon entered sums in his accounts with Louis which he never paid away. In any case it is to be remembered that Sidney is not charged with receiving money for advocating opinions which he did not enthusiastically hold.

Upon the dissolution of the last of Charles's parliaments the king issued a justificatory declaration. This was at once answered by a paper entitled *A Just and Modest Vindication, &c.*, the first sketch of which is imputed to Sidney. It was then, too, that his most celebrated production, the *Discourses concerning Government*, was concluded, in which he upholds the doctrine of the mutual compact and traverses the High Tory positions from end to end. In especial he vindicates the propriety of resistance to kingly oppression or misrule, upholds the existence of an hereditary nobility interested in their country's good as the firmest barrier against such oppression, and maintains the authority of parliaments. In each point the English constitution, which he ardently admires, is, he says, suffering: the prerogatives of the crown are disproportionately great; the peerage has been degraded by new creations; and parliaments are slighted.

For a long while Sidney kept himself aloof from the duke of Monmouth, to whom he was introduced by Lord Howard. After

the death of Shaftesbury, however, in November 1682, he entered into the conferences held between Monmouth, Russell, Essex, Hampden and others. That treasonable talk went on seems certain, but it is probable that matters went no further. The watchfulness of the court was, however, aroused, and on the discovery of the Rye House Plot, Sidney, who had always been regarded in a vague way as dangerous, was arrested while at dinner on the 26th of June 1683. His papers were carried off, and he was sent at once to the Tower on a charge of high treason. For a considerable while no evidence could be found on which to establish a charge. Jeffreys, however, was made lord chief-justice in September; a jury was packed; and, after consultations between the judge and the crown lawyers, Sidney was brought to listen to the indictment on the 7th of November. The trial began on the 21st of November: Sidney was refused a copy of the indictment, in direct violation of law, and he was refused the assistance of counsel. Hearsay evidence and the testimony of the perjured informer Lord Howard, whom Sidney had been instrumental in introducing to his friends, were first produced. This being insufficient, partial extracts from papers found in Sidney's study, and supposed only to be in his handwriting, in which the lawfulness of resistance to oppression was upheld, were next relied on. He was indicted for "conspiring and compassing the death of the king." Sidney conducted his case throughout with great skill; he pointed especially to the fact that Lord Howard, whose character he easily tore to shreds, was the only witness against him as to treason, whereas the law required two, that the treason was not accurately defined, that no proof had been given that the papers produced were his, and that, even if that were proved, these papers were in no way connected with the charge. Against the determination to secure a conviction, however, his courage, eloquence, coolness and skill were of no avail, and the verdict of "guilty" was given. On the 25th of November Sidney presented a petition to the king, praying for an audience, which, however, under the influence of James and Jeffreys, Charles refused. On the 26th he was brought up for judgment, and again insisted on the illegality of his conviction. Upon hearing his sentence he gave vent to his feelings in a few noble and beautiful words. Jeffreys having suggested that his mind was disordered, he held out his hand and bade the chief-justice feel how calm and steady his pulse was. By the advice of his friends he presented a second petition, offering, if released, to leave the kingdom at once and for ever. The supposed necessity, however, of checking the hopes of Monmouth's partisans caused the king to be inexorable. The last days of Sidney's life were spent in drawing up his *Apology* and in discourse with Independent ministers. He was beheaded on the morning of the 7th of December 1683. His remains were buried at Penshurst. (O. A.)

SIDNEY, SIR HENRY (1520-1586), lord deputy of Ireland, was the eldest son of Sir William Sidney, a prominent politician and courtier in the reigns of Henry VIII. and Edward VI., from both of whom he received extensive grants of land, including the manor of Penshurst in Kent, which became the principal residence of the family. Henry was brought up at court as the companion of Prince Edward, afterwards King Edward VI.; and he continued to enjoy the favour of the sovereign throughout the reigns of Edward and Mary. In 1556 he went to Ireland with the lord deputy, the earl of Sussex, who in the previous year had married his sister Frances Sidney; and from the first he had a large share in the administration of the country, especially in the military measures taken by his brother-in-law for bringing the native Irish chieftains into submission to the English Crown. In the course of the lord deputy's Ulster expedition in 1557 Sidney devastated the island of Rathlin; and during the absence of Sussex in England in the following year Sidney was charged with the sole responsibility for the government of Ireland, which he conducted with marked ability and success. A second absence of the lord deputy from Ireland, occasioned by the accession of Queen Elizabeth, threw the chief control into Sidney's hands at the outbreak of trouble with Shane O'Neill, and he displayed great skill in temporizing with that

redoubtable chieftain till Sussex reluctantly returned to his duties in August 1559. About the same time Sidney resigned his office of vice-treasurer of Ireland on being appointed president of the Welsh Marches, and for the next few years he resided chiefly at Ludlow Castle, with frequent visits to the court in London.

In 1565 Sidney was appointed lord deputy of Ireland in place of Sir Nicholas Arnold, who had succeeded the earl of Sussex in the previous year. He found the country in a more impoverished and more turbulent condition than when he left it, the chief disturbing factor being Shane O'Neill in Ulster. With difficulty he persuaded Elizabeth to sanction vigorous measures against O'Neill; and although the latter successfully avoided a decisive encounter, Sidney restored O'Neill's rival Calvagh O'Donnell to his rights, and established an English garrison at Derry which did something to maintain order. In 1567 Shane was murdered by the MacDonnells of Antrim (see O'NEILL), and Sidney was then free to turn his attention to the south, where with vigour and determination he arranged the quarrel between the earls of Desmond and Ormonde, and laid his hand heavily on other disturbers of the peace; then, returning to Ulster, he compelled Turlough Luineach O'Neill, Shane's successor in the clan chieftainship, to make submission, and placed garrisons at Belfast and Carrickfergus to overawe Tyrone and the Glynnns. In the autumn of 1567 Sidney went to England, and was absent from Ireland for the next ten months. On his return he urged upon Cecil the necessity for measures to improve the economic condition of Ireland, to open up the country by the construction of roads and bridges, to replace the Ulster tribal institutions by a system of freehold land tenure, and to repress the ceaseless disorder prevalent in every part of the island. In pursuance of this policy Sidney dealt severely with the unruly Butlers in Munster. At Kilkenny large numbers of Sir Edmund Butler's followers were hanged, and three of Ormonde's brothers were attainted by an act of the Irish parliament in 1570. Enlightened steps were taken for the education of the people, and encouragement was given to Protestant refugees from the Netherlands to settle in Ireland.

Sidney left Ireland in 1571, aggrieved by the slight appreciation of his statesmanship shown by the queen; but he returned thither in September 1575 with increased powers and renewed tokens of royal approval, to find matters in a worse state than before, especially in Antrim, where the MacQuillins of the Route and Sorley Boy MacDonnell (*q.v.*) were the chief fomenters of disorder. Having to some extent pacified this northern territory, Sidney repaired to the south, where he was equally successful in making his authority respected. He left his mark on the administrative areas of the island by making shire divisions on the English model. At an earlier period he had already in the north combined the districts of the Ardes and Clondeboye to form the county of Carrickfergus, and had converted the country of the O'Farrells into the county of Longford; he now carried out a similar policy in Connaught, where the ancient Irish district of Thomond became the county Clare, and the countics of Galway, Mayo, Sligo and Roscommon were also delimited. He suppressed a rebellion headed by the earl of Clanricarde and his sons in 1576, and hunted Rory O'More to his death two years later. Meantime Sidney's methods of taxation had caused discontent among the gentry of the Pale, who carried their grievances to Queen Elizabeth. Greatly to Sidney's chagrin the queen censured his extravagance, and notwithstanding his distinguished services to the crown he was recalled in September 1578, and was coldly received by Elizabeth. He lived chiefly at Ludlow Castle for the remainder of his life, performing his duties as president of the Welsh Marches, and died there on the 5th of May 1586.

Sir Henry Sidney was the ablest statesman charged with the government of Ireland in the 16th century; and the meagre recognition which his unrewarded services received was a conspicuous example of the ingratitude of Elizabeth. Sidney married in 1551 Mary, eldest daughter of John Dudley, duke of Northumberland, by whom he had three sons and four daughters. His eldest son was Sir Philip Sidney (*q.v.*), and his second was

Robert Sidney, 1st earl of Leicester (*q.v.*); his daughter Mary married Henry Herbert, 2nd earl of Pembroke, and by reason of her association with her brother Philip was one of the most celebrated women of her time (see PEMBROKE, EARLS OF).

See *Calendar of State Papers relating to Ireland, Henry VIII.-Elizabeth*; *Calendar of the Carew MSS.*; J. O'Donovan's edition of *The Annals of Ireland by the Four Masters* (7 vols., Dublin, 1851); Holinshed's *Chronicles*, vol. iii. (6 vols., London, 1807); Richard Bagwell, *Ireland under the Tudors* (3 vols., London, 1885); *Calendar of Ancient Records of Dublin*, edited by Sir J. T. Gilbert, vols. i. and ii. (Dublin, 1889); Sir J. T. Gilbert, *History of the Viceroy's of Ireland* (Dublin, 1865); J. A. Froude, *History of England* (12 vols., London, 1856-1870). (R. J. M.)

SIDNEY, SIR PHILIP (1554-1586), English poet, statesman and soldier, eldest son of Sir Henry Sidney and his wife Mary Dudley, was born at Penshurst on the 30th of November 1554. His father, Sir Henry Sidney (1529-1586), was three times lord deputy of Ireland, and in 1560 became lord president of Wales. Philip Sidney's childhood was spent at Penshurst; and before he had completed his tenth year he was nominated by his father lay rector of Whitford, Flintshire. A deputy was appointed, and Philip enjoyed the revenue of the benefice for the rest of his life. On the 17th of October 1564 he was entered at Shrewsbury school, not far from his father's official residence at Ludlow Castle, on the same day with his life-long friend and first biographer, Fulke Greville. An affectionate letter of advice from his father and mother, written about 1565, was preserved and printed in 1591 (*A Very Godly Letter . . .*). In 1568 Sidney was sent to Christ Church, Oxford, where he formed lasting friendships with Richard Hakluyt and William Camden. But his chief companion was Fulke Greville, who had gone to Broadgates Hall (Pembroke College). Sir Henry Sidney was already anxious to arrange an advantageous marriage for his son, who was at that time heir to his uncle, the earl of Leicester; and Sir William Cecil agreed to a betrothal with his daughter Anne. But in 1571 the match was broken off, and Anne Cecil married Edward Vere, 17th earl of Oxford. In that year Philip left Oxford, and, after some months spent chiefly at court, received the queen's leave in 1572 to travel abroad "for his attaining the knowledge of foreign languages."

He was attached to the suite of the earl of Lincoln, who was sent to Paris in that year to negotiate a marriage between Queen Elizabeth and the duc d'Alençon. He was in the house of Sir Francis Walsingham in Paris during the massacre of Saint Bartholomew, and the events he witnessed no doubt intensified his always militant Protestantism. In charge of Dr Watson, dean, and afterwards bishop, of Winchester, he left Paris for Lorraine, and in March of the next year had arrived in Frankfort on the Main. He lodged there in the house of the learned printer Andrew Wechel, among whose guests was also Hubert Languet. Fulke Greville describes Philip Sidney when a schoolboy as characterized by "such staidness of mind, lovely and familiar gravity, which carried grace and reverence far above greater years." "Though I lived with him, and knew him from a child," he says, "yet I never knew him other than a man." These qualities attracted to him the friendship of grave students of affairs, and in France he formed close connexions with the Huguenot leaders. Languet, who was an ardent supporter of the Protestant cause, conceived a great affection for the younger man, and travelled in his company to Vienna. In October Sidney left for Italy, having first of all entered into a compact with his friend to write every week. This arrangement was not strictly observed, but the extant letters, more numerous on Languet's side than on Sidney's, afford a considerable insight into Sidney's moral and political development. Languet's letters abound with sensible and affectionate advice on his studies and his affairs generally.

Sidney settled for some time in Venice, and in February 1574 he sat to Paolo Veronese for a portrait, destined for Languet. His friends seem to have feared that his zeal for Protestantism might be corrupted by his stay in Italy, and Languet exacted from him a promise that he would not go to Rome. In July he was seriously ill, and immediately on his recovery started for

Vienna. From there he accompanied Languet to Poland, where he is said to have been asked to become a candidate for the vacant crown. On his return to Vienna he fulfilled vague diplomatic duties at the imperial court, perfecting himself meanwhile, in company with Edward Wotton, in the art of horsemanship under John Pietro Pugliano, whose skill and wit he celebrates in the opening paragraph of the *Defence of Poesie*. He addressed a letter from Vienna on the state of affairs to Lord Burghley, in December 1574. In the spring of 1575 he followed the court to Prague, where he received a summons to return home, apparently because Sir Francis Walsingham, who was now secretary of state, feared that Sidney had leanings to Catholicism.

His sister, Mary Sidney, was now at court, and he had an influential patron in his uncle, the earl of Leicester. He accompanied the queen on one of her royal progresses to Kenilworth, and afterwards to Chartley Castle, the seat of Walter Devereux, earl of Essex. There he met Penelope Devereux, the "Stella" of the sonnets, then a child of twelve. Essex went to Ireland in 1576 to fill his office as earl marshal, and in September occurred his mysterious death. Philip Sidney was in Ireland with his father at the time. Essex on his deathbed had desired a match between Sidney and his daughter Penelope. Sidney was often harassed with debt, and seems to have given no serious thought to the question for some time, but Edward Waterhouse, an agent of Sir Henry Sidney, writing in November 1576, mentions "the treaty between Mr Philip and my Lady Penelope" (*Sidney Papers*, i. p. 147). In the spring of 1577 Sidney was sent to congratulate Louis, the new elector Palatine, and Rudolf II., who had become emperor of Germany. He received also general instructions to discuss with various princes the advancement of the Protestant cause.

After meeting Don John of Austria at Louvain, March 1577, he proceeded to Heidelberg and Prague. He persuaded the elector's brother, John Casimir, to consider proposals for a league of Protestant princes, and also for a conference among the Protestant churches. At Prague he ventured on a harangue to the emperor, advocating a general league against Spain and Rome. This address naturally produced no effect, but does not seem to have been resented as much as might have been expected. On the return journey he visited William of Orange, who formed a high opinion of Sidney. In April 1577 Mary Sidney married Henry Herbert, 2nd earl of Pembroke, and in the summer Philip paid the first of many visits to her at her new home at Wilton. But later in the year he was at court defending his father's interests, particularly against the earl of Ormonde, who was doing all he could to prejudice Elizabeth against the lord deputy.

Sidney drew up a detailed defence of his father's Irish government, to be presented to the queen. A rough draft of four of the seven sections of this treatise is preserved in the British Museum (*Cotton MS.*, Titus B, xii. pp. 557-559), and even in its fragmentary condition it justifies the high estimate formed of it by Edward Waterhouse (*Sidney Papers*, p. 228). Sidney watched with interest the development of affairs in the Netherlands, but was fully occupied in defending his father's interests at court. He came also in close contact with many men of letters. In 1578 he met Edmund Spenser, who in the next year dedicated to him his *Shepherd's Calendar*. With Sir Edward Dyer he was a member of the Areopagus, a society which sought to introduce classical metres into English verse, and many strange experiments were the result. In 1578 the earl of Leicester entertained Elizabeth at Wanstead, Essex, with a masque, *The Lady of the May*, written for the occasion by Philip Sidney. But though Sidney enjoyed a high measure of the queen's favour, he was not permitted to gratify his desire for active employment. He was already more or less involved in the disgrace of his uncle Leicester, following on that nobleman's marriage with Lettice, countess of Essex, when, in 1579, he had a quarrel on the tennis-court at Whitehall with the earl of Oxford. Sidney proposed a duel, which was forbidden by Elizabeth. There was more in the quarrel than appeared on the surface. Oxford was one of the chief supporters of the queen's proposed marriage with Alençon,

now duc d'Anjou, and Sidney, in giving the lie to Oxford, affronted the leader of the French party. In January 1580 he went further in his opposition to the match, addressing to Elizabeth a long letter in which the arguments against the alliance were elaborately set forth. This letter (*Sidney Papers*, pp. 287-292), in spite of some judicious compliments, was regarded, not unnaturally, by the queen as an intrusion. Sidney was compelled to retire from court, and some of his friends feared for his personal safety. A letter from Languet shows that he had written to Elizabeth at the instigation of "those whom he was bound to obey," probably Leicester and Walsingham.

Sidney retired to Wilton, or the neighbouring village of Ivychurch, where he joined his sister in writing a paraphrase of the Psalms. Here too he began his *Arcadia*, for his sister's amusement and pleasure. In October 1580 he addressed a long letter of advice, not without affectionate and colloquial interruptions, to his brother Robert, then about to start on his continental tour. This letter (*Sidney Papers*, p. 283) was printed in *Profitable Instructions for Travellers* (1633). It seems that a promise was exacted from him not to repeat his indiscretions in the matter of the French marriage, and he returned to court. In view of the silence of contemporary authority, it is hardly possible to assign definite dates to the sonnets of *Astrophel and Stella*. Penelope Devereux was married against her will to Robert, Lord Rich, in 1581, probably very soon after the letter from Penelope's guardian, the earl of Huntingdon, desiring the queen's consent. The earlier sonnets are not indicative of overwhelming passion, and it is a reasonable assumption that Sidney's liking for Penelope only developed into passion when he found that she was passing beyond his grasp. Mr A. W. Pollard assigns the magnificent sequence beginning with No. 33—

"I might! unhappy word—O me, I might,
And then would not, or could not, see my blisse,"—

to the period following on Stella's reappearance at court as Lady Rich. It has been argued that the whole tenor of Philip's life and character was opposed to an overmastering passion, and that there is no ground for attaching biographical value to these sonnets, which were merely Petrarchan exercises. That Sidney was, like his contemporaries, a careful and imitative student of French and Italian sonnets is patent. He himself confesses in the first of the series that he "sought fit words to paint the blackest face of woe," by "oft turning others' leaves" before he obeyed the command of his muse to "look in his heart and write." The account of his passion is, however, too circumstantial to be lightly regarded as fiction. Mr Pollard sees in the sonnets a description of a spiritual struggle between his sense of a high political mission and a disturbing passion calculated to lessen his efforts in a larger sphere. It seems certain, at any rate, that he was not solely preoccupied with scruples against his love for Stella because she was already married. He had probably been writing sonnets to Stella for a year or more before her marriage, and he seems to have continued to address her after his own marriage. Thomas Nash defined the general argument epigrammatically as "cruel chastity—the prologue Hope, the epilogue Despair." But after Stella's final refusal Sidney recovered his earlier serenity, and the sonnet placed by Mr Pollard at the end of the series—"Leave me, O Love, which reachest but to dust"—expresses the triumph of the spirit.

Meanwhile he prosecuted his duties as a courtier and as member for Kent in parliament. On the 15th and 16th of May 1581 he was one of the four challengers in a tournament arranged in honour of the visit of the duke of Anjou. In 1579 Stephen Gosson had dedicated to Sidney his *School of Abuse*, an attack on the stage, and incidentally on poetry. Sidney was probably moved by this treatise to write his own *Apologie for Poetrie*, dating from about 1581. In 1583 he was knighted in order that he might act as proxy for Prince John Casimir, who was to be installed as Knight of the Garter, and in the autumn of that year he married Frances, daughter of his friend and patron Sir Francis Walsingham, a girl of fourteen or fifteen years of age. In 1584 he met Giordano Bruno at the house of his friend Fulke Greville, and two of the philosopher's books are dedicated to him.

Sidney was employed about this time in the translation from the French of his friend Du Plessis Mornay's treatise on the Christian religion. He still desired active service and took an eager interest in the enterprises of Martin Frobisher, Richard Hakluyt and Walter Raleigh. In 1584 he was sent to France to condole with Henry III. on the death of his brother, the duke of Anjou, but the king was at Lyons, and unable to receive the embassy. Sidney's interest in the struggle of the Protestant princes against Spain never relaxed. He recommended that Elizabeth should attack Philip II. in Spain itself. So keen an interest did he take in this policy that he was at Plymouth about to sail with Francis Drake's fleet in its expedition against the Spanish coast (1585) when he was recalled by the queen's orders. He was, however, given a command in the Netherlands, where he was made governor of Flushing. Arrived at his post, he constantly urged resolute action on his commander, the earl of Leicester, but with small result. In July 1586 he made a successful raid on Axel, near Flushing, and in September he joined the force of Sir John Norris, who was operating against Zutphen. On the 22nd of the month he joined a small force sent out to intercept a convoy of provisions. During the fight that ensued he was struck in the thigh by a bullet. He succeeded in riding back to the camp. The often-told story that he refused a cup of water in favour of a dying soldier, with the words, "Thy need is greater than mine," is in keeping with his character. He owed his death to a quixotic impulse. Sir William Pelham happening to set out for the fight without greaves, Sidney also cast off his leg-armour, which would have defended him from the fatal wound. He died twenty-five days later at Arnheim, on the 17th of October 1586. The Dutch desired to have the honour of his funeral, but the body was taken to England, and, after some delay due to the demands of Sidney's creditors, received a public funeral in St Paul's Cathedral on the 16th of February 1587.

Sidney's death was a personal grief to people of all classes. Some two hundred elegies were produced in his honour. Of all these tributes the most famous is *Astrophel, A Pastoral Elegie*, added to Edmund Spenser's *Colin Clout's Come Home Again* (1595). Spenser wrote the opening poem; other contributors are Sidney's sister, the countess of Pembroke, Lodowick Bryskett and Matthew Roydon. In the bare enumeration of Sidney's achievements there seems little to justify the passionate admiration he excited. So calm an observer as William of Orange desired Fulke Greville to give Elizabeth "his knowledge and opinion of a fellow-servant of his, that (as he heard) lived unemployed under her. . . . If he could judge, her Majesty had one of the ripest and greatest counsellors of estate in Sir Philip Sidney, that this day lived in Europe" (Fulke Greville, *Life of Sidney*, ed. 1816, p. 21). His fame was due first of all to his strong, radiant and lovable character. Shelley placed him in *Adonais* among the "inheritors of unfulfilled renown," as "sublimely mild, a spirit without spot."

Sidney left a daughter Frances (b. 1584), who married Roger Manners, earl of Rutland. His widow, who, in spite of the strictures of some writers, was evidently sincerely attached to him, married in 1590 Robert Devereux, second earl of Essex, and, after his death in 1601, Richard de Burgh, earl of Clanricarde.

Sidney's writings were not published during his lifetime. *A Worke concerning the trewnesse of the Christian Religion*, translated from the French of Du Plessis Mornay, was completed and published by Arthur Golding in 1587.

The Countesse of Pembroke's Arcadia written by Philippe Sidnei (1590), in quarto, is the earliest edition of Sidney's famous romance.¹ A folio edition, issued in 1593, is stated to have been revised and rearranged by the countess of Pembroke, for whose delectation the romance was written. She was charged to destroy the work sheet by sheet as it was sent to her. The circumstances of its composition partly explain the difference between its intricate sentences, full of far-fetched conceits, repetition and antithesis, and the simple and dignified phrase of the *Apologie for Poetrie*. The style is a concession to the fashionable taste in

¹ For a bibliography of this and subsequent editions see the facsimile reprint (1891) of this quarto, edited by Dr Oskar Sommer.

literature which the countess may reasonably be supposed to have shared; but Sidney himself, although he was no friend to euphuism, was evidently indulging his own mood in this highly decorative prose. The main thread of the story relates how the princes Musidorus and Pyrocles, the latter disguised as a woman, Zelmane, woo the princesses Pamela and Philoclea, daughters of Basilius and Gynaecia, king and queen of Arcady. The shepherds and shepherdesses occupy a humble place in the story. Sidney used a pastoral setting for a romance of chivalry complicated by the elaborate intrigue of Spanish writers. Nor are these intrigues of a purely innocent and pastoral nature. Sidney described the passion of love under many aspects, and the guilty queen Gynaecia is a genuine tragic heroine. The loose framework of the romance admits of descriptions of tournaments, Elizabethan palaces and gardens and numerous fine speeches. It also contains some lyrics of much beauty. Charles I. recited and copied out shortly before his death Pamela's prayer, which is printed in the *Eikon Basilike*. Milton reproached him in the *Eikonoklastes* with having "borrowed to a Christian use prayers offered to a heathen god . . . and that in no serious book, but in the vain amatorial poem of Sir Philip Sidney's *Arcadia*." Professor Courthope (*Hist. of English Poetry*, i. 215) points out that the tragedy of Sidney's life, the divorce between his ideals of a nobly active life and the enforced idleness of a courtier's existence, is intimately connected with his position as a pioneer in fiction, in which the life represented is tacitly recognized as being contrary to the order of existence. Sidney's wide acquaintance with European literature is reflected in this book, but he was especially indebted to the *Arcadia* of Jacopo Sannazaro, and still more to George Montemayor's imitation of Sannazaro, the *Diana Enamorada*. The artistic defects of the *Arcadia* in no way detracted from its popularity. Both Shakespeare and Spenser were evidently acquainted with it. John Day's *Ile of Guls*, and the plots of Beaumont and Fletcher's *Cupid's Revenge*, and of James Shirley's *Arcadia*, were derived from it. The book had more than one supplement. Gervase Markham, Sir William Alexander (earl of Stirling) and Richard Beling wrote continuations.

The series of sonnets to Stella were printed in 1591 as *Sir P.S.: His Astrophel and Stella*, by Thomas Newman, with an introductory epistle by T. Nash, and some sonnets by other writers. In the same year Newman issued another edition with many changes in the text and without Nash's preface. His first edition was (probably later) reprinted by Matthew Lownes. In 1598 the sonnets were reprinted in the folio edition of Sidney's works, entitled from its most considerable item *The Countesse of Pembroke's Arcadia*, edited by Lady Pembroke, with considerable additions. The songs are placed in their proper position among the sonnets, instead of being grouped at the end, and two of the most personal poems (possibly suppressed out of consideration for Lady Rich in the first instance), which afford the best key to the interpretation of the series, appear for the first time. Sidney's sonnets adhere more closely to French than to Italian models. The octave is generally fairly regular on two rhymes, but the sestet usually terminates with a couplet. The *Apologie for Poetrie* was one of the "additions" to the countess of Pembroke's *Arcadia* (1598), where it is entitled "The Defence of Poesie." It first appeared separately in 1594 (unique copy in the Rowfant Library, reprint 1904, Camb. Univ. Press). Sidney takes the word "poetry" in the wide sense of any imaginative work, and deals with its various divisions. Apart from the subject matter, which is interesting enough, the book has a great value for the simple, direct and musical prose in which it is written. *The Psalmes of David*, the paraphrase in which he collaborated with his sister, remained in MS. until 1823, when it was edited by S. W. Singer. A translation of part of the *Divine Sepmaine* of G. Salluste du Bartas is lost. There are two pastorals by Sidney in Davison's *Poetical Rhapsody* (1602).

Letters and Memorials of State . . . (1746) is the title of an invaluable collection of letters and documents relating to the Sidney family, transcribed from originals at Penshurst and elsewhere by Arthur Collins. Fulke Greville's *Life of the Renowned Sir Philip Sidney* is a panegyric dealing chiefly with his public policy. The

Correspondence of Sir Philip Sidney and Hubert Languet was translated from the Latin and published with a memoir by Steuart A. Pears (1845). The best biography of Sidney is *A Memoir of Sir Philip Sidney* by H. R. Fox Bourne (1862). A revised life by the same author is included in the "Heroes of the Nations" series (1891). Critical appreciation is available in J. A. Symonds's *Sir Philip Sidney* (1886), in the "English Men of Letters" series; in J. J. A. Jusserand's *English Novel in the Time of Shakespeare* (1890); and in modern editions of Sidney's works, among which may be mentioned Mr A. W. Pollard's edition (1888) of *Astrophel and Stella*, Professor Arber's reprint (1868) of *An Apologie for Poetrie*, and Mr Sidney Lee's *Elizabethan Sonnets* (1904) in the re-issue of Professor Arber's *English Garner*, where the sources of Sidney's sonnets are fully discussed. See also a collection of *Sidneiana* printed for the Roxburgh Club in 1837, a notice by Mrs Humphry Ward in *Ward's English Poets*, i. 341 seq., and a dissertation by Dr K. Brunhuber, *Sir Philip Sidney's Arcadia und ihre Nachläufer* (Nürnberg, 1903). A complete text of Sidney's prose and poetry, edited by Albert Feuillerat, is to be included in the Cambridge English Classics.

SIDNEY, a city and the county-seat of Shelby county, Ohio, U.S.A., on the Miami river, about 33 m. S. by W. of Lima. Pop. (1890) 4850; (1900) 5688, including 282 foreign-born and 108 negroes; (1910) 6607. Sidney is served by the Cleveland, Cincinnati, Chicago & St Louis, the Cincinnati, Hamilton & Dayton, and the Western Ohio (electric) railways. The city is situated on an elevated tableland, in an agricultural region. Sidney has a public library, and a monumental building, a memorial, erected in 1875, to the soldiers in the American Civil War, and now devoted to various public uses. The river here provides some water-power, and the city has various manufactures. Sidney was laid out as the county-seat in 1810, was incorporated as a village in 1831 and first chartered as a city in 1897.

SIDON (Phoen. שִׁדוֹן, Hebrew שִׁדוֹן, Assyr. *Šidunnu*, Egypt. *Diduna*), formerly the principal city of Phoenicia, now a small town of about 15,000 inhabitants, situated on the Syrian coast between Beirūt and Šūr (Tyre). The name, which the Arabs now pronounce Šaida, has been explained as meaning "fish-town" (cf. Hebr. שָׂדֵה "to hunt," in Phoen. perhaps "to fish"); more likely it is connected with the god Šid, who is known only as an element in proper names (see Cooke, *North-Sem. Inscr.* p. 91); possibly both town and people were named after him. The ancient city extended some 800 yds. inland from the shore over ground which is now covered by fruit-gardens. From a series of inscriptions, all giving the same text, discovered at Bostan esh-Shēkh, a little way to the N. of Šaida, we learn that the ancient city was divided into three divisions at least, one of which was called "Sidon by the sea," and another "Sidon on the plain" (?) (see *N.-Sem. Inscr.* App. i.). In front of the flat promontory to which the modern Sidon is confined there stretches northwards and southwards a rocky peninsula; at the northern extremity of this begins a series of small rocks enclosing the harbour, which is a very bad one. The port was formerly protected on the north by the Qal'at el-Bahr ("Sea Castle"), a building of the 13th century, situated on an island still connected with the mainland by a bridge. On the S. side of the town lay the so-called Egyptian harbour, which was filled up in the 17th century in order to keep out the Turks. The wall by which Sidon is at present surrounded is pierced by two gates; at the southern angle, upon a heap of rubbish, stand the remains of the citadel. The streets are very narrow, and the buildings of any interest few; most prominent are some large caravanserais belonging to the period of Sidon's modern prosperity, and the large mosque, formerly a church of the knights of St John. The inhabitants support themselves mainly on the produce of their luxuriant gardens; but the increasing trade of Beirūt has withdrawn the bulk of the commerce from Sidon. In earlier days Phoenicia produced excellent wine, that of Sidon being specially esteemed; it is mentioned in an Aramaic papyrus from Egypt (4th century B.C., *N.S.I.* p. 213). One of the chief industries of Sidon used to be the manufacture of glass from the fine sand of the river Belus. To the S.E. of the town lies the Phoenician necropolis, which has been to a great extent investigated. The principal finds are sarcophagi, and next to these sculptures and paintings. It was here that the superb Greek

sarcophagi, which are now in the Imperial Museum at Constantinople, were found, and the sarcophagi of the two Sidonian kings Eshmunazar (Louvre) and Tabnith (Imperial Museum, Constantinople), both of them with important Phoenician inscriptions.

The ancient history of Sidon is discussed in the article PHOENICIA. In A.D. 325 a bishop of Sidon attended the Council of Nicaea. In 637-638 the town was taken by the Arabs. During the Crusades it was alternately in the possession of the Franks and the Mahomedans, but finally fell into the hands of the latter in 1201. As the residence of the Druse Amir Fakhr ud-Din, it rose to some prosperity about the beginning of the 17th century, but towards the close of the 18th its commerce again passed away and has never returned. The biblical references to Sidon are Gen. x. 15 (the people), xlix. 13; Is. xxiii. 1-14; Ezek. xxvii. 8; Acts xxvii. 3. Sidon is nearly always mentioned along with Tyre—Jer. xxvii. 3, xlvii. 4; Ezra iii. 7; Joel iii. 4; Mark iii. 8 and Luke vi. 17; Mark vii. 24, 31, and Matt. xv. 21; Matt. xi. 21 and Luke x. 13 f.; Acts xii. 20. In the Old Testament, as frequently in Greek literature, "Sidonians" is used not in a local but in an ethnic sense, and means "Phoenicians," hence the name of Sidon was familiar to the Greeks earlier than that of Tyre, though the latter was the more important city (ed. Meyer, *Encycl. Bibl.* col. 4505).

See Robinson, *Bibl. Res.* ii. 478 ff.; Prutz, *Aus Phönicien* (1876), 98 ff.; Pietschmann, *Gesch. d. Phönizier* (1889), 53-58; Hamdy Bey and T. Reinach, *Nécropole royale à Sidon* (1892-1896); A. Socin in Baedeker, *Pal. u. Syrien*. (G. A. C. *)

SIEBENGBIRGE ("The Seven Hills"), a cluster of hills in Germany, on the Rhine, 6 m. above Bonn. They are of volcanic origin, and form the north-western spurs of the Westerwald. In no part of the Rhine valley is the scenery more attractive; crag and forest, deep dells and gentle vine-clad slopes, ruined castles and extensive views over the broad Rhine and the plain beyond combine to render the Siebengebirge the most favourite tourist resort on the whole Rhine. The hills are as follows: the steep Drachenfels (1067 ft.), abutting on the Rhine and surmounted by the ruins of an old castle; immediately behind it, and connected by a narrow ridge, the Wolkenburg (1076 ft.); lying apart, and to the N. of these, the Petersberg (1096 ft.), with a pilgrimage chapel of St Peter; then, to the S. of these three, a chain of four—viz. the Ölberg (1522 ft.), the highest of the range; the Löwenburg (1506 ft.); the Lohrberg (1444 ft.), and, farthest away, the Nonnenstromberg (1107 ft.). At the foot of the Drachenfels, on the north side, lies the little town of Königswinter, whence a mountain railway ascends to the summit, and a similar railway runs up the Petersberg. The ruins which crown almost every hill are those of strongholds of the archbishops of Cologne and mostly date from the 12th century.

See von Dechen, *Geognostischer Führer in das Siebengebirge* (Bonn, 1861); von Stürtz, *Führer durch das Siebengebirge* (Bonn, 1893); Laspeyres, *Dos Siebengebirge am Rhein* (Bonn, 1901).

SIEBOLD, CARL THEODOR ERNST VON (1804-1885), German physiologist and zoologist, the son of a physician and a descendant of what Lorenz Oken called the "Asclepiad family of Siebolds," was born at Würzburg on the 16th of February 1804. Educated in medicine and science chiefly at the university of Berlin, he became successively professor of zoology, physiology and comparative anatomy in Königsberg, Erlangen, Freiburg, Breslau and Munich. In conjunction with F. H. Stannius he published (1845-1848) a *Manual of Comparative Anatomy*, and along with R. A. Kölliker he founded in 1848 a journal which soon took a leading place in biological literature, *Zeitschrift für wissenschaftliche Zoologie*. He was also a laborious and successful helminthologist and entomologist, in both capacities contributing many valuable papers to his journal, which he continued to edit until his death at Munich on the 7th of April 1885. In these ways, without being a man of marked genius, but rather an industrious and critical observer, he came to fill a peculiarly distinguished position in science, and was long reckoned, what his biographer justly calls him, the Nestor of German zoology.

See Ehlers, *Zeitschr. f. wiss. Zool.* (1885).

SIEBOLD, PHILIPP FRANZ VON (1796-1866), scientific explorer of Japan, elder brother of the physiologist, was born

at Würzburg, Germany, on the 17th of February 1796. He studied medicine and natural science at Würzburg, and obtained his doctor's diploma in 1820. In 1822 he entered the service of the king of the Netherlands as medical officer to the East Indian Army. On his arrival at Batavia he was attached to a new mission to Japan, sent by the Dutch with a view to improve their trading relations with that country. Siebold was well equipped with scientific apparatus, and he remained in Japan for six years, with headquarters at the Dutch settlement on the little island of Deshima. His medical qualifications enabled him to find favour with the Japanese, and he gathered a vast amount of information concerning a country then very little known, especially concerning its natural history and ethnography. He had comparatively free access to the interior, and his reputation spreading far and wide brought him visitors from all parts of the country. His valuable stores of information were enriched by trained natives whom he sent to collect for him in the interior. In 1824 he published *De historiae naturalis in Japonia statu* and in 1832 his splendid *Fauna Japonica*. His knowledge of the language enabled him also in 1826 to issue from Batavia his *Epitome linguae Japonicae*. In Deshima he also laid the foundation of his *Catalogus librorum Japonicorum* and *Isagoge in bibliothecam Japonicam*, published after his return to Europe, as was his *Bibliotheca Japonica*, which, with the co-operation of J. Hoffmann, appeared at Leiden in 1833. During the visit which he was permitted to make to Yedo (Tokio), Siebold made the best of the rare opportunity; his zeal, indeed, outran his discretion, since, for obtaining a native map of the country, he was thrown into prison and compelled to quit Japan on the 1st of January 1830. On his return to Holland he was raised to the rank of major, and in 1842 to that of colonel. After his arrival in Europe he began to give to the world the fruits of his researches and observations in Japan. His *Nippon; Archiv zur Beschreibung von Japan und dessen Neben- und Schutz-Ländern* was issued in five quarto volumes of text, with six folio volumes of atlas and engravings. He also issued many fragmentary papers on various aspects of Japan. In 1854 he published at Leiden *Urkundliche Darstellung der Bestrebungen Nederlands und Russlands zur Eröffnung Japans*. In 1859 Siebold undertook a second journey to Japan, and was invited by the emperor to his court. In 1861 he obtained permission from the Dutch government to enter the Japanese service as negotiator between Japan and the powers of Europe, and in the same year his eldest son was made interpreter to the English embassy at Yedo. Siebold was, however, soon obliged by various intrigues to retire from his post, and ultimately from Japan. Returning by Java to Europe in 1862, he set up his ethnographical collections, which were ultimately secured by the government of Bavaria and removed to Munich. He continued to publish papers on various Japanese subjects, and received honours from many of the learned societies of Europe. He died at Munich on the 18th of October 1866.

See biography by Moritz Wagner, in *Allgemeine Zeitung*, 13th to 16th of November 1866.

SIEDLCE (Russian *Syedlets*), a government of Russian Poland, between the Vistula and the Bug, having the governments of Warsaw on the W., Lomza on the N., Grodno and Volhynia on the E., Lublin on the S., and Radom on the S.W. Its area is 5533 sq. m. The surface is mostly flat, only a few hilly tracts appearing in the middle, around Biala, and in the east on the banks of the Bug. Extensive marshes occur in the north and in the south-east. Cretaceous, Jurassic and Tertiary strata cover the surface, and are overlain by widely spread Glacial deposits. The valley of the Vistula is mostly wide, with several terraces covered with sand-dunes or peat-bogs. Siedlce is drained by the Vistula, which borders it for 50 m. on the west; by the Bug, which is navigable from Opalin in Volhynia and flows for 170 m. on the east and north-east borders; by the Wieprz, a tributary of the Vistula, which is also navigable, and flows for 25 m. along the southern boundary; and by the Liwiec, a tributary of the Bug, which is navigable for some 30 m. below Wegrow. Of the total area only 5.2% is unproductive; 48.1% is under crops and 17.2 under meadows and pasture land. The estimated

population in 1906 was 907,700. The inhabitants consist of Little Russians (40%), Poles (43%), Jews (15½%) and Germans (1½%). The government is divided into nine districts, the chief towns of which are the capital Siedlce, Biala, Konstantinow, Garwolin, Lukow, Radzyn, Sokolow, Wegrow, Wlodawa. The main occupation is agriculture, the principal crops being rye, wheat, oats, barley and potatoes. The area under forests amounts to 19.6% of the total. Live-stock breeding is second in importance to agriculture. Manufactures and trade are insignificant.

SIEDLCE, a town of Russia, capital of the government of the same name, 56 m. E.S.E. of the city of Warsaw, on the Brest-Litovsk railway. It is a Roman Catholic episcopal see. The Oginskis, to whom it belonged, have embellished it with a palace and gardens; but it is nothing more than a large village. Pop. 23,714 (1897), two-thirds Jews.

SIEGBURG, a town of Germany, in the Prussian Rhine Province, on the river Sieg, 16 m. by rail S.E. of Cologne by the railway to Giessen. Pop. (1905) 14,878. It has a royal shell factory, calico-printing mills, lignite mines, stone quarries and pottery and tobacco factories. The parish church, dating from the 13th century, possesses several richly decorated reliquaries of the 12th to 15th centuries. The buildings of the Benedictine abbey, founded in 1066, are now used as a prison. The town, which was founded in the 11th century, attained the height of its prosperity in the 15th and 16th centuries owing to its pottery wares. Siegburg pitchers (*Siegburger Krüge*) were widely famed. Their shape was often fantastic and they are now eagerly sought by collectors.

See R. Heinekamp, *Siegburgs Vergangenheit und Gegenwart* (Siegburg, 1897); and Renard, *Die Kunstdenkmäler des Siegkreises* (Düsseldorf, 1907).

SIEGE (O. Fr. *sege*, *siege*, mod. *siège*, seat, ultimately from *sedere*, to sit, cf. Class. Lat. *obsidium*, a siege), the "sitting down" of an army or military force before a fortified place for the purpose of taking it, either by direct military operations or by starving it into submission (see FORTIFICATION AND SIEGECRAFT). A special form of coin is known as a "siege-piece." These are coins that were struck during a siege of a town when the ordinary mints were closed or their issues were not available. Such coins were commonly of special shape to distinguish them from the normal coinage, and were naturally of rough workmanship. A common shape for the siege pieces which were issued during the Great Rebellion was the lozenge. A noteworthy example is a shilling siege-piece struck at Newark in 1645 (see TOKEN MONEY).

SIEGEN, a town of Germany, in the Prussian province of Westphalia, situated 63 m. E. of Cologne by rail, on the Sieg, a tributary entering the Rhine opposite Bonn. Pop. (1905) 25,201. The town contains two palaces of the former princes of Nassau-Siegen, a technical and a mining school. The surrounding district, to which it gives its name, abounds in iron-mines, and iron founding and smelting are the most important branches of industry in and near the town. Large tanneries and leather works, and factories for cloth, paper and machinery, are among the other industrial establishments.

Siegen was the capital of an early principality belonging to the house of Nassau; and from 1606 onwards it gave name to the junior branch of Nassau-Siegen. Napoleon incorporated Siegen in the grand-duchy of Berg in 1806; and in 1815 the congress of Vienna assigned it to Prussia, under whose rule it has nearly quintupled its population. Rubens is said to have been born here in 1577.

See Cuno, *Geschichte der Stadt Siegen* (Dillenburg, 1873).

SIEMENS, ERNST WERNER VON (1816-1892), German electrician, was born on the 13th of December 1816 at Lenthe in Hanover. After attending the gymnasium at Lübeck, he entered the Prussian army as a volunteer, and for three years was a pupil in the Military Academy at Berlin. In 1838 he received a commission as lieutenant in the artillery, and six years later he was appointed to the responsible post of superintendent of the artillery workshops. In 1848 he had the task of protecting the port of Kiel against the Danish fleet, and as commandant of

Friedrichsort built the fortifications for the defence of Eckernförde harbour. In the same year he was entrusted with the laying of the first telegraph line in Germany, that between Berlin and Frankfort-on-Main, and with that work his military career came to an end. Thenceforward he devoted his energies to furthering the interests of the newly founded firm of Siemens and Halske, which under his guidance became one of the most important electrical undertakings in the world, with branches in different countries that gave it an international influence; in the London house he was associated with Sir William Siemens, one of his younger brothers. Although he had a decided predilection for pure research, his scientific work was naturally determined to a large extent by the demands of his business, and, as he said when he was admitted to the Berlin Academy of Sciences in 1874, the filling up of scientific voids presented itself to him as a technical necessity. Considering that his entrance into commercial life was almost synchronous with the introduction of electric telegraphy into Germany, it is not surprising that many of his inventions and discoveries relate to telegraphic apparatus. In 1847, when he was a member of the committee appointed to consider the adoption of the electric telegraph by the government, he suggested the use of gutta-percha as a material for insulating metallic conductors. Then he investigated the electrostatic charges of telegraph conductors and their laws, and established methods for testing underground and submarine cables and for locating faults in their insulation; further, he carried out observations and experiments on electrostatic induction and the retardation it produced in the speed of the current. He also devised apparatus for duplex and diplex telegraphy, and automatic recorders. In a somewhat less specialized sphere, he was an early advocate of the desirability of establishing some easily reproducible basis for the measurement of electrical resistance, and suggested that the unit should be taken as the resistance of a column of pure mercury one metre high and one square millimetre in cross-section, at a temperature of 0° C. Another task to which he devoted much time was the construction of a selenium photometer, depending on the property possessed by that substance of changing its electrical resistance according to the intensity of the light falling upon it. He also claimed to have been, in 1866, the discoverer of the principle of self-excitation in dynamo-electric machines, in which the residual magnetism of the iron of the electro-magnets is utilized for excitation, without the aid of permanent steel magnets or of a separate exciting current. In another branch of science he wrote several papers on meteorological subjects, discussing among other things the causation of the winds and the forces which produce, maintain and retard the motions of the air. In 1886 he devoted half a million marks to the foundation of the Physikalisch-Technische Reichsanstalt at Charlottenburg, and in 1888 he was ennobled. He died at Berlin on the 6th of December 1892. His scientific memoirs and addresses were collected and published in an English translation in 1892, and three years later a second volume appeared, containing his technical papers.

SIEMENS, SIR WILLIAM [KARL WILHELM] (1823-1883), British inventor, engineer and natural philosopher, was born at Lenthe in Hanover on the 4th of April 1823. After being educated in the polytechnic school of Magdeburg and the university of Göttingen, he visited England at the age of nineteen, in the hope of introducing a process in electroplating invented by himself and his brother Werner. The invention was adopted by Messrs Elkington, and Siemens returned to Germany to enter as a pupil the engineering works of Count Stolberg at Magdeburg. In 1844 he was again in England with another invention, the "chronometric" or differential governor for steam engines. Finding that British patent laws afforded the inventor a protection which was then wanting in Germany, he thenceforth made England his home; but it was not till 1859 that he formally became a naturalized British subject. After some years spent in active invention and experiment at mechanical works near Birmingham, he went into practice as an engineer in 1851. He laboured mainly in two distinct fields, the applications of heat and the applications of electricity, and was characterized

in a very rare degree by a combination of scientific comprehension with practical instinct. In both fields he played a part which would have been great in either alone; and, in addition to this, he produced from time to time miscellaneous inventions and scientific papers sufficient in themselves to have established a reputation. His position was recognized by his election in 1862 to the Royal Society, and later to the presidency of the Institution of Mechanical Engineers, the Society of Telegraph Engineers, the Iron and Steel Institute, and the British Association; by honorary degrees from the universities of Oxford, Glasgow, Dublin and Würzburg; and by knighthood (in 1883). He died in London on the 19th of November 1883.

In the application of heat Siemens's work began just after J. P. Joule's experiments had placed the doctrine of the conservation of energy on a sure basis. While Rankine, Clausius and Lord Kelvin were developing the dynamical theory of heat as a matter of physical and engineering theory, Siemens, in the light of the new ideas, made a bold attempt to improve the efficiency of the steam engine as a converter of heat into mechanical work. Taking up the regenerator—a device invented by Robert Stirling twenty years before, the importance of which had meanwhile been ignored—he applied it to the steam engine in the form of a regenerative condenser with some success in 1847, and in 1855 engines constructed on Siemens's plan were worked at the Paris exhibition. Later he also attempted to apply the regenerator to internal combustion or gas engines. In 1856 he introduced the regenerative furnace, the idea of his brother Friedrich (1826–1904), with whom he associated himself in directing its applications. In an ordinary furnace a very large part of the heat of combustion is lost by being carried off in the hot gases which pass up the chimney. In the regenerative furnace the hot gases pass through a regenerator, or chamber stacked with loose bricks, which absorb the heat. When the bricks are well heated the hot gases are diverted so to pass through another similar chamber, while the air necessary for combustion, before it enters the furnace, is made to traverse the heated chamber, taking up as it goes the heat which has been stored in the bricks. After a suitable interval the air currents are again reversed. The process is repeated periodically, with the result that the products of combustion escape only after being cooled, the heat which they take from the furnace being in great part carried back in the heated air. But another invention was required before the regenerative furnace could be thoroughly successful. This was the use of gaseous fuel, produced by the crude distillation and incomplete combustion of coal in a distinct furnace or gas-producer. From this the gaseous fuel passes by a flue to the regenerative furnace, and it, as well as the entering air, is heated by the regenerative method, four brick-stacked chambers being used instead of two. The complete invention was applied at Chance's glass-works in Birmingham in 1861, and furnished the subject of Faraday's farewell lecture to the Royal Institution. It was soon applied to many industrial processes, but it found its greatest development a few years later at the hands of Siemens himself in the manufacture of steel. To produce steel directly from the ore, or by melting together wrought-iron scrap with cast-iron upon the open hearth, had been in his mind from the first, but it was not till 1867, after two years of experiment in "sample steel works" erected by himself for the purpose, that he achieved success. The product is a mild steel of exceptionally trustworthy quality, the use of which for boiler-plates has done much to make possible the high steam-pressures that are now common, and has consequently contributed, indirectly, to that improvement in the thermodynamic efficiency of heat engines which Siemens had so much at heart. Just before his death he was again at work upon the same subject, his plan being to use gaseous fuel from a Siemens producer in place of solid fuel beneath the boiler, and to apply the regenerative principle to boiler furnaces. His faith in gaseous fuel led him to anticipate that it would in time supersede solid coal for domestic and industrial purposes, cheap gas being supplied either from special works or direct from the pit; and among his last inventions was a house grate to burn gas along with coke, which he regarded as a possible cure for city smoke.

In electricity Siemens's name is closely associated with the growth of land and submarine telegraphs, the invention and development of the dynamo, and the application of electricity to lighting and to locomotion. In 1860, with his brother Werner, he invented the earliest form of what is now known as the Siemens armature; and in 1867 he communicated a paper to the Royal Society "On the Conversion of Dynamical into Electrical Force without the aid of Permanent Magnetism," in which he announced the invention by Werner Siemens of the dynamo-electric machine, an invention which was also reached independently and almost simultaneously by Sir Charles Wheatstone and by S. A. Varley. The Siemens-Alteneck or multiple-coil armature followed in 1873. While engaged in constructing a trans-Atlantic cable for the Direct United States Telegraph Company, Siemens designed the very original and successful ship "Faraday," by which that and other cables were laid. One of the last of his works was the Portrush and Bushmills electric tramway, in the north of Ireland, opened in 1883, where the water-power

of the river Bush drives a Siemens dynamo, from which the electric energy is conducted to another dynamo serving as a motor on the car. In the Siemens electric furnace the intensely hot atmosphere of the electric arc between carbon points is employed to melt refractory metals. Another of the uses to which he turned electricity was to employ light from arc lamps as a substitute for sunlight in hastening the growth and fructification of plants. Among his miscellaneous inventions were the differential governor already alluded to, and a highly scientific modification of it, described to the Royal Society in 1866; a water-meter which acts on the principle of counting the number of turns made by a small reaction turbine through which the supply of water flows; an electric thermometer and pyrometer, in which temperature is determined by its effect on the electrical conductivity of metals; an attraction meter for determining very slight variations in the intensity of a gravity; and the bathometer, by which he applied this idea to the problem of finding the depth of the sea without a sounding line. In a paper read before the Royal Society in 1882, "On the Conservation of Solar Energy," he suggested a bold but unsatisfactory theory of the sun's heat, in which he sought to trace on a cosmic scale an action similar to that of the regenerative furnace. His fame, however, does not rest on his contributions to pure science, valuable as some of these were. His strength lay in his grasp of scientific principles, in his skill to perceive where and how they could be applied to practical affairs, in his zealous and instant pursuit of thought with action, and in the indomitable persistence with which he clung to any basis of effort that seemed to him theoretically sound.

Siemens's writings consist for the most part of lectures and papers scattered through the scientific journals and the publications of the Royal Society, the Institution of Civil Engineers, the Institution of Mechanical Engineers, the Iron and Steel Institute, the British Association, &c. A biography by Dr William Pole was published in 1888. (J. A. E.)

SIENA, a city and archiepiscopal see of Tuscany, Italy, capital of the province of Siena, 59 m. by rail S. of Florence and 31 m. direct. Pop. (1901) 25,539 (town); 40,423 (commune). The area of the city within the walls is about 2½ sq. m., and the height above sea-level 1115 ft. The plan, spreading from the centre over three hills, closely resembles that of Perugia. The city possesses a university, founded in 1203 and limited to the faculties of law and medicine. Among the other public institutions the following are the more important: the town library, first opened to students in the 17th century; the Archivio, a record office, instituted in 1858, containing a valuable and splendidly arranged collection of documents; the Fine Arts Institution, founded in 1816; and the natural history museum of the Royal Academy of the Physiocrats, inaugurated in the same year. There are also many flourishing charities, including an excellent hospital and a school for the deaf and dumb. The chief industries are weaving and agriculture.

The public festivals of Siena known as the "Palio delle Contrade" have a European celebrity. They are held in the public square, the curious and historic Piazza del Campo (now Piazza di Vittorio Emanuele) in shape resembling an ancient theatre, on the 2nd of July and the 16th of August of each year; they date from the middle ages and were instituted in commemoration of victories and in honour of the Virgin Mary (the old title of Siena, as shown by seals and medals, having been "Sena vetus civitas Virginis"). In the 15th and 16th centuries the celebrations consisted of bull-fights. At the close of the 16th century these were replaced by races with mounted buffaloes, and since 1650 by (ridden) horses. Siena is divided into seventeen *contrade* (wards), each with a distinct appellation and a chapel and flag of its own; and every year ten of these *contrade*, chosen by lot, send each one horse to compete for the prize *palio* or banner. The aspect of Siena during these meetings is very characteristic, and the whole festivity bears a medieval stamp in harmony with the architecture and history of the town.

Among the noblest fruits of Siennese art are the public buildings adorning the city. The cathedral, one of the finest examples of Italian Gothic architecture, obviously influenced in plan by the abbey of S. Galgano (*infra*), built in black and white marble, was begun in the early years of the 13th century, but interrupted by the plague of 1248 and wars at home and abroad, and in 1317 its walls were extended to the baptistery of San Giovanni; a further enlargement was begun in 1339 but never carried out, and a few ruined walls and arches alone remain to show the

magnificence of the uncompleted design, which would have produced one of the largest churches in the world.

The splendid west front, of tricuspidal form, enriched with a multitude of columns, statues and inlaid marbles, is said to have been begun by Giovanni Pisano, but really dates from after 1370; it was finished in 1380, and closely resembles that of Orvieto, which is earlier in date (begun in 1310). Both façades have been recently restored, and the effect of them not altogether improved by modern mosaics. The fine Romanesque campanile belongs to the first half of the 14th century. Conspicuous among the art treasures of the interior is the well-known octagonal pulpit by Niccolò Pisano, dating from 1266–1268. It rests on columns supported by lions, and is finely sculptured. Numerous statues and bas-reliefs by Renaissance artists adorn the various altars and chapels. The cathedral pavement is almost unique. It is inlaid with designs in colour and black and white, representing Biblical and legendary subjects, and is supposed to have been begun by Duccio della Buoninsegna. But the finest portions beneath the domes, with scenes from the history of Abraham, Moses and Elijah, are by Domenico Beccafumi and are executed with marvellous boldness and effect. The choir stalls also deserve mention: the older ones (remains of the original choir) are in *tarsia* work; the others, dating from the 16th century, are carved from Riccio's designs. The Piccolomini Library, adjoining the *duomo*, was founded by Cardinal Francesco Piccolomini (afterwards Pius III.) in honour of his uncle, Pius II. Here are Pinturicchio's famous frescoes of scenes from the life of the latter pontiff, and the collection of choir books (supported on sculptured desks) with splendid illuminations by Siennese and other artists. The church of San Giovanni, the ancient baptistery, beneath the cathedral is approached by an outer flight of marble steps built in 1451. It has a beautiful but incomplete façade designed by Giovanni di Mino del Pellicciaio in 1382, and a marvellous font with bas-reliefs by Donatello, Ghiberti, Jacopo della Quercia and other 15th-century sculptors. The Opera del Duomo contains Duccio's famous Madonna, painted for the cathedral in 1308–1311, and other works of art.

Among the other churches are S. Maria di Provenzano, a vast baroque building of some elegance, designed by Schifardini (1594); Sant' Agostino, rebuilt by Vanvitelli in 1755, containing a Crucifixion and Saints by Perugino, a Massacre of the Innocents by Matteo di Giovanni, the Coming of the Magi by Sodoma, and a St Anthony by Spagnoletto (?); the beautiful church of the Servites (15th century), which contains another Massacre of the Innocents by Matteo di Giovanni and other good examples of the Siennese school; San Francesco, designed by Agostino and Agnolo about 1326, and now restored, which once possessed many fine paintings by Duccio Buoninsegna, Lorenzetti, Sodoma and Beccafumi, some of which perished in the great fire of 1655; San Domenico, a fine 13th-century building with a single nave and transept, containing Sodoma's splendid fresco the Swoon of St Catherine, the Madonna of Guido da Siena, 1281, and a crucifix by Sano di Pietro. This church crowns the Fontebranda hill above the famous fountain of that name immortalized by Dante, and in a steep lane below stands the house of St Catherine, now converted into a church and oratory, and maintained at the expense of the inhabitants of the Contrada dell' Oca. It contains some good pictures by Pacchia and other works of art, but is chiefly visited for its historic interest and as a striking memorial of the characteristic piety of the Siennese. The Accademia di Belle Arti contains a good collection of pictures of the Siennese school, illustrating its development.

The communal palace in the Piazza del Campo was begun in 1288 and finished in 1309. It is built of brick, is a fine specimen of Pointed Gothic, and was designed by Agostino and Agnolo. The light and elegant tower (Torre del Mangia) soaring from one side of the palace was begun in 1338 and finished after 1348, and the chapel standing at its foot, raised at the expense of the Opera del Duomo as a public thank-offering after the plague of 1348, begun in 1352 and completed in 1376. This grand old palace has other attractions besides the beauty of its architecture, for its interior is lined with works of art. The atrium has a fresco by Bartolo di Fredi and the two ground-floor halls contain a Coronation of the Virgin by Sano di Pietro and a splendid Resurrection by Sodoma. In the Sala dei Nove or della Pace above are the noble allegorical frescoes of Ambrogio Lorenzetti representing the effects of just and unjust government; the Sala delle Balestre or del Mappamondo is painted by Simone di Martino (Memmi) and others, the Cappella della Signoria by Taddeo di Bartolo, and the Sala del Consistorio by Beccafumi. Another hall, the Sala di Balia, has frescoes by Spinello Aretino (1408) with scenes from the life of Pope Alexander III., while yet another has been painted by local artists with episodes in recent Italian history. An interesting exhibition of Siennese art, including many objects from neighbouring towns and villages, was held here in 1904. The former hall of the grand council, built in 1327, was converted into the chief theatre of Siena by Riccio in 1560, and, after being twice burnt, was rebuilt in 1753 from Bibbiena's designs. Another Siennese theatre that of the Rozzi, in Piazza San Pellegrino, designed by A. Doveri and erected in 1816, although modern, has an historic interest as the work of an academy dating from the 16th century, called the Congrega de' Rozzi, that played an important part in the history of the Italian comic stage.

The city is adorned by many other noble edifices both public and private, among which the following palaces may be mentioned—Tolomei (1205); Buonsignori, formerly Tegliacci, an elegant 14th-century construction, restored in 1848; Grottanelli, formerly Pecci and anciently the residence of the captain of war, recently restored in its original style; Sansedoni; Marsilii; Piccolomini, now belonging to the Government and containing the state archives;¹ Piccolomini delle Papesse, like the other Piccolomini mansion, designed by Bernardo Rossellino, and now the Banca d' Italia; the enormous block of the Monte de' Paschi, a bank of considerable wealth and antiquity, enlarged and partly rebuilt in the original style between 1877 and 1881, the old Dogana and Salimbeni palaces; the Palazzo Spannuchi, a fine early Renaissance building by Giuliano da Maiano (now the post office); the Loggia di Mercanzia (15th century), now a club, imitating the Loggia dei Lanzi at Florence, with sculptures of the 15th century; the Loggia del Papa, erected by Pius II.; and other fine buildings. We may also mention the two celebrated fountains, Fonte Gaia and Fontebranda; the former, in the Piazza del Campo, by Jacopo della Quercia (1409–1419), but freely restored in 1868, the much-damaged original reliefs being now in the Opera del Duomo; the Fonte Nuova, near Porta Ovile, by Camaino di Crescentino also deserves notice (1298). Thanks to all these architectural treasures, the narrow Siennese streets with their many windings and steep ascents are full of picturesque charm, and, together with the collections of excellent paintings, foster the local pride of the inhabitants and preserve their taste and feeling for art. The medieval walls and gates are still in the main preserved. The ruined Cistercian abbey of S. Galgano, founded in 1201, with its fine church (1240–1268) is interesting and imposing. It lies some 20 m. south-west of Siena.

History.—Siena was probably founded by the Etruscans (a few tombs of that period have been found outside Porta Camollia), and then, falling under the Roman rule, became a colony in the reign of Augustus, or a little earlier, and was distinguished by the name of *Saena Julia*. It has the same arms as Rome—the she-wolf and twins. But its real importance dates from the middle ages. Few memorials of the Roman era² or of the first centuries of Christianity have been preserved (except the legend of St Ansanus), and none at all of the interval preceding the Lombard period. We have documentary evidence that in the 7th century in the reign of Rotaris (or Rotari), there was a bishop of Siena named Mauro. Attempts to trace earlier bishops as far back as the 5th century have yielded only vague and contradictory results. Under the Lombards the civil government was in the hands of a *gastaldo*, under the Carolingians of a count, whose authority, by slow degrees and a course of events similar to what took place in other Italian communes, gave way to that of the bishop, whose power in turn gradually diminished and was superseded by that of the consuls and the commonwealth.

We have written evidence of the consular government of Siena from 1125 to 1212; the number of consuls varied from three to twelve. This government, formed of *gentiluomini* or nobles, did not remain unchanged throughout the whole period, but was gradually forced to accept the participation of the *popolani* or lower classes, whose efforts to rise to power were continuous and determined. Thus in 1137 they obtained a third part of the government by the reconstitution of the general council with 100 nobles and 50 *popolani*. In 1199 the institution of a foreign *podestà* (a form of government which became permanent in 1212) gave a severe blow to the consular magistracy, which was soon extinguished; and in 1233 the people again rose against the nobles in the hope of ousting them entirely from office.

The strife was largely economic, the people desiring to deprive the nobles of the immunity of taxation which they had enjoyed. The attempt was not completely successful; but the government was now equally divided between the two estates by the creation of a supreme magistracy of twenty-four citizens—twelve nobles and twelve *popolani*. During the rule of the nobles and the mixed rule of nobles and *popolani* the commune of Siena was enlarged by fortunate acquisitions of neighbouring lands and by the submission of feudal lords, such as the Scialenghi, Aldobrandeschi, Pannocchieschi, Visconti di Campiglia, &c.

¹ In these are especially interesting the painted covers of the books of the *bicchierna* and *gabella*, or revenue and tax offices.

² There are, however, remains of baths some 2½ m. to the east; see P. Piccolomini in *Bullettino Senese de storia patria*, vi. (1899).

Before long the reciprocal need of fresh territory and frontier disputes, especially concerning Poggibonsi and Montepulciano, led to an outbreak of hostilities between Florence and Siena. Thereupon, to spite the rival republic, the Siennese took the Ghibelline side, and the German emperors, beginning with Frederick Barbarossa, rewarded their fidelity by the grant of various privileges.

During the 12th and 13th centuries there were continued disturbances, petty wars, and hasty reconciliations between Florence and Siena, until in 1254-1255 a more binding peace and alliance was concluded. But this treaty, in spite of its apparent stability, led in a few years to a fiercer struggle; for in 1258 the Florentines complained that Siena had infringed its terms by giving refuge to the Ghibellines they had expelled, and on the refusal of the Siennese to yield to these just remonstrances both states made extensive preparations for war. Siena applied to Manfred, obtained from him a strong body of German horse, under the command of Count Giordano, and likewise sought the aid of its Ghibelline allies. Florence equipped a powerful citizen army, of which the original registers are still preserved in the volume entitled *Il Libro di Montaperti* in the Florence archives. This army, led by the podestà of Florence and twelve burgher captains, set forth gaily on its march towards the enemy's territories in the middle of April 1260, and during its first campaign, ending on the 18th of May, won an insignificant victory at Santa Petronilla, outside the walls of Siena. But in a second and more important campaign, in which the militia of the other Guelph towns of Tuscany took part, the Florentines were signally defeated at Montaperti on the 4th of September 1260. This defeat crushed the power of Florence for many years, reduced the city to desolation, and apparently annihilated the Florentine Guelphs. But the battle of Benevento (1266) and the establishment of the dynasty of Charles of Anjou on the Neapolitan throne put an end to the Ghibelline predominance in Tuscany. Ghibelline Siena soon felt the effects of the change in the defeat of its army at Colle di Valdelsa (1269) by the united forces of the Guelph exiles, Florentines and French, and the death in that battle of her powerful citizen Provenzano Salvani (mentioned by Dante), who had been the leading spirit of the government at the time of the victory of Montaperti. For some time Siena remained faithful to the Ghibelline cause; nevertheless Guelph and democratic sentiments began to make head. The Ghibellines were on several occasions expelled from the city, and, even when a temporary reconciliation of the two parties allowed them to return, they failed to regain their former influence.

Meanwhile the popular party acquired increasing power in the state. Exasperated by the tyranny of the Salimbeni and other patrician families allied to the Ghibellines, it decreed in 1277 the exclusion of all nobles from the supreme magistracy (consisting since 1270 of thirty-six instead of twenty-four members), and insisted that this council should be formed solely of Guelph traders and men of the middle class. This constitution was confirmed in 1280 by the reduction of the supreme magistracy to fifteen members, all of the humbler classes, and was definitively sanctioned in 1285 (and 1287) by the institution of the magistracy of nine. This council of nine, composed only of burghers, carried on the government for about seventy years, and its rule was sagacious and peaceful. The territories of the state were enlarged; a friendly alliance was maintained with Florence; trade flourished; in 1321 the university was founded, or rather revived, by the introduction of Bolognese scholars; the principal buildings now adorning the town were begun; and the charitable institutions, which are the pride of modern Siena, increased and prospered. But meanwhile the exclusiveness of the single class of citizens from whose ranks the chief magistrates were drawn had converted the government into a close oligarchy and excited the hatred of every other class. Nobles, judges, notaries and populace rose in frequent revolt, while the nine defended their state (1295-1309) by a strong body of citizen militia divided into *terzieri* (sections) and *contrade* (wards), and violently repressed these attempts. But in 1355 the arrival of Charles IV. in Siena gave fresh courage to the malcontents,

who, backed by the imperial authority, overthrew the government of the nine and substituted a magistracy of twelve drawn from the lowest class. These new rulers were to some extent under the influence of the nobles who had fomented the rebellion, but the latter were again soon excluded from all share in the government.

This was the beginning of a determined struggle for supremacy, carried on for many years, between the different classes of citizens, locally termed *ordini* or *monti*—the lower classes striving to grasp the reins of government, the higher classes already in office striving to keep all power in their own hands, or to divide it in proportion to the relative strength of each *monte*. As this struggle is of too complex a nature to be described in detail, we must limit ourselves to a summary of its leading episodes.

The twelve who replaced the council of nine (as these had previously replaced the council of the nobles) consisted—both as individuals and as a party—of ignorant, incapable, turbulent men, who could neither rule the state with firmness nor confer prosperity on the republic. They speedily broke with the nobles, for whose manœuvres they had at first been useful tools, and then split into two factions, one siding with the Tolomei, the other, the more restless and violent, with the Salimbeni and the *noveschi* (partisans of the nine), who, having still some influence in the city, probably fomented these dissensions, and, as we shall see later on, skilfully availed themselves of every chance likely to restore them to power. In 1368 the adversaries of the twelve succeeded in driving them by force from the public palace, and substituting a government of thirteen—ten nobles and three *noveschi*.

This government lasted only twenty-two days, from the 2nd to the 24th September, and was easily overturned by the dominant faction of the *dodicini* (partisans of the twelve), aided by the Salimbeni and the populace, and favoured by the emperor Charles IV. The nobles were worsted, being driven from the city as well as from power; but the absolute rule of the twelve was brought to an end, and right of participation in the government was extended to another class of citizens. For, on the expulsion of the thirteen from the palace, a council of 124 plebeians created a new magistracy of twelve *difensori* (defenders), no longer drawn exclusively from the order of the twelve, but composed of five of the *popolo minuto*, or lowest populace (now first admitted to the government), four of the twelve, and three of the nine. But it was of short duration, for the *dodicini* were ill satisfied with their share, and in December of the same year (1368) joined with the *popolo minuto* in an attempt to expel the three *noveschi* from the palace. But the new popular order, which had already asserted its predominance in the council of the *riformatori*, now drove out the *dodicini*, and for five days (11th to 16th December) kept the government in its own hands. Then, however, moved by fear of the emperor, who had passed through Siena two months before on his way to Rome, and who was about to halt there on his return, it tried to conciliate its foes by creating a fresh council of 150 *riformatori*, who replaced the twelve defenders by a new supreme magistracy of fifteen, consisting of eight *popolani*, four *dodicini*, and three *noveschi*, entitled respectively "people of the greater number," "people of the middle number," and "people of the less number." From this renewal dates the formation of the new order or *monte dei riformatori*, the title henceforth bestowed on all citizens, of both the less and the greater people, who had reformed the government and begun to participate in it in 1368. The turbulent action of the twelve and the Salimbeni, being dissatisfied with these changes, speedily rose against the new government. This time they were actively aided by Charles IV., who, having returned from Rome, sent his militia, commanded by the imperial vicar Malatesta da Rimini, to attack the public palace. But the Siennese people, being called to arms by the council of fifteen, made a most determined resistance, routed the imperial troops, captured the standard, and confined the emperor in the Salimbeni palace. Thereupon Charles came to terms with the government, granted it an imperial patent, and left the city, consoled for his humiliation by the gift of a large sum of money.

In spite of its wide basis and great energy, the *monte dei riformatori*, the heart of the new government, could not satisfactorily cope with the attacks of adverse factions and treacherous allies. So, the better to repress them, it created in 1369 a chief of the police, with the title of *esecutore*, and a numerous association of *popolani*—the company or *casata grande* of the people—as bulwarks against the nobles, who had been recalled from banishment, and who, though fettered by strict regulations, were now eligible for offices of the state. But the appetite for power of the “less people” and the dregs of the populace was whetted rather than satisfied by the installation of the *riformatori* in the principal posts of authority. Among the wool-carders—men of the lowest class, dwelling in the precipitous lanes about the Porta Oville—there was an association styling itself the “company of the worm.” During the famine of 1371 this company rose in revolt, sacked the houses of the rich, invaded the public palace, drove from the council of fifteen the four members of the twelve and the three of the nine, and replaced them by seven tattered demalions. Then, having withdrawn to its own quarter, it was suddenly attacked by the infuriated citizens (*noveschi* and *dodicini*), who broke into houses and workshops and put numbers of the inhabitants to the sword without regard for age or sex. Thereupon the popular rulers avenged these misdeeds by many summary executions in the piazza. These disorders were only checked by fresh changes in the council of fifteen. It was now formed of twelve of the greater people and three *noveschi*, to the total exclusion of the *dodicini*, who, on account of their growing turbulence, were likewise banished from the city.

Meanwhile the government had also to contend with difficulties outside the walls. The neighbouring lords attacked and ravaged the municipal territories; grave injuries were inflicted by the mercenary bands, especially by the Bretons and Gascons. The rival claims to the Neapolitan kingdom of Carlo di Durazzo and Louis of Anjou caused fresh disturbances in Tuscany. The Siene government conceived hopes of gaining possession of the city of Arezzo, which was first occupied by Durazzo's men, and then by Enguerrand de Coucy for Louis of Anjou; but while the Siene were nourishing dreams of conquest the French general unexpectedly sold the city to the Florentines, whose negotiations had been conducted with marvellous ability and despatch (1384). The gathering exasperation of the Siene, and notably of the middle class, against their rulers was brought to a climax by this cruel disappointment. Their discontent had been gradually swelled by various acts of home and foreign policy during the sixteen years' rule of the *riformatori*, nor had the concessions granted to the partisans of the twelve and the latter's recall and renewed eligibility to office availed to conciliate them. At last the revolt broke out and gained the upper hand, in March 1385. The *riformatori* were ousted from power and expelled the city, and the trade of Siena suffered no little injury by the exile of so many artisan families. The fifteen were replaced by a new supreme magistracy of ten priors, chosen in the following proportions—four of the twelve, four of the nine, and two of the people proper, or people of the greater number, but to the exclusion of all who had shared in the government or sat in council under the *riformatori*. Thus began a new order or *monte del popolo*, composed of families of the same class as the *riformatori*, but having had no part in the government during the latter's rule. But, though now admitted to power through the burgher reaction, as a concession to democratic ideas, and to cause a split among the greater people, they enjoyed very limited privileges.¹

In 1387 fresh quarrels with Florence on the subject of Montepulciano led to an open war, that was further aggravated by the interference in Tuscan affairs of the ambitious duke of Milan, Gian Galeazzo Visconti. With him the Siene concluded an alliance in 1389 and ten years later accepted his suzerainty and resigned the liberties of their state. But in 1402 the death of

Gian Galeazzo lightened their yoke. In that year the first plot against the Viscontian rule, hatched by the twelve and the Salimbeni and fomented by the Florentines, was violently repressed, and caused the twelve to be again driven from office; but in the following year a special *balìa*, created in consequence of that riot, annulled the ducal suzerainty and restored the liberties of Siena. During the interval the supreme magistracy had assumed a more popular form. By the partial readmission of the *riformatori* and exclusion of the twelve, the permanent *balìa* was now composed of nine priors (three of the nine, three of the people, and three of the *riformatori*) and of a captain of the people to be chosen from each of the three *monti* in turn. On 11th April peace was made with the Florentines and Siena enjoyed several years of tranquil prosperity.

But the great Western schism then agitating the Christian world again brought disturbance to Siena. In consequence of the decisions of the council of Pisa, Florence and Siena had declared against Gregory XII. (1409); Ladislaus of Naples, therefore, as a supporter of the pope, seized the opportunity to make incursions on Siene territory, laying it waste and threatening the city. The Siene maintained a vigorous resistance till the death of this monarch in 1414 freed them from his attacks. In 1431 a fresh war with Florence broke out, caused by the latter's attempt upon Lucca, and continued in consequence of the Florentines' alliance with Venice and Pope Eugenius IV., and that of the Siene with the duke of Milan and Sigismund, king of the Romans. This monarch halted at Siena on his way to Rome to be crowned, and received a most princely welcome. In 1433 the opposing leagues signed a treaty of peace, and, although it was disadvantageous to the Siene and temptations to break it were frequently urged upon them, they faithfully adhered to its terms. During this period of comparative tranquillity Siena was honoured by the visit of Pope Eugenius IV. (1443) and by that of the emperor Frederick III., who came there to receive his bride, Eleanor of Portugal, from the hands of Bishop Aeneas Sylvius Piccolomini, his secretary and historian (1452). This meeting is recorded by the memorial column still to be seen outside the Camollia gate. In 1453 hostilities against Florence were again resumed, on account of the invasions and ravages of Siene territory committed by Florentine troops in their conflicts with Alphonso of Naples, who since 1447 had made Tuscany his battleground. Peace was once more patched up with Florence in 1454. Siena was next at war for several years with Aldobrandino Orsini, count of Pitigliano, and with Jacopo Piccinini, and suffered many disasters from the treachery of its generals. About the same time the republic was exposed to still graver danger by the conspiracy of some of its leading citizens to seize the reins of power and place the city under the suzerainty of Alphonso, as it had once been under that of the duke of Milan. But the plot came to light; its chief ringleaders were beheaded, and many others sent into exile (1456); and the death of Alphonso at last ended all danger from that source. During those critical times the government of the state was strengthened by a new executive magistracy called the *balìa*, which from 1455 began to act independently of the priors or consistory. Until then it had been merely a provisional committee annexed to the latter. But henceforward the *balìa* had supreme jurisdiction in all affairs of the state, although always, down to the fall of the republic, nominally preserving the character of a magistracy extraordinary. The election of Aeneas Sylvius Piccolomini to the papal chair in 1458 caused the utmost joy to the Siene; and in compliment to their illustrious fellow-citizen they granted the request of the nobles and readmitted them to a share in the government. But this concession, grudgingly made, only remained in force for a few years, and on the death of the pope (1464) was revoked altogether, save in the case of members of the Piccolomini house, who were decreed to be *popolani* and were allowed to retain all their privileges. Meanwhile fresh discords were brewing among the plebeians at the head of affairs.

The conspiracy of the Pazzi in 1478 led to a war in which Florence and Milan were opposed to the pope and the king of Naples, and which was put an end to by the peace of 13th

¹ The following are the *ordini* or *monti* that held power in Siena for any considerable time—*gentiluomini*, from the origin of the republic; *nove*, from about 1285; *dodici*, from 1355; *riformatori*, from 1368; *popolo*, from 1385.

March 1480. Thereupon Alphonso, duke of Calabria, who was fighting in Tuscany on the side of his father Ferdinand, came to an agreement with Siena and, in the same way as his grandfather Alphonso, tried to obtain the lordship of the city and the recall of the exiled rebels in 1456. The *noveschi* (to whose order most of the rebels belonged) favoured his pretensions, but the *riformatori* were against him. Many of the people sided with the *noveschi*, rose in revolt on 22nd June 1480 and, aided by the duke's soldiery, reorganized the government to their own advantage. Dividing the power between their two orders of the nine and the people, they excluded the *riformatori* and replaced them by a new and heterogeneous order styled the *aggregati*, composed of nobles, exiles of 1456 and citizens of other orders who had never before been in office. But this violent and perilous upset of the internal liberties of the republic did not last long. A decree issued by the Neapolitan king (1482) depriving the Siense of certain territories in favour of Florence entirely alienated their affections from that monarch. Meanwhile the *monte* of the nine, the chief promoters of the revolution of 1480, were exposed to the growing hatred and envy of their former allies, the *monte del popolo*, who, conscious of their superior strength and numbers, now sought to crush the *noveschi* and rise to power in their stead. This change of affairs was accomplished by a series of riots between 7th June 1482 and 20th February 1483. The *monte del popolo* seized the lion's share of the government; the *riformatori* were recalled, the *aggregati* abolished and the *noveschi* condemned to perpetual banishment from the government and the city. But "in perpetuo" was an empty form of words in those turbulent Italian republics. The *noveschi*, being "fat burghers" with powerful connexions, abilities and traditions, gained increased strength and influence in exile; and five years later, on 22nd July 1487, they returned triumphantly to Siena, dispersed the few adherents of the *popolo* who offered resistance, murdered the captain of the people, reorganized the state, and placed it under the protection of the Virgin Mary. And, their own predominance being assured by their numerical strength and influence, they accorded equal shares of power to the other *monti*.

Among the returned exiles was Pandolfo Petrucci, chief of the *noveschi* and soon to be at the head of the government. During the domination of this man (who, like Lorenzo de' Medici, was surnamed "the Magnificent") Siena enjoyed many years of splendour and prosperity. We use the term "domination" rather than "signory" inasmuch as, strictly speaking, Petrucci was never lord of the state, and left its established form of government intact; but he exercised despotic authority in virtue of his strength of character and the continued increase of his personal power. He based his foreign policy on alliance with Florence and France, and directed the internal affairs of the state by means of the council (*collegio*) of the *balia*, which, although occasionally reorganized for the purpose of conciliating rival factions, was always subject to his will. He likewise added to his power by assuming the captainship of the city guard (1495), and later by the purchase from the impoverished commune of several outlying castles (1507). Nor did he shrink from deeds of bloodshed and revenge; the assassination of his father-in-law, Niccolò Borghesi (1500), is an indelible blot upon his name. He successfully withstood all opposition within the state, until he was at last worsted in his struggle with Cesare Borgia, who caused his expulsion from Siena in 1502. But through the friendly mediation of the Florentines and the French king he was recalled from banishment on 29th March 1503. He maintained his power until his death at the age of sixty on 21st May 1512, and was interred with princely ceremonials at the public expense. The predominance of his family in Siena did not last long after his decease. Pandolfo had not the qualities required to found a dynasty such as that of the Medici. He lacked the lofty intellect of a Cosimo or a Lorenzo, and the atmosphere of liberty-loving Siena with its ever-changing factions was in no way suited to his purpose. His eldest son, Borghese Petrucci, was incapable, haughty and exceedingly corrupt; he only remained three years at the head of affairs and fled ignominiously in 1515. Through

the favour of Leo X., he was succeeded by his cousin Raffaello Petrucci, previously governor of St Angelo and afterwards a cardinal.

This Petrucci was a bitter enemy to Pandolfo's children. He caused Borghese and a younger son named Fabio to be proclaimed as rebels, while a third son, Cardinal Alphonso, was strangled by order of Leo X. in 1518. He was a tyrannical ruler, and died suddenly in 1522. In the following year Clement VII. insisted on the recall of Fabio Petrucci; but two years later a fresh popular outbreak drove him from Siena for ever. The city then placed itself under the protection of the emperor Charles V., created a magistracy of "ten conservators of the liberties of the state" (December 1524), united the different *monti* in one named the "*monte* of the reigning nobles," and, rejoicing to be rid of the last of the Petrucci, dated their public books, *ab instaurata libertate* year I., II., and so on.

The so-called free government subject to the empire lasted for twenty-seven years; and the desired protection of Spain weighed more and more heavily until it became a tyranny. The imperial legates and the captains of the Spanish guard in Siena crushed both government and people by continual extortions and by undue interference with the functions of the *balia*. Charles V. passed through Siena in 1535, and, as in all the other cities of enslaved Italy, was received with the greatest pomp; but he left neither peace nor liberty behind him. From 1527 to 1545 the city was torn by faction fights and violent revolts against the *noveschi*, and was the scene of frequent bloodshed; while the quarrelsomeness and bad government of the Siense gave great dissatisfaction in Tuscany. The *balia* was reconstituted several times by the imperial agents—in 1530 by Don Lopez di Soria and Alphonso Piccolomini, duke of Amalfi, in 1540 by Granvella (or Granvelle) and in 1548 by Don Diego di Mendoza; but government was carried on as badly as before, and there was increased hatred of the Spanish rule. When in 1549 Don Diego announced the emperor's purpose of erecting a fortress in Siena to keep the citizens in order, the general hatred found vent in indignant remonstrance. The historian Orlando Malavolti and other special envoys were sent to the emperor in 1550 with a petition signed by more than a thousand citizens praying him to spare them so terrible a danger; but their mission failed: they returned unheard. Meanwhile Don Diego had laid the foundation of the citadel and was carrying on the work with activity. Thereupon certain Siense citizens in Rome, headed by Aeneas Piccolomini (a kinsman of Pius II.), entered into negotiations with the agents of the French king and, having with their help collected men and money, marched on Siena and forced their way in by the new gate (now Porta Romana) on 26th July 1552. The townspeople, encouraged and reinforced by this aid from without, at once rose in revolt, and, attacking the Spanish troops, disarmed them and drove them to take refuge in the citadel (28th July). And finally by an agreement with Cosimo de' Medici, duke of Florence, the Spaniards were sent away on the 5th August 1552 and the Siense took possession of their fortress.

The government was now reconstituted under the protection of the French agents; the *balia* was abolished, its very name having been rendered odious by the tyranny of Spain, and was replaced by a similar magistracy styled *capitani del popolo e reggimento*. Siena exulted in her recovered freedom; but her sunshine was soon clouded. First, the emperor's wrath was stirred by the influence of France in the counsels of the republic; then Cosimo, who was no less jealous of the French, conceived the design of annexing Siena to his own dominions. The first hostilities of the imperial forces in Val di Chiana (1552-1553) did little damage; but when Cosimo took the field with an army commanded by the marquis of Marignano the ruin of Siena was at hand. On 26th January Marignano captured the forts of Porta Camollia (which the whole population of Siena, including the women, had helped to construct) and invested the city. On the 2nd of August of the same year, at Marciano in Val di Chiana, he won a complete victory over the Siense and French troops under Piero Strozzi, the Florentine exile and

marshal of France. Meanwhile Siena was vigorously besieged, and its inhabitants, sacrificing everything for their beloved city, maintained a most heroic defence. A glorious record of their sufferings is to be found in the *Diary of Sozzini*, the Siennese historian, and in the *Commentaries* of Blaise de Monluc, the French representative in Siena. But in April 1555 the town was reduced to extremity and was forced to capitulate to the emperor and the duke. On 21st April the Spanish troops entered the gates; thereupon many patriots abandoned the city and, taking refuge at Montalcino, maintained there a shadowy form of republic until 1559.

Cosimo I. de' Medici being granted the investiture of the Siennese state by the patent of Philip II. of Spain, dated 3rd July 1557, took formal possession of the city on the 19th of the same month. A lieutenant-general was appointed as representative of his authority; the council of the *balìa* was reconstituted with twenty members chosen by the duke; the consistory and the general council were left in existence but deprived of their political autonomy. Thus Siena was annexed to the Florentine state under the same ruler and became an integral part of the grand-duchy of Tuscany. Nevertheless it retained a separate administration for more than two centuries, until the general reforms of the grand-duke Pietro Leopoldo, the French domination, and finally the restoration swept away all differences between the Siennese and Florentine systems of government. In 1859 Siena was the first Tuscan city that voted for annexation to Piedmont and the monarchy of Victor Emmanuel II., this decision (voted 26th June) being the initial step towards the unity of Italy.

Literary History.—The literary history of Siena, while recording no gifts to the world equal to those bequeathed by Florence, and without the power and originality by which the latter became the centre of Italian culture, can nevertheless boast of some illustrious names. Of these a brief summary, beginning with the department of general literature and passing on to history and science, is subjoined. Many of them are also dealt with in separate articles, to which the reader is referred.

As early as the 13th century the vulgar tongue was already well established at Siena, being used in public documents, commercial records and private correspondence. The poets flourishing at that period were Folcacchiero, Cecco Angiolieri—a humorist of a very high order—and Bindo Bonichi, who belonged also to the following century. The chief glory of the 14th century was St Catherine Benincasa. The year of her death (1380) was that of the birth of St Bernardino Albizzeschi (St Bernardino of Siena), a popular preacher whose sermons in the vulgar tongue are models of style and diction. To the 15th century belongs Aeneas Sylvius Piccolomini (Pius II.), humanist, historian and political writer. In the 16th century we find another Piccolomini (Alexander), bishop of Patras, author of a curious dialogue, *Della bella creanza delle donne*; another bishop, Claudio Tolomei, diplomatist, poet and philologist, who revived the use of ancient Latin metres; and Luca Contile, a writer of narratives, plays and poems. Prose fiction had two representatives in this century—Scipione Bargagli, a writer of some merit, and Pietro Fortini, whose productions were trivial and indecent. In the 17th century we find Ludovico Sergardi (Quinto Settano), a Latinist and satirical writer of much talent and culture; but the most original and brilliant figure in Siennese literature is that of Girolamo Gigli (1660–1722), author of the *Gazzettino*, *La Sorellina di Don Pilone*, *Il Vocabolario cateriniano* and the *Diario ecclesiastico*. As humorist, scholar and philologist, Gigli would take a high place in the literature of any land. His resolute opposition to all hypocrisy—whether religious or literary—exposed him to merciless persecution from the Jesuits and the Della Cruscan Academy.

In the domain of history we have first the old Siennese chronicles, which down to the 14th century are so confused that it is almost impossible to disentangle truth from fiction or even to decide the personality of the various authors. Three 14th-century chronicles, attributed to Andrea Dei, Agnolo di Tura, called Il Grasso, and Neri di Donati, are published in Muratori (vol. xv.). To the 15th century belongs the chronicle of Allegretto Allegretti, also in Muratori (vol. xxiii.); and during the same period flourished Sigismondo Tizio (a priest of Siena, though born at Castiglione Aretino), whose voluminous history written in Latin and never printed (now among the MSS. of the Chigi Library in Rome), though devoid of literary merit, contains much valuable material. The best Siennese historians belong to the 16th century. They are Orlando Malavolti (1515–1596), a man of noble birth, the most trustworthy of all; Antonio Bellarmati; Alessandro Sozzini di Girolamo, the sympathetic author of the *Diario dell' ultima guerra senese*; and Giugurta Tommasi, of whose tedious history ten books, down to 1354, have been published, the rest being still in manuscript. Together with these historians we must mention

the learned scholars Celso Cittadini (d. 1627), Ulberto Benvoglianti (d. 1733), one of Muratori's correspondents, and Gio. Antonio Picci (d. 1768), author of histories of Pandolfo Petrucci and the bishopric of Siena. In the same category may be classed the librarian C. F. Carpellini (d. 1872), author of several monographs on the origin of Siena and the constitution of the republic, and Scipione Borghesi (d. 1877), who has left a precious store of historical, biographical and bibliographical studies and documents.

In theology and philosophy the most distinguished names are: Bernardino Ochino and Lelio and Fausto Soccini (16th century); in jurisprudence, three Soccini: Mariano senior, Bartolommeo and Mariano junior (15th and 16th centuries); and in political economy, Sallustio Bandini (1677–1760), author of the *Discorso sulla Maremma*. In physical science the names most worthy of mention are those of the botanist Pier Antonio Mattioli (1501–1572), of Pirro Maria Gabrielli (1643–1705), founder of the academy of the Physiocrats, and of the anatomist Paolo Mascagni (d. 1825).

Art.—Lanzi happily designates Siennese painting as "Lieta scuola fra lieto popolo" ("the blithe school of a blithe people"). The special characteristics of its masters are freshness of colour, vivacity of expression and distinct originality. The Siennese school of painting owes its origin to the influence of Byzantine art; but it improved that art, impressed it with a special stamp and was for long independent of all other influences. Consequently Siennese art seemed almost stationary amid the general progress and development of the other Italian schools, and preserved its medieval character down to the end of the 15th century, when the influence of the Umbrian and—to a slighter degree—of the Florentine schools began to penetrate into Siena, followed a little later by that of the Lombard. In the 13th century we find Guido (da Siena), painter of the well-known Madonna in the church of S. Domenico in Siena. The 14th century gives us Ugolino, Duccio di Buoninsegna, Simone di Martino (or Memmi), Lippo Memmi, Pietro and Ambrogio Lorenzetti, Andrea di Vanni (painter and statesman), Bartolo di Fredi and Taddeo di Bartolo. In the 15th century we have Domenico di Bartolo, Sano di Pietro, Giovanni di Paolo, Stefano di Giovanni (Il Sassetta) and Matteo and Benvenuto di Giovanni Bartoli, who fell, however, behind their contemporaries elsewhere, and made indeed but little progress. The 16th century boasts the names of Bernardino Fungai, Guidoccio Cossarelli, Giacomo Pacchiarotto, Girolamo del Pacchia and especially Baldassare Peruzzi (1481–1537), who while especially celebrated for his frescoes and studies in perspective and chiaroscuro was also an architect of considerable attainments (see ROME); Giovanni Antonio Bazzi, otherwise known as Il Sodoma (1477–1549), who, born at Vercelli in Piedmont, and trained at Milan in the school of Leonardo da Vinci, came to Siena in 1504 and there produced some of his finest works, while his influence on the art of the place was considerable; Domenico Beccafumi, otherwise known as Micharino (1486–1550), noted for the Michelangelesque daring of his designs; and Francesco Vanni.

There may also be mentioned many sculptors and architects, such as Lorenzo Maitani, architect of Orvieto cathedral (end of 13th century); Camaino di Crescentino; Tino di Camaino, sculptor of the monument to Henry VII. in the Campo Santo of Pisa; Agostino and Agnolo, who in 1330 carved the fine tomb of Bishop Guido Tarlati in the cathedral of Arezzo; Lando di Pietro (14th century), architect, entrusted by the Siennese commune with the proposed enlargement of the cathedral (1339), and perhaps author of the famous Gothic reliquary containing the head of S. Galgano in the Chiesa del Santuccio, which, however, is more usually attributed to Ugolino di Vieri, author of the tabernacle in the cathedral at Orvieto; Giacopo (or Jacopo) della Quercia, whose lovely fountain, the Fonte Gaia, in the Piazza del Campo has been recently restored; Lorenzo di Pietro (Il Vecchietta), a pupil of Della Quercia and an excellent artist in marble and bronze; Francesco d'Antonio, a skilful goldsmith of the 16th century; Francesco di Giorgio Martini (1439–1502), painter, sculptor, military engineer and writer on art; Giacomo Cozzarelli (15th century); and Lorenzo Mariano, surnamed Il Marrina (16th century). Wood-carving also flourished here in the 15th and 16th centuries, and so also did the ceramic art, though few of its products are preserved. According to the well-known law, however, the Renaissance, made for the people of the plains, never fully took root in Siena, as in other parts of Tuscany, and the loss of its independence and power in 1555 led to a suspension of building activity, which to the taste of the present day is most fortunate, inasmuch as the baroque of the 17th and the false classicism of the 18th centuries have had hardly any effect here; and few towns of Italy are so unspoilt by restoration or the addition of incongruous modern buildings, or preserve so many characteristics and so much of the real spirit (manifested to-day in the grave and pleasing courtesy of the inhabitants) of the middle ages, which its narrow and picturesque streets seem to retain. Siena is indeed unsurpassed for its examples of 13th and 14th century Italian Gothic, whether in stone or in brick.

See W. Heywood, *Our Lady of August and the Palio* (Siena, 1899) and other works; R. H. Hobart Cust, *The Pavement Masters of Siena* (London, 1901); Langton Douglas, *History of Siena* (London, 1902); E. G. Gardner, *The Story of Siena* (London, 1902); *St Catherine of Siena* (London, 1908); W. Heywood and L. Olcott, *Guide to Siena* (Siena, 1603); A. Jahn Rusconi, *Siena* (Bergamo, 1904). (C. PA.; T. AS.)

SIENETJO, one of the Shangalla tribes living in south-west Abyssinia near the Sudan frontier, who claim to be a remnant of the primitive population. They are apparently a Hamitic people, and their skin is of a yellowish tint. Their women never intermarry with the Negroes or Arabs. Sienetjo villages are usually built on hilltops. They are an industrious people, skilful jewellers, weavers and smiths.

SIENKIEWICZ, HENRYK (1846–), Polish novelist, was born in 1846 at Wola Okrzeska near Lukow, in the province of Siedlce, Russian Poland. He studied philosophy at Warsaw University. His first work, a humorous novel entitled *A Prophet in his own Country*, appeared in 1872. In 1876 Sienkiewicz visited America, and under the pseudonym of "Litwos," contributed an account of his travels to the *Gazeta Polska*, a Warsaw newspaper. Thenceforward his talent as a writer of historical novels won rapid recognition, and his best-known romance, *Quo Vadis?* a study of Roman society under Nero, has been translated into more than thirty languages. Originally published in 1895, *Quo Vadis?* was first translated into English in 1896, and dramatized versions of it have been produced in England, the United States, France and Germany. Remarkable powers of realistic description, and a strong religious feeling which at times borders upon mysticism, characterize the best work of Sienkiewicz. Hardly inferior to *Quo Vadis?* in popularity, and superior in literary merit, is the trilogy of novels describing 17th-century society in Poland during the wars with the Cossacks, Turks and Swedes. This trilogy comprises *Ogniem i mieczem* ("With Fire and Sword," London, 1890, 1892 and 1895), *Potop* ("The Deluge," Boston, Mass., 1891) and *Pan Woxodjowski* ("Pan Michael," London, 1893). Among other very successful novels and collections of tales which have been translated into English are *Bez Dogmatu* ("Without Dogma," London, 1893; Toronto, 1899), *Janko muzykant. nowele* ("Yanko the Musician and other Stories," Boston, Mass., 1893), *Krzyżacy* ("The Knight of the Cross," numerous British and American versions), *Hania* ("Hania," London, 1897) and *Ta Trzecia* ("The Third Woman," New York, 1898). Sienkiewicz lived much in Cracow and Warsaw, and for a time edited the Warsaw newspaper *Slowo*; he also travelled in England, France, Italy, Spain, Greece, Africa and the East, and published a description of his journeys in Africa. In 1905 he received the Nobel prize for literature.

A German edition of his collected works was published at Graz (1906, &c.), and his biography was written in Polish by P. Chmielowski (Lemberg, 1901) and J. Nowiński (Warsaw, 1901).

SIERADZ, a town of Russian Poland, in the government of Kalisz, situated on the Warta, 110 m. S.W. of the city of Warsaw. Pop. (1897) 7019. It is one of the oldest towns of Poland, founded prior to the introduction of Christianity, and was formerly known as Syra or Syraz. The annals mention it in 1130. Several *seims*, or diets, of Poland were held there during the 13th to 15th centuries, and it was a wealthy town until nearly destroyed by a fire in 1447. The old castle, which suffered much in the Swedish war of 1702–1711, was destroyed by the Germans in 1800. There are two churches, dating from the 12th and 14th centuries respectively.

SIERO, a town of northern Spain, in the province of Oviedo, on the river Nora, and on the Oviedo-Trifiesto railway. Pop. (1900) 22,503. Siero is in the centre of a fertile agricultural district, in which live-stock is extensively reared. There are coal mines in the neighbourhood, and the local industries include tanning and manufactures of soap, coarse linen and cloths.

SIERRA LEONE, a British colony and protectorate on the west coast of Africa. It is bounded W. by the Atlantic, N. and E. by French Guinea and S. by Liberia. The coast-line, following the indentations, is about 400 m. in length, extending from 9° 2' N. to 6° 55' N. It includes the peninsula of Sierra Leone—23 m. long with an average breadth of 14 m.—Sherbro Island, Bance, Banana, Turtle, Plantain and other minor islands, also Turner's Peninsula, a narrow strip of land southward of Sherbro Island, extending in a S.E. direction about 60 m. Except in the Sierra Leone peninsula, Sherbro Island and Turner's

Peninsula, the colony proper does not extend inland to a greater depth than half a mile. The protectorate, which adjoins the colony to the north and east, extends from 7° N. to 10° N. and from 10° 40' W. to 13° W., and has an area of rather more than 30,000 sq. m., being about the size of Ireland. (For map, see FRENCH WEST AFRICA.) The population of the colony proper at the 1901 census was 76,655. The population of the protectorate is estimated at from 1,000,000 to 1,500,000.

Physical Features.—Sierra Leone is a well-watered, well-wooded and generally hilly country. The coast-line is deeply indented in its northern portion. Here the sea has greatly eroded the normal regular, harbourless line of the west coast of Africa, forming bold capes and numerous inlets or estuaries. The Sierra Leone peninsula is the most striking result of this marine action. North of it are the Sierra Leone and Scarcies estuaries; to the south is Yawry Bay. Then in 7° 30' N. Sherbro Island is reached. This is succeeded by Turner's Peninsula (in reality an island). The seaward faces of these islands are perfectly regular and indicate the original continental coast-line. They have been detached from the mainland partly by a marine inlet, partly by the lagoon-like creeks formed by the rivers. In the Sierra Leone peninsula the hills come down to the sea, elsewhere a low coast plain extends inland 30 to 50 m. The plateau which forms the greater part of the protectorate has an altitude varying from 800 to 3000 ft. On the north-east border by the Niger sources are mountains exceeding 5000 ft. The most fertile parts of the protectorate are Sherbro and Mendiland in the south-west. In the north-west the district between the Great Scarcies and the Rokell rivers is flat and is named Bullom (low land). In the south-east bordering Liberia is a belt of densely forested hilly country extending 50 m. S. to N. and very sparsely inhabited.

The hydrography of the country is comparatively simple. Six large rivers—300 to 500 m. long—rise in the Futa Jallon highlands in or beyond the northern frontier of the protectorate and in whole or in part traverse the country with a general S.W. course; the Great and Little Scarcies in the north, the Rokell and Jong in the centre and the Great Bum and Sulima in the south. These rivers are navigable for short distances, but in general rapids or cataracts mark their middle courses. The Great Scarcies, the Rio dos Carceres of the Portuguese, rises not far from the sources of the Senegal. Between 9° 50' and 9° 15' N. it forms the boundary between the protectorate and French Guinea; below that point it is wholly in British territory. The Little Scarcies enters Sierra Leone near Yomaia, in the most northerly part of the protectorate. Known in its upper course as the Kabba, it flows through wild rocky country, its banks in places being 900 ft. high. After piercing the hills it runs parallel with the Great Scarcies. In their lower reaches the two rivers—both large streams—traverse a level plain, separated by no obstacles. The mouth of the Little Scarcies is 20 m. S. of that of the Great Scarcies. South of the estuary of the Scarcies the deep inlet known as the Sierra Leone river forms a perfectly safe and commodious harbour accessible to the largest vessels. At its entrance on the southern shore lies Freetown. Into the estuary flows, besides smaller streams, the Rokell, known in its upper course as the Seli. The broad estuary which separates Sherbro Island from the mainland, and is popularly called the Sherbro river, receives the Bagru from the N.W. and the Jong river, whose headstream, known as the Taia, Pampana and Sanden, flows for a considerable distance east of and parallel to the Rokell. The sources of the Taia, and those of the Great Bum, are near to those of the Niger, the watershed between the coast streams and the Niger basin here forming the frontier. The main upper branch of the Great Bum (or Sewa) river is called the Bague or Bagbe (white river). It flows east of and more directly south than the Taia. In its lower course the Bum passes through the Mendi country and enters the network of lagoons and creeks separated from the ocean by the long low tract of Turner's Peninsula. The main lagoon waterway goes by the name of the Bum-Kittam river, and to the north opens into the Sherbro estuary. Southward it widens out and forms Lake Kasse (20 m. long), before reaching the ocean just north of the estuary of the Sulima. The Wanje or upper Kittam joins this creek, and is also connected with Lake Mabessi, a sheet of water adjacent to Lake Kasse. The Sulima or Moa is a magnificent stream and flows through a very fertile country. One of its headstreams, the Meli, rises in French Guinea in 10° 30' W. 9° 17' N. and flows for some distance parallel to the infant Niger, but in the opposite direction. It joins the Moa within Sierra Leone. The main upper stream of the Moa separates French Guinea and Liberia and enters British territory in 10° 40' W. 8° 20' N. Only the lower course is known as the Sulima. Between 7° 40' and 7° 20' are lacustrine reaches. Six miles S. of the mouth of the Sulima the Mano or Bewa river enters the sea. It rises in Liberia, and below 7° 30' N. forms the frontier between that republic and the protectorate.

The Sierra Leone peninsula, the site of the oldest British settlement, lies between the estuary of the same name and Yawry Bay to the south. It is traversed on its seaward face by hills attaining a height of 1700 ft. in the Sugar Loaf, and nearly as much in Mount Herton farther south. The hills consist of a kind of granite and of

beds of red sandstone, the disintegration of which has given a dark-coloured ferruginous soil of moderate fertility. Sugar Loaf is timbered to the top, and the peninsula is verdant with abundant vegetation.

Climate.—The coast lands are unhealthy and have earned for Sierra Leone the unenviable reputation of being "the white man's grave." The mean annual temperature is above 80°, the rainfall, which varies a great deal, is from 150 to 180 or more inches per annum. In 1896 no fewer than 203 in. were recorded. In 1894, a "dry" year, only 144 in. of rain fell. In no other part of West Africa is the rainfall so heavy. December, January, February and March are practically rainless; the rains, beginning in April or May, reach their maximum in July, August and September, and rapidly diminish in October and November. During the dry season, when the climate is very much like that of the West Indies, there occur terrible tornadoes and long periods of the harmattan—a north-east wind, dry and desiccating, and carrying with it from the Sahara clouds of fine dust, which sailors designate "smokes." The dangers of the climate are much less in the interior; 40 or 50 m. inland the country is tolerable for Europeans.

Flora.—The characteristic tree of the coast districts is the oil-palm. Other palm trees found are the date, bamboo, palmyra, coco and dom. The coast-line, the creeks and the lower courses of the rivers are lined with mangroves. Large areas are covered with brushwood, among which are scattered baobab, shea-butter, bread fruit, corkwood and silk-cotton trees. The forests contain valuable timber trees such as African oak or teak (*Oldfieldia Africana*), rosewood, ebony, tamarind, camwood, odum—whose wood resists the attacks of termites—and the tolgah or brimstone tree. The frankincense tree (*Daniellia thurifera*) reaches from 50 to 150 ft., the negro pepper (*Xylopha Aethiopica*) grows to about 60 ft., the fruit being used by the natives as pepper. There are also found the black pepper plant (*Piper Clusii*), a climbing plant abundant in the mountain districts; the grains of paradise or melegueta pepper plant (*Amomum Melegueta*) and other *Amomums* whose fruits are prized. Of the Apocynaceae the rubber plants are the most important. Both *Landolphia florida* and *Landolphia ovariensis* are found. Of several fibre-yielding plants the so-called aloes of the orders Amaryllidaceae and Liliaceae are common. The kola (*Cola acuminata*) and the bitter kola (*Garcinia kola*), the last having a fruit about the size of an apple, with a flavour like that of green coffee, are common. Of dye-yielding shrubs and plants camwood and indigo may be mentioned; of those whence gum is obtained the copal, acacia and African tragacanth (*Sterculia tragacantha*). Besides the oil-palm, oil is obtained from many trees and shrubs, such as the benni oil plant. Of fruit trees there are among others the blood-plum (*Haematostaphis Barteri*) with deep crimson fruit in grape-like clusters, and the Sierra Leone peach (*Sarcocephalus esculentus*). The coffee and cotton plants are indigenous; of grasses there are various kinds of millet, including *Paspalum exile*, the so-called hungry rice or Sierra Leone millet. Ferns are abundant in the marshes. Bright coloured flowers are somewhat rare.

Fauna.—The wild animals include the elephant, still found in large numbers, the leopard, panther, chimpanzee, grey monkeys, antelope of various kinds, the buffalo, wild hog, bush goat, bush pig, sloth, civet and squirrel. The hippopotamus, manatee, crocodile and beaver are found in the rivers, and both land and fresh-water tortoises are common. Serpents, especially the boa-constrictor, are numerous. Chameleons, lizards and iguanas abound, as do frogs and toads. Wild birds are not very common; among them are the hawk, parrot, owl, woodpecker, kingfisher, green pigeon, African magpie, the honey-sucker and canary. There are also wild duck, geese and other water fowl, hawk's bill, laggerheads and partridges. Mosquitoes, termites, bees, ants, centipedes, millipedes, locusts, grasshoppers, butterflies, dragonflies, sandflies and spiders are found in immense numbers. Turtle are common on the southern coast-line, sand and mangrove oysters are plentiful. Fish abound; among the common kinds are the bunga (a sort of herring), skate, grey mullet and tarpon. Sharks infest the estuaries.

Inhabitants.—Sierra Leone is inhabited by various negro tribes, the chief being the Timni, the Sulima, the Susu and the Mendi. From the Mendi district many curious steatite figures which had been buried have been recovered and are exhibited in the British Museum. They show considerable skill in carving. Of semi-negro races the Fula inhabit the region of the Scarcies. Freetown is peopled by descendants of nearly every negro tribe, and a distinct type known as the Sierra Leoni has been evolved; their language is pidgin English. Since 1900 a considerable number of Syrians have settled in the country as traders. Most of the negroes are pagans and each tribe has its secret societies and fetishes. These are very powerful and are employed often for beneficent purposes, such as the regulation of agriculture and the palm-oil industry. There are many Christian converts (chiefly Anglicans and Wesleyans) and Mahomedans. In the protectorate are some Mahomedan tribes, as for instance the

Susu. The majority of the Sierra Leonis are nominally Christian. The European population numbers about 500.

Towns.—Besides Freetown (*g.v.*) the capital (pop., 1901, 34,463), the most important towns for European trade are Bonthe, the port of Sherbro, Port Lokko, at the head of the navigable waters of a stream emptying itself into the Sierra Leone estuary, and Songo Town, 30 m. S.E. of Freetown, with which it is connected by railway. In the interior are many populous centres. The most noted is Falaba, about 190 m. N.E. of Freetown on the Fala river, a tributary of the Little Scarcies. It lies about 1600 ft. above the sea. Falaba was founded towards the end of the 18th century by the Sulima who revolted from the Mahomedan Fula, and its warlike inhabitants soon attained supremacy over the neighbouring villages and country. Like many of the native towns it is surrounded by a loopholed wall, with flank defences for the gates. The town is the meeting-place of many trade routes, including some to the middle Niger. Kambia on the Great Scarcies is a place of some importance. It can be reached by boat from the sea. On the railway running S.E. from Freetown are Rotifunk, Mano, and Bo, towns which have increased greatly in importance since the building of the railway.

Agriculture and Trade.—Agriculture is in a backward condition, but is being developed. The wealth of the country consists, however, chiefly in its indigenous trees of economic value—the oil-palm, the kola-nut tree and various kinds of rubber plants, chiefly the *Landolphia ovariensis*. The crops cultivated are rice, of an excellent quality, cassava, maize and ginger. The cultivation of coffee and of native tobacco has been practically abandoned as unremunerative. The sugar cane is grown in small quantities. The ginger is grown mainly in the colony proper. Minor products are benni seeds, pepper and piassava. The oil-palm and kola-nut tree are especially abundant in the Sherbro district and its hinterland, the Mendi country. The palms, though never planted, are in practically unlimited numbers. The nuts are gathered twice a year. Formerly groundnuts were largely cultivated, but this industry has been superseded by exports from India. Its place has been taken to some extent by the extraction of rubber.

The cotton plant grows freely throughout the protectorate and the cloth manufactured is of a superior kind. Exotic varieties of cotton do not thrive. Experiments were made during 1903–1906 to introduce the cultivation of Egyptian and American varieties, but they did not succeed. Cattle are numerous but of a poor breed; horses do not thrive. The chief export is palm kernels, the amount of palm oil exported being comparatively slight. Next to palm products the most valuable articles exported are kola-nuts—which go largely to neighbouring French colonies—rubber and ginger. The imports are chiefly textiles, food and spirits. Nearly three-fourths of the imports come from Great Britain, which, however, takes no more than some 35% of the exports. About 10% of the exports go to other British West African colonies. Germany, which has but a small share of the import trade, takes about 45% of the exports. The value of the trade increased in the ten years 1896–1905 from £943,000 to £1,265,000. In 1908 the imports were valued at £813,700, the exports at £736,700.

The development of commerce with the rich regions north and east of the protectorate has been hindered by the diversion of trade to the French port of Konakry, which in 1910 was placed in railway communication with the upper Niger. Moreover, the main trade road from Konakry to the middle Niger skirts the N.E. frontier of the protectorate for some distance. Sierra Leone is thus forced to look to its economic development within the bounds of the protectorate.

Communications.—Internal communication is rendered difficult by the denseness of the "bush" or forest country. The rivers, however, afford a means of bringing country produce to the seaports. A railway, state owned and the first built in British West Africa, runs S.E. from Freetown through the fertile districts of Mendiland to the Liberian frontier. Begun in 1896, the line reached Bo (136 m.) in the oil-palm district in 1903, and was completed to Baiima, 15 m. from the Liberian frontier—total length 221 m.—in 1905. The gauge throughout is 2 ft. 6 in. The line cost about £4300 per mile, a total of nearly £1,000,000. Tramways and "feeder roads" have been built to connect various places with the railway; one such road goes from railhead to Kailahun in Liberia.

Telegraphic communication with Europe was established in 1886. Steamers run at regular intervals between Freetown and Liverpool, Hamburg, Havre and Marseilles. In the ten years 1899–1908 the tonnage of shipping entered and cleared rose from 1,181,000 to 2,046,000.

Administration, Revenue, &c.—The country is administered as a crown colony, the governor being assisted by an executive and a legislative council; on the last-named a minority of nominated unofficial members have seats. The law of the colony is the common law of England modified by local ordinances. There is a denominational system of primary and higher education. The schools are

inspected by government and receive grants in aid. In 1907 there were 75 assisted elementary schools with nearly 8000 scholars. Furah Bay College is affiliated to Durham University. There is a Wesleyan Theological College; a government school (established 1906) at Bo for the sons of chiefs, and the Thomas Agricultural Academy at Mabang (founded in 1909 by a bequest of £60,000 from S. B. Thomas, a Sierra Leonian). Since 1901 the government has provided separate schools for Mahomedans. Revenue is largely derived from customs, especially from the duties levied on spirits. In the protectorate a house tax is imposed. In 1899-1908 revenue increased from £168,000 to £321,000, and the expenditure from £145,000 to £341,000. In 1906 there was a public debt of £1,279,000.

Freetown is the headquarters of the British army in West Africa, and a force of infantry, engineers and artillery is maintained there. The colony itself provides a battalion of the West African Frontier Force, a body responsible to the Colonial Office.

The protectorate is divided for administrative purposes into districts, each under a European commissioner. Throughout the protectorate native law is administered by native courts, subject to certain modifications. Native courts may not deal with murder, witchcraft, cannibalism or slavery. These cases are tried by the district commissioners or referred to the supreme court at Freetown. The tribal system of government is maintained, and the authority of the chiefs has been strengthened by the British. Domestic slavery is not interfered with.

History.—Sierra Leone (in the original Portuguese form *Sierra Leona*) was known to its native inhabitants as *Romarong*, or the Mountain, and received the current designation from the Portuguese discoverer Pedro de Sintra (1462), either on account of the "lion-like" thunder on its hill-tops, or to a fancied resemblance of the mountains to the form of a lion. Here, as elsewhere along the coast, the Portuguese had "factories"; and though none existed when the British took possession, some of the natives called themselves Portuguese and claimed descent from colonists of that nation. An English fort was built on Bance Island in the Sierra Leone estuary towards the close of the 17th century, but was soon afterwards abandoned, though for a long period the estuary was the haunt of slavers and pirates. English traders were established on Bance and the Banana islands as long as the slave trade was legal. The existing colony has not, however, grown out of their establishments, but owes its birth to the philanthropists who sought to alleviate the lot of those negroes who were victims of the traffic in human beings. In 1786 Dr Henry Smeathman, who had lived for four years on the west coast, proposed a scheme for founding on the peninsula a colony for negroes discharged from the army and navy at the close of the American War of Independence, as well as for numbers of runaway slaves who had found an asylum in London. In 1787 the settlement was begun with 400 negroes and 60 Europeans, the whites being mostly women of abandoned character. In the year following, 1788, Nembana, a Timni chief, sold a strip of land to Captain John Taylor, R.N., for the use of the "free community of settlers, their heirs and successors, lately arrived from England, and under the protection of the British government." Owing mainly to the utter shiftlessness of the settlers and the great mortality among them, but partly to an attack by a body of natives, this first attempt proved a complete failure. In 1791 Alexander Falconbridge (formerly a surgeon on board slave ships) collected the surviving fugitives and laid out a new settlement (Granville's Town); and the promoters of the enterprise—Granville Sharp, William Wilberforce, Sir Richard Carr Glyn, &c.—hitherto known as the St George's Bay Company, obtained a charter of incorporation as the Sierra Leone Company, with Henry Thornton as chairman. In 1792 John Clarkson, a lieutenant in the British navy and brother to Thomas Clarkson the slave trade abolitionist, brought to the colony 1100 negroes from Nova Scotia. In 1794 the settlement, which had been again transferred to its original site and named Freetown, was plundered by the French. The governor at the time was Zachary Macaulay, father of Thomas Babington, Lord Macaulay. In 1807, when the inhabitants of the colony numbered 1871, the company, which had encountered many difficulties, transferred its rights to the crown. The slave trade having in the same year been declared illegal by the British parliament, slaves captured by British vessels in the neighbouring seas were brought to Freetown, and thus the population of the colony grew. Its

development was hampered by the frequent changes in the governorship. Sydney Smith's jest that Sierra Leone had always two governors, one just arrived in the colony, and the other just arrived in England, is but a slight exaggeration. In twenty-two years (1792-1814) there were seventeen changes in the governorship. After that date changes, although not quite so rapid, were still frequent. Several of the governors, like Zachary Macaulay, Colonel Dixon Denham, the explorer, and Sir Samuel Rowe, were men of distinction. Colonel Denham, after administering the colony for five weeks, died at Freetown of fever on the 9th of June 1828. Sir Charles M'Carthy was, however, governor for ten years (1814-1824), an unprecedented period, during which he did much for the development of the country. Sir Charles fell in battle with the Ashanti on the 21st of January 1824. Whilst the governors found great difficulty in building up an industrious and agricultural community out of the medley of Africans brought to Sierra Leone, they had also to contend with the illicit slave trade which flourished in places close to the colony. To stop the traffic in Sherbro Island General Charles Turner concluded in 1825 a treaty with its rulers putting the island, Turner's Peninsula and other places under British protection. (This treaty was not ratified by the crown, but was revived by another agreement made in 1882.)

At this time—1826—measures were taken to ensure that the liberated slaves should become self-supporting. Many colonists took to trade, and notwithstanding numerous collisions with neighbouring tribes the settlement attained a measure of prosperity. Among the leading agents in spreading civilization were the missionaries sent out from 1804 onwards by the Church Missionary Society. Despite the anxiety of the British government not to increase their responsibilities in West Africa, from time to time various small territories were purchased, and by 1884 all the land now forming the colony had been acquired. The Los Islands (*q.v.*) which were ceded by the natives to Great Britain in 1818 were transferred to France in 1904. In 1866 Freetown was made the capital of the new general government set up for the British settlements on the West Coast of Africa (comprising Sierra Leone, Gambia, the Gold Coast and Lagos, each of which was to have a legislative council). In 1874 the Gold Coast and Lagos were detached from Sierra Leone, and the Gambia in 1888.

British influence was gradually extended over the hinterland, chiefly with the object of suppressing intertribal wars, which greatly hindered trade. In this work the British authorities enlisted the services of Dr Edward W. Blyden (a pure-blooded negro), who in 1872 visited Falaba and in 1873 Timbo, both semi-Mahomedan countries, being cordially received by the ruling chiefs. Falaba—which had been visited in 1869 by Winwood Reade on his journey to the Niger—came definitely under British protection, but Timbo, which is in Futa Jallon, was allowed to become French territory through the supineness of the home government. The area for expansion on the north was in any case limited by the French Guinea settlements, and on the south the territory of Liberia¹ hemmed in the colony. In the east and north-east British officers also found themselves regarded as trespassers by the French. The necessity for fixing the frontier in this direction was emphasized by the Waima incident. Both French and British military expeditions had been sent against the Sofas—Moslem mercenaries who, under the chieftainship of Fulas or Mandingos like Samory, ravaged the hinterland both of Sierra Leone and French Guinea. On the 23rd of December 1893 a British force was encamped at Waima. At dawn it was attacked by a French force which mistook the British troops for Samory's Sofas (save the officers the soldiers of both parties were negroes). Before the mistake was discovered the British had lost in killed three officers—Captain E. A. W. Lendy, Lieut. R. E. Liston and Lieut. C. Wroughton—and seven men, besides eighteen wounded. The French also suffered heavily. Their leader Lieut. Maritz was brought into the British camp mortally wounded,

*The
Waima
incident.*

¹ The Anglo-Liberian frontier, partly defined by treaty in 1885, was not delimited until 1903 (see LIBERIA).

and was buried by the British. Steps were taken to prevent the occurrence of any further conflicts, and an agreement defining the frontier was signed in January 1895. This agreement finally shut out Sierra Leone from its natural hinterland. In 1896 the frontier was delimited, and in the same year (26th of August 1896) a proclamation of a British protectorate was issued. To this extension of authority no opposition was offered at the time by any of the chiefs or tribes. Travelling commissioners were appointed to explore the hinterland, and frontier police were organized. The abolition of the slave trade followed; and with the introduction of the protectorate ordinance in 1897 a house tax of 5s. each was imposed, to come into operation in three districts on the 1st of January 1898. Chief Bai Bureh, in the Timni country, broke out into open war, necessitating a military punitive expedition. After strenuous fighting, in which the British casualties, including sick, reached 600, he was captured (14th of November 1898) and deported. Meantime (in April 1898) the Mendi tribes rose, and massacred several British and American missionaries, including four ladies, at Rotifunk and Taïama, some native officials (Sierra Leonis) in the Imperri district, and a large number of police throughout the country. Speedy retribution followed, which effectually put down the revolt. Sir David P. Chalmers was appointed (July 1898) royal commissioner to inquire into the disturbances. He issued a report, July 1899, deprecating the imposition of the house tax, which was not, however, revoked. The disturbances would appear to have arisen not so much from dislike of the house tax *per se* as irritation at the arbitrary manner in which it was collected, and from a desire on the part of the paramount chiefs (who chafed at the suppression of slave trading and slave raiding, and who disseminated a powerful fetish "swear," called "Poro," to compel the people to join) to cast off British rule. After the suppression of the rising (January 1899) confidence in the British administration largely increased among the tribes, owing to the care taken to preserve the authority of the chiefs whilst safeguarding the elementary rights of the people. The building of the railway and the consequent development of trade and the introduction of European ideas tended largely to modify native habits. The power of fetishism seemed, however, unaffected.

See H. C. Lukach, *A Bibliography of Sierra Leone* (Oxford 1911); Sir C. P. Lucas, *Historical Geography of the British Colonies*, vol. iii. (2nd ed., Oxford, 1900); T. J. Aldridge, *The Sherbro and its Hinterland* (London, 1901), and *A Transformed Colony* (London, 1910)—the last with valuable notes on secret societies and fetish; Winwood Reade, *The African Sketch Book*, vol. ii. (London, 1873); Colonel J. K. Trotter, *The Niger Sources* (London, 1898); Major J. J. Crook, *History of Sierra Leone* (Dublin, 1903)—a concise account of the colony to the end of the 19th century. For fuller details of the foundation and early history of the settlement consult *Sierra Leone after a Hundred Years* (London, 1894) by E. G. Ingham, bishop of the diocese, and *The Rise of British West Africa* (London, 1904) by Claude George. Bishop Ingham's book contains long extracts from the diary of Governor Clarkson, which vividly portray the conditions of life in the infant colony. For the rising in 1898 see *The Advance of our West African Empire* (London, 1903) by C. B. Wallis. A *Blue Book* on the affairs of the colony is published yearly at Freetown and an *Annual Report* by the Colonial Office in London. Maps on the scale of 1 : 250,000 are published by the War Office.

SIERRA MORENA, THE, a range of mountains in southern Spain. The Sierra Morena constitutes the largest section of the mountain system called the Cordillera Marianica (anc. *Montes mariani*), which also includes a number of minor Spanish ranges, together with the mountains of southern Portugal. The mean elevation of the range is about 2500 ft., but its breadth is certainly not less than 40 m. It extends eastward as far as the steppe region of Albacete, and westward to the valley of the lower Guadiana. Its continuity is frequently interrupted, especially in the west; in the eastern and middle portions it is composed of numerous irregularly disposed ridges. Many of these bear distinctive names; thus the easternmost and loftiest is called the Sierra de Alcaraz (5900 ft.), while some of the component ridges in the extreme west are classed together as the Sierras de Aracena. The great breadth of the Sierra Morena long rendered it a formidable barrier between Andalusia and the

north; as such it has played an important part in the social, economic and military history of Spain. Its configuration and hydrography are also important from a geographical point of view, partly because it separates the plateau region of Castile and Estremadura from the Andalusian plain and the highlands of the Sierra Nevada system, partly because it forms the watershed between two great rivers, the upper Guadiana on the north and the Guadalquivir on the south. Parts of the Sierra Morena are rich in minerals; the central region yields silver, mercury and lead, while the Sierras de Aracena contain the celebrated copper mines of Tharsis and Rio Tinto (*q.v.*).

SIERRA NEVADA (Span. for "snowy range"), a mountain range, about 430 m. long, in the eastern part of California, containing Mt Whitney (14,502 ft.), the highest point in the United States, excluding Alaska. (See CALIFORNIA.)

SIERRA NEVADA, THE, a mountain range of southern Spain, in the provinces of Granada and Almería. The Sierra Nevada is a well-defined range, about 55 m. long and 25 m. broad, situated to the south of the Guadalquivir valley, and stretching from the upper valley of the river Genil or Jenil eastwards to the valley of the river Almería. It owes its name, meaning "the snowy range," to the fact that several of its peaks exceed 10,000 feet in height and are thus above the limit of perpetual snow. Its culminating point, the Cerro de Mulhacen or Mulahacen (11,421 ft.) reaches an altitude unequalled in Spain, while one of the neighbouring peaks, called the Picacho de Veleta (11,148 ft.), is only surpassed by Aneto (11,168 ft.), the loftiest summit of the Pyrenees. The Sierra Nevada is composed chiefly of soft micaceous schists, sinking precipitously down on the north, but sloping more gradually to the south and south-east. On both sides deep transverse valleys (*barrancas*) follow one another in close succession, in many cases with round, basin-shaped heads like the cirques of the Pyrenees (*q.v.*). In many of these cirques lie alpine lakes, and in one of them, the Corral de Veleta, there is even a small glacier, the most southerly in Europe. The transverse valleys open on the south into the longitudinal valleys of the Alpujarras (*q.v.*). On the north, east and west there are various minor ranges, such as the Sierras of Parapanda, Harana, Gor, Baza, Lucena, Cazorla, Estancias, Filabres, &c., which are connected with the main range, and are sometimes collectively termed the Sierra Nevada system. The coast ranges, or Sierra Penibética, are not included in this group. The Sierras de Segura form a connecting link between the Sierra Morena and the Nevada system.

SIEVE (O.E. *sife*, older *sibi*, cf. Dutch *zeef*, Ger. *Sieb*; from the subst. comes O.E. *siflan*, to sift), an instrument or apparatus for separating finer particles from coarser. The common sieve is a net of wires or other material stretched across a framework with raised edges; the material to be sifted is then shaken or pressed upon the net so that the finer particles pass through the mesh and the coarser remain. The word "screen" is usually applied to such instruments with large mesh for coarse work, and "strainer" for those used in the separation of liquids or semi-liquids from solid matter. In the separation of meal from bran "bolting-clothes" are used. There was an early form of divination known as *coscinomancy* (Gr. *κόσκινον*, sieve, *μαρτεία*, divination), where a sieve was hung or attached to a pair of shears, whence the name sometimes given to it of "sieve and shears"; the turning or movement of the sieve at the naming of a person suspected of a crime or other act, coupled with the repetition of an incantation or other magic formula, decided the guilt or innocence of the person.

SIEYÈS, EMMANUEL-JOSEPH (1748-1836), French abbé and statesman, one of the chief theorists of the revolutionary and Napoleonic era, was born at Fréjus in the south of France on the 3rd of May 1748. He was educated for the church at the Sorbonne; but while there he eagerly imbibed the teachings of Locke, Condillac, and other political thinkers, in preference to theology. Nevertheless he entered the church, and owing to his learning and subtlety advanced until he became vicar-general and chancellor of the diocese of Chartres. In 1788 the excitement caused by the proposed convocation of the States

General of France after the interval of more than a century and a half, and the invitation of Necker to writers to state their views as to the constitution of the Estates, enabled Sieyès to publish his celebrated pamphlet, "What is the Third Estate?" He thus begins his answer,—“Everything. What has it been hitherto in the political order? Nothing. What does it desire? To be something.” For this *mot* he is said to have been indebted to Chamfort. In any case, the pamphlet had a great vogue, and its author, despite doubts felt as to his clerical vocation, was elected as the last (the twentieth) of the deputies of Paris to the States General. Despite his failure as a speaker, his influence became great; he strongly advised the constitution of the Estates in one chamber as the National Assembly, but he opposed the abolition of tithes and the confiscation of church lands. Elected to the special committee on the constitution, he opposed the right of “absolute veto” for the king, which Mirabeau unsuccessfully supported. For the most part, however, he veiled his opinions in the National Assembly, speaking very rarely and then generally with oracular brevity and ambiguity. He had a considerable influence on the framing of the departmental system, but after the spring of 1790 his influence was eclipsed by men of more determined character. Only once was he elected to the post of fortnightly president of the Constituent Assembly. Excluded from the Legislative Assembly by Robespierre's self-denying ordinance, he reappeared in the third National Assembly, known as the Convention (September 1792–September 1795); but there his self-effacement was even more remarkable; it resulted partly from disgust, partly from timidity. He even abjured his faith at the time of the installation of the goddess of reason; and afterwards he characterized his conduct during the reign of terror in the ironical phrase, *J'ai vécu*. He voted for the death of Louis XVI., but not in the contemptuous terms *La mort sans phrases* sometimes ascribed to him. He is known to have disapproved of many of the provisions of the constitutions of the years 1791 and 1793, but did little or nothing to improve them.

In 1795 he went on a diplomatic mission to the Hague, and was instrumental in drawing up a treaty between the French and Batavian republics. He dissented from the constitution of 1795 (that of the Directory) in some important particulars, but without effect, and thereupon refused to serve as a Director of the Republic. In May 1798 he went as the plenipotentiary of France to the court of Berlin in order to try to induce Prussia to make common cause with France against the Second Coalition. His conduct was skilful, but he failed in his main object. The prestige which encircled his name led to his being elected a Director of France in place of Rewbell in May 1799. Already he had begun to intrigue for the overthrow of the Directory, and is said to have thought of favouring the advent to power at Paris of persons so unlikely as the Archduke Charles and the duke of Brunswick. He now set himself to sap the base of the constitution of 1795. With that aim he caused the revived Jacobin Club to be closed, and made overtures to General Joubert for a *coup d'état* in the future. The death of Joubert at the battle of Novi, and the return of Bonaparte from Egypt marred his schemes; but ultimately he came to an understanding with the young general (see NAPOLEON I.). After the *coup d'état* of Brumaire, Sieyès produced the perfect constitution which he had long been planning, only to have it completely remodelled by Bonaparte. Sieyès soon retired from the post of provisional consul, which he accepted after Brumaire; he now became one of the first senators, and rumour, probably rightly, connected this retirement with the acquisition of a fine estate at Crôsne. After the bomb outrage at the close of 1800 (the affair of Nivôse) Sieyès in the senate defended the arbitrary and illegal proceedings whereby Bonaparte rid himself of the leading Jacobins. During the empire he rarely emerged from his retirement, but at the time of the Bourbon restorations (1814 and 1815) he left France. After the July revolution (1830) he returned; he died at Paris on the 20th of June 1836. The thin, wire-drawn features of Sieyès were the index of his mind, which was keensighted but narrow, dry and essentially limited. His lack

of character and wide sympathies was a misfortune for the National Assemblies which he might otherwise have guided with effect.

See A. Neton, *Sieyès (1748–1836) d'après documents inédits* (Paris, 1900); also the chief histories on the French Revolution and the Napoleonic empire. (J. HL. R.)

SIFAKA, apparently the name of certain large Malagasy lemurs nearly allied to the *INDRI* (*q.v.*) but distinguished by their long tails, and hence referred to a genus apart—*Propithecus*, of which three species, with several local races, are recognized. Sifakas are very variable in colouring, but always show a large amount of white. They associate in parties and are mainly arboreal, leaping from bough to bough with an agility that suggests flying through the air. When on the ground, to pass from one clump of trees to another, they do not run on all fours, but stand erect,

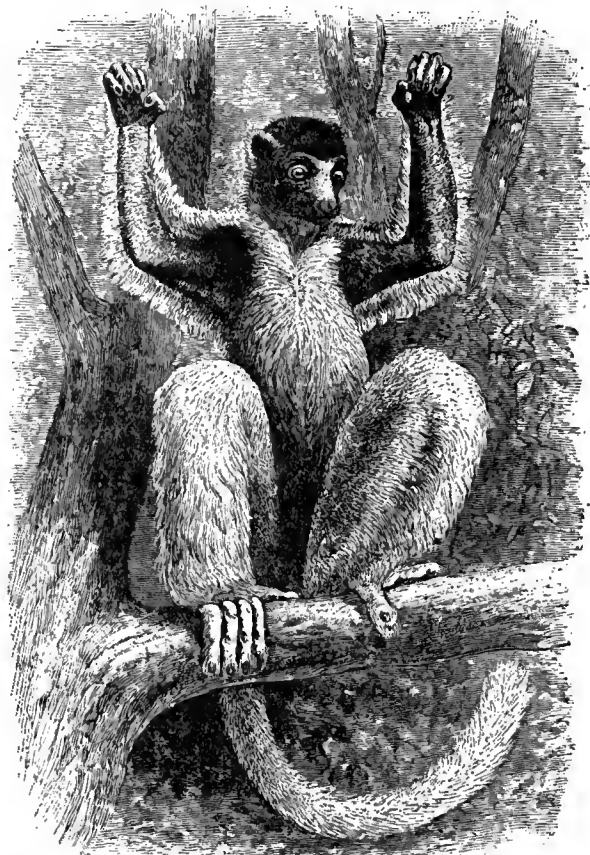

The Crowned Sifaka (*Propithecus diadema coronatus*). From Milne-Edwards and Grandidier.

and throwing their arms above their heads, progress by a series of short jumps, producing an effect which is described by travellers as exceedingly ludicrous. They are not nocturnal, but most active in the morning and evening, remaining seated or curled up among the branches during the heat of the day. In disposition they are quiet and gentle, and do not show much intelligence; they are also less noisy than the true lemurs, only when alarmed or angered making a noise which has been compared to the clucking of a fowl. Like all their kindred they produce only one offspring at a birth (see PRIMATES). (R. L.)*

SIGALON, XAVIER (1788–1837), French painter, born at Uzès (Gard) towards the close of 1788, was one of the few leaders of the romantic movement who cared for treatment of form rather than of colour. The son of a poor rural schoolmaster, he had a terrible struggle before he was able even to reach Paris and obtain admission to Guérin's studio. But the learning offered there did not respond to his special needs, and he tried to train himself by solitary study of the Italian masters in the gallery of the Louvre. The "Young Courtesan" (Louvre),

which he exhibited in 1822, at once attracted attention and was bought for the Luxembourg. The painter, however, regarded it as but an essay in practice and sought to measure himself with a mightier motive; this he did in his "Locusta" (Nîmes), 1824, and again in "Athaliah's Massacre" (Nantes), 1827. Both these works showed incontestable power; but the "Vision of St Jerome" (Louvre), which appeared at the salon of 1831, together with the "Crucifixion" (Issengeaux), was by far the most individual of all his achievements, and that year he received the cross of the Legion of Honour. The terrors and force of his pencil were not, however, rendered attractive by any charm of colour; his paintings remained unpurchased, and Sigalon found himself forced to get a humble living at times by painting portraits, when Thiers, then minister of the interior, recalled him to Paris and entrusted him with the task of copying the Sistine fresco of the "Last Judgment" for a hall in the Palace of the Fine Arts. On the exhibition, in the Baths of Diocletian at Rome, of Sigalon's gigantic task, in which he had been aided by his pupil Numa Boucoiran, the artist was visited in state by Gregory XVI. But Sigalon was not destined long to enjoy his tardy honours and the comparative ease procured by a small government pension; returning to Rome to copy some pendants in the Sistine, he died there of cholera on the 9th of August 1837.

SI-GAN FU (officially Sian Fu), the capital of the province of Shen-si, N.W. China, in $34^{\circ} 17' N.$, $108^{\circ} 58' E.$ Shi Hwang-ti (246–210 B.C.), the first universal emperor, established his capital at Kwan-chung, the site of the modern Si-gan Fu. Under the succeeding Han dynasty (206 B.C.–A.D. 25) this city was called Wei-nan and Nui-shi; under the eastern Han (A.D. 25–221) it was known as Yung Chow; under the T'ang (618–907) as Kwan-nui; under the Sung (960–1127) as Yung-hing; under the Yuan and Ming (1260–1644) as Gan-si. During the Ts'in, Han and T'ang dynasties the city was usually the capital of the empire, and in size, population and wealth it is still one of the most important cities of China. It was to Si-gan Fu that the emperor and dowager empress retreated on the capture of Peking by the allied armies in August 1900; and it was once again constituted the capital of the empire until the following spring when the court returned to Peking, after the conclusion of peace. The city, which is a square, is prettily situated on ground rising from the river Wei, and includes within its limits the two district cities of Ch'ang-gan and Hien-ning. Its walls are little inferior in height and massiveness to those of Peking, while its gates are handsomer and better defended than any at the capital. The population is said to be 1,000,000, of whom 50,000 are Mahomedans. Situated in the basin of the Wei river, along which runs the great road which connects northern China with Central Asia, at a point where the valley opens out on the plains of China, Si-gan Fu occupies a strategical position of great importance, and repeatedly in the annals of the empire has history been made around and within its walls. During the Mahomedan rebellion it was besieged by the rebels for two years (1868–70), but owing to the strength of the fortifications it defied the efforts of its assailants. It is admirably situated as a trade centre and serves as a depot for the silk from Cheh-kiang and Szech'uen, the tea from Hu-peh and Ho-nan, and the sugar from Szech'uen destined for the markets of Kan-suh, Turkestan, Kulja and Russia. Marco Polo, speaking of Kenjanfu, as the city was then also called, says that it was a place "of great trade and industry. They have great abundance of silk, from which they weave cloths of silk, and gold of divers kinds, and they also manufacture all sorts of equipments for an army. They have every necessary of man's life very cheap."

Several of the temples and public buildings are very fine, and many historical monuments are found within and about the walls. Of these the most notable is the Nestorian tablet, which was accidentally discovered in 1625 in the Ch'ang-gan suburb. The stone slab which bears the inscription is $7\frac{1}{2}$ ft. high by 3 wide.

The contents of this Nestorian inscription, which consists of 1780 characters, may be described as follows. (1) An abstract of Christian doctrine of a vague and figurative kind. (2) An account of the arrival

of the missionary Olopan (probably a Chinese form of Rabban = Monk) from Tats'in in the year 635, bringing sacred books and images; of the translation of the said books; of the imperial approval of the doctrine and permission to teach it publicly. Then follows a decree of the emperor (T'ai-tung, a very famous prince), issued in 638, in favour of the new doctrine, and ordering a church to be built in the square of justice and peace (*Ining fang*) in the capital. The emperor's portrait was to be placed in this church. After this comes a description of Tats'in, and then some account of the fortunes of the church in China. Kaotsung (650–683, the devout patron also of the Buddhist traveller and doctor, Hsüan Ts'ang), it is added, continued to favour the new faith. In the end of the century Buddhism got the upper hand, but under Yuen-tsung (713–755) the church recovered its prestige, and Kiho, a new missionary, arrived. Under Tih-tung (780–783) the monument was erected, and this part of the inscription ends with an eulogy of I-sze, a statesman and benefactor of the church. (3) Then follows a recapitulation of the above in octosyllabic verse. The Chinese inscription, which concludes with the date of erection, viz. 781, is followed by a series of short inscriptions in Syriac and the *Estrangelo* character, containing the date of the erection, the name of the reigning Nestorian patriarch, Mar Hanan Ishua, that of Adam, bishop and pope of China, and those of the clerical staff of the capital. Then follow sixty-seven names of persons in Syriac characters, most of whom are characterized as priests, and sixty-one names of persons in Chinese, all priests but one.

The stone—one of a row of five memorial tablets—stood within the enclosure of a dilapidated temple. It appears at one time to have been embedded in a brick niche, and about 1891 a shed was placed over it, but in 1907 it stood in the open entirely unprotected. In that year Dr Frits v. Holm, a Danish traveller, had made an exact replica of the tablet, which in 1908 was deposited in the Metropolitan Museum of Art, New York. The tablet itself was in October 1907 removed by Chinese officials into the city proper, and placed in the Pei Lin or "forest of tablets," a museum in which are collected tablets of the Han, T'ang, Sung, Yuen and Ming dynasties, some of which bear historical legends, notably a set of stone tablets having the thirteen classics inscribed upon them, while others are symbolical or pictorial; among these last is a full-sized likeness of Confucius. Antiquities are constantly being discovered in the neighbourhood of the city, e.g. rich stores of coins and bronzes, bearing dates ranging from 200 B.C. onwards.

See Yule, *Marco Polo* (1903 ed.); A. Williamson, *Journeys in North China* (London, 1870); S. Wells Williams, *The Middle Kingdom* (London, 1883); Père Havret, *La Sîle de Si-ngan Fou* (Shanghai, 1895–1902); F. v. Holm, *The Nestorian Monument* (Chicago, 1909).

SIGEBERT (d. 575), king of the Franks, was one of the four sons of Clotaire I. At the death of Clotaire in 561 the Frankish kingdom was divided among his sons, Sigebert's share comprising the Rhine and Meuse lands and the suzerainty over the Germanic tribes beyond the Rhine as far as the Elbe, together with Auvergne and part of Provence. At the death of his brother Charibert in 567 Sigebert obtained the cities of Tours and Poitiers, and it was he who elevated to the see of Tours the celebrated Gregory, the historian of the Franks. Being a smoother man than his brothers (who had all taken mates of inferior rank), Sigebert married a royal princess, Brunhilda, daughter of Athanagild, the king of the Visigoths; the nuptials were celebrated with great pomp at Metz, the Italian poet Fortunatus composing the epithalamium. Shortly afterwards Sigebert's brother Chilperic I. married Brunhilda's sister, Galswintha; but the subsequent murder of this princess embroiled Austrasia and Neustria, and civil war broke out in 573. Sigebert appealed to the Germans of the right bank of the Rhine, who attacked the environs of Paris and Chartres and committed frightful ravages. He was entirely victorious, and pursued Chilperic as far as Tournai. But just when the great nobles of Neustria were raising Sigebert on the shield in the villa at Vitry, near Arras, he was assassinated by two bravoes in the pay of Fredegond, Chilperic's new wife. At the beginning of his reign Sigebert had made war on the Avars, who had attacked his Germanic possessions, and he was for some time a prisoner in their hands.

See Gregory of Tours, *Historia Francorum*, book iv.; Aug. Thierry, *Récits des temps mérovingiens* (Brussels, 1840), and Aug. Digot, *Histoire du royaume d'Austrasie* (Nancy, 1863). (C. PF.)

SIGEBERT OF GEMBOUX (c. 1030–1112), medieval chronicler, became in early life a monk in the Benedictine abbey of Gembloux. Later he was a teacher at Metz, and about 1070 he returned to Gembloux, where, occupied in teaching and writing, he lived until his death on the 5th of October 1112. As an enemy of the papal pretensions he took part in the momentous contest between Pope Gregory VII. and the emperor Henry IV., his writings on this question being very serviceable to the imperial cause; and he also wrote against Pope Paschal II. Sigebert's most important work is a *Chronographia*, or universal chronicle, according to Molinier the best work of its kind, although it contains many errors and but little original information. It covers the period between 381 and 1111, and its author was evidently a man of much learning. The first of many editions was published in 1513 and the best is in Band vi. of the *Monumenta Germaniae historica. Scriptores*, with valuable introduction by L. C. Bethmann. The chronicle was very popular during the later middle ages; it was used by many writers and found numerous continuators. Other works by Sigebert are a history of the early abbots of Gembloux to 1048 (*Gesta abbatum Gemblacensium*) and a life of the Frankish king Sigebert III. (*Vita Sigeberti III. regis Austrasiae*). Sigebert was also a hagiographer. Among his writings in this connexion may be mentioned the *Vita Deoderici, Mettensis episcopi*, which is published in Band iv. of the *Monumenta*, and the *Vita Wicberti*, in Band viii. of the same collection. Dietrich, bishop of Metz (d. 984) was the founder of the abbey of St Vincent in that city, and Wicbert or Guibert (d. 962) was the founder of the abbey of Gembloux.

See S. Hirsch, *De vita et scriptis Sigiberti Gemblacensis* (Berlin, 1841); A. Molinier, *Les Sources de l'histoire de France*, tomes ii. and v. (1902–1904); and W. Wattenbach, *Deutschlands Geschichtsquellen*, Band ii. (Berlin, 1894).

SIGEL, FRANZ (1824–1902), German and American soldier, was born at Sinsheim, in Baden, on the 18th of November 1824. He graduated at the military school at Karlsruhe, and became an officer in the grand ducal service. He soon became known for revolutionary opinions, and in 1847, after killing an opponent in a duel, he resigned his commission. When the Baden insurrection broke out, Sigel was a leader on the revolutionary side in the brief campaign of 1848, and then took refuge in Switzerland. In the following year he returned to Baden and took a conspicuous part in the more serious operations of the second outbreak under General Louis Mieroslawski (1814–1878.). Sigel subsequently lived in Switzerland, England and the United States, whither he emigrated in 1852, the usual life of a political exile, working in turn as journalist and schoolmaster, and both at New York and St Louis, whither he removed in 1858, he conducted military journals. When the American Civil War broke out in 1861, Sigel was active in raising and training Federal volunteer corps, and took a prominent part in the struggle for the possession of Missouri. He became in May a brigadier-general U.S.V., and served with Nathaniel Lyon at Wilson's Creek and with J. C. Frémont in the advance on Springfield in the autumn. In 1862 he took a conspicuous part in the desperately fought battle of Pea Ridge, which definitely secured Missouri for the Federals. He was promoted to be major-general of volunteers, was ordered to Virginia, and was soon placed in command of the I. corps of Pope's "Army of Virginia." In this capacity he took part in the second Bull Run campaign, and his corps displayed the utmost gallantry in the unsuccessful attacks on Bald Hill. Up to the beginning of 1863, when bad health obliged him to take leave of absence, Sigel remained in command of his own (now called the XI.) corps and the XII., the two forming a "Grand Division." In June 1863 he was in command of large forces in Pennsylvania, to make head against Lee's second invasion of Northern territory. In 1864 he was placed in command of the corps in the Shenandoah Valley, but was defeated by General John C. Breckinridge at Newmarket (15th of May), and was superseded. Subsequently he was in command of the Harper's Ferry garrison at the time of Early's raid upon Washington and made a brilliant defence of his post

(July 4–5, 1864). He resigned his commission in May 1865, and became editor of a German journal in Baltimore, Maryland. In 1867 he removed to New York City, and in 1869 was the unsuccessful Republican candidate for secretary of state of New York. He was appointed collector of internal revenue in May 1871, and in the following October he was elected register of New York City by Republicans and "reform Democrats." From 1885 to 1889, having previously become a Democrat, he was pension agent for New York City, on the appointment of President Cleveland. General Sigel's last years were devoted to the editorship of the *New York Monthly*, a German-American periodical. He died in New York City on the 21st of August 1902. A monument (by Karl Bitter) in his honour was unveiled in Riverside Drive, New York City, in October 1907.

SIGER DE BRABANT [SIGHIER, SIGIERI, SYGERIUS], French philosopher of the 13th century. About the facts of his life there has been much difference of opinion. In 1266 he was attached to the Faculty of Arts in the University of Paris at the time when there was a great conflict between the four "nations." The papal legate decided in 1266 that Siger was the ringleader, and threatened him with death. During the succeeding ten years he wrote the six works which are ascribed to him and were published under his name by P. Mandonnet in 1899. The titles of these treatises are: *De anima intellectiva* (1270); *Quaestiones logicales*; *Quaestiones naturales*; *De aeternitate mundi*; *Quaestio utrum haec sit vera*; *Homo est animal nullo homine existente*; *Impossibilia*. In 1271 he was once more involved in a party struggle. The minority among the "nations" chose him as rector in opposition to the elected candidate, Aubri de Rheims. For three years the strife continued, and was probably based on the opposition between the Averroists, Siger and Pierre Dubois, and the more orthodox schoolmen. The matter was settled by the Papal Legate, Simon de Brion, afterwards Pope Martin IV. Siger retired from Paris to Liège. In 1277 a general condemnation of Aristotelianism included a special clause directed against Boetius of Denmark and Siger of Brabant. Again Siger and Bernier de Nivelles were summoned to appear on a charge of heresy, especially in connexion with the *Impossibilia*, where the existence of God is discussed. It appears, however, that Siger and Boetius fled to Italy and, according to John Peckham, archbishop of Canterbury, perished miserably. The manner of Siger's death, which occurred at Orvieto, is not known. A Brabantine chronicle says that he was killed by an insane secretary (*a clerico suo quasi dementi*). Dante, in the *Paradiso* (x. 134–6), says that he found "death slow in coming," and some have concluded that this indicates death by suicide. A 13th-century sonnet by one Durante (xcii. 9–14) says that he was executed at Orvieto: *a ghiado il fé' morire a gran dolore, Nella corte di Roma ad Orbivieto*. The date of this may have been 1283–1284 when Martin IV. was in residence at Orvieto. In politics he held that good laws were better than good rulers, and criticised papal infallibility in temporal affairs. The importance of Siger in philosophy lies in his acceptance of Averroism in its entirety, which drew upon him the opposition of Albertus Magnus and Aquinas. In December 1270 Averroism was condemned by ecclesiastical authority, and during his whole life Siger was exposed to persecution both from the Church and from purely philosophic opponents. In view of this, it is curious that Dante should place him in Paradise at the side of Aquinas and Isidore of Seville. Probably Dante knew of him only from the chronicler as a persecuted philosopher.

See P. Mandonnet, *Siger de Brabant et l'Averroïsme latin du XIII^e siècle* (Fribourg, 1899); G. Paris, "Siger de Brabant" in *La Poésie du moyen âge* (1895); and an article in the *Revue de Paris* (Sept. 1st, 1900).

SIGHTS, the name for mechanical appliances for directing the axis of the bore of a gun or other firearm on a point whose position relative to the target fired at is such that the projectile will strike the target.

Gun Sights.—Until the 19th century the only means for sighting cannon was by the "line of metal"—a line scored

along the top of the gun, which, owing to the greater thickness of metal at the breech than at the muzzle, was not parallel to the axis. "Some allowance had to be made for the inclination of the line of metal to the axis" (Lloyd and Hadcock, p. 32). The line of metal does not come under the definition of sights given above. In the year 1801 a proposal to use sights was sent to Lord Nelson for opinion, and elicited the following reply: "As to the plan for pointing a gun, truer than we do at present, if the person comes, I shall, of course, look at it, or be happy, if necessary, to use it; but I hope we shall be able, as usual, to get so close to our enemies that our shot cannot miss the object" (letter to Sir E. Berry, March 9, 1801). Three weeks later the fleet under Sir Hyde Parker and Nelson sailed through the Sound on its way to Copenhagen. In replying to the guns of Fort Elsinore no execution was done, as the long range made it impossible to lay the guns (Lloyd and Hadcock, p. 33).

The necessity for sights follows directly on investigation of the forces acting on a projectile during flight. In a vacuum, the projectile acted on by the force of projection begins to fall under the action of gravity immediately it leaves the bore, and under the combined action of these two forces the path of the projectile is a parabola. It passes over equal spaces in equal times, but falls with an accelerating velocity according to the formula $h = \frac{1}{2}gt^2$, where h is the height fallen through, g the force of gravity, and t the time of flight. From fig. 1 it will be seen that in three seconds the projectile would have fallen 144 ft. to G; therefore to strike T the axis must be raised to a point 144 ft. vertically above G. This law holds good

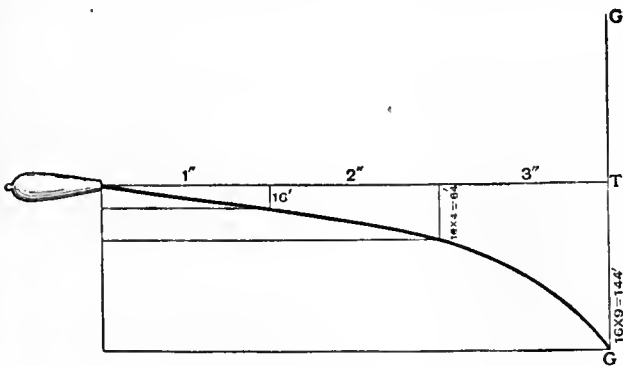

FIG. 1.—Elevation.

also in air for very low velocities, but, where the velocities are high, the retardation is great, the projectile takes longer to traverse each succeeding space, and consequently the time of flight for any range is longer; the axis must therefore be directed still higher above the point to be struck. The amount, however, still depends on the time of flight, as the retardation of the air to the falling velocity may be neglected in the case of flat trajectory guns. Owing to the conical shape of the early muzzle-loading guns, if one trunnion were higher than the other, the "line of metal" would no longer be in the same vertical plane as the axis; in consequence of this, if a gun with, say, one wheel higher than the other were layed by this line, the axis would point off the target to the side of the lower wheel. Further, the inclination of the line of metal to the axis gave the gun a fixed angle of elevation varying from 1° in light guns to $2\frac{1}{4}^\circ$ in the heavier natures. To overcome this a "dispart sight" (D) was introduced (fig. 2) to bring the line of sight (A'DG') parallel to the axis (AG).

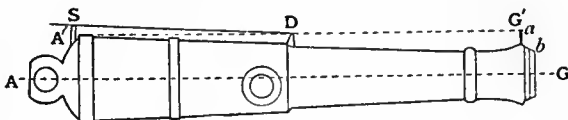

FIG. 2.—Dispart and Tangent Sights.

AG is the axis of the bore, ab the dispart, A'DG' is parallel to AG. D is the dispart sight, S the tangent sight, A'DS the clearance angle. At greater elevations than this the muzzle notch is used; to align on the target at lesser angles the dispart sight is so used. Guns without dispart sights cannot be layed at elevations below the clearance angle.

The earliest form of a hind or breech sight was fixed, but in the early part of the 19th century Colonel Thomas Blomefield proposed a movable or tangent sight. It was not, however, till 1829 that a tangent sight (designed by Major-General William Millar) was introduced

into the navy; this was adopted by the army in 1846. In the case of most guns it was used in conjunction with the dispart sight above referred to. The tangent sight (see fig. 3) was graduated in degrees only. There were three patterns, one of brass and two of wood. As the tangent sight was placed in the line of metal, hence directly over the cascable, very little movement could be given to it, so that a second sight was required for long ranges. This was of wood; the third sight, also of wood, was for guns without a dispart patch, which consequently could not be layed at elevations below the dispart angle.

Referring to fig. 1 it will be seen that in order to strike T the axis must be directed to G' at a height above T equal to TG, while the line of sight or line joining the notch of the tangent sight and apex of the dispart or foresight must be directed on T. In fig. 4 the tangent sight has been raised from O to S, the line of sight is SMT, and the axis produced is AG'. D is the dispart, M the muzzle sight, OM is parallel to AG'. Now the height to which the tangent sight has been raised in order to direct the axis on G' is evidently proportional to the tangent of the angle OMS=AXS. This angle is called the angle of elevation; OM is constant and is called the sighting radius. If the dispart sight were being used, the sighting radius would be OD, but, as at the range in fig. 4, the line of sight through D fouls the metal of the gun, the muzzle sight M is used. The formula for length of scale is, length=sighting radius X tangent of the angle of elevation. In practice, tangent sights were graduated graphically from large scale drawings. It will be seen from fig. 4 that if the gun and target are on the same horizontal plane the axis can be equally well directed by inclining it to the horizontal through the requisite number of degrees. This is called "quadrant elevation," and the proper inclination was given by means of the "gunner's quadrant," a quadrant and plumb bob, one leg being made long to rest in the bore, or by bringing lines scribed on the breech of the gun in line with a pointer on the carriage; these were called "quarter sights."

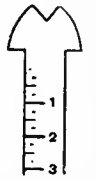

FIG. 3.—Early Tangent Sight.

Such were the sights in use with smooth-bore guns in the first half of the last century. Tangent sights were not much trusted at first. Captain Haultain, R.A., says in his description of testing sights (*Occasional Papers, R.A. Institute, vol. i.*): "Raise the sight, and if it keeps in line with a plumb bob, it can be as confidently relied upon as the line of metal, if the trunnions are horizontal. If the scale is only slightly out of the perpendicular, a few taps of the hammer will modify any trifling error."

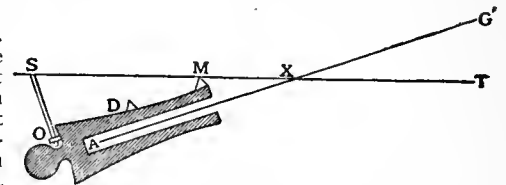

FIG. 4.—Theory of Tangent Sight.

The introduction of rifling necessitated an improvement in sights and an important modification in them. It was found that projectiles fired from a rifled gun deviated laterally from the line of fire owing to the axial spin of the projectile, and that if the spin were right-handed, as in the British service, the deviation was to the right. This deviation or derivation is usually called drift (for further details see BALLISTICS). The amount of drift for each nature of gun at different ranges was determined by actual firing. To overcome drift the axis must be pointed to the left of the target, and the amount will increase with the range.

Sights for rifled guns.

In fig. 5 (plan) at a range HT, if the axis were directed on T, drift would carry the shot to D, therefore the axis must be directed on a point D' such that D'T=DT. HFT is the line of sight without any allowance for drift, causing the projectile to fall at D. Now if the notch of the tangent sight be carried to H' in order to lay on T, the fore-sight, and with it the axis, will be moved to F', the line of fire will be HF'D', and the shot will strike T since D'T=DT. Left deflection has been put on; this could be done by noting the amount of deflection for each range and applying it by means of a sliding leaf carrying the notch, and it is so done in howitzers; in most guns, however, it is found more convenient and sufficiently accurate to apply it automatically by inclining the socket through which the tangent scale rises to the left, so that as the scale rises, i.e., as the range increases, the notch is carried more and more to the left, and an increasing

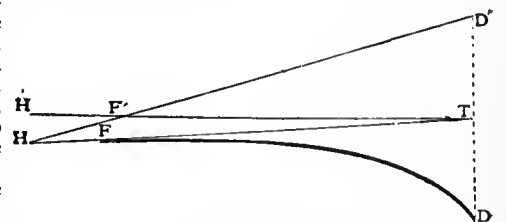

FIG. 5.—Drift.

amount of left deflection given—the amount can easily be determined thus:—

The height of tangent scale for any degree of elevation is given with sufficient accuracy by the rough rule for circular measure $h = \frac{a \times R}{3 \times 1200}$ where a is the angle of elevation in minutes, h the height of the tangent scale, and R the sighting radius; thus for 1° , $h = \frac{60 \times R}{3600} = \frac{R}{60}$. Now supposing the sight is inclined 1° to the left, which will move the notch from H to H' (see fig. 6); as before $HH' = \frac{R}{60}$, but in this case $R = h = \frac{R}{60}$. $HH' = \frac{R}{60 \times 60}$, the resultant angle of deflection is HFH' , and this can be determined by the same formula $a = \frac{h \times 1200 \times 3}{R}$, but in this case $h = HH' = \frac{R}{60 \times 60}$ $\therefore a = \frac{R \times 3600}{R \times 3600} = 1'$, so that if the sight is inclined to the left 1° it will give $1'$ deflection for every degree of elevation. By the same



FIG. 6.—Correction for Drift.

formula it can be shown that $1'$ deflection will alter the point of impact by 1 in. for every 100 yds. of range; thus the proper inclination to give a mean correction for drift can be determined. In the early R.B.L. guns this angle was $2^\circ 16'$. With rifled guns deflection was also found necessary to allow for effect of wind, difference of level of trunnions, movement of target, and for the purpose of altering the point of impact laterally.

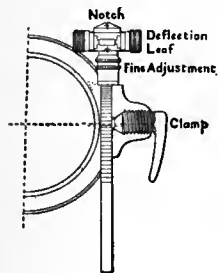

FIG. 7.

This was arranged for by a movable leaf carrying the sighting V , worked by means of a mill-headed screw provided with a scale in degrees and fractions to the same radius as the elevation scale, and an arrow-head for reading. Other improvements were: the gun was sighted on each side, tangent scales dropping into sockets in a sighting ring on the breech, thus enabling a long scale for all ranges to be used, and the foresights screwing into holes or dropping into sockets in the trunnions, thus obviating the fouling of the line of sight, and the damage to which a fixed muzzle sight was liable.

The tangent sight was graduated in yards as well as degrees and had also a fuze scale. The degree scale was subdivided to $10'$ and a slow-motion screw at the head enabled differences of one minute to be given; a clamping screw and lever were provided (see fig. 7).

Fore-sights varied in pattern. Some screwed in, others dropped into a socket and were secured by a bayonet joint. Two main shapes were adopted for the apex—the acorn and the hogsback. Instruction in the use of sights was based on the principle of securing uniformity in laying; for this reason fine sighting was discountenanced and laying by full sight enjoined. "The centre of the line joining the two highest points of the notch of the foresight and the target must be in line" (*Field Artillery Training*, 1902) (see fig. 8).

Since the early days of rifled guns tangent sights have been improved in details, but the principles remain the same. Except for some minor differences the tangent sights were the same for all natures of guns, and for all services, but the development of the modern sight has followed different lines according to the nature and use of the gun, and must be treated under separate heads.

Sights for Mobile Artillery.

With the exception of the addition of a pin-hole to the tangent sight and cross wires to the fore-sight, and of minor improvements, and of the introduction of French's crossbar sight and the reciprocating sight, of which later, no great advance was made until the introduction of Scott's telescopic sight.

This sight (see Plate, fig. 9) consists of a telescope mounted in a steel frame, provided with longitudinal trunnions fitting into V 's in the gun. These V 's are so arranged that the axis of the sight frame is always parallel to that of the gun. By means of a cross-level the frame can be so adjusted that the cross axis on which the telescope is mounted is always truly horizontal. Major L. K. Scott, R.E., thus described how he was led to think of the sight: "I had read in the *Daily News* an account of some experimental firing carried out by H.M.S. 'Hotspur' against the turret of H.M.S. 'Glutton.' At a

range of 200 yds. on a perfectly calm day the 'Hotspur' fired several rounds at the 'Glutton's' turret and missed it." Major Scott attributed this to tilt in the sights due to want of level of mounting (*R.A.I. Proceedings*, vol. xiii.). Tilt of sights in field guns owing to the sinking of one wheel had long been recognized as a source of error, and allowed for by a rule-of-thumb correction, depending on the fact that the track of the wheels of British field artillery gun-carriages is $60''$, so that, for every inch one wheel is lower than the other, the whole system is turned through one degree—

$$a = \frac{h \times 1200 \times 3}{60} = h \times 60 = 60' \text{ or } 1^\circ, \text{ as } h \text{ is } 1 \text{ inch.}$$

Referring to the calculations given above, this is equivalent to $1'$ deflection for every degree of elevation, which amount had to be given towards the higher wheel. This complication is eliminated in Scott's sight by simply levelling the cross axis of the telescope. Other advantages are those common to all telescopic sights. Personal error is to a great extent eliminated, power of vision extended, the sight is self-contained, there is no fore-sight, a fine pointer in the telescope being aligned on the target. It can be equally well used for direct or indirect, forward or back laying. A micrometer drum reads to $2'$, while the vernier reads to single minutes so that very fine adjustments can be made.

Disadvantages of earlier patterns were, the telescope was inverting, the drum was not graduated in yards, and drift not allowed for. These defects were all overcome in later patterns and an important addition made, viz. means of measuring the angle of sight. In speaking of quadrant elevation a brief reference was made to the necessity for making an allowance for difference of level of gun and target. Figs. 10 to 13 explain this more fully, and show that for indirect laying the angle of sight must be

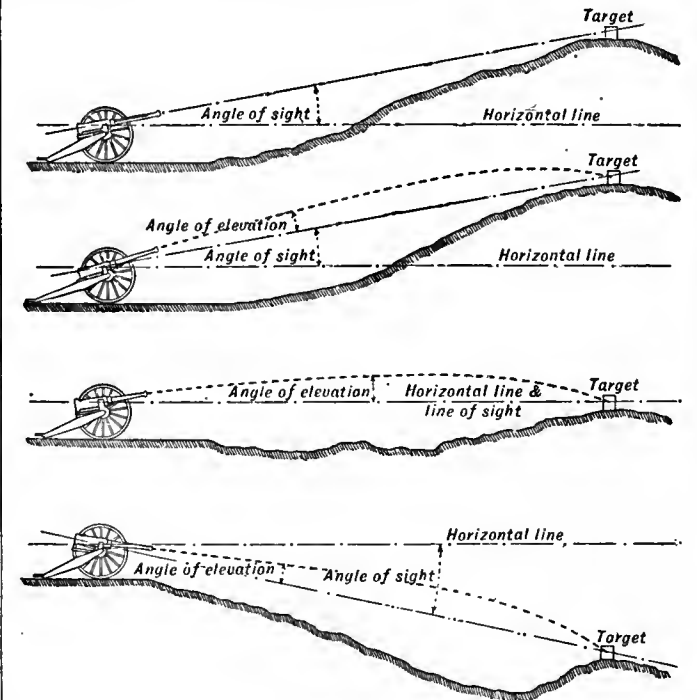

FIGS. 10, 11, 12, 13.

added to the angle of elevation if the target is above the gun, and subtracted if vice versa. In Scott's sight, mark iv., there is a longitudinal level pivoted at one end and provided with a degree scale up to 4° ; the level is moved by a spindle and micrometer screw reading to $2'$. If now the telescope be directed on the target and this level be brought to the centre of its run, the angle of sight can be read—if afterwards any range ordered is put on the sight and the gun truly layed, this bubble will be found in the centre of its run—so that if thereafter the target becomes obscured the gun can be relayed by elevating till the bubble is in the centre of its run, or at a completely concealed target the angle of sight can, if the range and difference of level are known or can be measured from somewhere near the gun, be put on by means of the micrometer screw, and the gun subsequently layed by putting the range in yards or degrees on the sight drum and elevating or depressing till the bubble is central. The disadvantages that still remain are that the sight has to be removed every time the gun is fired, and the amount of deflection is limited and has to be put on the reverse way to that on a tangent scale. Scott's sight, though no longer used with quick-firing guns, is the precursor of all modern sights.

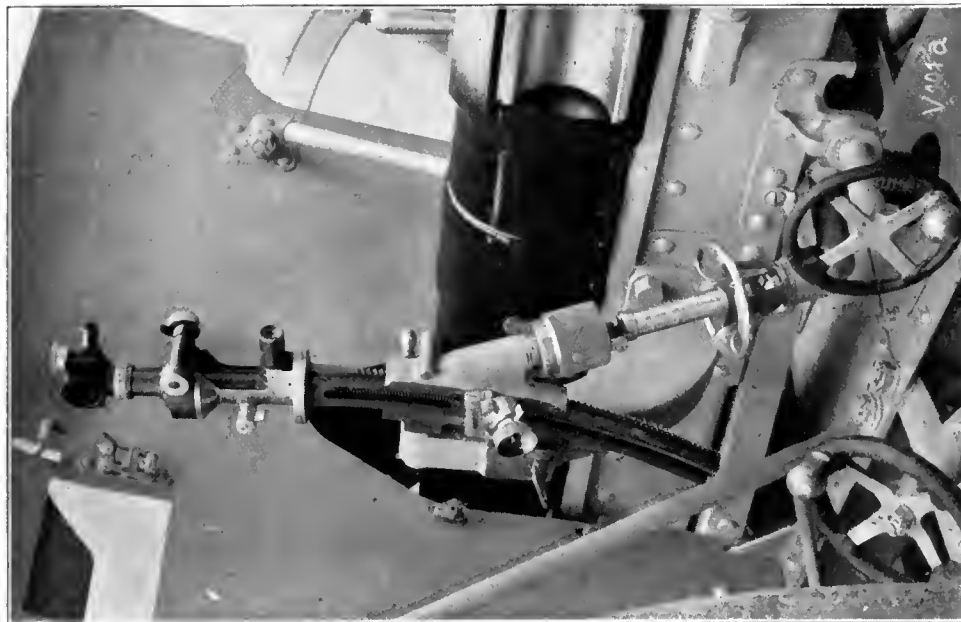

Photo, Friedr. Krupp, A.G.

FIG. 14.—KRUPP INDEPENDENT LINE OF SIGHT.

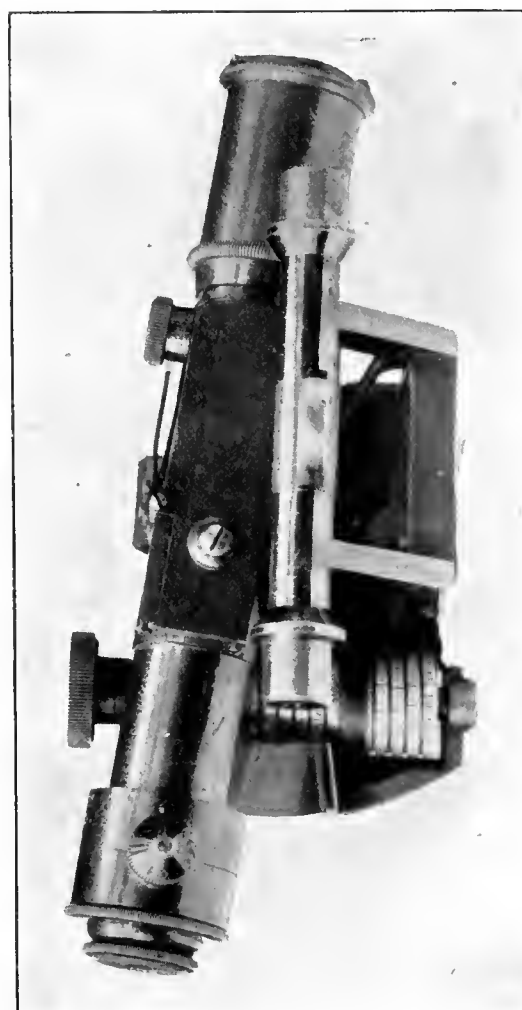
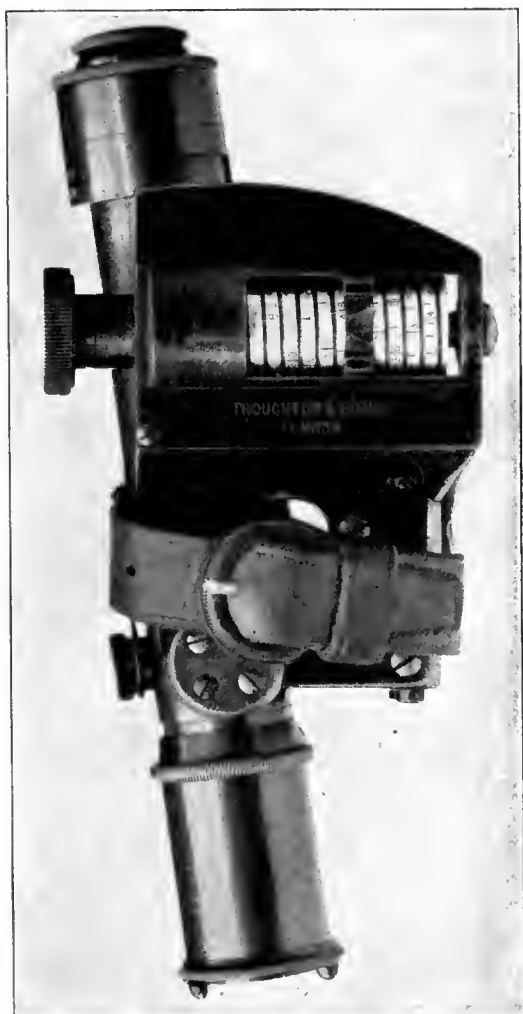

FIG. 9.—SCOTT'S TELESCOPIC SIGHT.

By permission of the Controller, H.M. Stationery Office.

The introduction of trunnionless guns recoiling axially through a fixed cradle enabled sights to be attached to the non-recoil parts of the mounting, so that the necessity of removing a delicate telescopic sight every round disappeared, and telescope sights on the rocking-bar principle (see below) were introduced for 4.7-in. Q.F. guns on field mountings; these sights admit of continuous laying, *i.e.* the eye need not be removed when the gun is fired. The increased importance of concealment for one's own guns and the certainty of being called upon to engage concealed targets, brought indirect laying into great prominence (see also ARTILLERY). This form of laying is of two kinds: (1) that in which the gun can be layed for direction over the sight on the target itself, or on some aiming point close by, but from indistinctness or other causes quadrant elevation is preferred; and (2) that used when the target is completely hidden and an artificial line of fire laid out and the guns layed for direction on pointers, or the line transferred to a distant aiming point. The old method of giving quadrant elevation by clinometer was obviously too slow. Scott's sight (see above) was the first attempt to obtain indirect laying for elevation by means of the sight itself, and in that sight the angle of sight was taken into account; in modern guns this is effected by what is technically called the "independent line of sight" (see ORDNANCE: *Field Equipments*). It is obtained by different means in different countries, but the principle is the same. There must be two sets of elevating gears, one which brings the axis of the gun and the sights together on to the target, thus finding the angle of sight and also pointing the axis of the gun at the target, and a second by which, independent of the sight which remains fixed, the elevation due to the range can be given to the gun and read by means of a pointer and dial marked in yards for range. This latter is shown in the Krupp equipment (Plate, fig. 14), in which the sight is attached to the cradle, but does not move with it. The hand-wheel that screws the gun and cradle down at the same time screws the sight up, and vice versa. When the target is completely concealed it is necessary to lay the gun on an aiming point more or less out of the line of fire, or to lay on a "director" with a large amount of deflection, and to align aiming posts with the sights at zero to give the direction of the target, and afterwards perhaps to transfer the line of sight to some other distant object, all of which require a far greater scope of deflection than is afforded by the deflection leaf. In the South African war improvised detachable deflection scales of wood or iron placed over the fore-sight, called gun arcs, were used, but this device was clumsy, inaccurate and insufficient, as it only gave about 30° right or left deflection, and only a sight that admitted of all-round laying could really satisfy the requirements. "The goniometric sight in its simplest form is a circular graduated base plate on which a short telescope or sighted ruler is pivoted. Besides the main graduations there is usually a separate deflection scale" (Bethell). In this form, which is found in British field artillery, the goniometric or dial sight is used for picking up the line of fire. In the pillar sight used in the French 80- and 90-mm. Q.F. guns it is used for laying for direction.

The *collimateur*, or sight proper, has a lateral movement of 9°, and is actuated by the drum on the right turned by the mill-headed screw. The drum is divided into 100 graduations, each equal to 5.4'. The gonio plate below is divided into 4 quadrants, and each quadrant into 10 spaces of 9° each numbered in hundreds from 0 to 900. The stem is turned by pressing down on the mill-headed screw. The *collimateur* which is used in many sights is a rectangular box closed at one end by a darkened glass with a bright cross. Its use is graphically described in a French text-book thus: "The layer, keeping his eye about a foot from the *collimateur* and working the elevating wheel, makes the horizontal line dance about the landscape until it dances on to the target; then working the traversing gear he does the same with the vertical line; then bringing his eye close, he brings the intersection on to the target." In the Krupp arc sight (see Plate, fig. 14), the goniometric sight is placed on the top of the arc. In the French field Q.F. artillery the intermediate carriage (see description and diagram in article ORDNANCE: *Field Equipments*) carries the sight.

Fig. 15 shows the reciprocating sight for the 2.5-in. gun. The sight drops through a socket in a pivoted bracket which is provided with a level and a clamp; the level is fixed at the correct angle for drift; if the sight (as is especially liable to be the case on steep hillsides) is tilted away from the angle it can be restored by moving the bracket till the bubble of the spirit-level is central, and then clamping it. With howitzers indirect laying is the rule, elevation being usually given by clinometer, direction by laying on banderols marking out the line of fire; then, when the direction has been established, an auxiliary mark, usually in rear, is selected and the line transferred to it. At night this mark is replaced by a lamp installed in rear

and in line with the sights. The normal method of laying these is from the fore-sight over the tangent sight to a point in rear. Special sights were designed for this purpose by Colonel Sir E. H. French, called cross-bar sights, and were in the year 1908 still in use with British 6-in. B.L. howitzers. The principle of these sights (see fig. 16) is that the tangent sight has a steel horizontal bar which can slide through the head of the tangent scale for deflection, and is graduated for 3° left and 1° right deflection. One end of the bar is slotted to take the sliding leaf; this end of the bar is graduated from 0° to 6°, and in conjunction with the fore-sight affords a lateral scope of 6° on either side of the normal for picking up an auxiliary mark. The fore-

sight has a fixed horizontal bar slotted and graduated similarly to the slotted portion of the tangent sight. The leaves are reversible, and provided with a notch at one end and a point at the other, so that they can be used for either forward or reverse laying. The leaf of the fore-sight has a pinhole, and that of the tangent sight cross-wires for fine reverse laying. Fore-sights are made right and left; tangent sights are interchangeable, the graduations are cut on the horizontal edges above and below, so that the sight can be changed from right to left or vice versa by removing and reversing the bar. Howitzer sights are vertical and do not allow for drift; they are graduated in degrees only. Goniometric sights have recently been introduced into British siege artillery. The pattern is that of a true sight, that is to say, the base plate is capable of movement about two axes, one parallel to and the other at right angles to the axis of the gun, and has cross spirit-levels and a graduated elevating drum and independent deflection scale, so that compensation for level of wheels can be given and quadrant elevation.

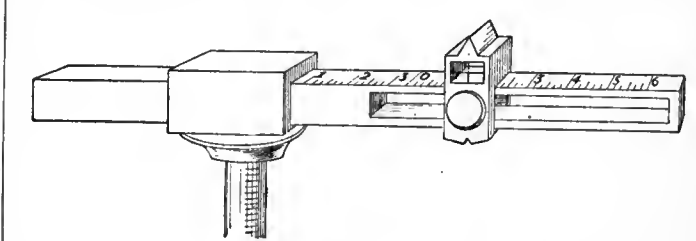

FIG. 16.

In smooth-bore days the term mortar meant a piece of ordnance of a peculiar shape resting on a bed at a fixed angle of quadrant elevation of 45°. It was ranged by varying the charge, and layed for line by means of a line and plumb bob aligned on a picket. The term mortar, though not used in the British service, is still retained elsewhere to signify very short, large-calibre howitzers, mounted on a bed with a minimum angle of elevation of 45°, which with the full charge would give the maximum range. Range is reduced by increasing the angle of elevation (by clinometer) or by using reduced charges. In the 9.45-in. Skoda howitzer, which is really a mortar as defined above, direction is given by means of a pointer on the mounting and a graduated arc on the bed. For a description of Goerz panoramic, "ghost" and other forms of sights, see Colonel H. A. Bethell, *Modern Guns and Gunnery* (Woolwich, 1907), and for sights used in the United States, Colonel O. M. Lissak, *Ordnance and Gunnery* (New York and London, 1907).

Sights for Coast Defence Artillery (Fixed Armaments).

In coast defence artillery, owing to the fact that the guns are on fixed mountings at a constant height (except for rise and fall of tide) above the horizontal plane on which their targets move, and that consequently the angle of sight and quadrant elevation for every range can be calculated, developments in sights, in a measure, gave way to improved means of giving quadrant elevation. Minor improvements in tangent sights certainly were made, notably an automatic clamp, but quadrant elevation was mainly used, and in the case of guns equipped with position-finders (see RANGE-FINDER) the guns could be layed for direction by means of a graduated arc on the emplacement and a pointer on the mounting. A straight-edge or vertical blade (see fig. 17) was placed above the leaf of the tangent sight, and in some cases on the fore-sight as well, to facilitate laying for line. This enabled the gun to be layed from some little distance behind, so that the layer could be clear of recoil, and continuous laying was thus possible. The arrangements for giving quadrant elevation consisted of an arc, called index plate (see fig. 18), on the gun, graduated in degrees read by a "reader" on the carriage. A yard scale of varnished paper, made out locally for quadrant elevation with regard to height of site, was usually pasted over this. A correction for level of tide was in many cases necessary, and was

From *Treatise on Service Ordnance*.

FIG. 17.

Siege artillery sights.

Laying Mortars.

entered in a table or mounted on a drum which gave several corrections that had to be applied to the range for various causes. One great drawback to this system was that elevation was given with reference to the plane of the racers upon which the mounting moved, and as this was not always truly horizontal grave errors were introduced. To overcome this Colonel H. S. Watkin, C.B., introduced a hydroclinometer fixed on the trunnion. It was provided with a yard scale calculated with reference to height of site, and elevation was read by the intersection of the edge of the liquid with the graduation for the particular range. Special sights were introduced to overcome the difficulties of disappearing guns, large guns firing through small ports, &c. Such were the Moncrieff reflecting sights, and the "chase sights" for the 10-in. gun in which the rear sight, equipped with a mirror, was placed on the chase, and the

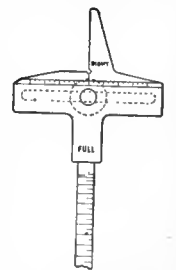
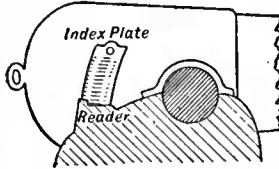

FIG. 18.—Sketch of Index Plate and Reader.

fore-sight on the muzzle, &c. In the early days of B.L. guns very little change was made in the pattern of sights. Shield sights were introduced for disappearing mountings to admit of continuous laying for line, and a disk engraved for yards of range duly corrected for height, and called an "elevation indicator," replaced the index plate and reader. As in mobile artillery, the introduction of trunnionless guns brought about a revolution in laying and sights. Smokeless powder also made rapid firing a possibility and a necessity. Continuous laying and telescopic sights became possible. The reduction of friction by improved mechanical arrangements, and the introduction of electric firing, enabled the layer not only to train and elevate the gun himself, but also to fire it the moment it was truly "on" the target. The rocking-bar sight, which had been for some time in use in the navy, was introduced. In this sight both hind and fore sights are fixed on a rigid bar pivoted about the centre; the rear end is raised or depressed by a rack worked by a hand-wheel; ranges are read from the periphery of a drum; the fore-sight and leaf of the hind-sight are provided with small electric glow lamps for night firing. In addition to these open sights the bar also carries a sighting telescope. The advantages compared with a tangent sight are that only half the movement is required to raise the sight for any particular range; the ranges on the drum are easier to read, and if necessary can be set by another man, so that the layer need not take his eye from the telescope. The pattern of telescope used in coast defence is that designed by Dr Common. It is an erecting telescope with a field of view of 10° and a magnification of 3 diameters, and admits plenty of light. The diamond-shaped pointer is always in focus; focusing for individual eyesight is effected by turning the eye-piece, which is furnished with a scale for readjustment. A higher power glass has since been introduced for long ranges.

Rocking-bar sight.

The pattern of telescope used in coast defence is that designed by Dr Common. It is an erecting telescope with a field of view of 10° and a magnification of 3 diameters, and admits plenty of light. The diamond-shaped pointer is always in focus; focusing for individual eyesight is effected by turning the eye-piece, which is furnished with a scale for readjustment. A higher power glass has since been introduced for long ranges.

The improvements in gun mountings mentioned above led the way to the introduction of the automatic sight. The principle of combined sight and range-finder had long been known, and was embodied in the so-called "Italian" sight, but, on account of the slow rate of fire imposed by black powder, the rapidity of laying conferred by its use was of no great advantage, and it was unsuited to the imperfect mechanical arrangements of the gun mountings of the time. When cordite replaced black powder, and the gun sights and all in front of the gun were no longer obscured by hanging clouds of smoke, it became a desideratum, and, as the automatic sight, it was reintroduced by Sir G. S. Clarke, when he, as superintendent of the Royal Carriage Factory, had brought gun mountings to such a pitch of perfection that it could be usefully employed.

An automatic sight is a sight connected in such a manner with the elevating gear of the gun, that when the sight is directed on the water-line of a target at any range the gun will have the proper quadrant elevation for that range. Colonel H. S. Watkin, C.B., describes the theory of the sight thus (*Proceedings R.A.I.* 1898).

Conditions.—The gun must be at a certain known height above sea-level—the greater the height the greater the accuracy. The racer path must be level. Let FB (fig. 19) represent a gun at height BD above water-level DC, elevated to such an angle that a shot would strike the water at C. Draw EB parallel to DC. It is clear that under these conditions, if a tangent sight AF be raised to a height F representing the elevation due to the range BC, the object C will be on the line of sight. Then ABF = angle of elevation; EFB = quadrant angle; BCD = angle of sight; EBF = ABF - ABE; and since ABE = BCD, it also equals ABF - BCD. BCD can always be calculated from the formula, angle of sight in minutes = $\frac{h \text{ (in feet)} \times 1146}{R \text{ (in yards)}}$ (h = height of gun above sea-level; R = range). An automatic sight based on the Italian sight was tried in 1878-1879. In this

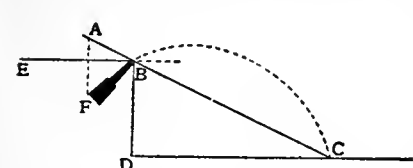
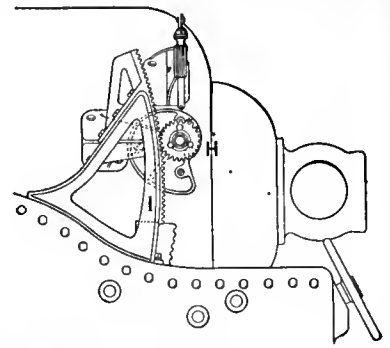

FIG. 19.—Theory of the Automatic Sight.

Conditions.—The gun must be at a certain known height above sea-level—the greater the height the greater the accuracy. The racer path must be level. Let FB (fig. 19) represent a gun at height BD above water-level DC, elevated to such an angle that a shot would strike the water at C. Draw EB parallel to DC. It is clear that under these conditions, if a tangent sight AF be raised to a height F representing the elevation due to the range BC, the object C will be on the line of sight. Then ABF = angle of elevation; EFB = quadrant angle; BCD = angle of sight; EBF = ABF - ABE; and since ABE = BCD, it also equals ABF - BCD. BCD can always be calculated from the formula, angle of sight in minutes = $\frac{h \text{ (in feet)} \times 1146}{R \text{ (in yards)}}$ (h = height of gun above sea-level; R = range). An automatic sight based on the Italian sight was tried in 1878-1879. In this

(see fig. 20) a rack I, fixed to the carriage, caused a pinion H on the gun to revolve. Fixed to the pinion were three cams, for high, low and mean tides. The tangent scale moved freely in a socket fixed to the gun; its lower end rested on one of the cams, cut to a correct curve. It followed that when the gun was elevated or depressed, the rack caused the pinion to revolve, and the sight was thus raised or lowered to the proper height to fulfil the conditions given above; but, as Colonel Watkin said, owing to want of level of platform and other causes it was not satisfactory. With the introduction of quick-firing guns it was felt that the layer should have the same control over his gun as a marksman had over his rifle, and this would be afforded by a satisfactory automatic sight. The principle of the modern automatic sight is made clear in figs. 21 and 22, which show a combined rocking-bar and automatic sight. The rocking-bar consists of a carrier a fixed to the cradle, a rocking-bar d pivoted to the carrier at e , a sight bar f carrying the sights and sighting telescope. The rocking-bar is moved by a rack g into which a pinion on a cross-spindle j gears; the cross-spindle is moved by means of a worm-wheel into which a worm on the longitudinal

(see fig. 20) a rack I, fixed to the carriage, caused a pinion H on the gun to revolve. Fixed to the pinion were three cams, for high, low and mean tides. The tangent scale moved freely in a socket fixed to the gun; its lower end rested on one of the cams, cut to a correct curve. It followed that when the gun was elevated or depressed, the rack caused the pinion to revolve, and the sight was thus raised or lowered to the proper height to fulfil the conditions given above; but, as Colonel Watkin said, owing to want of level of platform and other causes it was not satisfactory. With the introduction of quick-firing guns it was felt that the layer should have the same control over his gun as a marksman had over his rifle, and this would be afforded by a satisfactory automatic sight. The principle of the modern automatic sight is made clear in figs. 21 and 22, which show a combined rocking-bar and automatic sight. The rocking-bar consists of a carrier a fixed to the cradle, a rocking-bar d pivoted to the carrier at e , a sight bar f carrying the sights and sighting telescope. The rocking-bar is moved by a rack g into which a pinion on a cross-spindle j gears; the cross-spindle is moved by means of a worm-wheel into which a worm on the longitudinal



Proceedings R.A. Institute.

FIG. 20.—"Italian" Sight.

The rocking-bar consists of a carrier a fixed to the cradle, a rocking-bar d pivoted to the carrier at e , a sight bar f carrying the sights and sighting telescope. The rocking-bar is moved by a rack g into which a pinion on a cross-spindle j gears; the cross-spindle is moved by means of a worm-wheel into which a worm on the longitudinal

The rocking-bar consists of a carrier a fixed to the cradle, a rocking-bar d pivoted to the carrier at e , a sight bar f carrying the sights and sighting telescope. The rocking-bar is moved by a rack g into which a pinion on a cross-spindle j gears; the cross-spindle is moved by means of a worm-wheel into which a worm on the longitudinal

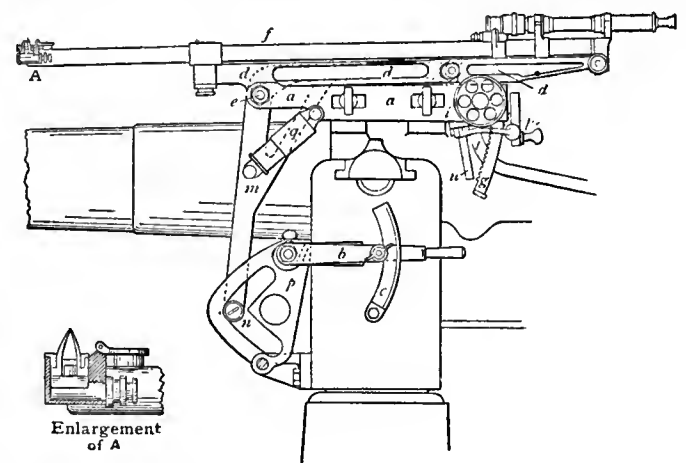

From War Office Handbook.

FIG. 21.

spindle of the hand-wheel gears; one end of the cross-spindle moves the range drum z' . The worm and hand-wheel are thrown into and out of gear by means of the clutch l . When the hand-wheel is thrown out of gear the sights can only be moved by means of the elevating gear of the gun. The line of sight and the elevation of the gun henceforth are inseparable. The automatic sight consists of a bent lever roller cam m , also secured by the bolt e to the carrier; the lower end of the lever carries the cam roller n , which is constrained to move in the cam p by means of the spring in the spring-box g ; the rear end of the horizontal arm of the lever is formed into jaws v ; the same action of the clutch l which releases the worm and hand-wheel forces a catch on a vertical stem u into the jaws of the lever, and fixes the rocking and sight bars rigidly to it. The movement of the sights can now only be effected by means of the elevating gear of the gun; acting by means of the movement of the vertical arm of the bent lever, and its movement is constrained to follow the cam, which is cut in such a way that for any given elevation of the gun the sight bar is depressed to the angle of sight for the range corresponding to the elevation; b' is a lever for making allowance for state of tide, and c' is the scale on which the rise and fall in feet above and below mean sea-level are marked. In later patterns, the sight is automatic pure and simple, the lever is rigidly attached to the rocking-bar, and the range scale and gear for raising the sights dispensed with, much as shown in fig. 23. In the larger natures of

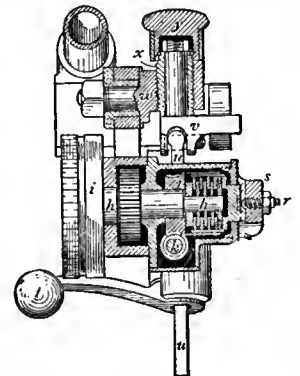

From War Office Handbook.

FIG. 22.

the larger natures of the sight is automatic pure and simple, the lever is rigidly attached to the rocking-bar, and the range scale and gear for raising the sights dispensed with, much as shown in fig. 23. In the larger natures of

gun there is a rocking-bar sight on one side and an automatic sight on the other. The automatic sight has, however, distinct limitations; it depends for its accuracy on height of site, and at long ranges even from a high site it cannot compare for accuracy with independent range-finding and careful laying or accurately applied quadrant elevation; it is also useless when the water line of the target is obscured, as may often be the case from the splashes caused by bursting shell. Improved communications between range-finder and gun, range and training dials placed on the mountings where

they can be read by the layers, and more accurate elevation indicators have made laying by quadrant elevation, and in certain cases giving direction by means of graduated arc and pointer, both accurate and rapid, so that once more this system of laying is coming into favour for long ranges.

Naval Sights.

In the navy the conditions of an unstable platform rendered quadrant elevation of little use, and necessitated a special pattern of tangent sight to facilitate firing the moment the roll of the ship brought the sights on the target. A diagram of the Foote-Arbuthnot, or H, or naval tangent sight, is given below (fig. 24).

The fore-sight was a small globe, and in the original patterns this was placed on a movable leaf on which deflection for speed of one's own ship was given, while deflection for speed of enemy's ship and wind were given on the tangent sight. The yard scales were on detachable strips, so that fresh strips could be inserted for variations in velocity. In subsequent patterns all the deflection was given on the tangent sight, which was provided with two scales, the upper one graduated in knots for speed of ship, and the lower one in degrees. Night sights were introduced by Captain McEvoy in 1884. They consist of an electric battery cable and lamp-holders and small glow lamps; that for the hind-sight is coloured.

Turret Sights.—In turrets or barbettes two sets of sights are provided, one for each gun. They are geared so as to work simultaneously and alike. Toothed gearing connected with the gun mountings actuates a rack attached to the standards carrying the sights, so that any movement of the gun mounting is communicated to the sights. The sights themselves fit into sockets cut at the proper angle for drift, and are raised in their sockets the requisite amount for the range by means of a small hand-wheel; they are thus non-recoiling sights. The layer has under his control the hand-wheel for setting the range on the sights, another hand-wheel for elevating the gun and the sights on to the target, and a third for traversing the turret.

The introduction of trunnionless guns was followed by that of rocking-bar sights (described above). Sighting telescopes were also introduced. In the navy one of the first essentials is rapidity of fire; to attain this the duties of laying are subdivided; one man laying for elevation, elevating and firing, a second laying for line and traversing, and a third putting on the elevation ordered or communicated by electric dial. To ensure the sights on each side reading together they are connected by rods. To facilitate the setting of the range the ranges are shown on a dial which can be read from the side of the mounting, from where also the sight can be set.

Military Rifle Sights.

With smooth-bore arms of short range, the soldier needed little more, in the way of sights, than the rough equivalent of the dispart of cannon, viz. patches at the breech and muzzle with notch and blade (fig. 25). But some form of sight was almost invariably employed with rifled firearms, even of early date, and when about 1780-1800 the rifle came into use as a military weapon, sights were introduced with it. The sights of the Baker, Brunswick, and other rifles did not differ in principle from the now common form of elevating back-sight (fig. 29), that is, the elevation was given on an upright adjustable back sight. But this refinement was long looked upon as a mere fad, both by the soldiers who used the smooth-bore (or converted rifle) musket, and by experienced short-range snappers. In this connexion Major-General John Gibbon, U.S.A., records that in the American Civil War hunters and others who

served in the western regiments habitually knocked off the back-sights of the rifles that were issued to them, preferring to do without them. But, as rifles improved and came into general use for all troops, sights became indispensable, and to-day as much care is

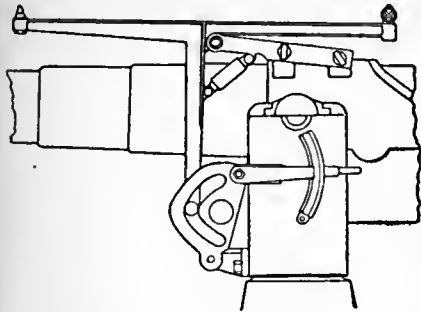

FIG. 23.

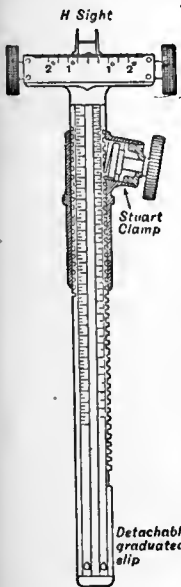

FIG. 24.

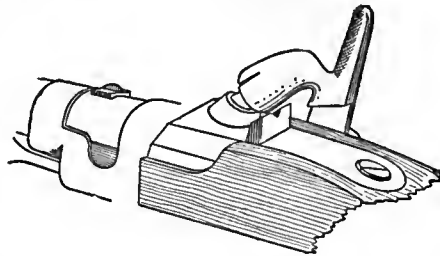

FIG. 25.



FIG. 26.



FIG. 27.

taken over the sighting as over the "proof" of a military rifle. The modern rifle has invariably a back-sight and a fore-sight. The latter is, as a general rule, fixed and unalterable, its size, position on the barrel, &c., being practically ascertained, as accurately as possible, for the lowest elevation on the back-sight. Some fore-sights have, however, a lateral motion giving within narrow limits the deflection found to be necessary for the variation of each rifle from the average. The shape of the part seen through the notch or

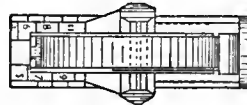
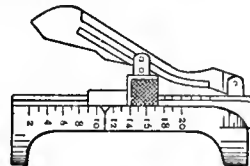

FIG. 28.

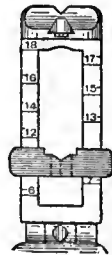

FIG. 29.

aperture of the back-sight in aiming varies a good deal. Two of the commonest forms are shown in fig. 26, called the "barleycorn," and 27, called the "bead." The fore-sight of the Krag-Jørgensen rifle, used in the United States army until 1906, consisted of a blade with parallel sides. The shape of the part seen when aiming indicates whether the proper amount of the fore-sight is taken up into the line of vision from the back-sight to the target. A "full" sight is shown in fig. 8 above. The position of the fore-sight at or near

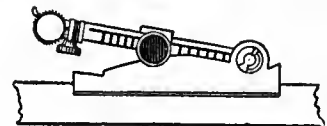

FIG. 30.

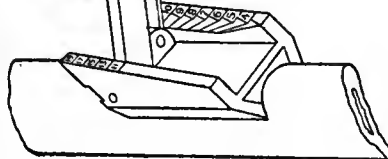

FIG. 31.

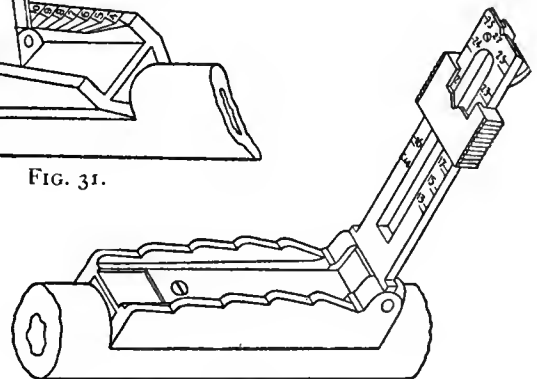

FIG. 32.

the end of the barrel renders it peculiarly liable to injury, and in some rifles therefore it is provided with guards or ears; these, however, have the disadvantage that more or less of the light that would otherwise light up the sight is intercepted by the guards. The fore-sight of the British service "short" Lee-Enfield (1903) has guards and also a lateral adjustment of the barleycorn. Back-sights are of many different patterns, almost any two being

unlike. Examples taken, except fig. 28, by permission from the *Text Book of Small Arms* (1909), are given in fig. 28 (German Mauser pattern), fig. 29 ("long" hand-loader Lee-Enfield), fig. 30 ("short" Lee-Enfield), fig. 31 (Dutch service rifle), and fig. 32 (Russian "three-line" rifle). Fine lateral adjustments are provided on the "short" Lee-Enfield, and on many other military sights of modern date. See for further details RIFLE.

AUTHORITIES CONSULTED.—Owen, *Modern Artillery*; Lloyd and Hadcock, *Artillery, its Progress and Present Position*; Lissak, *Ordinance and Gunnery*; Colonel H. A. Bethell, *Modern Guns and Gunnery*; *Proceedings and Occasional Papers*, R.A. Institute, and War Office publications.

SĪGIRI, the Lion's Rock, the ruin of a remarkable stronghold 7° 59' N., and 81° E., 14 m. N.E. of Dambulla, and about 17 m. nearly due W. of Pulastī-pura, the now ruined ancient capital of Ceylon. There a solitary pillar of granite rock rises to a great height out of the plain, and the top actually overhangs the sides. On the summit of this pencil of rock there are five or six acres of ground; and on them, in A.D. 477, Kasyapa the Parricide built his palace, and thought to find an inaccessible refuge from his enemies. His father Dhātu Sena, a country priest, had, after many years of foreign oppression, roused his countrymen, in 459, to rebellion, led them to victory, driven out the Tamil oppressors, and entered on his reign as a national hero. He was as successful in the arts of peace as he had been in those of war; and carried to completion, among other good works, an ambitious irrigation scheme—probably the greatest feat of engineering that had then been accomplished anywhere in the world. This was the celebrated Kalā Wewa, or Black Reservoir, more than 50 m. in circumference, which gave wealth to the whole country for two days' journey north of the capital, Anurādha-pura, and provided that city also with a constant supply of water. Popular with the people, the king could not control his own family; and as the outcome of a palace intrigue in 477 his son Kasyapa had declared himself king, and taken his father prisoner. Threatened with death on his refusing to say where his treasure lay hid, the old king told them to take him to the tank. They took him there, and while bathing in the water he let some of it drop through his fingers, and said, "This is my treasure; this, and the love of my people." Then Kasyapa had his father built up alive into a wall. Meanwhile, Kasyapa's brother had escaped to India and was plotting a counter revolution. It was then that the parricide prepared his defence. He utilized his father's engineers in the construction of a path or gallery winding up round the SĪgiri rock. Most of it was made, by bursting the rock by means of wooden wedges, through the solid granite, and its outside parapet was supported by walls of brick resting on ledges far below. It is a marvellous piece of work. Abandoned since 495—for Kasyapa was eventually slain during a battle fought in the plain beneath—it has, on the whole, well withstood the fury of tropical storms, and is now used again to gain access to the top. When rediscovered by Major Forbes in 1835 the portions of the gallery where it had been exposed for so many centuries to the south-west monsoon, had been carried away. These gaps have lately been repaired, or made passable with the help of iron stanchions; the remains of the buildings at the top and at the foot of the mountain have been excavated; and the entrance to the gallery, between the outstretched paws of a gigantic lion, has been laid bare. The fresco paintings in the galleries are perhaps the most interesting of the extant remains. They are older than any others found in India, and have been carefully copied, and, as far as possible, preserved.

See Major Forbes, *Eleven Years in Ceylon* (London, 1841); H. C. P. Bell, *Archaeological Reports* (Colombo, 1892-1906); Rhys Davids, "SĪgiri, the Lion Rock," in *Journal of the Royal Asiatic Society* (1875), pp. 191-220; H. W. Cave, *Ruined Cities of Ceylon* (London, 1906). (T. W. R. D.)

SIGISMUND (1368-1437), Roman emperor and king of Hungary and Bohemia, was a son of the emperor Charles IV. and Elizabeth, daughter of Bogislaus V., duke of Pomerania. He was born on the 15th of February 1368, and in 1374 was betrothed to Maria, the eldest daughter of Louis the Great, king of Poland and Hungary. Having become margrave of Brandenburg on his father's death in 1378, he was educated at the Hungarian court

from his eleventh to his sixteenth year, becoming thoroughly magyarized and entirely devoted to his adopted country. His wife Maria, to whom he was married in 1385, was captured by the rebellious Horvathys in the following year, and only rescued by her young husband with the aid of the Venetians in June 1387. Sigismund had been crowned king of Hungary on the 31st of March 1387, and having raised money by pledging Brandenburg to his cousin Jobst, margrave of Moravia, he was engaged for the next nine years in a ceaseless struggle for the possession of this unstable throne. The bulk of the nation headed by the great Garay family was with him; but in the southern provinces between the Save and the Drave, the Horvathys with the support of the Bosnian king Tvrtko, proclaimed as their king Ladislaus, king of Naples, son of the murdered Hungarian king, Charles II. (see HUNGARY). Not until 1395 did the valiant Miklós Garay succeed in suppressing them. In 1396 Sigismund led the combined armies of Christendom against the Turks, who had taken advantage of the temporary helplessness of Hungary to extend their dominion to the banks of the Danube. This crusade, preached by Pope Boniface IX., was very popular in Hungary. The nobles flocked in thousands to the royal standard, and were reinforced by volunteers from nearly every part of Europe, the most important contingent being that of the French led by John, duke of Nevers, son of Philip II., duke of Burgundy. It was with a host of about 90,000 men and a flotilla of 70 galleys that Sigismund set out. After capturing Widdin, he sat down before the fortress of Nicopolis, to retain which Sultan Bajazid raised the siege of Constantinople and at the head of 140,000 men completely overthrew the Christian forces in a battle fought between the 25th and 28th of September 1396. Deprived of his authority in Hungary, Sigismund then turned his attention to securing the succession in Germany and Bohemia, and was recognized by his childless step-brother Wenceslaus as vicar-general of the whole empire. He remained, however, powerless when in 1400 Wenceslaus was deposed and Rupert III., elector palatine of the Rhine, was elected German king in his stead. During these years he was also involved in domestic difficulties out of which sprang a second war with Ladislaus of Naples; and on his return to Hungary in 1401 he was once imprisoned and twice deposed. This struggle in its turn led to a war with Venice, as Ladislaus before departing to his own land had sold the Dalmatian cities to the Venetians for 100,000 ducats. In 1401 Sigismund assisted a rising against Wenceslaus, during the course of which the German and Bohemian king was made a prisoner, and Sigismund ruled Bohemia for nineteen months. In 1410 the German king Rupert died, when Sigismund, ignoring his step-brother's title, was chosen German king, or king of the Romans, first by three of the electors on the 20th of September 1410, and again after the death of his rival, Jobst of Moravia, on the 21st of July 1411; but his coronation was deferred until the 8th of November 1414, when it took place at Aix-la-Chapelle.

During a visit to Italy the king had taken advantage of the difficulties of Pope John XXIII. to obtain a promise that a council should be called to Constance in 1414. He took a leading part in the deliberations of this assembly, and during the sittings made a journey into France, England and Burgundy in a vain attempt to secure the abdication of the three rival popes (see CONSTANCE, COUNCIL OF). The complicity of Sigismund in the death of John Huss is a matter of controversy. He had granted him a safe-conduct and protested against his imprisonment; and it was during his absence that the reformer was burned. An alliance with England against France, and an attempt to secure peace in Germany by a league of the towns, which failed owing to the hostility of the princes, were the main secular proceedings of these years. In 1419 the death of Wenceslaus left Sigismund titular king of Bohemia, but he had to wait for seventeen years before the Czechs would acknowledge him. But although the two dignities of king of the Romans and king of Bohemia added considerably to his importance, and indeed made him the nominal head of Christendom, they conferred no increase of power and financially embarrassed him. It was only

as king of Hungary that he had succeeded in establishing his authority and in doing anything for the order and good government of the land. Entrusting the government of Bohemia to Sophia, the widow of Wenceslaus, he hastened into Hungary; but the Bohemians, who distrusted him as the betrayer of Huss, were soon in arms; and the flame was fanned when Sigismund declared his intention of prosecuting the war against heretics who were also communists. Three campaigns against the Hussites ended in disaster; the Turks were again attacking Hungary; and the king, unable to obtain support from the German princes, was powerless in Bohemia. His attempts at the diet of Nuremberg in 1422 to raise a mercenary army were foiled by the resistance of the towns; and in 1424 the electors, among whom was Sigismund's former ally, Frederick I. of Hohenzollern, margrave of Brandenburg, sought to strengthen their own authority at the expense of the king. Although the scheme failed, the danger to Germany from the Hussites led to fresh proposals, the result of which was that Sigismund was virtually deprived of the leadership of the war and the headship of Germany. In 1431 he went to Milan where on the 25th of November he received the Lombard crown; after which he remained for some time at Siena, negotiating for his coronation as emperor and for the recognition of the Council of Basel by Pope Eugenius IV. He was crowned emperor at Rome on the 31st of May 1433, and after obtaining his demands from the pope returned to Bohemia, where he was recognized as king in 1436, though his power was little more than nominal. On the 9th of December 1437 he died at Znaim, and was buried at Grosswardein. By his second wife, Barbara of Cilli, he left an only daughter, Elizabeth, who was married to Albert V., duke of Austria, afterwards the German king Albert II., whom he named as his successor. As he left no sons the house of Luxemburg became extinct on his death.

Sigismund was brave and handsome, courtly in his bearing, eloquent in his speech, but licentious in his manners. He was an accomplished knight and is said to have known seven languages. He was also one of the most far-seeing statesmen of his day, and steadily endeavoured to bring about the expulsion of the Turks from Europe by uniting Christendom against them. As king of Hungary he approved himself a born political reformer, and the military measures which he adopted in that country enabled the kingdom to hold its own against the Turks for nearly a hundred years. His sense of justice and honour was slight; but as regards the death of Huss he had to choose between condoning the act and allowing the council to break up without result. He cannot be entirely blamed for the misfortunes of Germany during his reign, for he showed a willingness to attempt reform; but he was easily discouraged, and was hampered on all sides by poverty, which often compelled him to resort to the meanest expedients for raising money.

BIBLIOGRAPHY.—The more important works to be consulted are *Repertorium Germanicum*; *Regesten aus den päpstlichen Archiven zur Geschichte des deutschen Reichs im XIV. und XV. Jahrhundert* (Berlin, 1897); E. Windecke, *Denkwürdigkeiten zur Geschichte des Zeitalters Kaisers Sigismund* (Berlin, 1893), and *Das Leben Königs Sigmund* (Berlin, 1886); J. Aschbach, *Geschichte Kaiser Sigmunds* (Hamburg, 1838-1845); W. Berger, *Johannes Hus und König Sigmund* (Augsburg, 1871); G. Schönherr, *The Inheritors of the House of Anjou* (Buda-Pesth, 1895); and J. Acsády, *History of the Hungarian Realm*, vol. i. (Buda-Pesth, 1903). Of the German books Aschbach is the fullest, and Windecke the most critical. Schönherr is the best Hungarian authority. Acsády is too indulgent to the vices of Sigismund. See also A. Main, *The Emperor Sigismund* (1903).

SIGISMUND I. (1467-1548), king of Poland, the fifth son of Casimir IV. and Elizabeth of Austria, was elected grand-duke of Lithuania on the 21st of October 1505 and king of Poland on the 8th of January 1506. Sigismund was the only one of the six sons of Casimir IV. gifted with extraordinary ability. He had served his apprenticeship in the art of government first as prince of Glogau and subsequently as governor of Silesia and margrave of Lusatia under his elder brother Wladislaus of Bohemia and Hungary. Silesia, already more than half Germanized, had for generations been the battle-ground between the Luxemburgers and the Piasts, and was split up into innumerable principalities which warred incessantly upon their neighbours and each other.

Into the midst of this region of banditti Sigismund came as a sort of grand justiciar, a sworn enemy of every sort of disorder. His little principality of Glogau soon became famous as a model state, and as governor of Silesia he suppressed the robber knights with an iron hand, protected the law-abiding classes, and revived commerce. In Poland also his thrift and businesslike qualities speedily remedied the abuses caused by the wastefulness of his predecessor Alexander. His first step was to recover control of the mint, and place it in the hands of capable middle-class merchants and bankers, like Caspar Beer, Jan Thurzo, Jan Boner, the Betmans, exiles for conscience' sake from Alsace, who had sought refuge in Poland under Casimir IV., Justus Decyusz, subsequently the king's secretary and historian, and their fellows, all practical economists of high integrity who reformed the currency and opened out new ways for trade and commerce. The reorganization of the mint alone increased the royal revenue by 210,000 gulden a year and enabled Sigismund to pay the expenses of his earlier wars. In foreign affairs Sigismund was largely guided by the Laskis (Adam, Jan and Hieronymus), Jan Tarnowski and others, most of whom he selected himself. In his marriages also he was influenced by political considerations, though to both his consorts he was an affectionate husband. His first wife, whom the diet, anxious for the perpetuation of the dynasty, compelled him, already in his forty-fourth year (Feb. 1512), to marry, was Barbara Zapolya, whose family as represented first by her father Stephen and subsequently by her brother John, dominated Hungarian politics in the last quarter of the 15th and the first quarter of the 16th century. Barbara brought him a dowry of 100,000 gulden and the support of the Magyar magnates, but the match nearly brought about a breach with the emperor Maximilian, jealous already of the Jagiello influence in Hungary. On Barbara's death three years later without male offspring, Sigismund (in April 1518) gave his hand to Bona Sforza, a kinswoman of the emperor and granddaughter of the king of Aragon, who came to him with a dowry of 200,000 ducats and the promise of an inheritance from her mother of half a million more which she never got. Bona's grace and beauty speedily fascinated Sigismund, and contemporary satirists ridiculed him for playing the part of Jove to her Juno. She introduced Italian elegance and luxury into the austere court of Cracow and exercised no inconsiderable influence on affairs. But she used her great financial and economical talents almost entirely for her own benefit. She enriched herself at the expense of the state, corrupted society, degraded the clergy, and in her later years was universally detested for her mischievous meddling; inexhaustible greed, and unnatural treatment of her children.

The first twenty years of Sigismund's reign were marked by exceptional vigour. His principal difficulties were due to the aggressiveness of Muscovy and the disloyalty of Prussia. With the tsars Vasily III. and Ivan IV. Sigismund was never absolutely at peace. The interminable war was interrupted, indeed, by brief truces whenever Polish valour proved superior to Muscovite persistence, as for instance after the great victory of Orsza (Sept. 1514) and again in 1522 when Moscow was threatened by the Tatars. But the Tatars themselves were a standing menace to the republic. In the open field, indeed, they were generally defeated (e.g. at Wisniowiec in 1512 and at Kaniow in 1526), yet occasionally, as at Sokal when they wiped out a whole Polish army, they prevailed even in pitched battles. Generally, however, they confined themselves to raiding on a grand scale and, encouraged by the Porte or the Muscovite, systematically devastated whole provinces, penetrating even into the heart of Poland proper and disappearing with immense booty. It was this growing sense of border insecurity which led to the establishment of the Cossacks (see *POLAND: History*).

The grand-masters of the Teutonic Order, always sure of support in Germany, were also a constant source of annoyance. Their constant aim was to shake off Polish suzerainty, and in 1520-21 their menacing attitude compelled Sigismund to take up arms against them. The long quarrel was finally adjusted in 1525 when the last grand-master, after a fruitless pilgrimage through Europe for support, professed Lutheranism and as first

duke of Prussia did public homage to the Polish king in the market-place of Cracow. The secularization of Prussia was opposed by the more religious of Sigismund's counsellors, and the king certainly exposed himself to considerable odium in the Catholic world; but taking all the circumstances into consideration, it was perhaps the shortest way out of a situation bristling with difficulties.

Personally a devout Catholic and opposed in principle to the spread of sectarianism in Poland, Sigismund was nevertheless too wise and just to permit the persecution of non-Catholics; and in Lithuania, where a fanatical Catholic minority of magnates dominated the senate, he resolutely upheld the rights of his Orthodox subjects. Thus he rewarded the Orthodox upstart, Prince Constantine Ortoegski, for his victory at Orsza by making him palatine of Troki, despite determined opposition from the Catholics; severely punished all disturbers of the worship of the Greek schismatics; protected the Jews in the country places, and insisted that the municipalities of the towns should be composed of an equal number of Catholics and Orthodox Greeks. By his tact, equity, and Christian charity, Sigismund endeared himself even to those who differed most from him, as witness the readiness of the Lithuanians to elect his infant son grand-duke of Lithuania in 1522, and to crown him in 1529.

After his sixtieth year there was a visible decline in the energy and capacity of Sigismund. To the outward eye his gigantic strength and herculean build lent him the appearance of health and vigour, but forty years of unintermittent toil and anxiety had told upon him, and during the last two-and-twenty years of his reign, by which time all his old self-chosen counsellors had died off, he apathetically resigned himself to the course of events without making any sustained effort to stem the rising tide of Protestantism and democracy. He had no sympathy with the new men and the new ideas, and the malcontents in Poland often insulted the aged king with impunity. Thus, at his last diet, held at Piotrkow in 1547, Lupa Podlodowski, the champion of the *szlachta*, openly threatened him with rebellion. Sigismund died on the 1st of April 1548. By Bona he had five children—one son, Sigismund Augustus, who succeeded him, and four daughters, Isabella, who married John Zapolya, prince of Transylvania, Sophia, who married the duke of Brunswick, Catherine, who as the wife of John III. of Sweden became the mother of the Polish Vasas, and Ann, who subsequently wedded King Stephen Báthory.

See August Sokolowski, *History of Poland* (Pol.), vol. ii. (Vienna, 1904); Zygmunt Celichowski, *Materials for the history of the reign of Sigismund the Old* (Pol.) (Posen, 1900); Adolf Pawinski, *The youthful years of Sigismund the Old* (Pol.) (Warsaw, 1893); Adam Darowski, *Bona Sforza* (1904). (R. N. B.)

SIGISMUND II. (1520–1572), king of Poland, the only son of Sigismund I., king of Poland, whom he succeeded in 1548, and Bona Sforza. At the very beginning of his reign he came into collision with the turbulent *szlachta* or gentry, who had already begun to oust the great families from power. The ostensible cause of their animosity to the king was his second marriage, secretly contracted before his accession, with the beautiful Lithuanian Calvinist, Barbara Radziwill, daughter of the famous Black Radziwill. But the Austrian court and Sigismund's own mother, Queen Bona, seem to have been behind the movement, and so violent was the agitation at Sigismund's first diet (31st of October 1548) that the deputies threatened to renounce their allegiance unless the king instantly repudiated Barbara. This he refused to do, and his moral courage united with no small political dexterity enabled him to win the day. By 1550, when he summoned his second diet, a reaction in his favour began, and the lingering petulance of the gentry was sternly rebuked by Kmita, the marshal of the diet, who openly accused them of attempting to diminish unduly the legislative prerogative of the crown. The death of Barbara, five days after her coronation (7th of December 1550), under very distressing circumstances which led to an unproven suspicion that she had been poisoned by Queen Bona, compelled Sigismund to contract a third purely political union with the Austrian archduchess Catherine, the sister of Sigismund's first wife Elizabeth, who had died within a

twelvemonth of her marriage with him, while he was still only crown prince. The third bride was sickly and unsympathetic, and from her Sigismund soon lost all hope of progeny, to his despair, for being the last male of the Jagiellos in the direct line, the dynasty was threatened with extinction. He sought to remedy the evil by *liaisons* with two of the most beautiful of his countrywomen, Barbara Gizanka and Anna Zajanczkowska, the diet undertaking to legitimize and acknowledge as his successor any heir male who might be born to him; but their complacency was in vain, for the king died childless. This matter of the king's marriage was of great political importance, the Protestants and the Catholics being equally interested in the issue. Had he not been so good a Catholic Sigismund might well have imitated the example of Henry VIII. by pleading that his detested third wife was the sister of his first and consequently the union was uncanonical. The Polish Protestants hoped that he would take this course and thus bring about a breach with Rome at the very crisis of the confessional struggle in Poland, while the Habsburgs, who coveted the Polish throne, raised every obstacle to the childless king's remarriage. Not till Queen Catherine's death on the 28th of February 1572 were Sigismund's hands free, but he followed her to the grave less than six months afterwards. Sigismund's reign was a period of internal turmoil and external expansion. He saw the invasion of Poland by the Reformation, and the democratic upheaval which placed all political power in the hands of the *szlachta*; he saw the collapse of the ancient order of the Knights of the Sword in the north (which led to the acquisition of Livonia by the republic) and the consolidation of the Turkish power in the south. Throughout this perilous transitional period Sigismund's was the hand which successfully steered the ship of state amidst all the whirlpools that constantly threatened to engulf it. A far less imposing figure than his father, the elegant and refined Sigismund II. was nevertheless an even greater statesman than the stern and majestic Sigismund I. Tenacity and patience, the characteristics of all the Jagiellos, he possessed in a high degree, and he added to them a supple dexterity and a diplomatic finesse which he may have inherited from his Italian mother. Certainly no other Polish king so thoroughly understood the nature of the ingredients of that witch's caldron, the Polish diet, as he did. Both the Austrian ambassadors and the papal legates testify to the care with which he controlled "this nation so difficult to lead." Everything went as he wished, they said, because he seemed to know everything beforehand. He managed to get more money than his father could ever get, and at one of his diets won the hearts of the whole assembly by unexpectedly appearing before them in the simple grey coat of a Masovian squire. Like his father, a pro-Austrian by conviction, he contrived even in this respect to carry the Polish nation, always so distrustful of the Germans, entirely along with him, thereby avoiding all serious complications with the ever dangerous Turk. Only a statesman of genius could have mediated for twenty years, as he did, between the church and the schismatics without alienating the sympathies of either. But the most striking memorial of his greatness was the union of Lublin, which finally made of Poland and Lithuania one body politic, and put an end to the jealousies and discords of centuries (see POLAND, *History*). The merit of this crowning achievement belongs to Sigismund alone; but for him it would have been impossible. Sigismund II. died at his beloved Knyshyne on the 6th of July 1572, in his fifty-second year.

See Ludwik Finkel, *Characteristics of Sigismund Augustus* (Pol.) (Lemberg, 1888); *Letters to Nicholas Radziwill* (Pol.) (Wilna, 1842); *Geheime Briefe an Hozjus, Gesandten am Hofe des Kaisers Karl V.* (Wadowice, 1850); Adam Darowski, *Bona Sforza* (Pol.) (Rome, 1904). (R. N. B.)

SIGISMUND III. (1566–1632), king of Poland and Sweden, son of John III., king of Sweden, and Catherine Jagiellonika, sister of Sigismund II., king of Poland, thus uniting in his person the royal lines of Vasa and Jagiello. Educated as a Catholic by his mother, he was on the death of Stephen Báthory elected king of Poland (August 19, 1587) chiefly through the efforts of the Polish chancellor, Jan Zamoyski, and of his own aunt, Anne, queen-dowager of Poland, who lent the chancellor 100,000 gulden

to raise troops in defence of her nephew's cause. On his election, Sigismund promised to maintain a fleet in the Baltic, to fortify the eastern frontier against the Tatars, and not to visit Sweden without the consent of the Polish diet. Sixteen days later were signed the articles of Kalmar regulating the future relations between Poland and Sweden, when in process of time Sigismund should succeed his father as king of Sweden. The two kingdoms were to be perpetually allied, but each of them was to retain its own laws and customs. Sweden was also to enjoy her religion subject to such changes as a general council might make. During Sigismund's absence from Sweden that realm was to be ruled by seven Swedes, six to be elected by the king and one by Duke Charles, his Protestant uncle. Sweden, moreover, was not to be administered from Poland. A week after subscribing these articles the young prince departed to take possession of the Polish throne. He was expressly commanded by his father to return to Sweden, if the Polish deputation awaiting him at Danzig should insist on the cession of Esthonia to Poland as a condition precedent to the act of homage. The Poles proved even more difficult to satisfy than was anticipated; but finally a compromise was come to whereby the territorial settlement was postponed till after the death of John III.; and Sigismund was duly crowned at Cracow on the 27th of December 1587.

Sigismund's position as king of Poland was extraordinarily difficult. As a foreigner he was from the first out of sympathy with the majority of his subjects. As a man of education and refinement, fond of music, the fine arts, and polite literature, he was unintelligible to the *szlachta*, who regarded all artists and poets as either mechanics or adventurers. His very virtues were strange and therefore offensive to them. His prudent reserve and imperturbable calmness were branded as stiffness and haughtiness. Even Zamoyski who had placed him on the throne complained that the king was possessed by a dumb devil. He lacked, moreover, the tact and bonhomie of the Jagiellos; but in fairness it should be added that the Jagiellos were natives of the soil, that they had practically made the monarchy, and that they could always play Lithuania off against Poland.

Sigismund's difficulties were also increased by his political views which he brought with him from Sweden cut and dried, and which were diametrically opposed to those of the omnipotent chancellor. Yet, impracticable as it may have been, Sigismund's system of foreign policy as compared with Zamoyski's was, at any rate, clear and definite. It aimed at a close alliance with the house of Austria, with the double object of drawing Sweden within its orbit and overawing the Porte by the conjunction of the two great Catholic powers of central Europe. A corollary to this system was the much needed reform of the Polish constitution, without which nothing beneficial was to be expected from any political combination. Thus Sigismund's views were those of a statesman who clearly recognizes present evils and would remedy them. But all his efforts foundered on the jealousy and suspicion of the magnates headed by the chancellor. The first three-and-twenty years of Sigismund's reign is the record of an almost constant struggle between Zamoyski and the king, in which the two opponents were so evenly matched that they did little more than counterpoise each other. At the diet of 1590 Zamoyski successfully thwarted all the efforts of the Austrian party; whereupon the king, taking advantage of sudden vacancies among the chief offices of state, brought into power the Radziwills and other great Lithuanian dignitaries, thereby for a time considerably curtailing the authority of the chancellor. In 1592 Sigismund married the Austrian archduchess Anne, and the same year a reconciliation was patched up between the king and the chancellor to enable the former to secure possession of his Swedish throne vacant by the death of his father John III. He arrived at Stockholm on the 30th of September 1593 and was crowned at Upsala on the 19th of February 1594, but only after he had consented to the maintenance of the "pure evangelical religion" in Sweden. On the 14th of July 1594 he departed for Poland leaving Duke Charles and the senate to rule Sweden during his absence. Four years later (July 1598) Sigismund was forced to fight for his native crown by the usurpation of his

uncle, aided by the Protestant party in Sweden. He landed at Kalmar with 5000 men, mostly Hungarian mercenaries; the fortress opened its gates to him at once and the capital and the country people welcomed him. The Catholic world watched his progress with the most sanguine expectations. Sigismund's success in Sweden was regarded as only the beginning of greater triumphs. But it was not to be. After fruitless negotiations with his uncle, Sigismund advanced with his army from Kalmar, but was defeated by the duke at Stångebro on the 25th of September. Three days later, by the compact of Linköping, Sigismund agreed to submit all the points in dispute between himself and his uncle to a *riksdag* at Stockholm; but immediately afterwards took ship for Danzig, after secretly protesting to the two papal prothonotaries who accompanied him that the Linköping agreement had been extorted from him, and was therefore invalid. Sigismund never saw Sweden again, but he persistently refused to abandon his claims or recognise the new Swedish government; and this unfortunate obstinacy was to involve Poland in a whole series of unprofitable wars with Sweden.

In 1602 Sigismund wedded Constantia, the sister of his deceased first wife, an event which strengthened the hands of the Austrian party at court and still further depressed the chancellor. At the diet of 1605 Sigismund and his partisans endeavoured so far to reform the Polish constitution as to substitute a decision by a plurality of votes for unanimity in the diet. This most simple and salutary reform was, however, rendered nugatory by the opposition of Zamoyski, and his death the same year made matters still worse, as it left the opposition in the hands of men violent and incapable, like Nicholas Zebrzydowski, or sheer scoundrels, like Stanislaw Stadnicki. From 1606 indeed to 1610 Poland was in an anarchical condition. Insurrection and rebellion triumphed everywhere, and all that Sigismund could do was to minimize the mischief as much as possible by his moderation and courage. On foreign affairs these disorders had the most disastrous effect. The simultaneous collapse of Muscovy had given Poland an unexampled opportunity of rendering the tsardom for ever harmless. But the necessary supplies were never forthcoming and the diet remained absolutely indifferent to the triumphs of Zolkiewski and the other great generals who performed Brobdingnagian feats with Lilliputian armies. At the outbreak of the Thirty Years' War Sigismund prudently leagued with the emperor to counterpoise the united efforts of the Turks and the Protestants. This policy was very beneficial to the Catholic cause, as it diverted the Turk from central to north-eastern Europe; yet, but for the self-sacrificing heroism of Zolkiewski at Cecora and of Chodkiewicz at Khotin, it might have been most ruinous to Poland. Sigismund died very suddenly in his 66th year, leaving two sons, Wladislaus and John Casimir, who succeeded him in rotation.

See Aleksander Rembowski, *The Insurrection of Zebrzydowski* (Pol.) (Cracow, 1893); Stanislaw Niemcewicz, *Memoires* (Pol.) (Lemberg, 1899); *Sveriges Historia*, vol. iii. (Stockholm, 1881); Julian Ursyn Niemcewicz, *History of the Reign of Sigismund III.* (Pol.) (Breslau, 1836). (R. N. B.)

SIGMARINGEN, a town of Germany, chief town of the Prussian principality of Hohenzollern, on the right bank of the Danube, 55 m. S. of Tübingen, on the railway to Ulm. Pop. (1905) 4621. The castle of the Hohenzollerns crowns a high rock above the river, and contains a collection of pictures, an exceptionally interesting museum (textiles, enamels, metal-work, &c.), an armoury and a library. On the opposite bank of the Danube there is a war monument to the Hohenzollern men who fell in 1866 and 1870-1871.

The division of Sigmaringen is composed of the two formerly sovereign principalities of Hohenzollern-Sigmaringen and Hohenzollern-Hechingen (see HOHENZOLLERN), and has an area of 440 sq. m. and a population (1905) of 68,282. The Sigmaringen part of the Hohenzollern lands was the larger of the two (297 sq. m.) and lay mainly to the south of Hechingen, though the district of Haigerloch on the Neckar also belonged to it. The name of Hohenzollern is used much more frequently than the official Sigmaringen to designate the combined principalities.

See Woelf, *Führer durch Sigmaringen* (Würzburg, 1886).

SIGNAL (a word common in slightly different forms to nearly all European languages, derived from Lat. *signum*, a mark, sign), a means of transmitting information, according to some pre-arranged system or code, in cases where a direct verbal or written statement is unnecessary, undesirable, or impracticable. The methods employed vary with the circumstances and the purposes in view, and the medium into which the transmitted idea is translated may consist of visible objects, sounds, motions, or indeed anything that is capable of affecting the senses, so long as an understanding has been previously effected with the recipient as to the meaning involved. Any two persons may thus arrange a system for the transmission of intelligence between them, and secret codes of this kind, depending on the inflections of the voice, the accent on syllables or words, the arrangement of sentences, &c., have been so elaborated as to serve for the production of phenomena such as are sometimes attributed to telepathy or thought transference. With the many private developments of such codes we are not here concerned, nor is it necessary to attempt an explanation of the systems of drum-taps, smoke-fires, &c., by which certain primitive peoples are supposed to be able to convey news over long distances with astonishing rapidity; the present article is confined to giving an account of the organized methods of signalling employed at sea, in military operations and on railways, these being matters of practical public importance.

Marine Signalling.—A system of marine signals comprises different methods of conveying orders or information to or from a ship in sight and within hearing, but at a distance too great to permit of hailing—in other words, beyond the reach of the voice, even when aided by the speaking-trumpet. The necessity of some plan of rapidly conveying orders or intelligence to a distance was early recognized. Polybius describes two methods, one proposed by Aeneas Tacticus more than three centuries before Christ, and one perfected by himself, which, as any word could be spelled by it, anticipated the underlying principle of later systems. The signal codes of the ancients are believed to have been elaborate. Generally some kind of flag was used. Shields were also displayed in a preconcerted manner, as at the battle of Marathon, and some have imagined that the reflected rays of the sun were flashed from them as with the modern heliograph. In the middle ages flags, banners and lanterns were used to distinguish particular squadrons, and as marks of rank, as they are at present, also to call officers to the admiral, and to report sighting the enemy and getting into danger. The invention of cannon made an important addition to the means of signalling. In the instructions issued by Don Martin de Padilla in 1597 the use of guns, lights and fires is mentioned. The introduction of the square rig permitted a further addition, that of letting fall a sail a certain number of times. Before the middle of the 17th century only a few stated orders and reports could be made known by signalling. Flags were used by day, and lights, occasionally with guns, at night. The signification then, and for a long time after, depended upon the position in which the light or flag was displayed. Orders, indeed, were as often as possible communicated by hailing or even by means of boats. As the size of ships increased the inconvenience of both plans became intolerable. Some attribute the first attempt at a regular code to Admiral Sir William Penn (1621–1670), but the credit of it is usually given to James II. when duke of York. Notwithstanding the attention paid to the subject by Paul Hoste and others, signals continued strangely imperfect till late in the 18th century. Towards 1780 Admiral Kempenfelt devised a plan of flag-signalling which was the parent of that now in use. Instead of indicating differences of meaning by varying the position of a solitary flag, he combined distinct flags in pairs. About the beginning of the 19th century Sir Home Popham improved a method of conveying messages by flags proposed by R. Hall Gower (1767–1833), and greatly increased a ship's power of communicating with others. The number of night and fog signals that could be shown was still very restricted. In 1867 an innovation of prodigious importance was made by the adoption in the British navy of Vice-Admiral (then Captain) Philip

Colomb's flashing system, on which he had been at work since 1858.

In the British navy, which serves as a model to most others, visual signals are made with flags or pendants, the semaphore, flashing, and occasionally fireworks. Sound signals are made with fog-horns, steam-whistles, sirens and guns. The number of flags in use in the naval code, comprising what is termed a "set," are 58, and consist of 26 alphabetical flags, 10 numeral flags, 16 pendants and 6 special flags. Flag signals are divided into three classes, to each of which is allotted a separate book. One class consists of two alphabetical flags, and refers to orders usual in the administration of a squadron, such as, for example, the flags LE, which might signify "Captain repair on board flagship." Another class consists of three alphabetical flags, which refer to a coded dictionary, wherein are words and short sentences likely to be required. The remaining refers to evolutionary orders for manœuvring, which have alphabetical and numeral flags combined. The flags which constitute a signal are termed a "hoist." One or more hoists may be made at the same time. Although flag signalling is a slow method compared with others, a fair rate can be attained with practice. For example, a signal involving 162 separate hoists has been repeated at sight by 13 ships in company in 76 minutes. Semaphore signals are made by the extension of a man's arms through a vertical plane, the different symbols being distinguished by the relative positions of the arms, which are never less than 45° apart. To render the signals more conspicuous the signaller usually holds a small flag on a stick in each hand, but all ships are fitted with mechanical semaphores, which can be worked by one man, and are visible several miles. Flag signalling being comparatively slow and laborious, the ordinary message work in a squadron is generally signalled by semaphore. The convenience of this method is enormous, and by way of example it may be of interest to mention a record message of 350 words which was signalled to 21 ships simultaneously at the rate of 17 words per minute. Flags being limited in size, and only distinguishable by their colour, signals by this means are not altogether satisfactory at long distances, even when the wind is suitable. For signalling at long range the British navy employs a semaphore with arms from 9 to 12 ft. long mounted at the top of the mast and capable of being trained in any required direction, and worked from the deck. Its range depends upon the clearness of the atmosphere, but instances are on record where a message by this means has been read at 16 to 18 m.

Night signalling is carried out by means of "flashing," by which is meant the exposure and eclipse of a single light for short and long periods of time, representing the dots and dashes composing the required symbol. The dots and dashes can be made mechanically by an obscuring arrangement, or by electro-mechanical means where magnets do the work, or by simply switching on and off specially manufactured electric lamps. The ordinary rate of signalling by flashing is from 7 to 10 words per minute. In the British navy, as in the army, dots and dashes are short and long exposures of light; but with some nations the dots and dashes are short and long periods of darkness, the light punctuating the spaces between them. The British navy uses the European modification of the so-called Morse code used in telegraphy, but with special signs added suitable to their code. The introduction of the "dot and dash" system into the British navy was entirely due to the perseverance of Vice-Admiral Colomb, who, in spite of great opposition, and even after it had once been condemned on its first trial at sea, carried it through with the greatest success. The value of this innovation made in 1867 may be gauged by the fact that now it is possible to handle a fleet with ease and safety in darkness and fog—a state of affairs which did not formerly exist. The simplicity of the dot and dash principle is its best feature. As the system only requires the exhibition of two elements it may be used in a variety of different manners with a minimum of material, namely, by waving the most conspicuous object at hand through short and long arcs, by exhibiting two different shapes, each representing one of the elements, or dipping a lantern in a bucket, and so on. Its

adoption has not only contributed very materially to the increased efficiency of the British navy, but it has been made optional for use with the mercantile marine. Curiously enough, flashing is not to any great extent used in the navies of other countries which rely more on some system of coloured lights at night. This system generally takes the form of four or five double-coloured lanterns, which are suspended from some part of the mast in a vertical line. Each lantern generally contains a red and a white lamp, either of which can be switched on. By a suitable keyboard on deck any combination of these coloured lanterns can be shown. The advantage of this system lies in the fact that each symbol is self-evident in its entirety, and does not require an expert signalman to read it, as is the case with flashing, which is a progressive performance.

For long distances at night the search-light, or some other high power electric arc light, is utilized on the flashing system. Dots and dashes are then made either by flashing the light directly on the object, or by waving the beam up and down for short and long periods of time. Sometimes when a convenient cloud is available the reflection of the beam has been read for nearly 40 m., with land intervening between the two ships. In a fog signals are made by the steam-whistle, fog-horn, siren or by guns. Except for the latter method the dot and dash system is employed in a similar manner to flashing a light. Guns are sometimes used in a fog for signalling, the signification being determined by certain timed intervals between the discharges. The larger British ships are supplied with telegraph instruments for connexion with the shore, and heliographs are provided for land operations. Marine galvanometers are also provided, and can be used to communicate through submarine cables. To the various methods of naval signalling must be added wireless telegraphy, which in its application to ships at sea bids fair to solve some problems hitherto impracticable. (See TELEGRAPHY: *Wireless*.)

The international code of signals, for use between ships of all nations, is perhaps the best universal dictionary in existence. By its means mariners can talk with great ease without knowing a word of one another's language. By means of a few flags any question can be asked and answered. The number of international flags and pendants used with the international code is 27, consisting of a complete alphabet and a special pendant characteristic of the code. At night flashing may be used. (C. A. G. B.; A. F. E.)

Army Signalling.—Communication by visual signals between portions of an army is a comparatively recent development of military service. Actual signals were of course made in all ages of warfare, either specially agreed upon beforehand, such as a rocket or beacon, or of more general application, such as the old-fashioned wooden telegraph and the combinations of lights, &c., used by savages on the N.W. frontier of India. But it was not until the middle years of the 19th century that military signalling proper, as a special duty of soldiers, became at all general. It was about the year 1865 that, owing to the initiative of Captain Philip Colomb, R.N., whose signal system had been adopted for his own service, the question of army signalling was seriously taken up by the British military authorities. A school of signalling was created at Chatham, and some time later all units of the line were directed to furnish men to be trained as signallers. At first a code book was used and the signals represented code words, but it was found better to revert to the telegraphic system of signalling by the Morse alphabet, amongst the undeniable advantages of which was the fact that it was used both by the postal service and the telegraph units of Royal Engineers. Thenceforward, in ever-increasing perfection, the work of signallers has been a feature of almost every campaign of the British army. To the original flags have been added the heliograph (for long-distance work), the semaphore system of the Royal Navy (for very rapid signalling at short distances), and the lamps of various kinds for working by night. Full and detailed instructions for the proper performance of the work, which provide for almost every possible contingency, have been published and are enforced.

The apparatus employed for signalling in the British service consists of flags, large and small, heliograph and lamp for night work. The distances at which their signals can be read vary very considerably, the flags having but a limited scope of usefulness, whilst the range of a heliograph is very great indeed. Whether it be 10 m. or 100 away, it has been found in practice that, given good sunlight, nothing but the presence of an intervening physical obstacle, such as a ridge or wood, prevents communication. For shorter distances moonlight, and even artificial light, have on occasion been employed as the source of light. In northern Europe the use of the instrument is much restricted by climate, and, further, stretches of plain country, permitting of a line of vision between distant hills, are not often found. It is in the wilder parts of the earth, that is to say in colonial theatres of war, that the astonishing value of the heliograph is displayed. In European warfare flag signalling is more usually employed. The flags in use are blue and white, the former for use with light, the latter for dark backgrounds.

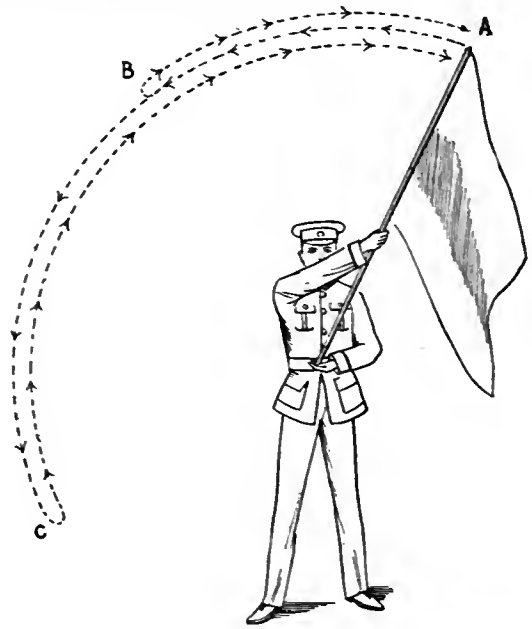

FIG. 1.

There is further a distinction between the "small" flag, which is employed for semaphore messages and for rapid Morse over somewhat shorter distances, and the "large" flag, which is readable at a distance of 5 to 7 m., as against the maximum of 4 m. allowed to the small flag. With a clear atmosphere these distances may be exceeded. The respective sizes of these flags are as follows:—large flag 3' x 3', pole 5' 6" long; small flag 2' x 2', pole 3' 6" long. The lamps used for night signalling are of many kinds. Officially only the "lime light" and the "Begbie" lamps are recognized, but a considerable number of the old-fashioned oil lamps is still in use, especially in the auxiliary forces, and many experiments have been made with acetylene. The lime light is obtained by raising a lime pencil to a white heat by forcing a jet of oxygen through the flame of a spirit lamp. The strong light thus produced can be read under favourable conditions at a distance of 15 m.; but the equipment of gas-bag, pressure-bag, and other accessories make the whole instrument rather cumbrous. The bull's-eye lamp differs but slightly from the ordinary lantern of civil life; it burns vegetable oil. The Begbie lamp, which burns kerosene, is rather more elaborate and gives a whiter light. It was in use for many years in India before the objections made by the authorities in England to certain features of the lamp were withdrawn. All these lamps when in use are set up on a tripod stand and signals in the Morse alphabet are made by opening and closing a shutter in front of the light, and thereby showing long and short flashes.

The same principle is followed in the heliograph. This instrument, invented by Sir Henry C. Mance, receives on a mirror, and thence casts upon the distant station, the rays of the sun; and the working of a small key controls the flashes by throwing the mirror slightly off its alignment and thus obscuring the light from the party reading signals. The fact that the heliograph requires sunlight, as mentioned above, militates against its employment in Great Britain, but where it is possible to use it it is by far the best means of signalling. Secrecy and rapidity are its chief advantages. An observer 6 m. distant would see none of its light if he were more than 50 yds. on one side of the exact alignment, whereas a flag signal could be read from almost every

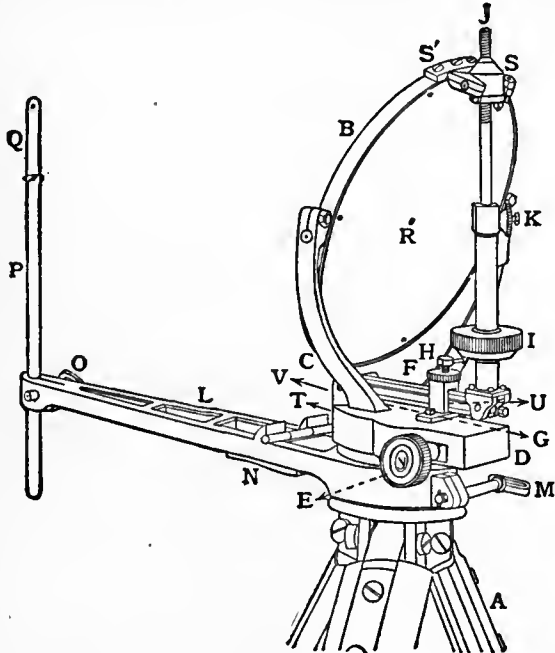

FIG. 2.—Heliograph (by permission of the Controller of H.M. Stationery Office).

hill within range. None of the physical exertion required for fast signalling with the flag is required to manipulate the instrument at a high rate of speed. The whole apparatus is packed in a light and portable form. An alternative method of using the heliograph is to keep the rays permanently on the distant point, a shutter of some kind being used in front of it to produce obscurations.

When in use the heliograph is fixed upon a tripod. A tangent screw (E) which moves the whole instrument (except the jointed arm L) turns the mirror in any direction. Metal U-shaped arms (C) carry the mirror (B), which is controlled by the vertical rod (J) and its clamping screw (K). The signalling mirror itself (usually having a surface of 5 in. diameter) is of glass, an unsilvered spot (R) being left in the centre. This spot retains its position through all movements in any plane. The instrument is aligned by means of the sighting vane (P) fixed in the jointed arm L, and the rays of the sun are then brought on to the distant station by turning the horizontal and vertical adjustments until the "shadow spot" cast by the unsilvered centre of the mirror appears on the vane. The heliograph is thus ready, and signals are made by the depression and release of the "collar" (I) which, with the pivoted arm (U, V), acts as a telegraph key. When the sun makes an angle of more than 120 degrees with the mirror and the distant station, a "duplex mirror" is used in place of the sighting vane. The process of alignment is in this case a little more complicated. Various other means of making dots and dashes are referred to in the official work, ranging from the "collapsible drum" hung on a mast to the rough but effective improvisation of a heliograph out of a shaving-glass. The employment of the beams of the search-light to make flashes on clouds is also a method of signalling which has been in practice very effective.

The Morse code employed in army signalling is as follows:—

A . —	J . — — —	S . . .	2 . . .
B — . . .	K — . —	T — .	3 — — —
C — . — .	L	U — —	4
D — . .	M — — —	V	5 .
E .	N — .	W — — —	6 —
F — . — .	O — — —	X — . — —	7 —
G — — . — .	P — . — .	Y — — — .	8 — . . .
H	Q — . — —	Z —	9 . . .
I . .	R — . .	1 — .	0 —

The semaphore code used in the army is shown below:—

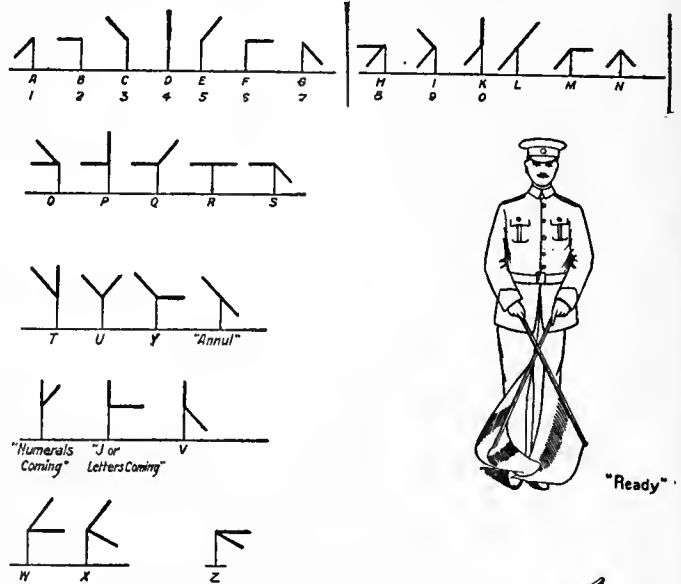

Fig. 3.—Semaphore (the thin upright strokes represent the seaman's body, the thick strokes his arms).



In using this code the signaller invariably faces his reader, as unless this were enforced each letter might be read as its opposite. In the above diagram the appearance of the signals to the reader is shown, thus the sender's right side only is used for the letter A.

In sending a message accuracy is ensured by various checks. The number of words in a message is the most valuable of these, as the receiving station's number must agree before the message is taken as correct. Each word or "group" sent by the Morse code must be "answered" before the sender passes on to another. All figures are checked by the "clock check" in which 1 is represented by A, 2 by B and so on. All cipher "groups" are repeated back *en bloc*. There is an elaborate system of signals relating to the working of the line. The "message form" in use differs but slightly from the ordinary form of the Post Office telegraphs. Signal stations in the field are classed as (a) "fixed" and "moving," the former connecting points of importance, or on a line of communications, the latter moving with the troops; (b) "terminal," "transmitting" and "central"; the first two require no definition, the last is intended to send and receive messages in many directions. The "transmitting station" receives and sends on messages, and consists in theory of two full "terminals," one to receive and one to send on. It is rarely possible in the field to work rapidly with less than five men at a transmitting and three at a terminal station. "Central" stations

are manned according to the number of stations with which they communicate.

Signalling is used on most campaigns to a large extent. In the Tirah expedition, 1897 and 1898, one signal station received and sent, between the 1st and 18th November, as many as 980 messages by heliograph, some of which were 200 to 300 words in length. It is often used as an auxiliary to the field telegraph, especially in mountainous countries, and when the wire is liable to be cut and stolen by hostile natives. In the Waziri expedition, 1881, communication was maintained direct for a distance of 70 m. with a 5-in. heliograph. In the Boer War, 1899-1902, the system of heliographic signalling was employed very extensively by both sides.

In Germany the first army signalling regulations only appeared in 1902. The practice was, however, rapidly developed and towards the end of the 1905 campaign in South-West Africa, 9 signalling officers and 200 signallers were employed in that country. These usually worked in parties of 2 or 3, each party being protected by a few infantrymen or troopers. The apparatus used was heliograph by day and a very elaborate form of lamp by night, and work was carried on between posts separated by 60 and even 90 m. The signallers were employed both with the mobile forces and in a permanent network of communication in the occupied territory. In 1907-1908 fresh signalling regulations were issued to the home army, and each company, battery or squadron is now expected to find one station of three men, apart from the regimental and special instructors and staff. Some experiments were carried out at Metz to ascertain the mean distance at which signals made by a man lying down could be seen, this being found to be about 1000 yds. The new regulations allow of the use of flag and lamp signalling at 4 m. instead of as formerly at 1½. Three flags are used, blue, white and yellow, and it is stated that the last is the most frequently useful of the three.

The enormous development of the field telegraph and telephone systems in the elaborate war of positions of 1904-1905 more or less crowded out, so to speak, visual signalling on both sides, and in any case the average illiterate Russian infantryman or the Cossack was not adaptable to signalling needs. Only about one-quarter of the signalling force (which consisted exclusively of engineer troops) in Kuropatkin's army was employed in optical work, the other three-quarters being assigned to telegraph, wireless and telephone station work. The Italians, who are no strangers to colonial warfare, have a well-developed visual signalling system.

See British Official *Training Manuals: Signalling* (1907).

Railway Signalling.—In railway phraseology the term "signal" is applied to a variety of hand motions and indications by lamps and other symbols, as well as to fixed signals; but only the last-named class—disks and semaphores, with lights, permanently fixed (on posts) at the side of the track—will be considered here. These may be divided into (1) interlocking signals, used at junctions and yards, and (2) block signals, for maintaining an interval of space between trains following one another. In both classes the function of a signal is to inform the engine-driver whether or not he may proceed beyond the signal, or on what conditions he may proceed, and it is essential to give him the information some seconds before it need be acted upon.

The semaphore signal, which is now widely used, consists of an arm or blade about 5 ft. long extending horizontally, at right angles to the line of the track, from the top of a post (wood or iron) 15 to 30 ft. high, and sometimes higher (fig. 4). This arm, turning on a spindle, is pulled down ("off") to indicate that a train may pass it, the horizontal (or "on") position indicating "stop"; sometimes, as on the continent of Europe, use is made of the position of the arm in which it points diagonally upwards, and on one or two English lines the arm in the safety position hangs down perpendicularly, parallel to, but a few inches away from, the post. A lamp is fixed to the side of the post about on a level with the blade, and by the movement of the blade is made to show at night red for "stop" and green for go-ahead or "all clear." The earlier practice, white for "all clear," still prevails largely in America.

In the early days of railway signalling three positions of the semaphore arm were recognized:—(1) Horizontal, or at right angles to the post, denoting danger; (2) at a downward angle of 45 degrees, denoting caution; (3) hanging vertically downwards or parallel to the post, denoting all right. Corresponding to the position of the arm, three different lights were employed at night—red for danger, green for caution and white for all right. But now British railways make use of only two positions of the arm and two lights—the arm at right angles to the post and a red light, both signifying danger or

stop; and the arm at about 60 degrees (or vertical, as mentioned above) and a green light, both meaning all right or proceed. It is better to abolish the use of white lights for signalling purposes. The reason is obvious. There are many lights and lamps on the platforms, in signal-boxes and in the streets and houses adjacent to a railway; and if white lights were recognized as signals, a driver might mistake a light of this nature as a signal to proceed; in fact, accidents have been caused in this manner. A white light is not to be regarded as a danger signal, as is sometimes erroneously stated, but rather as no signal at all; and as there is a well-known rule to the effect that "the absence of a signal at a place where a signal is ordinarily shown must be treated as a danger signal," it follows that a white light, when seen at a place where a red or green light ought to be visible, is to be treated as a danger signal, not because a white light *per se* means danger, but because in such a case it denotes the absence of the proper signal. Some companies have adopted a purple or small white light as a "danger" signal for shunting purposes in sidings and yards; but this practice is not to be commended, since red should be the universal danger signal.

Distant signals are used to make it unnecessary for an engine-driver to slacken his speed in case the stop (*home*) signal is obscured by fog or smoke, or is beyond a curve, or for any reason is not visible sufficiently far away. Encountering the distant signal at a point 400 to 800 yds. before reaching the home signal, he is informed by its position that he may expect to find the latter in the same position; if it is "off" he passes it, knowing that the home signal must be in the same position, but if it is at danger he proceeds cautiously, prepared to stop at the home signal, if necessary. The arm of a distant signal usually has a fish-tail end. In Great Britain its colour indications are generally the same as for the home signal, but occasionally it shows yellow, and on some lines it is distinguished at night by an angular band of light, shaped like a fish-tail, which appears by the side of the red or green light. In America its night colour-indication is made different from that of the home signal. Thus, where white is used to indicate all clear (in both home and distant) the distant arm, when horizontal, shows a green light; where green is the all-clear colour a horizontal distant shows either a yellow light or (on one road) a red and a green light side by side. Two lights for a single arm, giving their indication by position as well as colour, have been used to a limited extent for both home and distant signals. *Dwarf signals* (*a* in fig. 5) are used for very slow movements, such as those to or from a siding. Their blades are about 1 ft. long, and the posts about 4 ft. high; the lower arm on post *c* being for slow movements, is also frequently made shorter than the upper one. Where more than two full-sized arms are used on a post, the custom in America is to have the upper arm indicate for the track of the extreme right, and the others in the order in which the tracks lie; in Great Britain the opposite rule prevails, the upper arm indicating for the extreme left. But the signals controlling a large number of parallel or diverging tracks are preferably arranged side by side, often on a narrow overhead bridge or gantry spanning the tracks.

All the switches and locks are connected with the signal cabin by iron rods (channel-iron or gas-pipe) supported (usually near the ground and often covered by boxing) on small grooved wheels set at suitable distances apart. The foundations of these supports are of wood, cast iron or concrete. Concrete foundations are comparatively recent, but are cheap and durable. For signals (but not for points) wire connexions are universal in England, and are usual in America, being cheaper than rods. In changing the direction of a line of rodding a bell-crank is used, but with a wire a piece of chain is inserted and run round a grooved pulley. Wire connexions are shown at *a* and *b*, fig. 4, the main or "front" wire being attached at *a*. By this the signalman moves the arm down to the inclined or go-ahead position, to do which he has to lift the counter-

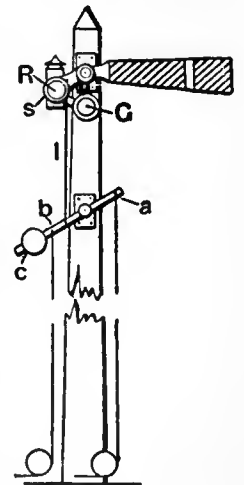

FIG. 4.—Semaphore signal. R, Red glass; G, green glass.

weight *c*. If the wire should break, the counter-weight would restore the arm to the horizontal (stop) position, and thus prevent the unauthorized passage of a train; and in case of failure of the rod *I*, the iron spectacle *s* would act as a safety counter-weight. The back-wire *b* is added to ensure quick movement of the arm, but is not common in England. Long lines of rigid connexions are "compensated" for expansion and contraction due to changes in temperature by the introduction of bell-cranks or rocker-arms. With wire connexions compensation is difficult, and many plans have been tried. The most satisfactory devices are those in which the connexion, in the cabin, between the wire and the lever is broken when the signal is in the horizontal position. The wire is kept taut by a weight or spring, and at each new movement the lever (if the wire has lengthened or shortened) grips it at a new place.

So early as 1846 it became a common practice in England to concentrate the levers for working the points and signals of a station in one or more cabins, and the necessity of interlocking soon became evident to prevent simultaneous signals being given over conflicting routes, or for a route not yet prepared to receive the train. In large terminals concentration and interlocking are essential to rapid movements of trains and economical use of ground.

Fig. 5 shows a typical arrangement of interlocked signals, the principle being the same whether a yard has one set of points or

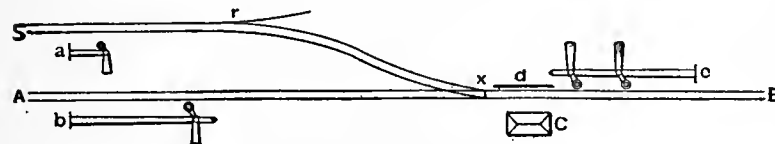

FIG. 5.—Interlocked signals (American practice, signals at right track, and arms at right of post).

a hundred. The signals (at *a*, *b*, and *c*) are of the semaphore pattern. For the four signals and one pair of points there are, in the second storey of the cabin *C*, five levers. Each signal arm stands normally in the horizontal position, indicating stop. To permit a train to pass from A to B the signalman moves the arm of signal *b* to an inclined position (60 degrees to 75 degrees downwards); and the interlocking of the levers prevents this movement unless it can safely be made. If *a* has been changed to permit a movement from S to B, or if the points *x* have been set for such a movement, or if either signal on post *c* has been lowered, the lever for *b* is immovable. In like manner, to incline the arm of signal *a* for a movement from S to B it is first necessary to have the points set for track S, and to have the levers of all the other signals in the normal (stop) position. A sixth lever, suitably interlocked, works a lock bar, which engages with the head rod of the points; it is connected to the lock through the "detector bar," *d*. This bar, lying alongside of and close to the rail, must move upwards when the points lock is being moved either to lock or to unlock; and being made of such a length that it is never entirely free of the wheels of any car or engine standing or moving over it, it is held down by the flanges, and the signalman is prevented from inadvertently changing the points when a train is passing. At *r* is a throw-off or derailing switch ("catch-points"). When *x* is set for the passage of trains on the main line, *r*, connected to the same lever, is open; so that if a car, left on the side track unattended, should be accidentally moved from its position, it could not run foul of the main track.

The function of the interlocking machine is to prevent the simultaneous display of conflicting signals, or the display of a signal over points that are not set accordingly. The most common forms of interlocking have the locking bars arranged in a horizontal plane; but for ease of description we may take one having them arranged vertically, the principle being the same. The diagram (fig. 6) shows a section with a side view of one lever.

arranged that either one of them will be moved by the same lever, the position of the point connexions being made to govern the selection of the arm to be moved. A switch rod would be connected to this lever at *H*; the lever *K* is for use where a signal is connected by two wires, as before described. The lever is held in each of its two positions by the catch rod *V*, which engages with notches in the segment *B*. When the signalman, preparatory to lowering a signal, grasps the lever at its upper end, he moves this rod upwards, and in so doing actuates the interlocking, through the tappet *N*, attached at *T*. Lifting the tappet locks all levers which need to be locked to make it safe to move this one. In pulling over the lever the rocker *R* is also pulled; but the slot in it is radial to the centre on which the lever turns, so that during the stroke *N* remains motionless. On the completion of

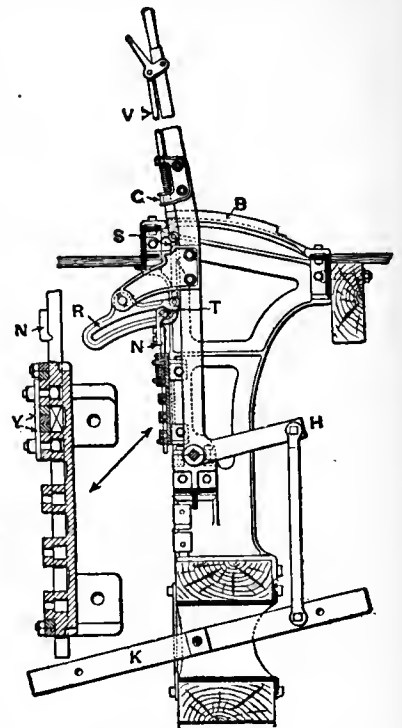

FIG. 6.—Signal Lever, with Mechanical Interlocking.

the stroke and the dropping of *V*, *N* is raised still farther, and this unlocks such levers as should be unlocked after this lever is pulled ("cleared" or "reversed"). It will be seen that whenever the tappet *N* of any lever is locked in the

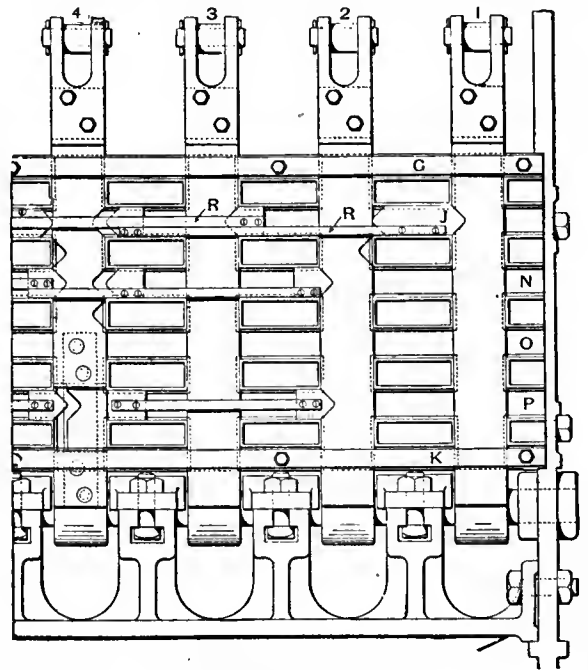

FIG. 7.—Interlocking Frame.

position shown in the figure, it is impossible to raise *V*, and therefore impossible to move the lever.

The action of tappet *N* may be understood by reference to fig. 7. A tappet, say 3, slides vertically in a planed recess in the locking plate, being held in place by strips *G* and *K*. Transverse

grooves N, O, P, carry dogs, such as J. Two dogs may be connected together by bars, R. The dogs are held in place by straps Y (fig. 6). Locking is effected by sliding the dogs horizontally; for example, dog J has been pushed into the notch in tappet 1, holding it in the normal position. If tappet 2 were raised, its notch would come opposite dog J; and then the lifting of 1 would lock 2 by pushing J to the left. By means of horizontal rod R, the lifting of 1 also locks 4. If 4 were already up, it would be impossible to lift 1.

Switch and signal machines are sometimes worked by compressed air, or electric or hydraulic power. The use of power makes it possible to move points at a greater distance from the cabin than is permissible with manual power. The most widely used apparatus is the electro-pneumatic, by which the points and signals are moved by compressed air at 70 lb per sq. in., a cylinder with piston being fixed at each signal or switch. From a compressor near the cabin, air is conveyed in iron pipes buried in the ground. The valves admitting air to a cylinder are controlled by electromagnets, the wires of which are laid from the cabin underground. Each switch or signal, on completing a movement, sends an electric impulse to the cabin, and the interlocking is controlled by this "return." In the machine the "levers" are very small and light, their essential function being to open and close electric circuits. This is performed through the medium of a long shaft placed horizontally with its end towards the operator, which is revolved on its axis through 60 degrees of a circle. This shaft actuates the interlocking, which is in principle the same as that already described; and it opens and closes the electric circuits, governing the admission of air to cylinders, by means of simple metal contact strips rubbing on sections of its surface. The high-pressure machine has been used with hydraulic power instead of pneumatic, and with electrical interlocking instead of mechanical.

Interlocking apparatus worked by compressed air at low pressure (15 lb per sq. in.), and with no electrical features, is in use on some lines in America and has been introduced into England. In place of an electromagnet for admitting compressed air to the cylinders, a rubber diaphragm 8 in. in diameter is used. This is lifted by air at 7 lb pressure, this pressure being conveyed from a cabin, distant 500 ft. or more, in one or two seconds. As in the electro-pneumatic machine, the lever of a switch cannot complete its stroke until the switch has actually moved home and conveyed a "return indication" to the cabin. Pneumatic apparatus of other designs is in use to a limited extent.

Pneumatic interlockings are costly to instal, and, depending on an unfailing source of power, have not been much used at isolated places, except on railways where an air-pipe is installed for block signals; but at large yards the pneumatic machines have been made a means of economy, because one attendant can manage as many levers as can two or three in a manual power machine. Moreover, a single lever will work two or more switches, locks, &c., simultaneously, where desirable. The absence of outdoor connexions above ground is also an advantage.

Since about 1900 electric power has come into use for working both points and signals. A motor, with gearing and cranks, is fixed to the sleepers at each pair of points, the power is conveyed from the cabin by underground wires, the locking is of common mechanical types, and, in general, the system is similar to pneumatic systems except in the source of power. By using accumulators, charged by dynamos run by gasoline engines, or by a travelling power-car, the cost of power is reduced to a very low figure, so that power-interlocking becomes economical at small as well as large stations.

The essence of block signalling is a simple regulation forbidding a train to start from station A until the last preceding train has passed station B; thus a space interval is maintained between each train, instead of the time-interval that was relied upon in the early days of railways. As the introduction of the telegraph was almost or quite contempor-

aneous with the advent of the railway, the possibility of a block system was early recognized; but its introduction was retarded by the great cost of employing attendants at every block station. But as traffic increased, the time-interval system proved inadequate; and in the United Kingdom the block system is now practically universal, while in America it is in use on many thousand miles of line. In "permissive blocking" a second train is allowed to enter a block section before the first has cleared it, the engine-man being required so to control his speed that if the first train be unexpectedly stopped he can himself stop before coming into collision with it. It thus violates the essential condition of true block signalling.

The manual "block" system in use at the present day in no way differs from that devised by W. F. Cooke in 1842, except so far as the details and designs of the telegraphic instruments are concerned. Cooke used a single-needle instrument giving two indications—the needle to the left signifying "line clear," to the right, "line blocked"; the instrument was also available for speaking purposes. The instruments employed in Great Britain consist of two dials—one for the up line and one for the down—and a bell. They may be divided into two main classes, those requiring one wire, and those requiring three wires for each double line of rails. The dials of the one-wire instruments give only two indications, namely, "line

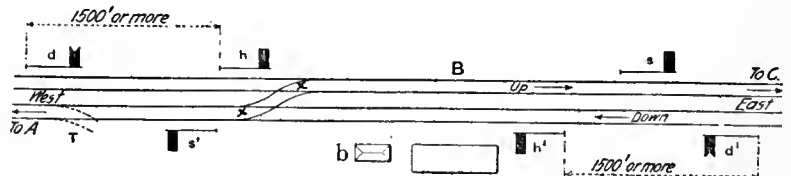

FIG. 8.—Block signals. (English practice, trains run on left-hand track, signals at left of track, arms on left of post.)

clear" and "train on line" or "line blocked," the latter being the normal indication, even when there is no train in the section. The three-wire instrument has the advantage of giving three indications on the dial, namely, "line clear," "line closed" and "train on line," the normal indication being "line closed." The one-wire instrument differs from the three-wire in that the indicator is moved over to the different positions by a momentary current, and is then held there by induced magnetism, the wire being then free for any succeeding signals. In the three-wire apparatus there is a separate wire, with an instrument at each end for the up line; the same for the down line; and a wire for the bell, which is common to both lines. When no current is flowing, the indicator is vertical, meaning "line blocked or closed." When a current is sent along one of the wires, the deflections to the right or left, according to the polarity of the current, mean "line clear" or "train on line" respectively. Some dial instruments are made with needles, some with small disks, some with miniature semaphores to give the necessary indications, but the effect is the same. The block instruments and bells should not, as a rule, be used for speaking purposes; but on a few subsidiary railways, block working is effected by means of ordinary single-needle telegraphic instruments, or by telephone, the drawback to such an arrangement being that the signalman has no indication before him to remind him of the condition of the line.

Fig. 8 shows the signals at a typical English station, which may be called B. Notice having been received over the block telegraph that a train is coming from A (on the up track), the signalman in the cabin, *b*, lowers the home signal *h*; and (if the block section from B to C is clear of trains) he lowers the starting signal, *s*, also. The function of a distant signal *d* has already been described; it is mechanically impossible for it to be lowered unless *h* has previously been lowered. The relation of the signals to the "crossover road" *xx* is the same in principle as is shown in fig. 5. Dwarf or disk signals such as would be used for the siding T or the crossover *xx* are omitted from the sketch. Where the sections are very short, the starting signal of one section is often placed on the same post as the distant signal of the next. Thus, supposing B and C to be very close to each other, B's starting signal would be on the same post as C's distant signal, the latter being below the former, and the two would be so interconnected by "slotting" apparatus that C could not lower his distant signal unless B's starting signal was "off," while B by the act of raising his starting arm would necessarily throw C's distant arm to "danger." In America many block stations have only the home signal, even at stations where there are points and sidings, and on double-track lines the block

telegraphing for both is done on a single Morse circuit. In the United Kingdom the practice is to have separate apparatus and separate wires for each track.

In the simple block system it is clearly possible for a signalman, through carelessness, forgetfulness, or other cause, and in disregard of the indications of his telegraph instruments, so to lower his signals as to admit a second train into the

Lock-and-block.

block section before the first has left it, and that without the driver of either train being aware of the fact. To eliminate as far as possible the chance of such an occurrence, which is directly opposed to the essence of the block system and may obviously lead to a collision, the locking of the mechanical signals with the electrical block instruments was introduced in England by W. R. Sykes about 1876, the apparatus being so arranged that a signalman at one end of a section is physically unable to lower his signals to let a train enter that section until they have been released electrically from the cabin at the other end. The starting signal at a block section A cannot be lowered until the signalman at the next station B, by means of an electric circuit, unlocks the lever in connexion with it. In so doing he breaks the unlocking circuit at his own station, and this break is restored only on the arrival of the train for which the unlocking was performed, the wheels of the train acting through a lever or by a short rail circuit. Valuable improvements have been made in this machine by Patenall, Coleman and others, and these are in use in America, where the system is known as the "controlled manual." The passage of a train is also made to set a signal at "stop" automatically, by disconnecting the rod between the signal and its lever. The connexion cannot be restored by the signalman; it must be done by an electro-magnet brought into action by the train as it passes the next block station.

The block system is used on single as well as on double lines. In the United Kingdom and in Australia the means for preventing collisions between trains running towards

Staff system.

each other on single-track railways is the "staff system." The staff, suitably inscribed, is delivered to the engine-driver at station A, and constitutes his authority to occupy the main track between that station and station B. On reaching B he surrenders the staff, and receives another one which gives him the right to the road between B and C. If there are two or more trains to be moved, all except the last one receive tickets, which belong to that particular staff. The staff system requires no telegraph; but to obviate the inconvenience of sometimes finding the staff at the wrong end of the road, electric staff apparatus has been devised. Staffs (or tablets) in any desired number are kept at each of the two stations, and are locked in a cabinet automatically controlled, through electro-magnets, by apparatus in the cabinet at the other station; and a staff (or tablet) being taken out at one station, a second one cannot be taken out at either station until this first one is returned to the magazine at one station or the other. Thus there is a complete block system. By simple "catching apparatus" on the engine, staffs or tablets may be delivered to trains moving at a good speed.

The signals so far described depend for their operation, either wholly or partially, on human agency, but there are others, commonly known as "automatic," which are worked by the trains themselves, without human intervention.

Automatic signals.

Such signals, as a rule, are so arranged that normally they are constrained to stand at "safety," instead of in the "danger" position, which, like ordinary signals, they assume if left to themselves; but as a train enters a block section the constraint on the signals that guard it is removed and they return to the danger position, which they retain till the train has passed through. To effect this result an electrical track circuit or rail circuit is employed, in conjunction with some form of power to put the signalling devices to safety. Live-wire circuits were formerly employed, but are now generally abandoned. The current from a battery *b* (fig. 9) passes along the rails of one side of the track to the signal *s* and returns along the other rails through a relay. If the current through this relay is stopped in

any way, whether by failure of the battery or by a short circuit caused by the presence of a train or vehicle with metal wheels connected by metal axles on any part of the block section, its electro-magnet is de-energized, and its armature drops, removing the constraint which kept the signals at safety and allowing them to move to danger. When the train has passed through the block



FIG. 9.—Automatic electric block signal, with rail circuit.

section the current is restored and the signals are forced back to show safety. The current used for the track circuit must be of low tension, because of the imperfect insulation, and as a rule the ballast must not be allowed to touch the rails and must be free from iron or other conducting substance. At each rail joint a wire is used to secure electrical continuity, and at the ends of each block section there are insulating joints in the track. Block sections more than about 1 m. long are commonly divided into two or more circuits, connected together by relays; but usually they are made under 1 m. in length and often on intra-urban railways very much less, so that many more trains can be passed over the line in a given time than is possible with ordinary block signalling. At points the track circuit is run through a circuit breaker, so that the "opening" of the points sets the signal for the section. The circuit is also led through the rails of the siding so far as they foul the main track. An indicator at each switch gives visual or audible warning of an approaching train.

The signals themselves have been devised to work by clockwork, by electricity—obtained, not from the track circuit, but from a power station, or from non-freezing batteries at each post, or from accumulators charged by dynamos situated, say, every 10 m. along the line—and by pneumatic power, either compressed atmospheric air laid on from a main or carbonic acid gas

stored in a tank at the foot of the posts, each tank furnishing power for several thousand movements of the signal arm. A clockwork signal is shown in fig. 10. When an electro-magnet in the rail circuit drops its armature, the mechanism is released and causes the disk to turn and indicate stop. On the restoration of the current the disk makes another quarter

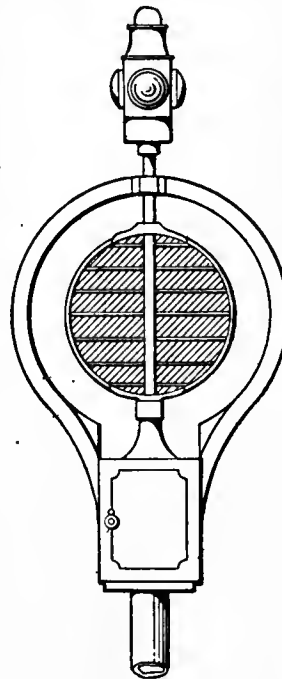

FIG. 10.—Signal moved by clockwork (Union).

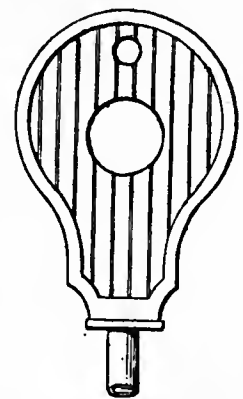

FIG. 11.—Enclosed disk signal (Hall).

turn and then shows only its edge to the approaching train, indicating "all clear."

The enclosed disk signal, commonly called a "banjo" (fig. 11), is a circular box about 4 ft. in diameter, with a glass-covered opening, behind which a red disk is shown to indicate stop. The disk, very light, made of cloth stretched over a wire, or of aluminium, is supported on a spindle, which is delicately balanced on a pivot so that the closing of an electro-magnet lifts the disk

away from the window and thus indicates "all clear." On the withdrawal or failure of the current the disk falls by gravity to the "stop" position. A local battery is used, with a relay, the rail circuit not being strong enough to lift the disk. In the electro-pneumatic system a full-size semaphore is used. Compressed air, from pumps situated at intervals of 10 to 20 m., is conveyed along the line in an iron pipe, and is supplied to a cylinder at each signal, exactly as in pneumatic interlocking, before described. The rail circuit, when complete, maintains pressure in a cylinder, holding the signal "off." On the entrance of a train or the failure of the current, the air is liberated and the signal arm is carried by gravity to the "stop" position.

Automatic signals are sometimes made to stand normally (when no train is in the section) in the "stop" position. The local circuit is connected with the rail circuit so that it is closed only when a train is approaching within, say, 1 m. With the rail circuit, distant signals are controlled, without a line wire, by means of a polarized relay. Each signal, when cleared, changes the polarity of the rail circuit for the next section in its rear, and this, by the polarized relay, closes the local circuit of the distant signal, without affecting the home signal for that section.

Automatic signals are used in America on a few single lines. The signal at A for the line AB is arranged as before described; and the signal at B, for movements in the opposite direction, is worked by means of a line wire from A, strung on poles. When a section is occupied, signals are set *two* sections away, so as to provide against the simultaneous entry of two trains.

One of the chief causes of anxiety and difficulty in the working of railway traffic is fog, which practically blots out the whole system of visible signals, so that while the block telegraph remains, the means of communicating the necessary instructions to the driver are no longer effective. Delay and confusion immediately arise; and in order to secure safety, speed has to be lessened, trains have to be reduced in number, and a system of "fog-signalling" introduced.

Fog signalling. In England, especially around London, elaborate arrangements have to be made. "Fog-signalling" consists in the employment of audible signals, or detonators, to convey to drivers the information ordinarily imparted by the visible or semaphore signals. As soon as possible after a fog comes on, a man is stationed at the foot of each distant signal, and generally of each home signal also, who by means of detonators, red and green flags and a hand-lamp, conveys information to the driver of every train as to the position of the semaphore arm. A detonator is a small flat metal case about 2 in. in diameter and $\frac{1}{2}$ in. deep, furnished with two leaden ears or clips which can be easily bent down to grip the head of the rail. The case contains some detonating composition, which readily explodes with a loud report when a wheel passes over it. As soon as a signal arm is raised to "danger," the fogman places upon one of the rails of the track to which the signal applies two detonators, or in the case of a new and improved class of detonator which contains two separate charges in one case, one detonator, and at the same time exhibits a red flag or light to the driver of an approaching train. The engine of a train passing over the detonators explodes them, the noise so made being sufficient to apprise the driver that the signal, though invisible to him, is at danger, and he then should act in the same way as if he had seen the signal. If, however, the signal arm should be lowered to the "all-right" position before a train reaches it, the fogman should immediately remove the detonators and exhibit a green flag or lamp, replacing the detonators as soon as the signal is again raised to danger. As a rule the fogmen are drawn from the ranks of the permanent-way men, who otherwise would be idle. But if, as sometimes happens, a fog continues for several days, great difficulty is experienced in obtaining sufficient men to carry on this important duty without undue prolongation of their hours of work. When this happens, signalmen, shunters, porters, yardsmen and even clerks may have to be called on to take a turn at "fogging." Some companies have adopted mechanical appliances, whereby a man can place a detonator upon a line of rails or remove it while standing at a distance away from the track, thus enabling him to attend to more than one line without danger to himself. The cost of detonators often amounts to a considerable sum; and an apparatus called an *economizer* has been introduced, whereby the explosion of one detonator removes the second from the rails before the wheels reach it. As it is only necessary for one detonator to explode, the object of placing two on the rails being merely to guard against a miss-fire, considerable saving can thus be effected. Many attempts have been made to design a mechanical apparatus for conveying to a driver the requisite information as to the state of the signals during a fog, and for enabling the fogmen to be dispensed with. Such inventions usually consist of two parts, namely (1) an inclined plane or block or trigger, placed on the permanent way alongside the track or between the rails, and working in connexion with the arm of the signal; and (2) a

lever or rod connected with the steam-whistle, or an electric bell or indicator on the foot-plate, and depending from the under-side of the engine in such a position as to come in contact with the apparatus on the ground, when the latter is raised above the level of the rails. Most of the proposed systems only give an indication when the signal is at danger, and are silent when the signal is off. This is contrary to good practice, which requires that a driver should receive a positive indication both when the signal is "off" as well as when it is "on." If this is not done, a driver may, if the signal is "off" and if the fog is thick, be unaware that he has passed the signal, and not know what part of the line he has reached. The absence of a signal at a place where a signal is usually exhibited should invariably be taken to mean danger. Fog signalling machines that depend on the explosion of detonators or cartridges have the drawback that they require recharging after a certain number of explosions, varying with the nature and size of the machine. Even when a satisfactory form of appliance has been discovered, the manner of using it is by no means simple. It is clearly no use placing such an apparatus immediately alongside a stop signal, as the driver would receive the intimation too late for him to be able to stop at the required spot. To place devices of this description at or near every stop signal in a large station or busy junction would involve a multiplication of wires or rods which is undesirable. Every such apparatus should certainly be capable of giving an "all-right" signal as well as a "danger" signal. It requires very careful maintenance, and should be in regular daily use to ensure its efficiency.

The fundamental principles of railway signalling are simple, but the development of the science has called for much study and a large money outlay. On every railway of any consequence the problems of safety, economy and convenience are involved, one with another, and cannot be perfectly solved. Even so fundamental a duty as that of guarding the safety of life and limb is a relative one when we have to consider whether a certain expenditure is justifiable for a given safety device. Having good discipline and foregoing the advantages of high speed, many a manager has successfully deferred the introduction of signals; others, having to meet severe competition, or, in Great Britain, under the pressure of the government, have been forced to adopt the most complete apparatus at great cost. In large city terminal stations, where additions to the space are out of the question, interlocking is necessary for economy of time and labour, as, indeed, it is in a less degree at smaller stations also; as a measure of safety, however, it is desirable at even the smallest, and the wise manager extends its use as fast as he is financially able. At crossings at grade level of one railway with another, and at drawbridges, interlocked signals with derailing switches obviate the necessity of stopping all the trains, as formerly was required by law everywhere in America, and saving a stop saves money. The block system was introduced primarily for safety, but where trains are frequent it becomes also an element of economy. Without it trains must usually be run at least five minutes apart (many managers deem seven or ten minutes the shortest safe interval for general use), but with it the interval may be reduced to three minutes, or less, according to the shortness of the block sections. With automatic signals trains are safely run at high speed only $1\frac{1}{2}$ m. apart, and on urban lines the distance between them may be only a few hundred yards. (B. B. A.; H. M. R.)

SIGNATURE (through Fr. from Lat. *signatura*, *signare*, to sign, *signum*, mark, token, sign), a distinguishing sign or mark, especially the name, or something representing the name, of a person used by him as affixed to a document or other writing to show that it has been written by him or made in accordance with his wishes or directions (see AUTOGRAPH, MONOGRAM, &c.). In the early sense of something which "signifies," *i.e.* marks a condition, quality or meaning, the word was formerly also used widely, but now chiefly in technical applications. In old medical theory, plants and minerals were supposed to be marked by some natural sign or symbol which indicated the particular medicinal use to which they could be put; thus yellow flowers were to be used for jaundice, the "scorpion-grass," the old name of the forget-me-not, was efficacious for the bite of the scorpion; many superstitions were based on the human shape of the roots of the mandrake or mandragora; the bloodstone was taken to be a cure for hemorrhage; this theory was known as the "doctrine of signatures." (See T. J. Pettigrew, *Superstitions connected with Medicine or Surgery*, 1844.) In printing or book-

**Develop-
ment of
signalling.**

binding the "signature" is a letter or figure placed at the bottom of the first page of a section of a book, as an assistance to the binder in folding and arranging the sections consecutively; hence it is used of a sheet ready folded. In music it is the term applied to the signs affixed at the beginning of the stave showing the key or tonality and the time or rhythm (see MUSICAL NOTATION).

SIGN-BOARD, strictly a board placed or hung before any building to designate its character. The French *enseigne* indicates its essential connexion with what is known in English as a flag (*q.v.*), and in France banners not infrequently took the place of sign-boards in the middle ages. Sign-boards, however, are best known in the shape of painted or carved advertisements for shops, inns, &c., they are in fact one of various emblematic methods used from time immemorial for publicly calling attention to the place to which they refer. The ancient Egyptians and Greeks are known to have used signs, and many Roman examples are preserved, among them the widely-recognized bush to indicate a tavern, from which is derived the proverb "Good wine needs no bush." In some cases, such as the bush, or the three balls of pawnbrokers, certain signs became identified with certain trades, but apart from these the emblems employed by traders—evolving often into trade-marks—may in great part be grouped according to their various origins. Thus, at an early period the cross or other sign of a religious character was used to attract Christians, whereas the sign of the sun or the moon would serve the same purpose for pagans. Later, the adaptation of the coats of arms or badges of noble families became common; these would be described by the people without consideration of the language of heraldry, and thus such signs as the Red Lion, the Green Dragon, &c., have become familiar. Another class of sign was that which exhibited merely persons employed in the various trades, or objects typical of them, but in large towns where many practised the same trade, and especially, as was often the case, where these congregated mainly in the same street, such signs did not provide sufficient distinction. Thus a variety of devices came into existence—sometimes the trader used a rebus on his own name (*e.g.* two cocks for the name of Cox); sometimes he adopted any figure of an animal or other object, or portrait of a well-known person, which he considered likely to attract attention. Finally we have the common association of two heterogeneous objects, which (apart from those representing a rebus) were in some cases merely a whimsical combination, but in others arose from a popular misconception of the sign itself (*e.g.* the combination of the "leg and star" may have originated in a representation of the insignia of the garter), or from corruption in popular speech (*e.g.* the combination "goat and compasses" is said by some to be a corruption of "God encompasses"). Whereas the use of signs was generally optional, publicans were on a different footing from other traders in this respect. As early as the 14th century there was a law in England compelling them to exhibit signs, for in 1393 the prosecution of a publican for not doing so is recorded. In France edicts were directed to the same end in 1567 and 1577. Since the object of sign-boards was to attract the public, they were often of an elaborate character. Not only were the signs themselves large and sometimes of great artistic merit (especially in the 16th and 17th centuries, when they reached their greatest vogue) but the posts or metal supports protruding from the houses over the street, from which the signs were swung, were often elaborately worked, and many beautiful examples of wrought-iron supports survive both in England and on the Continent. The signs were a prominent feature of the streets of London at this period. But here and in other large towns they became a danger and a nuisance in the narrow ways. Already in 1669 a royal order had been directed in France against the excessive size of sign-boards and their projection too far over the streets. In Paris in 1761 and in London about 1762–1773 laws were introduced which gradually compelled sign-boards to be removed or fixed flat against the wall. For the most part they only survived in connexion with inns, for which some of the greatest artists of the time painted sign-boards, usually

representing the name of the inn. With the gradual abolition of sign-boards the numbering of houses began to be introduced in the 18th century in London. It had been attempted in Paris as early as 1512, and had become almost universal by the close of the 18th century, though not enforced until 1805. It appears to have been first introduced into London early in the 18th century. Pending this development, houses which carried on trade at night (*e.g.* coffee houses, &c.) had various specific arrangements of lights, and these still survive to some extent, as in the case of doctors' dispensaries and chemists' shops.

See Jacob Larwood and John Camden Hotten, *History of Sign-boards* (London, 1866).

SIGNIA (mod. *Segni*), an ancient town of Latium (*adiectum*), Italy, on a projecting lower summit of the Volscian mountains, above the Via Latina, some 35 m. S.E. of Rome. The modern railway station, 33 m. S.E. of Rome, lies 5 m. S.E. of Signia, 669 ft. above sea level. The modern town (2192 ft.) occupies the lower part of the ancient site. Pop. (1901) 6942. Its foundation as a Roman colony is ascribed to Tarquinius Superbus, and new colonists were sent there in 495 B.C. Its position was certainly of great importance: it commands a splendid view, and with Anagnina, which lies opposite to it, guarded the approach to the valley of the Treverus or Tolerus (Sacco) and so the road to the south. It remained faithful to Rome both in the Latin and in the Hannibalic wars, and served as a place of detention for the Carthaginian hostages during the latter. It seems to have remained a place of some importance. Like Cora it retained the right of coining in silver. The wonderfully hard, strong cement, made partly of broken pieces of pottery, which served as the lining for Roman water cisterns (*opus signinum*) owes its name to its invention here (Vitruvius, viii. 7, 14). Its wine, pears and charcoal were famous in Roman times. In 90 B.C. it became a municipium with a *senatus* and *praetores*. In the civil war it joined the democratic party, and it was from here that in 82 B.C. Marius marched to Sacriportus (probably marked by the medieval castle of Piombinara, near Segni station, commanding the junction of the Via Labicana and the Via Latina; see T. Ashby, *Papers of the British School at Rome*, London, 1902, i. 125 sqq.), where he was defeated with loss. After this we hear no more of Signia until, in the middle ages, it became a papal fortress.

The city wall, constructed of polygonal blocks of the mountain limestone and $1\frac{1}{4}$ m. in circumference, is still well preserved and has several gates; the largest, Porta Saracinesca, is roofed by the gradual inclination of the sides until they are close enough to allow of the placing of a lintel. The other gates are mostly narrow posterns covered with flat monolithic lintels, and the careful jointing of the blocks of which some of them are composed may be noted. Their date need not be so early as is generally believed (*cf.* NORBA) and they are certainly not pre-Roman. A portion of the wall in the modern town has been restored in *opus quadratum* of tufa in Roman times. Above the modern town, on the highest point, is the church of S. Pietro, occupying the central cella of the ancient Capitolium of Signia (which had three cellae). The walls consist of rectangular blocks of tufa, and the whole rests upon a platform of polygonal masses of limestone (see R. Delbrück, *Das Capitolium von Signia*, Rome, 1903). An open circular cistern in front of the church lined with rectangular blocks of tufa may also be noted. (T. As.)

SIGNIFICS. The term "Significs" may be defined as the science of meaning or the study of significance, provided sufficient recognition is given to its practical aspect as a method of mind, one which is involved in all forms of mental activity, including that of logic.

In Baldwin's *Dictionary of Philosophy and Psychology* (1901–1905) the following definition is given:—

"1. Significs implies a careful distinction between (*a*) sense or signification, (*b*) meaning or intention and (*c*) significance or ideal worth. It will be seen that the reference of the first is mainly verbal (or rather sensal), of the second volitional, and of the third moral (*e.g.* we speak of some event 'the significance of which cannot be overrated,' and it would be impossible in such a case to substitute the 'sense' or the 'meaning' of such event, without serious loss).

Significs treats of the relation of the sign in the widest sense to each of these.

2. A proposed method of mental training aiming at the concentration of intellectual activities on that which is implicitly assumed to constitute the primary and ultimate value of every form of study, *i.e.* what is at present indifferently called its meaning or sense, its import or significance. . . . Significs as a science would centralise and co-ordinate, interpret, inter-relate and concentrate the efforts to bring out meanings in every form, and in so doing to classify the various applications of the signifying property clearly and distinctly."

Since this dictionary was published, however, the subject has undergone further consideration and some development, which necessitate modifications in the definition given. It is clear that stress needs to be laid upon the application of the principles and method involved, not merely, though notably, to language, but to all other types of human function. There is need to insist on the rectification of mental attitude and increase of interpretative power which must follow on the adoption of the signifi- cal view-point and method, throughout all stages and forms of mental training, and in the demands and contingencies of life.

In so far as it deals with linguistic forms, Significs includes "Semantics," a branch of study which was formally introduced and expounded in 1897 by Michel Bréal, the distinguished French philologist, in his *Essai de sémantique*. In 1900 this book was translated into English by Mrs Henry Cust, with a preface by Professor Postgate. M. Bréal gives no more precise definition than the following:—

"Extraire de la linguistique ce qui en ressort comme aliment pour la réflexion et—je ne crains pas de l'ajouter—comme règle pour notre propre langage, puisque chacun de nous collabore pour sa part à l'évolution de la parole humaine, voilà ce qui mérite d'être mis en lumière, voilà ce qui j'ai essayé de faire en ce volume."

In the *Dictionary of Philosophy and Psychology* Semantics is defined as "the doctrine of historical word-meanings; the systematic discussion of the history and development of changes in the meanings of words." It may thus be regarded as a reform and extension of the etymological method, which applies to contemporary as well as to traditional or historical derivation. As human interests grow in constantly specialized directions, the vocabulary thus enriched is unthinkingly borrowed and re-borrowed on many sides, at first in definite quotation, but soon in unconscious or deliberate adoption. Semantics may thus, for present purposes, be described as the application of Significs within strictly philological limits; but it does not include the study and classification of the "Meaning" terms themselves, nor the attainment of a clear recognition of their radical importance as rendering, well or ill, the expressive value not only of sound and script but also of all fact or occurrence which demands and may arouse profitable attention.

The first duty of the Significian is, therefore, to deprecate the demand for mere linguistic reform, which is indispensable on its own proper ground, but cannot be considered as the satisfaction of a radical need such as that now suggested. To be content with mere reform of articulate expression would be fatal to the prospect of a significantly adequate language; one characterized by a development only to be compared to that of the life and mind of which it is or should be naturally the delicate, flexible, fitting, creative, as also controlling and ordering, Expression.

The classified use of the terms of expression-value suggests three main levels or classes of that value—those of Sense, Meaning and Significance.

(a) The first of these at the outset would naturally be associated with Sense in its most primitive reference; that is, with the organic response to environment, and with the essentially expressive element in all experience. We ostracize the senseless in speech, and also ask "in what sense" a word is used or a statement may be justified.

(b) But "Sense" is not in itself purposive; whereas that is the main character of the word "Meaning," which is properly reserved for the specific sense which it is *intended to convey*.

(c) As including sense and meaning but transcending them in range, and covering the far-reaching consequence, implication, ultimate result or outcome of some event or experience, the term "Significance" is usefully applied.

These are not, of course, the only signifi- cal terms in common use, though perhaps sense and significance are on the whole the most consistently employed. We have also signification, pur- port, import, bearing, reference, indication, application, implica- tion, denotation and connotation, the weight, the drift, the tenour, the lie, the trend, the range, the tendency, of given statements. We say that this fact suggests, that one portends, another carries, involves or entails certain consequences, or justifies given inferences. And finally we have the *value* of all forms of expression; that which makes worth while any assertion or proposition, concept, doctrine or theory; the definition of scientific fact, the use of symbolic method, the construction of mathematical formulae, the playing of an actor's part, or even art itself, like literature in all its forms.

The distinctive instead of haphazard use, then, of these and like terms would soon, both as clearing and enriching it, tell for good on our thinking. If we considered that any one of them were senseless, unmeaning, insignificant, we should at once in ordinary usage and in education disavow and disallow it. As it is, accepted idiom may unconsciously either illuminate or con- tradict experience. We speak, for instance, of *going through* trouble or trial; we never speak of *going through* well-being. That illuminates. But also we speak of the Inner or Internal as *alternative* to the spatial—reducing the spatial to the External. The very note of the value to the philosopher of the "Inner" as opposed to the "Outer" experience is that a certain example or analogue of enclosed space—a specified inside—is thus not measurable. That obscures. Such a usage, in fact, implies that, within enclosing limits, space sometimes ceases to exist. Com- ment is surely needless.

The most urgent reference and the most promising field for Significs lie in the direction of education. The normal child, with his inborn exploring, signifi- cating and comparing tendencies is so far the natural Significian. At once to enrich and simplify language would for him be a fascinating endeavour. Even his crudeness would often be suggestive. It is for his elders to supply the lacking criticism out of the storehouse of racial experience, acquired knowledge and ordered economy of means; and to educate him also by showing the dangers and drawbacks of uncontrolled linguistic, as other, adventure. Now the evidence that this last has virtually been hitherto left undone and even reversed, is found on careful examination to be overwhelming.¹ Unhappily what we have so far called education has, anyhow for centuries past, ignored—indeed in most cases even balked—the instinct to scrutinise and appraise the value of all that exists or happens within our ken, actual or possible, and fittingly to express this.

Concerning the linguistic bearing of Significs, abundant evidence has been collected, often in quarters where it would least be expected—

1. Of general unconsciousness of confusion, defeat, anti- quation and inadequacy in language.
2. A. Of admission of the fact in given cases, but plea of helplessness to set things right. B. Of protest in such cases and suggestions for improvement.
3. Of direct or implied denial that the evil exists or is serious, and of prejudice against any attempt at concerted control and direction of the most developed group of languages.
4. Of the loss and danger of now unworthy or misfitting imagery and of symbolic assertion, observance or rite, once both worthy and fitting.
5. Of the entire lack, in education, of emphasis on the indis- pensable means of healthy mental development, *i.e.* the removal of linguistic hindrances and the full exploitation and expansion of available resources in language.
6. Of the central importance of acquiring a clear and orderly use of the terms of what we vaguely call "Meaning"; and also of the active modes, by gesture, signal or otherwise, of conveying intention, desire, impression and rational or emotional thought.

¹ It would be impossible of course in a short space to prove this contention. But the proof exists, and it is at the service of those who quite reasonably may deny its possible existence.

7. Finally and notably, of the wide-spread and all-pervading havoc at present wrought by the persistent neglect, in modern civilization, of the factor on which depends so much of our practical and intellectual welfare and advance.

As the value of this evidence is emphatically cumulative, the few and brief examples necessarily torn from their context for which alone room could here be found would only be misleading. A selection, however, from the endless confusions and logical absurdities which are not only tolerated but taught without correction or warning to children may be given.

We speak of beginning and end as complementary, and then of "both ends"; but never of both beginnings. We talk of truth when we mean accuracy; of the literal ("it is written") when we mean the actual ("it is done"). Some of us talk of the mystic and his mysticism, meaning by this, enlightenment, dawn heralding a day; others (more justly) mean by it the mystifying twilight, darkening into night. We talk of the unknowable when what that is or whether it exists is precisely what we cannot know—the idea presupposes what it denies; we affirm or deny immortality, ignoring its correlative innativity; we talk of solid foundations for life, for mind, for thought, when we mean the starting-points, foci. We speak of an eternal sleep when the very *raison d'être* of sleep is to end in awaking—it is not sleep unless it does; we appeal to a root as to an origin, and also figuratively give roots to the locomotive animal. We speak of natural "law" taking no count of the sub-attentive working in the civilized mind of the associations of the legal system (and the law court) with its decreed and enforced, but also revocable or modifiable enactments. Nature, again, is indifferently spoken of as the norm of all order and fitness, the desecration of which is reprobated as the worst form of vice and is even motherly in bountiful provision; but also as a monster of reckless cruelty and tyrannous mockery. Again, we use the word "passion" for the highest activity of desire or craving, while we keep "passive" for its very negation.

These instances might be indefinitely multiplied. But it must of course be borne in mind that we are throughout dealing only with the idioms and habits of the English language. Each civilized language must obviously be dealt with on its own merits.

The very fact that the significating and interpretative function is the actual, though as yet little recognized and quite unstudied condition of mental advance and human achievement; accounts for such a function being taken for granted and left to take care of itself. This indeed, in pre-civilized ages (since it was then the very condition of safety and practically of survival), it was well able to do. But the innumerable forms of protection, precaution, artificial aid and special facilities which modern civilization implies and provides and to which it is always adding, have entirely and dangerously changed the situation. It has become imperative to realize the fact that through disuse we have partly lost the greatest as the most universal of human prerogatives. Hence arises the special difficulty of clearly showing at this stage that man has now of set purpose to recover and develop on a higher than the primitive plane the sovereign power of unerring and productive interpretation of a world which even to a living, much more to an intelligent, being, is essentially significant. These conditions apply not only to the linguistic but to all forms of human energy and expression, which before all else must be significant in the most active, as the highest, sense and degree. Man has from the outset been organizing his experience; and he is bound correspondingly to organize the expression of that experience in all phases of his purposive activity, but more especially in that of articulate speech and linguistic symbol. This at once introduces the volitional element; one which has been strangely eliminated from the very function which most of all needs and would repay it.

One point must here, however, be emphasised. In attempting to inaugurate any new departure from habitual thinking, history witnesses that the demand at its initial stage for unmistakably clear exposition must be not only unreasonable but futile. This of course must be typically so in the case of an appeal for the vital

regeneration of all modes of Expression and especially of Language, by the practical recognition of an ignored but governing factor working at its very inception and source. In fact, for many centuries at least, the leading civilizations of the world have been content to perpetuate modes of speech once entirely fitting but now often grotesquely inappropriate, while also remaining content with casual changes often for the worse and always liable to inconsistency with context. This inevitably makes for the creation of a false standard both of lucidity and style in linguistic expression.

Still, though we must be prepared to make an effort in assuming what is virtually a new mental attitude, the effort will assuredly be found fully worth making. For there is here from the very first a special compensation. If, to those whose education has followed the customary lines, nowhere is the initial difficulty of moving in a new direction greater than in the one termed Significs, nowhere, correspondingly, is the harvest of advantage more immediate, greater, or of wider range and effort.

It ought surely to be evident that the hope of such a language; of a speech which shall worthily express human need and gain in its every possible development in the most efficient possible way, depends on the awakening and stimulation of a sense which it is our common and foremost interest to cultivate to the utmost on true and healthy lines. This may be described as the immediate and insistent sense of the pregnancy of things, of the actual bearings of experience, of the pressing and cardinal importance, as warning or guide, of that experience considered as indicative; a Sense realized as belonging to a world of what for us must always be the Sign of somewhat to be inferred, acted upon, used as a mine of pertinent and productive symbol, and as the normal incitant to profitable action. When this germinal or primal sense—as also the practical starting-point, of language—has become a reality for us, reforms and acquisitions really needed will naturally follow as the expression of such a recovered command of fitness, of boundless capacity and of perfect coherence in all modes of expression.

One objection, however, which before this will have suggested itself to the critical reader, is that if we are here really dealing with a function which must claim an importance of the very first rank and affect our whole view of life, practical and theoretical, the need could not have failed long ago to be recognised and acted upon. And indeed it is not easy in a few words to dispose of such an objection and to justify so venturesome an apparent paradox as that with which we are now concerned. But it may be pointed out that the special development of one faculty always entails at least the partial atrophy of another. In a case like this the principle typically applies. For the main human acquirement has been almost entirely one of logical power, subtle analysis, and co-ordination of artificial means. In modern civilization the application of these functions to an enormous growth of invention of every kind has contributed not a little to the loss of the swift and direct sense of *point*: the sensitiveness as it were of the compass-needle to the direction in which experience was moving. Attention has been forcibly drawn elsewhere; and moreover, as already pointed out, the natural insight of children, which might have saved the situation, has been methodically silenced by a discipline called educative, but mainly suppressive and distortive.

The biological history of Man has been, indeed, a long series of transmutations of form to subservise higher functions. In language he has so far failed to accomplish this. There has even in some directions been loss of advantage already gained. While his nature has been plastic and adaptive, language, the most centrally important of his acquirements, has remained relatively rigid, or what is just as calamitous, fortuitously elastic. There have been notable examples—the classical languages—of the converse process. In Greek and Latin, Man admirably controlled, enriched, varied, significated his expressions to serve his mental needs. But we forbear ourselves to follow and better this example. All human energies have come under orderly direction and control except the one in which in a true sense they all depend. This fatal omission, for which defective methods

of education are mainly responsible, has disastrously told upon the mental advance of the race. But after all, we have here a comparatively modern neglect and helplessness. Kant, for instance, complained bitterly of the defeating tendency of language in his day, as compared with the intelligent freedom of the vocabulary and idiom of the "classical" Greek, who was always creating expression, moulding it to his needs and finding an equally intelligent response to his efforts, in his listeners and readers—in short, in his public.

Students, who are prepared seriously to take up this urgent question of the application of Significs in education and throughout all human spheres of interest, will soon better any instruction that could be given by the few who so far have tentatively striven to call attention to and bring to bear a practically ignored and unused method. But by the nature of the case they must be prepared to find that accepted language, at least in modern European forms, is far more needlessly defeating than they have supposed possible: that they themselves in fact are continually drawn back, or compelled so to write as to draw back their readers, into what is practically a hotbed of confusion, a prison of senseless formalism and therefore of barren controversy.

It can hardly be denied that this state of things is intolerable and demands effectual remedy. The study and systematic and practical adoption of the natural method of Significs can alone lead to and supply this. Significs is in fact the natural response to a general sense of need which daily becomes more undeniably evident. It finds no school of thought and advocates no technical specialism. Its immediate and most pressing application is, as already urged, to elementary, secondary and specialised education. In recent generations the healthy sense of discontent and the natural ideals of interpretation and expression have been discouraged instead of fostered by a training which has not only tolerated but perpetuated the existing chaos. Signs, however, are daily increasing that Significs, as implying the practical recognition of, and emphasising the true line of advance in, a recovered and enhanced power to interpret experience and adequately to express and apply that power, is destined, in the right hands, to become a socially operative factor of the first importance.

LITERATURE.—Lady Welby, "Sense, Meaning and Interpretation," in *Mind* (January and April 1896), *Grains of Sense* (1897), *What is Meaning?* (1903); Professor F. Tönnies, "Philosophical Terminology" (Welby Prize Essay), *Mind* (July and October 1899 and January 1900), also article in *Jahrbuch*, &c., and supplements to *Philosophische Terminologie* (December 1906); Professor G. F. Stout, *Manual of Psychology* (1898); Sir T. Clifford Allbutt's Address on "Words and Things" to the Students' Physical Society of Guy's Hospital (October 1906); Mr W. J. Greenstreet's "Recent Science" articles in the *Westminster Gazette* (November 15, 1906, and January 10, 1907). (V. W.)

SIGN-MANUAL, ROYAL, the autograph signature of the sovereign, by which he expresses his pleasure either by order, commission or warrant. A sign-manual warrant may be either an executive act, e.g. an appointment to an office, or an authority for affixing the Great Seal. It must be countersigned by a principal secretary of state or other responsible minister. A royal order under the sign-manual, as distinct from a sign-manual warrant, authorizes the expenditure of money, e.g. appropriations. There are certain offices to which appointment is made by commission under the great seal, e.g. the appointment of an officer in the army or that of a colonial governor. The sign-manual is also used to give power to make and ratify treaties. In certain cases the use of the sign-manual has been dispensed with, and a stamp affixed in lieu thereof, as in the case of George IV., whose bodily infirmity made the act of signing difficult and painful during the last weeks of his life. A special act was passed providing that a stamp might be affixed in lieu of the sign-manual (11 Geo. IV. c. 23), but the sovereign had to express his consent to each separate use of the stamp, the stamped document being attested by a confidential servant and several officers of state (Anson, *Law and Custom of the Constitution*, 1907, vol. ii. pt. i. p. 59).

SIGNORELLI, LUCA (c. 1442-c. 1524), Italian painter, was born in Cortona—his full name being Luca d'Egidio di Ventura;

he has also been called Luta da Cortona. The precise date of his birth is uncertain; but, as he is said to have died at the age of eighty-two, and as he was certainly alive during some part of 1524, the birth-date of 1442 must be nearly correct. He belongs to the Tuscan school, associated with that of Umbria. His first impressions of art seem to be due to Perugia—the style of Bonfigli, Fiorenzo and Pinturicchio. Lazzaro Vasari, the great-grandfather of Giorgio Vasari, the historian of art, was brother to Luca's mother; he got Luca apprenticed to Piero de' Franceschi. In 1472 the young man was painting at Arezzo, and in 1474 at Città di Castello. He presented to Lorenzo de' Medici a picture which is probably the one named the "School of Pan," discovered some years ago in Florence, and now belonging to the Berlin gallery; it is almost the same subject which he painted also on the wall of the Petrucci palace in Siena—the principal figures being Pan himself, Olympus, Echo, a man reclining on the ground and two listening shepherds. He executed, moreover, various sacred pictures, showing a study of Botticelli and Lippo Lippi. Pope Sixtus IV. commissioned Signorelli to paint some frescoes, now mostly very dim, in the shrine of Loreto—Angels, Doctors of the Church, Evangelists, Apostles, the Incredulity of Thomas and the Conversion of St Paul. He also executed a single fresco in the Sistine Chapel in Rome, the "Acts of Moses"; another, "Moses and Zipporah," which has been usually ascribed to Signorelli, is now recognized as the work of Perugino. Luca may have stayed in Rome from 1478 to 1484. In the latter year he returned to his native Cortona, which remained from this time his ordinary home. From 1497 he began some professional excursions. In Siena, in the convent of Chiusuri, he painted eight frescoes, forming part of a vast series of the life of St Benedict; they are at present much injured. In the palace of Pandolfo Petrucci he worked upon various classic or mythological subjects, including the "School of Pan" already mentioned. From Siena he went to Orvieto, and here he produced the works which, beyond all others, stamp his greatness in art. These are the frescoes in the chapel of S. Brizio, in the cathedral, which already contained some pictures on the vaulting by Fra Angelico. The works of Signorelli represent the "Last Days of the Mundane Dispensation," with the "Pomp and the Fall of Antichrist," and the "Eternal Destiny of Man," and occupy three vast lunettes, each of them a single picture. In one of them, Antichrist, after his portents and impious glories, falls headlong from the sky, crashing down into an innumerable crowd of men and women. "Paradise," the "Elect and the Condemned," "Hell," the "Resurrection of the Dead," and the "Destruction of the Reprobate" follow in other compartments. To Angelico's ceiling Signorelli added a section showing figures blowing trumpets, &c.; and in another ceiling he depicted the Madonna, Doctors of the Church, Patriarchs and Martyrs. There is also a great deal of subsidiary work connected with Dante, and with the poets and legends of antiquity. The daring and terrible invention of the great compositions, with their powerful treatment of the nude and of the most arduous foreshortenings, and the general mastery over complex grouping and distribution, marked a development of art which had never previously been attained. It has been said that Michelangelo felt so strongly the might of Signorelli's delineations that he borrowed, in his own "Last Judgment," some of the figures or combinations which he found at Orvieto; this statement, however, has not been verified by precise instances. The contract for Luca's work is still on record. He undertook on 5th April 1499 to complete the ceiling for 200 ducats, and to paint the walls for 600, along with lodging, and in every month two measures of wine and two quarters of corn. Signorelli's first stay in Orvieto lasted not more than two years. In 1502 he returned to Cortona, and painted a dead Christ, with the Marys and other figures. Two years later he was once more back in Orvieto, and completed the whole of his work in or about that time, i.e. some two years before 1506—a date famous in the history of the advance of art, when Michelangelo displayed his cartoon of Pisa.

After finishing off at Orvieto, Signorelli was much in Siena. In 1507 he executed a great altarpiece for S. Medardo at Arcevia

in Umbria—the “Madonna and Child,” with the “Massacre of the Innocents” and other episodes. In 1508 Pope Julius II. determined to readorn the camere of the Vatican, and he summoned to Rome Signorelli, in company with Perugino, Pinturicchio and Bazzi (Sodoma). They began operations, but were shortly all superseded to make way for Raphael, and their work was taken down. Luca now returned to Siena, living afterwards for the most part in Cortona. He continued constantly at work, but the performances of his closing years were not of special mark. In 1520 he went with one of his pictures to Arezzo. Here he saw Giorgio Vasari, aged eight, and encouraged his father to second the boy's bent for art. Vasari tells a pretty story how the wellnigh octogenarian master said to him “Impara, parentino” (“You must study, my little kinsman”), and clasped a jasper round his neck as a preservative against nose-bleeding, to which the child was subject. He was partially paralytic when he began a fresco of the “Baptism of Christ” in the chapel of Cardinal Passerini's palace near Cortona, which (or else a “Coronation of the Virgin” at Foiano) is the last picture of his specified. Signorelli stood in great repute not only as a painter but also as a citizen. He entered the magistracy of Cortona as early as 1488, and in 1524 held a leading position among the magistrates of his native place. In or about the year 1524 he died there.

Signorelli from an early age paid great attention to anatomy, carrying on his studies in burial grounds. He surpassed all his contemporaries in showing the structure and mechanism of the nude in immediate action; and he even went beyond nature in experiments of this kind, trying hypothetical attitudes and combinations. His drawings in the Louvre demonstrate this and bear a close analogy to the method of Michelangelo. He aimed at powerful truth rather than nobility of form; colour was comparatively neglected, and his chiaroscuro exhibits sharp oppositions of lights and shadows. He had a vast influence over the painters of his own and of succeeding times, but had no pupils or assistants of high mark; one of them was a nephew named Francesco. He was a married man with a family; one of his sons died, seemingly through some sudden casualty, and Luca depicted the corpse with sorrowful but steady self-possession. He is described as full of kindness and amiability, sincere, courteous, easy with his art assistants, of fine manners, living and dressing well; indeed, according to Vasari, he always lived more like a nobleman than a painter. The Torrigiani Gallery in Florence contains a grand life-sized portrait by Signorelli of a man in a red cap and vest; this is said to be the likeness of the painter himself, and corresponds with Vasari's observation. In the National Gallery, London, are the “Circumcision of Jesus” and three other works.

See R. Vischer, *Signorelli und die italienische Renaissance* (1879); Burlington Fine Arts Club, *Exhibition of Work of Signorelli, &c.* (1893); M. Crutwell, *Luca Signorelli* (1899). (W. M. R.)

SIGONIUS, CAROLUS [CARLO SIGONIO OR SIGONE] (c. 1524–1584), Italian humanist, was born at Modena. Having studied Greek under the learned Franciscus Portus of Candia, he attended the philosophical schools of Bologna and Pavia, and in 1545 was elected professor of Greek in his native place in succession to Portus. In 1552 he was appointed to a professorship at Venice, which he exchanged for the chair of eloquence at Padua in 1560. To this period of his life belongs the famous quarrel with Robertelli, due to the publication by Sigonius of a treatise *De nominibus Romanorum*, in which he corrected several errors in a work of Robertelli on the same subject. The quarrel was patched up by the intervention of Cardinal Seripando (who purposely stopped on his way to the Council of Trent), but broke out again in 1562, when the two rivals found themselves colleagues at Padua. Sigonius, who was of a peaceful disposition, thereupon accepted (in 1563) a call to Bologna. He died in a country house purchased by him in the neighbourhood of Modena, in August 1584. The last year of his life was embittered by another literary dispute. In 1583 there was published at Venice what purported to be Cicero's *Consolatio*, written as a distraction from his grief at the death of his daughter Tullia. Sigonius declared that, if not genuine, it was at least worthy of Cicero; those who held the opposite view (Antonio Riccoboni, Justus Lipsius, and others) asserted that Sigonius himself had written it with the object of deceiving the learned world, a charge which he explicitly denied. The work is now universally regarded as a forgery, whoever may

have been the author of it. Sigonius's reputation chiefly rests upon his publications on Greek and Roman antiquities, which may even now be consulted with advantage: *Fasti consulares* (1550; new ed., Oxford, 1802), with commentary, from the regal period to Tiberius, the first work in which the history of Rome was set forth in chronological order, based upon some fragments of old bronze tablets dug up in 1547 on the site of the old Forum; an edition of Livy with the Scholia; *De antiquo jure Romanorum, Italiae, provinciarum* (1560) and *De Romanae jurisprudentiae judiciis* (1574); *De republica Atheniensium* (1564) and *De Atheniensium et Lacedaemoniorum temporibus* (1565), the first well-arranged account of the constitution, history, and chronology of Athens and Sparta, with which may be mentioned a similar work on the religious, political, and military system of the Jews (*De republica Ebraeorum*). His history of the kingdom of Italy (*De regno Italiae*, 1580) from the invasion of the Lombards (568) to the end of the 13th century forms a companion volume to the history of the western empire (*De occidentali imperio*, 1579) from Diocletian to its destruction. In order to obtain material for these works, Sigonius consulted all the archives and family chronicles of Italy, and the public and private libraries, and the autograph MS. of his *De regno Italiae*, containing all the preliminary studies and many documents not used in print, was discovered in the Ambrosian library of Milan. At the request of Gregory XIII. he undertook to write the history of the Christian Church, but did not live to complete the work.

The most complete edition of his works is that by P. Argelati (Milan, 1732–1737), which contains his life by L. A. Muratori, the only trustworthy authority for the biographer; see also G. Tiraboschi, *Storia della letteratura italiana*, vii.; Ginguéné, *Histoire littéraire d'Italie*; J. P. Krebs, *Carl Sigonius* (1840), including some Latin letters of Sigonius and a complete list of his works in chronological order; Franciosi, *Della vita e delle opere di Carlo Sigonio* (Modena, 1872); Hessel, *De regno Italiae libri XX. von Carlo Sigonio, eine quellenkritische Untersuchung* (1900); and J. E. Sandys, *History of Classical Scholarship*, ii. (1908), p. 143.

SIGOURNEY, LYDIA HUNTLEY (1791–1865), American author, was born in Norwich, Connecticut, on the 1st of September 1791. She was educated in Norwich and Hartford. After conducting a private school for young ladies in Norwich, she conducted a similar school in Hartford from 1814 until 1819, when she was married to Charles Sigourney, a Hartford merchant. She contributed more than two thousand articles to many (nearly 300) periodicals, and wrote more than fifty books. She died in Hartford, on the 10th of June 1865. Her books include *Moral Pieces in Prose and Verse* (1815); *Traits of the Aborigines of America* (1822), a poem; *A Sketch of Connecticut Forty Years Since* (1824); *Poems* (1827); *Letters to Young Ladies* (1833), one of her best-known books; *Sketches* (1834); *Poetry for Children* (1834); *Zinzendorf, and Other Poems* (1835); *Olive Buds* (1836); *Letters to Mothers* (1838), republished in London; *Pocahontas, and Other Poems* (1841); *Pleasant Memories of Pleasant Lands* (1842), descriptive of her trip to Europe in 1840; *Scenes in My Native Land* (1844); *Letters to My Pupils* (1851); *Olive Leaves* (1851); *The Faded Hope* (1852), in memory of her only son, who died when he was nineteen years old; *Past Meridian* (1854); *The Daily Counsellor* (1858), poems; *Gleanings* (1860), selections from her verse; *The Man of Uz, and Other Poems* (1862); and *Letters of Life* (1866), giving an account of her career. She was one of the most popular writers of her day, both in America and in England, and was called “the American Hemans.” Her writings were characterized by fluency, grace and quiet reflection on nature, domestic and religious life, and philanthropic questions; but they were too often sentimental, didactic and commonplace to have much literary value. Some of her blank verse and pictures of nature suggest Bryant. Among her most successful poems are “Niagara” and “Indian Names.” Throughout her life she took an active interest in philanthropic and educational work.

SIGURD (*Sigurðr*) or SIEGFRIED (M. H. G. *Stfrit*), the hero of the *Nibelungenlied*, and of a number of Scandinavian poems included in the older *Edda*, as well as of the prose *Völsunga Saga*, which is based upon the latter. According to both the

German and Scandinavian authorities he was the son of a certain Sigmundr (Siegmond), a king in the Netherlands, or the "land of the Franks." The exploits of this Sigmundr and his elder sons Sinfjötli and Helgi form the subject of the earlier parts of *Völsunga Saga*, and Siegmund and Fitela (*i.e.* Sinfjötli) are also mentioned in the Anglo-Saxon poem *Beowulf*. According to the Scandinavian story Sigmundr was slain in battle before the birth of Sigurd, but the German story makes him survive his son. Sigurd acquired great fame and riches by slaying the dragon Fáfnir, but the chief interest of the story centres round his connexion with the court of the Burgundian king Gunnar (Gunther). He married Guðrun (Kriemhild), the sister of that king, and won for him by a stratagem the hand of the Valkyrie Brynhildr, with whom he had himself previously exchanged vows of love. A quarrel arose between Brynhildr and Guðrun, in the course of which the former learnt of the deception which had been practised upon her and this led eventually to the murder of Sigurd. According to the Scandinavian version he was slain by his brother-in-law Guttorm, according to the German version by the knight Hagen. Gunther's brothers were subsequently slain while visiting Atli (Eizel), who married Guðrun after Sigurd's death. According to the German story they were killed at the instigation of Kriemhild in revenge for Siegfried. The Scandinavian version of the story attributes the deed to Atli's lust for gold.

The story of Sigurd has given rise to more discussion than any other subject connected with the Teutonic heroic age. Like Achilles he is represented as the perfect embodiment of the ideals of the race, and, as in the case of the Greek hero, it is customary to regard his personality and exploits as mythical. There is no question, however, that the Burgundian king who is said to have been his brother-in-law was an historical person who was slain by the Huns, at the time when the Burgundian kingdom was overthrown by the latter. Sigurd himself is not mentioned by any contemporary writer; but, apart from the dragon incident, there is nothing in the story which affords sufficient justification for regarding his personality as mythical. Opinions, however, vary widely as to the precise proportions of history and fiction which the story contains. The story of Siegfried in Richard Wagner's famous opera-cycle *Der Ring der Nibelungen* is mainly taken from the northern version; but many features, especially the characterization of Hagen, are borrowed from the German story, as is also the episode of Siegfried's murder in the forest.

See NIBELUNGENLIED and also R. Heinzel, "Über die Nibelungensage," in *Sitzungsberichte der K. Akademie der Wissenschaften* (Vienna, 1885); H. Lichtenberger, *Le Poème et la légende des Nibelungen* (Paris, 1891); B. Symons, "Heldensage" in H. Paul's *Grundriss der germ. Philologie*, vol. iii. (Strassburg, 1900); and R. C. Boer, *Untersuchungen über den Ursprung und die Entwicklung der Nibelungensage* (Halle, 1906). Also T. Abeling, *Nibelungenlied* (1907). (F. G. M. B.)

SIGURÐSSON, JÓN (1811–1879), Icelandic statesman and man of letters, was born in the west of Iceland in 1811. He came of an old family, and received an excellent education. In 1830 he was secretary to the bishop of Iceland, the learned Steingrímur Jónsson. In 1833 he went to the university of Copenhagen and devoted himself to the study of Icelandic history and literature. His name soon became prominent in the learned world, and it may safely be said that most of his historical works and his editions of Icelandic classics have never been surpassed for acute criticism and minute painstaking. Of these we may mention *Lögsögumannatal og Lögmanna á Islandi* ("Speakers of the Law and Law-men in Iceland"); his edition of *Landnáma* and other sagas in *Islandinga Sögur*, i.–ii. (Copenhagen, 1843–1847); the large collection of Icelandic laws edited by him and Oddgeir Stephensen; and last, not least, the *Diplomatarium Islandicum*, which after his death was continued by others. But although he was one of the greatest scholars Iceland has produced, he was still greater as a politician. The Danish rule had, during the centuries following the Reformation, gradually brought Iceland to the verge of economic ruin; the ancient Parliament of the island, which had degenerated

to a mere shadow, had been abolished in 1800; all the revenue of Iceland went into the Danish treasury, and only very small sums were spent for the good of the island; but worst of all was the notorious monopoly which gave away the whole trade of Iceland to a single Danish trading company. This monopoly had been abolished in 1787, and the trade had been declared free to all Danish subjects, but practically the old arrangement was continued under disguised forms. Jón Sigurðsson began a hard struggle against the Danish government to obtain a reform. In 1854 the trade of Iceland was declared free to all nations. In 1840 the Althing was re-established as an advisory, not as a legislative body. But when Denmark got a free constitution in 1848, which had no legal validity in Iceland, the island felt justified in demanding full home rule. To this the Danish government was vehemently opposed; it convoked an Icelandic National Assembly in 1851, and brought before that body a bill granting Iceland small local liberties, but practically incorporating Iceland in Denmark. This bill was indignantly rejected, and, instigated by Jón Sigurðsson, another was demanded of far more liberal tendencies. The Danish governor-general then dissolved the assembly, but Jón Sigurðsson and all the members with him protested to the king against these unlawful proceedings. The struggle continued with great bitterness on both sides, but gradually the Danish government was forced to grant many important reforms. High schools were established at Reykjavík, and efforts made to better the trade and farming of the country. In 1871 the Danish parliament (Riksdag) passed a law defining the political position of Iceland in the Danish monarchy, which, though never recognized as valid by the Icelanders, became *de facto* the base of the political relations of Iceland and Denmark. At last, in 1874, when King Christian IX. visited Iceland at the festival commemorating the millenary of the colonization of Iceland from Norway, he gave to the country a Constitution, with full home rule in all internal matters. An immense victory was gained, entirely due to Jón Sigurðsson, whose high personal qualities had rallied all the nation round him. He was a man of fine appearance, with an eloquence and diplomatic gifts such as no others of his countrymen possessed, and his unselfish love of his country made itself felt in almost every branch of Icelandic life. Recognizing the value of an intellectual centre, he made Reykjavík not only the political, but the spiritual capital of Iceland by removing all the chief institutions of learning to that city; he was the soul of many literary and political societies, and the chief editor of the *Ný Félagsrit*, which has done more than any other Icelandic periodical to promote the cause of civilization and progress in Iceland. After Iceland had got home rule in 1874, the grateful people showered on Jón Sigurðsson all the honours it could bestow. He lived the greater part of his life in Copenhagen, and died there in 1879; but his body, together with that of his wife, Ingibjörg Einarsdóttir, whom he had married in 1845, and who survived him only a few days, was taken to Reykjavík and given a public funeral. On his monument was placed the inscription: "The beloved son of Iceland, her honour, sword, and shield." (S. BL.)

SIGWART, CHRISTOPH WILHELM VON (1789–1844), German philosopher, was born at Remmingsheim in Württemberg, and died in Stuttgart. He became professor of philosophy at Tübingen, and wrote numerous books on the history of philosophy:—*Über den Zusammenhang des Spinozismus mit der Cartesianischen Philosophie* (1816); *Handbuch zu Vorlesungen über die Logik* (1818, 3rd ed., 1835); *Der Spinozismus* (1839); and *Geschichte der Philosophie* (1844).

His son, CHRISTOPH VON SIGWART (1830–1894), after a course of philosophy and theology, became professor at Blaubeuren (1859), and eventually at Tübingen, in 1865. His principal work, *Logik*, published in 1873, takes an important place among recent contributions to logical theory. In the preface to the first edition, Sigwart explains that he makes no attempt to appreciate the logical theories of his predecessors; his intention was to construct a theory of logic, complete in itself. It represents the results of a long and careful study not only of German but also of English logicians. In 1895 an English translation by

Miss H. Dendy was published in London. Chapter v. of the second volume is especially interesting to English thinkers as containing a profound examination of the Induction theories of Bacon, J. S. Mill and Hume. Among his other works are *Spinozas neu entdeckter Traktat von Gott, dem Menschen und dessen Glückseligkeit* (1866); *Kleine Schriften* (1881); *Vorfragen der Ethik* (1886). The *Kleine Schriften* contains valuable criticisms on Paracelsus and Bruno.

SIGYNNAE (Σιγυνναι, Σιγυννοι), an obscure people of antiquity. They are variously located by ancient authors. According to Herodotus (v. 9), they dwelt beyond the Danube, and their frontiers extended almost as far as the Eneti on the Adriatic. Their horses (or rather, ponies) were small, with shaggy long hair, not strong enough to carry men, but very speedy when driven in harness. The people themselves wore a Medic costume, and, according to their own account, were a colony of the Medes. Strabo (xi. p. 520), who places them near the Caspian, also speaks of their ponies, and attributes to them Persian customs. In Apollonius Rhodius (iv. 320) they inhabit the shores of the Euxine, not far from the mouth of the Danube.

The statement as to their Medic origin, regarded as incomprehensible by Herodotus, is doubtfully explained by Rawlinson as indicating that "the Sigynnae retained a better recollection than other European tribes of their migrations westward and Aryan origin"; R. W. Macan (on Herod. v. 9) suggests that it may be due to a confusion with the Thracian Maedi (*Μαῖδοι*). If the last paragraph in Herodotus be genuine, the Ligyes who lived above Massilia called traders Sigynnae, while among the Cyprians the word meant "spears." The similarity between Sigynnae and Zigeuner is obvious, and it has been supposed that they were the forefathers of the modern gipsies. According to J. L. Myres, the Sigynnae of Herodotus were "a people widely spread in the Danubic basin in the 5th century B.C.," probably identical with the Sequani, and connected with the iron-working culture of Hallstatt, which produced a narrow-bladed throwing spear, the *sigynna* spear (see notice of "Anthropological Essays" in *Classical Review*, November 1908).

SIKH, a member of the Sikh religion in India (see SIKHISM). The word Sikh literally means "learner," "disciple," and was the name given by the first guru Nanak to his followers. The Sikhs are divided into two classes, Sahijdhari and Kesadhari. The former were so named from living at ease and the latter from wearing long hair. Both obey the general injunctions of the Sikh gurus, but the Sahijdhari Sikhs have not accepted the *pahul* or baptism of Guru Govind Singh, and do not wear the distinguishing habiliments of the Kesadhari, who are the baptized Sikhs, also called Singhs or lions. Their distinguishing habiliments are long hair wound round a small dagger and bearing a comb inserted in it, a steel bracelet and short drawers. Neither the Sahijdhari nor the Kesadhari Sikhs may smoke tobacco or drink wine. The prohibition of wine is, however, generally disregarded except by very orthodox Sikhs.

In the census of 1901, the number of Sikhs in the Punjab and North-Western Provinces was returned as 2,130,987, showing an increase of 13.9% in the decade; but these figures are not altogether reliable owing to the difficulty of distinguishing the Sahijdhari from the Kesadhari Sikhs and both from the Hindus. A man is not born a-Singh, but becomes so by baptism, the water of which is called *amrit* or nectar. It is possible that one brother may be a Hindu, while another is a true Sikh.

The Sikhs are principally drawn from the Arora, Jat and Ramgarhia tribes, but any one may become a Sikh by accepting the Sikh baptism. The Aroras are generally merchants or petty dealers. The Jats are agriculturists variously described as Scythian immigrants and as descendants of Rajputs who immigrated to the Punjab from central India. They are of a tougher fibre than the Aroras; sturdy and self-reliant, slow to speak but quick to strike. The Ramgarhias are principally mechanics.

To the temperament of the Jat, the Arora and the Ramgarhia Sikh add the stimulus of a militant religion. The Sikh is a fighting man, and his best qualities are shown in the army, which is his natural profession. Hardy, brave and slow-witted, obedient to discipline, attached to his officers, he makes the finest soldier of the East. In victory he retains his steadiness, and in defeat he will die at his post rather than yield. In peace time he shows a decided fondness for money, and will go wherever

it is to be earned. There are some 30,000 Sikhs in the Indian army, and the sect is cherished by the military authorities, who insist on all recruits taking the *pahul* or Sikh baptism. Many Sikhs are also to be found in the native regiments of east and central Africa and of Hyderabad in the Deccan, and they compose a great part of the police force in the treaty ports of China. (M. M.)

SIKHISM, a religion of India, whose followers (Sikhs) are principally found in the Punjab, United Provinces, Sind, Jammu and Kashmir. Sikhism was founded by Nanak, a Khatri by caste, who was born at Talwandi near Lahore in A.D. 1469, and after travelling and preaching throughout a great part of southern Asia died at Kartarpur in Jullundur in 1539. He was succeeded by nine gurus, great teachers or head priests, whose dates are as follows:—

	A.D.		A.D.
1. Nanak . . .	1469-1539	6. Har Govind . . .	1606-1645
2. Angad . . .	1539-1552	7. Har Rai . . .	1645-1661
3. Amar Das . . .	1552-1574	8. Har Krishan . . .	1661-1664
4. Ram Das . . .	1574-1581	9. Teg Bahadur . . .	1664-1675
5. Arjan . . .	1581-1606	10. Govind Singh . . .	1675-1708

Nanak, like Buddha, revolted against a religion overladen with ceremonial and social restrictions, and both rebelled against the tyranny of the priesthood. The tendency of each religion was to quietism, but their separate doctrines were largely influenced by the surroundings of their founders. Buddha lived in the centre of Hindu India and among the many gods of the Brahmans. These he rejected, he knew of nought else, and in his theological system there was found no place for divinity. Nanak was born in the province which then formed the borderland between Hinduism and Islam. He taught that there was one God; but that God was neither Allah nor Ram, but simply God; neither the special god of the Mahomedan, nor of the Hindu, but the God of the universe, of all mankind and of all religions. Starting from the unity of God, Nanak and his successors rejected the idols and incarnations of the Hindus, and on the ground of the equality of all men rejected also the system of caste. The doctrines of Sikhism as set forth in the *Granth* (*q.v.*) are that it prohibits idolatry, hypocrisy, class exclusiveness, the cremation of widows, the immurement of women, the use of wine and other intoxicants, tobacco-smoking, infanticide, slander and pilgrimages to the sacred rivers and tanks of the Hindus; and it inculcates loyalty, gratitude for all favours received, philanthropy, justice, impartiality, truth, honesty and all the moral and domestic virtues upheld by Christianity. Sikhism mainly differs from Christianity in that it inculcates the transmigration of the soul, and adopts a belief in predestination, which is universal in the East.

The Sikh religion did not reach this full development at once, nor was the first of the gurus even the first to feel dissatisfaction with the existing order of things. Ideas of revolt and reform of decadent systems are always in the air, and Precursors
of the
Gurus. may be for centuries, until some one man bolder than the rest stands out to give them free expression; and as John the Baptist preceded Jesus Christ, so Nanak was preceded by several reformers, whose writings are incorporated in the *Granth* itself. The chief of these reformers are Jaidev, Ramanand and Kabir. Jaidev is better known as the author of the *Gita-gobind*, which was translated by Sir Edwin Arnold, than as a religious reformer; but in the *Adi Granth* are found two hymns of his in the Prakrit language of the time, in which he represents God as distinct from nature, yet everywhere present. He taught at the end of the 12th century A.D. that the practice of *yog*, sacrifices and austerities was as nothing in comparison with the repetition of God's name, and he inculcated the worship of God alone, in thought, word and deed. What was worthy of worship, he said, he had worshipped; what was worthy of trust he had trusted; and he had become blended with God, as water blends with water.

Jaidev was succeeded by numerous Hindu saints, who perceived that the superstitions of the age only led to spiritual blindness. Of these saints Ramanand was one of the most distinguished. He lived at the end of the 14th and beginning of

the 15th centuries, and during a visit to Benares he renounced some of the social and caste observances of the Hindus, called his disciples the liberated, and freed them from all restrictions in eating and social intercourse. Kabir denounced idolatry and the ritualistic practices of the Hindus. He was born A.D. 1398, and according to the legend was the son of a virgin widow, as the result of a prayer offered for her by Ramanand in ignorance of her status. Thus it will be seen that the doctrines of these early reformers contained the germs of the later Sikh religion.

Nanak seems to have been produced by the same cyclic wave of reformation as fourteen years later gave Martin Luther to Europe. He taught, "There is but one God, the Creator, whose name is true, devoid of fear and enmity, immortal, unborn and self-existent, great and bountiful." He held that the wearing of religious garb, praying and practising penance to be seen of men, only produced hypocrisy, and that those who went on pilgrimages to sacred streams, though they might cleanse their bodies, only increased their mental impurity. He pointed out that God "before all temples prefers the upright heart and pure," and must be worshipped in spirit and in truth, and not with the idolatrous accessories of incense, sandal-wood and burnt-offerings. He abrogated caste distinctions, and taught in opposition to ancient writings that every man had the eternal right of searching for divine knowledge and worshipping his Creator. This doctrine of philosophic quietism was common to his successors, until in the time of the sixth guru, Har Govind, it was found necessary to support the separate existence of Sikhism by force of arms, and this led to the militant and political development of the tenth and most powerful of the gurus, Govind Singh. The Sikhs of to-day, though they all derive primarily from Nanak, are only recognized as Singhs or real Sikhs when they accept the doctrines and practices of Guru Govind Singh.

Nanak's successor, Angad, was born in A.D. 1504 and died in 1552. He also was a Khatri, and was chosen by Guru Nanak in preference to his own sons. The legend of his choice is that Nanak with his followers was going on a journey, when they saw the dead body of a man lying by the wayside. Nanak said, "Ye who trust in me eat of this food." All hesitated save Angad (or own body), who knelt and uncovered the dead, but, behold; the corpse had disappeared, and a dish of sacred food was found in its place. The guru embraced his faithful follower, saying that he was as himself, and that his spirit should dwell within him. Thenceforward the Sikhs believe the spirit of Nanak to have been incarnate in each succeeding guru. Little is known of the ministry of Angad except that he committed to writing much of what he had heard about Guru Nanak as well as some devotional observations of his own, which were afterwards incorporated in the *Granth*.

Angad, like his predecessor, postponed the claims of his own sons to the guruship to those of Amar Das, who had been his faithful servant. Amar Das preached the doctrine of forgiveness and endurance, upheld Guru Nanak's abrogation of caste distinctions, and his precepts were implicitly followed by his successors. He used to place all his Sikhs and visitors in rows and cause them to eat together, not separately, as is the practice of the Hindus. He said: "Let no one be proud of his caste, for this pride of caste resulteth in many sins. He is a Brahman who knoweth Brahma (God). Every one prateth of four castes. All are sprung from the seed of Brahm. The whole world is formed out of one clay, but the Potter hath fashioned it in various forms." It was a maxim of the Sikhs of his time: "If any one treat you ill, bear it. If you bear it three times God himself will fight for you and humble your enemies." Guru Amar Das also discountenanced the practice of suttee, saying: "They are not *satis* who burn themselves with the dead. The true *sati* is she who dieth from the shock of separation from her husband. They also ought to be considered *satis* who abide in charity and contentment, who serve and, when rising, ever remember their lord." Amar Das was born in A.D. 1509 and died in 1574 after a ministry of twenty-two and a half years.

The fourth guru, originally called Jetha, was attracted to the third guru by his reputation for sanctity. He became the servant of Amar Das, helped in the public kitchen, shampooed his master, drew water, brought firewood from the forest, and helped in the excavation of a well which Amar Das was constructing at Goindwal. Jetha was of such a mild temper that, even if any one spoke harshly to him, he would endure it and never retaliate. He became known as Ram Das, which means God's slave; and on account of his piety and devotion Amar Das gave him his daughter in marriage and made him his successor. Ram Das is amongst the most revered of gurus, but no particular innovation is ascribed to him. He founded, however, the golden temple of Amritsar in A.D. 1577, which has remained ever since the centre of the Sikh religious worship. From this time onward the office of guru became hereditary, but the practice of primogeniture was not followed, each guru selecting the relative who seemed most fitted to succeed him.

Ram Das himself, finding his eldest son Prithi Chand worldly and disobedient, and his second unfitted by his too retiring disposition for the duties of guru, appointed his third son, Arjan, to succeed him. When Prithi Chand represented that he ought to have received the turban bound on Guru Arjan's head in token of succession to his father, Arjan meekly handed it to him, without, however, bestowing on him the guruship. The Sikhs themselves soon revolted against the exactions of Prithi Chand, and prayed Arjan to assert himself else the seed of the True Name would perish. It was Guru Arjan who compiled the *Granth* or Sikh Bible, out of his own and his predecessors' compositions. On this account he was accused of deposing the deities of his country and substituting for them a new divinity, but he was acquitted by the tolerant Akbar. When Akbar, however, was succeeded by Jahangir the guru aided the latter's son Khusru to escape with a gift of money. On this account his property was confiscated to the state, and he was thrown into rigorous imprisonment and tortured to death. Arjan saw clearly that it was impossible to preserve his sect without force of arms, and one of his last injunctions to his son Har Govind was to sit fully armed on his throne and maintain an army to the best of his ability. This was the turning-point in the history of the Sikhs. Hitherto they had been merely an insignificant religious sect; now, stimulated by persecution, they became a militant and political power, inimical to the Mahomedan rulers of the country.

When Har Govind was installed as guru, Bhai Budha, the aged Sikh who performed the ceremony, presented him with a turban and a necklace, and charged him to wear and preserve them as the founder of his religion had done. Guru Har Govind promptly ordered that the articles should be relegated to his treasury, the museum of the period. He said: "My necklace shall be my sword-belt, and my turban shall be adorned with a royal aigrette." He then sent for his bow, quiver, arrows, shield and sword, and arrayed himself in martial style, so that, as the Sikh chronicler states, his splendour shone like the sun.

The first four gurus led simple ascetic lives and were regardless of worldly affairs. Guru Arjan, who was in charge of the great Sikh temple at Amritsar, received copious offerings and became a man of wealth and influence, while the sixth guru became a military leader, and was frequently at warfare with the Mogul authorities. Several warriors and wrestlers, hearing of Guru Har Govind's fame, came to him for service. He enrolled as his body-guard fifty-two heroes who burned for the fray. This formed the nucleus of his future army. Five hundred youths then came to him for enlistment from the Manjha, Doab and Malwa districts. These men told him that they had no offering to make to him except their lives; for pay they only required instruction in his religion; and they professed themselves ready to die in his service. The guru gave them each a horse and five weapons of war, and gladly enlisted them in his army. In a short time, besides men who required regular pay, hordes gathered round the guru who were satisfied with two meals a day and a suit of clothes every six months. The fighting spirit of the people

**Guru
Nanak.**

**Guru
Ram Das.**

**Guru
Arjan.**

**Guru
Angad.**

**Guru Har
Govind.**

**Guru
Amar Das.**

was roused and satisfied by the spiritual and military leader. Har Govind was a hunter and eater of flesh, and encouraged his followers to eat meat as giving them strength and daring. It is largely to this practice that the Sikhs owe the superiority of their physique over their surrounding Hindu neighbours. The regal state that the guru adopted and the army that he maintained were duly reported to the emperor Jahangir.

In the *Autobiography of Jahangir* it is stated that the guru was imprisoned in the fortress of Gwalior, with a view to the realization of the fine imposed on his father Guru Arjan, but the Sikhs believe that the guru became a voluntary inmate of the fortress with the object of obtaining seclusion there to pray for the emperor who had been advised to that effect by his Hindu astrologers. After a time Jahangir died and was succeeded by Shah Jahan, with whom the guru was constantly at war. On three separate occasions after desperate fighting he defeated the royal troops sent against him. Many legends are told of his military prowess, for which there is no space in this summary. The guru before his death at Kiratpur, on the margin of the Sutlej, instructed his grandson and successor, Guru Har Rai, to retain two thousand two hundred mounted soldiers ever with him as a precautionary measure.

Har Rai was charged with friendship for Dara Shikoh, the son of Shah Jahan, and also with preaching a religion distinct from Islam. He was, therefore, summoned to Delhi, but instead of going himself he sent his son Ram Rai and shortly afterwards died. His ministry was mild but won him general respect.

The eighth guru was the second son of Har Rai, but he died when a child and too young to leave any mark on history. His elder brother Ram Rai was passed over in his favour and also in favour of the next guru for having altered a line of the *Granth* to please the emperor Aurangzeb.

As the direct line of succession died out with Har Krishan, the guruship harked back at this point to Teg Bahadur, the second son of Har Govind and uncle of Har Rai. Teg Bahadur was put to death for refusal to embrace Islam by Aurangzeb in A.D. 1675. It is of him that the legend is told that during his imprisonment in Delhi he was accused by the emperor of looking towards the west in the direction of the imperial zenana. The guru replied, "Emperor Aurangzeb, I was on the top storey of my prison, but I was not looking at thy private apartments or at thy queen's. I was looking in the direction of the Europeans who are coming from beyond the seas to tear down thy purdahs and destroy thine empire." This prophecy became the battle-cry of the Sikhs in the assault on Delhi in 1857.

Teg Bahadur was succeeded by the tenth and most powerful guru, his son Govind Singh; and it was under him that what had sprung into existence as a quietist sect of a purely religious nature, and had become a military society for self-protection, developed into a national movement which was to rule the whole of north-western India and to furnish to the British arms their stoutest and most worthy opponents. For some years after his father's execution Govind Singh, then known as Gobind Rai, lived in retirement, brooding over the wrongs of his people and the persecutions of the fanatical Aurangzeb. He felt the necessity for a larger following and a stronger organization, and following the example of his Mahomedan enemies used his religion as the basis of political power. Emerging from his retirement he preached the Khalsa, the "pure," and it is by this name his followers are now known. He, like his predecessors, openly attacked all distinctions of caste, and taught the equality of all men who would join him, and he instituted a ceremony of initiation with baptismal holy water by which all might enter the Sikh fraternity.

The higher castes murmured, and many of them left him, for he taught that the Brahmanical threads must be broken; but the lower orders rejoiced and flocked in numbers to his standard. These he inspired with military ardour in the hope of social freedom and of national independence. He gave them outward

signs of their faith in the five K's—which will subsequently be explained—he signified the military nature of their calling by the title of "singh" or "lion" and by the wearing of steel, and he strictly prohibited the use of tobacco. The following are the main points of his teaching: Sikhs must have one form of initiation, sprinkling of water by five of the faithful; they should worship the one invisible God and honour the memory of Guru Nanak and his successors; their watchword should be, "*Sri wah guru ji ka khalsa, sri wah guru ji ki fatah*" (Khalsa of God, victory to God!), but they should revere and bow to nought visible save the *Granth Sahib*, the book of their belief; they should occasionally bathe in the sacred tank of Amritsar; their locks should remain unshorn; and they should name themselves singhs or lions. Arms should dignify their person; they should ever practise their use; and great would be the merit of those who fought in the van, who slew the enemies of their faith, and who despaired not although overpowered by superior numbers.

The religious creed of Guru Govind Singh was the same as that of Guru Nanak: the God, the guru and the *Granth* remained unchanged. But while Nanak had substituted holiness of life for vain ceremonial, Guru Govind Singh demanded in addition brave deeds and zealous devotion to the Sikh cause as proof of faith; and while he retained his predecessors' attitude towards the Hindu gods and worship he preached undying hatred to the persecutors of his religion.

During the spiritual reign of Guru Govind Singh the religious was partially eclipsed by the military spirit. The Mahomedans promptly responded to the challenge, for the danger was too serious to be neglected; the Sikh army was dispersed and two of Guru Govind Singh's sons were murdered at Sirhind by the governor of that fortress, and his mother died of grief at the cruel death of her grandchildren. The death of the emperor Aurangzeb brought a temporary lull: the guru assisted Aurangzeb's successor, Bahadur Shah, and was himself not long after assassinated at Nander in the Deccan. As all the guru's sons predeceased him, and as he was disappointed in his envoy Banda, he left no human successor, but vested the guruship in the *Granth Sahib* and his sect. No formal alteration has been made in the Sikh religion since Guru Govind Singh gave it his military organization, but certain modifications have taken place as the result of time and contact with Hinduism. After the guru's death the gradual rise of the Sikhs into the ruling power of northern India until they came in collision with the British arms belongs to the secular history of the Punjab (*q.v.*).

The chief ceremony initiated by Guru Govind Singh was the Khanda ka Pahul or baptism by the sword. This baptism may not be conferred until the candidate has reached an age of discrimination and capacity to remember obligations, seven years being fixed as the earliest age, but it is generally deferred until manhood. Five of the initiated must be present, all of whom should be learned in the faith. An Indian sweetmeat is stirred up in water with a two-edged sword and the novice repeats after the officiant the articles of his faith. Some of the water is sprinkled on him five times, and he drinks of it five times from the palms of his hands; he then pronounces the Sikh watchword given above and promises adherence to the new obligations he has contracted. He must from that date wear the five K's and add the word singh to his original name. The five K's are (1) the *kes* or uncut hair of the whole body, (2) the *kachh* or short drawers ending above the knee, (3) the *kara* or iron bangle, (4) the *khanda* or small steel dagger, (5) the *khanga* or comb. The five K's and the other esoteric observances of the Sikhs mostly had a utilitarian purpose. When fighting was a part of the Sikh's duty, long hair and iron rings concealed in it protected his head from sword cuts. The *kachh* or drawers fastened by a waist-band was more convenient and suitable for warriors than the insecurely tied *dhoti* of the Hindus or the *tamba* of the Mahomedans. So also the Sikh's physical strength was increased by the use of meat and avoidance of tobacco. Another Sikh ceremony is the *kara parshad* or communion made of butter, flour and sugar, and consecrated with certain ceremonies. The communicants sit round, and the *kara*

Guru Har Rai.

Guru Har Krishan.

Guru Teg Bahadur.

Guru Govind Singh.

Sikh ceremonies.

parshad is then distributed equally to all the faithful present, no matter to what caste they belong. The object of this ceremony is to abolish caste distinctions.

There may be said to be three degrees of strictness in the observances of the Sikhs. There may first be mentioned the zealots such as the Akalis, who, though generally quite illiterate, aim at observing the injunctions of Guru Govind Singh; secondly, the true Sikhs or Singhs who observe his ordinances, such as the prohibitions of cutting the hair and the use of tobacco; and, thirdly, those Sikhs who while professing devotion to the tenets of the gurus are almost indistinguishable from ordinary Hindus. These are largely Nanakpanti Sikhs, or followers only of Guru Nanak. The Nanakpanti Sikhs do not wear the hair long, nor use any of the outward signs of the Sikhs, though they reverence the *Granth Schib* and above all the memory of their guru. They are distinguished from the Hindus by no outward sign except a slight laxity in the matter of caste observances.

Sikhism attained its zenith under the military genius of Ranjit Singh. After the British conquest of the Punjab the military spirit of the Sikhs remained for some time in abeyance. Then came the mutiny, and Sikhs once more were recruited in numbers and saved India for the British crown. Peace returned, and during the next twenty or twenty-five years Sikhism reached its lowest ebb; but since then the demand for Sikhs in the regiments of the Indian army and farther afield has largely revived the faith. The establishment of Singh Sabhas, of Sikh newspapers, and the spread of education have largely tended in the same direction, but the strict ethical code of Sikhism and the number of its obligatory divine services have caused many to fall away from the faith: nor does the austere Sikh ritual appeal to women, who generally prefer Hinduism with its picturesque material worship and the brightness of its innumerable festivals. At the present day the stronghold of Sikhism still remains the great Phulkian states of Patiala, Nabha and Jind and the surrounding districts of Ludhiana, Lahore, Amritsar, Jullundur and Gujranwala. In these states and districts are recruited the soldiers who form one of the main bulwarks of the British empire in India.

For authorities see Cunningham, *History of the Sikhs*; Sir Lepel Griffin, *Maharaja Ranjit Singh* ("Rulers of India" series, 1892); Falcon, *Handbook on Sikhs*; and specially M. Macauliffe, *The Sikh Religion: Its Gurus, Sacred Writings and Authors* (6 vols.; 1909), and two lectures before the United Service Institution of India on "The Sikh Religion and its Advantages to the State" and "How the Sikhs became a Militant Race." (M. M.)

SIKH WARS, two Indian campaigns fought between the Sikhs and the British, which resulted in the conquest and annexation of the Punjab (see PUNJAB).

First Sikh War (1845-46).—The first Sikh War was brought about by the insubordination of the Sikh army, which after the death of Ranjit Singh became uncontrollable and on the 11th of December 1845 crossed the Sutlej, and virtually declared war upon the British. The British authorities had foreseen the outbreak, and had massed sufficient troops at Ferozapore, Ludhiana and Umballa to protect the frontier, but not to offer provocation. So complete were the preparations for advance that on the 12th, the day after the Sikhs crossed the Sutlej, Sir Hugh Gough, the commander-in-chief, marched 16 m. with the Umballa force to Rajpura; on the 13th the governor-general, Sir Henry Hardinge, declared war, and by the 18th the whole army had marched 150 m. to Moodkee, in order to protect Ferozapore from the Sikh attack.

Wearied with their long march, the British troops were enjoying a rest, when the news came in that the Sikhs were advancing to battle at four o'clock in the afternoon. The British had some 10,000 men, and the Sikhs are estimated by some authorities as low as 10,000 infantry with 2000 cavalry and 22 guns. The battle opened with an artillery duel, in which the British guns, though inferior in weight, soon silenced the enemy, the 3rd Light Dragoons delivered a brilliant charge, and the infantry drove the enemy from position after position with great slaughter and the loss of seventeen guns.

The victory was complete, but the fall of night prevented it from being followed up, and caused some of the native regiments to fire into each other in the confusion.

After the battle of Moodkee Sir Henry Hardinge volunteered to serve as second in command under Sir Hugh Gough, a step which caused some confusion in the ensuing battle. At 4 A.M. on the 21st of December the British advanced from Moodkee to attack the Sikh entrenched camp under the command of Lal Singh at Ferozeshah, orders having been sent to Sir John Littler, in command at Ferozapore, to join the main British force. At 11 A.M. the British were in front of the Sikh position, but Sir John Littler, though on his way, had not yet arrived. Sir Hugh Gough wished to attack while there was plenty of daylight; but Sir Henry Hardinge reasserted his civil authority as governor-general, and forbade the attack until the junction with Littler was effected. The army then marched on to meet Littler and the battle did not begin until between 3.30 and 4 P.M. The engagement opened with an artillery duel, in which the British again failed to gain the mastery over the Sikhs. The infantry, therefore, advanced to the attack; but the Sikh muskets were as good as the British, and fighting behind entrenchments they were a most formidable foe. Sir John Littler's attack was repulsed, the 62nd regiment losing heavily in officers and men, while the sepoys failed to support the European regiments. But the Moodkee force, undaunted, stormed and captured the entrenchment, though the different brigades and regiments lost position and became mixed up together in the darkness. The army then passed the night on the Sikh position, while the Sikhs prowled round keeping up an incessant fire. In the morning the British found that they had captured seventy-three pieces of cannon and were masters of the whole field; but at that moment a fresh Sikh army, under Tej Singh, came up to the assistance of the scattered forces of Lal Singh. The British were exhausted with their sleepless night, the native troops were shaken, and a determined attack by this fresh army might have won the day; but Tej Singh, after a half-hearted attack, which was repulsed, marched away, whether from cowardice, incapacity or treason, and left the British masters of the position.

After the battle of Ferozeshah the Sikhs retired behind the Sutlej, but early in January they again raided across the river near Ludhiana, and Sir Harry Smith was detached to protect that city. On the 21st of January he was approaching Ludhiana when he found the Sikhs under Runjoo Singh in an entrenched position flanking his line of march at Budhawal. Sir Harry Smith passed on without fighting a general action, but suffered considerable loss in men and baggage. After receiving reinforcements Sir Harry again advanced from Ludhiana and attacked the Sikhs at Aliwal on the 28th of January. An attack upon the Sikh left near the village of Aliwal gave Sir Harry the key of the position, and a brilliant charge by the 16th Lancers, which broke a Sikh square, completed their demoralization. The Sikhs fled in confusion, losing sixty-seven guns, and by this battle were expelled from the south side of the Sutlej.

Ever since Ferozeshah Sir Hugh Gough had been waiting to receive reinforcements, and on the 7th of February his siege train arrived, while on the following day Sir Harry Smith's force returned to camp. On the 10th of February Sir Hugh attacked the Sikhs, who occupied a strong entrenched position in a bend of the Sutlej. After two hours' cannonading, the infantry attack commenced at 9 A.M. The advance of the first brigade was not immediately successful, but the second brigade following on carried the entrenchments. The cavalry then charged down the Sikh lines from right to left and completed the victory. The Sikhs, with the river behind them, suffered terrible carnage, and are computed to have lost 10,000 men and 67 guns. The British losses throughout the campaign were considerably heavier than was usual in Indian warfare; but this was partly due to the fact that the Sikhs were the best natural fighters in India, and partly to the lack of energy of the Hindostani sepoys. After the battle of Sobraon

Ferozeshah.

Aliwal.

Sobraon.

the British advanced to Lahore, where the treaty of Lahore was signed on the 11th of March.

Second Sikh War (1848-1849).—For two years after the battle of Sobraon the Punjab remained a British protectorate, with Sir Henry Lawrence as resident; but the Sikhs were unconvinced of their military inferiority, the Rani Jindan and her ministers were constantly intriguing to recover their power, and a further trial of strength was inevitable. The outbreak came at Multan, where on the 20th of April 1848 the troops of the Dewan Mulraj broke out and attacked two British officers, Mr Vans Agnew and Lieutenant Anderson, eventually murdering them. On hearing of the incident, Lieut. Herbert Edwardes, who was Sir Henry Lawrence's assistant in the Derajat, advanced upon Multan with a force of levies drawn from the Pathan tribes of the frontier; but he was not strong enough to do more than keep the enemy in check until Multan was invested by a Bombay column under General Whish. In the meantime Edwardes wished for an immediate British advance upon Multan; but Lord Gough, as he had now become, decided on a cold season campaign, on the ground that, if the Sikh government at Lahore joined in the rising, the British would require all their available strength to suppress it. Multan was invested on the 18th of August by General Whish in conjunction with the Sikh general Shere Singh; but during the course of the siege Shere Singh deserted and joined the rebels, thus turning the rising into a national war. The siege of Multan was temporarily abandoned, but was resumed in November, when Lord Gough's main advance had begun, and Mulraj surrendered on the 22nd of January. In the meantime Lord Gough had collected his army and stores, and on the 9th of November crossed the Sutlej.

On the 22nd of November there was a cavalry skirmish at Ramnagar, in which General Cureton and Colonel Havelock were killed. For a month after this Lord Gough remained inactive, waiting to be reinforced by General Whish from Multan; but at last he decided to advance without General Whish, and fought the battle of Chillianwalla on the 13th of January 1849. Lord Gough had intended to encamp for the night; but the Sikh guns opening fire revealed the fact that their army had advanced out of its intrenchments, and Lord Gough decided to seize the opportunity and attack at once. An hour's artillery duel showed that the Sikhs had the advantage both in position and guns, and the infantry advance commenced at three o'clock in the afternoon. The battle resulted in great loss to the European regiments, the 24th losing all its officers in a few minutes, while the total loss in killed and wounded amounted to 2338; but when darkness fell the British were in possession of the whole of the Sikh line. Lord Gough subsequently retired to the village of Chillianwalla, and the Sikhs returned and carried off their guns. After the battle Lord Gough received an ovation from his troops, but his losses were thought excessive by the public in England and the directors of the East India Company, and Sir Charles Napier was appointed to supersede him. Before, however, the latter had time to reach India, the crowning victory of Gujrat had been fought and won.

After the fall of Multan General Whish marched to join Lord Gough, and the junction of the two armies was effected on the 18th of February. In the meantime the Sikhs had withdrawn from their strong intrenchments at Russool, owing to want of provisions, and marched to Gujrat, which Lord Gough considered a favourable position for attacking them. By a series of short marches he prepared the way for his "last and best battle." In this engagement, for the first time in either of the Sikh wars, the British had the superiority in artillery, in addition to a picked force of 24,000 men. The battle began on the morning of the 21st of February with two and a half hours' artillery fire, which was overwhelmingly in favour of the British. At 11.30 A.M. Lord Gough ordered a general advance covered by the artillery; and an hour and a half later the British were in possession of the town of Gujrat, of the Sikh camp, and of the enemy's artillery and baggage, and the cavalry were in full pursuit on both flanks. In this battle the British only lost 96 killed and 700 wounded, while the Sikh loss was enormous, in

addition to 67 guns. This decisive victory ended the war. On the 12th of March the Sikh leaders surrendered at discretion, and the Punjab was annexed to British India.

See Sir Charles Gough and A. D. Innes, *The Sikhs and the Sikh Wars* (1897); and R. S. Rait, *Life and Campaigns of Viscount Gough* (1903).

SIKKIM, called by Tibetans *Dejong* ("the rice country"), a protected state of India, situated in the eastern Himalaya, between 27° 5' and 28° 9' N. and between 87° 59' and 88° 56' E. It comprises an area of 2818 sq. m. of what may be briefly described as the catchment basin of the headwaters of the rivers Tista and Rangit. On the S. and S.E., branches of these rivers form the boundary between Sikkim and British India, while on the W., N. and N.E. Sikkim is separated from Nepal, Tibet and Bhutan by the range of lofty mountains which culminate in Kinchinjunga and form a kind of horse-shoe, whence dependent spurs project southwards, gradually contracting and lessening in height until they reach the junction of the Rangit and the Tista. Thus the country is split up into a succession of deep valleys surmounted by open plateaus cut off from one another by high and steep ridges, and lies at a very considerable elevation, rising from 1000 ft. above sea-level at its southern extremity to 16,000 or 18,000 ft. on the north. The main trade-passes into Tibet, such as the Jelep (14,500), Chola (14,550), and Kangra-la (16,000), are not nearly so high as in the western Himalaya, while those into Nepal are less than 12,000 ft.

Physical Features.—Small though the country is, a wide variation of climate makes it peculiarly interesting. From a naturalist's point of view it can be divided into three zones. The lowest, stretching from 1000 to 5000 ft. above sea-level, may be called the tropical zone; thence to 13,000 ft., the upper limit of tree vegetation, the temperate; and above, to the line of perpetual snow, the alpine. Down to about 1880 Sikkim was covered with dense forests, only interrupted where village clearances had bared the slopes for agriculture, but at the present time this description does not apply below 6000 ft., the upper limit at which maize ripens; for here, owing to increase of population (particularly the immigration of Nepalese settlers), almost every suitable spot has been cleared for cultivation. The exuberance of its flora may be imagined when it is considered that the total flowering plants comprise some 4000 species; there are more than 200 different kinds of ferns, 400 orchids, 20 bamboos, 30 rhododendrons, 30 to 40 primulas, and many other genera are equally profuse; in fact Sikkim contains types of every flora from the tropics to the poles, and probably no other country of equal or larger extent can present such infinite variety. Butterflies abound and comprise about 600 species, while moths are estimated at 2000. Birds are profusely represented, numbering between 500 and 600 species. Among mammals, the most interesting are the snow leopard (*Felis unica*), the cat-bear (*Aelurus fulgens*), the musk deer (*Moschus moschiferus*) and two species of goat antelope (*Nemorhaedus bubalinus* and *Cemas goral*). Copper and lime are the chief minerals found and worked in Sikkim, but they are of little commercial value at present.

Government and Population.—The population is essentially agricultural, each family living in a house on its own land: there are no towns or villages, and the only collection of houses, outside the Lachen and Lachung valleys, are the few that have sprung up round country market-places, such as Rhenock, Dikelling and Gangtok; but in the above-mentioned valleys the inhabitants, who are Bhutanese in origin and herdsmen in occupation, have large clusters of well-built houses at various altitudes up the valleys, which they occupy in rotation according to the season of the year.

The seat of government, or in other words the palace of the raja, was formerly situated at Rubdentze; but when that place was taken and destroyed by the Gurkhas, a new palace was built at Tumlong, close to the eastern and Tibetan boundary, while a subsidiary summer residence was erected on the other side of the Chola range at Chumbi, in the Am-mochu valley. At the present time the raja and his court remain in the more open country at Gangtok, where the British political officer and a small detachment of native troops are also stationed.

The first regular census of Sikkim, in 1901, returned the population at 59,014, showing an apparent increase of nearly twofold in the decade. Of the total, 65% were Hindus and 35% Buddhists. The Lepchas, supposed to be the original inhabitants, numbered only 8000, while no less than 23,000 were immigrants from Nepal.

The state religion is Buddhism as practised in Tibet, but is not confined to one particular sect; while among the heterogeneous population of Sikkim all manner of religious cults can be found. Education is at a low ebb, though the monasteries are supposed to maintain schools, and missionary enterprise has established others.

The revenue of Sikkim has increased under British guidance from Rs. 20,000 a year to nearly Rs. 1,60,000, derived chiefly from a land and poll tax, excise, and sale of timber; the chief expenditure is on

the maintenance of the state, which practically means the raja's family, and on the improvement of communications. The country has a complete system of mountain roads, bridged and open to animal (but not cart) traffic. British trade with Central Tibet is carried over the Jelep route, on the south-eastern border of Sikkim.

History.—The earliest inhabitants of Sikkim were the Rong-pa (ravine folk), better known as Lepchas, probably a tribe of Indo-Chinese origin; but when or how they migrated to Sikkim is unknown. The reigning family, however, is Tibetan, and claims descent from one of the Gyalpos or princelings of eastern Chinese Tibet; their ancestors in course of several generations found their way westwards to Lhasa and Sakya, and thence down the Am-mochu valley; finally, about the year 1604, Penchoo Namgyé was born at Gangtok, and in 1641, with the aid of Lha-tsan Lama and two other priests of the Duk-pa or Red-hat sect of Tibet, overcame the Lepcha chiefs, who had been warring among themselves, established a firm government and introduced Buddhist Lamaism as a state religion. His son, Tensung Namgyé, very largely extended his kingdom, but much of it was lost in the succeeding reign of Chak-dor Namgyé (1700-1717), who is credited with having designed the alphabet now in use among the Lepchas.

In the beginning of the 18th century Bhutan appropriated a large tract of country on the east. Between 1776 and 1792 Sikkim was constantly at war with the victorious Gurkhas, who were, however, driven out of part of their conquests by the Chinese in 1792; but it was not until 1816 that the bulk of what is known to us as Sikkim was restored by the British, after the defeat of the Nepalese by General Ochterlony. In 1839 the site of Darjeeling was ceded by the raja of Sikkim. In 1849 the British resumed the whole of the plains (Tarai) and the outer hills, as punishment for repeated insults and injuries. In 1861 a British force was required to impose a treaty defining good relations. The raja, however, refused to carry out his obligations and defiantly persisted in living in Tibet; his administration was neglected, his subjects oppressed, and a force of Tibetan soldiers was allowed, and even encouraged, to seize the road and erect a fort within sight of Darjeeling. After months of useless remonstrance, the government was forced in 1888 to send an expedition, which drove the Tibetans back over the Jelep pass. A convention was then concluded with China in 1890, whereby the British protectorate over Sikkim was acknowledged and the boundary of the state defined; to this was added a supplemental agreement relating to trade and domestic matters, which was signed in 1893. Since that time the government has been conducted by the maharaja assisted by a council of seven or eight of his leading subjects, and guided by a resident British officer. Crime, of which there is little, is punished under local laws administered by kazis or petty chiefs. Since 1904 political relations with Sikkim, which had formerly been conducted by the lieutenant-governor of Bengal, have been in the hands of the Viceroy.

Rajas of Sikkim (Dejong-Gyalpo): Penchoo Namgyé (1641-1670), Tensung Namgyé (1670-1700), Chak-dor Namgyé (1700-1717), Gyur-mé Namgyé (1717-1734), Penchoo Namgyé (1734-1780), Tenzing Namgyé (1780-1790), Cho-phoe Namgyé (1790-1861), Sikhyong Namgyé (1861-1874), Tho-tub Namgyé (1874), the maharaja, whose son has been educated at Oxford.

AUTHORITIES.—Sir J. W. Edgar, *Report on a Visit to Sikkim and the Tibetan Frontier in 1873* (Calcutta, 1874); Macaulay, *Report on a Mission to Sikkim and the Tibetan Frontier* (Calcutta, 1885); *The Gazetteer of Sikkim* (Calcutta, 1894); Hooker, *Himalayan Journals* (London, 1854); L. A. Waddell, *Lamaism* (London, 1895); *Among the Himalayas* (London, 1898). (A. W. P.)

SILA, a mountainous forest district of Calabria, Italy, to the E. of Cosenza, extending for some 37 m. N. to S. and 25 m. E. to W. The name goes back to the Greek period, and then probably belonged to a larger extension of territory than at present. In ancient times these mountains supplied timber to the Greeks for shipbuilding, the forests have given way to pastures to some extent; but a part of them, which belongs to the state, is maintained. Geologically these mountains, which consist of granite, gneiss and mica schist, are the oldest portion of the Italian peninsula; their culminating point is the Botte Donato (6330 ft.), and they are not free of snow until the late spring. They are very rarely explored by travellers.

SILANION, a Greek sculptor of the 4th century B.C. He was noted as a portrait-sculptor. Of two of his works, his heads of Plato and of Sappho, we possess what seem to be copies. Both are of simple ideal type, the latter of course not strictly a portrait, since Sappho lived before the age of portraits. The best copy of the Plato is in the Vatican.

SILAS (fl. A.D. 50), early Christian prophet and missionary, was the companion of St Paul on the second journey, when he took the place formerly held by Barnabas. The tour included S. Galatia, Troas, Philippi (where he was imprisoned), Thessalonica and Beroea, where Silas was left with Timothy, though

he afterwards rejoined Paul at Corinth. He is in all probability the Silvanus¹ who is associated with Paul in the letters to the Thessalonians, mentioned again in 2 Cor. i. 19, and the bearer and amanuensis of 1 Peter (see v. 12). It is possible, indeed, that he has an even closer connexion with this letter, and some scholars (e.g. R. Scott in *The Pauline Epistles*, 1909) are inclined to give him a prominent place among the writers of the New Testament. He was of Jewish birth and probably also a Roman citizen.

SILAY, a town of the province of Negros Occidental, island of Negros, Philippine Islands, on the N.W. coast, about 10 m. N. of Bacolod, the capital of the province. Pop. (1903, after the annexation of Guimbalon and a portion of Eustaquio Lopez) 22,000. There are more than fifty barrios or villages in the town and the largest of these had, in 1903, 3834 inhabitants. The language is Visayan. There is a considerable coasting trade, sugar, brought by a tramway from neighbouring towns, is shipped from here, and the cultivation of sugar-cane is an important industry; Indian corn, tobacco, hemp, cotton and cacao are also grown.

SILCHAR, a town of British India, in the Cachar district of Eastern Bengal and Assam, of which it is the headquarters. Pop. (1901) 9256. It is situated on the left bank of the river Barak, with a station on the Assam-Bengal railway, 271 m. N. of Chittagong. Silchar is the centre of an important tea industry, and the headquarters of the volunteer corps known as the Surma Valley Light Horse.

SILCHESTER, a parish in the north of Hampshire, England, about 10 m. S. of Reading, containing the site of the Romano-British town Calleva Atrebatum. This site has been lately explored (1890-1909) and the whole plan of the ancient town within the walls recovered; unfortunately the excavators had to abandon their task before the suburbs, cemeteries and whatever else may lie outside the walls have been examined. The results are published in *Archaeologia*, the official organ of the London Society of Antiquaries (see BRITAIN: *Roman*). As the excavations proceeded, the areas excavated were covered in again, but the ruins of the town hall, which have been famous since the 12th century, still remain. The smaller and movable objects found in the excavations have been deposited by the duke of Wellington, owner of the site of Calleva, in the Reading museum.

SILENUS, a primitive Phrygian deity of woods and springs. As the reputed inventor of music he was confounded with Marsyas. He also possessed the gift of prophecy, but, like Proteus, would only impart information on compulsion; when surprised in a drunken sleep, he could be bound with chains of flowers, and forced to prophesy and sing (Virgil, *Ecl.* vi., where he gives an account of the creation of the world; cf. Aelian, *Var. hist.* iii. 18). In Greek mythology he is the son of Hermes (or Pan) and a nymph. He is the constant companion of Dionysus, whom he was said to have instructed in the cultivation of the vine and the keeping of bees. He fought by his side in the war against the giants and was his companion in his travels and adventures. The story of Silenus was often the subject of Athenian satyric drama. Just as there were supposed to be several Pans and Fauns, so there were many Silenuses, whose father was called Papposilenus ("Daddy Silenus"), represented as completely covered with hair and more animal in appearance. The usual attributes of Silenus were the wine-skin (from which he is inseparable), a crown of ivy, the Bacchic thyrsus, the ass, and sometimes the panther. In art he generally appears as a little pot-bellied old man, with a snub nose and a bald head, riding on an ass and supported by satyrs; or he is depicted lying asleep on his wine-skin, which he sometimes bestrides. A more dignified type is the Vatican statue of Silenus carrying the infant Dionysus, and the marble group from the villa Borghese in the Louvre.

See Preller-Robert, *Griechische Mythologie* (1894), pp. 729-735; Talfourd Ely, "A Cyprian Terracotta," in the *Archaeological Journal* (1896); A. Baumeister, *Denkmäler des klassischen Altertums*, iii. (1888).

¹ For the abbreviation, cf. Lucas, Prisca (=Priscilla), Sopater (=Sospater).

SILESIA, the name of a district in the east of Europe, the greater part of which is included in the German empire and is known as German Silesia. A smaller part, called Austrian Silesia, is included in the empire of Austria-Hungary.

German Silesia.

German Silesia is bounded by Brandenburg, Posen, Russian Poland, Galicia, Austrian Silesia, Moravia, Bohemia and the kingdom and province of Saxony. Besides the bulk of the old duchy of Silesia, it comprises the countship of Glatz, a fragment of the Neumark, and part of Upper Lusatia, taken from the kingdom of Saxony in 1815. The province, which has an area of 15,576 sq. m. and is the largest in Prussia, is divided into three governmental districts, those of Liegnitz and Breslau comprising lower Silesia, and of Oppeln taking in the greater part of mountainous Silesia.

Physiographically Silesia is roughly divided into a flat and a hilly portion by the so-called Silesian Langental, which begins on the south-east near the river Malapanca, and extends across the province in a west-by-north direction to the Black Elster, following in part the valley of the Oder. The south-east part of the province, to the east of the Oder and south of the Malapanca, consists of a hilly outpost of the Carpathians, the Tarnowitz plateau, with a mean elevation of about 1000 ft. To the west of the Oder the land rises gradually from the Langental towards the southern boundary of the province, which is formed by the central part of the Sudetic system, including the Glatz Mountains and the Riesengebirge (Schneekoppe, 5260 ft.). Among the loftier elevations in advance of this southern barrier the most conspicuous is the Zobten (2356 ft.). To the north and north-east of the Oder the province belongs almost entirely to the great North-German plain, though a hilly ridge, rarely attaining a height of 1000 ft., may be traced from east to west, asserting itself most definitely in the Katzengebirge. Nearly the whole of Silesia lies within the basin of the Oder, which flows through it from south-east to north-west, dividing the province into two approximately equal parts. The Vistula touches the province on the south-east, and receives a few small tributaries from it, while on the west the Spree and Black Elster belong to the system of the Elbe. The Iser rises among the mountains on the south. Among the chief feeders of the Oder are the Malapanca, the Glatzer Neisse, the Katzbach and the Bartsch; the Bober and Queiss flow through Silesia, but join the Oder beyond the frontier. The only lake of any extent is the Schlawa See, 7 m. long, on the north frontier; and the only navigable canal, the Klodnitz canal, in the mining district of upper Silesia. There is a considerable difference in the climate of Lower and Upper Silesia; some of the villages in the Riesengebirge have the lowest mean temperature of any inhabited place in Prussia (below 40° F.).

Of the total area of the province 56% is occupied by arable land, 10.2% by pasture and meadow, and nearly 29% by forests. The soil along the foot of the mountains is generally good, and the district between Ratibor and Liegnitz, where 70 to 80% of the surface is under the plough, is reckoned one of the most fertile in Germany. The parts of lower Silesia adjoining Brandenburg, and also the district to the east of the Oder, are sandy and comparatively unproductive. The different cereals are all grown with success, wheat and rye sometimes in quantity enough for exportation. Flax is still a frequent crop in the hilly districts, and sugar-beets are raised over large areas. Tobacco, oil-seeds, chicory and hops may also be specified, while a little wine, of an inferior quality, is produced near Grünberg. Mulberry trees for silk-culture have been introduced and thrive fairly. Large estates are the rule in Silesia, where about a third of the land is in the hands of owners possessing at least 250 acres, while properties of 50,000 to 100,000 acres are common. The districts of Oppeln and Liegnitz are among the most richly wooded parts of Prussia. The merino sheep was introduced by Frederick the Great, and since then the Silesian breed has been greatly improved. The woods and mountains harbour large quantities of game, such as red deer, roe deer, wild boars and hares. The fishery includes salmon in the Oder, trout in the mountain streams, and carp in the small lakes or ponds with which the province is sprinkled.

The great wealth of Silesia, however, lies underground, in the shape of large stores of coal and other minerals, which have been worked ever since the 12th century. The coal measures of Upper Silesia, in the south-east part of the province, are among the most extensive in continental Europe, and there is another large field near Waldenburg in the south-west. The output in 1905 exceeded 34 million tons, valued at £12,500,000 sterling, and equal to more than a quarter of the entire yield of Germany. The district of Oppeln also contains a great quantity of iron, the production in 1905 amounting to 862,000 tons. The deposits of zinc in the vicinity of Beuthen are perhaps the richest in the world, and produce two-thirds of the zinc ore of Germany (609,000 tons). The remaining mineral products include lead, from which a considerable quantity

of silver is extracted, copper, cobalt, arsenic, the rarer metal cadmium, alum, brown coal, marble, and a few of the commoner precious stones, jaspers, agates and amethysts. The province contains scarcely any salt or brine springs, but there are well-known mineral springs at Warmbrunn, Salzbrunn and several other places.

A busy manufacturing activity has long been united with the underground industries of Silesia, and the province in this respect is hardly excelled by any other part of Prussia. On the plateau of Tarnowitz the working and smelting of metals is the predominant industry, and in the neighbourhood of Beuthen, Königshütte and Gleiwitz there is an almost endless succession of iron-works, zinc-foundries, machine-shops and the like. At the foot of the Riesengebirge, and along the southern mountain line generally, the textile industries prevail. Weaving has been practised in Silesia, on a large scale, since the 14th century; and Silesian linen still maintains its reputation, though the conditions of production have greatly changed. Cotton and woollen goods of all kinds are also made in large quantities, and among the other industrial products are beetroot sugar, spirits, chemicals, tobacco, starch, paper, pottery, and "Bohemian glass." Lace, somewhat resembling that of Brussels, is made by the women of the mountainous districts. The trade of Silesia is scarcely so extensive as might be expected from its important industrial activity. On the east it is hampered by the stringent regulations of the Russian frontier, and the great waterway of the Oder, though in process of being regulated, is sometimes too low in summer for navigation. The extension of the railway system has, however, had its usual effect in fostering commerce, and the mineral and manufactured products of the province are freely exported.

At the census of 1905 the population of Silesia was 4,942,611, of whom 2,120,361 were Protestants, 2,765,394 Catholics and 46,845 Jews. The density is 317 per sq. m., but the average is of course very greatly exceeded in the industrial districts such as Beuthen. Three-fourths of the inhabitants and territory are German, but to the east of the Oder the Poles, more than 1,000,000 in number, form the bulk of the population, while there are about 15,500 Czechs in the south part of the province and 25,000 Wends near Liegnitz. The Roman Catholics, most of whom are under the ecclesiastical sway of the prince bishop of Breslau, are predominant in Upper Silesia and Glatz; the Protestants prevail in Lower Silesia, to the west of the Oder, and in Lusatia. The nobility is very numerous in Silesia, chiefly in the Polish districts. The educational institutions of the province are headed by the university of Breslau. In 1900 the percentage of illiterate recruits, in spite of the large Polish-speaking contingent, was only 0.05. The capital and seat of the provincial diet is Breslau (*q.v.*), which is also by far the largest and most important town. The towns next in point of size are Görlitz, Liegnitz, Königshütte, Beuthen, Schweidnitz, Neisse and Glogau. The province sends thirty-five members to the Reichstag and sixty-five to the Prussian chamber of deputies. The government divisions of Breslau and Oppeln together form the district of the 6th army corps with its headquarters at Breslau, while Liegnitz belongs to that of the 5th army corps, the headquarters of which are at Posen. Glogau, Glatz and Neisse are fortresses.

History.—The beginnings of Silesian history do not reach back beyond the 10th century A.D., at which time the district was occupied by clans of Slavonic nationality, one of which derived its name from the mountain *Zlenz* (mod. *Zobtenburg*), near Breslau, and thus gave rise to the present appellation of the whole province. The etymology of place-names suggests that the original population was Celtic, but this conjecture cannot be verified in any historical records. About the year 1000 the Silesian clans were incorporated in the kingdom of Poland, whose rulers held their ground with difficulty against continuous attacks by the kings of Bohemia, but maintained themselves successfully against occasional raids from Germany. The decisive factor in the separation of Silesia from Poland was furnished by a partition of the Polish crown's territories in 1138. Silesia was henceforth constituted as a separate principality, and in 1201 its political severance from Poland became complete.

A yet more important result of the partition of 1138 was the transference of Silesia to the German nation. The independent dynasty which was then established was drawn under the influence of the German king, Frederick Barbarossa, and two princes who in 1163 divided the sovereignty among themselves as dukes of Upper and Lower Silesia inaugurated the policy

of inviting German colonists to their vacant domains. More extensive immigrations followed, in the course of which the whole of Silesia was covered with German settlements. The numerous townships which then sprang up acquired rights of self-government according to German law, Breslau being refounded about 1250 as a German town, and a feudal organization was introduced among the landholding nobility. By the end of the 13th century Silesia had virtually become a German land.

This ethnical transformation was accompanied by a great rise in material prosperity. Large areas of forest or swamp were reclaimed for agriculture; the great Silesian industries of mining and weaving were called into existence, and Breslau grew to be a leading centre of exchange for the wares of East and West. The growing resources of the Silesian duchies are exemplified by the strength of the army with which Henry II., duke of Lower Silesia, broke the force of the Mongol invasion at the battle of Liegnitz (1241), and by the glamour at the court of the Minnesinger, Henry IV. (1266-1290). This prosperity, however, was checked by a growing tendency among the Silesian dynasties to make partitions of their territories at each new succession. Thus by the end of the 14th century the country had been split up into 18 principalities: Breslau, Brieg, Glogau, Jauer, Liegnitz, Münsterberg, Öls, Schweidnitz and Steinau in Lower Silesia; Beuthen, Falkenberg, Kosel, Neisse, Oppeln, Ratibor, Strehlitz, Teschen and Troppau in the upper district. The petty rulers of these sections wasted their strength with internecine quarrels and proved quite incompetent to check the lawlessness of their feudal vassals. Save under the vigorous rule of some dukes of Lower Silesia, such as Henry I. and Bolko I., and the above-named Henry II. and IV., who succeeded in reuniting most of the principalities under their sway, the country fell into a state of growing anarchy.

Unable to institute an effective national government, and unwilling to attach themselves again to Poland, the Silesian princes began about 1290 to seek the protection of the German dynasty then ruling in Bohemia. The intervention of these kings resulted in the establishment of their suzerainty over the whole of Silesia and the appropriation of several of its petty states as crown domains. The earliest of these Bohemian overlords, King John and the emperor Charles IV., fully justified their intrusion by the vigorous way in which they restored order and regularized the administration; in particular, the cities at this time attained a high degree of material prosperity and political importance. Under later rulers the connexion with Bohemia brought the Silesians no benefit, but involved them in the destructive Hussite wars. At the outbreak of this conflict in 1420 they gave ready support to their king Sigismund against the Bohemian rebels, whom they regarded as dangerous to their German nationality, but by this act they exposed themselves to a series of invasions (1425-1435) by which the country was severely devastated. In consequence of these raids the German element of population in Upper Silesia permanently lost ground; and a complete restitution of the Slavonic nationality seemed imminent on the appointment of the Hussite, George Podiebrad, to the Bohemian kingship in 1457. Though most of the Silesian dynasts seemed ready to acquiesce, the burghers of Breslau fiercely repudiated the new suzerain, and before he could enforce his claims to homage he was ousted by the Hungarian king, Matthias Corvinus, who was readily recognized as overlord (1469).

Matthias enforced his authority by the vigorous use of his mercenaries and by wholesale confiscations of the lands of turbulent nobles. By instituting a permanent diet of Silesian princes and estates to co-operate with his viceregent, he took an important step towards the abolition of particularism and the establishment of an effective central government. In spite of these reforms the Silesians, who felt severely the financial exactions of Matthias, began to resent the control of the Bohemian crown. Profiting by the feebleness of Matthias' successor Vladislav, they extorted concessions which secured to them a practical autonomy. These privileges still remained to them at the outset of the religious Reformation, which the Silesians, in spite of their Catholic zeal during the Hussite wars, accepted readily and

carried out with singularly little opposition from within or without. But a drastic revolution in their government was imposed upon them by the German king, Ferdinand I., who had been prevented from interference during his early reign by his wars with the Turks, and who showed little disposition to check the Reformation in Silesia by forcible means, but subsequently reasserted the control of the Bohemian crown by a series of important enactments. He abolished all privileges which were not secured by charter and imposed a more rigidly centralized scheme of government in which the activities of the provincial diet were restricted to some judicial and financial functions, and their freedom in matters of foreign policy was withdrawn altogether. Henceforth, too, annexations of territory were frequently carried out by the Bohemian crown on the extinction of Silesian dynasties, and the surviving princes showed an increasing reluctance to the exercise of their authority. Accordingly the Silesian estates never again chose to exercise initiative save on rare occasions, and from 1550 Silesia passed almost completely under foreign administration.

An uneventful period followed under the rule of the house of Habsburg, which united the kingship of Bohemia with the archduchy of Austria and the imperial crown. But this respite from trouble was ended by the outbreak of the Thirty Years' War (1618-48), which brought Silesia to the verge of ruin. Disquieted by some forcible attempts on Rudolph II.'s part to suppress Protestantism in certain parts of the country, and mistrusting a formal guarantee of religious liberty which was given to them in 1609, the Silesians joined hands with the Bohemian insurgents and renounced their allegiance to their Austrian ruler. Their defection, which was terminated by a capitulation in 1621, was not punished severely, but in spite of their attempt to maintain neutrality henceforth they were quite unable to secure peace. Silesia remained a principal objective of the various contending armies and was occupied almost continuously by a succession of ill-disciplined mercenary forces whose depredations and exactions, accentuated at times by religious fanaticism, reduced the country to a state of helpless misery. Three-quarters of the population are estimated to have lost their lives, and commerce and industry were brought to a standstill. Recovery from these disasters was retarded by the permanent diversion of trade to new centres like Leipzig and St Petersburg, and by a state of unsettlement due to the government's disregard of its guarantees to its Protestant subjects. A greater measure of religious liberty was secured for the Silesians by the representatives of King Charles XII. of Sweden on their behalf, and effective measures were taken by the emperor Charles VI. to stimulate commercial intercourse between Silesia and Austria. Nevertheless in the earlier part of the 18th century the condition of the country still remained unsatisfactory.

An important epoch in the history of Silesia is marked by the year 1740, when the dominion of Austria was exchanged for that of Prussia. Availing himself of a testamentary union made in 1537 between the duke of Liegnitz and the elector of Brandenburg, and of an attempt by the elector Frederick William to call it into force in spite of its annulment by Ferdinand I. in 1546, Frederick II. of Prussia raised a claim to the former duchies of Liegnitz, Brieg, Jägerndorf and Wohlau. The empress Maria Theresa, who was at this time involved with other enemies, was unable to prevent the occupation of Lower Silesia by Frederick and in 1741 ceded that province to him. In the following year Frederick renewed his attack and extorted from Austria the whole of Silesia except the districts of Troppau, Teschen and Jägerndorf, the present province of Austrian Silesia.

Though constrained by the general dangers of her position to make terms with Prussia, Maria Theresa long cherished the hope of recovering a possession which she, unlike her predecessors, valued highly and held by a far better title than did her opponent. A second war which Frederick began in 1744 in anticipation of a counter-attack from her only served to strengthen his hold upon his recent conquest; but in the famous Seven Years' War (*q.v.*) of 1756-63 the Austrian empress, aided by France and Russia, almost effected her purpose. Silesia was repeatedly overrun by

Austrian and Russian troops, and Frederick's ultimate expulsion seemed only a question of time. Yet the Prussian king recovered his lost ground by gigantic efforts and eventually retained his Silesian territory undiminished.

The annexation by Frederick was followed by a complete reorganization in which the obsolete powers of the local dynasts were abolished and Silesia became a mere province of the highly centralized Prussian state. Owing to the lack of a corporate Silesian consciousness and the feebleness of their local institutions, the people soon became reconciled to their change of rulers. Moreover Frederick, who had proved by his wars the importance which he attached to Silesia, was indefatigable in times of peace in his attempts to justify his usurpation. Making yearly visits to the country, and further keeping himself in touch with it by means of a special "minister of Silesia," he was enabled to effect numerous political reforms, chief of which were the strict enforcement of religious toleration and the restriction of oppressive seigniorial rights. By liberal endowments and minute but judicious regulations he brought about a rapid development of Silesian industries; in particular he revived the mining and weaving operations which at present constitute the country's chief source of wealth.

After its incorporation with Prussia Silesia ceases to have an independent political history. During the Napoleonic wars it was partly occupied by French troops (1806-1813), and at the beginning of the War of Liberation it was the chief scene of operations between the French and the allied armies. In 1815 it was enlarged by a portion of Lusatia, which had become detached from Silesia as far back as the 11th century and since then had been annexed to the kingdom of Saxony. During the rest of the 19th century its peace has been interrupted from time to time by riots of discontented weavers. But the general record of recent times has been one of industrial development and prosperity hardly inferior to that of any other part of Germany.

See C. Grünhagen, *Geschichte Schlesiens* (2 vols., Gotha, 1884-1886), and *Schlesien unter Friedrich dem Grossen* (2 vols., Gotha, 1890-1892); M. Morgenbesser, *Geschichte von Schlesien* (Berlin, 1892); Knötel, *Geschichte Oberschlesiens* (Kattowitz, 1906); H. Grotefend, *Stammtafeln der schlesischen Fürsten bis 1740* (Breslau, 1889); F. Rachfahl, *Die Organisation der Gesamtstaatsverwaltung Schlesiens vor dem dreissigjährigen Kriege* (Leipzig, 1894); H. Fechner, *Geschichte des schlesischen Berg- und Hüttenwesens 1741-1806* (Berlin, 1903); see also the *Zeitschrift des Vereins für Geschichte und Altertum Schlesiens* (Breslau, 1855 sqq.), and *Oberschlesische Heimat, Zeitschrift des oberschlesischen Geschichtsvereins* (Oppeln, 1905 sqq.).

Austrian Silesia.

Austrian Silesia (Ger. *Österreichisch-Schlesien*) is a duchy and crownland of Austria, bounded E. by Galicia, S. by Hungary and Moravia, W. and N. by Prussian Silesia. It has an area of 1987 sq. m. and is the smallest province of Austria. Silesia is divided by a projecting limb of Moravia into two small parts of territory, of which the western part is flanked by the Sudetic mountains, namely the Altvater Gebirge; while the eastern part is flanked by the Carpathians, namely the Jablunka Gebirge with their highest peak the Lissa Hora (4346 ft.). A great proportion of the surface of Silesia is occupied by the offshoots of these ranges. The province is traversed by the Vistula, which rises in the Carpathians within eastern Silesia, and by the Oder, with its affluents the Oppa and the Olsa. Owing to its mountainous character, and its slopes towards the N. and N.E., Silesia has a somewhat severe climate for its latitude, the mean annual temperature being 50° F., while the annual rainfall varies from 20 to 30 in.

Of the total area 49.4% is arable land, 34.2% is covered by forests, 6.2% by pasturages, while meadows occupy 5.8% and gardens 1.3%. The soil cannot, as a rule, be termed rich, although some parts are fertile and produce cereals, vegetables, beetroot and fruit. In the mountainous region dairy-farming is carried on after the Alpine fashion and the breeding of sheep is improving. Large herds of geese and pigeons are reared, while hunting and fishing constitute also important resources. The mineral wealth of Silesia is great and consists in coal, iron-ore, marble and slate. It possesses several mineral springs, of which the best known are the alkaline springs at Karlsbrunn. Like its adjoining provinces, Silesia boasts of a great and varied industrial activity, chiefly represented by the metallurgic and textile industries in all their branches. The cloth

and woollen industries are concentrated at Bielitz, Jägerndorf and Engelsberg; linen is manufactured at Freiwaldau Freudenthal and Bennisch; cotton goods at Friedek. The iron industry is concentrated at Trzinietz, near Teschen, and various industrial and agricultural machines are manufactured at Troppau, Jägerndorf, Ustron and Bielitz. The organs manufactured at Jägerndorf enjoy a good reputation. Other important branches of industry are chemicals at Hruschau and Petrowitz; sugar refineries, milling, brewing and liqueurs.

In 1900 the population numbered 680,422, which corresponds to 342 inhabitants per sq. m. The Germans formed 44.69% of the population, 33.21% were Poles and 22.05% Czechs and Slavs. According to religion, 84,73 were Roman Catholics, 14% Protestants and the remainder were Jews. The local diet is composed of 31 members, and Silesia sends 12 deputies to the Reichsrat at Vienna. For administrative purposes Silesia is divided into 9 districts and 3 towns with autonomous municipalities: Troppau, the capital, Bielitz and Friedek. Other principal towns are: Teschen, Polnisch-Ostrau, Jägerndorf, Karwin, Freudenthal, Freiwaldau and Bennisch.

The actual duchy is only a very small part, which was left to Austria after the Seven Years' War, from its former province of the same name. It formed, with Moravia, a single province until 1849, when it was created a separate duchy.

See F. Sláma, *Österreichisch-Schlesien* (Prague, 1887); and A. Peter, *Das Herzogtum Schlesien* (Vienna, 1884).

SILESIAN WARS, the name given to the contests between Austria and Prussia for the possession of Silesia. The first (1740-1742) and second (1744-1745) wars formed a part of the great European struggle called the War of the Austrian Succession (*q.v.*), and the third war (1756-1762) similarly a part of the Seven Years' War (*q.v.*).

SILHOUETTE, ÉTIENNE DE (1709-1767), controller-general of France, was born at Limoges on the 5th of July 1709. He travelled extensively while still a young man and drew attention to himself by the publication of English translations, historical writings, and studies on the financial system of England. Successively councillor to the parlement of Metz, secretary to the duke of Orleans, member of the commission on delimitation of Franco-British interests in Acadia (1749), and royal commissioner in the Indies Company, he was named controller-general through the influence of the marquess de Pompadour on the 4th of March 1759. The court at first reposed a blind confidence in him, but soon perceived not only that he was not a financier but also that he was bent on attacking privilege by levying a land-tax on the estates of the nobles and by reducing the pensions. A storm of opposition gathered and broke: a thousand cartoons and jokes were directed against the unfortunate minister who seemed to be resorting to one financial embarrassment in order to escape another; and in allusion to the sacrifices which he demanded of the nobles, even the conversion of their table plate into money, *silhouette* became the popular word for a figure reduced to simplest form. The word was eventually (1835) admitted to the dictionary by the French academy. Silhouette was forced out of the ministry on the 21st of November 1759 and withdrew to Brie-sur-Marne, where during the remainder of his life he sought refuge from scorn and sarcasm in religious devotion. He died on the 20th of January 1767.

Silhouette left several translations from the English and the Spanish, accounts of travel, and dull historical and philosophical writings, a list of which is given in Quérard, *France littéraire*, ix. 138. A *Testament politique*, published under his name in 1772, is apocryphal. See J. P. Clement and A. Lemoine, *M. de Silhouette* (Paris, 1872).

SILICA, in chemistry, the name ordinarily given to amorphous silicon dioxide, SiO₂. This chemical compound is widely and most abundantly distributed in nature, both in the free state and in combination with metallic oxides. Free silica constitutes the greater part of sand and sandy rocks; when fairly pure it occurs in the large crystals which we know as quartz (*q.v.*), and which, when coloured, form the gem-stones amethyst, cairngorm, cats'-eye and jasper. Tridymite (*q.v.*) is a rarer form, crystallographically different from quartz. Amorphous forms also occur: chalcedony (*q.v.*), and its coloured modifications agate, carnelian,

onyx and sard, together with opal (*qq.v.*) are examples. Amorphous silica can be obtained from a silicate (a compound of silica and a metallic oxide) by fusing the finely powdered mineral with sodium carbonate, decomposing the sodium silicate thus formed with hydrochloric acid, evaporating to dryness to convert the colloidal silicic acid into insoluble silica, and removing the soluble chlorides by washing with hot water. On drying, the silica is obtained as a soft white amorphous powder, insoluble in water and in all acids except hydrofluoric; it dissolves in hot solutions of the caustic alkalis and to a less extent in alkali carbonates. It melts at a high temperature, and in the electric furnace it may be distilled, the vapours condensing to a bluish-white powder. By heating a solution of sodium silicate in a glass vessel the glass is attacked (an acid silicate being formed) and silica separates at ordinary temperatures in a hydrated amorphous form, at higher temperatures but below 180° as tridymite, and above 180° as quartz.

Silicates.—These compounds are to be regarded as salts of silicic acid, or combinations of silicon dioxide and metallic basic oxides; they are of great importance since they constitute the commonest rock-forming and many other minerals, and occur in every petrographical species. The parent acid, silicic acid, was obtained by T. Graham by dialysing a solution of hydrochloric acid to which sodium silicate had been added; a colloidal silicic acid being retained in the dialyser. This solution may be concentrated until it contains about 14% of silica by open boiling, and this solution on evaporation in a vacuum gives a transparent mass of metasilicic acid, H_2SiO_3 . The solution is a tasteless liquid having a slight acid reaction; it gradually changes to a clear transparent jelly, which afterwards shrinks on drying. This coagulation is brought about very quickly by sodium carbonate, and may be retarded by hydrochloric acid or by a solution of a caustic alkali. Several hydrated forms have been obtained, e.g. $2\text{SiO}_2 \cdot \text{H}_2\text{O}$, $3\text{SiO}_2 \cdot \text{H}_2\text{O}$, $4\text{SiO}_2 \cdot \text{H}_2\text{O}$, $8\text{SiO}_2 \cdot \text{H}_2\text{O}$; these are very unstable, the first two losing water on exposure whilst the others absorb water. The natural silicates may be regarded as falling into 5 classes, viz. orthosilicates, derived from $\text{Si}(\text{OH})_4$; metasilicates, from $\text{SiO}(\text{OH})_2$; disilicates, from $\text{Si}_2\text{O}_3(\text{OH})_2$; trisilicates, from $\text{Si}_3\text{O}_5(\text{OH})_2$; and basic silicates. These acids may be regarded as derived by the partial dehydration of the ortho-acid. Another classification is given in METALLURGY; a list of mineral silicates is given in MINERALOGY, and for the synthetical production of these compounds see also PETROLOGY.

SILICON [symbol Si, atomic weight 28.3 (O=16)], a non-metallic chemical element. It is not found in the uncombined condition, but in combination with other elements it is, with perhaps the exception of oxygen, the most widely distributed and abundant of all the elements. It is found in the form of oxide (silica), either anhydrous or hydrated as quartz, flint, sand, chalcedony, tridymite, opal, &c., but occurs chiefly in the form of silicates of aluminium, magnesium, iron, and the alkali and alkaline earth metals, forming the chief constituent of various clays, soils and rocks. It has also been found as a constituent of various parts of plants and has been recognized in the stars. The element exists in two forms, one amorphous, the other crystalline. The older methods used for the preparation of the amorphous form, namely the decomposition of silicon halides or silicofluorides by the alkali metals, or of silica by magnesium, do not give good results, since the silicon obtained is always contaminated with various impurities, but a pure variety may be prepared according to E. Vigouroux (*Ann. chim. phys.*, 1897, (7) 12, p. 153) by heating silica with magnesium in the presence of magnesia, or by heating silica with aluminium. The crystalline form may be prepared by heating potassium silicofluoride with sodium or aluminium (F. Wohler, *Ann.*, 1856, 97, p. 266; 1857, 102, p. 382); by heating silica with magnesium in the presence of zinc (L. Gattermann, *Ber.*, 1889, 22, p. 186); and by the reduction of silica in the presence of carbon and iron (H. N. Warren, *Chem. News*, 1888, 57, p. 54; 1893, 67, p. 136). Another crystalline form, differing from the former by its solubility in hydrofluoric acid, was prepared by H. Moissan and F. Siemens (*Comptes rendus*, 1904, 138, p. 1299). A somewhat impure silicon (containing 90-98% of the element) is made by the Carborundum Company of Niagara Falls (United States Patents 745122 and 842273, 1908) by heating coke and sand in an electric furnace. The product is a crystalline solid of specific gravity 2.34, and melts at about 1430° C. See also German

Patent 108817 for the production of crystallized silicon from silica and carborundum.

Amorphous silicon is a brown coloured powder, the crystalline variety being grey, but it presents somewhat different appearances according to the method used for its preparation. The specific gravity of the amorphous form is 2.35 (Vigouroux), that of the crystalline variety varying, according to the method of preparation, from 2.004 to 2.493. The specific heat varies with the temperature, from 0.136 at -39° C. to 0.2029 at 232° C. Silicon distils readily at the temperature of the electric furnace. It is attacked rapidly by fluorine at ordinary temperature, and by chlorine when heated in a current of the gas. It undergoes a slight superficial oxidation when heated in oxygen. It combines directly with many metals on heating, whilst others merely dissolve it. When heated with sodium and potassium, apparently no action takes place, but if heated with lithium it forms a lithium silicide, Li_6Si_2 (H. Moissan, *Comptes rendus*, 1902, 134, p. 1083). It decomposes ammonia at a red heat, liberating hydrogen and yielding a compound containing silicon and nitrogen. It reduces many non-metallic oxides. It is only soluble in a mixture of hydrofluoric and nitric acid, or in solutions of the caustic alkalis, in the latter case yielding hydrogen and a silicate: $\text{Si} + 2\text{KHO} + \text{H}_2\text{O} = \text{K}_2\text{SiO}_3 + 2\text{H}_2$. On fusion with alkaline carbonates and hydroxides it undergoes oxidation to silica which dissolves on the excess of alkali yielding an alkaline silicate.

Silicon hydride, SiH_4 , is obtained in an impure condition, as a spontaneously inflammable gas, by decomposing magnesium silicide with hydrochloric acid, or by the direct union of silicon and hydrogen in the electric arc. In the pure state it may be prepared by decomposing ethyl silicoformate in the presence of sodium (C. Friedel and A. Ladenburg, *Comptes rendus*, 1867, 64, pp. 359, 1267); $4\text{Si}(\text{OC}_2\text{H}_5)_3 = \text{SiH}_4 + 3\text{Si}(\text{OC}_2\text{H}_5)_4$. When pure, it is a colourless gas which is not spontaneously inflammable at ordinary temperature and pressure, but a slight increase of temperature or decrease of pressure sets up decomposition. It is almost insoluble in water. It burns when brought into contact with chlorine, forming silicon chloride and hydrochloric acid. It decomposes solutions of silver nitrate and copper sulphate. A second hydride of silicon, of composition Si_2H_6 , was prepared by H. Moissan and S. Smiles (*Comptes rendus*, 1902, pp. 569, 1549) from the products obtained in the action of hydrochloric acid on magnesium silicide. These are passed through a vessel surrounded by a freezing mixture and on fractionating the product the hydride distils over as a colourless liquid which boils at 52° C. It is also obtained by the decomposition of lithium silicide with concentrated hydrochloric acid. Its vapour is spontaneously inflammable when exposed to air. It behaves as a reducing agent. For a possible hydride $(\text{Si}_2\text{H}_6)_n$ see J. Ogier, *Ann. chim. phys.*, 1880, (5), 20, p. 5.

Only one oxide of silicon, namely the dioxide or silica, is known (see SILICA).

Silicon fluoride, SiF_4 , is formed when silicon is brought into contact with fluorine (Moissan); or by decomposing a mixture of acid potassium fluoride and silica, or of calcium fluoride and silica with concentrated sulphuric acid. It is a colourless, strongly fuming gas which has a suffocating smell. It is decomposed with great violence when heated in contact with either sodium or potassium. It combines directly with ammonia to form the compound $\text{SiF}_4 \cdot 2\text{NH}_3$, and is absorbed by dry boric acid and by many metallic oxides. Water decomposes it into silicofluoric acid and silicic acid: $3\text{SiF}_4 + 3\text{H}_2\text{O} = 2\text{H}_2\text{SiF}_6 + \text{H}_2\text{SiO}_3$. With potassium hydroxide it yields potassium silicofluoride, whilst with sodium hydroxide, sodium fluoride is produced: $3\text{SiF}_4 = 4\text{KHO} = \text{SiO}_2 + 2\text{K}_2\text{SiF}_6 + 2\text{H}_2\text{O}$; $\text{SiF}_4 + 4\text{NaOH} = \text{SiO}_2 + 4\text{NaF} + 2\text{H}_2\text{O}$. It combines directly with acetone and with various amines. **Silicon fluoroform**, SiHF_3 , was obtained by O. Ruff and Curt Albert (*Ber.*, 1905, 38, p. 53) by decomposing titanium fluoride with silicon chloroform in sealed vessels at $100-120^{\circ}$ C. It is a colourless gas which may be condensed to a liquid boiling at -80.2° C. On solidification it melts at about -110° C. The gas is very unstable, decomposing slowly, even at ordinary temperatures, into hydrogen, silicon fluoride and silicon: $4\text{SiHF}_3 = 2\text{H}_2 + 3\text{SiF}_4 + \text{Si}$. It burns with a pale-blue flame forming silicon fluoride, silicofluoric acid and silicic acid. It is decomposed readily by water, sodium hydroxide, alcohol and ether:

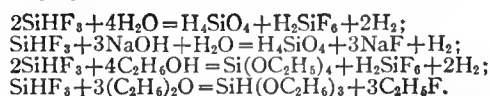

Silicofluoric acid, H_2SiF_6 , is obtained as shown above, and also by the action of sulphuric acid on barium silicofluoride, or by absorbing silicon fluoride in aqueous hydrofluoric acid. The solution on evaporation deposits a hydrated form, $\text{H}_2\text{SiF}_6 \cdot 2\text{H}_2\text{O}$, which decomposes when heated. The anhydrous acid is not known, since on

evaporating the aqueous solution it gradually decomposes into silicon fluoride and hydrofluoric acid.

Silicon chloride, SiCl_4 , was prepared by J. J. Berzelius (*Jahresb.*, 1825, 4, p. 91) by the action of chlorine on silicon, and is also obtained when an intimate mixture of silica and carbon is heated in a stream of chlorine and the products of reaction fractionated. It is a very stable colourless liquid which boils at 58°C . Oxygen only attacks it at very high temperatures. When heated with the alkali and alkaline earth metals it yields silicon and the corresponding metallic chlorides. Water decomposes it into hydrochloric acid and silicic acids. It combines directly with ammonia gas to form $\text{SiCl}_4 \cdot 6\text{NH}_3$, and it also serves as the starting point for the preparation of numerous organic derivatives of silicon. The hexachloride, Si_2Cl_6 , is formed when silicon chloride vapour is passed over strongly heated silicon; by the action of chlorine on the corresponding iodo-compound, or by heating the iodo-compound with mercuric chloride (C. Friedel, *Comptes rendus*, 1871, 73, p. 497). It is a colourless fuming liquid which boils at $146\text{--}148^\circ\text{C}$. It is decomposed by water, and also when heated between 350° and 1000°C ., but it is stable both below and above these temperatures. The octochloride, Si_3Cl_8 , is formed to the extent of about $\frac{1}{2}$ to 1% in the action of chlorine on silicon (L. Gattermann, *Ber.*, 1899, 32, p. 1114). It is a colourless liquid which boils at 210°C . Water decomposes it with the formation of silico-mesoxalic acid, $\text{HOOSiSi(OH)}_2\text{SiOOH}$. *Silicon chloroform*, SiHCl_3 , first prepared by H. Buff and F. Wöhler (*Ann.*, 1857, 104, p. 94), is formed by heating crystallized silicon in hydrochloric acid gas at a temperature below red heat, or by the action of hydrochloric acid gas on copper silicide, the products being condensed by liquid air and afterwards fractionated (O. Ruff and Curt Albert, *Ber.*, 1905, 38, p. 2222). It is a colourless liquid which boils at 33°C . It fumes in air and burns with a green flame. It is decomposed by cold water with the formation of silicoformic anhydride, $\text{H}_2\text{Si}_2\text{O}_3$. It unites directly with ammonia gas yielding a compound of variable composition. It is decomposed by chlorine.

Similar bromo-compounds of composition SiBr_4 , Si_2Br_6 and SiHBr_3 are known. *Silicon tetraiodide*, SiI_4 , is formed by passing iodine vapour mixed with carbon dioxide over strongly-heated silicon (C. Friedel, *Comptes rendus*, 1868, 67, p. 98); the iodo-compound condenses in the colder portion of the apparatus and is purified by shaking with carbon bisulphide and with mercury. It crystallizes in octahedra which melt at 120.5°C . and boil at 290°C . Its vapour burns with a red flame. It is decomposed by alcohol and also by ether when heated to 100°C .: $\text{SiI}_4 + 2\text{C}_2\text{H}_5\text{OH} = \text{SiO}_2 + 2\text{C}_2\text{H}_5\text{I} + 2\text{HI}$; $\text{SiI}_4 + 4(\text{C}_2\text{H}_5)_2\text{O} = \text{Si}(\text{OC}_2\text{H}_5)_4 + 4\text{C}_2\text{H}_5\text{I}$. The *hexaiodide*, Si_2I_6 , is obtained by heating the tetraiodide with finely divided silver to 300°C . It crystallizes in hexagonal prisms which exhibit double refraction. It is soluble in carbon bisulphide, and is decomposed by water and also by heat, in the latter case yielding the tetraiodide and the di-iodide, SiI_2 , an orange-coloured solid which is not soluble in carbon bisulphide. *Silicon iodoform*, SiHI_3 , is formed by the action of hydriodic acid on silicon, the product, which contains silicon tetraiodide, being separated by fractionation. It is also obtained by the action of hydriodic acid on silicon nitrogen hydride suspended in carbon bisulphide, or by the action of a benzene solution of hydriodic acid on trianilino-silicon hydride (O. Ruff, *Ber.*, 1907, 41, p. 3738). It is a colourless, strongly refracting liquid, which boils at about 220°C ., slight decomposition setting in above 150°C . Water decomposes it with production of leucone. Numerous chloro-iodides and bromoiodides of silicon have been described.

Silicon nitrogen hydride, SiNH , is a white powder formed with silicon amide when ammonia gas (diluted with hydrogen) is brought into contact with the vapour of silicon chloroform at -10°C . *Trianilino silicon hydride*, $\text{SiH}(\text{NH}_2)_3$, is obtained by the action of aniline on a benzene solution of silicon chloroform. It crystallizes in needles which decompose at 114°C . *Silicon amide*, $\text{Si}(\text{NH}_2)_4$, is obtained as a white amorphous unstable solid by the action of dry ammonia on silicon chloride at -50°C . (E. Vigouroux and C. Hugot, *Comptes rendus*, 1903, 136, p. 1670). It is readily decomposed by water: $\text{Si}(\text{NH}_2)_4 + 2\text{H}_2\text{O} = 4\text{NH}_3 + \text{SiO}_2$. Above 0°C . it decomposes thus: $\text{Si}(\text{NH}_2)_4 = 2\text{HN}_3 + \text{Si}(\text{NH}_2)_2$.

Silicon sulphide, SiS_2 , is formed by the direct union of silicon with sulphur; by the action of sulphuretted hydrogen on crystallized silicon at red heat (P. Sabatier, *Comptes rendus*, 1880, 90, p. 819); or by passing the vapour of carbon bisulphide over a heated mixture of silica and carbon. It crystallizes in needles which rapidly decompose when exposed to moist air. By heating crystallized silicon with boron in the electric furnace H. Moissan and A. Stock (*Comptes rendus*, 1900, 131, p. 139) obtained two borides, SiB_3 and SiB_6 . They are both very stable crystalline solids. The former is completely decomposed when fused with caustic potash and the latter by a prolonged boiling with nitric acid. For silicon carbide see carborundum. Numerous methods have been given for the preparation of *magnesium silicide*, Mg_2Si , in a more or less pure state, but the pure substance appears to have been obtained by P. Lebeau (*Comptes rendus*, 1908, 146, p. 282) in the following manner. Alloys of magnesium and silicon are prepared by heating fragments of magnesium with magnesium filings and potassium silico-fluoride. From the alloy containing 25% of silicon, the excess of magnesium is removed by a mixture of ethyl iodide and ether and a residue consisting of slate-blue octahedral crystals of magnesium silicide is left.

It decomposes water at ordinary temperature with evolution of hydrogen but without production of silicon hydride, whilst cold hydrochloric acid attacks it vigorously with evolution of hydrogen and spontaneously inflammable silicon hydride.

Organic Derivatives of Silicon.

The organic derivatives of silicon resemble the corresponding carbon compounds except in so far that the silicon atom is not capable of combining with itself to form a complex chain in the same manner as the carbon atom, the limit at present being a chain of three silicon atoms. Many of the earlier-known silicon alkyl compounds were isolated by Friedel and Crafts and by Ladenburg, the method adopted consisting in the interaction of the zinc alkyl compounds with silicon halides or esters of silicic acids. $\text{SiCl}_4 + 2\text{Zn}(\text{C}_2\text{H}_5)_2 = 2\text{ZnCl}_2 + \text{Si}(\text{C}_2\text{H}_5)_4$. This method has been modified by F. S. Kipping (*Jour. Chem. Soc.*, 1901, 79, p. 449) and F. Taurke (*Ber.*, 1905, 38, p. 1663) by condensing silicon halides with alkyl chlorides in the presence of sodium: $\text{SiCl}_4 + 4\text{R}\cdot\text{Cl} + 8\text{Na} = \text{SiR}_4 + 8\text{NaCl}$; $\text{SiHCl}_3 + 3\text{R}\cdot\text{Cl} + 6\text{Na} = \text{SiHR}_3 + 6\text{NaCl}$; whilst Kipping (*Proc. Chem. Soc.*, 1904, 20, p. 15) has used silicon halides with the Grignard reagent: $\text{C}_2\text{H}_5\text{MgBr} + \text{SiCl}_4 \rightarrow \text{C}_2\text{H}_5\text{SiCl}_3 + \text{MgBrPh} \rightarrow \text{Ph}\cdot\text{C}_2\text{H}_5\cdot\text{SiCl}_2 + \text{MgBrC}_2\text{H}_7 \rightarrow \text{Ph}\cdot\text{C}_2\text{H}_5\cdot\text{C}_3\text{H}_7\cdot\text{SiCl}$.

Silicon Tetramethyl, $\text{Si}(\text{CH}_3)_4$ (tetramethyl silicane), and silicon tetraethyl, $\text{Si}(\text{C}_2\text{H}_5)_4$, are both liquids. The latter reacts with chlorine to give silicon nonyl-chloride $\text{Si}(\text{C}_2\text{H}_5)_3\cdot\text{C}_2\text{H}_4\text{Cl}$, which condenses with potassium acetate to give the acetic ester of silicon nonyl alcohol from which the alcohol (a camphor-smelling liquid) may be obtained by hydrolysis. *Triethyl silicoal*, $(\text{C}_2\text{H}_5)_3\text{Si}\cdot\text{OH}$, is a true alcohol, obtained by condensing zinc ethyl with silicic ester, the resulting substance of composition, $(\text{C}_2\text{H}_5)_3\text{SiOC}_2\text{H}_5$, with acetyl chloride yielding a chloro-compound $(\text{C}_2\text{H}_5)_3\text{SiCl}$, which with aqueous ammonia yields the alcohol. *Silicon tetraphenyl*, $\text{Si}(\text{C}_6\text{H}_5)_4$, a solid melting at 231°C ., is obtained by the action of chlorobenzene on silicon tetrachloride in the presence of sodium. *Silico-oxalic acid*, $(\text{SiO}\cdot\text{OH})_2$, obtained by decomposing silicon hexachloride with ice-cold water, is an unstable solid which is readily decomposed by the inorganic bases, with evolution of hydrogen and production of a silicate. *Silico-mesoxalic acid*, $\text{HO}\cdot\text{OSi}(\text{OH})_2\cdot\text{SiO}\cdot\text{OH}$, formed by the action of moist air on silicon octochloride at 0°C ., is very unstable, and hot water decomposes it with evolution of hydrogen and formation of silicic acid (L. Gattermann, *Ber.*, 1899, 32, p. 1114). *Silico-benzoic acid*, $\text{C}_6\text{H}_5\cdot\text{SiO}\cdot\text{OH}$, results from the action of dilute aqueous ammonia on phenyl silicon chloride (obtained from mercury diphenyl and silicon tetrachloride). It is a colourless solid which melts at 92°C . For silicon derivatives of the amines see Michaelis, *Ber.*, 1896, 29, p. 710; on asymmetric silicon and the resolution of *dl*-benzyl-ethyl-propyl-silicoal see F. S. Kipping, *Jour. Chem. Soc.*, 1907, 91, pp. 209 et seq.

The atomic weight of silicon has been determined usually by analysis of the halide compounds or by conversion of the halides into silica. The determination of W. Becker and G. Meyer (*Zeit. anorg. Chem.*, 1905, 43, p. 251) gives the value 28.21, and the International Commission in 1910 has adopted the value 28.3.

SILISTRIA (Bulgarian *Silistra*), the chief town of a department in Bulgaria and the see of an archbishop, situated on a low-lying peninsula projecting into the Danube, 81 m. below Rustchuk and close to the frontier of the Rumanian Dobrudja. Pop. (1892) 11,718; (1900) 12,133; (1908) 12,055, of whom 6142 were Bulgarians and 4126 Turks. The town was formerly a fortress of great strength, occupying the N.E. corner of the famous quadrilateral (Rustchuk, Silistra, Shumla, Varna), but its fortifications were demolished in accordance with the Berlin Treaty (1877). In the town is a large subterranean cavern, the *Houmbata*, which served as a refuge for its inhabitants during frequent bombardments. The principal trade is in cereals; wine and wood are also exported. The town is surrounded by fine vineyards, some 30 kinds of grapes being cultivated, and tobacco is grown. Sericulture, formerly a flourishing industry, has declined owing to a disease of the silk-worms, but efforts have been made to revive it. Apiculture is extensively practised and there are large market-gardens in the neighbourhood. The soil of the department is fertile, but lacking in water; the inhabitants have excavated large receptacles in which rain-water is stored. A considerable area is still covered with forest, to which the region owes its name of Deli Orman ("the wild wood"); there are extensive tracts of pasturage, but cattle-rearing declined in 1880-1910. A large cattle-fair, lasting three days, is held in May. The town possessed in 1910 one steam flour-mill and some cloth factories and tanneries.

Silistria was the Durostorum of the Romans (Bulgarian *Drstr*); the ancient name remains in the title of the archbishop, who is styled metropolitan of Dorostol, and whose diocese is now

united with that of Tcherven (Rustchuk). It was one of the most important towns of Moesia Inferior and was successively the headquarters of the legio I. (Italica) and the legio XI. (Claudia). It was defended by the Bulgarian tsar Simeon against the Magyars and Greeks in 893. In 967 it was captured by the Russian prince Sviatoslav, whom the Byzantine emperor Nicephorus Phocas had summoned to his assistance. In 971 Sviatoslav, after a three months' heroic defence, surrendered the town to the Byzantines, who had meanwhile become his enemies. In 1388 it was captured by the Turks under Ali Pasha, the grand vizier of the sultan Murad. A few years later it seems to have been in the possession of the Walachian prince Mircea, but after his defeat by Mahommed I. in 1416 it passed finally into the hands of the Turks. Silistria flourished under Ottoman rule; Hajji Khalifa describes it as the most important of all the Danubian towns; a Greek metropolitan was installed here with five bishops under his control and a settlement of Ragusan merchants kept alive its commercial interests. In 1810 the town was surrendered to the Russians under Kamenskiy, who destroyed its fortifications before they withdrew, but they were rebuilt by foreign engineers, and in 1828-1829 were strong enough to offer a serious resistance to the Russians under Diebich, who captured the town with the loss of 3000 men. At that date the population including the garrison was 24,000, but in 1837 it was only about 4000. The town was held in pledge by the Russians for the payment of a war indemnity (1829-1836). During the campaign of 1854 it was successfully defended by General Krach against the Russians under Paskievich; the circuit of its defences had been strengthened before this time by the outlying fortresses Medjid-tabia (built by English engineers) and Arab-tabia. It was again invested by the Russians in 1877, and on the conclusion of peace was evacuated by the Turks. (J. D. B.)

SILIUS ITALICUS, in full TITUS CATIUS SILIUS ITALICUS (A.D. 25 or 26-101), Latin epic poet. His birthplace is unknown. From his cognomen Italicus the conclusion has been drawn that he came from the town of Italica in Spain; but Latin usage would in that case have demanded the form *Italicensis*, and it is highly improbable that Martial would have failed to name him among the literary celebrities of Spain in the latter half of the 1st century. The conjecture that Silius derived from Italica, the capital of the Italian confederation during the Social War, is open to still stronger objection. Most likely some ancestor of the poet acquired the title "Italicus" from having been a member of one of the corporations of "Italici" who are often mentioned in inscriptions from Sicily and elsewhere. In early life Silius was a renowned forensic orator, later a safe and cautious politician, without ability or ambition enough to be legitimately obnoxious to the cruel rulers under whom he lived. But mediocrity was hardly an efficient protection against the murderous whims of Nero, and Silius was generally believed to have secured at once his own safety and his promotion to the consulship by prostituting his oratorical powers in the judicial farces which often ushered in the doom of the emperor's victims. He was consul in the year of Nero's death (68), and is mentioned by Tacitus as having been one of two witnesses who were present at the conferences between Vitellius and Flavius Sabinus, the elder brother of Vespasian, when the legions from the East were marching rapidly on the capital. The life of Silius after his consulship is well depicted by the younger Pliny:—"He conducted himself wisely and courteously as the friend of the luxurious and cruel Vitellius; he won repute by his proconsulship of Asia, and obliterated by the praiseworthy use he made of his leisure the stain he had incurred through his active exertions in former days. In dignity and contentment, avoiding power and therefore hostility, he outlived the Flavian dynasty, keeping to a private station after his governorship of Asia." His poem contains only two passages relating to the Flavians; in both Domitian is eulogized as a warrior; in one he figures as a singer whose lyre is sweeter than that of Orpheus himself. Silius was a great student and patron of literature and art, and a passionate collector. Two great Romans of the past, Cicero and Virgil, were by him idealized

and veritably worshipped; and he was the happy possessor of their estates at Tusculum and Naples. The later life of Silius was passed on the Campanian shore, hard by the tomb of Virgil, at which he offered the homage of a devotee. He closely emulated the lives of his two great heroes: the one he followed in composing epic verse, the other in debating philosophic questions with his friends of like tastes. Among these was Epictetus, who judged him to be the most philosophic spirit among the Romans of his time, and Cornutus, the Stoic, rhetorician and grammarian, who appropriately dedicated to Silius a commentary upon Virgil. Though the verse of Silius is not wrapped in Stoic gloom like that of Lucan, yet Stoicism lends in many places a not ungraceful gravity to his poem. Silius was one of the numerous Romans of the early empire who had the courage of their opinions, and carried into perfect practice the theory of suicide adopted by their school. Stricken by an incurable tumour, he starved himself to death, keeping a cheerful countenance to the end.

Whether Silius committed to writing his philosophic dialogues or not, we cannot say. Chance has preserved to us his epic poem entitled *Punica*, in seventeen books, and comprising some fourteen thousand lines. In choosing the Second Punic War for his subject, Silius had, we know, many predecessors, as he doubtless had many followers. From the time of Naevius onwards every great military struggle in which the Romans had been engaged had found its poet over and over again. In justice to Silius and Lucan, it should be observed that the mythologic poet had a far casier task than the historic. In a well-known passage Petronius pointedly describes the difficulties of the historic theme. A poet, he said, who should take upon him the vast subject of the civil wars would break down beneath the burden unless he were "full of learning," since he would have not merely to record facts, which the historians did much better, but must possess an unshackled genius, to which full course must be given by the use of digressions, by bringing divine beings on to the stage, and by giving generally a mythologic tinge to the subject. The Latin laws of the historic epic were fixed by Ennius, and were still binding when Claudian wrote. They were never seriously infringed, except by Lucan, who substituted for the *dei ex machina* of his predecessors the vast, dim and imposing Stoic conception of destiny. By protracted application, and being "full of learning," Silius had acquired excellent recipes for every ingredient that went to the making of the conventional historic epic. Though he is not named by Quintilian, he is probably hinted at in the mention of a class of poets who, as the writer says, "write to show their learning." To seize the moments in the history, however unimportant, which were capable of picturesque treatment; to pass over all events, however important, which could not readily be rendered into heroics; to stuff out the somewhat modern heroes to something like Homeric proportions; to subject all their movements to the passions and caprices of the Olympians; to ransack the poetry of the past for incidents and similes on which a slightly new face might be put; to foist in by well-worn artifices episodes, however strange to the subject, taken from the mythologic or historic glories of Rome and Greece,—all this Silius knew how to do. He did it all with the languid grace of the inveterate connoisseur, and with a simplicity foreign to his time, which sprang in part from cultivated taste and horror of the venturesome word, and in part from the subdued tone of a life which had come unscathed through the reigns of Caligula, Nero and Domitian. The more threadbare the theme, and the more worn the machinery, the greater the need of genius. Two of the most rigid requirements of the ancient epic were abundant similes and abundant single combats. But all the obvious resemblances between the actions of heroic man and external nature had long been worked out, while for the renovation of the single combat little could be done till the hero of the Homeric type was replaced by the medieval knight. Silius, however, had perfect poetic appreciation, with scarce a trace of poetic creativeness. No writer has ever been more correctly and more uniformly judged by contemporaries and by posterity alike. Only the shameless flatterer, Martial, ventured to call

his friend a poet as great as Virgil. But the younger Pliny gently says that he wrote poems with greater diligence than talent, and that, when, according to the fashion of the time, he recited them to his friends, "he sometimes found out what men really thought of them." It is indeed strange that the poem lived on. Silius is never mentioned by ancient writers after Pliny except Sidonius, who, under different conditions and at a much lower level, was such another as he. Since the discovery of Silius by Poggio, no modern enthusiast has arisen to sing his praises. His poem has been rarely edited since the 18th century. Yet, by the purity of his taste and his Latin in an age when taste was fast becoming vicious and Latin corrupt, by his presentation to us of a type of a thousand vanished Latin epics, and by the historic aspects of his subject, Silius merits better treatment from scholars than he has received. The general reader he can hardly interest again. He is indeed of imitation all compact, and usually dilutes what he borrows; he may add a new beauty, but new strength he never gives. Hardly a dozen lines anywhere are without an echo of Virgil, and there are frequent admixtures of Lucretius, Horace, Ovid, Lucan, Homer, Hesiod and many other poets still extant. If we could reconstitute the library of Silius we should probably find that scarcely an idea or a phrase in his entire work was wholly his own.

The raw material of the *Punica* was supplied in the main by the third decade of Livy, though Silius may have consulted other historians of the Hannibalic war. Such facts as are used are generally presented with their actual circumstances unchanged, and in their historic sequence. The spirit of the Punic times is but rarely misconceived—as when to secret voting is attributed the election of men like Flaminius and Varro, and distinguished Romans are depicted as contending in a gladiatorial exhibition. Silius clearly intended the poem to consist of twenty-four books, like the *Iliad* and the *Odyssey*, but after the twelfth he hurries in visible weariness to the end, and concludes with seventeen. The general plan of the epic follows that of the *Iliad* and the *Aeneid*. Its theme is conceived as a duel between two mighty nations, with parallel dissensions among the gods. Scipio and Hannibal are the two great heroes who take the place of Achilles and Hector on the one hand and of Aeneas and Turnus on the other, while the minor figures are all painted with Virgilian or Homeric pigments. In the delineation of character our poet is neither very powerful nor very consistent. His imagination was too weak to realize the actors with distinctness and individuality. His Hannibal is evidently at the outset meant for an incarnation of cruelty and treachery, the embodiment of all that the vulgar Roman attached to the name "Punic." But in the course of the poem the greatness of Hannibal is borne in upon the poet, and his feeling of it betrays itself in many touches. Thus he names Scipio "the great Hannibal of Ausonia"; he makes Juno assure the Carthaginian leader that if fortune had only permitted him to be born a Roman he would have been admitted to a place among the gods; and, when the ungenerous monster of the first book accords in the fifteenth a splendid burial to Marcellus, the poet cries, "You would fancy it was a Sidonian chief who had fallen." Silius deserves little pity for the failure of his attempt to make Scipio an equipoise to Hannibal and the counterpart in personal prowess and prestige of Achilles. He becomes in the process almost as mythical a figure as the medieval Alexander. The best drawn of the minor characters are Fabius Cunctator, an evident copy of Lucan's Cato, and Paullus, the consul killed at Cannae, who fights, hates and dies like a genuine man.

Clearly it was a matter of religion with Silius to repeat and adapt all the striking episodes of Homer and Virgil. Hannibal must have a shield of marvellous workmanship like Achilles and Aeneas; because Aeneas descended into Hades and had a vision of the future history of Rome, so must Scipio have his revelation from heaven; Trebia, choked with bodies, must rise in ire like Xanthus, and be put to flight by Vulcan; for Virgil's Camilla there must be an Asbyte, heroine of Saguntum; the beautiful speech of Euryalus when Nisus seeks to leave him is too good to

be thrown away—furbished up a little, it will serve as a parting address from Imilce to her husband Hannibal. The descriptions of the numerous battles are made up in the main, according to epic rule, of single combats—wearisome sometimes in Homer, wearisome oftener in Virgil, painfully wearisome in Silius. The different component parts of the poem are on the whole fairly well knit together, and the transitions are not often needlessly abrupt; yet occasionally incidents and episodes are introduced with all the irrelevancy of the modern novel. The interposition of the gods is, however, usually managed with dignity and appropriateness.

As to diction and detail, we miss, in general, power rather than taste. The metre runs on with correct smooth monotony, with something always of the Virgilian sweetness, though attenuated, but nothing of the Virgilian variety and strength. The dead level of literary execution is seldom broken by a rise into the region of genuine pathos and beauty, or by a descent into the ludicrous or the repellent. There are few absurdities, but the restraining force is trained perception and not a native sense of humour, which, ever present in Homer, not entirely absent in Virgil, and sometimes finding grim expression in Lucan, fails Silius entirely. The address of Anna, Dido's sister, to Juno compels a smile. Though deified on her sister's death, and for a good many centuries already an inhabitant of heaven, Anna meets Juno for the first time on the outbreak of the *Second Punic War*, and deprecates the anger of the queen of heaven for having deserted the Carthaginians and attached herself to the Roman cause. Hannibal's parting address to his child is also comical: he recognizes in the "heavy wailing" of the year-old babe "the seeds of rages like his own." But Silius might have been forgiven for a thousand more weaknesses than he has if in but a few things he had shown strength. The grandest scenes in the history before him fail to lift him up; his treatment, for example, of Hannibal's Alpine passage falls immensely below Lucan's vigorous delineation of Cato's far less stirring march across the African deserts.

But in the very weaknesses of Silius we may discern merit. He at least does not try to conceal defects of substance by contorted rhetorical conceits and feebly forcible exaggerations. In his ideal of what Latin expression should be he comes near to his contemporary Quintilian, and resolutely holds aloof from the tenor of his age. Perhaps his want of success with the men of his time was not wholly due to his faults. His self-control rarely fails him; it stands the test of the horrors of war, and of Venus working her will on Hannibal at Capua. Only a few passages here and there betray the true silver Latin extravagance. In the avoidance of rhetorical artifice and epigrammatic antithesis Silius stands in marked contrast to Lucan, yet at times he can write with point. Regarded merely as a poet he may not deserve high praise; but, as he is a unique specimen and probably the best of a once numerous class, the preservation of his poem among the remains of Latin Literature is a fortunate accident.

The poem was discovered in a MS., possibly at Constance, by Poggio, in 1416 or 1417; from this now lost MS. all existing MSS., which belong entirely to the 15th century, are derived. A valuable MS. of the 8th or 9th century, found at Cologne by L. Carrion in the latter part of the 16th century, disappeared soon after its discovery. Two *editiones principes* appeared at Rome in 1471; the principal editions since have been those of Heinsius (1600), Drakenborch (1717), Ernesti (Leipzig, 1791), and L. Bauer (1890). The *Punica* is included in the second edition of the *Corpus poetarum Latinorum*. A useful *variorum* edition is that of Lemaire (Paris, 1823). Recent writing on Silius is generally in the form of separate articles or small pamphlets; but see H. E. Butler, *Post-Augustan Poetry* (1909), chap. x.

SILK, a fibrous substance produced by many insects, principally in the form of a cocoon or covering within which the creatures are enclosed and protected during the period of their principal transformations. The webs and nests, &c., formed by spiders are also of silk. But the fibres used for manufacturing purposes are exclusively produced by the mulberry silk-moth of China, *Bombyx mori*, and a few other moths closely allied to that insect. Among the Chinese the name of the silkworm is "si," Korean "soi"; to the ancient Greeks it became known

as *σῆρ*, the nation whence it came was to them *Σῆρες*, and the fibre itself *σηρικόν*, whence the Latin *sericum*, the French *soie*, the German *Seide* and the English *silk*.

History.—The silk industry originated in China; and according to native records it has existed there from a very remote period. The empress, known as the lady of Si-ling, wife of a famous emperor, Huang-ti (2640 B.C.), encouraged the cultivation of the mulberry tree, the rearing of the worms and the reeling of silk. This empress is said to have devoted herself personally to the care of silkworms, and she is by the Chinese credited with the invention of the loom. A voluminous ancient literature testifies not only to the antiquity but also to the importance of Chinese sericulture, and to the care and attention bestowed on it by royal and noble families. The Chinese guarded the secrets of their valuable art with vigilant jealousy; and there is no doubt that many centuries passed before the culture spread beyond the country of its origin. Through Korea a knowledge of the silkworm and its produce reached Japan, but not before the early part of the 3rd century. One of the most ancient books of Japanese history, the *Nihongi*, states that towards A.D. 300 some Koreans were sent from Japan to China to engage competent people to teach the arts of weaving and preparing silk goods. They brought with them four Chinese girls, who instructed the court and the people in the art of plain and figured weaving; and to the honour of these pioneer silk weavers a temple was erected in the province of Settsu. Great efforts were made to encourage the industry, which from that period grew into one of national importance. At a period probably little later a knowledge of the working of silk travelled westward, and the cultivation of the silkworm was established in India. According to a tradition the eggs of the insect and the seed of the mulberry tree were carried to India by a Chinese princess concealed in the lining of her head dress. The fact that sericulture was in India first established in the valley of the Brahmaputra and in the tract lying between that river and the Ganges renders it probable that it was introduced overland from the Chinese empire. From the Ganges valley the silkworm was slowly carried westward and spread in Khotan, Persia and the states of Central Asia.

Most critics recognize in the obscure word *d'meseq* or *d'mesheq*, Amos iii. 12, a name of silk corresponding to the Arabic *dimaqs*, late Greek *μέραξα*, English *damask*, and also follow the ancients in understanding *meshi*, Ezek. xvi. 10, 13, of "silken gauze." But the first notice of the silkworm in Western literature occurs in Aristotle, *Hist. anim.* v. 19 (17), 11 (6), where he speaks of "a great worm which has horns and so differs from others. At its first metamorphosis it produces a caterpillar, then a bombylius and lastly a chrysalis—all these changes taking place within six months. From this animal women separate and reel off the cocoons and afterwards spin them. It is said that this was first spun in the island of Cos by Pamphile, daughter of Plates." Aristotle's vague knowledge of the worm may have been derived from information acquired by the Greeks with Alexander the Great; but long before this time raw silk must have begun to be imported at Cos, where it was woven into a gauzy tissue, the famous *Cos vestis*, which revealed rather than clothed the form.

Towards the beginning of the Christian era raw silk began to form an important and costly item among the prized products of the East which came to Rome. Allusions to silk and its source became common in classical literature; but, although these references show familiarity with the material, they are singularly vague and inaccurate as to its source; even Pliny knew nothing more about the silkworm than could be learned from Aristotle's description. The silken textures which at first found their way to Rome were necessarily of enormous cost, and their use by men was deemed a piece of effeminate luxury. From an anecdote of Aurelian, who neither used silk himself nor would allow his wife to possess a single silken garment, we learn that silk was worth its weight in gold.

Notwithstanding its price and the restraints otherwise put on the use of silk the trade grew. Under Justinian a monopoly of the trade and manufacture was reserved to the emperor, and

looms, worked by women, were set up within the imperial palace at Constantinople. Justinian also endeavoured, through the Christian prince of Abyssinia, to divert the trade from the Persian route along which silk was then brought into the east of Europe. In this he failed, but two Persian monks who had long resided in China, and there learned the whole art and mystery of silkworm rearing, arrived at Constantinople and imparted their knowledge to the emperor. By him they were induced to return to China and attempt to bring to Europe the material necessary for the cultivation of silk, which they effected by concealing the eggs of the silkworm in a hollow cane. From the precious contents of that bamboo tube, brought to Constantinople about the year 550, were produced all the races and varieties of silkworm which stocked and supplied the Western world for more than twelve hundred years.

Under the care of the Greeks the silkworm took kindly to its Western home and flourished, and the silken textures of Byzantium became famous. At a later period the conquering Saracens obtained a mastery over the trade, and by them it was spread both east and west—the textures becoming meantime impressed with the patterns and colours peculiar to that people. They established the trade in the thriving towns of Asia Minor, and they planted it as far west as Sicily, as Sicilian silks of the 12th century with Saracenic patterns still testify. Ordericus Vitalis, who died in the first half of the 12th century, mentions that the bishop of St Evroul, in Normandy, brought with him from Apulia in southern Italy several large pieces of silk, out of the finest of which four copes were made for his cathedral chanters. The cultivation and manufacture spread northwards to Florence, Milan, Genoa and Venice—all towns which became famous for silken textures in medieval times. In 1480 silk weaving was begun under Louis XI. at Tours, and in 1520 Francis I. brought from Milan silkworm eggs, which were reared in the Rhone valley. About the beginning of the 17th century Olivier de Serres and Laffemas, somewhat against the will of Sully, obtained royal edicts favouring the growth of mulberry plantations and the cultivation of silk; but it cannot be said that these industries were firmly established till Colbert encouraged the planting of the mulberry by premiums, and otherwise stimulated local efforts.

Into England silk manufacture was introduced during the reign of Henry VI.; but the first serious impulse to manufactures of that class was due to the immigration in 1585 of a large body of skilled Flemish weavers who fled from the Low Countries in consequence of the struggle with Spain then devastating their land. Precisely one hundred years later religious troubles gave the most effective impetus to the silk-trade of England, when the revocation of the edict of Nantes sent simultaneously to Switzerland, Germany and England a vast body of the most skilled artisans of France, who planted in these countries silk-weaving colonies which are to this day the principal rivals of the French manufacturers. The bulk of the French Protestant weavers settled at Spitalfields, London—an incorporation of silk workers having been there formed in 1629. James I. used many efforts to encourage the planting of the mulberry and the rearing of silkworms both at home and in the colonies. Up to the year 1718 England depended on the thrown silks of Europe for manufacturing purposes. But in that year Lombe of Derby, disguised as a common workman, and obtaining entrance as such into one of the Italian throwing mills, made drawings of the machinery used for this process. On his return, subsidized by the government, he built and worked, on the banks of the Derwent, the first English throwing mill. In 1825 a public company was formed and incorporated under the name of the British, Irish and Colonial Silk Company, with a capital of £1,000,000, principally with the view of introducing sericulture into Ireland, but it was a complete failure, and the rearing of the silkworm cannot be said ever to have become a branch of British industry.

In 1522 Cortes appointed officials to introduce sericulture into New Spain (Mexico), and mulberry trees were then planted and eggs were brought from Spain. The Mexican adventure is

mentioned by Acosta, but all trace of the culture had died out before the end of the century. In 1609 James I. attempted to reinstate the silkworm on the American continent, but his first effort failed through shipwreck. An effort made in 1619 obtained greater success, and, the materials being present, the Virginian settlers were strongly urged to devote attention to the profitable industry of silk cultivation. Sericulture was enjoined under penalties by statute; it was encouraged by bounties and rewards; and its prosecution was stimulated by learned essays and rhapsodical rhymes, of which this is a sample:—

“Where Wormes and Food doe naturally abound
A gallant Silken Trade must there be found.
Virginia excels the World in both—
Envie nor malice can gaine say this troth!”

In the prospectus of Law's great *Compagnie des Indes Occidentales* the cultivation of silk occupies a place among the glowing attractions which allured so many to disaster. Onward till the period of the War of Independence bounties and other rewards for the rearing of worms and silk filature continued to be offered; and just when the war broke out Benjamin Franklin and others were engaged in nursing a filature into healthy life at Philadelphia. With the resumption of peaceful enterprise, the stimulus of bounties was again applied—first by Connecticut in 1783; and such efforts have been continued sporadically down almost to the present day. Bounties were last offered by the state of California in 1865–1866, but the state law was soon repealed, and an attempt to obtain state encouragement again in 1872 was defeated. About 1838 a speculative mania for the cultivation of silk developed itself with remarkable severity in the United States. It was caused principally through the representations of Samuel Whitmarsh as to the capabilities of the South Sea Islands mulberry (*Morus multicaulis*) for feeding silkworms; and so intense was the excitement that plants and crops of all kinds were displaced to make room for plantations of *M. multicaulis*. In Pennsylvania as much as \$300,000 changed hands for plants in one week, and frequently the young trees were sold two and three times over within a few days at ever-advancing prices. Plants of a single year's growth reached the ridiculous price of \$1 each at the height of the fever, which, however, did not last long, for in 1839 the speculation collapsed; the famous *M. multicaulis* was found to be no golden tree, and the costly plantations were uprooted.

The most singular feature in connexion with the history of silk is the persistent efforts which have been made by monarchs and other potentates to stimulate sericulture within their dominions, efforts which continue to this day in British colonies, India and America. These endeavours to stimulate by artificial means have in scarcely any instance resulted in permanent success. In truth, raw silk can only be profitably brought to the market where there is abundant and very cheap labour—the fact that China, Japan, Bengal, Piedmont and the Levant are the principal producing localities making that plain.

The Silkworm.

The mulberry-feeding moth, *Bombyx mori*, which is the principal source of silk, belongs to the *Bombycidae*, a family of *Lepidoptera* in which are embraced some of the largest and most handsome moths. *B. mori* is itself an inconspicuous moth (figs. 1 and 2), of an ashy white colour, with a body in the case of the male not $\frac{1}{2}$ in. in length, the female being a little longer and stouter. Its wings are short and weak; the

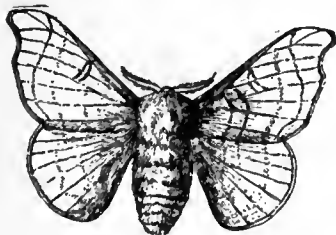

FIG. 1.—*Bombyx mori* (male).

hind pair do not reach to the end of the body. The larva (fig. 3) is hairless, of an ashy grey or cream colour, attains to a length of from 3 to $3\frac{1}{2}$ in., and is slender in comparison with many of its allies. The second thoracic ring is humped, and there

is a spine-like horn or protuberance at the tail. The common silkworm produces as a rule only one generation during the year; but there are races in cultivation which are bivoltine, or two-generationed, and some are multivoltine. Its natural food is the leaves of mulberry trees. The silk glands or vessels consist of two long thick-walled sacs running along the sides of the body, which open by a common orifice—the spinneret or seripositor—on the under lip of the larva.

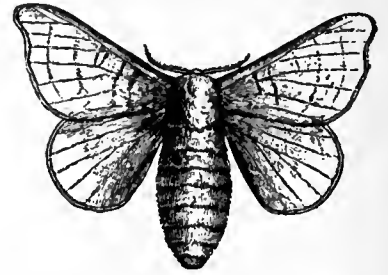

FIG. 2.—*Bombyx mori* (female).

Fig. 4 represents the head (a) and feet (b, b) of

the common silkworm, while c is a diagrammatic view of the silk glands. As the larva approaches maturity these vessels become gorged with a clear viscous fluid, which, upon being exposed to the air immediately hardens to a solid mass.

Advantage is taken of this peculiarity to prepare from fully developed larvae silkworm gut used for casting lines in rod-fishing, and for numerous other purposes where lightness, tenacity, flexibility and strength are essential. The larvae are killed and hardened by steeping some hours in strong acetic acid; the silk glands are then separated from the bodies, and the viscous fluid drawn out to the condition of a fine uniform line, which is stretched between pins at the extremity of a board.

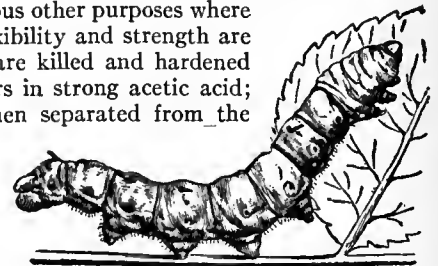

FIG. 3.—Larva of *Bombyx mori*.

The board is then exposed to the sunlight till the lines dry and harden into the condition of gut. The preparation of gut is, however, merely an unimportant collateral manufacture. When the larva is fully mature, and ready to change into the pupa condition, it proceeds to spin its cocoon, in which operation it ejects from both glands simultaneously a continuous and reelable thread of 800

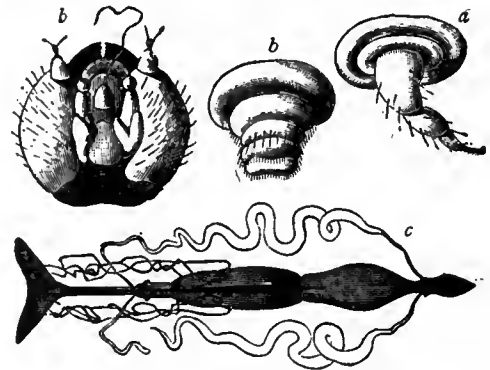

FIG. 4.

to 1200 yds. in length, moving its head round in regular order continuously for three days or thereabouts. The thread so ejected forms the silk of commerce, which as wound in the cocoon consists of filaments seriposited from two separate glands (discovered by an Italian naturalist named Filippi) containing a glutinous or resinous secretion which serves a double purpose, viz. that of helping the thin viscous threads through their final outlets, and the adhesion of the two filaments when brought into contact with the atmosphere.

Under the microscope cocoon silk presents the appearance (fig. 5) of a somewhat flattened combination of two filaments placed side by side, being on an average $\frac{1}{1250}$ part of an inch in thickness (see also FIBRES, Plate I.). The cocoons are white or yellow in colour, oviform in shape, with often a constriction in the middle (fig. 6). According to race, &c., they vary considerably in size and weight, but on an average they measure from an inch to an inch and a half in length, and from half an inch to an inch in diameter. They form

hard, firm and compact shells with some straggling flossy filaments on the exterior, and the interior layers are so closely and densely agglutinated as to constitute a parchment-like mass which resists all attempts at unwinding. The whole cocoon with its enclosed pupa weighs from 15 grains for the smaller races to about 50 grains for

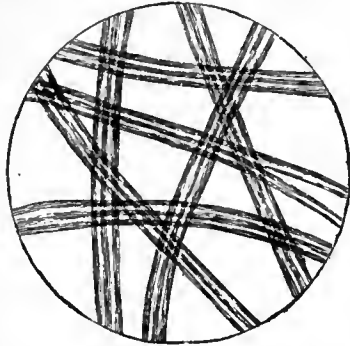

FIG. 5.—Microscopic appearance of Silk of *Bombyx mori*.



FIG. 6.—Cocoon of *Bombyx mori*.

the breeds which spin large cocoons. From two to three weeks after the completion of the cocoon the enclosed insect is ready to escape; it moistens one end of its self-made prison, thereby enabling itself to push aside the fibres and make an opening by which the perfect moth comes forth. The sexes almost immediately couple; the female in from four to six days lays her eggs, numbering 500 and upwards; and, with that the life cycle of the moth being complete, both sexes soon die.

Sericulture.

The art of sericulture concerns itself with the rearing of silkworms under artificial or domesticated conditions, their feeding, the formation of cocoons, the securing of these before they are injured and pierced by the moths, and the maturing of a sufficient number of moths to supply eggs for the cultivation of the following year. The first essential is a stock of mulberry trees adequate to feed the worms in their larval stage. The leaves preferred in Europe are those of the white-fruited mulberry, *Morus alba*, but there are numerous other species which appear to be equally suitable. The soil in which the mulberry grows, and the age and condition of the trees, are important factors in the success of silkworm cultivation; and it has been too often proved that the mulberry will grow in situations where, from the nature of the leaf the trees put forth and from other circumstances, silkworms cannot be profitably reared. An elevated position with dry, friable, well-drained soil produces the best quality of leaves. Throughout the East the species of mulberry cultivated are numerous, but, as these trees have been grown for special purposes at least for three thousand years, they show the complex variations peculiar to most cultivated plants.

The eggs of the silkworm, called *graine*, are hatched out by artificial heat at the period when the mulberry leaves are ready for the feeding of the larvae. These eggs are very minute—about one hundred weighing a grain; and a vast number of hatched worms may at first be kept in a small space; but the rapid growth and voracious appetite of the caterpillars demand quickly increasing and ample space. Pieces of paper punctured with small holes are placed over the trays in which the hatching goes on; and the worms, immediately they burst their shell, creep through these openings to the light, and thereby scrape off any fragments of shell which, adhering to the skin, would kill them by constriction. The rearing-house in which the worms are fed (Fr. *magnanerie*) must be a spacious, well-lighted and well-ventilated apartment, in which scrupulous cleanliness and sweetness of air are essential, and in which the temperature may to a certain extent be under control. The worms are more hardy than is commonly supposed, and endure variations of temperature from 62° to 78° F. without any injury; but higher temperature is very detrimental. The lower the temperature at which the worms are maintained the slower is their growth and development; but their health and vigour are increased, and the cocoon they spin is proportionately bigger. The worms increase in size with astonishing rapidity, and no less remarkable is their growing

voracity. Certain races moult or cast their skin three times during their larval existence, but for the most part the silkworm moults four times—about the sixth, tenth, fifteenth and twenty-third days after hatching. As these moulting periods approach, the worms lose their appetite and cease eating, and at each period of change they are left undisturbed and free from noise.

Laurent de l'Arbousset showed in 1905 that 1 oz. of seed of 30 grammes producing 30,000 to 35,000 silkworms (30,000 may be depended upon to reach the cocoon stage) will give a harvest of 130 to 140 lb fresh cocoons and an ultimate yield of about 12 lb raw silk properly reeled. The amount of nourishment required for this rearing is as follows:—hatching to first moult, about 9 lb of leaves of tender growth, equal to 40 to 45 lb ripe leaves; first to second moult, 24 lb, representing 100 lb ripe leaves; second to third moult, 80 lb, representing 240 lb ripe leaves; third to fourth moult, 236 lb, representing 472 lb ripe leaves; fourth moult to mounting, 1430 lb, representing 1540 lb ripe leaves, totalling to about one ton of ripe leaves for a complete rearing. The growth of the worms during their larval stage is thus stated by Count Dandolo:—

	Weight per 100.	Size in Lines.
Worms newly hatched	1 gr.	1
After 1st moult	15 "	4
" 2nd "	94 "	6
" 3rd "	400 "	12
" 4th "	1628 "	20
Greatest weight and size	9500 "	40

When the caterpillars are mature and ready to undergo their transformation into the pupa condition, they cease eating for some time and then begin to ascend the brushwood branches or echelletes provided for them, in which they set about the spinning of their cocoons. Crowding of positions must now be guarded against, to prevent the spinning of double cocoons (*doupiens*) by two worms spinning together and so interlacing their threads that they can only be reeled for a coarser and inferior thread. The insects complete their cocoons in from three to four days, and in two or three days thereafter the cocoons are collected, and the pupa killed to prevent its further progress and the bursting of the shell by the fully developed moth. Such cocoons as are selected for the production of graine, on the other hand, are collected, freed from the external floss, and preserved at a temperature of from 66° to 72° F., and after a lapse of from eleven to fifteen days the moths begin to make their appearance. The coupling which immediately takes place demands careful attention; the males are afterwards thrown away, and the impregnated females placed in a darkened apartment till they deposit their eggs.

Diseases.—That the silkworm is subject to many serious diseases is only to be expected of a creature which for upwards of 4000 years has been propagated under purely artificial conditions, and these most frequently of a very insanitary nature, and where, not the healthy life of the insect, but the amount of silk it could be made to yield, was the object of the cultivator. Among the most fatal and disastrous of these diseases with which the cultivator had long to grapple was "muscardine," a malady due to the development of a fungus, *Botrytis bassiana*, in the body of the caterpillar. The disease is peculiarly contagious and infectious, owing to the development of the fungus through the skin, whence spores are freed, which, coming in contact with healthy caterpillars, fasten on them and germinate inwards, giving off corpuscles within the body of the insect. Muscardine, however, has not been epidemic for many years. But about the year 1853 anxious attention began to be given in France to the ravages of a disease among silkworms, which from its alarming progress threatened to issue in national disaster. This disease, which at a later period became known as "pebrine"—a name given to it by de Quatrefages, one of its many investigators—had first been noticed in France at Cavaillon in the valley of the Durance near Avignon. Pebrine manifests itself by dark spots in the skin of the larvae; the eggs do not hatch out, or hatch imperfectly; the worms are weak, stunted and unequal in growth, languid in movement, fastidious in feeding; many perish before coming to maturity; if they spin a cocoon it is soft and loose, and moths when developed are feeble and inactive. When sufficient vitality remains to produce a second generation it shows in increased intensity the feebleness of the preceding. The disease is thus hereditary, but in addition it is virulently infectious and contagious.

From 1850 onwards French cultivators were compelled, in order to keep up their silk supply, to import graine from uninfected districts. The area of infection increased rapidly, and with that the demand for healthy graine correspondingly expanded, while the supply had to be drawn from increasingly remote and contracted regions. Partly supported by imported eggs, the production of silk in France was maintained, and in 1853 reached its maximum of 26,000,000 kilos of cocoons, valued at 117,000,000 francs. From that period, notwithstanding the importation at great cost of foreign graine, reaching in some years to 60,000 kilos, the production of silk fell off with startling rapidity: in 1856 it was not more than 7,500,000 kilos of cocoons; in 1861 and 1862 it fell as low as 5,800,000 kilos; and in 1865 it touched its lowest weight of about 4,000,000 kilos. In 1867 de Quatrefages estimated the loss suffered by France in the 13 years following 1853, from decreased production of silk and price paid to foreign cultivators for graine, to be not less than one milliard of francs. In the case of Italy, where the disease showed itself later but even more disastrously, affecting a much more extended industry, the loss in 10 years de Quatrefages stated at two milliards. A loss of £120,000,000 sterling within 13 years, falling on a limited area, and on one class within these two countries, constituted indeed a calamity on a national scale, calling for national effort to contend with its devastating action. The malady, moreover, spread eastward with alarming rapidity, and, although it was found to be less disastrous and fatal in Oriental countries than in Europe, the sources of healthy graine became fewer and fewer, till only Japan was left as an uninfected source of European graine supply.

A scourge which so seriously menaced the very existence of the silkworm in the world necessarily attracted a great amount of attention. So early as 1849 Guérin Méneville observed in the blood of diseased silkworms certain vibratory corpuscles, but neither did he nor the Italian Filippi, who studied them later, connect them distinctly with the disease. The corpuscles were first accurately described by Cornalia, whence they are spoken of as the corpuscles of Cornalia. The French Academy charged de Quatrefages, Decaisne and Péligot with the study of the disease, and they issued two elaborate reports—*Études sur les maladies actuelles des vers à soie* (1859) and *Nouvelles Recherches sur les maladies actuelles des vers à soie* (1860); but the suggestions they were able to offer had not the effect of stopping the march of the disease. In 1865 Pasteur undertook a Government commission for the investigation of the malady. Attention had been previously directed to the corpuscles of Cornalia, and it had been found, not only that they occurred in the blood, but that they gorged the whole tissues of the insect, and their presence in the eggs themselves could be microscopically demonstrated. Pasteur established (1) that the corpuscles are the special characteristic of the disease, and that these invariably manifest themselves, if not in earlier stages, then in the mature moths; (2) that the corpuscles are parasites, and not only the sign but the cause of the disease; and (3) that the disease manifests itself by heredity, by contagion with diseased worms, and by the eating of leaves on which corpuscles are spread. In this connexion he established the very important practical conclusion that worms which contract the disease during their own life-cycle retain sufficient vitality to feed, develop and spin their cocoon, although the next generation is invariably infected and shows the disease in its most virulent and fatal form. But this fact enabled the cultivator to know with assurance whether the worms on which he bestowed his labour would yield him a harvest of silk. He had only to examine the bodies of the moths yielding his graine: if they were free from disease then a crop was sure; if they were infected the education would assuredly fail. Pasteur brought out the fact that the malady had existed from remote periods and in many unsuspected localities. He found corpuscles in Japanese cocoons and in many specimens which had been preserved for lengthened periods in public collections. Thus he came to the conclusion that the malady had been inherent in many successive generations of the silkworm, and that the epidemic condition was only an exaggeration of a normal state brought about by the method of cultivation and production of graine pursued. The cure proposed by Pasteur was simply to take care that the stock whence graine was obtained should be healthy, and the offspring would then be healthy also. Small educations reared apart from the ordinary magnanerie, for the production of graine alone, were recommended. At intervals of five days after spinning their cocoons specimens were to be opened and the chrysalides examined microscopically for corpuscles. Should none have appeared till towards the period of transformation and escape of the moths, the eggs subsequently hatched out might be depended on to yield a fair crop of silk; should the moths prove perfectly free from corpuscles after depositing their eggs the next generation would certainly live well through the larval stage. For special treatment towards the regeneration of an infected race, the most robust worms were to be selected, and the moths issuing from the cocoons were to be coupled in numbered cells, where the female was to be confined till she deposited her eggs. The bodies of both male and female were to be examined for corpuscles, and the eggs of those found absolutely free from taint were preserved for similar "cellular" treatment in the following year. By this laborious and painstaking method it has been found possible to re-establish a healthy stock of valuable races from previously highly-infected breeds. The rearing of worms in small educations under special supervision has been found to be

a most effective means of combating pebrine. In the same way the rearing of worms for graine in the open air, and under as far as possible natural conditions, has proved equally valuable towards the development of a hardy, vigorous and untainted stock. The open-air education was originally proposed by Chavannes of Lausanne, and largely carried out in the canton of Vaud by Roland, who reared his worms on mulberry trees enclosed within "manchons" or cages of wire gauze and canvas. The insects appeared quickly to revert to natural conditions; the moths brought out in open air were strongly marked, lively and active, and eggs left on the trees stood the severity of the winter well, and hatched out successfully in the following season. Roland's experience demonstrated that not cold but heat is the agent which saps the constitution of the silkworm and makes it a ready prey to disease.

Grasserie is another form of disease incidental to the silkworm. It often appears before or after the first moult, but it is only after the fourth that it appears in a more developed form. The worm attacked presents the following symptoms: the skin is distended as if swollen, is rather thin and shiny, and the body of the worm seems to have increased, that is, it suffers from fatness, or is *engraissé*, hence its name. The disease is characterized by the decomposition of the blood; in fact it is really a form of dropsy. The blood loses its transparency and becomes milky, its volume increases so that the skin cannot hold it, and it escapes through the pores. This disease is more accidental than contagious and rarely takes very dangerous proportions. If the attack comes on a short time before maturity, the worms are able to spin a cocoon of a feeble character, but worms with this disease never change into chrysalides, but always die in the cocoon before transformation can take place. The causes which produce it are not well known, but it is generally attributable to currents of cold and damp air, to the use of wet leaves in feeding, and to sudden changes of temperature.

Another cause of serious loss to the rearers is occasioned by *Flacherie*, a disease well known from the earliest times. Pasteur showed that the origin of the disease proceeded from microscopic organisms called ferments and vitrios. One has only to ferment a certain quantity of mulberry leaves, chop them up and squeeze them, and so obtain a liquid, to find in it millions of ferments and vitrios. It invariably happens during the most active period of feeding, three or four days after the fourth moult up to the rising, and generally appears after a meal of coarse leaves, obtained from mulberries pruned the same year and growing in damp soil. *Flacherie* is an intestinal disease of the cholera species and therefore contagious. The definite course is not occasioned so much from the ferments which exist in the leaves themselves, but from an arrest of the digestive process which allows the rapid multiplication of the former in the intestines. Good ventilation is indispensable to allow the worm to give out by transpiration the great quantity of water that it absorbs with the leaf. If this exhalation is stopped or lessened the digestion in its turn is also stopped, the leaf remains longer than usual in the intestines, the microbes multiply, invading the whole body, and this brings about the sudden death which surprises the rearers. The true remedies consist in the avoidance of the fermentation of the leaves by careless gathering, transport or packing, in proper hygienic care in ventilation and in maintaining a proper degree of dryness in the atmosphere in rainy weather, and in the use of quicklime placed in different parts of the nursery to facilitate the transpiration of the silk-worms.

Wild Silks.—The ravages of pebrine and other diseases had the effect of attracting prominent attention to the numerous other insects, allies of the mulberry silkworm, which spin serviceable cocoons. It had been previously pointed out by Captain Hutton, who devoted great attention to the silk question as it affects the East Indies, that at least six species of *Bombyx*, differing from *B. mori*, but also mulberry-feeding, are more or less domesticated in India. These include *B. textor*, the boropooloo of Bengal, a large species having one generation yearly and producing a soft flossy cocoon; the Chinese monthly worm, *B. sinensis*, having several generations, and making a small cocoon; and the Madrasi worm of Bengal (*B. croesi*), the Dassee or Desi worm of Bengal (*B. fortunatus*) and *B. arracanensis*, the Burmese worm—all of which yield several

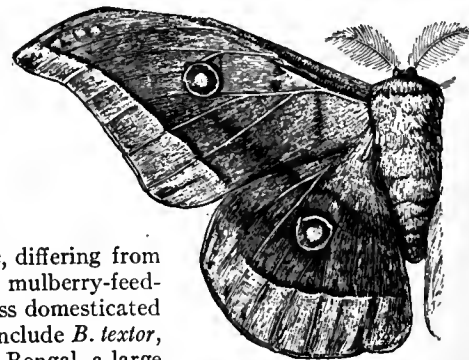

FIG. 7.—Chinese Tussur Moth, *Antheraea pernyi* (male).

generations in the year and form reelable cocoons. Besides these there are many other mulberry-feeding *Bombycidae* in the East, principally belonging to the genera *Theophila* and *Ocinara*, the cocoons of which have not attracted cultivators. The moths yielding wild silks which have obtained most attention belong to the extensive and handsome



FIG. 8.—Cocoon of *Antheraea pernyi*.

(fig. 9) *Antheraea mylitta*, found throughout the whole of India feeding on the bher tree, *Zizyphus jujuba*, and on many other plants. It yields a large compact cocoon (fig. 10) of a silvery grey colour, which Sir Thomas Wardle of Leek, who devoted a great amount of attention to the wild-silk

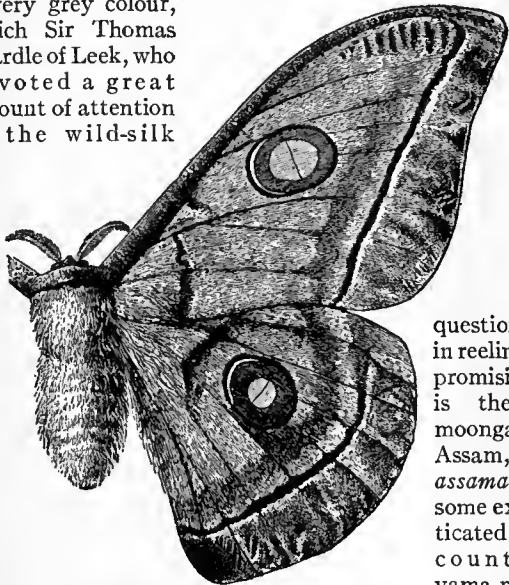

FIG. 9.—*Antheraea mylitta* (female).

(*Samia*) *yama-mai*, an oak-feeder, is a race of considerable importance in Japan, where it was said to be jealously guarded against foreigners. Its eggs were first sent to Europe by



FIG. 10.—Cocoon of *Antheraea mylitta*.

no means of a quality to compare with that of the common mulberry worm. The mezankeorie moth of the Assamese, *Antheraea mezankeoria*, yields a valuable cocoon, as does also

family *Saturniidae*. The most important of the species at the present time is the Chinese tussur or tasar worm, *Antheraea pernyi* (figs. 7, 8), an oak-feeding species, native of Mongolia, from which is derived the greater part of the so-called tussur silk now imported into Europe. Closely allied to this is the Indian tussur moth

question, succeeded in reeling. Next in promising qualities is the muga or moonga worm of Assam, *Antheraea assama*, a species to some extent domesticated in its native country. The yama-mai worm of Japan, *Antheraea*

the Atlas moth, *Attacus atlas*, which has an omnivorous larva found throughout India, Ceylon, Burmah, China and Java. The Cynthia moth, *Attacus cynthia*, is domesticated as a source of silk in certain provinces of China, where it feeds on the *Ailanthus glandulosa*. The eria or arrindi moth of Bengal and Assam, *Attacus ricini*, which feeds on the castor-oil plant, yields seven generations yearly, forming loose flossy orange-red and sometimes white cocoons. The ailanthus silkworm of Europe is a hybrid between *A. cynthia* and *A. ricini*, first obtained by Guérin Méneville, and now spread through many silk-growing regions. These are only a few of the moths from which silks of various usefulness can be produced; but none of these presents qualities, saving perhaps cheapness alone, which can put them in competition with common silk.

Physical and Chemical Relations of Silk.

Common cocoons enclosing chrysalides weigh each from 16 to 50 grains, or say from 300 to 600 of small breeds and from 270 to 300 of large breeds to the lb. About one-sixth of this weight is pure cocoon, and of that one-half is obtainable as reeled silk, the remainder consisting of surface floss or blaze and of hard gummy husk. As the outer flossy threads and the inner vests are not reelable, it is difficult to estimate the total length of thread produced by the silkworm, but the portion reeled varies in length and thickness, according to the condition and robustness of the cocoon, in some breeds giving a result as low as 500 metres, and in others 900 to 1200 metres. Under favourable conditions it is estimated that 11 kilogrammes of fresh cocoons give 1 kilogramme of raw silk for commerce, and about the same quantity for waste spinning purposes. Sir Thomas Wardle of Leek, in his handbook on silk published in 1887, showed by a series



FIG. 11.—Microscopic appearance of Silk of Chinese Tussur.

of measurements that the diameter of a single cocoon thread or have varied from $\frac{1}{16000}$ th to $\frac{1}{24000}$ th part of an inch in diameter in the various species of Bombycides, whilst those of the Saturnides or wild species varied from $\frac{1}{8000}$ th to $\frac{1}{11000}$ th part of an inch. As this estimation presents some difficulties and divergences, the size of the thread is generally defined commercially by deniers or decigrammes, those of the *Antheraeas* (wild silks) being said to range from 5 to 8 deniers or decigrammes, results confirmed by actual experience with the reeled thread. The silk of the various species of *Antheraea* and *Attacus* is also thicker and stronger at the centre of the reeled portion than towards its extremities; but the diameter is much greater than that of common silk, and the filaments under the microscope (fig. 11) present the appearance of flat bands, the exudation from the two spinnerets being joined at their flat edges. On this account the fibres of tussur or tussore silk tend to split up into fine fibrillae under the various preparatory processes in manufacturing, and its riband structure is the cause of the glassy lustre peculiar to the woven and finished fibres.

Silk fibre (see FIBRES) consists essentially of a centre or core of fibroin, with a covering of sericin or silk albumen, and a little waxy and colouring matter. Fibroin, which is analogous to horn, hair and like dermal products, constitutes about 75 to 82 % of the entire mass, and has a composition represented by the formula $C_{15}H_{23}N_5O_8$. It has the characteristic appearance of pure silk—a brilliant soft white body with a pearly lustre—insoluble in water, alcohol and ether, but it dissolves freely in concentrated alkaline solutions, mineral acids, strong acetic acid and in ammoniacal solution of oxide of copper. Sericin, which constitutes the gummy covering (Fr. *grès*) of the fibre, is a gelatinous body which dissolves readily in warm soapy solutions, and in hot water, in which on cooling it forms a jelly with even as little as 1 % of the substance. It is precipitated from hot solutions by alcohol, falling as a white powder. Its formula is $C_{15}H_{23}N_5O_8$. According to P. Bolley, the glands of the silkworm contain semi-liquid fibroin alone, and it is on exposure to the air that

the surface is acted on by oxygen, transforming the external pellicle into the more soluble form of sericin. Silk is highly hygroscopic. If desiccated at 250° F. it will be found to lose from 10 to 15% of moisture according to the condition of the silk. It is a most perfect non-conductor of electricity, and in its dry state the fibres frequently get so electrically excited as to seriously interfere with their working, so that it becomes necessary to moisten them with glycerin or soapy solutions. Silk is readily distinguished from wool and other animal fibres by the action of an alkaline solution of oxide of lead, which darkens wool, &c., owing to the sulphur they contain, but does not affect silk, which is free from that body. Again, silk dissolves freely in common nitric acid, which is not the case with wool. From vegetable fibres silk is readily distinguished by the bright yellow colour it takes from a solution of picric acid, which does not adhere to vegetable substances. The rod-like appearance of silk and its absence of markings under the microscope are also easily recognizable features of the fibre.

Silk Manufacture.

Here we must distinguish between the reeled silk and the spun or waste silk manufactures. The former embraces a range of operations peculiar to silk, dealing as they do with continuous fibres of great length, whereas in the spun silk industry the raw materials are treated by methods analogous to those followed in the treatment of other fibres (see WEAVING). It is only floss, injured and unreelable cocoons, the husks of reeled cocoons, and other waste from reeling, with certain wild silks, which are treated by the spun silk process, and the silk thereby produced loses much of the beauty, strength and brilliance which are characteristic of the manufactures from reeled silk.

Filature or Reeling.—When the cocoons have been gathered the chrysalides they contain are killed either by dry heat or by exposure to steam. All cocoons stained by the premature death of the chrysalides (*chiques*), pierced cocoons, and any from other causes rendered unreelable, are put aside for the spun-silk manufacture. Then the uninjured cocoons are by themselves sorted into classes having similar shades of colour, size and quality of fibre. This assortment is of great consequence for the success of the reeling operations, as uniformity of quality and evenness and regularity of fibre are the most valuable features in raw silk. The object of reeling is to bring together the filaments (*bave*) from two or more (generally four or five, but sometimes up to twenty) cocoons, and to form them into one continuous, uniform, and regular strand, which constitutes the "raw silk" of commerce. To do this, the natural gum of the cocoons which holds the filaments together must be softened, the ends of the filaments of the required number of cocoons must be caught, and means must be taken to unwind and lay these filaments together, so as to form a single uniform rounded strand of raw silk. As the reeling proceeds the reeler has to give the most careful attention to the thickness of the strand being produced, and to introduce new cocoons in place of any from which the reelable silk has become exhausted. In this way a continuous uniform fibre or strand of raw silk of indefinite length is produced. The apparatus used for these purposes in some localities is of a very primitive kind, and the reeling being uneven and lumpy the silk is of inferior quality and low value. With comparatively simple appliances, on the other hand, a skilled reeler, with trained eye and delicate touch, can produce raw silk of remarkably smooth and even quality. According to the method commonly adopted in North Italy and France the cocoons are for a few minutes immersed in water a little under the boiling point, to which a small quantity of alkali has been added. A girl with a small hand brush of twigs keeps stirring them in the water till the silk softens, and the outer loose fibres (*floss*) get entangled with the twigs and come off till the end of the main filament (*maitre brin*) is found. These ends being secured, the cocoons are transferred to a basin or tray containing water heated to from 140° to 150° F., in which they float while the silk is being reeled off. If the water is too cold the gum does not soften enough and the cocoons rise out of the basin in reeling; if it is too hot the cocoons collapse and fall to the bottom. The ends of the requisite number of filaments being brought together, they are passed through an eyelet or guide, and similarly another equal set are passed through a corresponding guide. The two sets of filaments are then crossed or twisted around each other several turns as if to make one thread, after which they are separated and passed through separate guides to the reel round which they are separately wound. When a large number of cocoons are to be combined into one strand they may be reeled from the tray in four sets, which are first crossed in pairs, then combined into two, and those two then crossed and afterwards combined into a single strand. The object of crossing (*croissage*) is to round, smooth and condense the separate filaments of each set into one strand, and as the surface of the filaments is gummy and adhesive it is found on drying that they have agglutinated into a compact single fibre of raw silk. In the most approved modern filatures there is a separate cocoon boiler (*cuisseuse*), an oblong tank containing water boiled by steam heat. In these the cocoons are immersed in rectangular perforated boxes for about

three minutes, when they are transferred to the beating machine (*batteuse*), an earthenware trough having a perforated false bottom through which steam keeps the water at a temperature of from 140° to 160°. In this water the cocoons are kept stirring by small brushes rotated by mechanical means, and as the silk softens the brushes gradually rise out of the water, bringing entangled with them the loose floss, and thereby revealing the main filament of each cocoon. The cocoons are next, in sufficient number, transferred to the reeler's tray (*bacinella*), where the water is heated to about 140° to 150°. From the tray the filaments are carried through a series of porcelain and glass eyelets, so arranged that the strand returns on itself, two portions of the same strand being crossed or intertwisted for rounding and consolidation, instead of the *croissage* of two separate strands as in the old method. The reel to which the raw silk is led consists of a light six-armed frame, enclosed within a wooden casing having a glass frame in front, the enclosure being heated with steam-pipes. To keep the strands from directly overlaying each other and so adhering, the last guide through which the silk passes has a reciprocating motion whereby the fibre is distributed within certain limits over the reel. Fig. 12 presents a sectional view of a reeling apparatus as used in Italy, and shows the passage of the thread from the basin to the reel, the threads being twisted around by the *tavelette* to give roundness to the thread, but though the principle remains much the same, great improvements have been made on this model.

Throwing.—Raw silk, being still too fine and delicate for ordinary use, next undergoes a series of operations called throwing, the object of which is to twist and double it into more substantial yarn. The first operation of the silk throwster is winding. He receives the raw silk in hanks as it is taken from the reel of the filature, and putting it on a light reel of a similar construction, called the *swifts*,

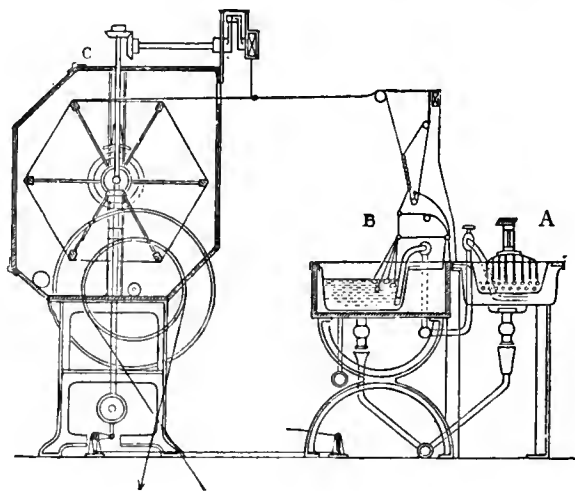

FIG. 12.

he winds it on bobbins with a rapid reciprocating motion, so as to lay the fibre in diagonal lines. These bobbins are then in general taken to the first spinning frame, and there the single strands receive their first twist, which rounds them, and prevents the compound fibre from splitting up and separating when, by the subsequent scouring operations, the gum is removed which presently binds them into one. Next follows the operation of cleaning, in which the silk is simply reeled from one bobbin to another, but on its way it passes through a slit which is sufficiently wide to pass the filament but stops the motion when a thick lump or nib is presented. In the doubling, which is the next process, two or more filaments are wound together side by side on the same reel, preparatory to their being twisted or thrown into one yarn. Bobbins to the number of strands which are to be twisted into one are mounted in a creel on the doubling frame, and the strands are passed over smooth rods of glass or metal through a reciprocating guide to the bobbin on which they are wound. Each separate strand passes through the eye of a faller, which, should the fibre break, falls down and instantly stops the machine, thus effectually calling attention to the fact that a thread has failed. The spinning or throwing which follows is done on a frame with upright spindles and flyers, the yarn as it is twisted being drawn forward through guides and wound on revolving bobbins with a reciprocating motion. From these bobbins the silk is reeled into hanks of definite length for the market. Numerous attempts have been made to simplify the silk-throwing by combining two or more operations on one machine, but not as yet with much success.

According to the qualities of raw silk used and the throwing operations undergone the principal classes of thrown silk are—(1) "singles," which consist of a single strand of twisted raw silk made up of the filaments of eight to ten cocoons; (2) tram or weft thread, consisting of two or three strands of raw silk not twisted before doubling and only lightly spun (this is soft, flossy and comparatively

weak); (3) organzine, the thread used for warps, made from two and rarely three twisted strands spun in the direction contrary to that in which they are separately twisted. Silks for sewing and embroidery belong to a different class from those intended for weaving, and thread-makers throw their raw silks in a manner peculiar to themselves.

Numbering of Silk.—The metric system of weights and measures has been adopted so widely that it forms the most suitable basis for the *titrage* or counts of yarns. The permanent committee of the Paris International Congress of 1900, which was held for the purpose of unification of the numerotation of counts, unanimously decided—(a) With reference to cotton, silk and other textiles spun from fibres, that they should be based on a fixed weight and variable length, the unit being one metre to one gramme. Thus number 100 would be 100 metres per gramme calculated on the single strand. (b) With reference to raw and thrown silk, in order to enable the count to show the degrees of variation incidental to this class of material, it was decided for a basis of a fixed length and variable count weight. The length of skein adopted was 450 metres and the unit of length the half decigramme. Thus the count of silk is expressed by the number of half decigrammes which the length of 450 metres weighs. This obtains whether in the single, double or more threads joined together in the doubling.

This latter differs very little in actual practice from the previous method of determination by the number of deniers per 476 metres, the denier being calculated on the equivalent of 0.0531 gramme, the English equivalent showing $33\frac{1}{2}$ deniers per one dram avoirdupois.

As the old systems of counts have some technical conveniences they will no doubt be retained for some time. In some districts, especially in Yorkshire, the count is based on the number of yards per ounce, and in others the older method of drams avoirdupois per 1000 yard skein. The English cotton yarn and spun silk counts are reckoned upon the number of hanks of 840 yds. in 1 lb of silk, cotton being reckoned upon the single thread and spun silk on the doubled or finished thread. Thus $2/40^{\circ}$ cotton indicates single 40° doubled to 20 hanks by 840 yds. to the lb., while $40/2$ fold spun silk means a single 80° doubled to give 40 hanks of 840 yds. to the lb. All continental conditioning establishments now formulate their tests for counts on the agreement arrived at by the International Congress of 1900.

Conditioning.—Silk in the raw and thrown state absorbs a large amount of moisture, and may contain a percentage of water without being manifestly damp. As it is largely sold by weight it becomes necessary to ascertain its condition in respect of absorbed water, and for that purpose official conditioning houses are established in all the considerable centres of silk trade. In these the silk is tested or conditioned, and a certificate of weight issued in accordance with the results. The silk is for four hours exposed to a dry heat of 230° F., and immediately thereafter weighed. To the weight 11% is added as the normal proportion of water held by the fibre.

Scouring.—Up to this point the silk fibre continues to be comparatively lustreless, stiff and harsh, from the coating of albuminous matter (gum or *grès*) on its surface. As a preliminary to most subsequent processes the removal of the whole or some portion of this gum is necessary by boiling-off, scouring or *décreusage*. To boil off say 300 lb of thrown silk, about 60 lb of fine white soap is shred, and dissolved in about 200 gallons of pure water. This solution is maintained at a heat of 195° , and in it the hanks of raw silk are immersed, hung on a wooden rod, the hanks being continually turned round so as to expose all portions equally to the solvent influence of the hot solution. After being dried, the hanks are packed in linen bags and boiled for three hours in a weaker soapy solution, then washed out in pure warm water and dried in a centrifugal hydro-extractor. According to the amount of gum to be boiled off the soap solutions are made strong or weak; but care has to be exercised not to overdo the scouring, whereby loss of strength, substance and lustre would result. For some purposes—making of gauzes, crapes, flour-bolting cloth and for what is termed “souples”—the silk is not scoured, and for silks to be dyed certain dark colours half-scouring is practised. The perfect scouring of silks removes from 20 to 27% of their weight, according to the character of the silk and the amount of soap or oil used in the working. Scouring renders all common silks, whether white or yellow in the raw, a brilliant pearly white, with a delicate soft flossy texture, from the fact that the fibres which were agglutinated in reeling, being now degummed, are separated from each other and show their individual tenuity in the yarn. Silks to be finished white are at this point bleached by exposure in a closed chamber to the fumes of sulphurous acid, and at the close of the process the hanks are washed in pure cold water to remove all traces of the acid.

Silk Weighting.—Into the dyeing of silk it is not here necessary to enter, except in so far as concerns a nefarious practice, carried on in dye-houses, which has exercised a most detrimental influence on the silk trade. Silk, we have seen, loses about one-fourth of its weight in scouring. To obviate that loss it has long been the practice to dye some dark silks “in the gum,” the dye combining in these cases with the gum or gelatinous coating, and such silks are known as “souples.” Both in the gum and in the boiled-off state silk has the peculiar property of imbibing certain metallic salts largely and combining very firmly with them, the fibre remaining to external

appearance undiminished in strength and lustre, but much added to in size and weight. Silk in the gum, it is found, absorbs these salts more freely than boiled-off; so to use it for weighting there are these great inducements—a saving of the costly and tedious boiling-off, a saving of the 25% weight which would have disappeared in boiling and a surface on which much greater sophistication can be practised than on scoured silk. In dyeing a silk black a certain amount of weight must be added; and the common practice in former times was to make up on the silk what was lost in the scouring. Up to 1857 the utmost the dyer could add was “weight for weight,” but an accidental discovery that year put dyers into the way of using tin salts in weighting with the result that they were enabled to add 40 oz. to scoured silk, 120 oz. to *souples* and as much as 150 oz. to spun silks. This excessive adulteration quickly worked its own cure by a decreased consumption, and the weighting in practice in 1910 is confined to moderate and safer limits. The use of tin salts, especially stannic chloride, SnCl_4 , enables dyers to weight all colours the same as black. In his “Report on English Silk Industry” to the Royal Commission on Technical Instruction (1885) Sir Thomas Wardle of Leek says:—

“Colours and white of all possible shades can very easily be imparted to this compound of silk and tin, and this method is becoming extensively used in Lyons. Thus weighting, which was until recently thought to apply only to black silks, and from which coloured silks were comparatively free, is now cheapening and deteriorating the latter in pretty much the same ratio as the former. Thus the proto- and per-salts of iron, as well as the proto- and per-salts of tin, including also a large variety of tannin, sumac, divi-divi, chestnut, valonia, the acacias (*Areca Catechu* and *Acacia Catechu* from India), from which are obtained cutch and gambier, &c., are no longer used solely as mordants or tinctorial matters, but mainly to serve the object of converting the silk into a greatly-expanded fibre, consisting of a conglomeration of more or less of these substances.”

Sugar also is employed to weight silk. On this adulterant Sir Thomas Wardle remarks:—

“With a solution of sugar, silk can have its weight augmented from 1 oz. to 3 oz. per lb. I am not quite sure that this method of weighting was not first used by the throwsters, as sugar is known to have been used for adulterating and loading gum silk for a very long time, and then the idea was afterwards applied to silk after the dyeing operations. It is much resorted to for weighting coloured silks by dyers on the continent, and, though a very clumsy method, no substitute has been found so cheap and easy of application. Bichloride of tin, having chemical affinity for silk fibre, bids fair to extinguish the use of sugar, which, from its hygrometric qualities, has a tendency to ruin the silk to which it is applied, if great care be not taken to regulate the quantity. There is not the slightest use or excuse for the application of sugar, except to cheapen the silk by about 15 to 20%.”

Wild Silk Dyeing.—Among the disadvantages under which the silks of the wild moths long laboured one of the most serious was the natural colour of the silks, and the extreme difficulty with which they took on dyes, specially the light and brilliant colours. For success in coping with this difficulty, as well as in dealing with the whole question of the cultivation and employment of wild silks, the unwearied patience and great skill of Sir Thomas Wardle of Leek deserve special mention here. The natural colour of tussur silk is a greyish fawn, and that shade it was found impossible to discharge by any of the ordinary bleaching agents, so as to obtain a basis for light and delicate dyes. Moreover, the chemical character of the tussur silk differs from that of the mulberry silk, and the fibre has much less affinity for tinctorial substances, which it takes up unevenly, requiring a large amount of dye-stuffs. After protracted experimenting Sir Thomas Wardle was able in 1873 to show a series of tussurs well dyed in all the darker shades of colour, but the lighter and bright blues, pinks, scarlets, &c., he could not produce. Subsequently Tessie du Motay found that the fawn colour of natural tussur could be discharged by solution of permanganate of potash, but the oxidizing action was so rapid and violent that it destroyed the fibre itself. Gentler means of oxidation have since been found for bleaching tussur to a fairly pale ground. The silk of the eria or castor-oil worm (*Attacus ricini*) presents the same difficulties in dyeing as the common tussur. A portion of the eria cocoons are white, while the others are of a lively brown colour, and for the dyeing of light colours the latter require to undergo a bleaching process. The silk takes up colour with difficulty from a strong vat, and is consequently costly to dye. Moonga silk from *Antheraea assama* has generally a rather dark-brown colour, but that appears to be much influenced by the leaves on which the worm feeds, the cocoons obtained on the champaca tree (*Michelia champaca*) giving a fine white fibre much valued in Assam. The dark colours are very difficult to bleach, but the silk itself takes dye-colours much more freely and evenly than either tussur or eria silk. (F. W. *)

Trade and Commerce.

About the beginning of the 19th century the chief silk-producing regions of the world were the Levant (including Broussa, Syria and Persia), India, Italy and France, the two first named sending the low-priced silk, the other two the fine qualities.

TABLE I.—Raw Silk: Production and Importation.

	Average for Five Years.					1898.	1907.	1908.
	1876 to 1880.	1881 to 1885.	1886 to 1890.	1891.	1892.			
France	11,220	13,882	15,224	12,452	14,080	14,504	14,430	
Italy	41,800	66,720	72,824	70,020	65,230	106,040	98,600	
Spain	1,430	1,802	1,584	1,980	1,564	1,650	1,650	
Austria-Hungary 1	1,430	3,360	5,830	6,782	4,850	7,920	7,920	
Brutia	1,870	3,080	4,082	2,970	4,532	7,920	7,920	
Syria and Cyprus	3,450	5,170	6,088	6,380	7,700	14,630	13,530	
Salonica and Adrianople	1,782	2,222	2,948	4,280	4,840	11,770	10,780	
Bulgaria, 2 Serbia and other provinces	7,480	7,480	
Greece and Crete	4,180	4,180	
Caucasus	1,672	1,672	
	6,380	4,570	2,040	4,180	3,900	10,780	7,920	
1 Persia 3 and Turkey	13,816	11,570	
2 Shanghai 4	93,704	124,040	
3 Canton	48,200	49,300	
4 Japan	43,104	52,320	
Exports	131,825	139,700	
Imports	7,150	5,500	
Total in Bales of 100 lb	104,790	207,636	255,200	291,280	297,836	487,606	529,770	
Price per lb of No. 4 Tsaltee, Maximum and Minimum 5	28/-	17/-	15/-	14/-	13/3	16/-	11/6	
	15/-	13/9	11/6	11/9	12/-	13/-	9/6	

1 Austria-Hungary before 1881 was included with Italy.
 2 Before 1900 there is no account of silk from Bulgaria.
 3 Before 1897 there is no account of exportation from Persia.

4 Before 1890 the exportation from Shanghai did not include Tussah.
 5 From 1905 the exports from India include Cashmere silks coming by Bombay.
 6 The prices are based upon the Blue Elephant Chap, although quality has deteriorated in the past few years.

Between 1840 and 1850, after the opening of trade with China, large quantities of silk were sent from the northern port of Shanghai, and afterwards also from the southern port of Canton. The export became important just at the time when disease in Europe had lessened the production on the continent. This increased production of medium silk, and the growing demand for fine sorts, induced many of the cocoon-growers in the Levant to sell their cocoons to Europeans, who reeled them in Italian fashion under the name of "Patent Brutia," thus producing a very fine valuable silk. In 1857 commenced the exportation of Japan silk, which became so fierce a competitor with Bengal silk as gradually to displace it in favour; and the native silk reeled in Bengal has almost ceased to be made, only the best European filatures, produced under the supervision of skilled Europeans, now coming forward.

China and Japan, both of which contribute so largely to the supplies that appear in European and American statistics, only export their excess growth, silk-weaving being carried on and native silk worn to an enormous extent in both countries. The other Asiatic exporting countries also maintain native silk manufactures which absorb no inconsiderable proportion of their raw material. Since about 1880 the silk production of the world (including only exports from the East) has more than doubled, the variations owing to partial failures from some countries being more than compensated by increase from others. The supplies available for European and American consumption have been carefully tabulated by the Lyons Chamber of Commerce, as shown by the table.

While the tables indicate the fluctuations of supply they show generally that Asiatic countries, in addition to supplying the necessities for their home trade, export to Europe and America about three-fifths of the whole of the silk consumed in Western manufactures.

Up to the year 1860 the bulk of the silks from the East was shipped to London, but subsequently, owing to the importance of continental demands, a large portion of the supplies has been unshipped at Genoa and Marseilles (especially the finer reeled silks from Japan and Canton), which are sold in the Milan and Lyons markets. Those for American consumption are sent direct by the Pacific route via San Francisco. Table II. shows the official annual returns of silk imports into Great Britain from 1880 to 1908.

TABLE II.—Imports of Silk into Great Britain.

Years.	Raw Silk.	Knubs or Husks of Silk and Waste.	Thrown Silk.	Silk (including Lace, &c.) Manufacture.
1880	3,673,949	55,002	203,567	13,329,935
1884	4,522,702	67,239	323,947	10,984,073
1888	3,065,771	83,466	559,289	10,466,537
1892	1,503,283	46,392	502,777	11,412,263
1896	1,697,668	62,923	572,599	16,923,176
1900	1,413,320	60,720	664,641	14,767,610
1901	1,332,480	48,162	624,859	13,708,645
1902	1,252,848	55,782	802,964	14,320,541
1903	1,109,930	66,782	662,677	13,493,961
1904	1,337,579	71,450	769,297	13,585,462
1905	1,160,265	72,055	878,850	13,010,766
1906	1,036,258	66,348	924,007	13,069,588
1907	1,195,366	66,299	938,112	12,862,834
1908	1,110,481	64,669	809,610	11,907,661

The power loom, owing to the improvement in its mechanism, has gained a distinct precedence and materially increased its producing power. In the development of silk manufacture the hand loom has taken a very secondary position. In order to form a relative idea of the importance of the various countries engaged in silk manufacture, a tabulation of the number of looms employed in each country would prove an inadequate guide, owing to the variations from time to time of the fabrics woven, as also to the difficulty in obtaining trustworthy statistics of the number in active operation. The production and consumption of raw material shown in Table III. was prepared by Messrs Chabrières, Morel & Co. of Lyons, Marseilles and Milan, and issued in 1905.

America takes a premier position in consumption of the raw material. The development and expansion of silk manufacture, owing to the importance and extent of the home market, coupled with high protective tariffs, has been enormous. In 1867 the import of raw material amounted to 491,983 lb. In 1905 a record was reached of 17,812,133 lb. During the decade of 1898 to 1908 the consumption has gone on steadily from about 10 million lb in the first five years to an average of 15 million lb in the second half of the decade. France comes a good second in importance with a

consumption of 9 to 10 million lb annually. Lyons is the headquarters of the trade, principally in the production of dress fabrics, plain and figured, and other light and heavier fabrics. St Étienne and St Chamond are important centres for the ribbon trade. There

TABLE III.—Production and Consumption of Raw Material.

	PRODUCTION. Average of Seasons 1903-1904, 1904- 1905, 1905-1906.	CONSUMPTION. Same Average of Years 1902-1903, 1904.
Europe—		
France	1,276,000	9,519,400
Italy	9,233,400	2,125,200
Switzerland	99,000	3,509,000
Spain	176,000	402,600
Austria	360,800	1,707,200
Hungary	323,400	
Russia and Caucasus	893,200	2,796,200
Bulgaria, Servia and Roumania	343,200	37,400
Greece and Crete	138,600	44,000
Salonica and Adrianople	574,200	66,000
Germany	Nil.	6,261,200
Great Britain	Nil.	1,559,800
America—		
United States	Nil.	13,481,600
Asia—		
Brutia	1,207,800	66,000
Syria	1,100,000	242,000
Persia (Exports)	556,600	(no estimates)
Turkestan	600,600	"
China	8,960,600	"
Canton, China	4,661,800	"
Japan	11,136,400	"
India	563,200	770,000
Tonquin and Annam	22,000	(no estimates)
Africa—		
Egypt	Nil.	440,000
Morocco	Nil.	154,000
Algeria, Tunis	Nil.	143,000
Various countries	Nil.	121,000
Total lb	42,226,800	43,445,000

N.B.—The difference in the totals is owing to the figures being based on the production in seasons, and that of consumption upon calendar years.

are also important manufactures of silk at Calais, Paris, Nîmes, Tours, Avignon and Roubaix. Germany follows France with a consumption for the various fabrics of over six million lb annually. The principal seat of the trade in that country is at Crefeld, nearly one-half of the production of the empire being manufactured there. Velvet is the special feature of the industry, about one-half of the looms being devoted to this textile, the remainder being devoted to union satins, pure broad silk goods and ribbons. Other principal centres of the silk trade in Rhenish Prussia are Viersen, Barmen, Elberfeld and Mühlheim. The province of Saxony has also important manufactures of lace and glove fabrics. Third on the list of continental producers is Switzerland; Zürich takes the lead with broad goods (faillies, armures, satins, serges, &c.), and Basel rivals St Étienne in the ribbon trade. Russia, by a prohibitive tariff on manufactured silks of other countries, has since 1890 developed and fostered a trade which consumes annually about 3 million lb of raw material for its home industry. This has also stimulated silk culture in the Caucasus, from which province it draws about one-third of its supplies. A special feature of its manufactures consists of gold and silver tissues and brocades for sacerdotal use. Moscow is one of the principal seats for the weaving of these fabrics. Italy, the early home of the silk trade in Europe, the land of the gorgeous velvets of Genoa and the damasks and brocades of medieval Sicily, Venice and Florence, now takes only a sixth place, the centre of greatest activity being at Como; but Genoa still makes velvets, and the brocades of Venice are not a thing of the past. Austria and England follow on the list of important silk manufactures. The former has found its principal development in Vienna and the immediate neighbourhood. By special grants from the Hungarian government silk-reeling has been fostered and encouraged. In 1885 the production of raw silk was about 300,000 lb, while in 1905 it reached 750,000 lb, an annual production which is still maintained.

In the United Kingdom all the silk industries (those depending on spun silk alone excepted) have been declining since the French Treaty of 1860 came into operation. This cannot be gauged by the

decrease in imports of raw material from the fact before mentioned that formerly London was the centre of distribution for Eastern silk, which is now disembarked at other European ports for continental consumption. The shrinkage is the more noticeable in the throwing branch of the industry. Many of the mills formerly in operation in Derby, Nottingham, Congleton and Macclesfield have been closed owing to the importation of foreign thrown silks from Italy and France, where a lower rate of wages is paid to the operatives employed in this branch. In like manner the manufacture of silk fabrics in the districts of Manchester, Middleton, Macclesfield, London (Spitalfields) and Nottingham (for silk lace) has decreased proportionately. Against this we must set off a decided increase in the manufacture of mixed goods, carried on principally in Scotland, Yorkshire and Lancashire.

The remarkable development of the comparatively new trade in spun silk goes far to compensate for the loss of the older trade of net silk, and has enabled the exports of silk manufactures from Great Britain to be at least maintained and to show some signs of expansion. Silk spinning has chiefly developed in the Yorkshire, Lancashire, Cheshire and Staffordshire textiles centres. Its expansion and importance may be seen from the fact that the imports of waste, knubs, &c., which in 1860 was 1506 cwts., reached in 1905 a record of 72,055 cwts. But it is highly significant that while the exports of British silk manufactures have not decreased, the imports in the meantime have shown a marked expansion. Although the use of silk goods has unquestionably increased since the middle of the 19th century, the expansion of native productions has not kept pace with that growth. (R. SN.)

The Spinning of "Silk Waste."

The term *silk waste* includes all kinds of raw silk which may be unwindable, and therefore unsuited to the throwing process. Before the introduction of machinery applicable to the spinning of silk waste, the refuse from cocoon reeling, and also from silk winding, which is now used in producing spun silk fabrics, hosiery, &c., was nearly all destroyed as being useless, with the exception of that which could be hand-combed and spun by means of the distaff and spinning wheel, a method which is still practised by some of the peasantry in India and other Eastern countries.

The supply of waste silk is drawn from the following sources: (1) The silkworm, when commencing to spin, emits a dull, lustreless and uneven thread with which it suspends itself to the twigs and leaves of the tree upon which it has been feeding, or to the straws provided for it by attendants in the worm-rearing establishments: this first thread is unreelable, and, moreover, is often mixed with straw, leaves and twigs. (2) The outside layers of the true cocoon are too coarse and uneven for reeling;

TABLE IV.—Silk Goods exported from the United Kingdom.

Year.	Raw Silk.	Knubs, Husks, Silk Waste and Noils.	Thrown and Spun Silk.		Silk Manufactures.	
			British.	Foreign and Colonial.	British.	Foreign and Colonial.
	lb.	cwts.	£	lb.	£	£
1860	3,153,993	1,506	826,107	426,866	1,587,303	224,366
1865	3,137,292	1,212	767,058	306,701	1,404,381	166,936
1870	2,644,402	4,167	1,154,364	39,771	1,450,397	166,297
1875	2,551,417	1,779	880,923	87,924	1,734,519	328,426
1880	947,165	9,241	683,591	7,553	2,030,659	259,023
1884	377,349	6,538	612,951	50,559	2,175,410	644,722
1888	167,086	7,438	388,828	63,192	2,664,244	727,673
1892	164,150	7,397	322,894	32,574	1,655,310	730,316
1896	142,034	5,053	265,142	74,140	1,423,174	725,123
1900	192,616	5,691	425,647	35,858	1,637,915	919,011
1901	244,566	5,370	294,311	48,666	1,429,381	1,021,637
1902	152,463	6,160	237,718	95,862	1,393,314	1,071,633
1903	178,458	9,740	256,341	81,707	1,436,734	1,038,634
1904	186,174	9,148	218,881	43,938	1,604,554	1,241,242
1905	188,246	13,524	298,299	53,825	1,693,314	1,142,217
1906	92,124	3,243	323,873	57,143	1,858,634	1,094,657
1907	80,645	5,007	401,336	47,404	2,009,613	1,490,066
1908	42,898	6,571	101,316	43,714	1,244,546	1,427,974

and as the worm completes its task of spinning, the thread becomes finer and weaker, so both the extreme outside and inside layers are put aside as waste. (3) Pierced cocoons—i.e. those from which the moth of the silkworm has emerged—and damaged cocoons. (4) During the process of reeling from the cocoon the silk often breaks; and both in finding a true and

reelable thread, and in joining the ends, there is unavoidable waste. (5) Raw silk skeins are often re-reeled; and in this process part has to be discarded: this being known to the trade as gum-waste. The same term—gum-waste—is applied to “waste” made in the various processes of silk throwing; but manufacturers using threads known technically as organzines and trams call the surplus “manufacturer’s waste.” Finally we have the uncultivated varieties of silks known as “wild silks,” the chief of which is tussur. The different qualities of “waste,” of which there are many, vary in colour from a rich yellow to a creamy white; the chief producing countries being China, Japan, India, Italy, France and the countries in the Near East; and the best-known qualities are: steam wastes, from Canton; knubs, from China and from Italy and other Western countries; frisons, from various sources; wadding and blaze, Shanghai; china, Hangchow; and Nankin buttons; Indian and Szechuen wastes; punjum, the most lustrous of wastes; China curls; Japan wastes, known by such terms as kikai, ostue, &c.; French, Swiss, Italian, China, Piedmont, Milan, &c. There are yellow wastes from Italy, and many more far too numerous to mention.

A silk “throwster” receives his silk in skein form, the thread of which consists of a number of silk fibres wound together to make a certain diameter or size, the separate fibre having actually been spun by the worm, and this fibre may measure anything from 500 to 1000 yds. in length. The silk-waste spinner receives his silk in quite a different form: merely the raw material, packed in bales of various sizes and weights, the contents being a much-tangled mass of all lengths of fibre mixed with much foreign matter, such as ends of straws, twigs, leaves, worms and chrysalis. It is the spinner’s business to straighten out these fibres, with the aid of machinery, and then to so join them that they become a thread, which is known as spun silk.

There are two distinct kinds of spun silk—one called “schappe” and the other “spun silk” or “discharged spun silk.” All silk produced by the worm is composed of two substances—fibroin, the true thread, and sericin, which is a hard, gummy coating of the “fibroin.” Before the silk can be manipulated by machinery to any advantage, the gum coating must be removed, really dissolved and washed away—and according to the method used in achieving this operation the result is either a “schappe” or a “discharged yarn.” The former, “schapping,” is the French, Italian and Swiss method, from which the silk when finished is neither so bright nor so good in colour as the “discharged silk”; but it is very clean and level, and for some purposes absolutely essential, as, for instance, in velvet manufacture.

Schapping.—The method is as follows: If waste silk is piled in a heap in a damp, warm place, and kept moist and warm, the gum will in a few days’ time begin to ferment and loosen, and can then be washed off, leaving the true thread soft and supple; but the smell caused by the fermentation is so offensive that it cannot be practised in or near towns. Therefore schappe spinners place their degumming plant in the hills, near or on a stream of pure water. The waste silk is put into large kilns and covered with hot water (temperature 170° F.). These are then hermetically closed, and left for a few hours for the gum to ferment and loosen. When thoroughly softened—the time occupied depending on the heat of the water and nature of the silk—the contents of the kiln are taken out and placed into vats of hot water, and allowed to soak there for some time. Thence the silk is taken to a washing machine, and the loosened gum thoroughly washed away. The silk is then partly dried in a hydro-extractor, and afterwards put in rooms heated by steam-pipes, where the drying is completed.

“Discharging” is the method generally used by the English, and results in a silk having brilliance and purity of colour. In this process the silk waste is put into strong, open-meshed cotton bags, made to hold (in accordance with the wish of individual spinners) from 1 lb to 5 lb in weight. When about 100 lb of silk has been bagged, the whole is placed in a large wooden tub and covered with boiling water in which 12 to 20 lb of white curd soap has previously been dissolved. In this the silk is boiled from one to two hours, then taken out and put through a hydro-extractor to remove the dirty gummy solution. Afterwards it is put into another tub of soapy liquor, and boiled from one to one and a half hours. It is then once more hydro-extracted, and finally taken to a stove and dried: “Discharged silk” must be *entirely free* from gum when

finished, where “schappe” contains a percentage of gum—sometimes as much as 20%.

From this stage both classes of silk receive much the same treatment, differing widely in detail in different mills and districts.

Conditioning.—The “degummed silk,” after it is dried, is allowed to absorb a certain amount of moisture, and thus it becomes soft and pliable to the touch, and properly conditioned for working by machinery.

Beating.—When the waste contains any large percentage of worm or chrysalis, it is taken to a “cocoon beater,” a machine which has a large revolving disk on which the silk is put, and while revolving slowly is beaten by a leather whip or flail, which loosens the silk and knocks out the wormy matter. After the beating, the silk presents a more loose appearance, but is still tangled and mixed in length of fibre. The object of the spinner at this point is to straighten out the tangles and lumps, and to lay the fibres parallel: the first machine to assist in this process being known as an opening machine, and the second as a filling engine.

Opening and Filling.—The silk to be opened is placed on a latticed sheet or feeder, and thus slowly conveyed to a series of rollers or porcupines (rollers set with rows of projecting steel pins), which hold the silk firmly while presenting it to the action of a large receiving drum, covered with a sheet of vulcanized rubber, set all-over with fine steel teeth. As the drum revolves at a good speed, the silk is drawn by the steel teeth through the porcupines into the drum in more or less straight and parallel fibres. When the teeth are full the machine is stopped, and the silk stripped off the drum, then presenting a sheet-like appearance technically known as a “lap.” The lap is taken to the filling engine, which is similar in construction and appearance to the opener as far as the feeding arrangements are concerned, but the drum, in place of being entirely covered with fine steel teeth, is spaced at intervals of from 5 to 10 in. with rows of coarser straight teeth, each row set parallel with the axle of the machine. The silk drawn by the rows of teeth on the drum through the porcupine rollers (or porcupine sheets in some cases) covers the whole of the drum, hooked at certain intervals round the teeth; and when a sufficient weight is on the machine, it is stopped, and an attendant cuts, with a knife, the silk along the back of each row of teeth, thus leaving a fringe of silk hooked on the pins or teeth. This fringe of silk is placed by the attendant between two hinged boards, and whilst held firmly in these boards (called book-boards) is pulled off the machine, and is called a “strip”; the part which has been hooked round the teeth is called the “face,” and the other portion the “tail.” By these means the silk has been opened, straightened and then cut into a certain length, the fibres now being fairly laid parallel and ready for the next operation, known as silk dressing.

Silk Dressing.—This is the process equivalent to combing in the wool industry. Its purpose is to sort out the different lengths of fibre, and to clear such fibres of their nibs and noils. There are two well-known principles of dressing: one known as “flat frame,” giving good result with discharged silk, and the other known as “circular frame” dressing, suitable for schappes.

The flat dressing frame is a box or frame holding a certain number of book-boards from the filling engine, which boards when full of silk are screwed tightly together in the frame. The frame is capable of being raised into contact with travelling combs, affixed to an endless belt placed round two metal rollers about 6 ft. apart. The attendant allows the silk to enter gradually into close contact with the combs, which comb through the silk in exactly the same manner as a lady combs her tresses. In a circular frame the silk is clamped between boards, and these are fixed on a large drum. This drum revolves slowly, and in its revolution conveys the fringes of silk past two quickly running smaller combing drums. These combing drums being covered with fine steel teeth penetrate their combs through the fringes of silk depending from the large drum, thus combing through the silk. In each machine the object is the same. First the filled silk is placed into a holding receptacle, clamped fast, and presented to combing teeth. These teeth retain a certain proportion of shorter fibre and rough places and tangled portions of silk, which are taken off the combs in a book-board or wrapped round a stick and again presented to the combs. This fibre again yields combings which will also be combed, and so on for five or six times until the combings are too short, and are taken from the machine and known as noils. The productions from these several combings are known as “drafts” and are of different lengths: the product of the filled silk first placed in the dressing frame being the longest fibre and of course the most valuable.

The flat frame is the most gentle in its usage of the silk, but is most costly in labour; whilst the circular frame, being more severe in its action, is not suitable for the thoroughly degummed silks, but on the other hand is best for silks containing much wormy matter, because the silk hanging down into the combing teeth is thoroughly cleansed of such foreign matter, which is deposited under the machine. This method also has the advantage of being cheaper in cost of labour. Recently a new machine has been invented giving the same results as circular frame: the silk depends from boxes into combs, and at the same time has the gentle action of the flat frame. The cost of the operations is as cheap as the circular frame, therefore the machine combines the advantages of each of its predecessors.

Noils.—The noils resulting from the dressing operations are sometimes combed, the comb used being similar to those used in the cotton trade. The resulting sliver is used by silk spinners who make a speciality of spinning short fibres, and the exhaust noils are bought by those who spin them up into "noil yarns" on the same principle as wool. The yarns are chiefly used by manufacturers of powder bags. The noils are also in great demand for mixing with wool to make fancy effects in wool cloths for the dress goods trade.

Drafts.—The drafts from the dressing frame are valued in accordance with their length of fibre, the longest being known as A or 1st drafts and so on:—

	1st	2nd	3rd	4th	5th	6th
	Drafts.	Drafts.	Drafts.	Drafts.	Drafts.	Drafts.

or as quality	A	B	C	D	Shorts.	
---------------	---	---	---	---	---------	--

Each draft may be worked into a quality of its own, and by such means the most level yarns are obtained. But occasionally one or more drafts are mixed together, when price is the determining factor.

Processes peculiar to Silk Spinning Industry.—The foregoing processes are all peculiar to the silk waste trade, no other fibre having to go through such processes, nor needing such machinery. In the first stages of the spun-silk industry, the silk was dressed before boiling the gum out; the resulting drafts were cut into lengths of one or two inches. The silk was then boiled and afterwards beaten, scutched, carded, drawn, spun, folded, &c., in exactly the same way as fine cotton. Short fibre silks are still put through cards and treated like cotton; but the value of silk is in its lustre, elasticity and strength, which characteristics are obtained by keeping fibres as long as possible. Therefore, when gill drawing machinery was invented, the cutting of silk into short fibres ceased, and long silks are now prepared for spinning on what is known as "long spinning process." Following the process of dressing, the drafts have to go through a series of machines known as preparing machines: the object being to piece up the lengths of fibre, and to prepare the silk for spinning.

Preparing or Drawing Machinery.—A faller or gill drawing machine consists of a long feeding sheet which conveys silk to a pair of rollers (back rollers). These rollers present the silk to a set of fallers (steel bars into which are fixed fine steel pins), which carry forward the silk to another pair of rollers, which draw the silk through the pins of the fallers and present it to the rollers in a continuous way, thus forming a ribbon of silk called a "sliver." The fallers are travelled forwards by means of screws, and when at the end of the screw are dropped automatically into the thread of a receiving screw fixed below, which carries the fallers back to their starting point to be risen by cams into the top pair of screws thus to repeat their journey.

Silk Spreader.—This is the first of the series of drawing machines. The drafts from the dressing frame are made into little parcels of a few ounces in weight, and given to the spreader, who opens out the silk and spreads it thinly and evenly on to the feeding sheet, placing a small portion of the silk only on the sheet. Another portion is opened out and placed tail end to the first portion; and these operations are repeated until the requisite weight is spread. During this time the silk has been conveyed through the fallers and into a large receiving drum about 3 ft. in diameter, the silk being wrapped thinly and evenly all round the circumference of the drum. When the agreed-on weight is on the drum, the silk is drawn across the face of the drum parallel with its axle, and pulled off in form of a sheet, and is called a lap. This lap is thin, but presents the fibres of silk now joined and overlapped in a continuous form, the length measured by the circumference of the drum. This lap is sometimes re-spread to make it more even, and at other times taken to a drawing machine which delivers in a sliver form. This sliver is taken through a series of four other drawing machines called "four head drawing box." Eight or more slivers are put behind the first drawing head, conveyed through the fallers and made into one sliver in front of the machine. This sliver is put up behind the second drawing; eight or more ends together run through the second head again into one sliver; and so on through the third and fourth heads of drawing. All these doublings of the sliver and re-drawing are for the purpose of getting each fibre to lie parallel and to make the sliver of an equal weight over every yard of its length. From the last head of drawing the sliver is taken to a machine known as a gill rover. This is a drawing machine fitted with fallers through which the sliver is drawn, but the end from the front roller is wound on to a bobbin. The machine is fitted with 20 to 40 of these bobbins placed side by side, and its product is known as "slubbing roving," it being now a soft, thick thread of silk, measuring usually either 840 or 1260 yds. to 1 lb weight. Hitherto all the drawing has been by rollers and fallers, but in the next machine the drawing is done by rollers only.

Dandy Roving Frame.—This is a frame built with forty or more spindles. Two or three slubbing rovings are put up behind the machine opposite each spindle; each end is guided separately into back rollers and thence between smaller rollers, known as carrier rollers, to the front rollers. The back rollers revolve slowly, the front rollers quickly, thus drawing the rovings out into a thinner size or count. The product is wound on to the bobbin by means of flyer and spindle, and is known as dandied or fine roving, and is then ready for the spinning frame.

Spinning.—The spinning is done by exactly the same methods

as cotton or worsted, viz. either mules, ring frames, cap or flyer frames, the choice of machine being determined by the size or count of yarn intended to be produced.

Twisting and Doubling.—If a 2-fold or 3-fold yarn is needed, then two or more ends of the spun thread are wound together and afterwards conveyed to the twisting frame for the purpose of putting the needed twist in the yarn necessary for weaving or other requirements. This process is exactly the same as in the cotton or worsted industry, ring or flyer frames being used as desired.

Weft Yarns.—These are taken straight from the spinning frame, wound on to a long paper tube and so delivered to the manufacturer ready to place in the loom shuttle.

Folded Yarns are hairy after being spun and folded, and in addition sometimes contain nibs and rough places. The fibre and nibs have to be cleaned off by means of a gassing machine so constructed that the end of silk (silk yarn) is frictioned to throw off the nibs, and at the same time is run very rapidly through a gas flame a sufficient number of times to burn off the hairy and fibrous matter without injuring the main thread. The yarn is now ready for reeling into skeins or for warping, both of which operations are common to all the textile yarns. It may be washed or dyed just as required, either in hank or in warp.

Growth of Industry and Uses of Spun Silk.—As will have been gathered, spun silk is pure silk just as much as that used by the throwster. The spinning industry has not decreased in England. The number of mills has decreased, but machinery now runs so much more quickly than formerly that more yarn is being spun on fewer spindles. The American spinning industry shows little signs of expansion in spite of a protective tariff of some 35%. The continental spinners have largely increased, but are developing into huge syndicates, all working on the schappe principle. The three chief syndicates, one each in Italy, France and Switzerland, work very much together, practically ruling the prices for yarns and raw materials.

Spun silks are used largely for silk linings, hosiery, sewing threads, elastic webbing, lace, plush and many other purposes, such as mufflers, dress goods and blouse silks; also for mixing with other fibres in form of stripes in the weaving of various fabrics, or to be used in what are known as mixed goods, i.e. a warp of silk and weft of some other fibre or weft of silk and a warp of cotton or other fibre. The article known as tussur spun is prepared in exactly the same manner as other spun silks, but its chief use is to make an imitation of sealskin known commercially as silk seal. (A. MEL.)

SILL, EDWARD ROWLAND (1841–1887), American poet and educationist, was born at Windsor, Connecticut, on the 29th of April 1841. He graduated at Yale in 1861, as class poet; engaged in business in California; entered the Harvard Divinity School in 1867, but soon left it for a position on the staff of the *New York Evening Mail*; and after teaching at Wadsworth and Cuyahoga Falls, Ohio (1868–1871), became principal of the Oakland High School, California. He was professor of English literature at the university of California in 1874–1882. His health was failing, and he returned to Cuyahoga Falls in 1883. He devoted himself to literary work, abundant and largely anonymous, until his death in Cleveland, Ohio, on the 27th of February 1887. Much of his poetry was contributed to the *Atlantic Monthly*, the *Century Magazine*, and the *Overland Monthly*. Many of his graceful prose essays appeared in "The Contributors' Club," and others appeared in the main body of the *Atlantic*. Among his works are a translation of *Rau's Mozart* (1868); *The Hermitage and Other Poems* (1868); *The Venus of Milo and Other Poems* (1883), a farewell tribute to his California friends; *Poems* (1887); *The Hermitage and Later Poems* (1889); *Hermione and Other Poems* (1900); *The Prose of Edward Rowland Sill* (1900); *Poems* (1902). He was a modest and charming man, a graceful essayist, a sure critic. His contribution to American poetry is small but of fine quality. His best poems, such as *The Venus of Milo*, *The Fool's Prayer* and *Opportunity*, gave him a high place among the minor poets of America, which might have been higher but for his early death.

See *A Memorial* volume privately printed by his friends in 1887; and "Biographical Sketch" in *The Poetical Works of Edward Rowland Sill* (Boston, 1906), edited by William Belmont Parker with Mrs Sill's assistance.

SILL (O. Eng. *syl*, Mid. E. *syll*, *selle*; the word appears in Icel. *syll*, *svill*, Swed. *syll*, and Dan. *syld*, and in German, as *Schwelle*; Skeat refers to the Teutonic root *swal*-, *swell*, the word meaning the rise or swell formed by a beam at a threshold; the Lat. *solea*, from which comes Fr. *seuil*, gives Eng. "sole," also sometimes used for "sill"), the horizontal base of a door or window-frame. A technical distinction is made between the inner or wooden base

of the window-frame and the stone base on which it rests—the latter being called the sill of the window, and the former that of its frame. This term is not restricted to the bases of apertures; the lower horizontal part of a framed partition is called its sill. The term is sometimes incorrectly written "cill." (See MASONRY.)

SILL, in geology, an intrusive mass of igneous rock which consolidated beneath the surface and has a large horizontal extent in comparison with its thickness. In the north-eastern counties of England there is a great mass of this kind known as the Whin Sill. The term "whin" is used in many parts of England and Scotland to designate hard, tough, dark coloured rocks often of igneous origin, and the Whin Sill is a mass of dolerite or, more strictly, quartz-diorite. Its most striking character is the great distance over which it can be traced. It starts not far north of Kirkby Stephen (Co. Durham) and follows a northerly course, describing a great curve with its convexity towards the west, till it ends on the sea-shore at Bamborough, not far south of Berwick-on-Tweed. The length of the outcrop is about 80 m., but in places it is covered with superficial deposits or may be actually discontinuous. Near Haltwhistle, however, it is visible for about 20 m., and as it lies among softer rocks (limestones and shales), it weathers out on a bold craggy ridge or escarpment. When it crosses the streams the resistant character of the igneous rock is indicated by waterfalls or "forces," e.g. High Force in Teesdale. The thickness varies from 20 to 150 ft., but averages 90 ft. In some places the Whin Sill splits up into two or more smaller sills which may unite, or one of them may die out and disappear, and often small attendant sills, resembling the main mass in petrographical character, appear in association with it. It is difficult to estimate the area over which it extends, as it dips downwards from its outcrop and is no longer visible, but we may conjecture that it spreads over no less than 4000 sq. m. underground.

The rocks in which it lies belong to the Carboniferous Limestone series, and the Sill is probably one of the manifestations of the volcanic activity which occurred during the later part of the carboniferous period. Many similar sills, often of large size, though none so great as the Whin Sill, are found in the Scottish coalfields. There are few lavas or ash beds at or above the horizons on which these intrusive rocks lie, and hence it has been concluded that towards the close of that volcanic episode in British geological history the molten magmas which were impelled upwards towards the surface found a place of rest usually within the sedimentary rocks, and rarely flowed out as lavas on the sea-bottom (the intrusive succeeding the effusive phase of volcanic action). In the Carboniferous rocks the Whin Sill lies almost like an interstratified bed, following the same horizon for many miles and hardly varying more in thickness than the sedimentary bands which accompany it. This, however, is true only on a large scale, for where the junctions are well exposed the igneous rock frequently breaks across the layers of stratification, and sometimes it departs quite suddenly from one horizon and passes to another, where again for a time it continues its apparently regular course. Its intrusive character is also shown by the emission of small veins, never very persistent, cutting the sediments above or below it. In addition, it bakes and hardens the adjacent rocks, both below and above, and this proves that the superjacent beds had already been deposited and the molten diorite forced its way along the bedding planes, as natural lines of weakness. The amount of contact alteration is not usually great, but the sandstones are hardened to quartzites, the shales become brittle and splintery, and in the impure limestones many new calc-silicates are produced.

The Whin Sill consists of a dark-green granular diorite, in which quartz or micropegmatite appears as the last product of crystallization. It is not usually vesicular and is not porphyritic, though exceptions may occasionally be noted. At both the upper and the under surface the diorite becomes much finer grained, and the finest intrusive veinlets which enter the surrounding rocks may even show remains of a glassy base. These phenomena are due to the rapid cooling where the magma was in contact with

the sediments. No ash beds accompany the Whin Sill, but there are certain dikes which occur near it and probably belong to the same set of injections. In many places the diorite is quarried as a road-mending stone.

The great Palisade trap of the Hudson river, which is an almost exact parallel to the Whin Sill, is an enormous sheet of igneous rock exposed among the Triassic beds of New Jersey and New York. It has an outcrop which is about 100 m. long; its thickness is said to be in places 800 ft., though usually not above 200 to 300 ft. Like the Whin Sill the rock is a quartz-diorite occasionally passing into olivine-diorite, especially near its edges. The Palisade diorite is compact, non-vesicular and non-porphyrific as a rule. It follows the bedding planes of the sedimentary rocks into which it was injected, but breaks across them locally and produces a considerable amount of contact alteration. In New Jersey, however, there is also an extensive development of effusive rocks which are olivine-basalts, and by their sluggy surfaces, the attendant ash-beds and their strictly conformable mode of occurrence, show that they were true lavas poured out at the surface. There can be little doubt that they belong to the same period as the Palisade trap, and they are consequently later than the Whin Sill.

These great sheets of igneous rock intruded into cold and nearly horizontal strata must have solidified very gradually. Their edges are fine grained owing to their having been rapidly chilled, and the whole mass is usually divided by joints into vertical columns, which are narrower and more numerous at top and base and broader in the centre. Where exposed by denudation the rocks, owing to this system of jointing, tend to present a nearly vertical, mural escarpment which seems to consist of polygonal pillars. The name "Palisade trap" expresses this type of scenery, so characteristic of intrusive sills, and very fine examples of it may be seen on the banks of the Hudson river. In Britain it is no less clearly shown, as by the Sill at Stirling on which Wallace's Monument is placed; and by the well-known escarpment of Salisbury Crags which fronts the town of Edinburgh.

In the Tertiary volcanic district of the West of Scotland and North Ireland, including Skye, Mull and Antrim, innumerable sills occur. Perhaps the best known is the Scur of Eigg, which forms a high ridge terminating in a vertical cliff or Scur in the island of Eigg, one of the inner Hebrides. At one time it was supposed to be a lava-flow, but A. Harker has maintained that it is of intrusive origin. This Sill occupies only a small area as compared with those above described. Its length is about two and a half miles and its breadth about a quarter of a mile. On the east side it terminates in a great cliff from 300 to 400 ft. high, rising from a steep slope below. This cliff is beautifully columnar, and shows also a horizontal banding, simulating bedding. The back of the intrusive sheet is a long ridge sloping downwards to the west. The rock of which the Scur of Eigg consists is a velvety black pitchstone, containing large shining crystals of felspar; it is dull or cryptocrystalline in places, but its glassy character is one of its most remarkable peculiarities.

In the Tertiary volcanic series of Scotland and Ireland intrusive sheets build up a great part of the geological succession. They are for the most part olivine-basalts and dolerites, and while some of them are nearly horizontal, others are inclined. Among the lavas of the basaltic plateaus there is great abundance of sills, which are so numerous, so thin and so nearly concordant to the bedding of the effusive rocks that there is great difficulty in distinguishing them. As a rule, however, they are more perfectly columnar, more coarsely crystalline and less vesicular than the igneous rocks which consolidated at the surface. These sills are harder and more resistant than the tuffs and vesicular lavas, and on the hill slopes their presence is often indicated by small vertical steps, while on the cliff faces their columnar jointing is often very conspicuous.

On modern volcanoes intrusive sheets are seldom visible except where erosion has cut deep valleys into the mountains and exposed their interior structure. This is the case, for example, in Ireland, Tenerife, Somma and Etna and in the volcanic islands of the West Indies. In their origin the deep-seated injections escape notice; many of them in fact belong to a period when superficial forms of volcanic action have ceased and the orifices of the craters have been obstructed by ashes or plugged by hard crystalline rock. But in the volcanoes of the Sandwich Islands the craters are filled at times with liquid basalt which suddenly escapes, without the appearance of any lava at the surface. The molten rock, in such a case, must have found a passage underground, following some bedding plane or fissure, and giving rise to a dike or sill among the older lavas or in the sedimentary rocks beneath. Many of the great sills, however, may have been connected with no actual volcanoes, and may represent great supplies of igneous magma which rose from beneath but never actually reached the earth's surface.

The connexion between sills and dikes is very close; both of them are of subterranean consolidation, but the dikes occupy vertical or highly inclined fissures, while the sills have a marked tendency to a horizontal position. Accordingly we find that sills are most common in stratified rocks, igneous or sedimentary. Very frequently sills give rise to dikes, and in other cases dikes spread out in a horizontal direction and become sills. It is often of considerable importance to

distinguish between sills and lavas, but this may be by no means easy. The Scir of Eigg is a good example of the difficulty in identifying intrusive masses. Lavas indicate that volcanic action was going on contemporaneously with the deposit of the beds among which they occur. Sills, on the other hand, show only that at some subsequent period there was liquid magma working its way to the surface. (J. S. F.)

SILLIMAN, BENJAMIN (1779-1864), American chemist and geologist, was born on the 8th of August 1779 at Trumbull (then called North Stratford), Connecticut. Entering Yale College in 1792, he graduated in 1796, became tutor in 1799, and in 1802 was appointed professor of chemistry and mineralogy, a position which he retained till 1853, when by his own desire he retired as professor emeritus. Not only was he a popular and successful teacher of chemistry, mineralogy and geology in the college for half a century, but he also did much to improve and extend its educational resources, especially in regard to its mineralogical collections, the Trumbull Gallery of Pictures, the Medical Institution and the Sheffield Scientific School. Outside Yale he was well known as one of the few men who could hold the attention of a popular audience with a scientific lecture, and on account of his clear and interesting style, as well as of the un-wonted splendour of his illustrative experiments, his services were in great request not only in the northern and eastern states but also in those of the south. His original investigations were neither numerous nor important, and his name is best known to scientific men as the founder, and from 1818 to 1838 the sole editor, of the *American Journal of Science and Arts*—often called *Silliman's Journal*,—one of the foremost American scientific serials. In 1810 he published *A Journal of Travels in England, Holland and Scotland*, in which he described a visit to Europe undertaken in 1805 in preparation for the duties of his chair. He paid a second visit in 1851, of which he also issued an account, and among his other publications were *Elements of Chemistry* (1830), and editions of W. Henry's *Chemistry with notes* (1808), and of R. Bakewell's *Geology* (1827). He died at New Haven on the 24th of November 1864.

His son, **BENJAMIN SILLIMAN** (1816-1885), chemist and mineralogist, was born at New Haven on the 4th of December 1816. After graduating at Yale in 1837 he became assistant to his father, and in 1847 was appointed professor in the school of applied chemistry, which was largely due to his efforts and formed the nucleus of the subsequent Sheffield Scientific School. In 1849 he was appointed professor of medical chemistry and toxicology in the Medical College at Louisville, Kentucky, but relinquished that office in 1854 to succeed his father in the chair of chemistry at Yale. The duties of this professorship, so far as they related to the Academic College, he gave up in 1870, but he retained his connexion with the Medical College till his death, which happened at New Haven on the 14th of January 1885. Much of his time, especially during the last twenty years of his life, was absorbed in making examinations of mines and preparing expert reports on technical processes of chemical manufacture; but he was also able to do a certain amount of original work, publishing papers on the chemistry of various minerals, on meteorites, on photography with the electric arc, the illuminating powers of gas, &c. A course of lectures given by him on agricultural chemistry in the winter of 1845-1846 at New Orleans is believed to have been the first of its kind in the United States. In 1846 he published *First Principles of Chemistry* and in 1858 *First Principles of Physics or Natural Philosophy*, both of which had a large circulation. In 1853 he edited a large quarto illustrated volume, *The World of Science, Art and Industry*, which was followed in 1854 by *The Progress of Science and Mechanism*. In 1874, when the 100th anniversary of Priestley's preparation of oxygen was celebrated as the "Centennial of Chemistry" at Northumberland, Pa., where Priestley died, he delivered an historical address on "American Contributions to Chemistry," which contains a full list, with their works, of American chemists up to that date. From 1838 to 1845 he was associated with his father in the editorship of the *American Journal of Science*, and from 1845 to the end of his life his name appeared on the title page as one of the editors in chief.

SILLIMANITE, a rock-forming mineral consisting of aluminium silicate, Al_2SiO_5 . It has the same percentage chemical composition as cyanite (*q.v.*) and andalusite (*q.v.*), but differs from these in crystalline form and physical characters. It crystallizes in the orthorhombic system and has the form of long, slender needles without terminal planes, which are often aggregated together to form fibrous and compact masses; hence the name *fibrolite*, which is often employed for this species. The name sillimanite is after Benjamin Silliman the elder. There is a perfect cleavage in one direction parallel to the length of the needles. The colour is greyish-white or brownish, and the lustre vitreous. The hardness is $6\frac{1}{2}$ and the specific gravity 3.23. Sillimanite is a characteristic mineral of gneisses and crystalline schists, and it is sometimes a product of contact-metamorphism. It has been observed at many localities; e.g. in Bohemia (the *Faserkiesel* of Lindacker, 1792), with corundum in the Carnatic (fibrolite of comte de Bournon, 1802), Chester in Connecticut (sillimanite of G. T. Bowen, 1824), Monroe in New York ("monrolite"), Bamle near Brevik in Norway ("bamlite"). Pre-historic implements made of compact sillimanite are found in western Europe, and have a certain resemblance to jade implements. (L. J. S.)

SILLY, weakly foolish, stupid. This is the current sense of a word which has much changed its meaning. The O.E. *selig* (usually *geselig*) meant prosperous, happy, and was formed from *sæl*, time, season, hence happiness, cf. Icel. *salá*, bliss; Ger. *selig*, blessed, happy, &c., probably also allied to Lat. *salvus*, whole, safe. The development of meaning is happy, blessed, innocent or simple, thence helpless, weak, and so foolish. The old provincial and Scottish word for a caul (*q.v.*) was "silly-how," i.e. "lucky cap." The development of meaning of "simple," literally "onefold" (Lat. *simplex*), plain, artless, hence unlearned, foolish, is somewhat parallel. A special meaning of "simple," in the sense of medicinal herbs, is due to the supposition that each herb had its own particular or simple medicinal value.

SILURES, a powerful and warlike tribe in ancient Britain, occupying approximately the counties of Monmouth, Brecon and Glamorgan. They made a fierce resistance to the Roman conquest about A.D. 48, but a legionary fortress (Isca Silurum, Caerleon) was planted in their midst and by A.D. 78 they were overcome. Their town Venta Silurum (Caerwent, 6 m. W. of Chepstow) became a Romanized town, not unlike Silchester, but smaller. Its massive Roman walls still survive, and recent excavations have revealed a town hall and market square, a temple, baths, amphitheatre, and many comfortable houses with mosaics, &c. An inscription shows that under the Roman Empire it was the *chef-lieu* of the Silures, whose *ordo* or county council provided for the local government of the district. (F. J. H.)

SILURIAN, in geology, a series of strata which is here understood to include those Palaeozoic rocks which lie above the Ordovician and below the Devonian or Old Red Sandstone, viz. the Llandoveryan (Valentian of C. Lapworth), Wenlockian and Ludlovian groups of Great Britain with their foreign equivalents. A word of caution is necessary, however, for in the early history of British stratigraphy the exact delimitation of "Silurian" was the subject of a great controversy, and the term has been used with such varying significance in geological literature, that considerable confusion may arise unless the numerous interpretations of the title are understood. The name "Silurian" was first introduced by Sir R. I. Murchison in 1835 for a series of rocks on the border counties of England and Wales—a region formerly inhabited by the Silures. Murchison's Silurian embraced not only the rock groups indicated above, but others below them that were much older, even such as are now classed as Cambrian. About the same time A. Sedgwick proposed the term Cambrian for a great succession of rocks which includes much of Murchison's Silurian system in its upper part; hence arose that controversy which left so lasting a mark on British geology. In 1850 A. d'Orbigny suggested the name "Murchisonian" for what is here retained as the Silurian system. As a solution of the difficulties of nomenclature, Professor C. Lapworth in 1879 proposed the term Ordovician systems (*q.v.*)

for those rocks which had been the Lower Silurian of Murchison and the Upper Cambrian of Sedgwick. An approximate correlation of the usages of the title "Silurian" is here given in tabulated form:—

in Timan, Tunguska and elsewhere in N. Russia. Rocks of this system in S. America have been only superficially studied; they occur in the lower regions of the Amazon, where they bear some resemblance to the Medina and is known of the Silurian rocks recorded from N. Africa.

	R. I. Murchison.	A. Sedgwick.	C. Lapworth.	American.	A. de Lapparent.	E. Renevier.
Silurian. (Upper Silurian of some authors.)	Silurian.	Silurian.	Silurian (Salopian).	Niagaran (S. D. Dana). Ontaric or Siluric (Emmons, &c.), 1844.	Bohemien (2nd ed. <i>Traité</i>). Gothlandien (3rd-5th ed.).	Silurique.
Ordovician. (Lower Silurian of some authors.)		Cambrian.	Ordovician.	Silurian (Dana). Champlainic (Hall, Emmons, &c.).	Ordovicien.	
Cambrian. Upper. Middle. Lower.		Cambrian.	Cambrian.		Cambrien.	

Silurian Life.—Our knowledge of the life of this period is limited to the inhabitants of the seas and of the brackish waters of certain districts. The remains of marine organisms are abundant and varied. Graptolites flourished as in the preceding period, but the forms characteristic of the Ordovician gave place early in the Silurian to the single-axis type (*Monograptidae*) which prevailed until the close of the period (*Rastrius*, *Monograptus*, *Retiolites* and *Cyrtograptus*). As in the Ordovician rocks, the graptolites have been largely employed as zonal indicators. Trilobites were important; the genera *Calymene*, *Phacops* and *Encrinurus* attained their maximum development; *Proetus*, *Bronteus*, *Cyphaspis*, *Arethusina* may be mentioned from among many other genera. The ostracods *Leperditia* and *Bey-*

The Silurian rocks are almost wholly of marine origin and include all the usual phases of sedimentation; shales and mudstones, marls and limestones, sandstones and grits are all represented in Great Britain and in most other countries where the Silurian is known. The majority of the rocks were deposited in the comparatively shallow waters of epicontinental seas, the graptolitic shales and sponge-bearing cherts being perhaps the representatives of the deeper waters. Locally, glauconitic limestones and ironstones (Clinton beds) indicate special conditions; while the isolation and desiccation of certain marine areas (New York) towards the close of the period gave rise to beds of red sandstone, red marls, gypsum and rock salt. The hydraulic limestone (Water Lime) of New York was probably a brackish-water formation. In Sweden and elsewhere some of the limestones and shales are distinctly bituminous.

Distribution.—In the preceding Ordovician period several well-marked marine provinces are indicated by the fossil contents of the rocks. At the beginning of Silurian time a general transgression of the sea—which had commenced at the close of the Ordovician—was in progress in the N. hemisphere (Europe and the Appalachian region). This culminated at the time when the Wenlock beds and their equivalents (Niagaran and Oesel beds) were forming at the bottom of a great periarctic sea or shallow ocean. It is thus found that the same general characters prevail in the Silurian of Britain, N. America, Scandinavia and the Baltic region, Russian Poland (Podolia, Kielce, Galicia), the Arctic regions, New Siberia (Kotelny), Olenk district, Waigatsch, N. Zembla, Tunguska, Greenland, Grinnell Land and China. The Bohemian region, comprising central Bohemia, Thuringia, Fichtelgebirge, Salzburg, Pyrenees, Languedoc, Catalonia, South Spain, Elba and Sardinia, alone retained some of its marked individuality. Later in the period a gradual withdrawal of the sea set in over the N. hemisphere, affecting the British area (except Devon), the left of the Rhine, Norway and the Baltic region, N. Russia, Siberia and the Ural region, Spitzbergen, Greenland and the W. states of N. America. Thus the later Silurian conditions heralded those of the succeeding Devonian and Old Red Sandstone, and there is generally a gradual passage from one set of rocks to the other (Downtonian of Great Britain). The Silurian rocks may occur in close continuity with the upper Ordovician, as in S. Europe; or, as in the typical region, the Llandovery beds may rest unconformably upon older rocks; in N. America also there is a marked unconformity on this horizon. A large part of N. America was apparently land during part of Silurian time; the lower members are found in the E. alone, while the Cayagan division is found to extend farther E. than the middle or Niagaran division, but not so far W. The falls of Niagara owe their existence to the presence of the hard Lockport and Guelph beds resting upon the softer Rochester shales. Most of the essential information as to the distribution of Silurian rocks will be found in a condensed form in the accompanying table and map; but attention may here be drawn to the upper Silurian (Ludlovian) limestone of Cornwallis Island, the mid-Silurian limestone of Grinnell Land and the lower Silurian limestone of New Siberia. Limestones of lower and middle Silurian age are found also

richia are very abundant locally. A feature of great interest is the first appearance of the remarkable Eurypterid crustacean *Eurypterus*, which occasionally reached the length of over a yard, and of the limulids, *Neolimulus* and *Hemiaspis*. The cephalopods were the predominant molluscs, especially *Orthoceras* and various abbreviated or coiled orthoceras-like forms (*Cyrtoceras*, *Phragmoceras*, *Trochoceras*, *Ascoceras*); there was also a *Nautilus*, and an early form of goniatite has been recorded. Gasteropods include the genera *Platyceras*, *Murchisonia* and *Bellerophon*; the pteropod *Tentaculites* is very abundant in certain beds. The pelecypods were not very important (*Cypricardina*, *Cardiola interrupta*, *C. cornucopiae*). Next to the cephalopods in importance were the brachiopods: in the lower Silurian pentamerus-like forms still continued (*P. Knightii*,

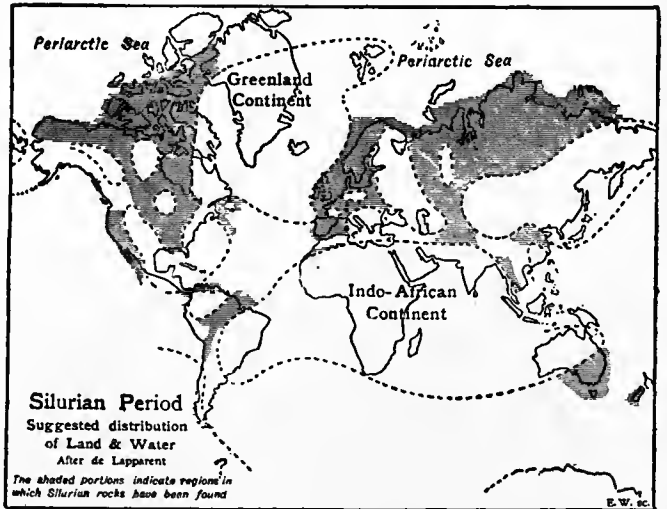

P. oblongus), but the spire-bearing forms soon began to increase (*Spirifer*, *Whitfieldia*, *Meristina*, *Atrypa*). Other genera include *Rhynchonella*, *Chonetes*, *Terebratula*, *Strophomena*, *Stricklandinia*. The bryozoa, especially the bulky rock-building forms, were less in evidence than in the Ordovician. The echinoderms were well represented by the crinoids (*Cyathocrinus*, *Crotalocrinus*, *Taxocrinus*), some of which are found in a state of beautiful preservation at Dudley in England, Lockport (New York), Waldron (Indiana) in N. America and also in Gothland in the Baltic. Cystids were abundant, but less so than in the Ordovician; blastoids made their first appearance. Corals, mostly tabulate forms, flourished in great abundance in the clearer waters and frequently formed reefs (*Favosites gothlandica*, *Halysites catenularia*, *Alveolites*, *Heliolites*); tetracoralian forms include *Stauria*, *Cyathophyllum*, *Cystiphyllum*, *Acerularia*, *Omphyma* and the remarkable *Goniophyllum*. Sponges were represented by *Astylospongia*, *Aulocopium*, &c. The peculiar genera

Approximate Correlation of Silurian Rocks.

Graptolite Zones (Britain).	Egland and Wales.	Scotland.	Scandinavian.	Baltic Region.	Bohemia.	Western Europe.	E. Alps.	North America (New York).	Canada.	Nova Scotia.	New Brunswick.	Asia.	Australia.								
<i>Monograptus leintwardinensis.</i> <i>M. bohemicus.</i> <i>M. Nilssoni.</i>	Downton and Ludlow groups.	Downtonian and Raeberry Castle beds.	Upper <i>Cardiola</i> beds and upper Cephalopod or Gothland limestone. Red sandstone. Lower cephalopod limestone. Crinoid and coral limestone. Lower <i>Cardiola</i> shales and <i>Megalomus</i> limestones.	<i>Eurypterus</i> beds. Upper Oesel beds; dolomite and limestones.	Stage E ₂ of J. Barrande. Limestones with cephalopods.	Graptolite-bearing shales and limestones of Iberian peninsula. Sandstones, shales and limestones of N. W. France.	<i>Orthoceras</i> limestone.	Maotius limestone. Rondout Water Lime. Cobleskill limestone. Salina beds of Onondaga with rock salt and gypsum.	CAYAGUAN.	Guelph limestone with <i>Megalomus</i> .	Upper Arisaig group.	Mascarene group.	Limestone of New South Wales and Tasmania with <i>Pentamerus Knightii</i> .								
<i>M. testis.</i> <i>Cyrtograptus Linnaerstoni.</i> <i>Cyrtograptus Murchisoni.</i>	Wenlock and Woolhope groups.	Riccarton, Blair, and Straiton beds.	<i>Cyrtograptus</i> shales and lower brachiopod and coral limestone with sandstone.	Lower Oesel beds; dolomite and marl.	Crinoid limestones.									Limestones and shales.	Guelph dolomite. Lockport limestone. Rochester shales. Clinton beds.	NIAGARAN.	Coral limestone of Anticosti.	New Canaan and Wentworth beds.	Restigouche group.	Coral limestone of the Himalayas with brachiopods and trilobites.	Limestone with <i>Encrinurus punctatus</i> .
<i>Rastrites maximus.</i> <i>M. spinigerus.</i> <i>M. gregarius.</i> <i>Diplograptus vesiculosus.</i> <i>Diplograptus acuminatus.</i>	Taranon, Llandovery, and May Hill groups.	Queensberry beds. Birkhill shales and Graptolitic beds of the Girvan area.	<i>Rastrites</i> shales and <i>Stricklandinia</i> marls.	<i>Pentamerus</i> beds.	Stage E ₁ of J. Barrande. Graptolite shales with diabase at the base.																

Receptaculites and *Ischadites* occur in the Silurian. Foraminifera and radiolaria also left their remains in the rocks. The most highly organized animals of the Silurian period were the fishes which had already made their appearance in the Ordovician rocks of Colorado and Russia. The Silurian fish include selachians (*Onchus*, *Thyestis*), and the occurrence of remains of the obscure backboned ostracoderms (placoderms) is particularly worthy of notice (*Pteraspis*, *Cephalaspis*, *Tremataspis*, *Cyathaspis*, *Thelodus*, *Lanarkia*, *Eukeraspis*). Scorpions (*Palaeophonus*) have been found in Lanark, Gothland and New York. Plant remains are very fully represented; land plants have been recorded from the Harz and Kellerwald (H. Potonie, 1901), and large silicified stems—up to 2 ft. in diameter—perhaps representing a gigantic seaweed (*Nematophycus*), have been found in Wales and in Canada. *Pachythea* is a small spherical body often associated with *Nematophycus*. *Girvanella* is another obscure algal plant.

As a natural result of the open character of the great Silurian periarctic sea referred to above, there are many points of resemblance between the fauna of the several regions of the N. hemisphere; this has been specially noticed in the community not only of genera but of species between Britain, Sweden and the interior of N. America (Iowa, Wisconsin, Illinois). *Gontophyllum pyramidale* is common to Iowa and Gothland; *Atrypa reticularis*, *Orthoceras annulatum* and not a few others are common to Europe and N. America. An extremely interesting circumstance is the admixture of a periarctic and Bohemian fauna in the Australasian region.

In a general sense the Silurian period was one of comparative quiescence as regards crustal disturbances, and a relative sinking of the land was followed by a relative elevation affecting wide areas in the N. hemisphere. Local oscillations, such as those taking part in the formation of the Salina beds, &c., were naturally taking place, but the folding of the Scandinavian mountains and in the N. highlands of Scotland continued throughout the period accompanied by a great amount of thrusting. Volcanic activity was quite subordinate in Silurian times; flows of diabase occurred at the commencement of the period in Bohemia, and evidence of minor basaltic flows and tuffs is found at Tortworth in Gloucestershire and at a few localities in N. America.

For further information, see articles on the CAMBRIAN, ORDOVICIAN, LLANDOVERY, WENLOCK, LUDLOW Systems and Groups. (J. A. H.)

SILVA, ANTONIO JOSÉ DA (1705-1739), Portuguese dramatist, known as "the Jew," was born at Rio de Janeiro, but came to Portugal at the age of eight. His parents, João Mendes da Silva and Lourença Coutinho, were descended from Portuguese Jews who had emigrated to Brazil to escape the Inquisition, but

in 1702 that tribunal began to persecute the *Marranos* in Rio, and in October 1712 Lourença Coutinho fell a victim. Her husband and children accompanied her to Portugal, where she figured among the "reconciled" in the *auto-da-fé* of the 9th of July 1713, after undergoing the torment only. Her husband, having then acquired a fixed domicile in Lisbon, settled down to advocacy with success, and he was able to send Antonio to the university of Coimbra, where he matriculated in the faculty of law. In 1726 Antonio was suddenly imprisoned along with his mother on the 8th of August; on the 16th he suffered the first interrogation, and on the 23rd of September he was put to the torment, with the result that three weeks later he could not sign his name. He confessed to having followed the practices of the Mosaic law, and this saved his life. He went through the great *auto-da-fé* held on the 23rd of October in the presence of King John V. and his court, abjured his errors, and was set at liberty. His mother was only released from prison in October 1729, after she had undergone torture and figured as a penitent in another *auto-da-fé*. Meanwhile Antonio had gone back to Coimbra, and finishing his course in 1728-1729 he returned to Lisbon and became associated with his father as an advocate. He found an ignorant and corrupt society ruled by an immoral yet fanatical monarch, who wasted millions on unprofitable buildings though the country was almost without roads and the people had become the most backward in Europe. As his plays show, the spectacle struck Antonio's observation, but he had to criticize with caution. He produced his first play or opera in 1733, and the next year he married a cousin, D. Leonor Maria de Carvalho, whose parents had been burnt by the Inquisition, while she herself had gone through an *auto-da-fé* in Spain and been exiled on account of her religion. A daughter was born to them in 1734, but the years of their happiness and of Silva's dramatic career were few, for on the 5th of October 1737 husband and wife were both imprisoned on the charge of "judaizing." A slave of theirs had denounced them to the Holy Office, and though the details of the accusation against them seem trivial and even contradictory, Antonio was condemned to death. On the 18th of October he was beheaded and his body burnt in an *auto-da-fé*;

that same day one of his popular operettas was given at a Lisbon theatre.

His dramatic works, which were produced at the Bairro Alto theatre between 1733 and 1738, include the following comedies, all played by marionettes:—*D. Quixote* (1733), *Esopaida* (1734), *Os Encantos de Medea* (1735), *Amphitrião* (May 1736), *Labyrintho de Creta* (November 1736), *Guerras do Alecrim e Mangerona* (carnival of 1737), *As Variedades de Proteo* (May 1737) and *Precipicio de Faetonle* (1738). Slight as these sketches are, they show considerable dramatic talent and an Aristophanic wit. The characters are well drawn and the dialogue full of comic strength, the scenes knit together and the plot skilfully worked out. Moreover Silva possessed a knowledge of stagecraft, and, if he had lived, he might have emancipated the drama in Portugal from its dependence on foreign writers; but the triple licence of the Palace, the Ordinary and the Inquisition, which a play required, crippled spontaneity and freedom. Even so, he showed some boldness in exposing types of the prevailing charlatanism and follies, though his liberty of speech is far less than that of Gil Vicente (*q.v.*). His comedies give a truthful and interesting picture of 18th century society, especially his best comedy, the *Alecrim e Mangerona*, in which he treats of the *fidalgos pobres*, a type fixed by Gil Vicente and Francisco Manoel de Mello (*q.v.*). His works bear the title "operas" because, though written mainly in prose, they contain songs which Silva introduced in imitation of the true operas which then held the fancy of the public. He was also a lyric poet of real merit, combining correctness of form with a pretty inspiration and real feeling. His plays were published in the first two volumes of a collection entitled *Theatro comico portuguez*, which went through at least five editions in the 18th century, while the *Alecrim e Mangerona* appeared separately in some seven editions. This comedy and the *D. Quixote* have been reprinted in a critical edition with a life of Silva by Dr Mendes dos Remedios (Coimbra, 1905). Ferdinand Denis, in his *Chefs-d'œuvre du théâtre portugais* (pp. 365-496, Paris, 1823), prints liberal extracts, with a French translation, from the *Vida de D. Quixote*, and F. Wolf likewise gives selections from Silva's various compositions. Silva is the subject also of several laudatory poems and dramas, one or two of which were composed by Brazilian compatriots.

See Dr Theophilo Braga, *Historia do theatro portuguez; a baixa comedia e a opera* (Oporto, 1871); F. Wolf, *Dom Antonio José da Silva* (Vienna, 1860); Ernest David, *Les Opéras du juif Antonio José da Silva, 1705-1739* (Paris, 1880); Oliveira Lima, *Aspectos de litteratura colonial Brasileira* (Leipzig, 1896); *Jewish Encyclopedia*, vol. xi. p. 341; G. A. Kohnt, "Bibliography of Works relating to Antonio José da Silva and Bibliography of Don Antonio's Compositions" in the *Publ. Am. Jew. Hist. Soc.* No. 4, p. 181; idem, "Martyrs of the Inquisition in South America," *ib.* p. 135; M. Grünwald, "José da Silva" in *Monatsschrift* (1880), xxix. p. 241. (E. Pr.)

SILVANUS (Lat. *silva*, wood), a deity or spirit of Italian woodland; not, however, of the wholly wild woodland, but of that which borders the clearings in a country not entirely reclaimed. Thus he is partly wild and partly civilized, and reflects the experience of the earliest settlers in Italy, whose descendants took him with them to the farthest limits of the empire, even to Britain, where we have many votive inscriptions to him, always as the friendly deity dwelling outside the new clearing, benevolent towards the settler in a strange land. This leading characteristic of Silvanus is shown clearly in Roman literature: Horace writes of the "horridi dumeta Silvani" (*Odes*, iii. 29) but he also calls him "tutor finium" (*Epod.* ii. 22) while for Virgil he is "arvorum pecorisque deus" (*Aen.* viii. 600). A writer on land measurement (*Script. gramatici*, i. 302) tells us that each holding had three Silvani—*domesticus* (of the holding itself), *agrestis* (of the wilder pasture-land) and *orientalis* (of the boundaries). It is plain that in him the Italians had a very useful deity, and in all these capacities he became extremely popular, as the extraordinary number of his inscriptions shows. Unlike Mars, from whom he was probably in origin an offshoot (cf. the Mars Silvanus of Cato, *De re rustica*, 141; see MARS), he never made his way into the towns, but is almost the only Roman deity who from first to last retained the same perfectly intelligible rustic character. His double nature as deity of woodland and cultivated land is seen well in the artistic representations of him; he carries a young tree in one hand, a pruning-hook in the other.

See Wissowa, *Gesammelte Abhandlungen* (1904, p. 78 foll.).

(W. W. F. *)

SILVER (symbol Ag, from the Latin *argentum*, atomic weight 107.88 (O=16)), a metallic chemical element, known from the earliest times and of great importance as a "noble" metal for articles of value—coinage, ornamentation and jewelry.

Etymologically the word "silver" probably refers to the shining appearance or brightness of the metal. The Latin *argentum* is cognate with the Greek *ἀργυρος*, silver, which in turn is derived from *ἀργός*, shining. The Hebrew *Keseph* is connected with a root meaning "to be pale." The alchemists named it Luna or Diana, and denoted it by the crescent moon; the first name has survived in *lunar caustic*, silver nitrate. Silver is widely diffused throughout nature, occurring in minute amount in sea-water, and in the mineral kingdom as the free metal, as an amalgam with mercury and as alloys with gold, platinum, copper and other metals. Native silver is occasionally met with in metalliferous veins, where it has been formed by the alteration of silver-bearing minerals. It crystallizes in the cubic system, but the crystals are usually distorted and indistinctly developed: twisted wire-like forms are much more common. The best crystallized specimens have been obtained from Kongsberg in Norway, large masses, weighing as much as 5 cwts., having been found. It is also found in other silver mines, especially those of Mexico, Peru and Chile; in the Lake Superior copper mining region it occurs in association with native copper. The element is a constituent of many mineral sulphides, some of which are of sufficiently frequent occurrence to rank as ores of silver. Of these the more important are noticed under *Metallurgy*; here we may notice the rarer minerals. Silver sulphide, Ag_2S , occurs naturally as the orthorhombic acanthite, and the cubic argentite; the telluride, Ag_2Te , named hessite, assumes cubic forms; other tellurides containing silver are petzite, $(Ag,Au)_2Te$, and sylvanite, $AuAgTe_4$. In association with antimonious and arsenious sulphides, silver sulphide forms many important minerals, which sometimes present dimorphous forms, reflecting the dimorphism of silver sulphide; moreover, the corresponding arsenious and antimonious compounds are frequently isomorphous. This is illustrated by the hexagonal pyrrargyrite $3Ag_2S \cdot Sb_2S_3$, and proustite, $3Ag_2S \cdot As_2S_3$, and the monoclinic pyrostilpnite, isomeric with pyrrargyrite, and xanthoconite, isomeric with proustite. Other pairs of isomorphous argentiferous minerals are: the cubic polybasite, $9Ag_2S \cdot Sb_2S_3$, and pearceite, $9Ag_2S \cdot As_2S_3$; and the germanium minerals argyrodite, $4Ag_2S \cdot GeS_2$, and canfieldite, $4Ag_2S \cdot (Sn,Ge)S_2$.

Physical Properties.—In appearance silver presents a pure white colour with a perfect metallic lustre. It is the most malleable and ductile of all metals with the exception of gold: one gramme can be drawn out into a wire 180 metres long, and the leaf can be beaten out to a thickness of 0.00025 mm.; traces of arsenic, antimony, bismuth and lead, however, make it brittle. In hardness it is superior to gold, but inferior to copper. Its specific gravity, according to G. Rose, lies between 10.514 and 10.619 at 14°; an average value is 10.57. Its specific heat is 0.05701 (Regnault) or 0.0559 (Bunsen); its coefficient of linear expansion is 0.0001921. Its thermal conductivity is, according to Wiedemann and Franz, superior to that of other metals, being in the ratio of 100:74 as compared with copper and 100:54 with gold; it is the most perfect conductor of electricity, standing to copper in the ratio 100:75, and to gold 100:73. Silver melts at about 1000° C.; recent determinations give 960.7° (Heycock and Neville) and 962° (Becquerel); at higher temperatures it volatilizes with the formation of a pale blue vapour (Stas). Its vapour density has been determined at 2000°, and corresponds to a monatomic molecule. When molten, silver occludes the oxygen of the atmosphere, absorbing 20 times its own volume of the gas; the oxygen, however, is not permanently retained, for on cooling it is expelled with great violence; this phenomenon is known as the "spitting" of silver. It is prevented by preserving the molten metal from contact with air by covering the surface with non-oxidizing agents, or by traces of copper, bismuth or zinc.

Chemical Properties.—Silver is not oxidized by oxygen, but resembles mercury in being oxidized by ozone. It has no action on water. It is readily soluble in dilute nitric acid, nitric oxide and silver nitrate being formed; it also dissolves in hot, strong sulphuric acid, sulphur dioxide being evolved. Hydrochloric acid forms a surface film of silver chloride; hydriodic acid

readily dissolves it, while hydrofluoric acid is without action. Sulphuretted hydrogen is decomposed with the formation of a black coating of silver sulphide; this is the explanation of the black tarnish seen when silver is exposed to the fumes of coal gas, and other sulphuretted compounds, such as occur in eggs. The so-called "oxidized" silver is a copper-silver alloy coated superficially with a layer of the sulphides by immersion in sodium sulphide or otherwise. Silver combines with the free halogens on heating and also with sulphur.

Molecular silver is a grey powder obtained by leaving metallic zinc in contact with silver chloride which has been precipitated in the cold and washed till nearly free from acid. The powder is separated from the zinc, washed with hydrochloric acid, dried in the air, and then gently heated to 150°. It assumes a metallic lustre on burnishing or heating to redness. It receives application in synthetic organic chemistry by virtue of its power to remove the halogen atoms from alkyl haloids, and so effect the combination of the two alkyl residues.

Colloidal silver is the name given by Carey Lea to the precipitates obtained by adding reducing solutions, such as ferrous sulphate, tartrates, citrates, tannin, &c., or to silver solutions. They dissolve in water to form solutions, which do not penetrate parchment membranes, hence the name colloidal. Many other methods of preparing these substances are known. Bredig's process consists in passing an electric arc between silver electrodes under water, when a brown solution is obtained.

Production.—The economic questions which attend the production of silver and the influence which gold and silver exercise on prices are treated in the articles MONEY and BI-METALLISM; the reader is referred to the former article for the history of silver production and to the topographical headings for the production of specific countries. Since the middle of the 19th century the annual production has increased: the following table gives the average annual production in 1000 oz. over certain periods:—

1841-1850.	1851-1860.	1861-1865.	1866-1870.	1871-1875.	1876-1880.	1881-1885.	1886-1890.	1891-1895.
25,090	28,792	35,402	43,052	63,318	78,777	87,272	110,356	158,942
1900.	1901.	1902.	1903.	1904.	1905.	1906.	1907.	1908.
180,093	174,851	164,560	170,128	182,262	189,830	165,640	184,894	203,186

Over two-thirds of the world's supply is derived from Mexico and the United States. The Mexican mines first sent supplies to Europe in the 16th century, and during the period 1781-1800 yielded two-thirds of the world's production. Although the production has decreased relatively, yet it has increased enormously absolutely; in 1900, it was 55,804,420 oz., being second to the United States; in 1905 it was 73,838,066 oz., establishing a record for any single country. The United States came into prominence in about 1860, and the discovery of the famous Comstock lode in Nevada led to an enormous increase in the production. The production of this lode declined in 1876, but the total production of this country was increased by discoveries in Colorado (Leadville) and Nevada (Eureka); and in more recent years silver-producing areas in other states (Montana, Utah, Idaho) have been exploited. In 1860 the production was 116,019 oz., which increased to 1,546,920 in 1861; in 1872 it was 22,254,002 oz.; in 1888, 45,792,682; in 1890, 54,516,300 oz.; in 1900, 57,647,000; and in 1905, 58,918,839 oz. S. America has furnished European supplies since the discovery of the Potosi mines of Peru in 1533; Bolivia and Chile are also notable producers. Of European producers, Germany, Spain and Austria are the most important; Greece, Italy, France, Turkey and Russia occupy secondary positions. The German mines were worked in the 10th century; at the beginning of the 16th century the production was over 400,000 oz. annually; this dropped in the following century to about one-half; it then recovered, and in recent times has enormously increased, attaining 12,535,238 oz. in 1905. The mines of Spain, neglected late in the 15th century on the advent of supplies from America, came into note in 1827; the output has since greatly increased, amounting to 3,774,989 oz. in 1905. Austria-Hungary was producing twice as much as Germany, and about one-half of the total European production, in the 16th century; the yield diminished in the ensuing century, to be subsequently increased. The output was about 1,800,000 oz. in 1905. The total European supply was about 17,000,000 oz. in 1900 and about 18,600,000 oz. in 1905. Of other countries we may notice Canada, which produced 4,468,225 oz. in 1900 and 5,974,875 oz. in 1905, and Japan, which produced about

670,000 oz. in 1880 and 3,215,000 oz. in 1905. Australia came into notice chiefly by reason of the discoveries at Broken Hill, New South Wales; these mines producing 36,608 oz. in 1885, 1,016,269 in 1886, and 7,727,877 oz. in 1890. The total Australasian production in 1900 was 14,063,244 oz. and 14,362,639 oz. in 1905.

Metallurgy.

From the metallurgical point of view, silver ores may be classified as real silver ores and argentiferous ores. The former consist of silver minerals and gangue (vein matter, country-rock). The leading silver minerals are native silver; argentite or silver glance, Ag₂S, usually containing small amounts of lead, copper and tin; dyscrasite or antimonial silver, Ag₂Sb to Ag₃Sb, an isomorphous mixture of silver and antimony; proustite or light red silver ore, Ag₃AsS₃; pyrargyrite or dark red silver ore, Ag₃SbS₃; stephanite, Ag₈SbS₄; miargyrite, AgSbS₂; stromeyerite, CuAgS; polybasite, 9(Cu₂S,Ag₂S)·(Sb₂S₃,As₂S₃); cerargyrite or horn silver, AgCl; bromite or bromargyrite, AgBr; embolite, Ag(Cl,Br); iodite or iodargyrite, AgI. Metalliferous products containing silver arise in many operations; the chief products which may yield silver economically are copper and lead mattes, burnt argentiferous pyrites and certain drosses and scums. Argentiferous ores consist of silver-bearing base-metal minerals and gangue. Lead and copper ores, carrying silver in some form or other, are the leading representatives. The silver is extracted from the gangue with the base metal, usually by smelting, and the two are then separated by special processes (see LEAD).

Milling, i.e. amalgamation and lixiviation, is cheaper than smelting, but the yield in silver is lower. Often it is more profitable to smelt real silver ores with argentiferous ores than to mill them, the greater cost being more than balanced by the

increased yield. Milling is practised mainly in isolated localities near the mine producing the ore. As any given region is opened up by railways, cheapening transportation, milling is apt to give way to smelt-

ing. Thus on the American continent, which produces the bulk of the world's silver, milling is still prominent in S. America and Mexico, while in the United States it has to a considerable extent been replaced by smelting.

Amalgamation is based on the property of quicksilver to extract the silver from finely-pulverized ore and collect it in the form of an amalgam. When the rock has been separated from the amalgam by a washing operation, the quicksilver is recovered by distillation in an iron retort, and the remaining crude retort-silver melted into bars and shipped to a refinery, which removes the impurities, the leading one of which is copper. A silver ore is either free-milling or refractory, that is, the silver mineral is readily amalgamated or it is not. In free-milling ore the silver is present either in the native state, or as chloride or as simple sulphide. Complex silver minerals (sulph-arsenides and anti-monides) which are difficult to amalgamate must be made amenable to quicksilver, and the simplest way of doing this is to convert the silver into chloride. This is imperfectly accomplished, in the wet way, by cupric and cuprous chloride solutions, but completely so, in the dry way, by roasting with salt (chloridizing roasting). According as a preliminary chloridizing roast has or has not been given, the process is classed as roast-amalgamation or raw-amalgamation. The leading raw-amalgamation processes are the Patio and Washoe; then follow the Cazo, Fondon and Kröhnke; of the roast-amalgamation processes, the European Barrel or Freiberg, the Reese River and the Francke-Tina are the most important.

The *Patio* process, sometimes named the American-heap-amalgamation process, which is carried out principally in Mexico, aims at

amalgamating the silver in the open in a circular enclosure termed a *lorta*, the floor of which is generally built of flagstones. In order to facilitate the decomposition of the silver-mineral, salt and magistral, i.e. cupriferos pyrites roasted to convert the copper into soluble sulphate, which is the active agent, are worked into the wet pulp spread out on the floor. The amalgamation proceeds very slowly, as the sole extraneous heat is that of the sun. According to Laur ("Métallurgie de l'argent au Mexico," *Ann. des mines*, series 6, vol. xx.), at Guanajuato, Mexico, 92.79% of the total silver recovered was extracted after 12 days, 97.55% after 25 days, 99.1% after 28 days and 100% after 33 days. The loss of quicksilver in the process is large, owing to the formation of calomel which is not saved. The yield in silver is low unless the ores are exceptionally free-milling; the bullion produced is high-grade, as refractory silver minerals are hardly attacked. The process is suited to easy ores and a region where the climate is warm and dry, and horse- or mule-power, labour and quicksilver are cheaper than fuel and water.

The *Washoe* process of pan-amalgamation, named from the Washoe district in the United States, is the leading raw-amalgamation process of the United States, where it was introduced in 1861 by A. B. Paul. It consists in wet-stamping coarsely crushed ore, settling the sands and slimes produced, and grinding and amalgamating them in steam-heated iron pans with or without the use of chemicals (salt and copper sulphate). The ores may contain a larger proportion of sulphides and complex silver minerals than with the *Patio* process and still give a satisfactory extraction. They are crushed to egg-size in a rock-breaker, and pulverized to pass a 40-mesh sieve in a California stamp-mill, which treats in 24 hours about 3 tons per stamp. A 10-stamp mill is fed by one rock-breaker, and discharges the liquid pulp into 10-15 wooden settling tanks, 9 by 5 by 8 ft., the settled contents of which are shovelled out and charged into the pans. The pan in general use is the combination pan. It has a flat cast-iron bottom, 5 feet in diameter, and wooden sides about 30 inches high, the lower parts of which are lined with cast-iron. In the centre is a hollow cone, through which passes the driving shaft, geared from below. This turns the grinding apparatus (driver with "muller"), which can be raised and lowered. The speed is 60-90 revolutions per minute. To the bottom and muller are attached grinding plates (shoes and dies), which are replaced when worn; and to the sides three wings to deflect the moving pulp towards the centre, and thus establish the necessary pulp current. The lower side of the bottom has also a steam-chest. A 10-stamp mill has 4-6 pans, which receive 2-ton charges. In working, the muller is raised $\frac{1}{2}$ in., the pan charged with water and then with ore; the muller is then lowered, salt and blue vitriol added, and the charge ground for 3-4 hours. The pulp is heated with live steam to about 90°C., and kept at that temperature by exhaust steam in the bottom-chest. After grinding, the muller is raised and quicksilver added, and the silver up to 81.04% then amalgamated in 4 hours.

In amalgamating without the use of chemicals, finely divided iron, worn from the shoes and dies in the stamp-mill and the pan, decomposes cerargyrite and argentite, and the liberated silver is taken up by the quicksilver; the process is hastened by adding salt. When salt and copper sulphate are added to the charge, they form sodium sulphate and cupric chloride, both of which are readily soluble in water. Cupric chloride acts upon argentite ($\text{Ag}_2\text{S} + \text{CuCl}_2 = 2\text{AgCl} + \text{CuS}$), proustite ($4\text{Ag}_3\text{AsS}_3 + 4\text{CuCl}_2 = 8\text{AgCl} + 2\text{Ag}_2\text{S} + 4\text{CuS} + 2\text{As}_2\text{S}_3$), pyrrargyrite ($2\text{Ag}_3\text{SbS}_3 + 3\text{CuCl}_2 = 6\text{AgCl} + 3\text{CuS} + \text{Sb}_2\text{S}_3$), and is also reduced to cuprous chloride by metallic iron. This salt, insoluble in water but soluble in brine, also acts upon argentite ($\text{Ag}_2\text{S} + \text{Cu}_2\text{Cl}_2 = 2\text{AgCl} + \text{CuS} + \text{Cu}$) and pyrrargyrite ($2\text{Ag}_3\text{SbS}_3 + \text{Cu}_2\text{Cl}_2 = 2\text{AgCl} + \text{Ag}_2\text{S} + 2\text{Ag} + 2\text{CuS} + \text{Sb}_2\text{S}_3$), and would give with silver sulphide in the presence of quicksilver, the *Patio*-reaction; metallic silver, cupric sulphide, and mercurous chloride ($2\text{Ag}_2\text{S} + \text{Cu}_2\text{Cl}_2 + 2\text{Hg} = 4\text{Ag} + 2\text{CuS} + \text{Hg}_2\text{Cl}_2$), but the iron decomposes the quicksilver salt, setting free the quicksilver.

The amalgamation is rapid. Thus Austin found that at the Charleston mills, Arizona, 92.13% of the total silver recovered was extracted after 1 hour, 94.10% after 2 hours, 95.92% after 3 hours, and 100% after 4 hours. The loss in quicksilver is small, as there is no chemical loss inherent in the process; the yield is relatively high, but the bullion is liable to be low-grade, on account of copper being precipitated and amalgamated.

When the charge has been worked, the contents of the pan are discharged into a settler, in which the amalgam is separated from the sands. It has the same general construction as the pan. It is 8 ft. in diameter and 3 ft. deep. The bottom, slightly conical, has a groove near the circumference to catch the amalgam, which is withdrawn through a discharge-spout into a bowl. In the sides at different levels are three discharge-holes for water and sand. The muller reaches to within 3 in. of the bottom and makes 12-15 revolutions per minute. In settling, the pulp is diluted by a small stream of water, and the thinned pulp drawn off, first through the top discharge-hole and then through the other two, the bottom one being about 8 in. above the amalgam. Settling takes about half the time required to work a charge in the pan, hence one settler serves two pans. The amalgam is dipped out from the bowl into a canvas bag (the strainer), to separate the excess of the quicksilver from the pasty amalgam, which is then retorted and melted. The cost of treating a ton of ore in the western part of the United States is from \$3 to \$7. At some

works treating ores containing sulphides which do not yield their silver to quicksilver, concentration apparatus (see *ORE-DRESSING*) is inserted between the stamps and the settling tanks to remove the sulphides, which are worked by themselves; at other works they are recovered from the sands after these have left the settlers. In order to do away with the handling of the wet pulp, and to obtain a higher extraction, M. P. Boss has modified the ordinary plant by making the pulp flowing from the stamps pass through a grinding pan, then through a series of amalgamating pans followed by a row of settlers.

A 20-stamp mill is served by 12 men in 24 hours. The Washoe process is independent of the climate, but it requires cheap power and an abundance of water.

In the *Cazo*, *Caldron* or *Hot* process the pulverized silver ore is boiled in a copper-bottomed wooden vat, first with brine until the silver has been reduced by the copper, and then with quicksilver. The *Fondon* is an improvement on the *Cazo*. Bars of copper drawn over the bottom by mules or water-power (like the stone drags in the *arrastra*) grind off fine particles of copper, which hasten the reduction of the silver and diminish the formation of calomel. In the *Kröhnke* process introduced by B. Kröhnke into Copiapó, Chile, in 1860, the silver mineral of the pulverized ore is decomposed in a revolving barrel by a hot solution of cuprous chloride in brine in the presence of zinc or lead and quicksilver (see B. Kröhnke, *Methode zur Entsilberung von Erzen*, Stuttgart, 1900).

Chloridizing Roasting.—In a chloridizing roast chlorine produces its effect as nascent chlorine or gaseous hydrochloric acid. The leading reagents are salt (NaCl), sulphur trioxide (SO_3 , produced in the roasting), and steam (H_2O). The decomposition of salt is expressed by $2\text{NaCl} + 2\text{SO}_3 = \text{Na}_2\text{SO}_4 + \text{SO}_2 + \text{Cl}_2$. In the presence of water-vapour the following reaction takes place: $2\text{NaCl} + \text{SO}_3 + \text{H}_2\text{O} = \text{Na}_2\text{SO}_4 + 2\text{HCl}$. As some water-vapour is always present, hydrochloric acid will invariably be formed with the chlorine. The roasting is carried on in hand and mechanical reverberatory furnaces, and occasionally in muffle-furnaces. A chloridation of over 90% silver is the rule.

The *European Barrel* or *Freiberg* process consists in roasting the ground ore with salt which converts the silver sulphide into chloride. The mass, along with certain proportions of water, scrap-iron and mercury, is then placed in barrels, which are made to rotate so that the several ingredients are thoroughly mixed. The salt solution dissolves a small proportion of chloride, which in this form is quickly reduced by the iron to the metallic state. This solution and precipitation is continuous, and the metal formed unites with the mercury to form a semi-fluid amalgam. The amalgam is pressed in linen bags to eliminate a quantity of relatively silver-free liquid mercury (which is utilized as such in subsequent operations), and the remaining solid amalgam is subjected to distillation from iron retorts. This process was perfected at Freiberg, Saxony, but abandoned there in 1856. In the United States it was used quite extensively in Colorado and Nevada, but has now been given up. The main reasons for this are the length of time required to finish a charge, on account of the absence of any extraneous source of heat, and the great care with which operations have to be carried out in order to obtain satisfactory results.

The *Reese River* or pan-amalgamation process consists in dry-stamping crushed dried ore and dried salt (separately or together), charging them into a roasting furnace, and amalgamating the chloridized ore in an iron pan. The general arrangement and construction of a mill resemble those of the Washoe process. The apparatus for drying ore and salt varies greatly, drying-floors, dry-kilns and continuous mechanical reverberatory furnaces with stationary and revolving hearths being used. The general construction of the pan is the same as in the Washoe process; the management, however, differs. The steam-chest is not used to such an extent, as the bottom would be prematurely corroded; less water is used, as the pulp would become too thin on account of the soluble salts (sodium chloride, sulphate, &c.) going into solution; and the roasted ore is not ground, as the hot brine readily dissolves the silver chloride from the porous ore, and thus brings it into intimate contact with iron and quicksilver. Chemical reagents are sometimes added—lime or sulphuric acid, to neutralize an excess of acid or alkali; copper sulphate, to form cuprous chloride with sodium chloride; and iron and zinc, to make the galvanic action more energetic and reduce the consumption of iron. The rest of the apparatus (settler, retort, crucible, furnace) is the same as with the Washoe process. The Reese River process costs from half as much again to twice as much as the Washoe process.

The *Francke-Tina* process, named from Francke, German consul at Bolivia, and *tina*, the wooden vat in which the process is carried out, was developed in Bolivia for the treatment of refractory ores rich in zinc blende and tetrahedrite (fahl-ore). The ore is given only a partial chloridizing roast, on account of the great loss in silver that would be caused by the formation of zinc chloride. The large amount of soluble sulphates of iron and copper formed in the roast is made to act upon salt charged in a copper-bottomed amalgamating pan; the chlorides formed finish in the wet way the imperfect chloridation obtained in the furnace.

Lixiviation.—Ores suited for amalgamation can, as a rule, be successfully leached. In leaching, the silver ore is subjected to the action of solvents, which dissolve the silver; from the solution the silver is precipitated and converted into a marketable product.

The leading solvents are aqueous solutions of thiosulphates, unsystematically but generally termed hyposulphites. Sodium chloride, characteristic of the Augustin process in which the ores, after a chloridizing roast, were extracted with brine, and the silver precipitated by copper, has almost wholly fallen into disuse; and potassium cyanide, which has become a very important solvent for finely divided gold, is rarely used in leaching silver ores. The use of sodium hyposulphite as solvent, and sodium sulphide as precipitant, was proposed in 1846 by Hauch and in 1850 by Percy, and put into practice in 1858 by Patera (*Patera process*); calcium hyposulphite with calcium polysulphide was first used by Kiss in 1860 (*Kiss process*, now obsolete); sodium hyposulphite with calcium polysulphide was adopted about 1880 by O. Hofmann (*Hofmann process*); finally, sodium hyposulphite with cuprous hyposulphite was first applied by Russell in 1884, who included in his process the acidulation of the first wash-water (to neutralize any harmful alkaline reaction), and the separation of lead with sodium carbonate from the silver solution previous to precipitating with sodium sulphide (see C. A. Stetefeldt, *The Lixiviation of Silver Ores with Hyposulphite Solutions*, &c., New York, 1888).

In all processes the silver ore is finely crushed, usually by rolls, as, because making few fines, they leave the ore in the best condition for leaching. As a rule the ore is subjected to a preliminary chloridizing roast, though occasionally it may be leached raw. The vats in common use are circular wooden tanks, 16-20 ft. in diameter and 8-9 ft. deep if the leached ore is to be removed by sluicing, 5 ft. if by shovelling. They have a false bottom, with cloth or gravel filters.

The basis of the following outline is the Patera process. The ore, supposed to have been salt-roasted, is charged loosely into the leaching vat and treated with water (to which sulphuric acid or copper sulphate may have been added), to remove soluble salts, which might later on be precipitated with the silver (base-metal chlorides), or overcharge the solution (sodium chloride and sulphate), or interfere with the solvent power (sodium sulphate). The vat is filled with water from above or below, in- and out-flow are then so regulated as to keep the ore covered with water. Any silver dissolved by the first wash-water is recovered by a separate treatment. After the wash-water has been drained off, the ore is ready for the silver solvent. This is a solution containing up to 2% of sodium hyposulphite, of which one part dissolves 0.485 part silver chloride, equivalent to 0.365 part metallic silver, to form double hyposulphites. Silver arsenate and antimoniate are also readily soluble, metallic silver slightly so, silver sulphide not at all. (In the Russell-process double salts: $4\text{Na}_2\text{S}_2\text{O}_3 \cdot 3\text{Cu}_2\text{S}_2\text{O}_3$, and $8\text{Na}_2\text{S}_2\text{O}_3 \cdot 3\text{Cu}_2\text{S}_2\text{O}_3$ the metallic silver and silver sulphide are readily soluble; thus it supplements that of Patera.)

After the silver has been dissolved by percolation, the last of the solvent still in contact with the ore is replaced by a second wash-water. The silver solution, collected in a circular precipitating vat (10 ft. in diameter and 10 ft. deep), is treated with sodium sulphide (or calcium polysulphide), unless sodium carbonate was first added to throw down any lead, present in the ore as sulphate, that had gone into solution. Silver sulphide falls out as a black mud, with about 50% silver, and the solvent will be regenerated.

If the sodium cuprous hyposulphite was used as a solvent in addition to the simple sodium hyposulphite, cuprous sulphide will be precipitated with the silver sulphide, and the precipitate will be of lower grade. At some works the silver is precipitated with sodium sulphide, and the liquor, after having been separated from the silver sulphide, is treated with calcium polysulphide, that by the precipitation of calcium sulphate the accumulation of sodium sulphate may be prevented. The precipitated silver (copper) sulphide is filtered, dried, and usually shipped to silver-lead works to be refined; sometimes it is converted into metallic silver at the works. The solution, freed from silver, is used again as solvent. Lixiviation has many advantages over amalgamation. It permits coarser crushing of the ore, the cost of plant is lower, the power required is nominal, the cost of chemicals is lower than that of quicksilver, less water is necessary, and the extraction is often higher, as silver arsenate and antimoniate are readily soluble, while they are not decomposed in amalgamation. On the other hand, silver and silver sulphide are readily amalgamated; and while they are not dissolved in the Patera process, they are in the Russell process.

Mention may be made of the *Ziervogel* process, introduced at Heitstadt in 1841 for the purpose of extracting silver from copper mattes. In principle it consists in oxidizing silver sulphide to the sulphate which is soluble in water, the silver being then precipitable by metallic copper. This process when carefully carried out, especially as to the details of the roasting process whereby the silver sulphide is oxidized, yields 92% of the silver originally present.

Electrolytic Methods.—Crude silver generally contains small amounts of copper, gold, bismuth, lead and other metals. To

eliminate these impurities, electrolytic methods have been devised; of these that of Moebius is the most important and will be described in detail.

Under his earlier patent of 1884, cast crude silver anode plates, about $\frac{1}{4}$ in. thick, and thin rolled silver cathodes, were suspended in a $\frac{1}{2}$ %, slightly acid, solution of silver nitrate contained in tarred wooden tanks. The deposit from this solution even with low current-densities is pulverulent and non-coherent, and therefore during electrolysis wooden scrapers are automatically and intermittently passed over the surface of the cathode to detach the loose silver, which falls into cloth trays at the bottom of the tanks. These trays are removed at intervals, and the silver washed and cast into bars, which should contain over 99.9% of pure metal. The relatively electro-negative character of silver ensures that with moderate current densities no metal (other than precious metals) will be deposited with it; hence, while the solution is pure a current-density of 30 amperes per sq. ft. of cathode may be used, but as copper accumulates in it, the current-density must be diminished to (say) 15 to 20 amperes per sq. ft., and a little extra nitric acid must be added, in order to prevent the co-deposition of copper. A pressure of 1.5 volt usually suffices when the space between the electrodes is 2 in. The tanks were arranged in groups of seven on the multiple system.

Of the metals present in the anode, practically all, except gold, pass into solution, but, under the right conditions, only silver should deposit. The whole of the gold is recovered as anode slime in cloth bags surrounding the anodes. Practical results with a large plant indicate an expenditure of 1.23 electrical horse-power hours per 100 oz. (Troy) of refined silver. In later installations, under the 1895 patent, the anodes are placed horizontally on a porous tray resting within the solution above an endless silver band revolving, also horizontally, over rollers placed near the ends of a long shallow tank. The revolving band forms the cathode, and at one end makes a rubbing contact with a travelling belt placed at an angle so that the crystals of silver detached thereby from the cathode are conveyed by it from the solution and deposited outside.

Alloy scrap containing chiefly copper with, say 5 or 6% of gold, and other metals, and up to 40 or 50% of silver, is often treated electrolytically. Obviously, with modifications, the Moebius process could be applied. Other systems have been devised. Borchers uses the alloy, granulated, in an anode chamber separated from the cathode cell by a porous partition through which the current, but not electrolyte, can pass freely. The anode residue is collected in the angular bottom of the tank, the electrolyte passes from the anode chamber to a series of tanks in which the more electro-negative constituents (silver, &c.) are chemically separated, and thence to the cathode chamber, where the copper is deposited electrolytically, thence it passes again to the anode chamber and so completes the cycle. In one form of the apparatus a rotating cathode is used. Dietzel has described (*Zeitschrift für Elektrochem.*, 1899, vol. vi. p. 81) the working of his, somewhat similar, process at Pforzheim, where about 130 lb of the alloy was being treated by it daily in 1899. The alloy is cast into anode plates about $\frac{1}{4}$ in. thick, and placed in the anode chamber beneath the cathode cell, and separated from it by linen cloth. In the upper compartment are two large revolving horizontal cathode cylinders. Acidified copper nitrate solution is run into this cell, copper is deposited, and the more or less spent solution then passes through the linen partition, and, taking up metal from the anodes by electrolytic solution, is run out of the trough through a series of vessels filled with copper by which the silver is precipitated by simple exchange; after acidification the resulting silver-free copper solution is returned to the cathode cell for the deposition of the copper, the solution being employed again and again until too impure for use.

Chemically Pure Silver.—Even the best "fine" silver of commerce contains a few thousandth-parts of copper or other base metal. To produce perfectly pure metal the usual method is to first prepare pure chloride and then to reduce the chloride to metal. This may be effected by mixing the dry chloride with one-fifth of its weight of pure quicklime or one-third of its weight of dry sodium carbonate, and fusing the mixture in a fire-clay crucible at a bright red heat. In either case we obtain a regulus of silver lying under a fused slag of chloride. The fused metal is best granulated by pouring it into a mass of cold water. A convenient wet method for small quantities is to boil the recently precipitated chloride (which must have been produced and washed in the *cold*) with caustic soda and just enough sugar to reduce the silver oxide (Ag_2O) transitorily produced. The silver in this case is obtained as a yellowish grey heavy powder, which is easily washed by decantation; but it tends to retain unreduced chloride, which can be removed only by fusion with carbonate of soda.

Stas in his stoichiometric determinations employed the following process as yielding a metal which comes nearer ideal purity. Slightly cupriferous silver is made into dry nitrate and the latter fused to

reduce any platinum nitrate that may be present to metal. The fused mass is dissolved in dilute ammonia and diluted to about fifty times the weight of the silver it contains. The filtered (blue) solution is now mixed with an excess of solution of ammonium sulphite, and allowed to stand. After twenty-four hours about one-half of the silver has separated out in crystals; from the mother-liquor the rest comes down promptly on application of a water-bath heat. The rationale of the process is that the sulphite hardly acts upon the dissolved oxide of silver, but it reduces some of the cupric oxide to cuprous oxide, which reduces its equivalent of silver oxide to silver and reforming cupric oxide which passes through the same cycle.

Alloys of Silver.—Silver readily alloys with many metals, and the admixture generally differs in physical properties from the pure metal. Thus arsenic, antimony, bismuth, tin or zinc render the metal brittle, so that it fractures under a die or rolling mill; copper, on the other hand, increases its hardness, makes it tougher and more readily fusible. Consequently copper-silver alloys receive extensive application for coinage and jewelry. The composition of the alloy is stated in terms of its "fineness," the proportion of silver in 1000 parts of alloy. Generally copper-silver alloys separate into two layers of different composition on fusion; an exception is the alloy Ag_3Cu_2 , investigated by A. I. F. Levil, corresponding to a fineness of 719, which remained perfectly homogeneous.

The extent to which the properties of silver are modified by addition of copper depends on the fineness of the alloy produced. The addition of even three parts of copper to one of silver does not quite obliterate the whiteness of the noble metal. According to Kamarsch, the relative abrasion suffered by silver coins of the degrees of fineness named is as follows:—

Fineness	312	750	900	993
Abrasion	1	2.3	3.9	9.5

The same observer established the following relation between fineness p and specific gravity of alloys containing from 375 to 875 of silver per 1000:— $\text{sp. gr.} = 0.001647 p + 8.833$.

The fusing points of all copper-silver alloys lies below that of pure copper; that of British standard silver is lower than even that of pure silver.

Compounds of Silver.

Silver forms one perfectly characterized oxide, Ag_2O , from which is derived a series of stable salts, and probably several less perfectly known ones. *Argentite* or *silver oxide*, Ag_2O , is obtained as a dark brown precipitate by adding potash to a solution of a silver salt; on drying at 60° – 80° it becomes almost black. It is also obtained by digesting freshly precipitated silver chloride with potash. It is sparingly soluble in water (one part in 3000); and the moist oxide frequently behaves as the hydroxide, AgOH , *i.e.* it converts alkyl haloids into alcohols. It begins to decompose into silver and oxygen at 250° . *Silver peroxide*, Ag_2O_2 , appears under certain conditions as minute octahedra when a solution of silver nitrate is electrolysed, or as an amorphous crust in the electrolysis of dilute sulphuric acid between silver electrodes. It readily decomposes into silver and oxygen. It dissolves in ammonia with the liberation of nitrogen and the formation of silver oxide, Ag_2O ; and in sulphuric acid forming a fairly stable dark green liquid which, on dilution, gives off oxygen and forms silver sulphate. It is doubtful whether the pure compound has been obtained. The compound obtained from silver nitrate always contains nitrogen; it appears to have the constant composition $\text{Ag}_7\text{NO}_{11}$, and has been named silver peroxy-nitrate. Similarly the sulphate yields $5\text{Ag}_2\text{O}_2$, $2\text{Ag}_2\text{SO}_7$, silver peroxy-sulphate, and the fluoride the peroxyfluorides $\text{Ag}_{15}\text{F}_3\text{O}_{16}$, Ag_7FO_8 . The sesquioxide, Ag_2O_3 , is supposed to be formed when silver peroxide is treated with ammonia (Watson, *Jour. Chem. Soc.*, 1906, 89, p. 578).

Silver chloride, AgCl , constitutes the mineral cerargyrite or horn silver; mixed with clay it is the butter-milk ore of the German miners. Early names for it are *Lac argenti* and *Luna cornea*, the first referring to its form when freshly precipitated, the latter to its appearance after fusion. It is readily obtained as a white curdy precipitate by adding a solution of a chloride to a soluble silver salt. It is almost insoluble in water, soluble in 50,000 parts of nitric acid, and more soluble in strong hydrochloric acid and solutions of alkaline chlorides. It readily dissolves in ammonia, the solution, on evaporation, yielding rhombic crystals of $2\text{AgCl}\cdot 3\text{NH}_3$; it also dissolves in sodium thiosulphate and potassium cyanide solutions. On exposure to light it rapidly darkens, a behaviour utilized in photography (*q.v.*). Abney and Baker have shown that the pure dry chloride does not blacken when exposed in a vacuum tube to light, and that the blackening is due to absorption of oxygen accompanied by a loss of chlorine. Hydrogen peroxide is also formed. It melts at about 460° to a clear yellow liquid, which, on cooling, solidifies to a translucent resinous mass. It is reduced to metallic silver by certain metals—zinc, iron, &c.—in the presence of water, by fusion with alkaline carbonates or cyanides, by heating in a current of hydrogen, or by digestion with strong potash solution, or with potassium carbonate and grape sugar. *Silver bromide*, AgBr , constitutes the

mineral bromargyrite or bromyrite, found in Mexico and Chile. It is obtained as a yellowish white precipitate by mixing solutions of a bromide and a silver salt. It is very slightly soluble in nitric acid, and less soluble in ammonia than the chloride. It melts at 427° , and darkens on exposure to air. The minerals embolite, megabromite and microbromite, occurring in Chile, are variable mixtures of the chloride and bromide. *Silver iodide*, AgI , occurs in nature as the mineral iodargyrite or iodryrite, forming hexagonal crystals, or yellowish green plates. It is obtained as a light yellow powder by dissolving the metal in hydriodic acid, or by precipitating a silver salt with a soluble iodide. It is very slightly soluble in acids and ammonia, and almost insoluble in alkaline chlorides; potassium iodide, however, dissolves it to form $\text{AgI}\cdot\text{KI}$. Silver iodide is dimorphous; at ordinary temperatures the stable form is hexagonal; on heating to about 138° the colour changes from deep yellow to yellowish-white with the formation of cubic crystals. *Silver fluoride*, AgF , is obtained as quadrangular octahedra, with one molecule of water, by dissolving the oxide or carbonate in hydrofluoric acid. It is deliquescent, and dissolves in half its weight of water to form a strongly alkaline liquid. It is not decomposed by sunlight. It melts at 435° and, on cooling, forms a yellow transparent mass. In addition to the salts described above there exist sub-salts. *Silver nitrate*, AgNO_3 , one of the most important silver salts, is obtained by dissolving the metal in moderately dilute nitric acid; on evaporation it separates in the anhydrous form as colourless triclinic plates. It dissolves in water, alcohol and ether. It stains the skin and hair black: an ethereal solution having been employed as a dye for the hair. Mixed with gum arabic it forms a marking ink for linen. It fuses at 218° ; and when cast in quill-like moulds, it constitutes the lunar caustic of medicine, principally used as a cauterizing agent.

Silver sulphide, Ag_2S , constitutes the mineral argentite or silver glance, and may be obtained by heating silver with sulphur, or by precipitating a silver salt with sulphuretted hydrogen. Thus obtained it is a brownish solid, which readily fuses and resolidifies to a soft leaden-grey mass. It forms with silver nitrate the yellowish green solid, $\text{Ag}_2\text{S}\cdot\text{AgNO}_3$, and with silver sulphate the orange-red powder, $\text{Ag}_2\text{S}\cdot\text{Ag}_2\text{SO}_4$. *Silver sulphate*, Ag_2SO_4 , is obtained as white crystals, sparingly soluble in water, by dissolving the metal in strong sulphuric acid, sulphur dioxide being evolved, or by adding strong sulphuric acid to a solution of the nitrate. It combines with ammonia to form the readily soluble $2\text{NH}_3\cdot\text{Ag}_2\text{SO}_4$. *Silver selenide*, Ag_2Se , resembles the sulphide. It occurs in the minerals naumannite, $\text{PbSe}\cdot\text{Ag}_2\text{Se}$, and eukairite, $\text{Ag}_2\text{Se}\cdot\text{Cu}_2\text{Se}$. The *telluride*, Ag_2Te , occurs in nature as the mineral hessite.

Fulminating silver is an extremely explosive black powder, first obtained in 1788 by Berthelot, who acted with ammonia on silver oxide (prepared by adding lime water to a silver solution). When dry it explodes even on touching with a feather. It appears to be silver nitride Ag_3N , but it usually contains free silver and sometimes hydrogen. It is to be distinguished from silver fulminate (see FULMINIC ACID). The nitride Ag_3N , silver azoimide (*q.v.*), is also highly explosive.

See J. Percy, *Metallurgy of Silver and Gold* (London, 1880), part i.; T. Egleston, *The Metallurgy of Silver, Gold and Mercury* (New York, 1887–1890), part i.; M. Eissler, *The Metallurgy of Silver* (London, 1891); H. F. Collins, *The Metallurgy of Lead and Silver* (London, 1900), part ii.; H. O. Hofman, *Hydrometallurgy of Silver* (1907); C. Schnabel, *Metallurgy*, translated by H. Louis, 2nd ed. vol. i. (1905).

Medicinal Use.

Two salts of silver are used in the British pharmacopoeia. (1) *Argentum nitras* (United States and British pharmacopoeia), lunar caustic, incompatible with alkalis, chlorides, acids, except nitric and acetic, potassium iodide and arsenical solutions. From the nitrate are made (a) *argentum nitras indurata*, toughened caustic, containing 19 parts of silver nitrate and one of potassium nitrate fused together into cylindrical rods; (b) *Argentum nitras mitigatus*, mitigated caustic, in which 1 part of silver nitrate and 2 parts of potassium nitrate are fused together into rods or cones. (2) *Argentum oxidum*, incompatible with chlorides, organic substances, phenol, creosote, &c., with which it forms explosive compounds.

Therapeutics.—Externally the nitrate has a caustic action, destroying the superficial tissues and separating the part acted on as a slough. Its action is limited. It may be employed to destroy warts or small growths, to reduce exuberant granulations or it may be applied to bites. In granular lids and various forms of ophthalmia solutions of silver nitrate (2 grs. to 1 fl. oz.) are employed. A 1% solution is also used as a prophylactic for ophthalmia neonatorum. The effects of the nitrate being both astringent and stimulating as well as bactericidal, solutions of it are used to paint indolent ulcers, and in chronic pharyngitis or laryngitis. Salts of silver are most useful as an injection in subacute and chronic gonorrhoea, either the nitrate (1 to 5% solution) being employed, or protargol, which is a proteid compound containing 8% of silver nitrate, is used in 1% solution; they also benefit in leucorrhoea. In pruritus of the

vulva and anus a weak solution of silver nitrate will relieve the itching, and strong solutions painted round the base of a boil at the beginning will abort its formation. Internally the nitrate has been used in the treatment of gastric ulcer, in ulcerative conditions of the intestine and in chronic dysentery. For the intestinal conditions it must either be given in a keratin-coated pill or injected high up into the rectum. The oxide has been given in epilepsy and chorea. Nitrate of silver is eliminated from the system very slowly and the objection to its employment continuously as a drug is that it is deposited in the tissues causing *argyria*, chronic silver poisoning, of which the most prominent symptom is dark slate-blue colour of the lips, cheeks, gums and later of the skin.

Taken in large doses nitrate of silver is a powerful poison, causing violent abdominal pain, vomiting and diarrhoea with the development of gastro-enteritis. In some cases nervous symptoms and delirium supervene. The treatment consists in the use of solutions of common salt, followed by copious draughts of milk or white of egg and water or soap in water, in order to dilute the poison and protect the mucous membranes of the oesophagus and stomach from its action.

SILVERFISH, a small active insect, so-called from the silvery glitter of the scales covering the body. It is less than half an inch long and is found in damp corners or amongst books and papers in houses. Although accredited with destroying paper and linen, it probably feeds only on farinaceous or saccharine substances. Scientifically it is known as *Lepisma saccharina* and belongs to the sub-order Thysanura of the order Aptera.

SILVERIUS, pope from June 536 to March 537, successor of Pope Agapetus I., was a legitimate son of Pope Hormisdas, born before his father entered the priesthood. He was consecrated on the 8th of June 536, having purchased his elevation from the Gothic king Theodotus. Six months afterwards (Dec. 9) he was one of those who admitted Belisarius into the city. He opposed the restoration of the patriarch Anthimus, whom Agapetus had deposed, and thus brought upon himself the hatred of Theodora, who desired to see Vigilius made pope. He was deposed accordingly by Belisarius in March 537 on a charge of treasonable correspondence with the Goths, and degraded to the rank of monk. He went to Constantinople, and Justinian, who entertained his complaint, sent him back to Rome, but Vigilius was ultimately able to banish his rival to Pandataria, where the rest of his life was spent in obscurity. The date of his death is unknown.

SILVES, a city of S. Portugal, in the district of Faro (formerly the province of Algarve); on the right bank of the river Silves at the head of its estuary, and 30 m. W.N.W. of Faro. Pop. (1900) 9687. Silves is surrounded by Moorish walls and dominated by a Moorish castle. It has a fine Gothic church. It has manufactures of corks and soap; and exports corn, vegetables and fruits. Large numbers of pigs are bred, and fishing is carried on in the river and at sea. Alphonso III. (1210-1248) wrested Silves from the Moors.

SILVESTER, the name of three popes.

SILVESTER I., bishop of Rome from January 314 to December 335, succeeded Melchisedech and was followed by Marcus. The accounts of his papacy preserved in the *Liber pontificalis* are little else than a record of the gifts said to have been conferred on the Roman church by Constantine the Great. He was represented at the council of Nice. The story of his having baptized Constantine is pure fiction, as almost contemporary evidence shows the emperor to have received this rite near Nicomedia at the hands of Eusebius, bishop of that city. According to Döllinger, the entire legend, with all its details of the leprosy and the proposed bath of blood, cannot have been composed later than the close of the 5th century (cf. Duchesne, the *Liber pontificalis*, i. 109). The so-called *Donation of Constantine* was long ago shown to be spurious, but the document is of very considerable antiquity and, in Döllinger's opinion, was forged in Rome between 752 and 777. It was certainly known to Pope Adrian in 778, and was inserted in the false decretals towards the middle of the next century.

SILVESTER II., pope from 999 till 1003, and previously famous, under his Christian name of Gerbert, first as a teacher and afterwards as archbishop successively of Reims and Ravenna, was an Aquitanian by birth, and was educated at the abbey of St Gerold in Aurillac. Here he seems to have had Gerald for his

abbot and Raymond for his instructor, both of whom were among the most trusted correspondents of his later life. From Aurillac, while yet a young man (*adolescens*), he was taken to the Spanish march by "Borrell, duke of Hither Spain," prosecuting his studies. Borrell entrusted him to the care of a Bishop Hatto, under whose instruction Gerbert made great progress in mathematics. In this duke we may certainly recognize Borel, who, according to the Spanish chroniclers, was count of Barcelona from 967 to 993, while the bishop may probably be identified with Hatto, bishop of Vich or Ausona from about 960 to 971 or 972. In company with his two patrons Gerbert visited Rome, where the pope, hearing of his proficiency in music and astronomy, induced him to remain in Italy, and introduced him to the emperor Otto I. A papal diploma, still extant, shows that Count Borel and Bishop Octo or Otho of Ausona were at Rome in January 971, and, as all the other indications point to a corresponding year, enables us to fix the chronology of Gerbert's later life.

When brought before the emperor, Gerbert admitted his skill in all branches of the quadrivium, but lamented his comparative ignorance of logic. Eager to supply this deficiency he followed Lothair's ambassador Germanus, archdeacon of Reims, to that city, for the sake of studying under so famous a dialectician in the episcopal schools which were rising into reputation under Archbishop Adalbero (969-989). So promising a scholar soon attracted the attention of Adalbero himself, and Gerbert was speedily invited to exchange his position of learner for that of teacher. At Reims he seems to have studied and lectured for many years, having amongst his pupils Hugh Capet's son Robert, afterwards king of France, and Richer, to whose history we owe almost every detail of his master's early life. According to this writer Gerbert's fame began to spread over Gaul, Germany and Italy, till it roused the envy of Otric of Saxony, in whom we may recognize Otricus of Magdeburg, the favourite scholar of Otto I., and, in earlier days, the instructor of St Adalbert, the apostle of the Bohemians. Otric, suspecting that Gerbert erred in his classification of the sciences, sent one of his own pupils to Reims to take notes of his lectures, and, finding his suspicions correct, accused him of his error before Otto II. The emperor, to whom Gerbert was well known, appointed a time for the two philosophers to argue before him; and Richer has left a long account of this dialectical tournament at Ravenna, which lasted out a whole day and was only terminated at the imperial bidding. The date of this controversy seems to have been about Christmas 980, and it was probably followed by Otric's death, on the 1st of October 981.

It must have been about this time that Gerbert received the great abbey of Bobbio from the emperor. That it was Otto II., and not, as formerly supposed, Otto I., who gave him this benefice, seems evident from a diploma quoted by Mabillon (*Annales*, iv. 121). Richer, however, makes no mention of this event; and it is only from allusions in Gerbert's letters that we learn how the new abbot's attempts to enforce his dues waked a spirit of discontent which at last drove him in November 983 to take refuge with his old patron Adalbero. It was to no purpose that he appealed to the emperor and empress for restitution or redress; and it was perhaps the hope of extorting his reappointment to Bobbio, as a reward for his services to the imperial cause, that changed the studious scholar of Reims into the wily secretary of Adalbero. Otto II. died in December 983, leaving the empire to his infant heir Otto III. Lothair, king of the west Franks, claimed the guardianship, and attempted to make use of his position to serve his own purposes in Lorraine, which would in all probability have been lost to the empire but for the efforts of Adalbero and Gerbert. Gerbert's policy is to be identified with that of his metropolitan, and was strongly influenced by gratitude for the benefits that he had received from the first two Ottos.

According to M. Olleris's arrangement of the letters, Gerbert was at Mantua and Rome in 985. Then followed the death of Lothair (2nd of March 986) and of Louis V., the last Carolingian king, in May 987. Later on in the same year Adalbero crowned

Hugh Capet (1st June) and his son Robert (25th December). Such was the power of Adalbero and Gerbert in those days that it was said their influence alone sufficed to make and unmake kings. The archbishop died on the 23rd of January 989, having, according to his secretary's account, designated Gerbert his successor. Notwithstanding this, the influence of the empress Theophana, mother of Otto III., secured the appointment for Arnulf, a bastard son of Lothair. The new prelate took the oath of fealty to Hugh Capet and persuaded Gerbert to remain with him. When Charles of Lorraine, Arnulf's uncle, and the son of Louis IV. D'Outremer, surprised Reims in the autumn of the same year, Gerbert fell into his hands and for a time continued to serve Arnulf, who had gone over to his uncle's side. He had, however, returned to his allegiance to the house of Capet before the fall of Laon placed both Arnulf and Charles at the mercy of the French king (March 991). Then followed the council of St Basle, near Reims, at which Arnulf confessed his treason and was degraded from his office (17th June 991). In return for his services Gerbert was elected to succeed the deposed bishop.

The episcopate of the new metropolitan was marked by a vigour and activity that were felt not merely in his own diocese, but as far as Tours, Orleans and Paris. Meanwhile the friends of Arnulf appealed to Rome, and a papal legate was sent to investigate the question. As yet Hugh Capet maintained the cause of his nominee and forbade the prelates of his kingdom to be present at the council of Mouzon, near Sedan (June 2, 995). Notwithstanding this prohibition Gerbert appeared in his own behalf. Council seems to have followed council, but with uncertain results. At last Hugh Capet died in 996, and, shortly after, his son Robert married Bertha, the widow of Odo, count of Blois. The pope condemned this marriage as adulterous; and Abbo of Fleury, who visited Rome shortly after Gregory V.'s accession, is said to have procured the restoration of Arnulf at the new pontiff's demand. We may surmise that Gerbert left France towards the end of 995, as he was present at Otto III.'s coronation at Rome on the 21st of May 996. Somewhat later he became Otto's instructor in arithmetic, and had been appointed archbishop of Ravenna before May 998. Early in the next year he was elected pope (April 999), and took the title of Silvester II. In this capacity Gerbert showed the same energy that had characterized his former life. He is generally credited with having fostered the splendid vision of a restored empire that now began to fill the imagination of the young emperor, who is said to have confirmed the papal claims to eight counties in the Ancona march. Writing in the name of the desolate church at Jerusalem he sounded the first trumpet-call of the crusades, though almost a century was to pass away before his note was repeated by Peter the Hermit and Urban II.¹

Nor did Silvester II. confine himself to plans on a large scale. He is also found confirming his old rival Arnulf in the see of Reims; summoning Adalbero or Azelmus of Laon to Rome to answer for his crimes; judging between the archbishop of Mainz and the bishop of Hildesheim; besieging the revolted town of Cesena; flinging the count of Angoulême into prison for an offence against a bishop; confirming the privileges of Fulda abbey; granting charters to bishoprics far away on the Spanish mark; and, on the eastern borders of the empire, erecting Prague as the seat of an archbishopric for the Slavs. More remarkable than all his other acts is his letter to St Stephen, king of Hungary, to whom he sent a golden crown, and whose kingdom he accepted as a fief of the Holy See. It must, however, be remarked that the genuineness of this letter, in which Gerbert to some extent foreshadows the temporal claims of Hildebrand and Innocent III., has been hotly contested, and that the original document has long been lost. All Gerbert's dreams for the advancement of church and empire were cut short by the death of Otto III., on the 4th of February 1002; and this event was followed a year later by the death of the pope himself, which took place on the 12th of May 1003. His body was buried in the church

¹ This letter, even if spurious as now suspected, is found in the 11th-century Leiden MS., and is therefore anterior to the first crusade.

of St John Lateran, where his tomb and inscription are still to be seen.

A few words must be devoted to Silvester II. as regards his attitude to the Church of Rome and the learning of his age. He has left us two detailed accounts of the proceedings of the council of St Basle; and, despite his reticence, it is impossible to doubt that he was the moving spirit in Arnulf's deposition. On the whole it may be said that his position in this question as to the rights of the papal see over foreign metropolitans resembled that of his great predecessor Hincmar, to whose authority he constantly appeals. But he is rather the practised debater who will admit his opponent's principles for the moment when he sees his way to moulding them to his own purposes, than the philosophical statesman who has formulated a theory from whose terms he will not move. Roughly sketched, his argument is as follows. Rome is indeed to be honoured as the mother of the churches; nor would Gerbert oppose her judgments except in two cases—(1) where she enjoins something that is contrary to the decrees of a universal council, such as that of Nice, or (2) where, after having been once appealed to in a matter of ecclesiastical discipline and having refused to give a plain and speedy decision, she should, at a later date, attempt to call in question the provisions of the metropolitan synod called to remedy the effects of her negligence. The decisions of a Gregory or a Leo the Great, of a Gelasius or an Innocent, prelates of holy life and unequalled wisdom, are accepted by the universal church; for, coming from such men, they cannot but be good. But who could recognize in the cruel and lustful popes of later days—in John XII. or Boniface VII., "monsters, as they were, of more than human iniquity"—anything else than "Anti-christ sitting in the temple of God and showing himself as God"? Gerbert proceeds to argue that the church councils admitted the right of metropolitan synods to depose unworthy bishops, but contends that, even if an appeal to Rome were necessary, that appeal had been made a year before without effect. This last clause prepares us to find him shifting his position still farther at the council of Causey, where he advances the proposition that John XV. was represented at St Basle by his legate Seguin, archbishop of Sens, and that, owing to this, the decrees of the latter council had received the papal sanction. Far firmer is the tone of his later letter to the same archbishop, where he contends from historical evidence that the papal judgment is not infallible, and encourages his brother prelate not to fear excommunication in a righteous cause, for it is not in the power even of the successor of Peter "to separate an innocent priest from the love of Christ."

Besides being the most distinguished statesman, Gerbert was also the most accomplished scholar of his age. But in this aspect he is rather to be regarded as the diligent expositor of other men's views than as an original thinker. Except as regards philosophical and religious speculation, his writings show a range of interest and knowledge quite unparalleled in that generation. His pupil Richer has left us a detailed account of his system of teaching at Reims. So far as the trivium is concerned, his text-books were Victorinus's translation of Porphyry's *Isagoge*, Aristotle's *Categories*, and Cicero's *Topics* with Manlius's *Commentaries*. From dialectics he urged his pupils to the study of rhetoric; but, recognizing the necessity of a large vocabulary, he accustomed them to read the Latin poets with care. Virgil, Statius, Terence, Juvenal, Horace, Persius and Lucan are specially named as entering into a course of training which was rendered more stimulating by a free use of open discussion. More remarkable still were his methods of teaching the quadrivium. To assist his lectures on astronomy he constructed elaborate globes of the terrestrial and celestial spheres, on which the course of the planets was marked; for facilitating arithmetical and perhaps geometrical processes he constructed an abacus with twenty-seven divisions and a thousand counters of horn. A younger contemporary speaks of his having made a wonderful clock or sun-dial at Magdeburg; and we know from his letters that Gerbert was accustomed to exchange his globes for MSS. of those classical authors that his own library did not contain. More extraordinary still was his knowledge of music—an accomplishment which seems to have been his earliest recommendation to Otto I. Probably he was beyond his age in this science, for we read of Garamnus, his first tutor at Reims, whom he attempted to ground in this subject: "Artis difficultate victus, a musica rejectus est." Gerbert's letters contain more than one allusion to organs which he seems to have constructed, and William of Malmesbury has preserved an account of a wonderful musical instrument still to be seen in his days at Reims, which, so far as the English chronicler's words can be made out, seems to refer to an organ worked by steam. The same historian tells us that Gerbert borrowed from the Arabs (Saraceni) the abacus with ciphers (see NUMERALS). Perhaps Gerbert's chief claim to the remembrance of posterity is to be found in the care and expense with which he gathered together MSS. of the classical writers. His love for literature was a passion. In the turmoil of his later life he looked back with regret to his student days; and "for all his troubles philosophy was his only cure." Everywhere—at Rome, at Treves, at Moutier-en-Der, at Gerona in Spain, at Barcelona—he had friends or agents to procure him copies of the great Latin writers for Bobbio or Reims. To the abbot of Tours he writes that he is "labouring assiduously to form a library," and "throughout Italy, Germany and Lorraine (Belgica)

is spending vast sums of money in the acquisition of MSS." It is noteworthy, however, that Gerbert never writes for a copy of one of the Christian fathers, his aim being, seemingly, to preserve the fragments of a fast-perishing secular Latin literature. Despite his residence on the Spanish mark, he shows no token of a knowledge of Arabic, a fact which is perhaps sufficient to overthrow the statement of Adhemar as to his having studied at Cordova. There is hardly a trace to be found in his writings of any acquaintance with Greek.

So remarkable a character as that of Gerbert left its mark on the age, and fables soon began to cluster round his name. Towards the end of the 11th century Cardinal Benno, the opponent of Hildebrand, is said to have made him the first of a long line of magician popes. Ordericus Vitalis improves this legend by details of an interview with the devil, who prophesied Gerbert's threefold elevation in the famous line that Gerbert's contemporaries attributed to the pope himself:

Transit in R. Gerbertus in R. post papa vigens R.

A few years later William of Malmesbury adds a love adventure at Cordova, a compact with the devil, the story of a speaking statue that foretold Gerbert's death at Jerusalem—a prophecy fulfilled, somewhat as in the case of Henry IV. of England, by his dying in the Jerusalem church of Rome—and that imaginative story of the statue with the legend "Strike here," which, after having found its way into the *Gesta Romanorum*, has of late been revived in the *Earthy Paradise*.

Gerbert's extant works may be divided into five classes. (a) A collection of letters, some 230 in number. These are to be found for the most part in an 11th-century MS. at Leiden. Other important MSS. are those of the Barberini Library at Rome (late 16th century), of Middlehill (17th century), and of St Peter's abbey, Salzburg. With the letters may be grouped the papal decrees of Gerbert when Silvester II. (b) The *Acta concilii Remensis ad Sanctum Basolum*, a detailed account of the proceedings and discourses at the great council of St Basle; a shorter account of his apologetic speeches at the councils of Mouzon and Causey; and drafts of the decrees of two or three other councils or imperial constitutions promulgated when he was archbishop of Ravenna or pope. The important works on the three above-mentioned councils are to be found in the 11th-century Leiden MS. just alluded to. (c) Gerbert's theological works comprise a *Sermo de informatione episcoporum* and a treatise entitled *De corpore et sanguine Domini*, both of very doubtful authenticity. (d) Of his philosophical works we only have one, *Libellus de rationali et ratione uti*, written at the request of Otto III. and preserved in an 11th-century MS. at Paris. (e) His mathematical works consist of a *Regula de abaco computi*, of which a 12th-century MS. is to be found at the Vatican; and a *Libellus de numerorum divisione* (11th- and 12th-century MSS. at Rome, Montpellier and Paris), dedicated to his friend and correspondent Constantine of Fleury. A long treatise on geometry, attributed to Gerbert, is of somewhat doubtful authenticity. To these may be added a very short dissertation on the same subject addressed to Adalbold, and a similar one, on one of his own spheres, addressed to Constantine, abbot of Micy. All the writings of Gerbert are collected in the edition of A. Ollerys (Clermont, 1867).

(T. A. A.)

SILVESTER III. When Boniface IX. was driven from Rome early in January 1044, John, bishop of Sabina, was elected in his stead and took the title of Silvester III. Within three months Boniface returned and expelled his rival. Nearly three years later (December 1046) the council of Sutri deprived him of his bishopric and priesthood. He was then sent to a monastery, where he seems to have died.

SILVESTRE, PAUL ARMAND (1837-1901), French poet and *conteur*, was born in Paris on the 18th of April 1837. He studied at the *École polytechnique* with the intention of entering the army, but in 1870 he entered the department of finance. He had a successful official career, was decorated with the Legion of Honour in 1886, and in 1892 was made inspector of fine arts. Armand Silvestre made his entry into literature as a poet, and was reckoned among the Parnassians. His volumes of verse include: *Rimes neuves et vieilles* (1866), to which George Sand wrote a preface; *Les Renaissances* (1870); *La Chanson des heures* (1878); *Le Chemin des étoiles* (1885), &c. The poet was also a contributor to *Gil Blas* and other Parisian journals, distinguishing himself by the licence he permitted himself. To these "absences" from poetry, as Henri Chantavoine calls them, belong the seven volumes of *La Vie pour rire* (1881-1883), *Contes pantagruéliques et galants* (1884), *Le Livre des joyusetés* (1884), *Gauloiseries nouvelles* (1888), &c. For the stage he wrote in many different manners: *Sapho* (1881), a drama; *Henry VIII* (1883), with Léonce Détroyat, music by Saint-Saëns; and the *Drames sacrés* (1893), religious pictures after 14th- and 15th-century Italian painters, with music by Gounod. An account of

his varied and somewhat incongruous production is hardly complete without mention of his art criticism. *Le Nu au Salon* (1888-1892), in five volumes, with numerous illustrations, was followed by other volumes of the same type. He died at Toulouse on the 19th of February 1901.

SILVESTRE DE SACY, ANTOINE ISAAC, BARON (1758-1838), French orientalist, was born in Paris on the 21st of September 1758. His father was a Parisian notary named Silvestre, and the additional name of de Sacy was taken by the younger son after a fashion then common with the Paris *bourgeoisie*. From the age of seven years, when he lost his father, he was educated in the closest seclusion by his mother. In 1781 he was appointed councillor in the *cour des monnaies*, and was advanced in 1791 to be a commissary-general in the same department. De Sacy had successively acquired all the Semitic languages, and as a civil servant he found time to make himself a great name as an orientalist. He began successfully to decipher the Pahlavi inscriptions of the Sassanian kings (1787-1791).¹ In 1792 he retired from the public service, and lived in close seclusion in a cottage near Paris till in 1795 he became professor of Arabic in the newly founded school of living Eastern languages. The interval was in part devoted to the study of the religion of the Druses, which was the subject of his last and unfinished work, the *Exposé de la religion des Druzes* (2 vols., 1838). Since the death of Johann Jakob Reiske Arabic learning had been in a backward state. In the *Grammaire arabe* (2 vols., 1st ed. 1810, 2nd ed. 1831) and the *Chrestomathie arabe* (3 vols., 1806), together with its supplement, the *Anthologie grammaticale* (1829), De Sacy supplied admirable text-books, and earned the gratitude of later Arabic students. In 1806 he added the duties of Persian professor to his old chair, and from this time onwards his life was one of increasing honour and success, broken only by a brief period of retreat during the Hundred Days. He was perpetual secretary of the Academy of Inscriptions from 1832 onwards; in 1808 he had entered the *corps législatif*; he was made a baron in 1813; and in 1832, when quite an old man, he became a peer of France and was regular in the duties of the chamber. In 1815 he became rector of the university of Paris, and after the second restoration he was active on the commission of public instruction. With Abel Rémusat he was joint founder of the *Société asiatique*, and was inspector of oriental types at the royal printing press. De Sacy died on the 21st of February 1838.

Among his other works are his edition of Hariri (1822, 2nd edition by Reinaud, 1847, 1855), with a selected Arabic commentary, and of the *Alfiya* (1833), and his *Calila et Dimna* (1816)—the Arabic version of that famous collection of Buddhist animal tales which has been in various forms one of the most popular books of the world. A version of Abd-Allatif, *Relation arabe sur l'Égypte*, and essays on the history of the law of property in Egypt since the Arab conquest (1805-1818). To biblical criticism he contributed a memoir on the Samaritan Arabic of the Pentateuch (*Mém. Acad. des Inscr.* vol. xlix.), and editions of the Arabic and Syriac New Testaments for the British and Foreign Bible Society. Of the brilliant teachers who went out from his lecture-room may be mentioned Professor Heinrich Leberecht Fleischer (1801-1888), who contributed elaborate notes and corrections to the *Grammaire arabe* (*Kleinere Schriften*, vol. i., 1885).

SILVESTRINES, or SYLVESTRINES, an order of monks under the Benedictine rule, founded 1231 by St Silvester Gozzolini. He was born at Osimo near Ancona and held a canonry there. About 1227 he resigned it to lead an austere eremitical life. Disciples came to him, and in 1231 he built a monastery at Montefano. The rule was the Benedictine, but as regards poverty in external things, far stricter than the Benedictine. The order was approved in 1247 by Innocent IV., and at Silvester's death in 1267 there were eleven Silvestrine monasteries. At a later date there were 56, mostly in Umbria, Tuscany and the March of Ancona. In 1907 there were nine Silvestrine houses, one in Rome, and about 60 choir monks. Since 1855 they

¹ A communication to Eichhorn on the Paris MS. of the Syro-Hexaplar version of IV. Kings formed the basis of a paper in the latter's *Reperitorium*, vol. vii. (1780). This was de Sacy's literary debut. It was followed by text and translation of the letters of the Samaritans to Jos. Scaliger (*ibid.* vol. xiii., 1783) and by a series of essays on Arabian and Persian history in the *Recueil* of the Academy of Inscriptions and in the *Notices et extraits*.

have had a house and a mission in Ceylon. The order has no history. The habit is blue.

See Helyot, *Histoire des ordres religieux* (1718), vi. c. 21; Max Heimbucher, *Orden u. Kongregationen* (1907), i. § 30; Wetzler u. Welte, *Kirchenlexicon* (ed. 2).

SIMANCAS, a town of Spain, in the province of Valladolid; 8 m. S.W. of Valladolid, on the road to Zamora and the right bank of the river Pisuerga. Pop. (1900) 1129. Simancas is a town of great antiquity, the Roman Septimanca, with a citadel dating from the Moorish occupation in the 9th century, a fine bridge of seventeen arches, and many remains of old walls. In 934 it was the scene of a bloody battle between the Moors and Christians. The citadel is now the Archivo General del Reino, to which the national archives of Spain were removed by order of Philip II. in 1563. Their transference thither was first suggested to Charles V. by Cardinal Ximenes or Cisneros (d. 1517). The extensive alterations were made by three celebrated 16th-century architects, Juan de Herrera, Alonso Berruguete and Juan Gomez de Mora; the arrangement of the papers was entrusted to Diego de Ayala. They occupy forty-six rooms, and are arranged in upwards of 80,000 bundles (33,000,000 documents), including important private as well as state papers. The archives of the Indies were transferred in 1784 to the Lonja of Seville (q.v.). Permission to consult the documents at Simancas can be readily obtained.

SIMBIRSK, a government of E. Russia, on the right bank of the middle Volga, with the government of Kazan on the N., Samara on the E., Saratov on the S., and Penza and Nizhny-Novgorod on the W. It has an area of 18,095 sq. m. and occupies the E. of the great central plateau of middle Russia. Its higher parts range from 750 to 1000 ft. above the sea, and form the Zhegulev range of hills, which compels the Volga to make its great bend at Samara. In the W. a broad depression, traversed by numerous rivers and streams, extends along the left bank of the Sura. The Volga flows for 300 m. along the E. boundary, separating Simbirsk from Samara. The shallow Sviyaga rises in the Samarskaya Luka Hills and flows parallel to the Volga, at a distance of 2 to 20 m. but in the opposite direction. The Sura, also flowing N., drains the W. of Simbirsk; it is navigable for more than 270 m. A few lakes and marshes exist in the W. The climate is severe, and the extremes are great. At the city of Simbirsk the average temperature is 38.7°, but the thermometer sometimes reaches 115° F., and frosts of -47° F. are not uncommon; the average rain and snowfall is only 17.6 in. In respect to the geology, all systems, beginning with the Carboniferous, are represented in the government. The exact age of the "Variegated Marls," the subject of animated polemics among Russian geologists, remains problematic, but the inquiries of Professor Pavlov have definitely settled the geological age of the Jurassic formations. Triassic deposits appear in the N.; Carboniferous and Cretaceous predominate in the E. of the province, where they are covered in many places by Tertiary deposits; Chalk and Eocene deposits crop up chiefly in the W. and the Chalk in the S. Post-Pliocene deposits, containing bones of the mammoth and other extinct mammals, overlie the older formations. Sulphur, asphalt, salt, ochre, and iron-ore are extracted, as well as various building stones.

The estimated pop. in 1906 was 1,783,000. Nearly all the inhabitants either belong to the Russian Orthodox Church or are Nonconformists, there being only 145,000 Mussulmans. The greater number (about two-thirds) are Great Russians, the remainder being Mordvinians (12%), Chuvashes (8%), and Tatars (8%), with about 1000 Jews. The Mordvinians are settled chiefly in the N.W., in Ardatov and Alaty, and on the Volga in Sengilei; the Chuvashes make about one-third of the population of the districts of Buinsk and Kurmysh, contiguous to Kazan; the Tatars constitute about 35% in Buinsk and 18% in Sengilei. The villages in Simbirsk are large, many of them having 3000 to 5000 inhabitants. The government is divided into eight districts, the chief towns of which are Simbirsk, Alaty, Ardatov, Buinsk, Karsun, Kurmysh, Sengilei and Syzran.

School gardens and school farms have been widely introduced, while bee-keeping is taught in over 50 schools. Owing to the efforts of the *zemstvos* (local councils), sanitation is well looked after. Agriculture is the principal occupation. Out of the total area the peasant village communities hold 40%, private owners 20%, the imperial domains 5%, and the towns and the crown 0.6%. The area under forests amounts to 30% of the whole and over 50% is under cultivation. The peasants are rapidly buying land in considerable quantities. Most of their allotments (more than 76%) are cultivated, and besides what they own they rent over 500,000 acres from private owners. The principal crops are wheat, rye, oats, barley and potatoes. Good breeds of horses are kept, and considerable numbers are exported. Fishing (sturgeon) is carried on in the Volga and the Sura, timber trade in the N. and shipbuilding on the Sura. Domestic trades give employment to over 15,000 persons; carts, sledges, wheels and all sorts of wooden wares are made in the villages, as also felt goods, boots, gloves, caps, handkerchiefs, ropes and fishing-nets, all extensively exported. The factories employ less than 20,000 persons. They comprise mainly cloth mills, flour-mills and distilleries, with tanneries, glass, oil and starch works. There are 82 fairs, the most important of which are held at Simbirsk, Syzran and Karsun. There is a considerable export trade in grain, mostly rye, and in flour.

The first Russian settlers made their appearance in the Simbirsk region in the 14th century, but did not go E. of the Sura. Not till two centuries later did they cross that river and the district begin to be peopled by refugees from Moscow. The Zhegulev Mountains in the S. still continuing to be a place of refuge for the criminal and the persecuted, the town of Simbirsk was founded in 1648, with a string of small forts extending to the Sura. The region thus protected was soon settled, and, as the Russian villages advanced farther S., Syzran was founded, and a second line of small forts to the Sura was erected. The aboriginal Mordvinians rapidly lost their ethnographical individuality, especially since the middle of the 19th century. (P. A. K.; J. T. BE.)

SIMBIRSK, a town of Russia, capital of the government of the same name, 154 m. by the Volga S.S.W. from Kazan, between the Volga and the Sviyaga. Pop. (1897) 44,111. It is one of the best built provincial towns of Russia. It is an episcopal see of the Orthodox Greek Church. The central part of Simbirsk—the Crown (*Venets*), containing the cathedral and the best houses—is built on a hill 560 ft. above the Volga. Adjoining this is the commercial quarter, while farther down the slope, towards the Volga, are the storehouses and the poorest suburbs of the city; these last also occupy the W. slope towards the Sviyaga. There are three suburbs on the left bank of the Volga, communication with them being maintained in summer by steamers. A great fire having destroyed nearly all the town in 1864, it has been built again on a new plan, though still mostly of wood. The cathedral of St Nicholas dates from 1712. The new cathedral of the Trinity was erected in 1824-1841 in commemoration of the French invasion of 1812. The historian Karamzin (born in 1766 in the vicinity of Simbirsk) has a monument here, and a public library bearing his name contains about 15,000 volumes. The trade is brisk, corn being the principal item, while next come potash, wood, fruits, wooden wares and manufactured produce. Simbirsk fair has a turnover of £650,000 annually. The city was founded in 1648, and in 1670 endured a long siege by the rebel leader Stenka Razin.

SIMCOE, JOHN GRAVES (1752-1806), British soldier and first lieutenant-governor of Upper Canada, was born at Cotterstock, Northumberland, England, on the 25th of February 1752. His father, John Simcoe, who was a captain in the Royal Navy, died in 1759, and his only brother was drowned in early youth. During Simcoe's childhood the family removed to Exeter. He was sent to Eton at the age of fourteen, and three years later entered Merton College, Oxford. After two years of college life, he became ensign in the 35th regiment, first seeing active service at Boston in 1775, and remaining in America during the greater part of the Revolutionary War. In 1776 he secured command of the Queen's Rangers with the rank of major. His military career in America ended with the surrender of Cornwallis at Yorktown (Oct. 19, 1781). He returned to England on parole, and for the next ten years divided his time between London and his family estate in Devon. In December

1782 he married Elizabeth Posthuma, only child of Colonel Thomas Gwillim of Old Court, Herefordshire. In 1790 he was elected member of parliament for St Mawes in Cornwall, and at the close of his first session was appointed lieutenant-governor of the new province of Upper Canada created under the Constitutional Act of 1791. He reached Kingston, Upper Canada, on the 1st of July 1792. There the first council was assembled, the government of the new province proclaimed, and the oaths of office taken. Immediately afterwards preparations were made for the election of the first house of assembly, which opened at Newark near the mouth of the Niagara river, on the 17th of September 1792. Simcoe's ideas of colonial government were dominated by military and aristocratic conceptions quite unsuited to the pioneer conditions of Upper Canada. Thus, while his administration was characterized by the most disinterested devotion to what he conceived to be for the best interests of the province, it was rendered ineffective by the impracticable character of his projects and the friction which developed between himself and Lord Dorchester, the governor-general. He left Canada in September 1796, and was immediately afterwards sent on a mission to San Domingo, from which, however, he returned in a few months on account of ill-health. In October 1798 he was promoted to the rank of lieutenant-general, and appointed colonel of the 22nd foot. During 1800-1801 he was in command at Plymouth. Desiring more active service, he was designated commander-in-chief for India to succeed Lord Lake, but before taking the appointment his health broke and he died at Exeter on the 26th of October 1806.

See D. C. Scott, *John Graves Simcoe* (1905).

SIMEON, in the Old Testament, the name of a tribe of Israel, named after the second son of Jacob by Leah (Gen. xxix. 33). According to Gen. xxxiv., the brothers Simeon and Levi massacred the males of Shechem to avenge the violation of their sister Dinah ("judgment") by Shechem the son of Hamor. Jacob disavowed the act, and on his deathbed solemnly cursed their ferocity, condemning the two to be divided in Jacob and scattered in Israel (xlix. 5-7). Subsequently the priestly Levites are found distributed throughout Israel without portion or inheritance (Deut. xviii. 1, Josh. xiii. 14). The career of Simeon, on the other hand, raises numerous questions. Simeon is reckoned among the N. tribes in 2 Chron. xv. 9, xxxiv. 6, but is elsewhere assigned a district in S. Palestine, the cities of which are otherwise ascribed to Judah (cf. Josh. xix. 1-9 with xv. 26-32).¹ A gloss in 1 Chron. iv. 31 (which breaks the connexion) states that the latter was their seat in David's time, but there is no support for this in other records (see 1 Sam. xxvii., xxx.). In fact, Simeon is not mentioned in the "blessing of Moses" (Deut. xxxiii., see S. R. Driver, *Deut.* p. 397 seq.), or in the stories of the "judges"; and notwithstanding references to it in the chronicler's history of the monarchy, it is not named in the earlier books of Samuel and Kings. But is Gen. xxxiv. to be taken literally? Shechem is the famous holy city, Hamor a well-known native family, Jacob talks of himself as being "few in number," and the deeds of Simeon and Levi are those of communities, not of individuals. What historical facts are thus represented, and how they are to be brought into line with the early history of Israel, are problems which have defied solution (see J. Skinner, *Genesis*, p. 421 seq.). It is conjectured that Dinah represents a clan or group (cf. DAN) which settled in Shechem and was exposed to danger (e.g. oppression or absorption); the tribes Simeon and Levi intervened on its behalf, the ensuing massacre was avenged by the Canaanites, and the two were broken up. These events would belong to an early stage in the invasion of Palestine by the Israelites (15th-13th century B.C.), perhaps to a preliminary settlement by the "sons" of Leah (Reuben, Simeon, Levi and Judah), previous to the entrance of the "son" of Rachel, Joseph, the "father"

¹ It is difficult to determine whether the writers included Simeon among the ten N. tribes (2 Sam. xix. 43, 1 Kings xi. 31, 35) which are contrasted with the one (Judah, 1 Kings xi. 32, 36, xii. 20), or two (plus Benjamin; *ib.* xii. 21-23) which remained faithful to the Davidic dynasty.

of Ephraim and Manasseh.² The internal biblical evidence has forced all independent investigators to adopt *some* reconstruction, but the above theory is in many respects precarious.³ It may explain the disappearance of a *secular* tribe of Levi, but not the rise of the sacred Levites. Even in Judges ix. 28 Shechem is still held by the family of Hamor (cf. Gen. xxxiii. 19), and if Simeon was scattered and divided at any early date, its appearance in tradition many centuries later is inexplicable. On the other hand, the latter feature is significant for its vitality in post-exilic traditions. Gen. xxxiv. and the narratives upon which the above reconstruction depends are preserved by compilers of the 6th century and later, and the correlation of Simeon and Levi points to a time when the latter had at length become the recognized eponym of the well-known ecclesiastical body.

Gen. xxxiv. has been heavily revised and is in a post-exilic dress. The original story must have concerned Simeon and Levi alone (*vv.* 25 seq., 30, cf. xlix. 7), but it has been adapted to tribal history, to the spoliation of Shechem by all the "sons" of Jacob (xxxiv. 27-29). Both forms have lost their true sequel, and when Jacob and his sons journey S. they are protected from pursuit by a mysterious panic which seizes the district (Gen. xxxv. 5). As the narrative now stands, the conduct of Simeon and Levi is judged far less unfavourably than in Jacob's curse, and the editor evidently shared that aversion from foreign marriages (especially with the Samaritans of Shechem) which is characteristic of the post-exilic age (cf. Neh. xiii. 27-29). It is the attitude of the zeal of Phinehas (Num. xxv. 1-15), and of the terrible extermination of Midian (*ib.* xxxi.), and it becomes more pronounced as early Judaism extolled the two brothers.⁴ In these circumstances the original narrative can scarcely be recovered, and one can only point to the traditions of the Levites (*q.v.* § 3) and the hints of fierce religious reforms which, in certain circles and at an intermediate stage in the literary growth of the biblical sources, were condemned. In fact, the Levites are connected by the genealogical evidence with S. Palestine, the district which is associated with the scene of their divine selection, with the seat of the tribe Simeon, and with the life of Israel around Kadesh previous to Joshua's invasion. Herein lies the peculiar complexity of the problem. Underlying Gen. xxxiv. and other portions of Genesis may be recognized the tradition of a settlement of Jacob, which belongs to a cycle quite independent of the descent into Egypt and the Exodus (cf. E. Meyer, *op. cit.*, and J. Skinner, *Genesis*, p. 418). But the story of the entrance of Jacob and his "sons" finds a parallel in the entrance of the tribes under Joshua and in the S. move of Judah and Simeon (see GENESIS). With the conquest of Zephath (renamed Hormah, Judg. i. 17) by these tribes, compare not only Judah's settlement (Gen. xxxviii., cf. Skinner p. 450), but also that of Simeon (Gen. xlvi. 10), and the related tradition that Simeon married a Zephathite (Jubilees, xlv. 13). 1 Chron. iv. 39 sqq. mentions a Simeonite occupation of Gedor, or rather Gerar, which would bring this tribe into the district of Kadesh (cf. Gen. xx. 1 seq., xxvi. 1), and adds a raid upon Mount Seir (Edom) ending in the overthrow of Amalek (1 Chron. iv. 39-43).⁵ S. Palestine, associated with Abraham, Isaac and Jacob, and with the separation of the non-Israelite Ishmael and Esau (Edom), is the district whence Jacob departed to his Aramaean relatives (Gen. xxviii. sqq.). Hormah, too, is the scene of an Israelite victory in the story of the Exodus (Num. xxi. 1-3), and is connected with evidence suggesting that this victory at the very gate of the promised land belongs to a tradition of some movement from Kadesh into Judah (Wellhausen, G. F. Moore, H. P. Smith, and others; see EXODUS, THE). The other tradition, that the Israelites were defeated there by Amalekites and Canaanites, explains the detour by Edom and Moab (*ib.* xiv. 25, 40-45), and the appearance of the tribes E. of the Jordan to invade the land of their ancestors. Obviously these represent fundamentally differing views, which cannot be woven into a single outline; and they cannot be isolated from more profound questions which really affect all ordinary conceptions of the structure of biblical history.

See S. A. Cook, *Amer. Journ. of Theol.* xiii. 370-388 (1909); JEWS, §§ 5-8, 22; LEVITES; PALESTINE: *History*. (S. A. C.)

² So in general, the favourite interpretation (Wellhausen, Stade, Guthe and many others) with some variation of detail, see especially Gunkel's commentary (*Handkommentar*, 1901, pp. 335 sqq.).

³ See the instructive study by E. Meyer, *Die Israeliten und ihre Nachbarstämme* (1906), pp. 409-428 (especially his criticisms, p. 421 seq.); cf. also I. Benzinger, *Hebr. Archäologie* (1907), pp. 345 sqq. (whose astral interpretation of the narrative, however, is quite inadequate).

⁴ See Judith ix. 2, Philo, *De Migr. Abrahami*, 39, and, for fuller details of the trend of Jewish opinion, R. H. Charles, *Book of Jubilees*, p. 179, *id.*, "Test. of xii. Patriarchs," p. 22.

⁵ On these wars, see the criticisms of H. W. Hogg in his elaborate study of Simeon, *Ency. Bib.* col. 4524-34.

SIMEON (or **SYMEON**) **OF DURHAM** (d. after 1129), English chronicler, embraced the monastic life before the year 1083 in the monastery of Jarrow; but only made his profession at a later date, after he had removed with the rest of his community to Durham. He was author of two historical works which are particularly valuable for northern affairs. He composed his *Historia ecclesiae Dunelmensis*, extending to the year 1096, at some date between 1104 and 1108. The original manuscript is at Durham in the library of Bishop Cosin. It is divided into four books, which are subdivided into chapters; the order of the narrative is chronological. There are two continuations, both anonymous. The first carries the history from 1096 to the death of Ranulf Flambard (1129); the second extends from 1133 to 1144. A Cambridge MS. contains a third continuation covering the years 1141-1154. About 1129 Simeon undertook to write a *Historia regum Anglorum et Dacorum*. This begins at the point where the *Ecclesiastical History* of Bede ends. Up to 957 Simeon merely copies some old Durham annals, not otherwise preserved, which are of value for northern history; from that point to 1119 he copies Florence of Worcester with certain interpolations. The section dealing with the years 1119-1129 is, however, an independent and practically contemporaneous narrative. Simeon writes, for his time, with ease and perspicuity; but his chief merit is that of a diligent collector and copyist.

Other writings have been attributed to his pen, but on no good authority. They are printed, along with his undoubted works, in the *Scriptores decem* of Roger Twysden (1652). The most complete modern edition is that of Thomas Arnold ("Rolls" series, 2 vols., 1882-1885). The value of the "Northumbrian Annals," which Simeon used for the *Historia regum*, has been discussed by J. H. Hinde in the preface to his *Symeonis Dunelmensis opera*, vol. i. pp. xiv. ff. (1868); by R. Pauli in *Forschungen zur deutschen Geschichte*, xii. pp. 137 sqq. (Göttingen, 1872); and by W. Stubbs in the introduction to *Roger of Hoveden*, vol. i. p. x. ("Rolls" series). Simeon's works have been translated by J. Stevenson in his *Church Historians of England*, vol. iii. part ii. (1855). (H. W. C. D.)

SIMEON, CHARLES (1759-1836), English evangelical divine, was born at Reading and educated at Eton and Cambridge. In 1782 he became fellow of King's College, Cambridge, and took orders, receiving the living of Holy Trinity, Cambridge, in the following year. He was at first so unpopular that the services were frequently interrupted, and he was often insulted in the streets. Having lived down this prejudice, he subsequently gained a very remarkable and lasting influence among the undergraduates of the university. He became a leader among evangelical churchmen, was one of the founders of the Church Missionary Society, and acted as adviser to the East India Company in the choice of chaplains for India. His chief work is a commentary upon the whole Bible, entitled *Horae homileticae* (London, 1819-1820). He died on the 13th of November 1836. The "Simeon Trustees" were instituted by him for the purpose of acquiring church patronage in the interests of evangelical views.

See *Memoirs of Charles Simeon*, with a selection from his writings and correspondence, edited by the Rev. W. Carus (3rd ed., 1848); H. C. G. Moule, *Charles Simeon* (London, 1892).

SIMÉON, JOSEPH JÉRÔME, COMTE (1749-1842), French jurist and politician, was born at Aix on the 30th of September 1749. His father, Joseph Sextius Siméon (1717-1788), had been professor of law and royal secretary for the parlement of Provence. J. J. Siméon followed his father's profession, but he was outlawed for his share in the federalist movement in 1793, and only returned to France after the revolution of Thermidor. In the council of the Five Hundred, of which he was now a member, he took the conservative side. In 1799, for protesting against the invasion of the chamber by P. F. C. Augereau, he was imprisoned until the 18th Brumaire (9th November). In the Tribunal he had an important share in the preparation of the Civil Code, being rewarded by a seat in the council of state. In 1807 he was one of the commissioners sent to organize the new kingdom of Westphalia, and was premier of King Jerome. He served the Restoration as councillor of state and in the chamber of peers. In 1820 he was under-secretary of state for justice, and in the next year minister of the interior until the fall of the Richelieu ministry. A baron of the Empire

and count at the second Restoration, he was admitted to the Academy of Moral and Political Science in 1832, and in 1837 he became president of the Cour des Comptes. He died in Paris on the 19th of January 1842 in his 93rd year.

His son, **JOSEPH BALTHASAR, COMTE SIMÉON** (1781-1846), entered the diplomatic service under the Empire. At the Restoration he was successively prefect of Var, Doubs and Pas de Calais. He was director-general of fine arts in 1828, and had a great reputation as a connoisseur and collector.

SIMEON STYLITES, ST (390-459), the first and most famous of the Pillar-hermits (Gr. *στυλος*, pillar), was born in N. Syria. After having been expelled from a monastery for his excessive austerities, at thirty years of age he built a pillar six feet high on which he took up his abode. He made new pillars higher and higher, till after ten years he reached the height of sixty feet. On this pillar he lived for thirty years without ever descending. A railing ran round the capital of the pillar, and a ladder enabled his disciples to take him the necessaries of life. From his pillar he preached and exercised a great influence, converting numbers of heathen and taking part in ecclesiastical politics. The facts would seem incredible were they not vouched for by Theodoret, who knew him personally (*Historia religiosa*, c. 26). Moreover, Simeon had many imitators, well authenticated Pillar-hermits being met with till the 16th century.

The standard work on the subject is *Les Stylites* (1895), by H. Delehaye, the Bollandist; for a summary see the article "Säulenheilige," in Herzog's *Realencyklopädie* (ed. 3). On Simeon see Th. Nöldeke's *Sketches from Eastern History* (1892), p. 210, and the *Dictionary of Christian Biography*. (E. C. B.)

SIMFEROPOL, a town of Russia, capital of the government of Taurida, in the S. of the Crimea, 78 m. by rail N.E. of Sevastopol and 800 from Moscow. Pop. (1897) 60,876. It occupies an admirable site on the N. slopes of the Chatyr-dagh Mountains, and is divided into two parts—the European, well built in stone, and the Tatar, with narrow and filthy streets peopled by some 7000 Tatars and by Jews. Although it has grown since the railway brought it into connexion with the rest of the empire, it still remains a mere administrative centre. It is the see of a bishop of the Orthodox Greek Church and the headquarters of the 7th Russian army corps. There are a museum and monuments to Dolgoruki, conqueror of the Crimea, and to the empress Catherine II. (1890). The town is famous for its fruit.

In the neighbourhood stood the small fortress of Napoli, erected by the ruler of Taurida some hundred years before the Christian era, and it existed until the end of the 3rd century. Afterwards the Tatar settlement of Ak-mechet, which in the 17th century was the residence of the chief military commander of the khan, had the name of Sultan-serai. In 1736 it was taken and burnt by the Russians, and in 1784, after the conquest of the Crimea by the Russians, it received its present name and became the capital of Taurida.

SIMLA, a town and district in British India, in the Delhi division of the Punjab. The town is the summer residence of the viceroy and staff of the supreme government, and also of the Punjab government. It is 58 m. by cart-road from the railway station of Kalka, which is 1116 m. from Calcutta. A metre-gauge railway, 68 m. long, was opened from Kalka to Simla in 1903. The population in 1901 was 13,960, but that was only the winter population, and the summer census of 1904 returned the number of 35,250. The sanatorium of Simla occupies a spur of the lower Himalaya, running E. and W. for about 6 m. The ridge culminates at the E. in the eminence of Jakke, in the vicinity of which bungalows are most numerous; the viceregal lodge stands on Observatory Hill. The E. of the station is known as Chota Simla and the W. as Boileauganj. The situation is one of great beauty; and the houses, built separately, lie at elevations between 6600 and 8000 ft. above sea-level. To the N., a beautiful wooded spur, branching from the main ridge, is known as Elysium. Three miles W. is the cantonment of Jutogh. The minor sanatoria of Kasauli, Sabathu, Dagshai and Solon lie some distance to the S. The first European house at Simla was built in 1819, and the place was first visited by a governor-general in 1827. It has gradually

become the permanent headquarters of many of the official establishments. During the season Simla is the focus of Indian society; and viceregal and other balls, and entertainments of every description, are frequent. Simla is the headquarters of a volunteer rifle corps, and there are numerous libraries and institutes, of which the chief is the United Service Institution, with a subsidy from government. The two chief medical institutions are the Ripon and Walker hospitals. There are a theatre, concert room and numerous churches. Educational institutions include Bishop Cotton's school for boys, the Mayo industrial school for girls, several aided schools for European boys and girls, and two Anglo-vernacular schools for natives. The Lawrence military asylums are at Sanawar, near Kasauli.

The DISTRICT OF SIMLA has an area of 101 sq. m., and had a population in 1901 of 40,351. The mountains of Simla and the surrounding native states compose the S. outliers of the great central chain of the E. Himalaya. They descend in a gradual series from the main chain to the general level of the Punjab plain, forming a transverse S.W. spur between the great basins of the Ganges and the Indus. S. and E. of Simla the hills between the Sutlej and the Tons centre in the great peak of Chor, 11,982 ft. above sea-level. Throughout all the hills forests of deodar abound, while rhododendrons clothe the slopes up to the limit of perpetual snow. The principal rivers are the Sutlej, Pahar, Giri, Gambhar and Sarsa.

The acquisition of the patches of territory forming the district dates from various times subsequent to the close of the Gurkha War in 1816, which left the British in possession of the whole tract of hill-country from the Gogra to the Sutlej. Kumaon and Dehra Dun were annexed to the British dominions; but the rest, with the exception of a few localities retained as military posts and a portion sold to the raja of Patiala, was restored to the hill rajas, from whom it had been wrested by the Gurkhas. Garhwal state became attached to the North-Western Provinces; but the remaining principalities rank among the dependencies of the Punjab, and are known collectively as the Simla Hill States, under the superintendence of the deputy-commissioner of Simla, subordinate to the commissioner at Umballa. The chief of the Simla Hill States—which number 28 in all—are Jubbāl, Bashahr, Keonthal, Baghal, Bilaspur and Hindur.

SIMLER, JOSIAS (1530–1576), author of the first book relating solely to the Alps, was the son of the former prior of the Cistercian convent of Kappel (Canton of Zürich), and was born at Kappel, where his father was the Protestant pastor and schoolmaster till his death in 1557. In 1544 Simler went to Zürich to continue his education under his godfather, the celebrated reformer, Heinrich Bullinger. After having completed his studies at Basel and Strassburg, he returned to Zürich, and acted as a pastor in the neighbouring villages. In 1552 he was made professor of New Testament exegesis at the Carolinum at Zürich, and in 1560 became professor of theology. In 1559 he had his first attack of gout, a complaint which finally killed him. In 1555 he published a new edition of Conrad Gesner's *Epitome* of his *Bibliotheca universalis* (a list of all authors who had written in Greek, Latin or Hebrew), in 1574 a new edition of the *Bibliotheca* itself, and in 1575 an annotated edition of the *Antonine Itinerary*. About 1551 he conceived the idea of making his native land better known by translating into Latin parts of the great *Chronik* of Johann Stumpf. With this view he collected materials, and in 1574 published a specimen of his intended work in the shape of a monograph on the Canton of the Valais. He published in the same volume a general description of the Alps, as the Introduction to his projected work on the several Swiss Cantons. In this treatise, entitled *De Alpibus commentarius*, he collected all that the classical authors had written on the Alps, adding a good deal of material collected from his friends and correspondents. This *Commentarius* is the first work exclusively devoted to the Alps, and sums up the knowledge of that region possessed in the 16th century. It was republished by the Elzevirs at Leiden in 1633, and again at Zürich in 1735, while an elaborate annotated edition (prepared by Mr Coolidge), with French translation, notes and appendices, appeared at

Grenoble in 1904. Another fragment of his vast plan was the work entitled *De Helvetiorum republica*, which appeared at Zürich in 1576, just before his death. It was regarded as the chief authority on Swiss constitutional matters up to 1798.

See lives by G. von Wyss (Zürich, 1855), and in Mr Coolidge's book, pp. cxlvii-clviii. (W. A. B. C.)

SIMMONS, EDWARD EMERSON (1852–), American artist, was born at Concord, Massachusetts, on the 27th of October 1852. He graduated from Harvard College in 1874, and was a pupil of Lefebvre and Boulanger in Paris, where he took a gold medal. He was awarded the prize by the Municipal Art Society of New York for a mural decorative scheme, which he carried out for the criminal courts building, later decorating the Waldorf-Astoria hotel in New York, the Library of Congress, Washington, and the Capitol at Saint Paul, Minnesota. He was one of the original members of the Ten American Painters.

SIMMS, WILLIAM GILMORE (1806–1870), American poet, novelist and historian, was born at Charleston, S.C., on the 17th of April 1806 of Scotch-Irish descent. His mother died during his infancy, and his father having failed in business and joined Coffee's Indian fighters, young Simms was brought up by his grandmother. He was clerk in a drug store for some years, and afterwards studied law, the bar of Charleston admitting him to practice in 1827, but he soon abandoned his profession for literature. At the age of eight he wrote verses, and in his 19th year he produced a *Monody on Gen. Charles Cotesworth Pinckney* (Charleston, 1825). Two years later, in 1827, *Lyrical and Other Poems* and *Early Lays* appeared; and in 1828 he began journalism, editing and partly owning the *City Gazette*. The enterprise failed, and the editor devoted his attention entirely to letters, and in rapid succession published *The Vision of Cortes, Cain, and other Poems* (1829), *The Tricolor, or Three Days of Blood in Paris* (1830), and his strongest poem, *Atalantis*, a story of the sea (1832). *Atalantis* established his fame as an author, and *Martin Faber, the Story of a Criminal*, was warmly received. During the American Civil War Simms espoused the side of the Secessionists in a weekly newspaper, and suffered damage at the hands of the Federal troops when they entered Charleston. He served in the state House of Representatives in 1844–1846, and the university of Alabama conferred on him the degree of LL.D. He died at Charleston on the 11th of June 1870.

In addition to the works mentioned above, Simms published the following poetry:—*Southern Passages and Pictures*, lyrical, sentimental and descriptive poems (New York, 1839); *Donna Florida*, a tale (Charleston, 1843); *Grouped Thoughts and Scattered Fancies*, sonnets (Richmond, 1845); *Areytos, or Songs of the South* (1846); *Lays of the Palmetto; a Tribute to the South Carolina Regiment in the War with Mexico* (Charleston, 1848); *The Eye and the Wing*, poems, (New York, 1848); *The City of the Silent* (1850). To dramatic literature he contributed *Norman Maurice, or the Man of the People* (Richmond, 1851); and *Michael Bonham, or the Fall of the Alamo* (Richmond, 1852). His romances of the American Revolution—*The Partisan* (1835); *Mellichampe* (1836); *Katherine Walton, or the Rebel of Dorchester* (1851); and others—describe social life at Charleston, and the action covers the whole period, with portraits of the political and military leaders of the time. Of border tales the list includes *Guy Rivers, a Tale of Georgia* (1834); *Richard Hurd's* (1838); *Border Beagles* (1840); *Beauchampe* (1842); *Helen Halsey* (1845); *The Golden Christmas* (1852); and *Charlemont* (1856). The historical romances are *The Yemassee* (1835), dealing largely with Indian character and nature; *Pelayo* (1838); *Count Julien* (1845); *The Damsel of Darien* (1845); *The Lily and the Tolem*; *Vasconcelos* (1857), which he wrote under the assumed name of "Frank Cooper"; and *The Cassique of Kiawah* (1860). Other novels are *Carl Werner* (1838); *Confession of the Blind Heart* (1842); *The Wigwam and the Cabin*, a collection of short tales (1845–1846); *Castle Dismal* (1845); and *Marie de Berniere* (1853). Simms's other writings comprise a *History of S. Carolina* (Charleston, 1840); *South Carolina in the Revolution* (Charleston, 1853); *A Geography of South Carolina* (1843); lives of *Francis Marion* (New York, 1844); *Capt. John Smith* (1846); *The Chevalier Bayard* (1848) and *Nathanael Green* (1849); *The Ghost of my Husband* (1866); and *War Poetry of the South*—an edited volume—(1867). Simms was also a frequent contributor to the magazines and literary papers, six of which he founded and conducted. In the discussion on slavery he upheld the views of the pro-slavery party. He edited the seven dramas doubtfully ascribed to Shakespeare, with notes and an introduction to

each play. Simms' works in 10 vols. were published at New York in 1882; his *Poems* (2 vols., New York) in 1853.

See his biography (Boston, 1892), by Professor William P. Trent. A bibliographical *List of the Separate Writings of W. G. Simms of South Carolina* (New York, 1906) was compiled by O. Wegelin.

SIMNEL, LAMBERT (fl. 1477-1534). English impostor, was probably the son of a tradesman at Oxford. He was about ten years old in 1487, and was described as a handsome youth of intelligence and good manners. In 1486, the year following the accession of Henry VII., rumours were disseminated by the adherents of the Yorkist dynasty that the two sons of Edward IV., who had been murdered in the Tower of London, were still alive. A young Oxford priest, Richard Symonds by name, conceived the project of putting forward the boy Simnel to impersonate one of these princes as a claimant for the crown, with the idea of thereby procuring for himself the archbishopric of Canterbury. He set about instructing the youth in the arts and graces appropriate to his pretended birth; but meanwhile a report having gained currency that the young earl of Warwick, son of Edward IV.'s brother George, duke of Clarence, had died in the Tower, Symonds decided that the impersonation of this latter prince would be a more easily credible deception. It is probable that Symonds acted throughout with the connivance of the Yorkist leaders, and especially of John de la Pole, earl of Lincoln, himself a nephew of Edward IV., who had been named heir to the crown by Richard III. The Yorkists had many adherents in Ireland, and thither Lambert Simnel was taken by Symonds early in 1487; and, gaining the support of the earl of Kildare, the archbishop of Dublin, the lord chancellor and a powerful following, who were, or pretended to be, convinced that the boy was the earl of Warwick escaped from the Tower, Simnel was crowned as King Edward VI. in the cathedral in Dublin on the 24th of May 1487. Messages asking for help were sent to Margaret, duchess of Burgundy, sister of Edward IV., to Sir Thomas Broughton and other Yorkist leaders.

On the 2nd of February 1487 Henry VII. held a council at Sheen to concert measures for dealing with the conspiracy. Elizabeth Woodville, widow of Edward IV., was imprisoned in the convent of Bermondsey; and the real earl of Warwick was taken from the Tower and shown in public in the streets of London. But although Lincoln is said to have conversed with Warwick on this occasion, he fled abroad immediately after the council at Sheen, where he was present. In Flanders, Lincoln joined Lord Lovell, who had headed an unsuccessful Yorkist rising in 1486, and in May 1487 the two lords proceeded to Dublin, where they landed a few days before the coronation of Lambert Simnel. They were accompanied by 2000 German soldiers under Martin Schwartz, procured by Margaret of Burgundy to support the enterprise, Margaret having recognized Simnel as her nephew. This force, together with some ill-armed Irish levies commanded by Sir Thomas Fitzgerald, landed in Lancashire on the 4th of June. King Henry was at Coventry when the news of the landing reached him, and immediately marched to Nottingham, where his army was strengthened by the addition of 6000 men. The invaders met with little encouragement from the populace, who were not well disposed towards a monarch whom it was sought to impose upon them by the aid of Irish and German mercenaries. Making for the fortress of Newark, Lincoln and Sir Thomas Broughton, at the head of their motley forces, and accompanied by Simnel, attacked the royal army near the village of Stoke-on-Trent on the 16th of June 1487. After a fierce and stubborn struggle in which the Germans behaved with great valour, the Royalists were completely victorious, though they left 2000 men on the field; Lincoln, Schwartz and Fitzgerald with 4000 of their followers were killed, and Lovell and Broughton disappeared never to be heard of again. The priest Symonds, and Simnel were taken prisoners. The former was consigned to a dungeon for the rest of his life; but Henry VII., recognizing that the youthful pretender had been a tool in the hands of others and was in himself harmless, pardoned Lambert Simnel and took him into his own service in the menial capacity of scullion. He was later promoted to be royal falconer and is said to have afterwards become a

servant in the household of Sir Thomas Lovell. The date of Simnel's death is unknown, but he is known to have been still living in the year 1534.

See *Rolls of Parliament. VI.*: Francis Bacon, *History of Henry VII.*, with notes by J. R. Lumby (Cambridge, 1881); Richard Bagwell, *Ireland under the Tudors* (3 vols., London, 1885-1890); James Gairdner, *Henry VII.* (London, 1889) and *Letters and Papers illustrative of the reigns of Richard III. and Henry VII.* ("Rolls" series, 2 vols., London, 1861-1863); *The Political History of England*, vol. v., by H. A. L. Fisher (London, 1906); and W. Busch, *England under the Tudors* (1895). For a contemporary account of Simnel's imposture, see Polydore Vergil, *Anglicae historiae*, to which all the later narratives are indebted. (R. J. M.)

SIMOCATTA,¹ THEOPHYLACT, Byzantine historian, a native of Egypt, flourished at Constantinople during the reign of Heraclius (610-640), under whom he held the office of imperial secretary. He is best known as the author of a history, in eight books, of the reign of the emperor Maurice (582-602), for which period he is the best and oldest authority. The work describes the wars with the Persians, the Avars and Slavs, and the emperor's tragic end. "His want of judgment renders him diffuse in trifles and concise in the most interesting facts" (Gibbon), but his general trustworthiness is admitted. The history contains an introduction in the form of a dialogue between History and Philosophy. Photius (cod. 65) while admitting a certain amount of gracefulness in the language, blames the author's excessive use of figurative and allegorical expressions and moral sentiments. While the vocabulary contains many strange and affected words, the grammar and syntax are on the whole correct (ed. pr. by J. Pontanus, 1609; best edition by C. de Boor, 1887, with a valuable Index Graecitatis).

Simocatta was also the author of *Physical Problems* (*Ἀπορίας φυσικαί*) in dialogue form, dealing with the nature of animals and especially of man (ed. J. Ideler in *Physici et medici Graeci minores*, i. 1841); and of a collection of 85 letters (moral, rustic, crotic), the supposed writers of which are either fictitious or well-known personages (Antisthenes to Pericles, Socrates to Plato, Socrates to Alcibiades). The best edition is by R. Hercher in *Epistolographi Graeci* (1873). The letters were translated into Latin (1509) by Copernicus (reprinted 1873 by F. Hipler in *Spicilegium Copernicanum*).

See C. Krumbacher, *Geschichte der byzantinischen Literatur* (1897).

SIMON, ABRAHAM (1622-1692), English medallist and modeller, was born in Yorkshire in 1622. He was originally intended for the church, but turned his attention to art, and, after studying in Holland, proceeded to Sweden, where he was employed by Queen Christina, in whose train he travelled to Paris. He returned to England before the outbreak of the Civil War, and attained celebrity by his medals and portraits modelled in wax. During the Commonwealth he executed many medals of leading parliamentarians, and at the Restoration he was patronized by Charles II., from whom he received a hundred guineas for his portrait designed as a medal for the proposed order of the Royal Oak. Having incurred the displeasure of the duke of York, he lost the favour of the court, and died in obscurity in 1692. Among the more interesting of his medals are those of the 2nd earl of Dunfermline, the 2nd earl of Lauderdale and the 1st earl of Loudon; that of the duke of Albemarle, and many other fine medals, were modelled by Abraham Simon and chased by his brother Thomas Simon (*q.v.*).

SIMON, SIR JOHN (1816-1904), English surgeon and sanitary reformer, was born in London on the 10th of October 1816. His father, Louis Michael Simon, was for many years a leading member of the London Stock Exchange. Both his grandfathers were French emigrants, who carried on business in London and Bath respectively. His father died at almost ninety-eight, and his mother at nearly ninety-five years of age. Simon was educated at a preparatory school in Pentonville, spent seven years at Dr Burney's school in Greenwich, and then ten months with a German Pfarrer in Rhenish Prussia. His father intended him for surgery, and he began the study of medicine on 1st October 1833, when he was a few days short of seventeen. He was an apprentice of Joseph Henry Green, the distinguished surgeon at St Thomas's, well known for his friendship for Samuel Taylor Coleridge, whose literary executor Green became. He became

¹ Other forms of the name are Simocattos, Simocatos, Simocates.

a demonstrator of anatomy, and was assistant surgeon to King's College Hospital for several years; and in the autumn of 1847 he was appointed surgeon and lecturer on pathology at his old school, St Thomas's, where, with progressive changes, he continued to remain an officer. His life was divided between two great pursuits—the career of a surgeon, and the mastery and solution of many of the great problems of sanitary science and reform. In the spring of 1844 he gained the first Astley Cooper prize by a physiological essay on the thymus gland, and the following year was elected a fellow of the Royal Society. In 1847 he gave his first lecture at St Thomas's Hospital, on the "Aims and Philosophic Method of Pathological Research," followed a little later by lectures on general pathology in relation to the principles of diagnosis, and the treatment of disease. These lectures were of great importance at the time, and of the utmost value in directing energy into new and profitable channels of work. Simon published many clinical surgical lectures of the greatest importance, and contributed a masterly article on "Inflammation" to Holmes's *System of Surgery*, which has become a classic of its kind. It was, however, on his appointment in 1848 as medical officer of health to the City of London, and afterwards to the government, that Simon's great abilities found scope for congenial exercise. He stimulated and guided the development of sanitary science, until it reached in England the highest degree of excellence, and gave an example to the civilized world. It is impossible to overestimate the value of Sir John Simon's work, or the importance of his influence in the furtherance of the public health and the prevention of disease, and in inculcating right methods of medical government. In 1878, after filling other offices in the Royal College of Surgeons, he became its president, and in 1887 was created K.C.B. It was largely due to his advocacy that the new St Thomas's Hospital was rebuilt on its present site after it was compelled to leave its old habitation near London Bridge. As a surgeon, Simon's work came second to his interest in sanitary science, but he claimed priority over Cock in the operation of perineal puncture of the urethra in cases of retention from stricture. He died on the 23rd of July 1904. (W. MACC.)

SIMON, JULES FRANÇOIS (1814–1896), French statesman and philosopher, was born at Lorient on the 27th of December 1814. His father was a linen-draper from Lorraine, who abjured Protestantism before his second marriage, of which Jules Simon was the son, with a Catholic Breton. The family name was Suisse, which Simon dropped in favour of his third prenom. By dint of considerable sacrifice he was able to attend a seminary at Vannes, and was for a short time usher in a school before, in 1833, he became a student at the École Normale in Paris. There he came in contact with Victor Cousin, who sent him to Caen and then to Versailles to teach philosophy. He helped Cousin, without receiving any recognition, in his translations from Plato, and in 1839 became his deputy in the chair of philosophy at the Sorbonne, with the meagre salary of 83 francs per month. He also lectured on the history of philosophy at the École Normale. At this period he edited the works of Malebranche (2 vols., 1842), of Descartes (1842), Bossuet (1842) and of Arnauld (1843), and in 1844–1845 appeared the two volumes of his *Histoire de l'école d'Alexandrie*. He became a regular contributor to the *Revue des deux mondes*, and in 1847, with Amédée Jacques and Émile Saisset, founded the *Liberté de penser*, with the intention of throwing off the yoke of Cousin, but he retired when Jacques allowed the insertion of an article advocating the principles of collectivism, with which he was at no time in sympathy. In 1848 he represented the Côtes-du-Nord in the National Assembly, and next year entered the Council of State, but was retired on account of his republican opinions. His refusal to take the oath of allegiance to the government of Louis Napoleon after the *coup d'état* was followed by his dismissal from his professorship, and he devoted himself to philosophical and political writings of a popular order. *Le Devoir* (1853), which was translated into modern Greek and Swedish, was followed by *La Religion naturelle* (1856, Eng. trans., 1887), *La Liberté de conscience* (1857), *La Liberté politique*

(1859), *La Liberté civile* (1859), *L'Ouvrière* (1861), *L'École* (1864), *Le Travail* (1866); *L'Ouvrier de huit ans* (1867) and others. In 1863 he was returned to the Corps Législatif for the 8th circonscription of the Seine, and supported "les Cinq" in their opposition to the government. He became minister of instruction in the government of National Defence on the 5th of September 1870. After the capitulation of Paris in January 1871 he was sent down to Bordeaux to prevent the resistance of Gambetta to the peace. But at Bordeaux Gambetta, who had issued a proclamation excluding from the elections officials under the Empire, was all powerful. He affected to dispute Jules Simon's credentials, and issued orders for his arrest. Meanwhile Simon had found means of communication with Paris, and on the 6th of February was reinforced by Eugène Pelletan, E. Arago and Garnier-Pagès. Gambetta resigned, and the ministry of the Interior, though nominally given to Arago to avoid the appearance of a personal issue, was really in Simon's hands. Defeated in the department of the Seine, he sat for the Marne in the National Assembly, and resumed the portfolio of Education in the first cabinet of M. Thiers's presidency. He advocated free primary education yet sought to conciliate the clergy by all the means in his power; but no concessions removed the hostility of Mgr. Dupanloup, who presided over the commission appointed to consider his draft of an elementary education bill. The reforms he was actually able to carry out were concerned with secondary education. He encouraged the study of living languages; and limited the attention given to the making of Latin verse; he also encouraged independent methods at the École Normale, and set up a school at Rome where members of the French school of Athens should spend some time. He retained office until a week before the fall of Thiers in 1873. He was regarded by the monarchical right as one of the most dangerous obstacles in the way of a restoration, which he did as much as any man (except perhaps the comte de Chambord himself) to prevent, but by the extreme left he was distrusted for his moderate views, and Gambetta never forgave his victory at Bordeaux. In 1875 he became a member of the French Academy and a life senator, and in 1876, on the resignation of M. Dufaure, was summoned to form a cabinet. He replaced anti-republican functionaries in the civil service by republicans, and held his own until the 3rd of May 1877, when he adopted a motion carried by a large majority in the Chamber inviting the cabinet to use all means for the repression of clerical agitation. His clerical enemies then induced Marshal MacMahon to take advantage of a vote on the press law carried in Jules Simon's absence from the Chamber to write him a letter regretting that he no longer preserved his influence in the Chamber, and thus practically demanding his resignation. His resignation in response to this act of the president, known as the "Seize Mai," which he might have resisted by an appeal to the Chamber, proved his ruin, and he never again held office. He justified his action by his fear of providing an opportunity for a *coup d'état* on the part of the marshal. The rejection (1880) of article 7 of Ferry's Education Act, by which the profession of teaching would have been forbidden to members of non-authorized congregations, was due to his intervention. He was in fact the chief of the left centre opposed to the radicalism of Jules Grévy and Gambetta. He was director of the *Gaulois* from 1879 to 1881, and his influence in the country among moderate republicans was retained by his articles in the *Matin* from 1882 onwards, in the *Journal des Débats*, which he joined in 1886, and in the *Temps* from 1890.

He left accounts of some of the events in which he had participated in *Souvenirs du 4 septembre* (1874), *Le Gouvernement de M. Thiers* (2 vols., 1878), in *Mémoires des autres* (1889), *Nouveaux mémoires des autres* (1891) and *Les Derniers mémoires des autres* (1897), while his sketch of *Victor Cousin* (1887) was a further contribution to contemporary history. For his personal history the *Premiers mémoires* (1900) and *Le Soir de ma journée* (1902), edited by his son Gustave Simon, may be supplemented by Léon Séché's *Figures bretonnes, Jules Simon, sa vie, son œuvre* (new ed., 1898), and G. Picot, *Jules Simon: notice historique* . . . (1897); also by many references to periodical literature and collected essays in Hugo P. Thieme's *Guide bibliographique de la litt. franç. de 1800 à 1906* (1907).

SIMON MAGUS ("Simon the Magician"; Gr. μάγος, a wizard), a character who appears in the New Testament and also in the works of the Christian Fathers. In Acts viii. 5-24 he is portrayed as a famous sorcerer in Samaria who had been converted to Christianity by Philip. His personality has been the subject of considerable discussion. The conclusions to which the present writer has been led are mainly as follows: (1) that all we know of the original Simon Magus is contained in Acts; (2) that from very early times he has been confused with another Simon; (3) that the idea that Simon Magus is merely a distortion of St Paul is absurd.

As regards the story of Acts viii. 5-24, it will suffice to make a few remarks. First it is interesting to note that Simon Magus was older than Christianity. The first missionary enterprise of the nascent Church brought it into contact with a magician who had for a long time amazed the people of Samaria with his sorceries (v. 11). This person gave himself out to be "some great one," but the popular voice defined his claims by saying "this man is that power of God which is called Great." Such a voice of the people cannot be imagined in Judaea, but Samaria was more open than Judaea to the influence of Greek ideas. Readers of Philo are familiar with the half-philosophical and half-mythological mode of thought by which the "powers of God" are substantialized into independent personalities. There were powers of all sorts, powers of help and salvation and also powers of punishment (Philo i. 431). It was through these powers that the incorporeal world of thought was framed, which served as the archetype of this world of appearance. The various powers are sometimes summed up under the two heads of βασιλική and εβεργερική, which correspond to the two names κύριος and θεός. Which of them—if it is lawful at all to argue from Alexandria to Samaria—is to be identified with the one called "great" we have no means of deciding. Notwithstanding his own success as a magician Simon Magus was amazed in his turn at the superior power of Christianity. But he did not understand that this power was spoilt by self-seeking, and his offer of money to the Apostles, to enable him to confer the gift of the Holy Ghost, has branded his name for ever through the use of the word "simony" (q.v.). He was, however, a baptized Christian, and accepted with meekness the rebuke of Peter. The last that we hear of him is his humble entreaty to the Apostles to pray for him. Had the writer of Acts known anything of his subsequent adventures, he might certainly have been expected to give some hint of them.

There is no reason for identifying the Simon Magus of Acts with the Simon, also a magician, who was a friend of Felix, and employed by him to tempt Drusilla away from her husband Azizus, the king of the Emesites. The name Simon was common, and so was the claim to magical powers. But the Simon of Josephus (*Ant.* xx. 7, § 2) is expressly declared to have been a Jew and a native of Cyprus.

The Apostolic Fathers say nothing about Simon Magus, but with Justin Martyr we get startling developments. In his *First Apology*, written in A.D. 138 or 139, he tells us that one Simon, a Samaritan, from a village called Gitta or Gittae (see *Ency. Bibl.* iv. col. 4538), performed such miracles by magic acts in Rome during the reign of Claudius, that he was regarded as a god and honoured with a statue "in the river Tiber, between the two bridges, having an inscription in Latin as follows: SIMONI DEO SANCTO." "And almost all the Samaritans," he goes on to say, "and a few among the other nations, acknowledge and adore him as the first God. And one Helen, who went about with him at that time, who before had had her stand in a brothel, they say was the first thought that was brought into being by him" (*Apol.* i. 26. 1-3). Justin goes on to speak, as from personal knowledge, of the feats of magic performed by Menander, another Samaritan and a disciple of Simon's, who persuaded his followers that they would never die. After Menander Justin proceeds to speak of Marcion, who was still teaching at the time. The followers of Simon Magus, of Menander and of Marcion, he says, were all called Christians, but so also Epicureans and Stoics were alike called philosophers. He had himself composed a treatise against all the heresies that there had been, which he was willing to present to the imperial family (*Apol.* i. 26. 4-8). As Justin was himself a Samaritan it is natural that his fellow-countrymen should bulk largely in his eyes. Accordingly we find him reverting to Simon and Menander in a later passage of the same *Apology*, where he repeats that in the royal city of Rome, in the time of Claudius Caesar, Simon so astonished "the holy Senate" and the Roman people that he was worshipped as a god and honoured with a statue (*Apol.* i. 56), which Justin petitions to have taken down. In the *Second Apology* also there is a passage which seems mutilated or misplaced, in which he declares himself to have "despised the impious and misleading teaching of the Simonians in his own nation" (*Apol.* ii. 15. 1). In the *Dialogue* (349 c, ch. 120) he prides himself on the independence and love of truth which he had displayed in the *Apology*. "For," he says, "in writing to Caesar, I showed no regard even for any of my own nation, but said that they were deceived by trusting in a magician of their own race, Simon, whom

they assert to be God, above all rule and authority and power" (cf. *Eph.* i. 21).

Such is the testimony of Justin; what is it worth? In 1574, during the pontificate of Gregory XIII., a stone was dug up in the island of the Tiber bearing the inscription—"Semoni Sango Deo Sacrum Sex. Pompeius" (see SEMO SANCUS). This discovery has led many to suspect that Justin Martyr has somehow been hoaxed. The stone is not the only one of its kind, and it is a serious charge to bring against Justin to suppose him guilty of so silly a confusion as this. But Justin Martyr was decidedly weak in history, and it is not unreasonable to suppose that he may have confused the Simon of *Acts* with a heretical leader of the same name who lived much nearer to his own time, especially as this other Simon also had a great reputation for magic. A full century must have elapsed between the conversion of Simon Magus to Christianity and the earliest date possible (which is the one that we have adopted) for the composition of Justin Martyr's *First Apology*. That work is assigned by Schmiedel and others to about A.D. 152. Justin Martyr could not have been mistaken as to the fact that the bulk of his countrymen were followers of a religious leader named Simon, whose disciple Menander he seems to speak of as an elder contemporary of his own. But having a mind void of historical perspective he identified this Simon with Simon Magus.

When once this identification has been made by Justin, it was taken for granted by almost all subsequent writers. The temptation to trace all heresy to one who had been condemned by Peter was too strong for the Fathers.¹ Dr George Salmon brought light into darkness by distinguishing between Simon of Gitta and the original Simon Magus. What has not perhaps been so clearly perceived is the consequence that all that is told about Helen refers to the later Simon.

With Hegesippus, who wrote during the episcopate of Eleutherus (A.D. 176-189), as with Justin, Simon heads the list of heretics, but there is no identification of him with Simon Magus; indeed, the context plainly excludes it (*Eus. H.E.* iv. 22). Hegesippus.

During the same episcopate Irenaeus was appointed bishop of Lyons. In his work *Against Heresies* (i. 16) we hear for the first time of opposition on the part of Simon to the Apostles after his pretended conversion. His magic, we are told, procured him the honour of a statue from the emperor Claudius. He was glorified by many as God, and he taught that it was he who appeared among the Jews as the Son, in Samaria as the Father and among other nations as the Holy Spirit. He was indeed the highest power, the Father, who is above all, but he consented to be called by whatever name men chose to give him. Irenaeus then goes on to tell how at Tyre Simon rescued Helen from prostitution, and took her about with him, saying that she was the first thought of his mind, the mother of all things, by whom in the beginning he had conceived the idea of making angels and arch-angels. For that this Thought (*ἐννοια*), recognizing her father's will, had leapt forth from him, and descended to lower regions, and generated the angelic powers by whom this world was made. But after she had done so she was detained by them through ill-will, since they did not wish to be thought the offspring of any other being. For, as for himself, they knew nothing at all about him. But his Thought had been detained by the angelic powers which had been sent forth from her, and had been subjected by them to every indignity, so that she might not return on high to her own father, inasmuch that she was even enclosed in a human body, and for age after age transmigrated into different female forms, as though from one vessel into another. For she had been also in that Helen who was the cause of the Trojan War. But while she passed from body to body, and consequently suffered perpetual indignity, she had at the last been prostituted in a brothel; she was "the lost sheep." Wherefore he himself had come to free her from her bonds, and to confer salvation upon men through knowledge of himself. For as the angels were mismanaging the world, owing to their individual lust for rule, he had come to set things straight, and had descended under a changed form, likening himself to the Principalities and Powers through whom he passed, so that among men he appeared as a man, though he was not a man, and was thought to have suffered in Judaea, though he had not suffered. But the prophets had delivered their prophecies under the inspiration of the world-creating angels: wherefore those who had their hope in him and in Helen minded them no more, and, as being free, did what they pleased; for men were saved according to his grace, but not according to just works. For works were not just by nature, but only by convention, in accordance with the enactments of the world-creating Angels, who by precepts of this kind sought to bring men into slavery. Wherefore he promised that the world should be dissolved, and that those who were his should be freed from the dominion of the world-creators. Irenaeus concludes his account by saying that this Antinomian teaching had its logical consequence in his followers, who lived licentious lives and practised every kind of magic. They also, he adds, worshipped

¹ Clement of Alexandria (*Strom.* vii. § 107) alone seems to have an inkling that there was something wrong. He puts Simon after Marcion, and yet refers in the same breath to his acceptance of Peter's preaching.

images of Simon under the form of Zeus, and of Helen under that of Athena. They were called *Simoniani*, and were the introducers of "knowledge falsely so called." In the next chapter Irenaeus speaks of Menander, who was also a Samaritan, as the successor of Simon, and as having, like him, attained to the highest pitch of magic. His doctrine is represented as being the same as that of Simon, only that it was *he* this time who was the saviour of the world.

It is evident that the Samaritans were not to be outdone by the Jews, that Mount Gerizim was once more being set up against Jerusalem, and that a bold bid was being made by the hated Samaritans for a world-wide religion, which should embrace Pagans as well as Christians. But before such an amalgam of paganism and Christianity could be propounded, it is evident that Christianity must have been for some little time before the world, and that the system cannot possibly be traced back to Simon Magus. Is it not this early struggle between Jewish and Samaritan universalism, involving as it did a struggle of religion against magic, that is really symbolized under the wild traditions of the contest between Peter and Simon?¹

Tertullian is fond of alluding to Simon Magus. He says that he offered money for the Holy Spirit (*De fuga*, 12; *De anima*, 34), that he was cursed by the Apostles and expelled from the faith (*De idol.* 9), that he consoled himself for the loss of the Spirit by the purchase of Helen of Tyre (*De an.* 34), that he was honoured at Rome with a statue bearing the inscription "Sancti Dei" (*Apol.* 13), that the *Simonianae magiae disciplina* had been condemned by Peter (*De praescr.* 33), and that in his own day (he died in A.D. 220) the followers of Simon professed to raise the souls of prophets from the dead (*De anima*, 57). In a list of heretics Marcion, Valentine and Apelles are followed by Hebion and Simon, whom we may take as standing respectively for Jewish and Samaritan types of Christian heresy (*De praescr.* 10). But the important passage is the account of his doctrine in *De anima*, 34, which is evidently derived from the same source as that of Irenaeus. The pseudo-Tertullian in the short treatise *Against all Heresies* lets us know that the being whom the Most High God came down to seek was Wisdom. This is important as bearing upon the connexion between Simon and Valentinus. In the Clementine *Homilies* (ii. 25) it is said that Simon called Helen *σοφία*.

We now come to the important testimony of Hippolytus (c. A.D. 218-222). In his *Refutatio omnium haeresium* he gives the same account as Irenaeus with certain slight differences, which indicate a common source rather than direct borrowing.

The word used for the Thought of the first Father, which in Justin is *ἐννοια*, and which the translator of Irenaeus renders by *conceptio* and Tertullian by *injectio*, is in Hippolytus *ἐπινοια*. We are told that Simon allegorized the wooden horse and "Helen with the lamp,"² and applied them to himself and his *ἐπινοια*. Upon the story of "the lost sheep" Hippolytus comments as follows. "But the liar was enamoured of this wench, whose name was Helen, and had bought her and had her to wife, and it was out of respect for his disciples that he invented this fairy-tale" (*Ref. O. H.* vi. 19). To this he adds a scathing indictment against the licentiousness of the Simonians.³ Hippolytus speaks in language similar to that of Irenaeus about the variety of magic arts practised by the Simonians, and also of their having images of Simon and Helen under the forms of Zeus and Athena. But here he has a significant addition. "But if any one, on seeing the images either of Simon or Helen, shall call them by those names, he is cast out, as showing ignorance of the mysteries." From this it is evident that the Simonians did not allow that they worshipped their founders. Lipsius conjectured that the supposed worship of Simon and Helen was really that of Hercules-Melkart and Selene-Astarte. Baür before him made Simon = *σῶν*, the Sun. In the Clementine *Recognitions* Helen is called Luna (ii. 8, 9), and in the *Homilies* she is mystically connected with the lunar month (*Hom.* ii. 23).

Hippolytus, like the rest, identified Simon of Gitta (*Σίμων ὁ Γιττανός*, vi. 7) with Simon Magus. Reduced to despair, he says, by the curse laid upon him by Peter, he embarked on the career that has been described, "Until he came to Rome also and fell foul of the Apostles. Peter withstood him on many occasions. At last he came (here some words are missing) and began to teach sitting under a plane tree. When he was on the point of being shown up, he said, in order to gain time, that if he were buried alive he would rise again on the third day. So he bade that a tomb should be dug by his disciples and that he should be buried in it. Now they did what they were ordered, but he remained there until now: for he was not the Christ."

Prefixed to this account of Simon, which, except in its dramatic close, so nearly tallies with that of Irenaeus, is a description of a book of which he was the author. It is quoted under the title of *The Declaration* (vi. 14, 18) or *The Great Declaration* (vi. 11). The

¹ The account given by Irenaeus should be compared with what is said of Simon Magus in the Clementine *Homilies*, ii. 22, where the rivalry between Jews and Samaritans becomes evident (cf. *Recognitions*, i. 57).

² On this see *Eph.* xxi. 3.

³ Hippolytus says the free love doctrine was held by them in its frankest form.

longest extract from it is in vi. 18, but others occur here and there,⁴ and, where not explicitly quoted, it still underlies the statements of Hippolytus. It is written in a mystical and pretentious style, but the philosophy of it, if allowance be made for the allegorical method of the time, is by no means to be despised. As Hippolytus himself in more than one place (iv. 51, vi. 20) points out, it is an earlier form of the Valentinian doctrine, but there are things in it which remind us of the Stoic physics, and much use is made of the Aristotelian distinction between *ἐπέροια* and *διναμια*.

Starting from the assertion of Moses that God is "a devouring fire" (Deut. iv. 24), Simon combined therewith the philosophy of Heraclitus which made fire the first principle of all things. This first principle he denominated a "power without end" (*διναμια ἀπέραντος*), and he declared it to dwell in the sons of men, beings born of flesh and blood. But fire was not the simple thing that the many imagined, and Simon distinguished between its hidden and its manifest qualities, maintaining, like Locke, that the former were the cause of the latter. Like the Stoics he conceived of it as an intelligent being. From this ungenerated being sprang the generated world of which we know, whereof there were six roots, having each its inner and its outer side, and arranged in pairs (*συζυγίαι*) as follows: *νοῦς* and *ἐπινοια* = *οὐρανός* and *γῆ*; *φωγή* and *δυσμα* = *ἥλιος* and *σελήνη*; *λογισμός* and *ἐπιθυμησις* = *ἄηρ* and *ὕδωρ*. These six roots are also called six powers. Commingled with them all was the great power, the "power without end." This was that "which stands, which stood and yet shall stand." It existed potentially in every child of man, and might be developed in each to its own immensity. The small might become great, the point be enlarged to infinity (iv. 51, v. 9, vi. 14). This indivisible point which existed in the body, and of which none but the spiritual knew, was the Kingdom of Heaven, and the grain of mustard-seed (v. 9). But it rested with us to develop it, and it is this responsibility which is referred to in the words—"that we may not be condemned with the world" (1 Cor. xi. 32). For if the image of the Standing One were not actualized in us, it would not survive the death of the body. "The axe," he said, "is nigh to the roots of the tree. Every tree that bringeth not forth good fruit is cut down and cast into the fire" (cf. Matt. iii. 10).

The whole book is a queer mixture of Hellenism and Hebraism, in which the same method of allegory is applied to Homer and Hesiod as to Moses. There is a physiological interpretation of the Garden of Eden. The five books of Moses are made to represent the five senses. There is a mystical passage on the unity of all things, suggestive of "the hymn the Brahman sings." Its language seems to throw light on the story about Helen. "This," he says, "is one power, divided between above and below, self-generating, self-increasing, *self-seeking*, *self-finding*, being its own mother, its own father, its own sister, its own spouse, its own daughter, its own son, mother, father, an abstract unity, being the root of all things" (*Hipp. Ref. O. H.* vi. 17). That a learned man like Hippolytus should refer a work which contains quotations from the Epistles and Gospels to Simon Magus, who was probably older than Jesus Christ, shows the extent to which men can be blinded by religious bigotry.

Next in order comes Origen, who was ordained priest in A.D. 231 (*Eus. H. E.* vi. 23, 26). The most interesting point in his evidence relates to the decline of the Samaritan attempt to establish a world religion. After speaking of Dositheus the Samaritan, who persuaded some of his countrymen that he was the Christ prophesied by Moses, he goes on to say: "Also Simon the Samaritan, a magician, wished to filch away some by his magic. And at the time indeed he succeeded in his deception, but now I suppose it is not possible to find 30 Simonians altogether in the world; and perhaps I have put the number higher than it really is. But in Palestine there are very few, and in the rest of the world, in which he wished to spread his own glory, his name is nowhere mentioned. If it is, this is due to the Acts of the Apostles. It is the Christians who say what is said about him, and it has become plain as daylight (*ἡ ἐνάργεια ἐμαρτύρησεν*) that Simon was nothing divine" (Origen, *Cont. Cels.* i. 57). Origen also mentions that some of the sect were called Heleniani (v. 62).

The treatise of the pseudo-Cyprian *De Rebaptismate* is assigned by some to about A.D. 260. The writer says that on the strength of the words of John, that "we were to be baptized with the Holy Ghost and with fire," the Simonians maintained *Pseudo-Cyprian* that the orthodox baptism was a mere form, and that they had the real baptism, for, as soon as their neophytes went down into the water, a fire appeared on it. The writer does not dispute the fact, but is at a loss what to make of it. Was it a bit of jugglery, or a natural phenomenon, or a piece of self-deception, or an effect of magic? In advocacy of this baptism, we are told, there was composed by the same heretics a book which was inscribed *Preaching of Paul*.

Arnobius (early in the 3rd century) introduces us to a new phase of the Simon-legend. "They had seen," he says, "the car of Simon Magus blown away by the mouth of Peter and vanish at the name of Christ. They had seen, I say, him who *Arnobius* trusted in false gods and was betrayed by those gods in their fear, brought headlong down by his own weight, lie with broken legs, and afterwards be carried to Brunda and, exhausted by suffering and

⁴ E.g. iv. 51, v. 9, vi. 11, 14, 17.

shame, fling himself down once more from the gable of a lofty roof." The immediate sequel shows that belief in this story was confined to Christians.

Eusebius (about A.D. 264-340) follows Justin Martyr and Irenaeus, but he adds the statement, which is not derived from them, that

Eusebius. Peter opposed Simon at Rome under the reign of Claudius. From Origen's statement one might have thought that the Simonians would have dwindled out altogether by the time of Eusebius. But they were still extant in his time, and there is no sect of whom he speaks in such unmeasured terms of vituperation.¹ Eusebius's account of Menander (iii. 26) is also based upon Justin and Irenaeus.

St Cyril of Jerusalem (A.D. 346) in the sixth of his *Catechetical Lectures* prefaces his history of the Manichees by a brief account of earlier heresies. Simon Magus, he says, was the father

Cyrril. of all heresy. After being cast out by the Apostles he came to Rome where, having joined to himself a profligate woman of the name of Helen, he gave out that it was he who appeared as the father on Mt. Sinai, and afterwards, not in the flesh, but in appearance (*δοκῆσαι*) as Jesus Christ, and, finally, as the Holy Ghost, according to the promise of Christ. His success at Rome was so great that the emperor Claudius erected a statue to him with the inscription *Simoni Deo Sancto*. The triumph of Simon Magus was terminated on the arrival of Peter and Paul at Rome. Simon Magus had given out that he was going to be translated to heaven, and was actually careering through the air in a chariot drawn by demons when Peter and Paul knelt down and prayed, and their prayers brought him to earth a mangled corpse.

Such is the form assumed by the legend of Simon Magus about the middle of the 4th century. It is interesting to note in it the first introduction of Paul on the scene, at least by name. The reader who is not familiar with the eccentricities of the Tübingen school will doubtless be surprised to learn that the Paul who thus quietly slips in at the close of the drama was himself all along the disguised villain of the plot, the very Simon Magus whom he comes to assist Peter in destroying (see below).

Epiphanius (c. A.D. 367) is a writer who has nothing but his learning to recommend him. It seems that there were some Simonians

Epi-phanus. still in existence in his day, but he speaks of them as almost extinct. Gitta, he says, had sunk from a town into a village. He makes no mention of the *Great Declaration*, but as in several places he makes Simon speak in the first person, the inference is that he is quoting from it, though perhaps not verbatim. Take, for instance, the following passage: "But in each heaven I changed my form," says he, "in accordance with the form of those who were in each heaven, that I might escape the notice of my angelic powers and come down to the Thought, who is none other than her who is also called Pronikos and Holy Ghost, through whom I created the angels, while the angels created the world and men" (56 C, D). And again, "And on her account," he says, "did I come down; for this is that which is written in the Gospel 'the lost sheep'" (58 A). Epiphanius further charges Simon with having tried to wrest the words of St Paul about the armour of God (Eph. vi. 14-16) into agreement with his own identification of the "ennoia" with Athena. He tells us also that he gave barbaric names to the "principalities and powers," and that he was the beginning of the Gnostics. The Law, according to him, was not of God, but of "the sinister power."²

The same was the case with the prophets, and it was death to believe in the Old Testament. Epiphanius clearly has before him the same written source as Hippolytus, which we know to have been the *Great Declaration*. The story of Helen is thus definitely shown to belong to the second Simon, and not at all to the first. Dr Salmon pointed out that Simon was known as a writer to the author of the *Clementine Recognitions* (ii. 38), and towards the close of the 4th century we find St Jerome quoting from him as such.³

Two points must by this time have become clear: (1) that our knowledge of the original Simon Magus is confined to what

The Tübingen theory. we are told in the Acts, and (2) that from the earliest times he has been confused with another Simon. The initial error of Justin was echoed by every subsequent writer, with the one exception of Hegesippus, who had perhaps not read him. There were, of course, obvious reasons for the confusion. Both Simons were Samaritans, both were magicians, and the second Simon claimed for himself what was claimed for the earlier Simon by the people, namely, that he was the great power of God. But, if the end in view with the Fathers had been the attainment of truth, instead of the branding of heretics, they could not possibly have accepted the *Great Declaration*, which contains, as we have seen, the story of Helen, with its references to the Gospels, as the work of Simon

¹ See *H.E.* ii. 1, 13, 14, iii. 26, iv. 11, 22.

² 58 D, xxi. 4, τῆς ἀριστερᾶς δυνάμεως.

³ Comm. on Matt. xxiv. 5—Ego sum sermo Dei, ego sum speciosus, ego paracletus, ego omnipotens, ego omnia Dei.

Magus. As regards the third point, the difficulty is to make clear to the ordinary mind why it should be treated at all. But as Schmiedel champions the Tübingen view in the *Encyclopaedia Biblica*, it cannot be overlooked.

Among the sources of the Simon-legend we have omitted the pseudo-Clementine literature and a number of Apocryphal *Martyria*, *Passiones* and *Actus*. It is necessary to treat them separately in connexion with the Tübingen view, which represents Paul as the original Simon. That view is based on these works of fiction, of uncertain date and authorship, which seem to have been worked over by several hands in the interest of diverse forms of belief. The romance of Clement of Rome exists at present in two forms, in Greek under the name of the *Clementine Homilies* and in a Latin translation by Rufinus, which is known as the *Recognitions* (see CLEMENTINE LITERATURE). It is contended that the common source of these documents may be as early as the 1st century, and must have consisted in a polemic against Paul, emanating from the Jewish side of Christianity. Paul being thus identified with Simon, it was argued that Simon's visit to Rome had no other basis than Paul's presence there, and, further, that the tradition of Peter's residence in Rome rests on the assumed necessity of his resisting the arch-enemy of Judaism there as elsewhere. Thus the idea of Peter at Rome really originated with the Ebionites, but it was afterwards taken up by the Catholic Church, and then Paul was associated with Peter in opposition to Simon, who had originally been himself.

Now it must be conceded at once that the *Clementine Homilies* are marked by hostility to Paul. Prefixed to them is a supposed letter from Peter to James, in which Peter is made to write as follows:—

"For some of the converts from the Gentiles have rejected the preaching through me in accordance with the law, having accepted a certain lawless and babbling doctrine of the enemy (τοῦ ἐχθροῦ ἀθρώπου). And this some people have attempted while I am still alive, by various interpretations to transform my words, unto the overthrow of the law; as though I also thought thus, but did not preach it openly: which be far from me! For to do so is to act against the law of God as spoken through Moses, the eternal duration of which is borne witness to by our Lord. Since He said thus—'Heaven and earth shall pass away: one jot or one tittle shall not pass away from the law' (cf. Matt. v. 18). Now this He said that all might be fulfilled. But they, professing somehow to know my mind, attempt to expound the words they heard from me more wisely than I who spoke them, telling those who are instructed by them that this is my meaning, which I never thought of. But if they venture on such falsehoods while I am still alive, how much more when I am gone will those who come after me dare to do so!"

It would be futile to maintain that that passage is not aimed at Paul. It does not identify Paul with Simon Magus, but it serves to reveal an animus which would render the identification easy. In the 17th Homily the identification is effected. Simon is there made to maintain that he has a better knowledge of the mind of Jesus than the disciples, who had seen and conversed with Him in person. His reason for this strange assertion is that visions are superior to waking reality, as divine is superior to human (xvii. 5, 14). Peter has much to say in reply to this, but the passage which mainly concerns us is as follows:—

"But can any one be educated for teaching by vision? And if you shall say, 'It is possible,' why did the Teacher remain and converse with waking men for a whole year? And how can we believe you even as to the fact that he appeared to you? And how can he have appeared to you seeing that your sentiments are opposed to his teaching? But if you were seen and taught by him for a single hour, and so became an apostle, then preach his words, expound his meaning, love his apostles, fight not with me who had converse with him. For it is against a solid rock, the foundation-stone of the Church, that you have opposed yourself in opposing me. If you were not an adversary, you would not be slandering me and reviling the preaching that is given through me, in order that, as I heard myself in person from the Lord, when I speak I may not be believed, as though forsooth it were I who was condemned and I who was reprobate.⁴ Or, if you call me 'condemned' (κατεγνωσμένον, Gal. ii. 11), you are accusing God who revealed the Christ to me, and are inveighing against Him who called me blessed on the ground of the revelation. But if indeed you truly wish to work along with

⁴ Reading with Schmiedel ἀδοκίμων ὄντος (from 1 Cor. ix. 27) in place of ἐδόκιμοῦντος.

the truth, learn first from us what we learnt from Him, and when you have become a disciple of truth, become our fellow-workman."

Here we have the advantage, rare in ecclesiastical history, of hearing the other side. The above is unmistakably the voice of those early Christians who hated Paul, or at all events an echo of that voice. But how late an echo it would be hazardous to decide. Schmiedel asks, "How should Paul ever come to be in the 2nd, or, as far as the pseudo-Clementine *Homilies* and *Recognitions* are concerned, even in the 3rd or 4th century, the object of so fanatical a hatred? It is a psychological impossibility." Yet the love and hatred aroused by strong characters is not confined to their life-time. There is not the slightest reason why there should not have been people in the 3rd or 4th century who would have been glad to lampoon Paul. The introduction of Pauline features, however, into the representation of Simon Magus is merely incidental. The portrait as a whole is not in the least like Paul, and could not even have been intended for a caricature of him.

There are other features in the portrait which remind us strongly of Marcion. For the first thing which we learn from the *Homilies* about Simon's opinions is that he denied that God was just (ii. 14). By "God" he meant the Creator. But he undertakes to prove from Scripture that there is a higher God, who really possesses the perfections which are falsely ascribed to the lower (iii. 10, 38). On these grounds Peter complains that, when he was setting out for the Gentiles to convert them from their worship of many gods upon earth, the Evil Power (*ἡ κακία*) had sent Simon before him to make them believe that there were many gods in heaven. Peter throughout is represented as defending the *μοναρχία* of God against Simon's attacks on it (e.g. iii. 3, 9, 59).

If we knew more, we might detect other historical characters concealed under the mask of Simon. Just as whatever Plato approves is put into the mouth of Socrates, so whatever the author of the *Homilies* condemns is put into the mouth of Simon Magus. But while thus seeking for hidden meanings, are we not in danger of missing what lies on the surface, namely, that the Simon Magus of the Clementine romance is a portrait of Simon of Gitta, after he had been confused with the Simon of Acts? The mention of Helen in the *Clementines* stamps them as later than the *Great Declaration*, in which, to all appearance, her story originates. Indeed, the Clementine romance may most fitly be regarded as an answer to the *Great Declaration*, the answer of Jewish Gnosticism to the more Hellenized Gnosticism of Samaria. Let us look at the *Homilies* in this light, and see how far what they have to tell us about Simon accords with conclusions which we have already reached.

Simon, we are informed, was a Samaritan, and a native of Gitta, a village situated at a distance of 6 *σχοίνοι* (about 4 m.) from the city. The name of his father was Antonius, that of his mother Rachel. He studied Greek literature in Alexandria, and, having in addition to this great power in magic, was so puffed up by his attainments that he wished to be considered a highest power, higher even than the God who created the world.¹ And sometimes he "darkly hinted" that he himself was Christ, calling himself the Standing One. Which name he used to indicate that he would stand for ever, and had no cause in him for bodily decay. He did not believe that the God who created the world was the highest, nor that the dead would rise. He denied Jerusalem, and introduced Mount Gerizim in its stead. In place of the real Christ of the Christians he proclaimed himself; and the Law he allegorized in accordance with his own preconceptions. He did indeed preach righteousness and judgment to come: but this was merely a bait for the unwary.

So far we have had nothing that is inconsistent with Simon of Gitta, and little but what we are already familiar with in connexion either with him or his disciple Menander. But in what follows the identification of this Simon with the Simon of Acts has led the novelist to give play to his fancy. It may be well to premise that in the view of the writer of the *Homilies*, "All things are double one against another." "As first night, then day, and first ignorance, then knowledge (*γνώσις*), and first sickness, then healing, so the things of error come first in life, and then the truth supervenes upon them, as the physician upon the sickness." (*Hom.* ii. 33). In this way every good thing has its evil forerunner.

According to the *Homilies*, the manner of his entering on his career of impiety was as follows. There was one John, a Hemero-

¹ Supplying, with Schmiedel, *ἀνθρώπα*.

baptist, who was the forerunner of our Lord Jesus in accordance with the law of parity;² and as the Lord had twelve Apostles, bearing the number of the twelve solar months, so had he thirty leading men, making up the monthly tale of the moon. One of these thirty leading men was a woman called Helen. Now, as a woman is only half a man, in this way the number thirty was left incomplete, as it is in the moon's course. Of these thirty disciples of John the first and most renowned was Simon. But on the death of the master he was away in Egypt for the practice of magic, and one Dositheus, by spreading a false report of Simon's death, succeeded in installing himself as head of the sect. Simon on coming back thought it better to dissemble, and, pretending friendship for Dositheus, accepted the second place. Soon, however, he began to hint to the thirty that Dositheus was not as well acquainted as he might be with the doctrines of the school. Dositheus was so enraged at these suggestions, which were calculated to undermine his position as the Standing One, that he struck at Simon with his staff. But the staff went clean through the body of Simon as though it had been vapour. Whereat Dositheus was so amazed that he said to him, "Art thou the Standing One? And am I to worship thee?" When Simon said, "I am," Dositheus, knowing that he himself was not, fell down and worshipped him. Then he retired into the number of the twenty-nine leaders, and not long afterwards died.

The above is doubtless pure fiction. But Dositheus the Samaritan is a real person. He is mentioned by Hegesippus as the founder of a sect (*Eus. H.E.* iv. 22), and spoken of by the pseudo-Tertullian as a heretic from Judaism, not from Christianity, "who first dared to reject the prophets as not having spoken in the Holy Ghost." After this we return to the comparatively solid ground of Simon of Gitta. For the narrative goes on to say that Simon took Helen about with him, saying that she had come down into the world from the highest heavens, and was mistress, inasmuch as she was the all-mother being and wisdom. It was for her sake, he said, that the Greeks and Barbarians fought, deluding themselves with an image of truth, for the real being was then present with the First God.³ By such specious allegories and Grecian fables Simon deceived many, while at the same time he astounded them by his magic. A description is given of how he made a familiar spirit for himself by conjuring the soul out of a boy and keeping his image in his bedroom, and many instances of his feats of magic are given.

The Samaritans were evidently strong in magic. In all the accounts given us of Simon of Gitta magic is a marked feature, as also in the case of his pupil Menander. We cannot, therefore, agree with Dr Salmon's remark that the only reason why Justin attributed magic to Simon of Gitta was because of his identifying him with Simon Magus. Rather Simon Magus and his sorceries would have been forgotten had not his reputation been reinforced in the popular mind by that of his successor.

Whether Simon of Gitta ever exhibited his skill in Rome we have no means of determining, but at all events the compound Simon, resulting from the fusion of him with his predecessor, is brought to Rome by popular legend, and represented as enjoying great influence with Nero. One of his feats at Rome is to have himself beheaded and to rise again on the third day. It was really a ram that was beheaded, but he contrived by his magic to make people think that it was himself. The *Clementines* leave room for this development. In the Epistle of Clement to James prefixed to the *Homilies* Peter is spoken of as the light of the West, and as having met with a violent death in Rome; and in *Homilies* i. 16, Peter invites Clement to share his travels and listen to the words of truth which he is about to preach from town to town, "even unto Rome itself."

It would be superfluous to criticize the Tübingen view under a form in which it has already been abandoned. We may, therefore, confine our attention to the latest exposition of it by Schmiedel in the *Ency. Biblica*. In the narrative of Acts Schmiedel finds much to surprise him. He thinks, for instance, that verse 10 of chapter viii. must be interpolated, and that in the process *προσείχον* was borrowed from verse 11. But there is no inconsistency between the two verses. Verse 10 merely states that the people gave heed to the magician, verse 11 adds why. All the complicated speculations about a redactor which follow are swept away by the simple assumption that the text is sound.

With Schmiedel's contention that there are passages in the *Clementines* which are aimed at Paul, we entirely agree. But this interesting discovery so dazzled the eyes of Baur and his followers that after it they saw Paul everywhere. In the *Clementines* Simon by his magic imposes his own personal appearance upon Faustus, the father of Clement. This he does for his own ends, but Peter seeing his opportunity adroitly makes Faustus go to Antioch, and in the person of Simon make a public

² *κατὰ τὸν τῆς συζυγίας λόγον*, ii. 23.

³ As to the phantasmal nature of Helen see Plat. *Rep.* 586 c; Sext. Emp. *Adv. math.* vii. 180; cf. Hd. ii. 112-117. We have only the evidence of this passage for Simon having adopted the notion.

recantation of his aspersions on Peter, giving as a reason that he had been soundly scourged by angels during the preceding night. Now here, we are told, there is a malicious allusion to the "messenger of Satan to buffet me" of 2 Cor. xii. 6. We do not think that this conjecture will commend itself to the unprejudiced, especially in view of the fact that scourging by angels is a well-known piece of supernatural machinery (cf. 2 Macc. iii. 26; Eus. *H.E.* v. 28, § 12; Tert. *De idol.* 15). Yet Schmiedel speaks of this as "a well ascertained case in which an utterance of Paul regarding himself is spitefully twisted to his discredit." There is more plausibility in connecting Simon's assumed knowledge of things above the heavens (*Recog.* ii. 65) with St Paul's claim to have been "caught up even to the third heaven" (2 Cor. xii. 2). But the passage is much more appropriate to Simon of Gitta. From the height in which he claimed to dwell even the third heaven would have seemed quite the lower regions. The question of meat offered to idols was a burning one, in every sense of the term, long after Paul's day. We need not, therefore, see a reference to the Apostle's laxity on this crucial point in the story (*Hom.* iv. 4, vii. 3) that Simon Magus had entertained the people of Antioch on a sacrificial ox, and so subjected them to the evil influence of demons. The non-necessity of martyrdom is mentioned as a feature of early Gnosticism.¹

The miracles which St Paul claims for himself in 2 Cor. xii. 12, Rom. xv. 19, must doubtless have led to his being regarded as a magician by those who did not accept him as divinely commissioned; but, as we have seen throughout, magic was the salient feature about the Samaritan Messiah, who is the real enemy aimed at in the Clementine literature. The opening of doors of their own accord no more connects Simon Magus with Paul than with Peter. We need not, therefore, see in *Recog.* ii. 9 a reference to Acts xvi. 26. As to the use of bad language, people in the 2nd century were glad to avail themselves of such missiles as *ψευδαπόστολοι*, which had been manufactured for them in the 1st (*Hom.* xvi. 21; 2 Cor. xi. 13). That the *homo quidam inimicus* of the *Recognitions* (i. 70) is intended for Paul is plain, but then, as Schmiedel points out in a note, he is not identified with Simon. "Even the style of Paul," Schmiedel assures us, "is plainly imitated in a mocking way." The reference is to the recantation in *Hom.* xx. 19, which is like the rest of the treatise and quite unlike Paul, but Schmiedel's familiarity with Paul's writings enables him to collect phrases therefrom which occur also in the *Homilies*.

When the Tübingen School turn their attention to the Apocryphal Acts and Martyrdoms, the image of Paul still obsesses their mental gaze. There is indeed one passage which may plausibly be adduced in favour of their contention. In the *Martyrdom of the Holy Apostles Peter and Paul* (ch. 45), Paul is made to put this question—"If then circumcision is a good thing, why did you, Simon, deliver up circumcised men and compel them to be condemned and put to death?" We must let the Tübingen School have this passage for what it is worth, only remarking that it was not on the ground of circumcision that Paul persecuted the Church, and that it is impossible to extract history out of these fictions. We certainly cannot subscribe to the conjecture of Lipsius that "the story of the seeming beheading of Simon has at its root malicious misrepresentations of the beheading of Paul." The climax of absurdity seems to be reached when we are informed that the story of Simon offering money to the Apostles for the gift of the Holy Ghost arose out of Jewish-Christian scandal about Paul's "collection for the Saints" (1 Cor. xvi. 1). Yet Schmiedel follows Lipsius "in his latest treatment of the subject" in recognizing "a Samaritan γόης named Simon as historical." But the part which he played in history is thus taken away from him. He was there, it seems, but he did not do what he is said to have done. Only the author of Acts, wishing to obviate the reproach against Paul of offering money to the Apostles, attributed the like conduct to Simon.

¹ Pseudo-Tertullian says of Basilides, "Martyria negat esse facienda."

In conclusion, there are of course some grounds for the Tübingen view, but they are wholly inadequate to bear the structure that has been raised upon them. St Paul was a hard hitter, and Jewish Christians, who still clung to James and Peter as the only true pillars of the Church, are not likely to have cherished any love for his memory. This is enough to account for the hostility displayed against St Paul in the Clementines. But to push the equation of St Paul with Simon Magus further than we are forced to by the facts of the case is to lose sight of the real character of the Clementines as the counterblast of Jewish to Samaritan Gnosticism and to obscure the greatness of Simon of Gitta, who was really the father of all heresy, a character which has been erroneously attributed to Simon Magus.

LITERATURE.—Harnack, *Lehr. d. Dogmengesch.*, 2nd ed., 204-209, 264-270; Salmon in *Dict. Chr. Biog.* iv. 681; Hort, *Notes Introductory to the Study of the Clem. Recog.* (1902); Bigg in *Stud. Bib.* (1890), 2, 157-193; Headlam in *Hastings' Dict. of the Bible*; P. W. Schmiedel in *Encyc. Bibl.* (St. G. S.)

SIMON, RICHARD (1638-1712), French biblical critic, was born at Dieppe on the 13th of May 1638. His early studies were carried on at the college of the Fathers of the Oratory in that city. He was soon, by the kindness of a friend, enabled to enter upon the study of theology at Paris, where he early displayed a taste for Hebrew and other Oriental languages. At the end of his theological course he was sent, according to custom, to teach philosophy at Juilly, where there was one of the colleges of the Oratory. But he was soon recalled to Paris, and employed in the congenial labour of preparing a catalogue of the Oriental books in the library of the Oratory. His first publication was his *Fides Ecclesiae orientalis, seu Gabrielis Metropolitae Philadelphiensis opuscula, cum interpretatione Latina, cum notis* (Paris, 1671), the object of which was to demonstrate that the belief of the Greek Church regarding the Eucharist was the same as that of the Church of Rome. Simon entered the priesthood in 1670, and the same year wrote a pamphlet in defence of the Jews of Metz, who had been accused of having murdered a Christian child. It was shortly before this time that there were sown the seeds of that enmity with the Port Royalists which filled Simon's after life with many bitter troubles. Antoine Arnauld (1612-1694) had written a work on the *Perpetuity of the Faith*, the first volume of which treated of the Eucharist. The criticisms of Simon excited lasting indignation among Arnauld's friends and admirers. Another matter was the cause of inciting against him the ill-will of the monks of the Benedictine order. In support of a friend who was engaged in a lawsuit with the Benedictine monks of Fécamp, Simon composed a strongly-worded memorandum. The monks were greatly exasperated, and made loud complaints to the new general of the Oratory. The charge of Jesuitism was also brought against Simon, apparently on no other ground than that his friend's brother was an eminent member of that order. The commotion in ecclesiastical circles was great, and Simon's removal not only from Paris but from France was seriously considered. A mission to Rome was proposed to him, but he saw through the design, and, after a short delay dictated by prudential motives, declined the proposal. He was engaged at the time in superintending the printing of his *Histoire critique du Vieux Testament*. He had hoped, through the influence of Père la Chaise, the king's confessor, and the duc de Montausier, to be allowed to dedicate the work to Louis XIV., but, as the king was absent in Flanders at the time, the volume could not be published until he had accepted the dedication, though it had passed the censorship of the Sorbonne, and the chancellor of the Oratory had given his imprimatur. The printer of the book, in order to promote the sale, had caused the titles of the various chapters to be printed separately, and to be put in circulation. These, or possibly a copy of the work itself, had happened to come into the hands of the Port Royalists. It seems that, with a view to injure the sale of the work, which it was well known in the theological circles had been long in preparation by Simon, the Messieurs de Port Royal had undertaken a translation into French of the Prolegomena to *Walton's Polyglott*. To counteract this proceeding Simon announced his intention of publishing

an annotated edition of the Prolegomena, and actually added to the *Critical History* a translation of the last four chapters of that work, which had formed no part of his original plan. Simon's announcement prevented the appearance of the projected translation, but his enemies were all the more irritated. They had now obtained the opportunity which they had long been seeking. The freedom with which Simon expressed himself on various topics, and especially those chapters in which he declared that Moses could not be the author of much in the writings attributed to him, especially aroused their opposition. The powerful influence of Bossuet, at that time tutor to the dauphin, was invoked; the chancellor Michael le Tellier lent his assistance; a decree of the council of state was obtained, and after a series of paltry intrigues the whole impression, consisting of 1300 copies, was seized by the police and destroyed, and the animosity of his colleagues in the Oratory rose to so great a height against Simon that he was declared to be no longer a member of their body. Full of bitterness and disgust, Simon retired in 1679 to the curacy of Bolleville, to which he had been lately appointed by the vicar-general of the abbey of Fécamp.

The work thus confiscated in France it was proposed to republish in Holland. Simon, however, at first opposed this, in hopes of overcoming the opposition of Bossuet by making certain changes in the parts objected to. The negotiations with Bossuet lasted a considerable time, but finally failed, and the *Critical History* appeared, with Simon's name on the title page, in the year 1685, from the press of Reenier Leers in Rotterdam. An imperfect edition had previously been published at Amsterdam by Daniel Elzevir, based upon a MS. transcription of one of the copies of the original work which had escaped destruction and had been sent to England, and from which a Latin and an English translation were afterwards made. The edition of Leers was a reproduction of the work as first printed, with a new preface, notes, and those other writings which had appeared for and against the work up to that date.

The work consists of three books. The first deals with questions of Biblical criticism, properly so called, such as the text of the Hebrew Bible and the changes which it has undergone down to the present day, the authorship of the Mosaic writings and of other books of the Bible, with an exposition of Simon's peculiar theory of the existence during the whole extent of Jewish history of recorders or annalists of the events of each period, whose writings were preserved in the public archives, and the institution of which he assigns to Moses. The second book gives an account of the principal translations, ancient and modern, of the Old Testament, and the third contains an examination of the principal commentators. He had, with the exception of the theory above mentioned, contributed nothing really new on the subject of Old Testament criticism, for previous critics as L. Cappel, Johannes Morinus (1591-1659) and others had established many points of importance, and the value of Simon's work consisted chiefly in bringing together and presenting at one view the results of Old Testament criticism. The work encountered strong opposition, and that not only from the Church of Rome. The Protestants felt their stronghold—an infallible Bible—assailed by the doubts which Simon raised against the integrity of the Hebrew text. J. le Clerc ("Clericus") in his work *Sentimens de quelques théologiens de Hollande*, controverted the views of Simon, and was answered by the latter in a tone of considerable asperity in his *Réponse aux Sentimens de quelques théologiens de Hollande*, over the signature "Pierre Ambrun," it being a marked peculiarity of Simon rarely to give his own name.

The remaining works of Simon may be briefly noticed. In 1689 appeared his *Histoire critique du texte du Nouveau Testament*, consisting of thirty-three chapters, in which he discusses the origin and character of the various books, with a consideration of the objections brought against them by the Jews and others, the quotations from the Old Testament in the New, the inspiration of the New Testament (with a refutation of the opinions of Spinoza), the Greek dialect in which they are written (against C. Salmasius), the Greek MSS. known at the time, especially Codex D (Cantabrigiensis), &c. This was followed in 1690 by his *Histoire critique des versions du Nouveau Testament*, where he gives an account of the various translations, both ancient and modern, and discusses the manner in which many difficult passages of the New Testament have been rendered in the various versions. In 1693 was published what in some respects is the most valuable of all his writings, viz. *Histoire critique des principaux commentateurs du Nouveau Testament depuis le commencement du Christianisme jusques à notre temps*. This work exhibits immense reading, and the information it contains

is still valuable to the student. The last work of Simon that we need mention is his *Nouvelles Observations sur le texte et les versions du Nouveau Testament* (Paris, 1695), which contains supplementary observations upon the subjects of the text and translations of the New Testament.

As a controversialist Simon displayed a bitterness which tended only to aggravate the unpleasantness of controversy. He was entirely a man of intellect, free from all tendency to sentimentality, and with a strong vein of sarcasm and satire in his disposition. He died at Dieppe on the 11th of April 1712 at the age of seventy-four.

The principal authorities for the life of Simon are the life or "éloge" by his grand-nephew De la Martinière in vol. i. of the *Lettres choisies* (4 vols., Amsterdam, 1730); K. H. Graf's article in the first vol. of the *Beitr. zu d. theol. Wissensch.*, &c. (Jena, 1851); E. W. E. Reuss's article, revised by E. Nestle, in *Herzog-Hauck, Realencyklopädie* (ed. 1906); *Richard Simon et son Vieux Testament*, by A. Bernus (Lausanne, 1869); H. Margival, *Essai sur Richard Simon et la critique biblique au XVII^e siècle* (1900). For the bibliography, see, in addition to the various editions of Simon's works, the very complete and accurate account of A. Bernus, *Notice bibliographique sur Richard Simon* (Basel, 1882).

SIMON, THOMAS (c. 1623-1665), English medallist, was born, according to Vertue, in Yorkshire about 1623. He studied engraving under Nicholas Briot, and about 1635 received a post in connexion with the Mint. In 1645 he was appointed by the parliament joint chief engraver along with Edward Wade, and, having executed the great seal of the Commonwealth and dies for the coinage, he was promoted to be chief engraver to the mint and seals. He produced several fine portrait medals of Cromwell, one of which is copied from a miniature by Cooper. After the Restoration he was appointed engraver of the king's seals. On the occasion of his contest with the brothers Roettiers, who were employed by the mint in 1662, Simon produced his celebrated crown of Charles II., on the margin of which he engraved a petition to the king. This is usually considered his masterpiece. He is believed to have died of the plague in London in 1665.

A volume of *The Medals, Coins, Great Seals and other Works of Thomas Simon, engraved and described by George Vertue*, was published in 1753.

SIMON BEN YOĤAI (2nd century A.D.), a Galilean Rabbi, one of the most eminent disciples of Aqiba (*q.v.*). His master was executed by Hadrian, and Simon's anti-Roman sentiments led to his own condemnation by Varus c. 161 A.D. (according to Graetz). He escaped this doom and dwelt for some years in a cavern. Emerging from concealment, Simon settled in Tiberias and in other Galilean cities. He acquired a reputation as a worker of miracles, and on this ground was sent to Rome as an envoy, where (legend tells) he exorcised from the emperor's daughter a demon who had obligingly entered the lady to enable Simon to effect his miracle. This Rabbi bore a large part in the fixation of law, and his decisions are frequently quoted. To him were attributed the important legal homilies called *Sifre* and *Mekhillta* (see MIDRASH), and above all the *Zohar*, the Bible of the Kabbalah (*q.v.*). This latter ascription is altogether unfounded, the real author of this mystical commentary on the Pentateuch being Moses of Leon (*q.v.*).

The fullest account of Simon's teachings is to be found in W. Bacher's *Agada der Tannaiten*, ii. pp. 70-149. (I. A.)

SIMON OF ST QUENTIN (*fl.* 1247), Dominican mission-traveller and diplomatist. He accompanied, and wrote the history of, the Dominican embassy under Friar Ascelin or Anselm, which Pope Innocent IV. sent in 1247 to the Mongols of Armenia and Persia. Simon's history, in its original form, is lost; but large sections of it have been preserved in Vincent of Beauvais's *Speculum historiale*, where nineteen chapters are expressly said to be *ex libello fratris Simonis*, or entitled *frater Simon*. The embassy of Ascelin and Simon, who were accompanied by Andrew of Longjumeau, proceeded to the camp of Baiju or Bachu Noyan (*i.e.* "General" Baiju, Noyan signifying a commander of 10,000) at Sitiens in Armenia, lying between the Aras river and Lake Gokcha, fifty-nine days' journey from Acre. The papal letters were translated into Persian, and thence into Mongol, and so presented to Baiju; but the Tatars were greatly irritated by the haughtiness of the Dominicans,

who implied that the pope was superior even to the Great Khan, and offered no presents, refused the customary reverences before Baiju, declined to go on to the imperial court, and made unseasonable attempts to convert their hosts. The Frankish visitors were accordingly lodged and treated with contempt: for nine weeks (June and July 1247) all answer to their letters was refused. Thrice Baiju even ordered their death. At last, on the 25th of July 1247, they were dismissed with the *Noyan's* reply, dated the 20th of July. This reply complained of the high words of the Latin envoys, and commanded the pope to come in person and submit to the Master of all the Earth (the Mongol emperor). The mission thus ended in complete failure; but, except for Carpini's (*q.v.*), it was the earliest Catholic embassy which reached any Mongol court, and its information must have been valuable. It performed something at least of what should have been (but apparently was not) done by Lawrence (Lourenço) of Portugal, who was commissioned as papal envoy to the Mongols of the south-west at the same time that Carpini was accredited to those of the north (1245).

See Vincent of Beauvais, *Speculum historiale*, book xxxii. (sometimes quoted as xxxi.), chaps. 26-29, 32, 34, 40-52, (cf. pp. 453 A-454 B in the Venice edition of 1591); besides these, several other chapters of the *Spec. hist.* probably contain material derived from Simon, e.g. bk. xxxi. (otherwise xxx.), chaps. 3, 4, 7, 8, 13, 32; and bk. xxx. (otherwise xxix.), chaps. 69, 71, 74-75, 78, 80. See also d'Ohsson, *Histoire des Mongols*, ii. 200-201, 221-233; iii. 79 (edition of 1852); Fontana, *Monumenta Dominicana*, p. 52 (Rome, 1675); Luke Wadding, *Annales Minorum*, iii. 116-118; E. Bretschneider, *Mediaeval Researches from Eastern Asiatic Sources*, vol. i., notes 455, 494 (London, 1888); M. A. P. d'Avezac's Introduction to Carpini, pp. 404-405, 433-434, 464-465, of vol. iv. of the Paris Geog. Soc.'s *Recueil de Voyages*, &c. (Paris, 1839); W. W. Rockhill, *Rubruck*, pp. xxiv-xxv (London, Hakluyt Soc., 1900); C. R. Beazley, *Dawn of Modern Geography*, ii. 277, and *Carpini and Rubruquis*, 269-270. (C. R. B.)

SIMONIDES (OR SEMONIDES) OF AMORGOS, Greek iambic poet, flourished in the middle of the 7th century B.C. He was a native of Samos, and derived his surname from having founded a colony in the neighbouring island of Amorgos. According to Suidas, besides two books of iambics, he wrote elegies, one of them a poem on the early history of the Samians. The elegy included in the fragments (85) of Simonides of Ceos is more probably by Simonides of Amorgos. We possess about thirty fragments of his iambic poems, written in clear and vigorous Ionic, with much force and no little harmony of versification. With Simonides, as with Archilochus, the iambic is still the vehicle of bitter satire, interchanging with melancholy, but in Simonides the satire is rather general than individual. His "Pedigree of Women" may have been suggested by the beast fable, as we find it in Hesiod and Archilochus, and as it recurs a century later in Phocylides; it is clear at least that Simonides knew the works of the former. Simonides derives the dirty woman from a hog, the cunning from a fox, the fussy from a dog, the apathetic from earth, the capricious from sea-water, the stubborn from an ass, the incontinent from a weasel, the proud from a high-bred mare, the worst and ugliest from an ape, and the good woman from a bee. The remainder of the poem (96-118) is undoubtedly spurious. There is much beauty and feeling in Simonides's description of the good woman.

See Fragments in T. Bergk, *Poëtae lyrii Graeci*; separate editions by F. T. Welcker (1835), and especially by P. Malusa (1900), with exhaustive introduction, bibliography and commentary.

SIMONIDES OF CEOS (c. 556-469 B.C.), Greek lyric poet, was born at Iulis in the island of Ceos. During his youth he taught poetry and music in his native island, and composed pæans for the festivals of Apollo. Finding little scope for his abilities at home, he went to live at Athens, at the court of Hipparchus, the patron of literature. After the murder of Hipparchus (514), Simonides withdrew to Thessaly, where he enjoyed the protection and patronage of the Scopadae and Aleuadae (two celebrated Thessalian families). An interesting story is told of the termination of his relations with the Scopadae. On a certain occasion he was reproached by Scopas for having allotted too much space to the Dioscuri in an ode celebrating the victory of his patron in a chariot-race. Scopas refused to

pay all the fee and told Simonides to apply to the Dioscuri for the remainder. The incident took place at a banquet. Shortly afterwards, Simonides was told that two young men wished to speak to him; after he had left the banqueting room, the roof fell in and crushed Scopas and his guests (Cicero, *De oratore*, ii. 86). There seems no doubt that some disaster overtook the Scopadae, which resulted in the extinction of the family. After the battle of Marathon Simonides returned to Athens, but soon left for Sicily at the invitation of Hiero, at whose court he spent the rest of his life.

His reputation as a man of learning is shown by the tradition that he introduced the distinction between the long and short vowels (ε, η, ο, ω), afterwards adopted in the Ionic alphabet which came into general use during the archonship of Eucleides (403). He was also the inventor of a system of mnemonics (Quintilian xi. 2, 11). So unbounded was his popularity that he was a power even in the political world; we are told that he reconciled Thero and Hiero on the eve of a battle between their opposing armies. He was the intimate friend of Themistocles and Pausanias the Spartan, and his poems on the war of liberation against Persia no doubt gave a powerful impulse to the national patriotism. For his poems he could command almost any price: later writers, from Aristophanes onwards, accuse him of avarice, probably not without some reason. To Hiero's queen, who asked him whether it was better to be born rich or a genius, he replied "Rich, for genius is ever found at the gates of the rich." Again, when someone asked him to write a laudatory poem for which he offered profuse thanks, but no money, Simonides replied that he kept two coffers, one for thanks, the other for money; that, when he opened them, he found the former empty and useless, and the latter full.

Of his poetry we possess two or three short elegies (Fr. 85 seems from its style and versification to belong to Simonides of Amorgos, or at least not to be the work of our poet), several epigrams and about ninety fragments of lyric poetry. The epigrams written in the usual dialect of elegy, Ionic with an epic colouring, were intended partly for public and partly for private monuments. There is strength and sublimity in the former, with a simplicity that is almost statuesque, and a complete mastery over the rhythm and forms of elegiac expression. Those on the heroes of Marathon and Thermopylae are the most celebrated. In the private epigrams there is more warmth of colour and feeling, but few of them rest on any better authority than that of the Palatine anthology. One interesting and undoubtedly genuine epigram of this class is upon Archedice, the daughter of Hippias the Peisistratid, who, "albeit her father and husband and brother and children were all princes, was not lifted up in soul to pride." The lyric fragments vary much in character and length: one is from a poem on Artemisium, celebrating those who fell at Thermopylae, with which he gained the victory over Aeschylus; another is an ode in honour of Scopas (commented on in Plato, *Protagoras*, 339 b); the rest are from odes on victors in the games, hyporchemes, dirges, hymns to the gods and other varieties. The poem on Thermopylae is reverent and sublime, breathing an exalted patriotism and a lofty national pride; the others are full of tender pathos and deep feeling, combined with a genial worldliness. For Simonides requires no standard of lofty unswerving rectitude. "It is hard," he says (Fr. 5), "to become a truly good man, perfect as a square in hands and feet and mind, fashioned without blame. Whosoever is bad, and not too wicked, knowing justice, the benefactor of cities, is a sound man. I for one will find no fault with him, for the race of fools is infinite. . . . I praise and love all men who do no sin willingly; but with necessity even the gods do not contend." Virtue, he tells us elsewhere in language that recalls Hesiod, is set on a high and difficult hill (Fr. 58); let us seek after pleasure, for "all things come to one dread Charybdis, both great virtues and wealth" (Fr. 38). Yet Simonides is far from being a hedonist; his morality, no less than his art, is pervaded by that virtue for which Ceos was renowned—σφροσύνη or self-restraint. His most celebrated fragment is a dirge, in which Danaë, adrift with the infant Perseus on the sea in a dark and stormy night, takes comfort from the peaceful slumber of her babe. Simonides here illustrates his own saying that "poetry is vocal painting, as painting is silent poetry." Of the many English translations of this poem, one of the best is that by J. A. Symonds in *Studies on the Greek Poets*. Fragments in T. Bergk, *Poëtae lyrii Graeci*; standard edition by F. G. Schneidewin (1835) and of the *Danaë* alone by H. L. Ahrens (1853). Other authorities are given in the exhaustive treatise of E. Cesati, *Simonide di Ceo* (1882); see also W. Schröter, *De Simonidis Cei melici sermone* (1906).

SIMON'S TOWN, a town and station of the British navy in the Cape province, South Africa, in 34° 15' S., 18° 30' E., on the

shores of Simon's Bay, an inlet on the west side of False Bay. It is 22½ m. S. of Cape Town by rail and 17 m. N. of Cape Point (the Cape of Good Hope). Apart from the naval station the town (pop. 1904, 6642) is an educational and residential centre, enjoying an excellent climate with a mean minimum temperature of 57° and a mean maximum of 70° F. Owing to the influence of the Mozambique current the temperature of the water in the bay is 10° to 12° F. higher than that of Table Bay, hence Simon's Town and other places along the shores of False Bay are favourite bathing resorts. The naval establishment is the headquarters of the East India and Cape Squadron.

In 1900 the yard covered about 13 acres, exclusive of the victualling establishment and naval hospital, and was provided with a small camber, slipways for torpedo-boats and small vessels, together with various dockyard buildings, storehouses, coal stores, &c., but had no dry dock or deep-water wharf. Under the Naval Works Loan Act of 1899 £2,500,000 was provided for the construction of additional docks east of the original naval yard. These works were begun in 1900 and completed in 1910. They consist of a tidal basin 28 acres in extent, with a depth of 30 ft. at low-water spring tides, enclosed by a breakwater on the eastern and northern sides and a similar projecting arm or pier on the west. The entrance to the basin faces north-westerly, and is 300 ft. in width. South of the basin is a large reclaimed area forming the site of the new dockyard. Opening from the basin is a dry dock, 750 ft. in length on blocks, with an entrance 95 ft. wide and having 30 ft. over the sill at low-water spring tides. The foundation stone of the dry dock was laid in November 1906 by the earl of Selborne, after whom it is named, and the dock was opened in November 1910 by the duke of Connaught.

The Selborne dock can be subdivided by an intermediate caisson in such a manner as to form two docks, respectively 400 ft. and 320 ft. in length, or 470 ft. and 250 ft. in length on blocks, as may be required, or the full length of 750 ft. can be made available. The dockyard buildings include extensive shops for the chief engineer's and chief constructor's departments, the pumping-engine house, working sheds, &c., while ample space is reserved for additional docks and buildings. Berthing accommodation is provided in the basin alongside the wharf walls which surround it. The walls available for this purpose have a total length of 2585 ft. lineal, are constructed of interlocked concrete block work, with an available depth of water of 30 ft. at low water, and are furnished with powerful shear-legs and cranes for the use of vessels alongside. Extensive sheds for the storage of coal are provided. The whole of the dockyard area (35 acres), including the enclosing breakwater and pier, was formed by reclamation from the sea; and the total area of the new works, including the tidal basin, is 63 acres.

False Bay, which corresponds on the south to Table Bay on the north side of Table Mountain, is a spacious inlet which has an average depth of from 15 to 20 fathoms, and is completely sheltered on all sides except towards the south. Here a whole fleet of the largest vessels can ride at anchor. Defensive works protect the entrance to the bay.

Simon's Town dates from the close of the 17th century, the town and bay being named after Simon van der Stell, governor of the Cape in 1679-1699. It was at Simon's Town that the first British landing in Cape Colony was made by General Sir James Craig in 1795. About 1810 the bay was selected as the base for the South African squadron, Table Bay being abandoned for that purpose in consequence of its exposed position.

SIMONY, an offence, defined below, against the law of the church. The name is taken from Simon Magus (*q.v.*). In the canon law the word bears a more extended meaning than in English law. "Simony according to the canonists," says Ayliffe in his *Parergon*, "is defined to be a deliberate act or a premeditated will and desire of selling such things as are spiritual, or of anything annexed unto spirituals, by giving something of a temporal nature for the purchase thereof; or in other terms it is defined to be a commutation of a thing spiritual or annexed unto spirituals by giving something that is temporal." An example of the offence occurs as early as the 3rd century in the purchase of the bishopric of Carthage by a wealthy matron for her servant, if the note to Gibbon (vol. ii. p. 457) is to be believed. The offence was prohibited by many councils, both in the East and in the West, from the 4th century onwards. In the *Corpus juris canonici* the Decretum (pt. ii. cause i. quest. 3) and the Decretals (bk. v. tit. 3) deal with the subject. The offender, whether *simoniacus* (one who had bought his orders) or *simoniace promotus* (one who had bought his promotion),

was liable to deprivation of his benefice and deposition from orders if a secular priest,—to confinement in a stricter monastery if a regular. No distinction seems to have been drawn between the sale of an immediate and of a reversionary interest. The innocent *simoniace promotus* was, apart from dispensation, liable to the same penalties as though he were guilty. Certain matters were simoniacal by the canon law which would not be so regarded in English law, e.g. the sale of tithes, the taking of a fee for confession, absolution, marriage or burial, the concealment of one in mortal sin or the reconciliation of an impenitent for the sake of gain, and the doing homage for spiritualities. So grave was the crime of simony considered that even infamous persons could accuse of it. English provincial and legatine constitutions continually assailed simony. Thus one of the heads in Lyndewode (bk. v.) is, "Ne quis ecclesiam nomine dotalitatibus transferat vel pro praesentatione aliquid accipiat." In spite of all the provisions of the canon law it is well established that simony was deeply rooted in the medieval church. Dante places persons guilty of simony in the third bolgia of the eighth circle of the Inferno:—

"O Simon mago, O miseri seguaci,
Che le cose di Dio che di bontate
Deono esser spose, voi rapaci
Per oro e per argento adulterate."—*Inf.* xix. 1.

The popes themselves were notorious offenders. In the canto just cited Pope Nicholas III. is made by the poet the mouth-piece of the simoniacs. He is supposed to mistake the poet for Boniface VIII., whose simoniacal practices, as well as those of Clement V., are again alluded to in Par. xxx. 147. At a later period there was an open and continuous sale of spiritual offices by the Roman curia which contemporary writers attacked in the spirit of Dante. A pasquinade against Alexander VI. begins with the lines—

"Vendit Alexander claves, altaria, Christum.
Emerat ille prius; vendere jure potest."

Machiavelli calls luxury, simony and cruelty the three dear friends and handmaids of the same pope.¹ The colloquy of Erasmus *De sacerdotiis captandis* bears witness to the same state of things. And, best proof of all, numerous decisions as to what is or is not simony are to be found in the reported decisions of the Roman rota.² That part of the papal revenue which consisted of first-fruits (*primitiæ* or *annates*) and tenths (*decimæ*) must have been theoretically simoniacal in its origin. In England this revenue was annexed to the crown by Henry VIII. and restored to the church by Queen Anne (see **QUEEN ANNE'S BOUNTY**).

For the purposes of English law simony is defined by Blackstone as the corrupt presentation of any person to an ecclesiastical benefice for money, gift or reward. The offence is one of purely ecclesiastical cognizance, and not punishable by the criminal law. The penalty is forfeiture by the offender of any advantage from the simoniacal transaction, of his patronage by the patron, of his benefice by the presentee; and now by the Benefices Act 1892, a person guilty of simony is guilty of an offence for which he may be proceeded against under the Clergy Discipline Act 1892. An innocent clerk is under no disability, as he might be by the canon law. Simony may be committed in three ways—in promotion to orders, in presentation to a benefice, and in resignation of a benefice. The common law (with which the canon law is incorporated, as far as it is not contrary to the common or statute law or the prerogative of the crown) has been considerably modified by statute. Where no statute applies to the case, the doctrines of the canon law may still be of authority. Both Edward VI. and Elizabeth promulgated advertisements against simony. The Act of 31 Eliz. c. 6 was intended to reach the corrupt patron as well as the corrupt clerk, the ecclesiastical censures apart from the statute not extending to the case of a patron. The first part of the act deals with the penalties for election or resignation of officers of churches, colleges, schools, hospitals, halls and societies for reward. The second part of the act provides that if any person or persons, bodies politic and corporate, for any sum of money, reward, gift, profit or benefit, directly or indirectly, or for or by reason of any promise, agreement, grant, bond, covenant or other assurances, of or for any sum of money, &c., directly or indirectly present or collate any person to any benefice with cure of souls, dignity, prebend or living ecclesiastical, or give or bestow the same for or in respect of

¹ See Roscoe, *Life of Leo X.*, vol. i. p. 463.

² Compare the fine distinctions drawn by the casuists and attacked by Pascal in the twelfth of the *Provincial Letters*.

any such corrupt cause or consideration, every such presentation, collation, gift and bestowing, and every admission, institution, investiture and induction shall be void, frustrate and of none effect in law; and it shall be lawful for the queen to present, collate unto, or give and bestow every such benefice, dignity, prebend and living ecclesiastical for that one time or turn only; and all and every person or persons, bodies politic and corporate, that shall give or take any such sum of money, &c., directly or indirectly, or that shall take or make any such promise, &c., shall forfeit and lose the double value of one year's profit of every such benefice, &c., and the person so corruptly taking, procuring, seeking or accepting any such benefice, &c., shall be adjudged a disabled person in law to have or enjoy the same benefice, &c. Admission, institution, installation or induction of any person to a benefice, &c., for any sum of money, &c., renders the offender liable to the penalty already mentioned. But in this case the presentation reverts to the patron and not to the crown. The penalty for corrupt resigning or exchanging of a benefice with cure of souls is that the giver as well as the taker shall lose double the value of the sum so given or taken, half the sum to go to the crown and half to a common informer. The penalty for taking money, &c., to procure ordination or to give orders or licence to preach is a fine of £40; the party so corruptly ordained forfeits £10; acceptance of any benefice within seven years after such corrupt entering into the ministry makes such benefice merely void, and the patron may present as on a vacancy; the penalties are divided as in the last case. The act is cumulative only, and does not take away or restrain any punishment prescribed by ecclesiastical law. The Act of 1 Will. & M. sess. 1, c. 16, guards the rights of an innocent successor in certain cases. It enacts that after the death of a person simoniacally presented the offence or contract of simony shall not be alleged or pleaded to the prejudice of any other patron innocent of simony, or of his clerk by him presented, unless the person simoniac or simoniacally presented was convicted of such offence at common law or in some ecclesiastical court in the lifetime of the person simoniac or simoniacally presented. The act also declares the validity of leases made by a simoniac or simoniacally-presented person, if *bona fide* and for valuable consideration to a lessee ignorant of the simony. By the Simony Act 1713 if any person shall for money, reward, gift, profit or advantage, or for any promise, agreement, grant, bond, covenant, or other assurance for any money, &c., take, procure or accept the next avoidance of or presentation to any benefice, dignity, prebend or living ecclesiastical, and shall be presented or collated thereupon, such presentation or collation and every admission, institution, investiture and induction upon the same shall be utterly void; and such agreement shall be deemed a simoniacal contract, and the queen may present for that one turn only; and the person so corruptly taking, &c., shall be adjudged disabled to have and enjoy the same benefice, &c., and shall be subject to any punishment limited by ecclesiastical law. The Ecclesiastical Commissioners Act 1840, § 42, provides that no spiritual person may sell or assign any patronage or presentation belonging to him by virtue of any dignity or spiritual office held by him; such sale or assignment is null and void. This selection has been construed to take away the old archbishop's "option," *i.e.* the right to present to a benefice in a newly appointed bishop's patronage at the option of the archbishop. By canon 40 of the canons of 1603 an oath against simony was to be administered to every person admitted to any spiritual or ecclesiastical function, dignity or benefice. By the Clerical Subscription Act 1865 a declaration was substituted for the oath, and a new canon incorporating the alteration was ratified by the crown in 1866. By the canon law all resignation bonds were simoniacal, and in 1826 the House of Lords held that all resignation bonds, general or special, were illegal. Special bonds have since, however, been to a limited extent sanctioned by law. The Clerical Resignation Bonds Act 1828 makes a written promise to resign valid if made in favour of some particular nominee or one of two nominees, subject to the conditions that, where there are two nominees, each of them must be either by blood or marriage an uncle, son, grandson, brother, nephew or grand-nephew of the patron, that the writing be deposited with the registrar of the diocese open to public inspection, and that the resignation be followed by presentation within six months of the person for whose benefit the bond is made. The Benefices Act 1898 substitutes and makes obligatory on every person about to be instituted to a benefice a simpler and more stringent form of declaration against simony. The declaration is to the effect that the clergyman has not received the presentation in consideration of any sum of money, reward, gift, profit or benefit directly or indirectly given or promised by him or any one for him to any one; that he has not made any promise of resignation other than that allowed by the Clerical Resignation Bonds Act 1828; that he has not for any money or benefit procured the avoidance of the benefice; and that he has not been party to any agreement invalidated by sec. 3 sub-sec. 3 of the act which invalidates any agreement for the exercise of a right of patronage in favour or on the nomination of any particular person, and any agreement on the transfer of a right of patronage (a) for the retransfer of the right, or (b) for postponing payment of any part of the consideration for the transfer until a vacancy or for more than three months, or (c) for payment of interest until a vacancy or for more than three

months, or (d) for any payment in respect of the date at which a vacancy occurs, or (e) for the resignation of a benefice in favour of any person. Cases of simony have come before the courts in which clergy of the highest rank have been implicated. In 1695, in the case of *Lucy v. The Bishop of St David's*, the bishop was deprived for simony. The queen's bench refused a prohibition (1 Lord Raymond's Rep. 447). In 1841 the dean of York was deprived by the archbishop for simony, but in this case the queen's bench granted a prohibition on the ground of informality in the proceedings (*In Re the Dean of York*, 2 Q.B.R. 1). The general result of the law previous to the Benefices Act 1898, as gathered from the statutes and decisions, may be exhibited as follows: (1) it was not simony for a layman or spiritual person not purchasing for himself to purchase, while the church was full, as advowson or next presentation, however immediate the prospect of a vacancy; (2) it was not simony for a spiritual person to purchase for himself a life or any greater estate in an advowson, and to present himself thereto; (3) it was not simony to exchange benefices under an agreement that no payment was to be made for dilapidations on either side; (4) it was not simony to make certain assignments of patronage under the Church Building and New Parishes Acts (9 & 10 Vict. c. 88, 32 & 33 Vict. c. 94); (5) it was simony for any person to purchase the next presentation while the church was vacant; (6) it was simony for a spiritual person to purchase for himself the next presentation, though the church be full; (7) it was simony for any person to purchase the next presentation, or in the case of purchase of an advowson the next presentation by the purchaser would be simoniacal if there was any arrangement for causing a vacancy to be made; (8) it was simony for the purchaser of an advowson while the church was vacant to present on the next presentation; (9) it was simony to exchange otherwise than *simpliciter*; no compensation in money might be made to the person receiving the less valuable benefice. The law on the subject of simony was long regarded as unsatisfactory by the authorities of the church. In 1879 a royal commission reported on the law and existing practice as to the sale, exchange and resignation of benefices. Many endeavours were made in parliament to give effect to the recommendations of the commission, but it was not until 1898 that any important change was made in the law. The Benefices Act of that year absolutely invalidates any transfer of a right of patronage unless (a) it is registered in the diocesan registry, (b) unless more than twelve months have elapsed since the last institution or admission to the benefice, and (c) unless "it transfers the whole interest of the transferor in the right" with certain reservations; in other words, the act abolished the sale of next presentations, but it expressly reserved from its operation (a) a transmission on marriage, death or bankruptcy or otherwise by operation of law, or (b) a transfer on the appointment of a new trustee where no beneficial interest passes. It also substituted another form of declaration for that required under the Clerical Subscription Act 1865 (see above). It abolished the sale by auction of an advowson in gross, and empowered a bishop to refuse to institute or admit a presentee to a benefice on a number of specified grounds: among others, on the ground of possible corrupt presentation through a year not having elapsed since the last transfer of the right of patronage, and constituted a new court to hear appeals against a bishop's refusal to institute. This court consists of a judge of the Supreme Court, who shall decide all questions of law and of fact, and of the archbishop, who gives judgment.

In Scotland simony is an offence both by civil and ecclesiastical law. The rules are generally those of the canon law. There are few decisions of Scottish courts on the subject. By the Act of 1584, c. 5, ministers, readers and others guilty of simony provided to benefices were to be deprived. An Act of Assembly of 1753 declares pactions simoniacal whereby a minister or probationer before presentation and as a means of obtaining it bargains not to raise a process of augmentation of stipend or demand reparation or enlargement of his manse or glebe after induction.

SIMOOM, or **SAMUM**, the name usually given in Algeria, Syria and Arabia to dust and sand-laden desert winds of the sirocco type. See **SIROCCO** and **KHAMSIN**.

SIMPLICIUS, pope from 468 to 483. During his pontificate the Western Empire was overthrown, and Italy passed into the hands of the barbarian king Odoacer. In the East, the usurpation of Basiliscus (475-476), who supported the monophysites, gave rise to many ecclesiastical troubles, which were a source of grave anxiety to the pope. The emperor Zeno, who had procured the banishment of Basiliscus, endeavoured to compound with the monophysite party; and the bishop of Constantinople, who had previously fought on the pope's side for the council of Chalcedon, abandoned Simplicius and subscribed to the *henoticon*, the conciliatory document promulgated in 482 by the emperor. Simplicius died on the 2nd of March 483, but without settling the monophysite question.

SIMPLICIUS, a native of Cilicia, a disciple of Ammonius and of Damascus, was one of the last of the Neoplatonists. When,

in A.D. 529, the school of philosophy at Athens was disendowed and the teaching of philosophy forbidden, the scholars Damascius, Simplicius, Priscianus and four others resolved in 531 or 532 to seek the protection of Chosroes, king of Persia, but, though they received a hearty welcome, they found themselves unable to endure a continued residence amongst barbarians. Before two years had elapsed they returned to Greece, Chosroes, in his treaty of peace concluded with Justinian in 533, expressly stipulating that the seven philosophers should be allowed "to return to their own homes, and to live henceforward in the enjoyment of liberty of conscience" (Agathias ii. 30, 31). After his return from Persia Simplicius wrote commentaries upon Aristotle's *De coelo*, *Physica*, *De anima* and *Categoriae*, which, with a commentary upon the *Enchiridion* of Epictetus, have survived. Simplicius is not an original thinker, but his remarks are thoughtful and intelligent and his learning is prodigious. To the student of Greek philosophy his commentaries are invaluable, as they contain many fragments of the older philosophers as well as of his immediate predecessors. (See NEO-PLATONISM.)

See J. A. Fabricius, *Bibliotheca Graeca*, ix. 529 seq., who praises very highly Simplicius's commentary on the *Enchiridion*; Ch. A. Brandis's article in Smith's *Dict. of Greek and Roman Biography*; E. Zeller, *D. Phil. d. Gr.* III. ii. 851 seq., also Ch. A. Brandis, "Über d. griech. Ausleger d. Aristot. Organons," in *Abh. Berl. Akad.* (1833); C. G. Zumpt, "Über d. Bestand d. phil. Schulen in Athen," *ibid.* (1842); Chaiguet, *Histoire de la psychologie des Grecs*, v. 357; Zahlfleisch, *Die Polemik des S.*

SIMPLON PASS, a pass over the Alps. Not known early save as a purely local route, the Simplon Pass rose into importance when Napoleon caused the carriage road to be built across it between 1800 and 1807, though it suffered a new eclipse on the opening of the Mont Cenis (1871) and St Gotthard railways (1882). The Simplon tunnel was opened in 1906. The pass proper starts from Brieg (Swiss canton of the Valais), which is in the upper Rhône valley and 90½ m. by rail from Lausanne, past St Maurice and Sion. From Brieg it is about 14 m. up to the pass (6592 ft.), close to which is the hospice (first mentioned in 1235) in the charge of Austin Canons from the Great St Bernard. The road descends past the Swiss village of Simplon, and passes through the wonderful rock defile of Gondo before entering Italy at Iselle (28 m. from Brieg). Here the road joins the railway line through the tunnel, which is 12¼ m. in length, and 2313 ft. high, being thus both the longest and the lowest tunnel through the Alps. From Iselle it is about 11 m. by rail to Domo d'Ossola, whence the Toce or Tosa valley is followed to the Lago Maggiore (23 m.). The new line runs along the W. shore of the Lago Maggiore past Baveno, Stresa and Arona, and so on to Milan. (W. A. B. C.)

SIMPSON, SIR JAMES YOUNG (1811–1870), Scottish physician, was born at Bathgate, Linlithgow, Scotland, on the 7th of June 1811. His father was a baker in that town, and James was the youngest of a family of seven. At the age of fourteen he entered the university of Edinburgh as a student in the arts classes. Two years later he began his medical studies. At the age of nineteen he obtained the licence of the College of Surgeons, and two years afterwards took the degree of doctor of medicine. Dr John Thomson (1765–1846), who then occupied the chair of pathology in the university, impressed with Simpson's graduation thesis, "On Death from Inflammation," offered him his assistantship. The offer was accepted, and during the session 1837–1838 he acted as interim lecturer on pathology during the illness of the professor. The following winter he delivered his first course of lectures on obstetric medicine in the extra-academical school. In February 1840 he was elected to the professorship of medicine and midwifery in the university. Towards the end of 1846 he was present at an operation performed by Robert Liston on a patient rendered unconscious by the inhalation of sulphuric ether. The success of the proceeding was so marked that Simpson immediately began to use it in midwifery practice. He continued, however, to search for other substances having similar effects, and in March 1847 he read a paper on chloroform to the Medico-Chirurgical Society of

Edinburgh, in which he fully detailed the history of the use of anaesthetics from the earliest times, but especially dwelt upon the advantages of chloroform over ether. He advocated its use, not only for the prevention of pain in surgical operations, but also for the relief of pain in obstetrical practice, and his uncompromising advocacy of its use in the latter class of cases gave rise to one of the angriest and most widespread controversies of the time. In 1847 he was appointed a physician to the queen in Scotland. In 1859 he advocated the use of acupuncture in place of ligatures for arresting the bleeding of cut arteries, but of more importance were his improvements in the methods of gynaecological diagnosis and obstetrics. His contributions to the literature of his profession were very numerous, embracing *Obstetric Memoirs and Contributions* (2 vols.), *Homoeopathy*, *Acupressure*, *Selected Obstetrical Works*, *Anaesthesia and Hospitalism* and *Clinical Lectures on the Diseases of Women*. He also took an active interest in archaeology, and two volumes of his *Archaeological Essays*, edited by Dr J. Stuart, were published at Edinburgh in 1873. Simpson, who had been created a baronet in 1866, died in Edinburgh on the 6th of May 1870, and was accorded a public funeral; his statue in bronze now stands in West Princes Street Gardens, Edinburgh.

See John Duns, *Memoir of J. Y. Simpson* (1873); E. B. Simpson, *Sir James Simpson* (1896); and H. L. Gordon, *Sir J. Y. Simpson and Chloroform* (1897).

SIMPSON, MATTHEW (1811–1884), American bishop of the Methodist Episcopal Church, was born in Cadiz, Ohio, on the 21st of June 1811. He studied medicine in 1830–1833 and began to practise, and in 1833 was licensed as a preacher of the Methodist Episcopal Church. He was pastor of the Liberty Street Church of Pittsburg in 1835, and of a church at Williamsport (now Monongahela) in 1836. In 1837 he was ordained elder and was appointed professor of natural science in Allegheny College, Meadville, in which Madison College had been merged in 1833; and in 1838 he was elected professor and immediately afterwards president of the newly established Indiana Asbury (now De Pauw) University, Greencastle, Indiana, to which he went in 1839; this position he held until 1848. He was editor of the *Western Christian Advocate*, which he made a strong temperance and anti-slavery organ, from 1848 to 1852. He was elected a bishop in May 1852, and in 1857, with Dr McClintock, visited Great Britain as a delegate to the British Wesleyan Conference, and travelled in the Holy Land. He was an intimate and trusted friend of President Lincoln, who considered his advice of great value, and at whose grave in Springfield he spoke the last words. He addressed the Garfield Memorial Meeting at Exeter Hall, London, on the 24th of September 1881. He died on the 18th of June 1884 in Philadelphia.

He published *A Hundred Years of Methodism* (1876); a *Cyclopedia of Methodism* (1878); *Lectures on Preaching* (1879), delivered before the Theological Department of Yale College; and a volume of his *Sermons* (1885) was edited by George R. Crooks, whose *Life of Bishop Matthew Simpson* (New York, 1890) should be consulted.

SIMPSON, THOMAS (1710–1761), English mathematician, was born at Market Bosworth in Leicestershire on the 20th of August 1710. His father was a stuff weaver, and, intending to bring his son up to his own business, took little care of the boy's education. Young Simpson was so eager for knowledge that he neglected his weaving, and in consequence of a quarrel was forced to leave his father's house. He settled for a short time at Nuneaton at the house of a Mrs Swinfield, whom he afterwards married, where he met a pedlar who practised fortune-telling. Simpson was induced to cast nativities himself, and soon became the oracle of the neighbourhood; but he became convinced of the imposture of astrology, and he abandoned this calling. After a residence of two or three years at Derby, where he worked as a weaver during the day and taught pupils in the evenings, he went to London. The number of his pupils increased; his abilities became more widely known; and he was enabled to publish by subscription his *Treatise of Fluxions* in 1737. This treatise abounded with errors of the press, and contained several obscurities and defects incidental to the author's want of experience and the disadvantages under which

he laboured. His next publications were *A Treatise on the Nature and Laws of Chance* (1740); *Essays on Several Curious and Useful Subjects in Speculative and Mixed Mathematicks* (1740); *The Doctrine of Annuities and Reversions deduced from General and Evident Principles* (1742); and *Mathematical Dissertations on a Variety of Physical and Analytical Subjects* (1743). Soon after the publication of his *Essays* he was chosen a member of the Royal Academy at Stockholm; in 1743 he was appointed professor of mathematics in the Royal Military Academy at Woolwich; and in 1745 he was admitted a fellow of the Royal Society of London. In 1745 he published *A Treatise of Algebra*, with an appendix containing the construction of geometrical problems, and in 1747 the *Elements of Plane Geometry*. The latter book, unlike many others with the same title, is not an edition of Euclid's *Elements*, but an independent treatise, and the solutions of problems contained in it (and in the appendix to the *Algebra* as well) are in general exceedingly ingenious. In his *Trigonometry, Plane and Spherical, with the Construction and Application of Logarithms*, which appeared in 1748, there is a tolerably uniform use of contractions for the words sine, tangent, &c., prefixed to the symbol of the angle. *The Doctrine and Application of Fluxions* (1750) was more comprehensive than his earlier work on the same subject and was so different that he wished it to be considered as a new book and not as a second edition of the former. In 1752 appeared *Select Exercises for Young Proficients in the Mathematicks*, and in 1757 his *Miscellaneous Tracts on Some Curious and Very Interesting Subjects in Mechanics, Physical Astronomy and Speculative Mathematics*, the last and perhaps the greatest of all his works. From the year 1735 he had been a frequent contributor to the *Ladies' Diary*, an annual publication partly devoted to the solution of mathematical problems, and from 1754 till 1760 inclusive he was the editor of it. He died at Market Bosworth on the 14th of May 1761.

See Charles Hutton, *Mathematical and Philosophical Dictionary* (1815).

SIMROCK, KARL JOSEPH (1802-1876), German poet and man of letters, was born on the 28th of August 1802 at Bonn, where his father was a music publisher. He studied law at the universities of Bonn and Berlin, and in 1823 entered the Prussian civil service, from which he was expelled in 1830 for writing a poem in praise of the French July revolution. Afterwards he was admitted as lecturer at the university of Bonn, where in 1850 he was made a professor of Old German literature, and in which city he died on the 18th of July 1876. Simrock established his reputation by his excellent modern rendering of the *Nibelungenlied* (1827), and of the poems of Walther von der Vogelweide (1833).

Among other works translated by him into modern German were the *Arme Heinrich* of Hartmann von Aue (1830), the *Parzival* and *Titurel* of Wolfram von Eschenbach (1842), the *Tristan* of Gottfried of Strassburg (1855), and the *Heldenbuch* (1843-1849), which he supplemented with independent poems. Before the publication of this work he had shown an original poetical faculty in *Wieland der Schmied* (1835); and in 1844 he issued a volume of *Gedichte* in which there are many good lyrics, romances and ballads. In 1850 appeared *Lauda Sion*, and in 1857 the *Deutsche Sionsharfe*, collections of Old German sacred poetry. Of his republications the most popular and the most valuable were the *Deutschen Volksbücher*, of which fifty-five were printed between 1839 and 1867. His best contribution to scholarship was his *Handbuch der deutschen Mythologie* (1853-1855). At an early stage of his career Simrock took a high place among students of Shakespeare by his *Quellen des Shakespeare in Novellen, Märchen und Sagen* (1831); and afterwards he translated Shakespeare's poems and a considerable number of his dramas. The large number of editions through which Simrock's translations from the Middle High German have passed (the *Nibelungenlied* more than forty) bear witness to their popularity. An edition of his *Ausgewählte Werke* in 12 vols. has been published by G. Klee (1907).

See N. Hocker, *Karl Simrock, sein Leben und seine Werke* (1877); H. Düntzer, "Erinnerungen an Karl Simrock," in *Monatsschrift für Westdeutschland* (1877), and E. Schröder's article in *Allg. deutsche Biographie*.

SIMS, GEORGE ROBERT (1847-), English journalist and dramatic author, was born on the 2nd of September 1847. He was educated at Hanwell College and at Bonn, and commenced journalism in 1874 as successor to Tom Hood on *Fun*.

His first play, *Critch and Toothpick*, was produced at the Royalty Theatre in April 1879, and was followed by a number of plays of which he was author or part-author. After long runs at west end houses, many of these became stock pieces in suburban and provincial theatres. His most famous melodramas were: *The Lights of London* (Princess's theatre, September 1881), which ran for nearly a year; *In the Ranks* (Adelphi, Oct. 1883), written with H. Pettit, which ran for 457 nights; *Harbour Lights* (1885), which ran for 513 nights; *Two Little Vagabonds* (Princess's Theatre, 1896-1897). He was part-author with Cecil Raleigh of the burlesque opera, *Little Christopher Columbus* (1893), and among his musical plays were *Blue-eyed Susan* (Prince of Wales's, 1892) and *The Dandy Fifth* (Birmingham, 1898). His early volumes of light verse were very popular, notably *The Dagonet Ballads* (1882), reprinted from the *Referee*. *How the Poor Live* (1883) and his articles on the housing of the poor in the *Daily News* helped to arouse public opinion on the subject, which was dealt with in the act of 1885.

SIMSBURY, a township of Hartford county, Connecticut, U.S.A., traversed by the Farmington river and about 10 m. N.W. of Hartford. Pop. (1910) 2537. Area about 38 sq. m. The township is served by the New York, New Haven & Hartford and by the Central New England railways, which meet at Simsbury village. Among the manufactures are fuses, cigars and paper. A tract along the Tuxus (now Farmington) river, called Massacoe or Saco by the Indians, was ceded to whites in 1648, and there were settlers here from Windsor as early as 1664. In 1670 the township was incorporated as Simsbury. In 1675, during King Philip's War, Simsbury was abandoned; and in 1676 it was burnt and pillaged by the Indians; but it was resettled in the following year. Steel seems to have been made here from native iron in 1727, and in 1739 the General Court of Connecticut granted to three citizens of Simsbury a fifteen years' monopoly of making steel in the colony. Owing to the pine forests pitch and tar were important manufactures in early times. From the N. of Simsbury the township of Granby (pop. 1910, 1383) was set off in 1786. In this part of the township a copper mine was worked between 1705 and 1745, and smelting and refining works were built in 1721. In 1773 the mine was leased by the General Court and was fitted up as a public gaol and workhouse (called Newgate Prison), the prisoners being employed in mining. Some Tories were imprisoned here after 1780; many of them escaped in May 1781. The prison was rebuilt in 1790 and was used until 1827. The W. of Simsbury was set off in 1806 as Canton (pop. in 1900, 2678).

See N. A. Phelps, *History of Simsbury, Granby and Canton from 1642 to 1845* (Hartford, 1845).

SIMSON, MARTIN EDUARD VON (1810-1899), German jurist and politician, was born at Königsberg, in Prussia, on the 10th of November 1810, of Jewish parentage. After the usual course at the gymnasium of his native town, he entered its university in 1826 as a student of jurisprudence, and specially of Roman law. He continued his studies at Berlin and Bonn, and, having graduated *doctor juris*, attended lectures at the *École de Droit* in Paris. Returning to Königsberg in 1831 he established himself as a *Privatdozent* in Roman law, becoming two years later extraordinary, and in 1836 ordinary, professor in that faculty at the university. Like many other distinguished German jurists, *pari passu* with his professorial activity, Simson followed the judicial branch of the legal profession, and, passing rapidly through the subordinate stages of auscultator and assessor, became adviser (Rath) to the Landgericht in 1846. In this year he stood for the representation of Königsberg in the National Assembly at Frankfort-on-Main, and on his election was immediately appointed secretary, and in the course of the same year became successively its vice-president and president. In his capacity of president he appeared, on 3rd April 1849, in Berlin at the head of a deputation of the Frankfort parliament to announce to King Frederick William IV. his election as German Emperor by the representatives of the people. The king, either apprehensive of a rupture with Austria, or fearing detriment to the prerogatives of the Prussian crown should he

accept this dignity at the hands of a democracy, refused the offer. Simson, bitterly disappointed at the outcome of his mission, resigned his seat in the Frankfort parliament, but in the summer of the same year was elected deputy for Königsberg in the popular chamber of the Prussian Landtag. Here he soon made his mark as one of the best orators in that assembly. A member of the short-lived Erfurt parliament of 1850, he was again summoned to the presidential chair.

On the dissolution of the Erfurt assembly, Simson retired from politics, and for the next few years devoted himself exclusively to his academical and judicial duties. It was not until 1859 that he re-entered public life, when he was elected deputy for Königsberg in the lower chamber of the Prussian Landtag, of which he was president in 1860 and 1861. In the first of these years he attained high judicial office as president of the court of appeal at Frankfort on the Oder. In 1867, having been elected a member of the constituent assembly of the North German Federation, he again occupied the presidential chair, as he did also in the first regular Diet and the Zoll-parliament which succeeded it. On 18th December 1870 Simson arrived at the head of a deputation in the German headquarters at Versailles to offer the imperial crown to the king of Prussia in the name of the newly-elected Reichstag. The conditions under which Prussia might justly aspire to the hegemony in Germany at last appeared to have been accomplished, no obstacles, as in 1849, were in the way of the acceptance of the crown by the leading sovereign of the confederation, and on 18th January 1871 King William of Prussia was proclaimed with all pomp German Emperor in the Salle des Glaces at Versailles. Simson continued as president of the Reichstag until 1874, when he retired from the chair, and in 1877 resigned his seat in the Diet, but at Bismarck's urging, accepted the presidency of the supreme court of justice (Reichsgericht), and this high office he filled with great distinction until his final retirement from public life in 1891. In 1888 the emperor Frederick bestowed upon Simson the order of the Black Eagle.

His political career coincides with the era of German struggles towards unity. As a politician he was one of the leaders of modern Liberalism, and though always loyal when appeals were made to patriotism, such as government demands for the army, he remained obdurate on constitutional questions; and he resolutely opposed the reactionary policy of the Prussian Conservatives. On his retirement from the presidency of the Reichsgericht, he left Leipzig and made his home in Berlin, where he died on the 2nd of May 1899.

His *Life* was written by his son, Bernard von Simson, under the title *Eduard von Simson, Erinnerungen aus seinem Leben* (1900).

(P. A. A.)

SIMSON, ROBERT (1687–1768), Scottish mathematician, the eldest son of John Simson of Kirktonhill in Ayrshire, was born on the 14th of October 1687. He was intended for the church, but the bent of his mind was towards mathematics, and, when a prospect opened of his succeeding to the mathematical chair at the university of Glasgow, he proceeded to London for further study. After a year in London he returned to Glasgow, and in 1711 was appointed by the university to the professorship of mathematics, an office which he retained until 1761. He died on the 1st of October 1768.

Simson's contributions to mathematical knowledge took the form of critical editions and commentaries on the works of the ancient geometers. The first of his published writings is a paper in the *Philosophical Transactions* (1723, vol. xl. p. 330) on Euclid's *Porisms* (q.v.). Then followed *Sectionum conicarum libri V.* (Edinburgh, 1735), a second edition of which, with additions, appeared in 1750. The first three books of this treatise were translated into English, and several times printed as *The Elements of the Conic Sections*. In 1749 was published *Apollonii Pergaei locorum planorum libri II.*, a restoration of Apollonius's lost treatise, founded on the lemmas given in the seventh book of Pappus's *Mathematical Collection*. In 1756 appeared, both in Latin and in English, the first edition of his Euclid's *Elements*. This work, which contained only the first six and the eleventh and twelfth books, and to which in its English version he added the *Data* in 1762, was for long the standard text of Euclid in England. After his death restorations of Apollonius's treatise *De sectione determinata* and of Euclid's treatise *De porismatibus* were printed for private circulation in

1776 at the expense of Earl Stanhope, in a volume with the title *Roberti Simson opera quaedam reliqua*. The volume contains also dissertations on *Logarithms* and on the *Limits of Quantities and Ratios*, and a few problems illustrative of the ancient geometrical analysis.

See W. Trail, *Life and Writings of Robert Simson* (1812); C. Hutton, *Mathematical and Philosophical Dictionary* (1815).

SIMSON, WILLIAM (1800–1847), Scottish portrait, landscape and subject painter, was born at Dundee in 1800. He studied under Andrew Wilson at the Trustees' Academy, Edinburgh, and his early pictures—landscape and marine subjects—found a ready sale. He next turned his attention to figure painting, producing in 1829 the "Twelfth of August," which was followed in 1830 by "Sportsmen Regaling" and a "Highland Deer-stalker." In the latter year he was elected a member of the Scottish Academy; and, having acquired some means by portrait-painting, he spent three years in Italy, and on his return in 1838 settled in London, where he exhibited his "Camaldolese monk showing Relics," his "Cimabue and Giotto," his "Dutch Family," and his "Columbus and his Child" at the Convent of Santa Maria la Rabida. He died in London on the 29th of August 1847. Simson is greatest as a landscapist; his "Solway Moss—Sunset," exhibited in the Royal Scottish Academy of 1831 and now in the National Gallery, Edinburgh, ranks as one of the finest examples of the early Scottish school of landscape. His elder brother George (1791–1862), portrait-painter, was also a member of the Royal Scottish Academy, and his younger brother David (d. 1874) practised as a landscape-painter.

SIN (O. Eng. *syn*: a common Teutonic word, cf. Dutch *zonde*, Ger. *Sünde*), a general term for wickedness or a wicked act. As psychology recognizes a distinction of pleasure and pain, and metaphysics of good and evil, so morality assumes the difference between right and wrong in action, good and bad in character; but the distinction in psychology and metaphysics applies to what is, the difference in morality is based on a judgment of what is by what ought to be. When the act or the character does not correspond with the standard, this want of correspondence may in different relations be variously described. In relation to human society, and the rules it imposes on its members, action that ought not to be done is *crime*; a habit which is injurious to a man's own moral nature, especially if it involves evil physical consequences, is described as *vice*. If man is thought of as under the authority of God, any transgression of or want of conformity to the law of God is defined as *sin*. Crime is a legal, vice a moral, and sin a religious term. Sin may be distinguished from *guilt* as follows: guilt is the liability to *penalty*, that is, to the suffering conceived not as the natural consequence, but as the expression of the divine displeasure, which sin as a breach of divine law involves. Sin is a term applied not only to actions, but also to dispositions and motives. In the theological phrase *original sin* it means the inherited tendency to do wrong.

There have been two great controversies in the Christian Church on this question, the Augustinian-Pelagian and the Calvinistic-Arminian, one in the 5th century and the other in the 17th. Pelagius declared the capacity of every man to become virtuous by his own efforts, and summoned the members of the Church in Rome to enter on the way of perfection in monasticism. His friend Caelestius was in 412 charged with and excommunicated for heresy because he regarded Adam as well as all his descendants as naturally mortal, denied the racial consequences of Adam's fall, asserted the entire innocence of the new-born, recognized sinless men before the coming of Christ. Pelagius himself desired to avoid controversy, and with mental reservations denied these statements of his friend; but he did not escape suspicion, and his condemnation in 418 was the signal for a literary polemic, which lasted ten years, and in which Julian of Eklantum was the most brilliant but reckless combatant on the side of Pelagius. In the East the freedom of the will was so insisted on, that one may regard Greek theology as essentially Pelagian. In the West there was unanimity only on three points: the necessity of baptism for the remission of sins, the inheritance of sin as a result of Adam's fall, and the indispensableness of the divine grace in the attainment of goodness. Pelagius insisted that

sin was an act, not a state, an abuse of the freedom of the will, and that each man was responsible and liable to punishment only for his own acts. This extreme individualism he qualified only in two respects, he admitted a principle of imitation, the influence of bad example, habit and customs, may be inherited and communicated. Divine grace is not necessary for human virtue. It is granted only according to act, and merits as the law in enlightening, warning or promising reward. To this Augustine opposed the view that Adam's sin is, as its penalty, transmitted to all his descendants, both as guilt and as weakness. The transmission is not by imitation, but by propagation. The essence and mode of operation of *original sin* is *concupiscence*, which, as of the devil, subjects man in his natural state to the devil's dominion. Even infants are involved in Adam's condemnation. Sin is a necessity in each individual, and there is a total corruption of man's nature, physically as well as morally. Into the details of the controversy it is not necessary to go any further. While the authority of Augustine received lip-homage, the doctrine of the Roman Catholic Church became more Pelagian, and in the Tridentine decrees and still more in the ethics of the Jesuits, in spite of the opposition of Jansenism, Pelagianism at last triumphed.

The Reformation restored the teaching of Augustine; in Calvinism especially the sovereignty of the divine and the impotence of the human will were emphasized; and against this exaggeration Arminianism was a protest. Of the five articles of the *Remonstrance* of 1610 only two now concern us: the possibility of resisting the grace which is indispensable to salvation, and the possibility of falling away from grace even after conversion. The Arminian system was an attempt to modify the Calvinistic theory in a moral interest, so as to maintain human responsibility, good and ill desert; but to this moral interest the system sacrificed the religious interest in the sufficiency and the sovereignty of divine grace. Its adherents necessarily laid emphasis on human freedom. As regards *original sin* they taught that the inclinations to evil inherited from Adam are not themselves blameworthy, and only consent to them involves real guilt. It is not just, however, to Arminianism to identify it with Pelagianism, as it does strive to make clear man's need of divine grace to overcome sin and reach holiness. In the Evangelical Revival of the 18th century Arminianism was represented by Wesley, and Calvinism by Whitefield.

SIN, the name of the moon-god in Babylonia and Assyria, also known as Nannar, the "illuminer." The two chief seats of his worship were Ur in the S., and Harran considerably to the N., but the cult at an early period spread to other centres, and temples to the moon-god are found in all the large cities of Babylonia and Assyria. He is commonly designated as En-zu, i.e. "lord of wisdom," and this attribute clings to him throughout all periods. During the period (c. 2600-2400 B.C.) that Ur exercised a large measure of supremacy over the Euphrates valley, Sin was naturally regarded as the head of the pantheon. It is to this period that we must trace such designations of the god as "father of the gods," "chief of the gods," "creator of all things," and the like. We are justified in supposing that the cult of the moon-god was brought into Babylonia by the Semitic nomads from Arabia. The moon-god is *par excellence* the god of nomadic peoples, their guide and protector at night when, during a great part of the year, they undertake their wanderings, just as the sun-god is the chief god of an agricultural people. The cult once introduced would tend to persevere, and the development of astrological science culminating in a calendar and in a system of interpretation of the movements and occurrences in the starry heavens would be an important factor in maintaining the position of Sin in the pantheon. The name of Sin's chief sanctuary at Ur was E-gish-shir-gal, "house of the great light"; that at Harran was known as E-khul-khul, "house of joys." On seal-cylinders he is represented as an old man with flowing beard, with the crescent as his symbol. In the astral-theological system he is represented by the number 30, and the planet Venus as his daughter by the number 15. The number 30 stands obviously in connexion with the thirty days as the average extent of his course until he stands again in conjunction with the sun.

The "wisdom" personified by the moon-god is likewise an expression of the science of astrology in which the observation of the moon's phases is so important a factor. The tendency to centralize the powers of the universe leads to the establishment of the doctrine of a triad consisting of Sin, Shamash and Ishtar (*q.v.*), personifying the moon, sun and the earth as the life-force. (M. JA.)

SINAI. 1. *The Biblical Mount Sinai.* In judging of the points of controversy connected with Sinai we are brought face to face with the question of the historicity of the Hebrew records involved. Though new attempts to fix the stations of the wilderness wandering appear every year, critics have long agreed that the number of forty for the years of wandering and for the stations are round numbers, and that the details are not based on historical tradition of the Mosaic age. This does not exclude the possibility that the names of some or all of the stations belong to real places and are based on more or less careful research on the part of the writers who record them. As regards the Mountain of the Law in particular, if the record of Exod. xix. seq. is strictly historical, we must seek a locality where 600,000 fighting men, or some two million souls in all, could encamp and remain for some time, finding pasture and drink for their cattle, and where there was a mountain (with a wilderness at its foot) rising so sharply that its base could be fenced in, while yet it was easily ascended, and its summit could be seen by a great multitude below. In the valley there must have been a flowing stream. The peninsula of Sinai does not furnish any locality where so great a host could meet under the conditions specified, and accordingly many investigators give up the statistics of the number of Hebrews and seek a place that fulfils the other conditions. But when we consider that the various records embodied in the Pentateuch were composed long after the time of Moses, and that the authors in all probability never saw Sinai, and had no exact topographical tradition to fall back on, but could picture to themselves the scene of the events they recorded only by the aid of imagination, the topographical method of identifying the Mountain of the Law becomes very questionable. The Pentateuchal writers are not at one even about the name of the mountain. It used to be thought that Horeb was the name of the mountain mass as a whole, or of its southern part, while Sinai was the Mountain of the Law proper, but it has been shown by Dillmann that the Elohist and Deuteronomy always use the name Horeb for the same mountain which the Jahvist and the Priestly Code call Sinai. The Elohist belonged to Northern Israel, but Judges v. 5 shows that even in Northern Israel the other name Sinai was not unknown. And it might be shown, though that cannot be done here, that the several accounts vary not only as regards the name but in topographical details. Thus all that can be taken as historically fixed is that after leaving Goshen the Hebrews abode for some time near a mountain called Sinai or Horeb, and that this mountain or range was held to be holy as a seat of the Deity (Exod. ii. 1; 1 Kings xix.).

Where, then, was this mountain? The Midianites, of whom according to one source Jethro was priest, probably always lived E. of the Gulf of 'Aqaba; yet we can hardly follow Beke in seeking Sinai beyond that gulf, but must rather think of some point in the so-called peninsula of Sinai, which lies between the Gulfs of 'Aqaba and Suez, bounded on the N. by the Wilderness el-Tih, which slopes gently towards the Mediterranean. To the south of this wilderness rises the Jebel el-Tih, a mass composed mainly of Nubian sandstone and cretaceous limestone, which attains in fantastic forms an altitude of some 3000 ft.; its ridges converge towards the S. and are cut off by great valleys from the mass now known as Mount Sinai. The latter is composed of primitive rocks—granite, porphyry, diorite, gneiss, &c. The sandstones of Jebel el-Tih are rich in minerals; inscriptions of Amenophis III. and Thothmes III. found on the spot show that the ancient Egyptians got turquoise at Serabit al-Khadem; and at Maghara, where inscriptions occur bearing the names of kings from Semerkhet and Khufu down to Rameses II. These mines were worked by criminals and prisoners of war, and the

waste products of copper foundries indicate that the peninsula was once better wooded than now, of which indeed we have express testimony of post-Christian date. At present the dominant feature is bare walls of rock, especially in the primitive formations; the steep and jagged summits have a striking effect, which is increased by the various colours of the rock and the clearness of the atmosphere. The deep-cut valleys are filled by rushing torrents after rain, but soon dry up again. In the S. the centre of the main mountain mass is Mount Catherine (8540 ft.), Omm Shōmar to the S.E. being little lower; this peak and N. of it Mount Serbāl (6750 ft.), which rises more immediately from the plain, dominate the Kā'ah, a waste expanse of sand strewn with pebbles, which occupies the S.W. margin of the peninsula. In the Kā'ah is the village of Ṭūr, and at the S. promontory (Ras Mohammed) is the little hamlet of Sherm. The Sinai group as a whole is called by the Arabs Jebel al-Ṭūr; the name Sinā in Arabic comes only from books. The area of the peninsula is about 11,200 sq. m.; the population is four to five thousand souls, chiefly Bedouins of various tribes, whose common name, derived from Ṭūr, is Ṭowāra. They have sheep and goats, with which they retire in summer to the higher lands, where there is good pasture ground, and where springs are comparatively common. On the chalk and sandstone water is scarcer than among the primitive rocks, and often brackish. Though the rocks are bare, there is always vegetation in the dales, especially acacias and tamarisks; from the latter (*T. mannifera*) manna is still derived in quantities that vary with the rainfall. On the hills grow aromatic plants, especially *Thymaceae*. The fauna includes the ibex, hyrax and hyaena; the panther too is sometimes found. Flights of quail have been observed. In some valleys there are well-kept gardens and good date-palms; the most noted oasis is that of Feiran, in the N.W. of the peninsula, which is watered by a perennial stream. Whether Feiran is the Rephidim of Exod. xvii. is a question which, like the identification of the other stations of the Israelites, depends on the localization of the Mountain of the Law.

There is no genuine pre-Christian tradition on this subject. The chief authority for the ancient sanctity of Mount Sinai is Antoninus Martyr (end of the 6th century), who tells that the heathen Arabs in his time still celebrated a moon feast there. As *sin* means "moon," this feast has been connected with the name of Sinai, but the proposed etymology is not certain. Of heathen origin, too, are the many Nabataean inscriptions of Sinai, found especially in the Wādy Mokatteb (in the N.W.), and sometimes accompanied by rude drawings. The language and character are Aramaic, but the proper names are mainly those of Arabs, who passing by graved their names on the rocks. That they were pilgrims to Sinai cannot be made out with certainty. The inscriptions date from the early years of the Christian era, when the Nabataean kingdom was at its height.

In early Christian times many anchorites inhabited Sinai, living for the most part in the caves, which are numerous even in the primitive rocks. Then monasteries were built, the most famous being the great one of St Catherine in Wādy el-Dēr (the valley of the monastery). On Serbāl, too, there were many granite dwellings, and in the neighbouring Pharan (Phoenician), which was a bishop's see, there were, as the ruins show, churches and convents.

The question then is whether when the hermits first settled in the peninsula there existed a tradition as to the place of the Mountain of the Law, and whether they chose for their residence a spot which was already traditionally consecrated by memories significant to the Christian as well as to the Jew. No assertion of the existence of such a tradition is to be found in Josephus, who only says that Sinai was the highest mountain of the district—a description which might apply to Serbāl as seen from the plain below. Eusebius uses expressions which may also seem to point to Serbāl as the place of the law-giving, and it must be admitted that the tradition which seeks the holy site in the group of Jebel Mūsā (*i.e.* the mass of which Mount Catherine is the highest peak) is not older than the time of Justinian, so that the identification with Mount Serbāl seems to have greater

antiquity in its favour. In later times Jebel Mūsā and Serbāl had each its own tradition, and the holy places were pointed out at each; thus from the monastery of St Catherine a path of granite steps was constructed up to "the Mountain of the Law," but similar steps are found at Serbāl. That these traditions are not decisive, however, is admitted, more or less, even by those moderns who, like Lepsius, Ebers, Bartlett, give their voice for Serbāl. Most authorities still prefer Jebel Mūsā or some point in that group, but they again differ in details. First of all there is much difficulty in determining the route by which the Hebrews approached the mountain. Then comes the question of finding a suitable plain for their encampment under the mountain, which is best met if, with Robinson, Stanley, Palmer and others, the plain is taken to be that of al-Rāḥe and the overhanging mountain to be Jebel Sufsāfeh. The latter is over 6300 ft. high, and consists of pasture ground; it does not fit all the details in Exodus, but this objection is quite as strong against the traditional site on Jebel Mūsā (Mount Moses), which lies farther S. Jebel Mūsā has been accepted by Tischendorf, Laborde, Ritter, Strauss, Farrar, and many others; on this view the Israelites must have encamped in the narrow Wādy al-Seya'iyeh, N. of the mount. But the absence of exact topographical detail on the part of the Biblical narrators, who always speak of Sinai as if it were a single summit and give no hint about several summits of which it is one, shows that in their time there was no real tradition on the matter, and that all attempts at identification are necessarily vain.

LITERATURE.—Burckhardt, *Travels in Syria, &c.* (London, 1822); Leon de Laborde, *Voyage de l'Arabie Pétrée* (Paris, 1830-1836); Robinson, *Biblical Researches* (London, 1841); Lepsius, *Reise* (Berlin, 1845); Stanley, *Sinai and Palestine*; Fraas, *Aus d. Orient* (Stuttgart, 1867); *Ordnance Survey of the Pen. of Sinai* (Southampton, 1869, 3 vols.); Palmer, *Desert of the Exodus* (Cambridge, 1871); Ebers, *Durch Gosen zum Sinai* (2nd ed., Leipzig, 1881); Baker Greene, *The Hebrew Migration* (London, 1883); Hull, *Mount Seir, Sinai and West Palestine* (London, 1885). See also the Palestine Society's *Quarterly Statement, passim.* (A. So.)

2. *The Peninsula: Recent Research.*—The peninsula of Sinai is about 230 m. in extreme length and 150 m. wide, or nearly the size of Ireland. It is practically waterless and barren, the population being not a thousandth of that on an equal area in England. The S. part is a high mass of schists and granite, deeply cut into valleys; it is overlaid by carboniferous sandstone, and limestone, capped with tertiary basalt, flows in the mining region. The N. part is an expanse of cretaceous limestone and nummulitic tertiary limestone, sloping down to the Mediterranean. The steep valley of the Gulf of Suez has been greatly deepened—if not formed—since the tertiary limestone was deposited, the beds dipping down sharply to the sea. The only water supply of any importance is that in the Wādy Feiran; elsewhere only small water-holes preserve enough for a few persons, but fresh water can be obtained along the shore route by digging.

The difficulty about the numbers of the Israelites who lived here has lately been treated on a fresh basis. That they were not more numerous than the previous inhabitants is shown by the difficulty in conquering the Amalekites at Rephidim. In the census lists of the Book of Numbers the hundreds of people in each tribe are in most cases 4 or 500; 2, 3, 6 or 700 are rare; 0, 1, 8 or 900 do not occur. The hundreds are therefore independent of the thousands prefixed to them: and as *alāf* means both a "thousand" and a "family," it is proposed that the original census was in numbers of tents or families, and hundreds of people; and that later the family numbers were mistaken for thousands. Other points agree in this view, such as the number of persons in a family, the similarity of hundreds in the census before and that after the wanderings, and the actual size of Goshen, from which they came, and the population of Sinai where they settled. Thus the total numbers were 5730 people. The internal evidence that the census lists are original documents is very strong, though they have been misunderstood by later compilers. It is impossible to suppose a population trained in Egypt not having the ability to keep some tribal

records of numbers and movements such as were the basis of the existing re-edited narrative.

The history of the Egyptian settlements has been investigated. They began in the Ist Dynasty, shown by the tablet of the conquest by King Semerkhet (5280 B.C.) above the mines of turquoise at Wady Maghara. Seneferu (4750 B.C.) was already working at Serabit for turquoise. Other kings who left records here are Sanekht (IIIrd Dynasty), Khufu (IVth), Sahura, Ranuser, Menkauhor (Vth), Amenemhat I., Senusert I., Senusert II., Senusert III., Amenemhat II., Amenemhat III., Amenemhat IV. (XIIth), Aahmes I., Amenhotep I., Tahutmes I., Hatshesput, Tahutmes III., Tahutmes IV., Amenhotep III. (XVIIIth), Rameses I., Sety I., Rameses II., Merenptah, Sety II., Tausert, Setnekht (XIXth), Rameses III., IV., V. and VI. (XXth). The monuments are mostly inscriptions recording the mining expeditions and offerings made to the goddess of turquoise. The original shrine of the goddess was a cave; this was hewn out and buildings were gradually added before it to a length of 230 ft. The records show that no fewer than twenty-five different grades of officials took part in the work of mining, which was highly organized as regards direction, technical ability, labour and transport, often as many as 700 men being employed. Over 400 objects with kings' names have been found in the fragments of the offerings which were left in the shrine. The worship at Serabit was that of Hathor, mistress of turquoise. She is identical with Athtar or Ishtar, the Semitic goddess of Arabia. The features of the worship were entirely Semitic and not Egyptian. An enormous mass of burnt-offerings is shown by the bed of ashes before the sacred cave; tanks for ablutions are found in the temple courts, altars of incense are in the shrine itself, and also conical stones; and chambers or shelters for dreaming before the temple are a main feature. All of these belong to Semitic worship, and they show that before Mosaism the elements of the worship were the same as are found in later times.

For all the recent research see W. M. Flinders Petrie, *Researches in Sinai* (1906).

SINAIA, a town of Rumania, about 12 m. S. of the Hungarian frontier at Predeal, on the railway from Ploesci to Kronstadt in Transylvania. Pop. (1900), 2210. Sinaia resembles a large model village, widely scattered among the pine forests of the lower Carpathians, and along the banks of the Prahova, a swift alpine stream. The monastery of Sinaia, founded by Prince Michael Cantacuzino in 1695, was the residence of the royal family until the present chateau was built. It consists of two courts surrounded by low buildings. In the centre of each court is a small church built in the Byzantine style. The monks possess a library, in which are kept valuable jewels belonging to the Cantacuzene family. Castle Peles or Pelesh, the modern palace, named after the hill on which it stands, is of a mixed style of architecture. The interior is fitted with magnificent wood carvings and stained glass windows illustrating the principal scenes of "Carmen Sylva's" writings. Until 1850 Sinaia consisted of little more than the monastery and a group of huts. In 1864, however, the monastic estate was assigned to the Board of Civil Hospitals, by which a hospital and baths were opened and the mineral springs developed. Sinaia soon became the favourite summer resort of Bucharest society, and rapidly developed in all its equipment.

SINALOA, a N. state of Mexico, bounded N. by Sonora and Chihuahua, E. by Durango, S. by Tepic, and W. by the Gulf of California, with a coast line of nearly 400 m. Area, 33,671 sq. m. Pop. (1900), 296,701, largely Indians. The surface consists of a narrow coastal zone where tropical conditions prevail, a broad belt of mountainous country covered by the ranges of the Sierra Madre Occidental and their intervening valleys where oak and pine forests are to be found, and an intervening zone among the foothills of the Sierra Madre up to an elevation of 2000 ft., where the conditions are subtropical. The state is traversed by numerous streams, the largest of which have broad valleys among the foothills. The largest of these are the Culiacán, Fuerte and Sinaloa, the last two having short navigable courses across the lowlands.

Rain is plentiful everywhere, except in the extreme north, where the conditions are arid. The climate of the low-lying coast lands is hot and malarious, but in the mountains it is cool and healthy. Cereals and *mescal* are produced on the uplands, and sugar, rum, coffee, tobacco, grape spirits and fruit in the lower zones. There are excellent cotton lands in the state and the production of this staple was largely developed during the American Civil War, but it has since declined. Grazing receives considerable attention in the uplands, where the temperature is favourable and the pasturage good, and hides are largely exported. Mining, however, is the chief industry, Sinaloa being one of the richest mineral-producing states in the republic. Gold, silver, copper, iron and lead are found. There are also salt deposits and mineral springs. The best-known silver mines are the Rosario, from which about \$90,000,000 had been extracted up to the last decade of the 19th century, and the Nuestra Señora de Guadalupe de los Reyes, discovered early in the 19th century and yielding over \$85,000,000 before its close. The forest products of the state include rubber, resins, cabinet and dye-woods, deerskins, orchilla and itxle fibre. Up to the beginning of the 20th century Sinaloa had only one short railway, which connected Culiacán with its port Altata. Since then the Mexican branch of the (American) Southern Pacific railway from Nogales to Guaymas has been extended S.E. along the coast. Sinaloa has excellent natural harbours, only two of which—Mazatlán and Altata—are much used. The bays of Agiobampo and Topolobampo are prospective railway terminals with fine harbours. The capital of the state is Culiacán Rosales (commonly called Culiacán), on the Culiacán river 39 m. from its port, Altata, at the mouth of the same river, with which it is connected by rail. It is a well-built town, with some thriving manufactures, including cotton goods, cigarettes, liqueurs, &c. It is the see of a bishop and has a fine cathedral. Culiacán (pop. in 1900, 10,380) is the distributing centre for a large district between Guaymas and Mazatlán. The most important town is Mazatlán, one of the leading ports of Mexico on the Pacific coast, and the commercial centre for S. Sinaloa and N. Durango. Other towns are Mocerito (pop. 9971 in 1895), Sinaloa and Fuerte, all in the N. of the state, Rosario (pop. 8448 in 1900), and San Ignacio in the S.

SINAN PASHA (1515-1596), Turkish soldier and statesman, was an Albanian of low origin. In 1569 he was appointed governor of Egypt and was occupied until 1571 in the conquest of Yemen. In 1574 he commanded the great expedition against Tunis, which, in spite of the brave defence by the Spanish and Italian garrison, was added to the Ottoman empire. In 1580 Sinan commanded the army against Persia and was appointed grand vizier, but was disgraced and exiled in the following year, owing to the rout of his lieutenant Mahommed Pasha, at Gori, in an attempt to provision the Turkish garrison of Tiflis. He subsequently became governor of Damascus and, in 1589, after the great revolt of the Janissaries, was appointed grand vizier for the second time. Another revolt of Janissaries led to his dismissal in 1591, but in 1593 he was again recalled to become grand vizier for the third time, and in the same year he commanded the Turkish army against Hungary. In spite of his victories he was again deposed in February 1595, shortly after the accession of Mahommed III., and banished to Malghara; but in August was in power again and on the march to Wallachia. The unhappy course of this campaign, culminating in the fall of Gran, brought him once more into disfavour, and he was deprived of the seal of office (November 19). The death of his successor, Lala Mahommed, three days later, was looked on as a sign from heaven, and Sinan became grand vizier for the fifth time. He died suddenly on the 3rd of April 1596.

Bold, overbearing and unscrupulous, Sinan recoiled from no baseness to put a rival out of the way; while his insolence was not confined to foreign ambassadors, but was exercised towards his opponents in the sultan's presence. He had a barbarous hatred not only for Christians but for all civilization. The immense fortune which he left is a proof of his rapacity.

Another Sinan Pasha was governor of Anatolia at the time of Mahommed II.'s death in 1481. He was a brother-in-law of Bayezid II. and defeated Prince Jem's troops at Brusa. In Selim I.'s reign he served with great distinction in the Persian and Egyptian campaigns and fell at the battle of Ridania, where the Mamelukes were defeated, in 1517.

A third Sinan Pasha, brother of the grand vizier Rustem Pasha, was grand admiral under Suleiman I. and died about 1553.

See J. v. Hammer-Purgstall, *Gesch. des Osmanischen Reiches* (2nd ed., Pesth, 1840), and authorities there cited.

SINCLAIR, the name of an old Scottish family, members of which have held the titles of earl of Orkney and earl of Caithness. The word is a variant of Saint Clair.

SIR WILLIAM SINCLAIR, or **SAINT CLAIR** (c. 1260—c. 1303), was the descendant of a line of Anglo-Norman barons, one of whom obtained the barony of Rosslyn from King David I. in the 12th century. Sir William took part in the dispute over the succession to the crown of Scotland in 1292, and was one of the leaders of the Scots in their revolt against Edward I. One of his sons was William Sinclair (d. 1337), bishop of Dunkeld, who was responsible for the defeat of an English force at Donibristle in Fife in 1317. Sir William's eldest son was Sir Henry Sinclair (d. 1330), the friend of Robert the Bruce; and Sir Henry's son was Sir William Sinclair, who was slain by the Saracens in August 1330, while journeying through Spain to Palestine with Sir James Douglas, the bearer of the heart of Bruce. This Sir William Sinclair married Isabel, daughter of Malise, earl of Strathearn, Caithness and Orkney (d. c. 1350), and their son Sir Henry Sinclair (d. c. 1400) obtained the earldom of Orkney by a judgment of the Norwegian king Haakon VI. in 1379. He then helped to conquer the Faeroe Islands, and took into his service the Venetian travellers, Niccolo and Antonio Zeno, sailing with Antonio to Greenland. This prince of Orkney, as he is sometimes called, was succeeded by his son Henry (d. 1418), who was admiral of Scotland, and then by his grandson William (c. 1404—1480), the founder of the beautiful chapel at Rosslyn.

WILLIAM, the 3rd earl of his line, whose earldom of Orkney was a Norwegian dignity, was made chancellor of Scotland in 1454 and Lord Sinclair and earl of Caithness in 1455. He took some part in public affairs in Scotland, and when in 1470 the Orkney Islands were ceded by Norway to King James III. he resigned all his rights therein to his sovereign and was known merely as earl of Caithness. His eldest son, William, having offended his father by his wasteful habits, the earl settled his earldom on his eldest son by another marriage, also called William, who was killed at Flodden in 1513. The elder William, however, inherited the title of Lord Sinclair, and the family was thus split into two main branches. John, the 3rd earl, was killed in 1529 while attempting to seize the Orkney Islands.

GEORGE, 4th earl of Caithness (c. 1525—1582), a son of the 3rd earl, was a Roman Catholic and a supporter of Mary Queen of Scots, but he was mainly occupied with acts of violence in the north of Scotland. His grandson George, the 5th earl (c. 1566—1643), was outlawed and compelled to fly to the Shetlands. He left many debts, and his great-grandson and successor, George, the 6th earl (d. 1676), who was childless, arranged that his estates should pass to a creditor, Sir John Campbell, afterwards earl of Breadalbane. Campbell was created earl of Caithness in 1677, but the title was also claimed by George Sinclair (d. 1698), a grandson of the 5th earl, and in 1681 the privy council decided in his favour. When Alexander, the 9th earl, died in 1765 the title was successfully claimed by William Sinclair (d. 1779), a descendant of the 4th earl, who became the 10th earl. James, the 12th earl (1766—1823), was descended from another branch of the 4th earl's family, and his grandson James, the 14th earl (1821—1881), was a representative peer for Scotland from 1858 to 1868, and was created a peer of the United Kingdom as Baron Barrogill in 1856. He was interested in scientific matters, and published *Lectures on Popular and Scientific Subjects* (1877).

The title of Lord Sinclair passed from William, the 2nd lord, who died about 1488, to John (1610—1676), who became the 9th lord in 1615. At first a covenanter, afterwards he became a royalist, and was taken prisoner at the battle of Worcester. He died without male issue and the title became dormant. His estates, however, passed to his grandson, Henry St Clair (1660—1723), the son of his daughter Catherine (d. 1666) and her husband, John St Clair of Herdmanston, and in 1677 Henry was created Lord Sinclair with the precedence of the older title. He had two sons, John Sinclair (1683—1750) the Jacobite, and James Sinclair, who became a general in the British army, and was also ambassador at Vienna and Turin and a member of parliament for many

years. After the attainder of John, in consequence of his share in the rising of 1715, the family estates were settled on James, but he resigned them to his elder brother when the latter was pardoned in 1726. The pardon, however, did not include the restoration of the title. Earlier in life John Sinclair had killed a man named Shaw in a duel and had afterwards shot this man's brother. He was tried by court-martial and sentenced to death, but was pardoned. An account of the proceedings in the court-martial was edited by Sir Walter Scott for the Roxburghe Club (Edinburgh, 1828). Sinclair himself wrote *Memoirs of the Rebellion*, published by the Roxburghe Club in 1858.

Neither of the brothers left male issue, and the title devolved upon a cousin, Charles St Clair (d. 1775), who was not included in the attainder. Charles did not claim it, but in 1782 his grandson Charles (1768—1863) was declared to be Lord Sinclair. He was a Scottish representative peer from 1807 to 1859 and is the ancestor of the present holder of the title.

Three brothers were also noted Sinclairs:—Oliver, the friend of James V. and the leader of the Scots at the rout of Solway Moss; Henry (1508—1565), bishop of Ross and president of the court of session, who made some additions to Hector Boece's *Chronicles of Scotland*; and John (d. 1566), bishop of Brechin.

See Sir R. Douglas, *The Peerage of Scotland*, new ed. by Sir J. B. Paul; G. E. (Cokayne), *Complete Peerage*; Sinclair, *The Sinclairs of England* (1887); Sir R. Gordon and G. Gordon, *The Earldom of Sutherland* (Edinburgh, 1813), and Hay, *Genealogy of the Sinclairs of Roslin* (1835).

SINCLAIR, SIR JOHN, BART. (1754—1835), Scottish writer on finance and agriculture, was the eldest son of George Sinclair of Ulbster, a member of the family of the earls of Caithness, and was born at Thurso Castle on the 10th of May 1754. After studying at Edinburgh, Glasgow and Trinity College, Oxford, he was admitted to the faculty of advocates in Scotland, and called to the English bar, but never practised. In 1780 he was returned to parliament for Caithness, and subsequently represented several English constituencies, his parliamentary career extending, with few interruptions, until 1811. He established at Edinburgh a society for the improvement of British wool, and was mainly instrumental in the creation of the Board of Agriculture, of which he was the first president. His reputation as a financier and economist had been established by the publication, in 1784, of his *History of the Public Revenue of the British Empire*; in 1793 widespread ruin was prevented by the adoption of his plan for the issue of exchequer bills; and it was on his advice that, in 1797, Pitt issued the "loyalty loan" of eighteen millions for the prosecution of the war. His services to scientific agriculture were no less conspicuous. He supervised the compilation of the valuable *Statistical Account of Scotland* (21 vols., 1791—1799), and also that of the *General Report of Scotland*, issued by the Board of Agriculture; and from the reports compiled by this society he published in 1819 his *Code of Agriculture*. He was a member of most of the continental agricultural societies, a fellow of the Royal Societies of London and Edinburgh, as well as of the Antiquarian Society of London, and president of the Highland Society in London. Originally a thorough supporter of Pitt's war policy, he later on joined the party of "armed neutrality." In 1805 he was appointed by Pitt a commissioner for the construction of roads and bridges in the N. of Scotland, in 1810 he was made a member of the privy council and, next year, received the lucrative sinecure office of commissioner of excise. He died on the 21st of December 1835.

Sir John Sinclair, who was created a baronet in 1780, was twice married, first to a daughter of Alexander Maitland, by whom he had two daughters, and secondly to Diana, daughter of the first lord Macdonald, by whom he had thirteen children. His eldest son, Sir George Sinclair (1790—1868) was a writer and a member of parliament, representing Caithness at intervals from 1811 till 1841. His son, Sir John George Tollemache Sinclair, the 3rd baronet, was member for the same constituency from 1869 to 1885. The first baronet's third son, John (1797—1875), became archdeacon of Middlesex; the fifth son, William (1804—1878), was prebendary of Chichester and was the father of William Macdonald Sinclair (b. 1850), who in 1889 became archdeacon of

London; the fourth daughter, Catherine (1800-1864), at one time enjoyed some vogue as an author.

See *Correspondence of the Right Hon. Sir John Sinclair, Bart., with Reminiscences of Distinguished Characters* (2 vols., London, 1831); and *Memoirs of the Life and Works of the Right Hon. Sir John Sinclair* (2 vols., Edinburgh, 1837).

SIND, a former province of India, now a division of the Bombay presidency. It is the most northerly portion of the presidency, lying between 23° 35' and 28° 29' N. and between 66° 40' and 71° 10' E., having an area of 53,116 sq. m. and a population (1901) of 3,410,223. It includes the six districts of Karachi, Hyderabad, Thar and Parkar, Larkhana, Sukkur and Upper Sind Frontier, together with the native state of Khairpur. It differs widely in physical features and climate, no less than in the language, dress and customs of the people, from the rest of the presidency, from which it is cut off by the deserts or the sea. It is bounded on the N. by Baluchistan and the Punjab; on the E. by the desert tracts of W. Rajputana; on the S. by the Runn of Cutch and the Indian Ocean; and on the W. by Baluchistan.

Physical features.—Sind proper, or the central alluvial plain watered by the Indus, lies between the Kohistan or hilly country that rises to the Kirthar range on the Baluchistan border, and the Registan or Thar desert that stretches E. into Rajputana. The Kohistan in years of good rainfall yields abundant fodder for cattle and camels, and supports a scanty tillage on the banks of the hill streams or *nats*, one of which, named the Hab, forms the boundary between Sind and Baluchistan. Central Sind lies on both banks of the Indus, which flows S. in a bed that has been raised by the deposit of silt above the surrounding country. Except where its bed is confined by rocks, as at Sukkur, Rohri and along the edge of the Kohistan from Lakhi to Jhirak, the river constantly changes its course, especially in the delta, the head of which is now opposite Shahbandar. Central Sind depends on the yearly inundation of the Indus, which begins to rise in March and reaches its highest point about the middle of August. The water is distributed by a very ancient system of canals, which has been greatly improved and extended since the British conquest. The soil is a plastic clay deposited by the river.

The great geographical feature in Sind is the lower Indus, which passes through the entire length of the country, first in a S.W. direction, then turning somewhat to the E., then returning to a line more directly S., and finally inclining to the W., to seek an outlet at the sea. The distant line of mountains between Sukkur and Sehwan, the steep pass overhanging the water at Lakhi, and the hill country below Sehwan give a distinctive character to the right bank. Sind has been aptly likened to Egypt. If the one depends for life and fertility on the Nile, so does the other on the Indus. The cities and towns are not so readily to be compared. Hyderabad, notwithstanding its remarkable fortress and handsome tombs, can scarcely vie in interest as a native capital with Cairo; nor can Karachi, as a Europeanized capital, be said to have attained the celebrity of Alexandria. The province contains many monuments of archaeological and architectural interest.

Owing to the deficiency of rain, the continuance of hot weather in Sind is exceptional. Lying between two monsoons, it just escapes the influence of both. The S.W. monsoon stops short at Lakhpat in Cutch, the N.W. monsoon at Karachi, and even here the annual rainfall is not reckoned at more than 6 or 8 in. At times there is no rain for two or three years, while at others there is a whole season's rainfall in one or two days. The average temperature of the summer months rises to 95° F., and the winter average is 60°, the summer maximum being 120° and the winter minimum 28°. The temperature on the sea-coast is much more equable than elsewhere. In northern Sind we find frost in winter, while both here and in Lower Sind the summer heat is extreme and prolonged. This great heat, combined with the poisonous exhalations from the pools left after the annual inundation and the decaying vegetable deposits, produces fever and ague, to which even the natives fall a prey.

Agriculture.—The salt of the delta is the only mineral product of commercial importance. Timber and fuel are supplied chiefly by the *babul* (*Acacia arabica*), *bahan* (*Populus euphratica*), *kandi* (*Prosopis spicigera*) and iron wood (*Tocoma undulata*), and fruit by the date, mango and pomegranate. The chief *rabi* or spring crops, sown from August to October and reaped from February to April, are wheat, barley, gram, oilseeds and vegetables. The chief winter

or *khari* crops, sown from May to July and reaped from October to December, are the millets (*bajri* and *juar*), rice, *urad* (*Phaseolus radiatus*), *mung* (*Phaseolus mungo*), cotton and indigo. Efforts are being made to introduce the long-stapled Egyptian cotton. Agriculture is almost entirely dependent upon irrigation from the Indus.

Manufactures.—Among the chief manufactures may be mentioned gold, silver, and silk embroideries, carpets, cloths, lacquered ware, horse-trappings and other leather-work, paper, pottery, tiles, swords and matchlocks, and the boxes and other articles of inlaid work introduced from Shiraz. Lac work, a widely extended industry in India, is also in vogue in Sind. Various coloured lac is laid in succession on the boxes while turning on the lathe, and the design is then cut through the different colours. Hyderabad was long famous for its silks and cottons, silver and gold work and lacquered ornaments, and the district could once boast of skilled workmen in arms and armour; but these old industries are now on the decline. In the cloths called *sudi*, silk is woven with the striped cotton—a practice possibly due to the large Mahomedan population of the country, as no Moslem may wear a garment of pure silk. *Chundari*, or knotting, is another method of decorating cotton and silk goods. The extension of cotton cultivation in Sind has caused a brisk development in ginning factories of recent years. The Sind cotton-printers are the most skilful and tasteful in the Bombay presidency. Cotton carpets, rugs, horse-cloths, towels and napkins are manufactured at the gaols. Woollen saddle-cloths, blankets and felts are also made. Sind produces the best pottery of India. The art was introduced or developed by the Mahomedans, whose rulers gave it every encouragement. Magnificent tombs and mosques, now in ruins, testify to the skill of the ancient potters. Leather is worked in a variety of articles, such as saddle-covers for camels and horses, shoes, leggings and accoutrements. In 1904 two new flour and rice-cleaning mills were started at Sukkur.

Trade.—The trade of Sind is carried on through Karachi with foreign countries, and across the land frontier with Afghanistan, Baluchistan and Seistan. Karachi is the great port for the grain trade of all N. India, and is also the great strategic military port for the N.W. frontier. The chief articles of import are cotton and woollen goods, iron and steel, mineral oil, sugar, tea and machinery; while the chief exports are wheat and other grains, cotton, wool, oilseeds, hides and skins, and bones. On the land frontier the chief articles of import are horses, ponies, mules, sheep and goats, woollen and cotton piece-goods, wheat, gram and pulse, rice, fruits and nuts, provisions, stores, leather, ghee, raw wool, silver, assafoetida, drugs, hides, fish, seeds, manufactured silk, spices and tobacco; while the exports are cotton twist and yarn, piece-goods, leather, metals, coal and coke, wheat, husked rice, liquors, *ghee*, sugar, tea, tobacco, wool and silver.

Fauna.—The last tiger in Sind was shot about 1885. Among other wild animals are the hyaena, the *gürkhar* or wild ass (in the S. of the Thar and Parkar district), the wolf, jackal, fox, wild hog, antelope, *pharho* or hog deer, hares and porcupines. Of birds of prey, the vulture and several varieties of falcon may be mentioned. The flamingo, pelican, stork, crane and Egyptian ibis frequent the shores of the delta. Besides these there are the *ubāra* (bustard) or *tīlūr*, the rock-grouse, quail, partridge and various kinds of parrots. Waterfowl are plentiful; in the cold season the lakes or *dhandhs* are covered with wild geese, *kulang*, ducks, teal, curlew and snipe. Among other animals to be noted are scorpions, lizards, centipedes and many snakes.

The domestic animals include camels (one-humped), buffaloes, sheep and goats, horses and asses (small but hardy), mules and bullocks. Of fish there are, on the sea-coast, sharks, saw-fish, rays and skate; cod, *sir*, *cavalho*, red-snapper, *gassir*, *begti*, *dangāra* and *buru* abound. A kind of sardine also frequents the coast. In the Indus, the finest flavoured and most plentiful fish is the *palo*, generally identified with the *hilsa* of the Ganges. *Dambhra* (*Labeo rohita*) and mullet, *morāko* (*Cirrhina mrigala*), *gandan* (*Notopterus kapirot*), *khago* or catfish (*Rita buchhanani*), *pāpri* (*Barbus sarana*), *shakūr*, *jerkho* and *singhāri* (*Macrones aor*) are also found. Otter, turtle and porpoise are frequently met with; so too are long-snouted crocodiles and water-snakes.

Forests.—The area of reserved forest in Sind is 1065 sq. m. The forests are situated for the most part on the banks of the Indus, and extend S. from near Rohri to the middle delta. They are narrow strips of land, from 2 to 3 m. in length, and ranging from 2 furlongs to 2 m. in breadth. The largest are between 9000 and 10,000 acres in area, but are subject to diminution owing to the encroachments of the stream. The wood is principally *bābul* (*Acacia arabica*), *bahan* (*Populus euphratica*) and *kandi* (*Prosopis spicigera*). The *tāli* (*Dalbergia Sissoo*) grows to some extent in Upper Sind; the iron-wood tree (*Tocoma undulata*) is found near the hills in the Mehrar districts. There are, besides, the *nim* (*Melia Azadirachta*), the *pīpal* (*Ficus religiosa*), the *bēr* (*Zizyphus Jujuba*). The delta has no forests, but its shores abound with mangrove trees. Of trees introduced are the tamarind (*Tamarindus indica*), several Australian wattle trees, the water-chestnut (*Trapa natans*), the *aula* (*Emblia officinalis*), the *bahera* (*Terminalia Bellerica*), the carob tree (*Ceratonia Siliqua*), the China tallow (*Stillingia sebifera*), the *bēl* (*Aegle Marmelos*) and the manah (*Bassia latifolia*). There is a specially organized forest department.

Irrigation.—The Indus at its source is 16,000 ft. above sea-level. At Attock it is still 2000 ft. above the sea. It is, therefore, a rapid river, which brings down a great quantity of silt from the mountains and deposits it in the Sind valley. The bed of the river is always rising, and has to be constantly watched to prevent its overflowing its banks, while the quantity of silt that the water contains makes it very valuable to the cultivator. The inundation canals of the Indus have, therefore, been carried to a high degree of perfection, though the water of the river cannot be fully utilized until the proposed barrage is constructed at Sukkur. The chief of the existing canals are: on the right bank of the Indus, the Desert, Undarwah, Begari, Mahiwah, Sukkur, Ghar, Sattah, Sind and Western Nara canals; and on the left bank the Eastern Nara, Hiral, Jamrao, Dad, Nasrat, Fuleli and Hasanali canals. Within the area watered by these canals all vegetation is luxuriant; but beyond the reach of the silt-laden waters the dry and hardened ground is almost bare.

Railways.—Sind is traversed by the North-Western railway, which follows the Indus from the Punjab to the sea at Karachi. The Indus is twice bridged: at Rohri where the main line crosses the river and a branch goes off to Quetta; and at Kotri, opposite Hyderabad, whence a narrow-gauge line was opened into Rajputana in 1900, and another branch runs S. to Budin in the delta. A chord line connects Hyderabad with Rohri, to evade the erosion of the Indus, giving an alternative route from Karachi to Quetta and the N.W. frontier. One of the main purposes of the Indus valley line is the strategic defence of that frontier.

Population.—The great majority of the inhabitants of Sind are of Hindu descent, converted to Islam. They speak a language of their own, which is akin to that of the Punjab, though retaining many archaic peculiarities. Mahommedans, who form more than three-fourths of the total, may be divided into Sindis proper and naturalized Sindis. The Sindi proper is a descendant of the original Hindu. In sect he is a Suni, though the Talpur mirs adopted the Shiah persuasion. There is, as a rule, no distinction of caste, except that followers of certain vocations—such as weavers, leather-workers, sweepers, huntsmen—are considered low and vile. The six different classes of naturalized Sindis are—the four families of the Saiyids (the Bokhari, Mathari, Shirazi and Laghari); the Afghans; the Baluchis; the slaves or Sidis—originally Africans; the Memans; and the Khwajas. More than half of the Hindus are Lohanas, originally traders, who have almost monopolised government service and the professions. Brahmans are few and unimportant. Sikhs are numerous.

Administration.—Sind is administered as a non-regulation province, under a commissioner, who resides at Karachi. The highest court, independent of the High Court at Bombay, is that of the judicial commissioner, consisting of three judges, one of whom must be a barrister specially qualified to deal with mercantile cases. The Karachi brigade, forming part of the Quetta or fourth division of the Southern army, is distributed in cantonments at Karachi, Hyderabad and Jacobabad.

History.—Sind has a history of its own, distinct from the rest of India. In the early centuries of the Christian era it was ruled by a Buddhist dynasty, with capitals at Alor and Brahmanabad. It was the first part of the peninsula to be invaded by the Mahommedans, under Mahommed bin Kasim, a general of the caliph, in 711. The invasion was by sea, from the mouth of the Indus; and for nearly three centuries Sind remained nominally subject to the Arab caliphs. Though conquered by Mahmud of Ghazni in the course of his raids into India, Sind long preserved a semi-independence under two local dynasties, the Sumras and the Sammas, both of Rajput descent but Mahommedans in religion. The latter had their capital at Tatta, in the delta of the Indus, which continued to be a seaport until the 18th century. The Sammas were followed by the Arghuns, of foreign origin, and the Arghuns by the short-lived Turkhan dynasty. It was not till the time of Akbar, who had himself been born at Umarkot in Sind, that the province was regularly incorporated in the Delhi empire. When that empire broke up on the death of Aurangzeb, local dynasties again arose. The first of these was the Kalhoras, who were succeeded by the Talpurs, of Baluch descent, who were ruling under the title of Mirs, with their capital at Hyderabad, when the British first entered into close relations with the country.

The East India Company had established a factory at Tatta in 1758; but the Talpur mirs were never friendly to trade, and the factory was withdrawn in 1775. In 1830 Alexander Burnes

was permitted to pass up the Indus on his way to the court of Ranjit Singh at Lahore, and two years later Henry Pottinger concluded a commercial treaty with the mirs. It was, however, the expedition to Afghanistan in 1838 for the restoration of Shah Shuja that forced on matters. The British army under Sir John Keane marched through Sind, and the mirs were compelled to accept a treaty by which they paid a tribute to Shah Shuja, surrendered the fort of Bukkur to the British, and allowed a steam flotilla to navigate the Indus. The crisis did not arrive till 1842, when Sir Charles Napier arrived in Sind and fresh terms were imposed on the mirs. The Baluch army resented this loss of independence, and attacked the residency near Hyderabad, which was bravely defended by Outram. Then followed the decisive battle of Meeanee and the annexation of Sind. A course of wise, firm and kindly administration inaugurated by Sir Charles Napier himself, and continued by Sir Bartle Frere, Sir W. Merewether and later commissioners, has since made the province peaceful and prosperous.

See H. M. Birdwood, *The Province of Sind* (Society of Arts, 1903); and Sir Richard Burton, *Scinde* (1851).

SINDBAD THE SAILOR, VOYAGES OF, a collection of Arabic travel-romances, partly based upon real experiences of Oriental navigators in the seas S. of Asia and E. of Africa (especially in the 8th–10th centuries); partly upon ancient poetry, Homeric and other; partly upon Indian and Persian collections of *mirabilia*. In Sindbad's First Voyage, from Bagdad and Basra, the incident of the Whale-Back Island may be compared with the Indian Ocean whales of Pliny and Solinus, covering four *jugera*, and the *pristis* sea-monster of the same authorities, 200 cubits long; Al Kazwini tells a similar tale of a colossal tortoise. Such Eastern stories are probably the original of the whale-island in the Irish travel-romance of St Brandan. With the Island of the Mares of King Mihraj, or Mihrjan, we may find (rather imperfect) parallels in Homer's *Iliad* (the mares impregnated by the wind), in Ibn Khurdadbih and Al Kazwini, and in Wolf's account of the three *Ithas de Cavallos* near Ceylon, so called from the wild horses with which they abounded, to which the Dutch East India merchants of the 17th century sometimes sent their mares for breeding purposes. Sindbad's account of the Kingdom of Mihraj (Mihrjan) is perhaps derived from the *Two Musulman Travellers* of the 9th century; it would seem to refer to one of the greater East Indian islands, perhaps Borneo. With the *Rukh* ("roc") of the Second Voyage we may compare Al Kazwini, and, more particularly, Ibn Al Wardi, who mentions the Island of the Rukh among the isles of the China Sea, and relates two incidents parallel to adventures with the rukh of Sindbad's Second and Fifth Voyages. Marco Polo in a famous passage describes this monstrous bird in detail, locates it apparently to the S. of Madagascar, and relates how one of its supposed feathers had been taken to the grand khan of the Mongols. Sindbad's Valley of Diamonds has fairly complete parallels in Al Kazwini, in Benjamin of Tudela, in Marco Polo and in the far earlier Epiphanius, bishop of Salamis in Cyprus, who died A.D. 403. As to the Mountain, or Island, of Apes in the Third Voyage, Ibn Al Wardi and Idrisi each recognizes an island of this kind, the former in the China Sea, the latter near Sokotra. Sindbad's negro cannibal adventure, next following, reproduces almost every detail of the Cyclops story in the *Odyssey*; among the Spice Islands, and perhaps at Timor, may be located the island rich in sandal-wood, where the wanderer rejoins his friends. The cannibal land of the Fourth Voyage, producing pepper and coco-nuts, where Sindbad's companions were offered food which destroyed their reason, has suggested the Andamans to some inquirers and certain districts of Sumatra to others; with this tale we may compare the lotus-eating of the *Odyssey*, Plutarch's story of Mark Antony's soldiers maddened and killed by an "insane" and fatal root in their Parthian wars, a passage in Davis's *Account of Sumatra* in 1599, and more complete parallels in Ibn Al Wardi and Al Kazwini. The burial of Sindbad in, and his escape from, the cavern of the dead is faintly foreshadowed in the story of Aristomenes, the Messenian hero, and in a reference of St Jerome to a supposed Scythian

custom of burying alive with the dead those who had been dear to them; the fully-developed Sindbad tale finds an echo in "Sir John Mandeville." For the "Old Man of the Sea," in the Fifth Voyage, we may also refer to Al Kazwini, Ibn Al Wardi and the romance of Seyf Zu-l Yezen; Sindbad's tyrannical rider has usually been explained as one of the huge apes of Borneo or Sumatra, improved to make a better story. The account of pepper, somewhat later in this Voyage, has a good deal in common with Idrisi's; Sindbad's pearl-fishing is probably to be located in the famous beds off Ceylon, of which Marco Polo has an excellent description. The romance of Seyf Zu-l Yezen has a voyage along a subterranean river similar to that of Sindbad on his Sixth Voyage; the elephant adventure of the Seventh Voyage adds another to the many stories of the elephant's sagacity which were already told in every southern country, and of which we have many examples in Pliny's *Historia Naturalis*, and in Aelian's *Historia Animalium*.

See Richard Hole, *Remarks on the Arabian Nights' Entertainments, in which the Origin of Sindbad's Voyages... is particularly considered* (London, 1797); Eusebius Renaudot's edition of the *Two Muslim Travellers* (1718, translated into English, 1733, as *Ancient Accounts of India and China by two Mahomedan Travellers... in the 9th Century*); J. T. Reinaud, *Relations des voyages faits par les Arabes et les Persans dans l'Inde et à la Chine dans le IX^e siècle* (1845); E. W. Lane's translation of the *Arabian Nights* (London, 1859), especially the notes in vol. iii. pp. 77-108; M. J. de Goeje, *La Légende de Saint Brandan* (1890); C. R. Beazley, *Dawn of Modern Geography* (1897), i. 235-238, 438-450. Besides the works noticed in the text of this article, the 12th-century *Romance of Duke Ernest of Bavaria*, written in German rhyme by Henry of Veldeck about 1160, gives parallels to Sindbad's flight through the air (tied to his rukh) in Voyage II., to the subterranean river-excursion in Voyage VI., and to some other incidents. (C. R. B.)

SINDHI (properly *Sindhī*, the language of Sindh, *i.e.* Sind) **AND LAHNDA** (properly *Lahndā* or *Lahindā*, western, or *Lahndē-dī bōlī*, the language of the west), two closely connected forms of speech belonging, together with Kashmiri (*q.v.*), to the N.W. group of the outer band of Indo-Aryan languages. In the following pages it will be assumed that the reader is familiar with the main facts stated in the articles INDO-ARYAN LANGUAGES and PRAKRIT.

In 1901 Sindhi (including Kachchhī) was spoken by 3,494,971 people, and Lahnda by 3,337,917,—the former in Sind and Cutch, and the latter in the W. Punjab and adjoining tracts (for further details on this point see the article LAHNDA). The parent Prakrit, from which Lahnda is sprung, must once have extended over the greater part of the Punjab, but, as explained under INDO-ARYAN LANGUAGES, the population of the Midland expanded so as to cover the E. and centre of that province, and the language (Panjabi) now there spoken is a mixed one, Midland in its main characteristics, but showing more and more traces of its old Lahnda basis as we go W. The wave of Midland progress exhausted itself in the barren tract of the west-central Punjab, and W. of about the seventy-third degree of E. longitude Lahnda holds decisive sway. The facts are very much the same with regard to the mixed language of Rajputana. Here the expansion of the Midland language was stopped by the desert, beyond which lies Sindhi. Lahnda and Sindhi, the W. outposts of Indo-Aryan speech, have accordingly for centuries occupied a peculiarly isolated position, and have in many respects struck out common lines of independent growth. This process was aided by the presence of Piśāca languages (see INDO-ARYAN LANGUAGES). In early times there were Piśāca colonies along the Indus, right down to its delta, and both Sindhi and Lahnda have borrowed many peculiarities from their dialects.

Sindhi is directly derived from the Vṛacāḍa Apabhraṁśa Prakrit (see PRAKRIT). The name of the Apabhraṁśa from which Lahnda is derived is not known, but it must have been closely allied to Vṛacāḍa. Sindhi has one important dialect, Kachchhī, spoken in Cutch. Here the language has come into contact with Gujarati and is somewhat mixed with that form of speech. For the dialects of Lahnda, and the various names under which that language is known, see the article LAHNDA.

Owing to their geographical position both Sind and the W. Punjab were early subject to Mahomedan inroads. The

bulk of the population is Mussulman, and their languages make free use of words borrowed from Persian and (through Persian) from Arabic. The written character employed for Lahnda is usually that modification of the Persian alphabet which has been adopted for Hindostani. The same is the case for Sindhi, except that further modifications have been introduced to represent special sounds. In both languages, Hindus also employ a script akin to the well-known Nagari alphabet (see SANSKRIT). It is the same as the "Laṇḍā" (a word distinct from "Lahndā") or "clipped" character current all over the Punjab and is very imperfect, being seldom legible to any one except its original writer, and not always so to him.

Phonetics.—The phonetic system of both languages in most respects resembles that of other Indo-Aryan vernaculars. Space will not allow us to do more than draw attention to the main points of difference. In other Indo-Aryan languages a final short vowel is generally elided. This rule is also followed in Lahnda, but the genius of Sindhi requires every word to end in a vowel, and hence these short vowels are still retained. Thus, *ṣkr. naras*, a man, Pr. *narō*, Ap. *narū*, L. *nar*, but S. *nar^u*. In Sindhi these final short vowels are, as in Kashmiri, very lightly pronounced, so that they are hardly audible to a person unacquainted with the language. They are therefore printed in these pages as small letters above the line. In the cognate Kashmiri a short *i* or *u* affects by epenthesis the pronunciation of a preceding vowel, just as in English the silent vowel *e* added to "mar" changes its pronunciation to "mare." So, in Kashmiri, *mar^u* is pronounced *mor*. Lahnda, especially when dropping the final short vowel, has similar epenthetic changes. Thus *chōhar(u)*, a boy, becomes *chōhur*; *shāhar(u)*, a city, becomes first *shāhur* and then, further, *shāhur* (*ā* like the *a* in "all"); while *chōhar(i)*, a girl, becomes *chōhir*. The oblique singular (see below) of *chōhar* is *chōhar*, for *chōhar(a)* with a final *a* instead of a final *u*, and hence the vowel of the second syllable is unchanged. Similarly, the oblique form of *shāhur* is *shāhar*, while the oblique form of *chōhir* is still *chōhir*, because it also originally ended in *i*. Similar epenthetic changes have not been noted in Sindhi. In that language and in Lahnda the short vowel *i*, when preceded or followed by *h*, or at the end of a word, is pronounced as a short *e*. Thus S. *kīharō*, of what kind, and S. *mīhī^ṣ*, a mosque, are respectively pronounced *kehāṛō* and *mehet^ṣ*. When *i* is so pronounced, it will be written as *e* or *ē* in the following pages.

In Prakrit almost the only consonants which had survived were double letters, and in most of the Indo-Aryan vernaculars these have been simplified, the preceding vowel being lengthened in compensation. Thus, Ap. *kammu*, a work, Hindostani, *kām*. In Panjabi and Lahnda the double consonant is generally retained, as in *kamm*, but in Sindhi, while the double consonant is simplified, the vowel, as in the Piśāca languages, remains short; thus, *kam^u*. This non-lengthening of the vowel in such cases is typical of Sindhi, words like S. *āg^ṣ*, fire, from Ap. *aggi*, being quite exceptional. It even happens that an original long vowel coming before a conjunct consonant is shortened when the conjunct is simplified. Thus, *ṣkr. tūryam*, S. *turī*, a trumpet.

In Sindhi, as in Piśāca, a sibilant is liable to be changed into *h*. Thus, *ṣkr. māmsam*, S. *māṣ^u* or *māh^u*, flesh; *ṣkr. dēśas*, S. *dēṣ^u* or *dēh^u*, a country. In L. the *s* is generally, but not always, preserved. As in most Indo-Aryan languages a medial *ḍ* becomes the hard *r*; thus, S. *jurāṣ^u*, to join; L. *ghōrā*, a horse. As in the Piśāca languages, there is great confusion between cerebrals and dentals. There was the same tendency in Vṛacāḍa Apabhraṁśa, and it is more common in Sindhi than in Lahnda. Thus, *ṣkr. tāmrakas*, S. *tāmō*, copper; *ṣkr. dandās*, S. *ḍand^u*, a staff. Moreover, in Sindhi, *t* and *d* become regularly cerebralized before *r*, as in Ap. *putru*, S. *puṭr^u*, a son; Ap. *drākhā*, S. *ḍrākh^u*, a vine. The cerebral *l* does not appear in Sindhi, but it has survived from Prakrit in Lahnda, being subject to the same rules as in Marathi (*q.v.*). When *l* represents a Prakrit single *l*, it becomes *l*, but if it represents a Prakrit *ḷ*, it remains a simple dental *l*. It may be remarked that the same rule seems to have applied in the Prakrit spoken by the Piśācas.

Sindhi has a series of strengthened consonants—*g*, *ḡ*, *ḍ*, and *ḍ̄*. They are pronounced "with a certain stress in prolonging and somewhat strengthening the contact of the closed organ, as if one tried to double the sound at the beginning of a word." They often, but not always, represent an original double letter. Thus, Ap. *jaggau*, S. *lāḡō*, applied; Ap. *garuau*, S. *garō*, heavy, but S. *garō*, mangy; Ap. *vijā*, S. *viḡā*, science; L. *jaṭ*, S. *jaṭ^u*, a Jat; Ap. *vaḍḍau*, S. *vaḍḍō*, great; Ap. *dōliā*, S. *dōḷā*, a sedan-chair; Ap. *dubbalu*, S. *ḍabal^u*, weak; S. *bābō*, a father, but *bāḷō*, a father's brother.

Declension.—Both languages have lost the neuter gender, all nouns being either masculine or feminine. The rules for distinguishing gender are much as in Hindostani. As in other Indo-Aryan languages, nouns may be either strong or weak, the strong forms being derived from nouns with the pleonastic Sanskrit suffix *ka* (see HINDOSTANI and MARATHI). In Sindhi a masculine weak form

¹ Abbreviations: *ṣkr.* = Sanskrit; *Pr.* = Prakrit; *Ap.* = Apabhraṁśa; *L.* = Lahnda; *S.* = Sindhi.

in ^u corresponds to the strong one in *ō*, and feminine weak forms in ^a and ^o to a strong one in *i*. In Lahnda weak forms have dropped the final short vowel, and the strong forms end in *ā* (masc.) and *ī* (fem.).

As explained in the articles above referred to, almost the only old case that has survived throughout the declension of both languages is the general oblique. This is used for any oblique case, the particular case required being as a rule further defined by the help of a postposition. The general oblique case, without any defining postposition, is specially employed for the case of the agent. There are also examples of the survival of the old locative and of the old ablative. Thus S. *math^u*, top, loc. *math^o*, on the top; L. *Ambā*, at Amb; L. *vēlā*, time, *rōṭ-dē vēlē*, at the time of food; L. *jāngil*, for *jāngali*, in the forest. This locative is of regular occurrence in the case of Sindhi weak masculine nouns in ^u. For the old ablative, we have S, *ghar^u*, L. *ghar*, a house, abl. S. *gharō*, L. *gharā*, and so others. The locative termination can be referred to the Ap. locative termination *-hi* or *-hī*, and the ablative *ā* or *ō* to the Ap. *-hā* or *-hū*. The nominative plural, and the general oblique case of both numbers are formed as in the following examples:—

Comparison is effected as in Hindostani by putting the noun with which comparison is made in the ablative case. Sometimes special postpositions are employed for this form of the ablative.

Case.	Singular.		Plural.	
	Sindhi.	Lahnda.	Sindhi.	Lahnda.
Nominative	<i>ghōrō</i>	<i>ghōrā</i>	<i>ghōrā</i>	<i>ghōrē</i>
Accusative	<i>ghōrō</i>	<i>ghōrā</i>	<i>ghōrā</i>	<i>ghōrē</i>
Agent	<i>ghōrē</i>	<i>ghōrē</i>	<i>ghōrā</i>	<i>ghōrē</i>
Dative	<i>ghōrē-khē</i>	<i>ghōrē-nū</i>	<i>ghōran^o-khē</i>	<i>ghōrē-nū</i>
Ablative	<i>ghōrā</i>	<i>ghōrē-tō</i>	<i>ghōrane</i>	<i>ghōrē-tō</i>
Genitive	<i>ghōrē-khā</i>	<i>ghōrē-dā</i>	<i>ghōran^o-khā</i>	<i>ghōrē-dā</i>
Locative	<i>ghōrē-jō</i>	<i>ghōrē-vic</i>	<i>ghōran^o-jō</i>	<i>ghōrē-vic</i>

The usual pronouns are as follows. In the Lahnda forms *ā* is pronounced as in German:—

I—S. *āṅ*, *ā*, *mā* or *mū*; L. *mā*; obl. S. *ā*, *mā*, *mū*; L. *mā*.
 We—S. *asī*; L. *assī*; obl. S. *asā*; L. *assā*. Of me, my—S. *mūh^o-jō*; L. *mērā*. Of us, our—S. *asā-jō*; L. *asāḍā*.

	Singular.				Plural.			
	Nominative.		Oblique.		Nominative.		Oblique.	
	Sindhi.	Lahnda.	Sindhi.	Lahnda.	Sindhi.	Lahnda.	Sindhi.	Lahnda.
Weak Noun—								
Masc.	<i>ghar^u</i> , a house	<i>ghar</i>	<i>ghar^a</i>	<i>ghar</i>	<i>ghar^a</i>	<i>ghar</i>	<i>gharan^o</i> , <i>gharā</i> , <i>gharē</i>	<i>gharā</i>
Fem.	<i>jibh^a</i> , a tongue	<i>jibbh</i>	<i>jibh^a</i>	<i>jibbh</i>	<i>jibhā</i> , <i>jibhā</i>	<i>jibbhā</i>	<i>jibhun^o</i> , <i>jibhā</i> , <i>jibhē</i>	<i>jibbhā</i>
“	<i>āg^o</i> , fire	<i>agg</i>	<i>āg^o</i>	<i>agg</i>	<i>āgeā</i>	<i>aggā</i>	<i>āgean^o</i> , <i>āgeā</i> , <i>āgiē</i>	<i>aggā</i>
Strong Noun—								
Masc.	<i>ghōrō</i> , a horse	<i>ghōrā</i>	<i>ghōrē</i>	<i>ghōrē</i>	<i>ghōrā</i>	<i>ghōrē</i>	<i>ghōran^o</i> , <i>ghōrā</i> , <i>ghōrē</i>	<i>ghōrē</i>
Fem.	<i>ghōrī</i> , a mare	<i>ghōrī</i>	<i>ghōrī^a</i>	<i>ghōrī</i>	<i>ghōrīā</i>	<i>ghōrīā</i>	<i>ghōrin^o</i> , <i>ghōrīā</i> , <i>ghōrīē</i>	<i>ghōrīā</i>

In Lahnda the final short vowel of the weak forms has been dropped, but in some cases the final *u* of the masculine and the final *i* of the feminine have been preserved by epenthesis, as explained under the head of phonetics. The origin of the nominative plural and of the various oblique forms is explained in the article HINDOSTANI. In the same article is discussed the derivation of most of the postpositions employed to define the various oblique forms and to make real cases. There are as follows: S. *khē*, L. *nū*, to or for; S. *khā*, L. *tō*, from; S. *jō*, *sandō*, L. *dā*, of; S. *mē*, L. *vic*, in. It will be observed that the Lahnda forms are identical with those found in Panjabi. In both languages the accusative case is the same as the nominative, unless special definiteness is required, when, as usual in Indo-Aryan vernaculars, the dative is employed in its place. The agent case is the oblique form without any postposition. The S. *khē* is a corruption of Ap. *kaahī*, Skr. *krīṭe*; and similarly *khā* from Ap. *kaahu*, Skr. *krīṭāt*. S. *sandō*, like the Rajasthani *handō* and the Kashmiri *sand^u* or *hand^u*, is by origin the present participle of the verb substantive, *ghar^o-sandō*, meaning literally “existing (in connexion) with the house,” hence “of the house.” We may compare the Bengali use of *hāṭē*, on being, to mean “from.” All these postpositions are added to the oblique form. We thus get the declension of the strong masculine noun S. *ghōrō*, L. *ghōrā*, a

Thou—S. L. *tū*; obl. S. *tō*; L. *tā*, *tā*, *tudh*. You—S. *tavhī*, *avhī*; L. *tussī*; obl. S. *tavhā*, *avhā*; L. *tussā*. Of thee, thy—S. *tūh^o-jō*; L. *tērā*. Of you, your—S. *tavh^o-jō*, *avh^o-jō*; L. *tusāḍā*, *tuhāḍā*.
 This, he, she, it—S. *hī*; L. *eh*; obl. S. *hin^a*, *in^a*; L. *is*. These, they—S. *hē*; L. *eh*, *in*; obl. S. *hin^o*, *in^o*; L. *inhā*.
 That, he, she, it—S. *hū*; L. *oh*; obl. S. *hun^o*, *un^o*; L. *unhā*.
 Those, they—S. *hō*; L. *oh*, *un*; obl. S. *hun^o*, *un^o*; L. *unhā*.
 That, he, she, it—S. *sō*; obl. *tāh^o*. Those, they—S. *sē*; obl. *tan^o*. We should expect corresponding forms for Lahnda, but they are not given in the grammars.
 Self—S. *pān^o*; L. *āpē*. Own—S. *pāh^o-jō*; L. *āpūā*. Cf. Panjabi *āp*, Kashmiri *pān^o*.
 Who—S. L. *jō*; obl. S. *jāh^o*; L. *jā*; plur. nom. S. *jē*; L. *jō*; obl. S. *jan^o*; L. *jinhā*.
 Who?—S. *kēr^u*; L. *kaun*; obl. S. *kāh^o*; L. *kā*; plur. nom. S. *kēr^o*; L. *kaun*; obl. S. *kan^o*; L. *kinhā*.
 What?—S. *chā*; L. *cā*; obl. S. *chā*; L. *kitt*.
 Any one—S. L. *kōī*; obl. S. *kāhī*; L. *kāhē*.
 The derivation of most of these forms can be gathered from the article HINDOSTANI. Others, such as *assī*, *tussī*, *pān^o*, are borrowed from Piśāca.

The north-western group of Indo-Aryan vernaculars, Sindhi, Lahnda, and Kashmiri, are distinguished by the free use which they make of pronominal suffixes. In Kashmiri these are added only to verbs, but in the other two languages they are also added to nouns. These suffixes take the place of personal pronouns in various cases and are as follows:—

	First Person.				Second Person.				Third Person.					
	Singular.		Plural.		Singular.		Plural.		Singular.			Plural.		
	Nom.	Other Cases.	Nom.	Other Cases.	Nom.	Other Cases.	Nom.	Other Cases.	Nom.	Agent.	Other Cases.	Nom.	Agent.	Other Cases.
Sindhi	<i>s^o</i>	<i>m^o</i> , <i>mā</i>	<i>sī</i>	<i>ā</i> , <i>hā</i> (not as gen.)	<i>ē</i>	<i>o</i>	<i>u</i>	<i>v^a</i>	None	<i>ī</i>	<i>s^o</i>	None	<i>ā</i>	<i>n^o</i> , <i>n^a</i>
Lahnda	<i>m</i>	<i>m</i>	<i>sē</i>	<i>sē</i>	<i>ī</i>	<i>ī</i>	<i>vē</i>	<i>vē</i>	None	<i>s</i>	<i>s</i>	None	<i>nē</i>	<i>nē</i>

horse, as shown in the next column. When there are optional methods of making the oblique form only one is given. The others can be employed in the same way.

As in most other Indo-Aryan vernaculars, the genitive is really a possessive adjective, and agrees with the person or thing possessed in gender, number and case, exactly as in Panjabi.

An adjective agrees with its qualified noun in gender, number and case. In Lahnda, as in Hindostani, the only adjectives which change in these respects are strong adjectives in *ā*. In Sindhi weak forms in ^u also change the ^u to ^o or ^a in the feminine. Thus, S. *canō*, L. *cangā*, good, fem. S. *canī*, L. *cangī*; S. *nidhar^o*, helpless, fem. *nidhar^a* or *nidhar^o*. The plural and oblique forms are made as in the case of nouns. If a postposition is used with the noun it is not also used with the adjective. Thus, L. *cangiā ghōrīā-dā*, of good mares.

All these suffixes are remnants of the full pronominal forms. In all cases they can be at once explained by a reference to the originals in Piśāca, rather than to those of other Indo-Aryan languages.¹ It will here be convenient to consider them only in connexion with nouns. In such cases they are usually in the genitive case. Thus, S. *piu*, a father; *pium^o*, my father; *piu^o*, thy father; *piu^o*, your father; *pius^o*, his father; *piun^o* or *piun^o*, their father. There being in Sindhi no suffix of the genitive plural of the first personal pronoun, there is no compound for “our father.” For that, as in the beginning of the Lord’s Prayer, we must employ the full expression, *asī-jō piu*. In Lahnda we have *piū*, a father; *pium*, my

¹ See G. A. Grierson, *The Piśāca Languages of North-Western India* (London, 1906), pp. 44 ff.

father; *piūsē*, our father; *piū*, thy father; *piūvē*, your father; *pius*, his father; *piūnē*, their father. A junction vowel is often inserted between these suffixes and the main word to assist the pronunciation. Further examples will be found under the head of verbs.

Conjugation.—As in Marathi (*q.v.*) there are, in both languages, two conjugations, of which one (intransitive) has *-a-* and the other (transitive) *-e-* or *-i-* for its characteristic letter. The differences appear in the present participle and, in Sindhi, also in the conjunctive participle, the present subjunctive and imperative. The two latter are the only original synthetic tenses which have survived in Sindhi, but in Lahnda the old synthetic future is also in common use. Both languages have a passive voice formed by adding *ij* or *ṛj* to the root. This form is not employed for the past participle or for tenses derived from it. The following are the principal parts of the regular verb in each conjugation:—

	First Conjugation.		Second Conjugation.	
	Sindhi.	Lahnda.	Sindhi.	Lahnda.
Infinitive	<i>halanⁿ</i>	<i>halan</i> , to go.	<i>māranⁿ</i>	<i>māran</i> , to kill.
Present participle	<i>halandō</i>	<i>haldā</i> , going.	<i>mārindō</i>	<i>mārēndō</i> , killing.
Past participle	<i>haliō</i>	<i>haleā</i> , gone.	<i>māriō</i>	<i>māreā</i> , killed.
Conjunctive participle	<i>halī</i>	<i>halī</i> , having gone.	<i>mārē</i>	<i>mārī</i> , having killed.

It will be observed that, as in most other Indo-Aryan vernaculars, the past participle of the transitive verb is passive in signification. There is therefore no need of a past participle for the passive voice. The Sindhi present participle of the passive voice follows a different rule of formation, and, in Lahnda, it omits the letter *j*, thus *S. māribō* (Pr. *māriavvāō*), *L. māriṇdā*, being killed. In other respects the passive, *S. mārijanⁿ*, *L. mārijan*, to be killed, is conjugated like a regular verb of the first conjugation. The passive is directly derived from the Outer Prakrit passive in *-ijja-*. The origin of the other forms is dealt with under HINDOSTANI and MARATHI.

The present subjunctive is the direct descendant of the old Prakrit (*q.v.*) present indicative. It is conjugated as follows:—

Person.	Singular.				Plural.			
	First Conjugation.		Second Conjugation.		First Conjugation.		Second Conjugation.	
	Sindhi and Lahnda.	Sindhi.	Lahnda.	Sindhi.	Lahnda.	Sindhi.	Lahnda.	
1.	<i>halā</i>	<i>māriā</i>	<i>mārā</i>	<i>halā</i>	<i>halā</i>	<i>māriā</i>	<i>mārā</i>	
2.	<i>halē</i>	<i>māriē</i>	<i>mārē</i>	<i>halō</i>	<i>halō</i>	<i>māriō</i>	<i>mārō</i>	
3.	<i>halē</i>	<i>māriē</i>	<i>mārē</i>	<i>halan^e</i>	<i>halin</i>	<i>mārin^e</i>	<i>mārin</i>	

The imperative is formed very similarly. In Lahnda the future is *mārēṣā* (Pr. *māriṣam*), I shall kill, conjugated like *mārā*. The Sindhi future is formed by adding the nominative pronominal suffixes to the present participle. It will be remembered that there are no nominative suffixes of the third person. For that person, therefore, the simple participle is employed. There are slight euphonic changes of the termination of the participle in the other persons. Thus, *halandō*, he will go; *halandus^e*, I shall go; and so on.

The past tense is formed from the past participle, with pronominal suffixes added in both languages. As in the transitive verb the past participle is passive in signification, the subject (see article HINDOSTANI) must be put in the agent case, and the participle agrees in gender and number with the direct object, or, if the object is put in the dative case instead of the accusative, is treated impersonally in the masculine. Examples of this tense are:—

Intransitive verb—*S. haliō*, *L. haleā*, he went; *S. L. halī*, she went; *S. haliu-s^e*, *L. haleu-m*, I (masc.) went; *S. haliu-s^e*, *L. haliu-m*, I (fem.) went, and so on.

Transitive verb—*S. māriō*, *L. māreā*, he was killed; *S. L. māri*, she was killed; *S. māriu-m^e*, *L. māreu-m*, he was killed by me, I killed him; *S. māria-m^e*, *L. māriu-m*, she was killed by me, I killed her; *S. pātishāh^a saji gālh^e būdhāi*, the-whole matter (fem.) was-related (fem.) by-the-king (agent), the king related the whole matter; *S. iāh-khē sāth^a chaqōiō*, with-reference-to-her, by-the-caravan, it-was-abandoned (impersonal), *i.e.* the caravan abandoned her.

There are numerous compound tenses formed by conjugating the verb substantive with one or other of the participles. The usual forms of the present and past of this verb are as follows:—

Person.	Present, "I am," &c. (com. gen.).				Past, "I was," &c. (masc.).			
	Singular.		Plural.		Singular.		Plural.	
	Sindhi.	Lahnda.	Sindhi.	Lahnda.	Sindhi.	Lahnda.	Sindhi.	Lahnda.
1.	<i>āhiyā</i>	<i>hā</i>	<i>āhiyā</i>	<i>hā</i>	<i>hōs^e</i>	<i>hāus</i>	<i>huāsā</i>	<i>hāsē</i>
2.	<i>āhē</i>	<i>hē</i>	<i>āhiyō</i>	<i>hō</i>	<i>huē</i>	<i>hāē</i>	<i>huaⁿ</i>	<i>havē</i>
3.	<i>āhē</i>	<i>hē</i>	<i>āhin^e</i>	<i>hin</i>	<i>hō</i>	<i>hā</i>	<i>hā</i>	<i>hāin</i>

The past has slightly different forms with a feminine subject. Sindhi examples of the compound tenses are *halandō āhiyā*, I am going; *halandō hōs^e*, I was going; *haliō āhiyā*, I have gone; and so on. The Lahnda tenses are made on the same principles.

We have seen the important part that pronominal suffixes play in the conjugation of the verb. But their use is not confined to the examples given above. Additional suffixes may be added to indicate the object, direct or remote. Thus, *S. māriē*, thou mayest kill; *māriē-m^e*, thou mayest kill me; *māriō* (he) was killed; *māriō-ī* (for *māriō-ī*), (he) was killed by-him, he killed him; *māriō-ī-m^e*, it (impersonal)-was killed by-him with-reference-to-me, *i.e.* he killed me; *ḍinā-ī-s^e*, was-given by-him to-him, he gave to him.

Numerous verbs have irregular past participles, derived directly from the Prakrit past participles, instead of being made by adding *-iō* to the root. These must be learnt from the grammars. We may mention a few very common ones: *S. karānⁿ*, *L. karān*, to do, to make, past participle *S. kiō*, *kūō*, *L. kiā*; *S. ḍiānⁿ*, *L. ḍān*, to give, past participle *S. ḍinō*, *L. ḍitā*; *S. labhanⁿ*, *L. labhan*, to be obtained, past participle *S. ladhō*, *L. laddhā*. The many compound verbs are formed much as in Hindostani, and must be learnt from the grammars.

LITERATURE.—Sindhi and Lahnda possess no literature worthy of the name. Such as they have consists of translations from Arabic and Persian. There is, however, as usual in uncultivated dialects, in both languages a large stock of folk-songs—rude poems dealing with the popular traditions of the country. Some of these have been published in Colonel Sir Richard Temple's *Legends of the Panjab* (3 vols., Bombay, 1884-1900). The late Professor Trumpp published one text of some importance under the title of *Sindhi Literature*, the *Divān of Abd-ul-Latif*, known by the name of *Shāha jō Risālō* (Leipzig, 1866).

AUTHORITIES.—G. A. Grierson, "Vrācaḍa and Sindhi," in *Journal of the Royal Asiatic Society* (1902), p. 47; G. Stack, *Grammar and Dictionary* (both Bombay, 1849); E. Trumpp, *Grammar* (London and Leipzig, 1872). This last is still the standard work on the language, although

much of the philological portion is now out of date. It was the pioneer of the comparative study of the modern Indo-Aryan vernaculars. G. Shirt, Udham Thavurdas and S. F. Mirza, *Sindhi-English Dictionary* (Karachi, 1879).

W. St Clair Tisdall's *Simplified Panjabi Grammar* (London, 1889) also deals, in an appendix, with Lahnda. E. O'Brien, *Glossary of the Multani Language* (1st ed., Lahore, 1881; 2nd ed., revised by J. Wilson and Hari Kishen Kaul, Lahore, 1903); T. Bomford, "Rough Notes on the Grammar of the Language spoken in the Western Panjab," in *Journal of the Asiatic Society of Bengal*, vol. lxiv. (1895), pt. i. pp. 290 ff.; the same, "Pronominal Adjuncts in the Language spoken in the Western and Southern Parts of the Panjab," *ib.* vol. lxxi. (1897), pt. i. pp. 146 ff.; A. Jukes, *Dictionary of the Jatki or Western Panjabi Language* (Lahore and London, 1900); J. Wilson, *Grammar and Dictionary of Western Panjabi as spoken in the Shahpur District* (Lahore, 1899).

For both languages the authorities quoted under the articles INDO-ARYAN LANGUAGES and PRAKRIT may be consulted with advantage. Vol. viii. of the *Linguistic Survey of India* contains full particulars of both in great detail. (G. A. GR.)

SIN-EATER, a man who for trifling payment was believed to take upon himself, by means of food and drink, the sins of a deceased person. The custom was once common in many parts of England and in the highlands of Scotland, and survived until recent years in Wales and the counties of Shropshire and Herefordshire. Usually each village had its official sin-eater to whom notice was given as soon as a death occurred. He at once went to the house, and there, a stool being brought, he sat down in front of the door. A goat, a crust of bread and a bowl of ale were handed him, and after he had eaten and drunk he rose and pronounced the ease and rest of the dead person, for whom he thus pawned his own soul. The earlier form seems to have been more realistic, the sin-eater being taken into the death-chamber, and a piece of bread and possibly cheese having been placed on the

breast of the corpse by a relative, usually a woman, it was afterwards handed to the sin-eater, who ate it in the presence of the dead. He was then handed his fee, and at once hustled and thrust out of the house amid execrations, and a shower of sticks, cinders or whatever other missiles were handy. The custom

of sin-eating is generally supposed to be derived from the scapegoat (*q.v.*) in Leviticus xvi. 21, 22. A symbolic survival of it was witnessed as recently as 1893 at Market Drayton, Shropshire. After a preliminary service had been held over the coffin in the house, a woman poured out a glass of wine for each bearer and handed it to him across the coffin with a "funeral biscuit." In Upper Bavaria sin-eating still survives: a corpse cake is placed on the breast of the dead and then eaten by the nearest relative, while in the Balkan peninsula a small bread image of the deceased is made and eaten by the survivors of the family. The Dutch *doed-koecks* or "dead-cakes," marked with the initials of the deceased, introduced into America in the 17th century, were long given to the attendants at funerals in old New York. The "burial-cakes" which are still made in parts of rural England, for example Lincolnshire and Cumberland, are almost certainly a relic of sin-eating.

SINECURE (Lat. *sine cura*, without care), properly a term of ecclesiastical law, for a benefice without the cure of souls (*beneficium sine cura*). In the English Church such sinecures arise when the rector has no cure of souls nor resides in the parish, the work of the incumbent being performed by a vicar; such sinecure rectories were expressly granted by the patron; they were abolished by the Ecclesiastical Commissioners Act 1840. Other ecclesiastical sinecures are certain cathedral dignities to which no spiritual function attached or incumbencies where by reason of depopulation and the like the parishioners have disappeared or the parish church has been allowed to decay. Such cases have ceased to exist. The term is also used of any office or place, to which a salary, emoluments or dignity but no duties are attached. The British civil service and royal household were loaded with innumerable offices which by lapse of time had become sinecures and were only kept as the reward of political services or to secure voting power in parliament. They were extremely prevalent in the 18th century and were gradually abolished by statutes during that and the following century.

SINEW (O. Eng. *sinu*, *sionu*, cf. Dutch *zenuw*, Ger. *Sehne*, possibly allied to Skt. *snava*, tendon, cf. Ger. *Schnur*, string), a tendon, a cord-like layer of fibrous tissue at the end of a muscle forming the attachment to the bone or other hard part. The broad, flat tendons are usually called *fasciae* (see MUSCULAR SYSTEM AND CONNECTIVE TISSUE). The word is used figuratively of muscular or nervous strength, and particularly, in "sinews of war," of the power of money.

SINGAPORE (Malay, *Singapura*, *i.e.* "The City of the Lion"), a town and island situated at the S. extremity of the Malay Peninsula in 1° 20' N., 103° 50' E. Singapore is the most important part of the crown colony of the Straits Settlements, which consists with it of Penang, Province Wellesley and the Dindings, and Malacca. The port is one of the most valuable of the minor possessions of Great Britain, as it lies midway between India and China, and thus forms the most important halting-place on the great trading-route to the Far East. It is strongly fortified by forts and guns of modern type upon which large sums have been expended by the imperial government, aided by a heavy annual military contribution payable by the colony and fixed at 20% of its gross revenue. Its geographical position gives it strategic value as a naval base; and as a commercial centre it is without a rival in this part of Asia. Its prosperity has been greatly enhanced by the rapid development of the Federated Malay States on the mainland. It possesses a good harbour; docks and extensive coaling-wharves, which have been acquired by government from the Tanjong Pagar Dock Company, and are undergoing considerable extensions; an admiralty dockyard; and many facilities for shipping. It is also resorted to by native sailing craft from all parts of the Malay Archipelago. On the island of Pūlau Brani stand the largest tin-smelting works in existence, which for many years have annually passed through their furnaces more than half the total tin output of the world. Singapore has also establishments for tinning pineapples, and a large biscuit factory. The town possesses few buildings of any note, but government

house, the law-courts, the gaol, the lunatic asylum and the Hong-Kong and Shanghai Bank are exceptions, as also is the cathedral of St Andrew. There are three Roman Catholic churches, a Free Kirk, an American mission, and several chapels belonging to Nonconformist sects. The mosques and Chinese and Hindu temples are numerous. There are extensive military barracks at Tanglin. There is a good race-course and polo-ground, a fine cricket-ground on the esplanade, three golf courses, and several clubs.

The island is 27 m. long by 14 m. broad, and is separated from the native state of Johor, situated on the mainland of the Malay Peninsula, by a strait which, at its narrowest point, is less than $\frac{1}{2}$ m. in width. A line of railway connects the town of Singapore with the spot on the strait opposite to the town of Johor Bharu. The strait which divides the island from the Dutch islands of Bintang, Rhio, &c., bears the name of the Singapore Strait. The surface of the island is undulating and diversified by low hills, the highest point being Bukit Timah, on the N.W. of the town, which is a little over 500 ft. in altitude. Geologically, the core of the island consists of crystalline rocks; but in the W. there are shales, conglomerates and sandstones; and all round the island the valleys are filled with alluvial deposits on a much more extensive scale than might have been looked for seeing that no river in the island has a course longer than some 6 m. The S.W. shores are fringed with coral reefs, and living coral fields are found in many parts of the straits. Being composed largely of red clays and laterite, the soil is not generally rich, and calls for the patient cultivation of the Chinese gardener to make it really productive. There is a forest reserve near the centre of the island, but the forest is of a mean type. The humid climate causes the foliage here, as in other parts of Malaya, to be very luxuriant, and the contrast presented by the bright green on every side and the rich red laterite of the roads is striking. When it was first occupied by Sir Stanford Raffles, on behalf of the East India Company, the island was covered by jungle, but now all the land not reserved by government has been taken up, principally by Chinese, who plant vegetables in large quantities, indigo and other tropical products. There are fine botanical gardens at Tanglin on the outskirts of the town.

Climate.—The climate of Singapore is always humid and usually very hot. There is hardly any seasonal change to be observed, and the dampness of the climate causes the heat to be more oppressive than are higher temperatures in drier climates. The mean atmospheric pressure in Singapore during 1906 was 29.908 in. The highest shade temperature for the year was 92° F. registered in March; the lowest 72.5° F., registered in November. The mean was 80.3° F. The range for the year was 14.5° F. The temperature of solar radiation was in 1906: highest in the sun 153.8°, recorded in March; the lowest 143.4°, recorded in June. The highest temperature of nocturnal radiation on grass was 73.1°, recorded in May, and the lowest 67.2°, recorded in January. The mean for 1906 was 71°. Relative humidity: highest 92, recorded in December; lowest, 72, recorded in April; mean for 1906, 81. N. and N.E. winds prevail from the middle of October to the end of April, and S. and S.W. winds from the middle of May to the end of September. The mean velocity of winds for 1906 was 110 m.; the maximum recorded being 148 in May, the minimum velocity recorded being 76 in December. The rainfall of Singapore for 1906 was 129.64 in.; the heaviest rainfall for any one month being 15.23 in. recorded in January, the smallest being 4.98 in. recorded in May. There were 182 rainy days during the year, the average annual number of the past decade being 176.

Population.—The following shows the composition of the population, which numbered in all 228,555 in 1901: Europeans 3824, Eurasians 4120, Chinese 164,041, Malays 36,080, Indians, 17,823, other nationalities 2667. The births registered in Singapore during 1898 numbered 3751, namely, 1960 males and 1791 females, being a ratio of 16.55 per mille. The deaths registered during the same period numbered 7602, namely, 5894 males and 1708 females, a ratio of 33.54 per mille. The excess of deaths over births is due to the fact that there are comparatively few women among the Chinese; the steady increase of the population in the face of this fact is to be attributed entirely to immigration, mainly from China, but to a minor extent from India also. The persons classed above under "other nationalities" are representatives of almost every Asiatic nation of importance, and of many African races, Singapore being one of the most cosmopolitan cities in the world.

Administration and Trade.—As Singapore is the chief administrative

Singapore
Island.

centre of the colony, the governor, who is also *ex officio* high commissioner of the Federated Malay States, British North Borneo, Brunei, Sarawak and governor of Labuan, has his principal residence here. Here also are chief offices of the various heads of the government departments, and here the legislative council of the colony holds its sessions. The town is governed by a municipality composed partly of *ex officio*, nominated and elected members.

Finance.—The revenue of Singapore for 1906 amounted to \$5,942,661, exclusive of \$26,650 received on account of land sales. The chief sources of revenue were licences (which include the farms let for the collection of import duties in opium, wine and spirits) \$4,248,856, nearly half the revenue of the settlement; post and telegraphs \$424,645; railway receipts \$196,683; and land revenue \$104,482. The expenditure of the settlement during 1906 amounted to \$5,392,380. Of this \$1,416,392 was expended on personal emoluments, and \$1,116,548 on other charges connected with the administrative establishments; \$1,763,488 was spent on military services, exclusive of expenses connected with the volunteer force; \$183,075 on the upkeep and maintenance of existing public works; and \$569,884 on new public works.

Trade.—The trade of Singapore is chiefly dependent upon the position which the port occupies as the principal emporium of the Federated Malay States and of the Malayan archipelago, and as the great port of call for ships passing to and from the Far East. The total value of the imports into Singapore in 1906 was \$234,701,760, and the exports in the same year were valued at \$202,210,849. The ships using the port during 1906 numbered 1886 with an aggregate tonnage of 3,805,566 tons, of which 1261 were British with an aggregate tonnage of 2,498,968 tons. The retail trade of the place is largely in the hands of Chinese, Indian and Arab traders, but there are some good European stores. The port is a free port, import duties being payable only on opium, wines and spirits.

History.—A tradition is extant to the effect that Singapore was an important trading centre in the 12th and 13th centuries, but neither Marco Polo nor Ibn Bātuta, both of whom wintered in Sumatra on their way back to Europe from China, have left anything on record confirmatory of this. It is said to have been attacked and devastated by the Javanese in 1252, and at the time when it passed by treaty to the East India Company in 1819, Sir Stamford Raffles persuading the sultan and tumenggong of Johor to cede it to him, it was wholly uninhabited save by a few fisherfolk living along its shores. It was at first subordinate to Benkulen, the company's principal station in Sumatra, but in 1823 it was placed under the administration of Bengal. It was incorporated in the colony of the Straits Settlements when that colony was established in 1826.

See *Life of Sir Stamford Raffles*; Logan's *Journal of the Malay Archipelago*; the *Journal of the Straits Branch of the Royal Asiatic Society* (Singapore); Sir Frank Swettenham, *British Malaya* (London, 1906); *Blue-Book of the Straits Settlements* (1906); *The Straits Directory, 1908* (Singapore, 1908). (H. C.)

SINGER, SIMEON (1846–1906), Jewish preacher, lecturer and public worker. He was born in London, and after a short stay at a Hungarian school, entered as one of its pupils the Jews' College, of which he was subsequently for a time the headmaster. In 1867 he became minister of the Borough Synagogue, London. In the following year he married. He moved to the new West End Synagogue in 1878, and remained the minister of that congregation until his death. He was the first to introduce regular sermons to children; as a preacher to the young Singer showed rare gifts. His pulpit addresses in general won wide appreciation, and his services were often called for at public functions. In 1897 he strongly opposed the Diggle policy at the London School Board, but he refused nomination as a member. In 1890 the Rabbinical Diploma was conferred on him by Lector Weiss of Vienna, but again he evidenced his self-denial by declining to stand for the post of associate Chief Rabbi in the same year. Singer was a power in the community in the direction of moderate progress; he was a lover of tradition, yet at the same time he recognized the necessity of well-considered changes. In 1892 at his instigation the first English Conference of Jewish Preachers was held, and some reforms were then and at other times introduced, such as the introduction of Bible Readings in English, the admission of women as choristers and the inclusion of the express consent of the bride as well as the bridegroom at the marriage ceremony.

Singer did much to reunite Conservatives and Liberals in the community, and he himself preached at the Reform Synagogue in Manchester. He had no love for the minute critical analysis of the Bible, but he was attracted to the theory of progressive revelation, and thus was favourably disposed to the modern treatment of the Old Testament. His cheery optimism was at the basis of this

attitude, and strongly coloured his belief in the Messianic ideals. He held aloof, for this very reason, from all Zionist schemes. His interest in the fortunes of foreign Jews led him to make several continental journeys on their behalf; he was one of the leading spirits of the Russo-Jewish Committee, of the International Jewish Society for the Protection of Women and of other philanthropic organizations. Despite his devotion to public work, Singer published some important works. In 1896 the Cambridge University Press published *Talmudical Fragments in the Bodleian Library* of which Singer was joint author. But his most famous work was his new edition and English translation of the *Authorized Daily Prayer Book* (first published in 1870), a work which has gone through many large editions and which has probably been the most popular (both with Jews and Christians) of all books published by an English Jew.

See *The Literary Remains of the Rev. Simeon Singer* (3 vols., 1908), with Memoir. (I. A.)

SINGHBHUM, a district of British India, in the Chota Nagpur division of Bengal. The administrative headquarters are at Chaibasa. Area 3891 sq. m. Its central portion consists of a long undulating tract of country, running E. and W., and enclosed by great hill ranges. The depressions lying between the ridges comprise the most fertile part, which varies in elevation above sea-level from 400 ft. near the Subanrekha on the E. to 750 ft. around the station of Chaibasa. S. of this an elevated plateau of 700 sq. m. rises to upwards of 1000 ft. In the W. is an extensive mountainous tract, sparsely inhabited by the wildest of the Hos; while in the extreme S.W. is a still grander mass of mountains, known as "Saranda of the seven hundred hills," rising to a height of 3500 ft. From the Layada range on the N.W. of Singhbhum many rocky spurs strike out into the district, some attaining an elevation of 2900 ft. Among other ranges and peaks are the Chaitanpur range, reaching an elevation of 2529 ft., and the Kapargadi range, rising abruptly from the plain and running in a S.E. direction until it culminates in Tuiligar Hill (2492 ft.). The principal rivers are the Subanrekha, which with its affluents flows through the E. of the district; the South Koel, which rises W. of Ranchi, and drains the Saranda region; and the Baitarani, which touches the S. border for 8 m. About two-thirds of Singhbhum district is covered with primeval forest, containing some valuable timber trees; in the forests tigers, leopards, bears and several kinds of deer abound, and small herds of elephants occasionally wander from the Meghasani Hills in Mayurbhanj.

In 1901 the population was 613,579, showing an increase of 12% in the decade. More than one-half belong to aboriginal tribes, mostly Hos. The chief crop is rice, followed by pulses, oil-seeds and maize. There are three missions in the district—S.P.G., Lutheran and Roman Catholic—which have been very successful among the aboriginal tribes, especially in the spread of education. The isolation of Singhbhum has been broken by the opening of the Bengal-Nagpur railway, which has protected it from the danger of famine, and at the same time given a value to its jungle products.

Colonel Dalton, in his *Ethnology of Bengal*, says that the Singhbhum Rajput chiefs have been known to the British government since 1803, when the marquess Wellesley was governor-general of India; but there does not appear to have been any intercourse between British officials and the people of the Kolhan previous to 1819. The Hos or Larka Kols, the aboriginal race of Singhbhum, would allow no stranger to settle in, or even pass through, the Kolhan; they were, however, subjugated in 1836, when the head-men entered into engagements to bear allegiance to the British government. The country remained tranquil and prosperous until 1857, when a rebellion took place among the Hos under Parahat Raja. After a tedious campaign they surrendered in 1859, and the capture of the raja put a stop to their disturbances.

SINGLE-STICK, a slender, round stick of ash about 34 in. long and thicker at one end than the other, used as a weapon of attack and defence, the thicker end being thrust through a cup-shaped hilt of basket-work to protect the hand. The original form of the single-stick was the "waster," which appeared in the 16th century and was merely a wooden sword used in practice for the back-sword (see SABRE-FENCING), and of the same general shape. By the first quarter of the 17th century wasters had become simple cudgels provided with sword-guards, and when, about twenty-five years later, the basket-hilt came into general use, it was

employed with the cudgel also, the heavy metal hilt of the back-sword being discarded in favour of one of wicker-work. The guards, cuts and parries in single-stick play were at first identical with those of back-sword play, no thrusts being allowed (see FENCING). The old idea, prevalent in England in the 16th century, that hits below the girdle were unfair, disappeared in the 18th century, and all parts of the person were attacked. Under the first and second Georges back-sword play with sticks was immensely popular under the names "cudgel-play" and "single-sticking," not only in the cities but in the country districts as well, wrestling being its only rival. Towards the end of the 18th century the play became very restricted. The players were placed near together, the feet remaining immovable and all strokes being delivered with a whip-like action of the wrist from a high hanging guard, the hand being held above the head. Blows on any part of the body above the waist were allowed, but all except those aimed at the head were employed only to gain openings, as each bout was decided only by a "broken head," i.e. a cut on the head that drew blood. At first the left hand and arm were used to ward off blows not parried with the stick, but near the close of the 18th century the left hand grasped a scarf tied loosely round the left thigh, the elbow being raised to protect the face. Thomas Hughes's story, *Tom Brown's School Days*, contains a spirited description of cudgel-play during the first half of the 19th century. This kind of single-sticking practically died out during the third quarter of that century, but was revived as a school for the sabre, the play being essentially the same as for that weapon (see SABRE-FENCING). The point was introduced and leg hits were allowed. By the beginning of the 20th century single-stick play had become much neglected, the introduction of the light Italian fencing sabre having rendered it less necessary. Stick-play with wooden swords as a school for the cutlas is common in some navies. The French cane-fencing (*q.v.*) has a general similarity to single-stick play, but is designed more for defence with a walking-stick than as a school for the sabre.

See *Broadsword and Single-stick*, by R. G. Allanson Winn and C. Phillips-Wolley (London, 1898); *Manual of Instruction for Single-stick Drill* (London, 1887, British War Office); *Schools and Masters of Fence*, by Egerton Castle (London, 1892); *The Sword and the Centuries*, by A. Hutton (London, 1901).

SINGORA, or SONGKLA (the *Sangore* of early navigators), a port on the E. coast of the Malay Peninsula and the headquarters of the high commissioner of the Siamese division of Nakhon Sri Tammarat. It is situated in 7° 12' N. and 100° 35' E. It was settled at the beginning of the 19th century by Chinese from Amoy, the leader of whom was appointed by Siam to be governor of the town and district. Having been more than once sacked by Malay pirates, the town was encircled, about 1850, by a strong wall, which, as both Chinese governors and Malay pirates, are now things of the past, supplies the public works department with good road metal. The population, about 5000, Chinese, Siamese and a few Malays, is stationary, and the same may be said of the trade, which is all carried in Chinese junks. The town has become an important administrative centre; good roads connect it with Kedah and other places in the Peninsula, and the mining is developed in the interior. In 1906 railways surveys were undertaken by the government with a view to making Singora the port for S. Siam; but this harbour, formed by the entrance to the inland sea of Patalung, would require dredging to be available for vessels of any size.

SINOPE, Turk. Sinüb, a town on the N. coast of Asia Minor in the vilayet of Kastamüni, on a low isthmus which joins the promontory of Boz Tepé to the mainland. Though it possesses the only safe roadstead between the Bosphorus and Batum, the difficulties of communication with the interior, and the rivalry of Ineboli on the W. and Samsun on the E. have prevented Sinope from becoming a great commercial centre. It is shut off from the plateau by forest-clad mountains; a carriage road over the hills to Boiavad and thence by Vezir-Keupru to Amasia was begun about 20 years ago, but has never been completed even as far as Boiavad. Consequently the trade is small; the annual exports are about £80,000, and the imports £50,000. Population, 5000 Moslems and 4000 Christians, chiefly Greeks

and Armenians. On the isthmus, towards the mainland, stands a huge but for the most part ruined castle, originally Byzantine and afterwards strengthened by the Seljuk sultans; and the Mahommedan quarter is surrounded by massive walls. Of early Roman or Greek antiquities there are only the columns, architraves and inscribed stones built into the old walls; but the ancient local coinage furnishes a very beautiful and interesting series of types.

See M. Six's paper in the *Numismatic Chronicle* (1885), and MM. Babelon & Reinach, *Recueil des monnaies grecques d'Asie Mineure* (1904).

Sinope (*Σινώπη*), whose origin was assigned by its ancient inhabitants to Autolykus, a companion of Hercules, was founded 630 B.C. by the Ionians of Miletus, and ultimately became the most flourishing Greek settlement on the Euxine, as it was the terminus of a great caravan route from the Euphrates, through Pteria, to the Black Sea, over which were brought the products of Central Asia and Cappadocia (whence came the famous "Sinopic" red earth). In the 5th century B.C. it received a colony of Athenians; and by the 4th it had extended its authority over a considerable tract of country. Its fleet was dominant in the Euxine, except towards the W., where it shared the field with Byzantium. When in 220 B.C. Sinope was attacked by the king of Pontus, the Rhodians enabled it to maintain its independence. But where Mithradates IV. failed Pharnaces succeeded; and the city, taken by surprise in 183 B.C., became the capital of the Pontic monarchy. Under Mithradates VI. the Great, who was born in Sinope, it had just been raised to the highest degree of prosperity, with fine buildings, naval arsenals and well-built harbours, when it was captured by Lucullus and nearly destroyed by fire (70 B.C.). In 64 B.C. the body of the murdered Mithradates was brought home to the royal mausoleum. Under Julius Caesar the city received a Roman colony, but was already declining with the diversion of traffic to Ephesus, the port for Rome, and in part to Amisos (Samsun). In the middle ages it became subject to the Greek Empire of Trebizond, and passed into the hands of the Seljuk Turks, and in 1461 was incorporated in the Ottoman Empire. In November 1853 the Russian vice-admiral Nakhimov destroyed here a division of the Turkish fleet and reduced a good part of the town to ashes.

(J. G. C. A.)

SINTER, a word taken from the German (allied to Eng. "cinder") and applied to certain mineral deposits, more or less porous or vesicular in texture. At least two kinds of sinter are recognized—one siliceous, the other calcareous. Siliceous sinter is a deposit of opaline or amorphous silica from hot springs and geysers, occurring as an incrustation around the springs, and sometimes forming conical mounds or terraces. The pink and white sinter-terraces of New Zealand were destroyed by the eruption of Mount Tarawera in 1886. Mr W. H. Weed on studying the deposition of sinter in the Yellowstone National Park found that the colloidal silica was largely due to the action of algae and other forms of vegetation in the thermal waters (*9th Ann. Rep. U.S. Geol. Surv.*, 1889, p. 613). Siliceous sinter is known to mineralogists under such names as geyserite, fiorite and michaelite (see OPAL).

Calcareous sinter is a deposit of calcium carbonate, exemplified by the travertine, which forms the principal building stone of Rome (Ital. *travertino*, a corruption of *liburlino*, the stone of Tibur, now Tivoli). The so-called "petrifying springs," not uncommon in limestone-districts, yield calcareous waters which deposit a sintery incrustation on objects exposed to their action. The cavities in calcareous sinter are partly due to the decay of mosses and other vegetable structures which have assisted in its precipitation. Even in thermal waters, like the hot springs of Carlsbad, in Bohemia, which deposit *Sprudelstein*, the origin of the deposits is mainly due to organic agencies, as shown as far back as 1862 by Ferd. Cohn. Whilst calcareous deposits in the open air form sinter-like travertine, those in caves constitute stalagmite.

Iron-sinter is a term sometimes applied to cellular bog iron-ore. (F. W. R.*)

SION [Ger. *Sitten*], the capital of the Swiss canton of the Valais. It is on the railway between St Maurice (25½ m. distant) and Brieg (33 m. distant). Sion is one of the most picturesque little cities in Switzerland, being built around two prominent hillocks that rise from the level valley of the Rhone. The north hillock is crowned by the castle of Tourbillon (built 1294, burnt 1788), which was long the residence of the bishops. The south hillock bears the castle of Valeria, long the residence of the canons (it now contains an historical museum) with the interesting 13th century church of St Catherine. In the town below is the 15th century cathedral, and the Majoria castle (burnt in 1788) the former residence of the "major" (or mayor of the city). There are various other curious objects in the city, which is built on the banks of the Sionne torrent, and is at a height of 1680 ft. above the sea-level. In 1900 Sion contained 6048 inhabitants (mainly Romanists), of whom 1481 were German-speaking and 4446 French-speaking.

Sion [*Sedunum*] dates from Roman times, and the bishop's see was removed thither from Martigny [*Octodurum*] about 580. In 999 the bishop received from Rudolf III., king of Burgundy, the dignity of count of the Valais, and henceforward was the temporal as well as the spiritual lord of the Valais, retaining this position, at least in part, till 1798.

See also J. Gremaud, Introduction to vol. v. (Lausanne, 1884) of his *Documents relatifs à l'histoire du Vallais*; R. R. Hoppeler, *Beiträge zur Geschichte des Wallis im Mittelalter* (Zürich, 1897); B. Rameau, *Le Vallais historique* (Sion, 1886). (W. A. B. C.)

SION COLLEGE, in London, an institution founded as a college, guild of parochial clergy and almshouse, under the will (1623) of Dr Thomas White, vicar of St Dunstan's in the West. The clergy who benefit by the foundation are the incumbents of the City parishes, of parishes which adjoined the city bounds when the college was founded, and of parishes subsequently formed out of these. The original buildings in London Wall were on a site previously occupied by Elsing Spital, a hospital for the blind founded in 1329, and earlier still by a nunnery. They comprised the almshouses, a hall and chapel, and the library added to the foundation by Dr John Simson, rector of St Olave's, Hart Street, one of White's executors. There were also, at least originally, apartments for students. In 1884 the almshouses were abolished, and the almsfolk became out-pensioners. It was subsequently found possible to extend their numbers from the original number of 10 men and 10 women to 40 in all, and to increase the pension. In 1886 Sion College was moved to new buildings on the Victoria Embankment, and is now principally known for its theological library which serves as a lending library to members of the college, and is accessible to the public. A governing body appointed by the members to administer the foundation consists of a president, two deans and four assistants.

SIOUX, a tribe of North American Indians. The name is an abbreviation of the French corruption *Nadaouesioux* of the Algonquian name *Nadawesiwug*, "little snakes." They call themselves Dakotas ("allies"). They were formerly divided into seven clans: hence the name they sometimes used, *Oiceti Cakowin*, "the seven council-fires." There was a further distribution into eastern and western Sioux. The former were generally sedentary and agricultural, the latter nomad horsemen. The Sioux were ever conspicuous, even among Indians, for their physical strength and indomitable courage. Their original home was east of the Alleghanies, but in 1632 the French found them chiefly in Minnesota and Wisconsin. Thereafter driven westward by the Ojibwa and the French, they crossed the Missouri into the plains. The Sioux fought on the English side in the War of Independence and in that of 1812. In 1815 a treaty was made with the American government by which the right of the tribe to an immense tract, including much of Minnesota, most of the Dakotas, and a large part of Wisconsin, Iowa, Missouri and Wyoming, was admitted. In 1835 missions were started among the eastern Sioux by the American Board, and schools were opened. In 1837 the tribe sold all their land east of the Mississippi. In 1851 the bulk of their Minnesota territory was sold, but a hitch in the carrying out of the agreement led to a rising

and massacre of whites in 1857 at Spirit Lake on the Minnesota-Iowa border. There was peace again till 1862, when once again the tribe revolted and attacked the white settlers. A terrible massacre ensued, and the punitive measures adopted were severe. Thirty-nine of the Indian leaders were hanged from the same scaffold, and all the Minnesota Sioux were moved to reservations in Dakota. The western Sioux, angry at the treatment of their kinsmen, then became thoroughly hostile and carried on intermittent war with the whites till 1877. In 1875 and 1876 under their chief, Sitting Bull, they successfully resisted the government troops, and finally Sitting Bull and most of his followers escaped into Canada. Sitting Bull returned in 1881. In 1889 a treaty was made reducing Sioux territory. Difficulties in the working of this, and religious excitement in connexion with the Ghost Dance craze, led to an outbreak in 1890. Sitting Bull and three hundred Indians were killed at Wounded Knee Creek, and the Sioux were finally subdued. They are now on different reservations and number some twenty-four thousand. See INDIANS, NORTH AMERICAN.

SIOUX CITY, a city and the county-seat of Woodbury county, Iowa, U.S.A., at the confluence of the Big Sioux with the Missouri river, about 156 m. N.W. of Des Moines. Pop. (1890) 37,806; (1900) 33,111, of whom 6592 were foreign-born (including 1460 Swedish, 1176 German and 1054 Norwegian); (1910, census) 47,828. It is served by the Chicago, Milwaukee & Saint Paul, the Chicago & North-Western, the Chicago, Saint Paul, Minneapolis & Omaha, the Chicago, Burlington & Quincy, the Illinois Central, and the Great Northern railways. The bluffs approach the Missouri more closely at this point than elsewhere in the state, so that little more than manufacturing establishments and business blocks are built on the bottom lands, and the residences are spread over the slope and summit of the bluffs. The city has a public library (housed in the city hall) and eight parks (including Riverside on the Big Sioux), with a total area of more than 500 acres. Among the principal buildings are the city hall, the post office, the Young Men's Christian Association building, and the High School. There are several boat clubs and a country and golf club. Two miles S. of the city is a monument to Sergeant Charles Floyd of the Lewis and Clark expedition, who died here in 1804; and 1 m. W. of the city is the grave of War Eagle, a Sioux chief. Among the educational institutions are Morningside College (Methodist Episcopal, 1894), 3 m. from the business centre of the city, which had in 1908-1909 34 instructors and 672 students; the Sioux City College of Medicine (1889), and St Mary's School. The principal hospitals are the Samaritan, the St Joseph's Mercy, and the German Lutheran. Sioux City is the see of a Roman Catholic bishop. The Chicago, Milwaukee & Saint Paul, the Great Northern, and the Chicago, Saint Paul, Minneapolis & Omaha have shops here; meat packing is an important industry, and the city has large stock yards. As a manufacturing centre, it ranked first in 1900 and third in 1905 among the cities of the state; the value of its factory product in 1905 was \$14,760,751. Its manufactures include slaughtering and meat-packing products, cars and car repairing, linseed oil, bricks and tiles (made from excellent clay found in and near the city). The city does a large wholesale and distributing business. Sioux City was settled about 1850, was platted in 1854, becoming the headquarters of a United States Land Office, was incorporated in 1856, and was chartered as a city in 1857. It was the starting-point of various expeditions sent against the Sioux Indians of the Black Hills.

SIOUX FALLS, a city and the county-seat of Minnehaha county, South Dakota, U. S. A., on the Big Sioux river, about 12 m. N.W. of the N.W. corner of Iowa. Pop. (1890), 10,177; (1900) 10,266, of whom 1858 were foreign-born; (1905), 12,283; (1910), 14,094. It is the largest city in the state. Sioux Falls is served by the Chicago, Milwaukee & St Paul, the Chicago, Rock Island & Pacific, the Great Northern, the Illinois Central, the Chicago, St Paul, Minneapolis & Omaha (North-Western lines), and the South Dakota Central railways. In the city are the State Penitentiary, the State Children's Home, the South Dakota School for Deaf Mutes, a United States Government

Building, the County Court House, Sioux Falls College (Baptist; co-educational; founded in 1883), All Saints School (Protestant Episcopal), for girls, and a Lutheran Normal School (1889). The city is the see of a Roman Catholic and of a Protestant Episcopal bishop. The river falls here about 100 ft. in half a mile and provides good water power for manufactures. The total value of the factory products increased from \$883,624 in 1900 to \$1,897,790 in 1905, or 114.8%. Sioux Falls is a jobbing and wholesaling centre for South Dakota and for the adjacent parts of Iowa and of Minnesota. A quartzite sandstone, commonly known as jasper or "red granite," is extensively quarried in the vicinity, and cattle raising and farming are important industries of the surrounding country. A settlement was made at Sioux Falls in 1856, but this was abandoned about six years later on account of trouble with the Indians. A permanent settlement was established in 1867, and Sioux Falls was incorporated as a village in 1877 and was chartered as a city in 1883.

SIPHANTO, SIPHÉNO or SIPHNO (anc. *Siphnos*), an island of the Greek Archipelago, in the department of the Cyclades, 30 m. S.W. of Syra. It has an area of 28 sq. m., and the population of the commune is 3777 (1907). A ridge of limestone hills—whose principal summits, Hagios Elias and Hagios Simeon, are crowned by old Byzantine churches—runs through the island; for about 2 m. along the western slope stretches a series of villages, each white-washed house with its own garden and orchard. One of these, called after the name of an ancient town Apollonia, is the modern capital; Kastro is an "old-world Italian town" with medieval castle and fortifications, and an old town-hall bearing date 1365. Inscriptions found on the spot show that Kastro stands on the site of the ancient city of Siphnos; and Mr Bent identifies the other ancient town of Minoa with the place on the coast where a Hellenic white marble tower is distinguished as the Pharos or lighthouse, and another as the tower of St John. Churches and convents of Byzantine architecture are scattered about the island. One building of this class is especially interesting—the school of the Holy Tomb or school of Siphnos, founded by Greek refugees from Byzantium at the time of the iconoclastic persecutions, and afterwards a great centre of intellectual culture for the Hellenic world. The endowments of the school are now made over to the gymnasium of Syra. In ancient times Siphnos was famous for its gold and silver mines, the site of which is still easily recognized by the excavations and refuse-heaps. As in antiquity so now the potters of the island are known throughout the Archipelago. Siphnos was said to have been colonized by Ionians from Athens. It refused tribute to Xerxes, and sent one ship to fight on the Greek side at Salamis.

The wealth of the ancient Siphniotes was shown by their treasury at Delphi, where they deposited the tenth of their gold and silver; but, says the legend, they once failed to do this, and Apollo in his anger flooded their mines. That the mines were invaded by the sea is still evident; and by Strabo's time the inhabitants of the island were noted for their poverty. During the Venetian period it was ruled first by the Da Corogna family and after 1456 by the Gazzadini, who were expelled by the Turks in 1617.

SIPHON, or SYPHON (Lat. *siphon*; Gr. *σίφων*, a tube), an instrument, usually in the form of a bent tube, for conveying liquid over the edge of a vessel and delivering it at a lower level. The action depends upon the difference of the pressure on the liquid at the extremities of the tube, the flow being towards the lower level and ceasing when the levels coincide. The instrument affords a ready method of transferring liquids. The tube is made of glass, indiarubber, copper or lead, according to the liquid which is to be transferred. The simple siphon is used by filling it with the liquid to be decanted, closing the longer limb with the finger and plunging the shorter into the liquid; and it must be filled for each time of using. Innumerable forms have been devised adapted for all purposes, and provided with arrangements for filling the tube, or for keeping it full and starting it into action automatically when required. Pipes conveying the water of an aqueduct across a valley and following the contour of the sides are sometimes called siphons, though they do not depend on the principle of the above instrument. In the siphon

used as a container for aerated waters a tube passes through the neck of the vessel, one end terminating in a curved spout while the other reaches to the bottom of the interior. On this tube is a spring valve which is opened by pressing a lever. The vessel is filled through the spout, and the water is driven out by the pressure of the gas it contains, when the valve is opened. The "Regency portable fountain," patented in 1825 by Charles Plinth, was the prototype of the modern siphon, from which it differed in having a stopcock in place of a spring valve. The "siphon champenois" of Deleuze and Dutillet (1829) was a hollow corkscrew, with valve, which was passed through the cork into a bottle of effervescent liquid, and the "vase siphon" of Antoine Perpigna (Savaresse père), patented in 1837, was essentially the modern siphon, its head being fitted with a valve which was closed by a spring.

SIPPARA (*Zimbar* in Sumerian, *Sippar* in Assyro-Babylonian), an ancient Babylonian city on the east bank of the Euphrates, north of Babylon. It was divided into two quarters, "Sippar of the Sun-god" (see SHAMASH) and "Sippar of the goddess Anunit," the former of which was discovered by Hormuzd Rassam in 1881 at Abu-Habba, 16 m. S.E. of Bagdad. Two other Sippars are mentioned in the inscriptions, one of them being "Sippar of Eden," which must have been an additional quarter of the city. It is possible that one of them should be identified with Agadē or Akkad, the capital of the first Semitic Babylonian Empire. The two Sippars of the Sun-god and Anunit are referred to in the Old Testament as Sepharvaim. A large number of cuneiform tablets and other monuments has been found in the ruins of the temple of the Sun-god which was called E-Babara by the Sumerians, Bit-Uri by the Semites. The Chaldaean Noah is said by Berossus to have buried the records of the antediluvian world here—doubtless because the name of Sippar was supposed to be connected with *sipru*, "a writing"—and according to Abydenus (*Fr.* 9) Nebuchadrezzar excavated a great reservoir in the neighbourhood. Here too was the Babylonian camp in the reign of Nabonidos, and Pliny (*N.H.* vi. 30) states that it was the seat of a university.

See Hormuzd Rassam, *Babylonian Cities* (1888). (A. H. S.)

SIPUNCULOIDEA, marine animals of uncertain affinities, formerly associated with the Echiuroidea (*q.v.*) in the group Gephyrea. Externally, the body of a Sipunculoid presents no projections: its surface is as a rule even, and often glistening, and the colour varies from whitish through yellow to dark brown. The anterior one-quarter or one-third of the body is capable of being retracted into the remainder, as the tip of a glove-finger may be pushed into the rest, and this retractile part is termed the introvert. At the tip of the introvert the mouth opens, and is surrounded in *Sipunculus* by a funnel-shaped, ciliated lophophore (figs. 1 and 2). In *Phascolosoma* and *Phascolion* this funnel-shaped structure has broken up into a more or less definite group of tentacles, which in *Dendrostoma* are arranged in four groups. In *Aspidosiphon* and *Physcosoma* the tentacles are usually arranged in a horse-shoe, which may be double, overhanging the mouth dorsally. On the surface of the funnel-shaped lophophore are numerous ciliated grooves, and each of the tentacles in the tentaculated forms has a similar groove directed towards the mouth. These grooves doubtless serve to direct currents of water, carrying with them small organisms towards the mouth.

The skin consists of a layer of cuticle, easily stripped off, secreted by an ectodermal layer one cell thick. Within this is usually a sheath of connective tissue, which surrounds a layer of circular muscles; the latter may be split up into separate bundles, but more usually form a uniform sheet. Within the circular muscles is a layer of longitudinal muscles, very often broken into bundles, the number of which is often of specific importance. Oblique muscles sometimes lie between the circular and longitudinal sheaths. On the inner surface is a layer of peritoneal epithelium, which is frequently ciliated, and at the bases of the retractor muscles is heaped up and modified into the reproductive organs. The ectoderm is in some genera modified to form certain excretory glands, which usually take the form of papillae with an apical opening. These papillae give the surface a roughened aspect; the use of their secretion is unknown. They are best developed in *Physcosoma*.

When the body of a Sipunculoid is opened, it is seen that the body-cavity is spacious and full of a corpusculated fluid, in which the various organs of the body float. The most conspicuous of these is

the long, white alimentary canal, crowded with mud. The mouth is devoid of armature, and passes without break into the oesophagus; this is surrounded by the retractor muscles, which are inserted into the skin around the mouth, and have their origin in the body-wall, usually about one-third or one-half of the body-length from the anterior end (figs. 1 and 2). Their function is to retract the introvert, which is protruded again by the contraction of the circular muscles of the skin; these, compressing the fluid of the body-cavity, force

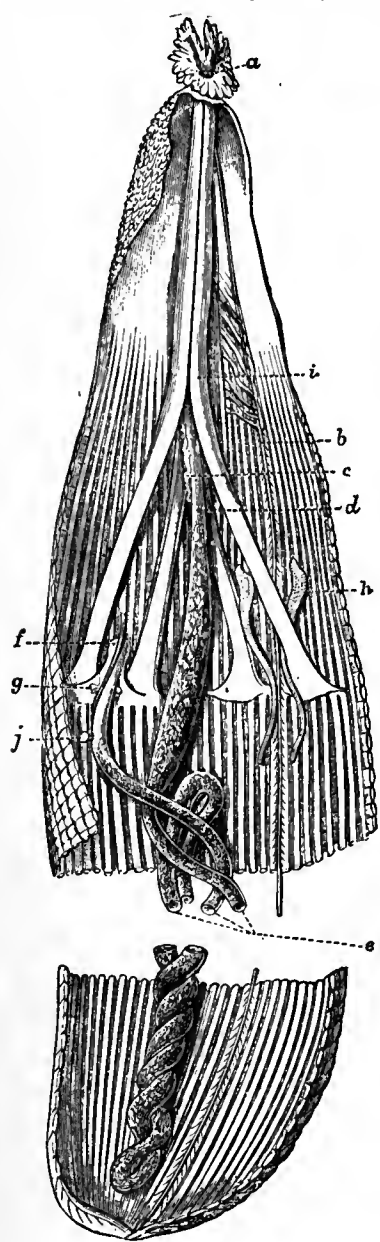

FIG. 1.—*Sipunculus nudus*, L., with introvert and head fully extended, laid open by an incision along the right side to show the internal organs, $\times 2$.

- a, Mouth.
- b, Ventral nerve-cord.
- c, "Heart."
- d, Oesophagus.
- e, Intestine.
- f, Position of anus.
- g, Tuft-like organs.
- h, Right nephridium.
- i, Retractor muscles.
- j, Diverticulum on rectum. The spindle-muscle is seen overlying the rectum.

the mouth; this gives off a pair of oesophageal commissures, which surround the oesophagus and unite in a median ventral nerve-cord which runs between the longitudinal muscles to the posterior end of the body. From time to time it gives off

forward the anterior edge of the introvert. The number of muscles varies from one (*Onchnesoma* and *Tylosoma*) to four, the latter being very common. The alimentary canal is U-shaped, the dorsal limb of the U terminating in the anus, situated not very far from the level of the origin of the retractor muscles. The limbs of the U are further twisted together in a looser or tighter coil, the axis of which may be traversed by a "spindle" muscle arising from the posterior end of the body. No glands open into the alimentary canal, but a diverticulum, which varies enormously in size, opens into the rectum. As is so often the case with animals which eat mud and sand, and extract what little nutriment is afforded by the organic debris therein, the walls of the alimentary canal are thin and apparently weak. All along one side is a microscopic ciliated groove, into which the mud does not seem to enter, and along which a continuous stream of water may be kept up. Possibly this is respiratory—there are no special respiratory organs. A so-called heart lies on the dorsal surface of the oesophagus; it is closed behind, but in front it opens into a circumoesophageal ring, which gives off vessels into the lophophore and tentacles. The contraction of this heart, which is not rhythmic, brings about the expansion of the tentacles and lophophore. This system is in no true sense a vascular system; there are no capillaries, and the fluid it contains, which is corpusculated, can hardly have a respiratory or nutritive function. It is simply a hydrostatic mechanism for expanding the tentacles. The excretory organs are typical nephridia, with an internal ciliated opening into the body-cavity, and an external pore. One surface of the tube is prolonged into a large sac lined with glandular excretory cells. The organs are typically two, though one is often absent, e.g. in *Phascolion*. They serve as channels by which the reproductive cells leave the body, and they are sometimes spoken of as "brown tubes." There is a well-developed brain dorsal to the oesophageal commissures,

which run round the body in the skin and break up into a very fine nerve plexus. There are no distinct ganglia, but ganglion cells are uniformly distributed along the ventral side of the cord. The whole is anteriorly somewhat loosely slung to the skin, so as to allow free play when the animal is extending or retracting its introvert. A pit or depression, known as "the cerebral organ," opens into the brain just above the mouth; this usually divides into two limbs, which are deeply pigmented and have been called eyes.

Sipunculoids are dioecious, and the ova and spermatozoa are formed from the modified cells lining the body-cavity, which are heaped up into a low ridge running along the line of origin of the retractor muscles. The ova and the mother-cells of the spermatozoa break off from this ridge, and increase in size considerably in the fluid of the body-cavity. Fertilization is external; and in about three days a small ciliated larva, not unlike that of the Echiuroids, but with no trace of segmentation, emerges from the egg-shell. This little creature, which has many of the features of a Trochosphere larva, swims about at the surface of the sea for about a month and grows rapidly. At the end of this time it undergoes a rapid metamorphosis:

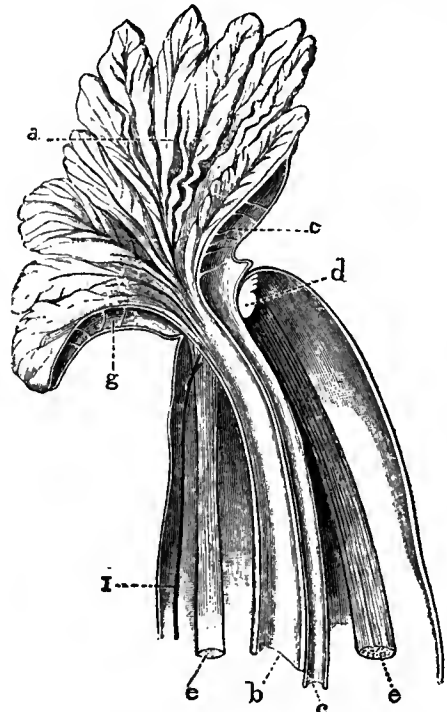

FIG. 2.—Right half of the anterior end of *Sipunculus nudus*, L., seen from the inner side and magnified.

- a, Funnel-shaped grooved tentacular crown leading to the mouth.
- b, Oesophagus.
- c, Strands breaking up the cavity of the tentacular crown into vascular spaces.
- c', "Heart."
- d, Brain.
- e, Ventral, and e', dorsal retractor muscles.
- f, Ventral nerve-cord.
- g, Vascular spaces in tentacular crown.

it loses many of its larval organs, cilia, takes in a quantity of water into its body-cavity, sinks to the bottom of the sea, and begins life in its final form.

The following genera of Sipunculoids are recognized:—(i.) *Sipunculus*. This, with *Physcosoma*, has its longitudinal muscles divided up into some 17-41 bundles. It has no skin papillae. The members of this genus attain a larger size than any other species, and the genus contains some 16-17 species. (ii.) *Physcosoma* (fig. 3) has its body covered with papillae, and usually numerous rows of minute hooks encircling the introvert. It is the most numerous genus, and consists for the most part of shallow-water (less than 50 fathoms) tropical and subtropical forms. They often live in tubular burrowings in coral-rock. The following three genera have their longitudinal muscles in a continuous sheath:—(iii.) *Phascolosoma*, with some 25 species, mostly small, with numerous tentacles. (iv.) *Phascolion*, 10 species, small, living in mollusc-shells and usually adopting the coiled shape of their house; only one kidney, the right, persists. (v.) *Dendrostoma*, with 4-6 tentacles, a small genus found in tropical shallow water. (vi.) *Aspidosiphon*, with 19 species, is easily distinguished by a calcareous deposit and thickened shield at the posterior end and at the base of the introvert, which is eccentric. (vii.) *Cloeosiphon* has a calcareous ring, made up of lozenge-shaped plates, round the base of its centric introvert. (viii.) *Petalostoma*, a

minute form with two leaf-like tentacles, is found in the English Channel. (ix.) *Onchnesoma*, with 2 species, and (x.) *Tylosoma*, with 1 species, have no tentacles, only one brown tube, and only one retractor muscle. Both genera are found off the Norwegian coast. The last named is said to have numerous papillae and no introvert.

SIR (Fr. *sire*, like *sieur* a variant of *seigneur*,¹ from Lat. *senior*, comparative of *senex*, "old"), a title of honour. As a definite style it is now confined in the dominions of the British crown to baronets, knights of the various orders, and knights bachelor. It is never used with the surname only, being prefixed to the

Christian name of the bearer; e.g. Sir William Jones. In formal written address, in the case of baronets the abbreviation Bar^t, Bart. or B^t (baronet) is added after the surname,² in the case of knights of any of the orders the letters indicating his style (K.G., K.C.B., &c.). In conversation a knight or baronet is addressed by the prefix and Christian name only (e.g. "Sir William"). The prefix Sir, like the French *sire*, was originally applied loosely to any person of position as a mere honorific distinction (as the equivalent of *dominus*, lord), as it still is in polite address, but Selden (*Titles of Honor*, p. 643) points out that as a distinct title "prefixed to the Christian names in compellations and expressions of knights" its use "is very ancient," and that in the reign of Edward I. it was "so much taken to be parcel of their names" that the Jews in their documents merely transliterated it, instead of translating it by its Hebrew equivalent, as they would have done in the case of e.g. the Latin form *dominus*.

How much earlier this custom originated it is difficult to say, owing to the ambiguity of extant documents, which are mainly in Latin. Much light is, however, thrown upon the matter by the Norman-French poem *Guillaume le Mareschal*,³ which was written early in the 13th century. In this *Sire* is obviously used in the general sense mentioned above, i.e. as a title of honour applicable to all men of rank, whether royal princes or simple knights. The French king's son is "Sire Loeis" (l. 17741), the English king's son is "Sire Richard li filz le roi" (l. 17376); the marshal himself is "Sire Johan li Mareschals" (17014). We also find such notable names as "Sire Hubert de Burc" (ll. 17308, 17357) and "Sire Hue de Bigot"—

"Qui par lignage esteit des buens,
E après son pere fu cuens,"⁴

and such simple knights as "Sire Johan d'Erlée" (Early in Berks), the originator of the poem, who was squire to William the Marshal, or "Seingnor Will. de Monceals," who, though of very good family, was but constable of a castle. Throughout the poem, moreover, though *Sire* is the form commonly used it is freely interchanged with *Seignor* and *Monseignor*. Thus we have "Seingnor Huc. de Corni" (l. 10935), "Sire Hug. de Corni" (l. 10945) and "Monseingnor Huon de Corni" (l. 10955). Occasionally it is replaced by *Dan* (*dominus*), e.g. the brother of Louis VII. of France is "Dan Pierre de Cortenei" (l. 2131). Very rarely the *e* of *Sire* is dropped and we have *Sir*: e.g. "Sir Will." (l. 12513). Sometimes, where the surname is not territorial, the effect is closely approximate to more modern usage: e.g. "Sire Aleins Basset," "Sire Enris li filz Gerolt" (Sir Henry Fitz Gerald), "Sire Girard Talebot," "Sire Robert Tresgoz."

It is notable that in connexion with a name the title *Sire* in the poem usually stands by itself: sometimes *mis* (my) is prefixed, but never *li* (the). Standing alone, however, *Sire* denominates a class and the article is prefixed: e.g. *les seirs d'Engleterre*—the lords of England—(l. 15837).⁵ "Sire," "Seignor" are used in addressing the king or a great noble.

It is thus not difficult to see how the title "Sir" came in England to be "prefixed to the expressions of knights." Knight-hood was the necessary concomitant of rank, the ultimate proof of nobility. The title that expressed this was "Sire" or "Sir" prefixed to the Christian name. In the case of earls or barons it might be lost in that of the higher rank, though this was not

¹ Certainly not "from Cyr, κυρ, a diminutive of the Greek word κήριος" (F. W. Pixley, *A History of the Baronetage*, 1900, p. 208).

² For not very obvious reasons some baronets now object to the contracted form "Bart.," which had become customary. See Pixley, *op. cit.* p. 212.

³ Edited in 3 vols., with notes, introduction and mod. French translation by Paul Meyer for the Soc. de l'Histoire de France (Paris, 1891).

⁴ "Who was of good lineage and after his father became earl."

⁵ Cf. l. 18682. N'entendi mie bien li sire
Que mis sire Johan volt dire.

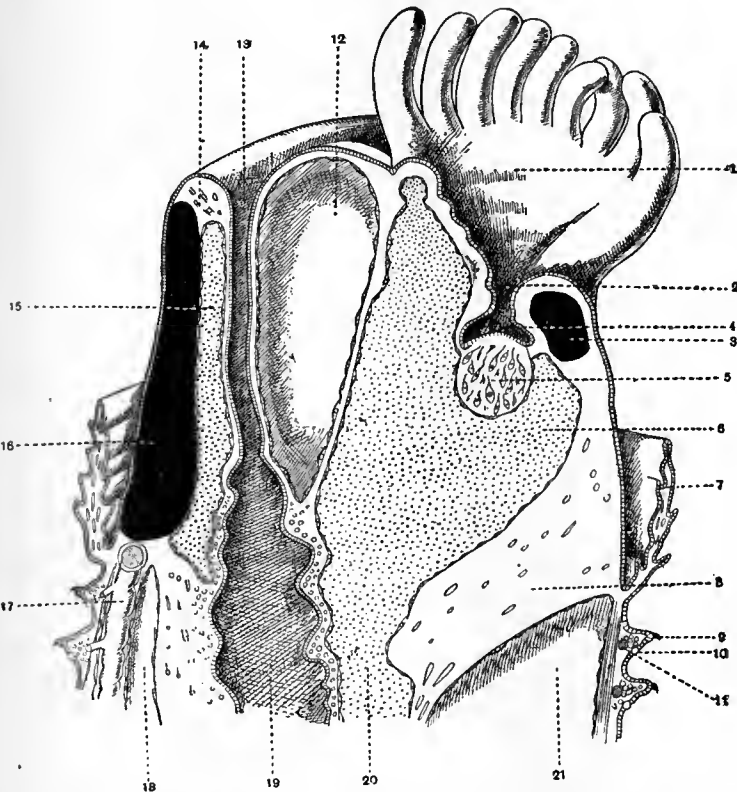

FIG. 3.—A semi-diagrammatic figure of the anterior end of half a *Physcosoma*, seen from the inner side. The introvert is fully everted and the lophophore expanded. The collar which surrounds the head is not fully extended. Two rows only of hooks are shown.

- 1, Lophophore.
- 2, Pigmented pit leading to brain.
- 3, Segmented dorsal portion of mesoblastic "skeleton."
- 4, Pit ending in eye.
- 5, The brain.
- 6, Blood-sinus of dorsal side surrounding brain and giving off branches to the tentacles.
- 7, Collar.
- 8, Retractor muscle of head.
- 9, Hook.
- 10, Sense-organ.
- 11, Nerve-ring.
- 12, Coelom of upper lip; it is continuous with 21.
- 13, Mouth.
- 14, Lower lip.
- 15, Blood-sinus of ventral side, continuous with 6.
- 16, Ventral portion of mesoblastic "skeleton."
- 17, Ventral nerve-cord.
- 18, Coelom, continuous with 12 and 21.
- 19, Oesophagus.
- 20, Dorsal vessel arising from the blood-sinus 6.
- 21, Coelom.

AUTHORITIES.—Selenka, "Die Sipunculiden," *Semper's Reisen* (1883), and *Challenger Reports*, xiii. (1885); Sluiter, *Natuurk. Tijdschr. Nederl. Ind.* xli. and following volumes; Andrews, *Stud. Johns Hopkins Univ.* iv. (1887-1890); Ward, *Bull. Mus. Harvard*, xxi. (1891); Hatschek, *Arb. Inst. Wien*, v. (1884); Shipley, *Quart. J. Micr. Sci.* xxxi. (1890), xxxii. (1891), and xxxiii. (1892); *P. Zool. Soc. London* (1898), and Willey's *Zoological Results*, pt. 2 (1899); Horst, *Niederland. Arch. Zool.*, Supplementary, vol. i. (A. E. S.)

SIQUIJOR, a town of the province of Negros Oriental, Philippine Islands, on a small island of the same name about 14 m. S.E. of Dumaguete, the capital of the province. Pop. (1903) after the annexation of San Juan, 19,416. There are sixty-four barrios or villages in the town, but only one of these had in 1903 more than 1000 inhabitants. The language is Bohol-Visayan. The principal industry is the raising of coco-nuts and preparing them for market. Other industries are the cultivation of tobacco, rice, Indian corn and hemp, and the manufacture of *sinamay*, a coarse hemp cloth. The island is of coral formation; its highest point is about 1700 ft.

universal even much later: e.g. in the 14th century, Sir Henry Percy, the earl marshal, or Sir John Cobham, Lord Oldcastle. The process by which the title lost all connotation of nobility would open up the whole question of the evolution of classes in England (see GENTLEMAN). In the case of baronets the prefix "Sir" before the Christian name was ordained by King James I. when he created the order.

The old use of "Sir" as the style of the clergy, representing a translation of *dominus*, would seem to be of later origin; in *Guillaume le Mareschal* even a high dignitary of the church is still *maistre* (master): e.g. "Maistre Pierres li cardonals" (l. 11399). It survived until the honorific prefix "Reverend" became stereotyped as a clerical title in the 17th century. It was thus used in Shakespeare's day: witness "Sir Hugh Evans," the Welsh parson in *The Merry Wives of Windsor*. In the English universities there is a curious survival of this use of "Sir" for *dominus*, members of certain colleges, technically still "clerks," being entered in the books with the style of "Sir" without the Christian name (e.g. "Sir Jones").

In ordinary address the title "Sir," like the French *Monsieur*, is properly applied to any man of respectability, according to circumstances. Its use in ordinary conversation, as readers of Boswell will realize, was formerly far more common than is now the case; nor did its employment imply the least sense of inferiority on the part of those who used it. The general decay of good manners that has accompanied the rise of democracy in Great Britain has, however, tended to banish its use, together with that of other convenient forms of politeness, from spoken intercourse. As an address between equals it has all but vanished from social usage, though it is still correct in addressing a stranger to call him "Sir." In general it is now used in Great Britain as a formal style, e.g. in letters or in addressing the chairman of a meeting; it is also used in speaking to an acknowledged superior, e.g. a servant to his master, or a subaltern to his colonel. "Sir" is also the style used in addressing the king or a prince of the blood royal (the French form "Sire" is obsolete).

In the United States, on the other hand, or at least in certain parts of it, the address is still commonly used by people of all classes among themselves, no relation of inferiority or superiority being in general implied.

The feminine equivalent of the title "sir" is legally "dame" (*domina*); but in ordinary usage it is "lady," thus recalling the original identity of the French *sire* with the English "lord." (W. A. P.)

SIRAJGANJ, a town of British India, in the Pabna district of Eastern Bengal and Assam, on the right bank of the Jamuna or main stream of the Brahmaputra, 6 hours by steamer from the railway terminus at Goalundo. It is the chief river mart for jute in northern Bengal, with several jute presses. The jute mills were closed after the earthquake of 1897. Pop. (1901) 23,114.

SIRDAR, or **SARDAR** (Persian *sardar*, meaning a leader or officer), a title applied to native nobles in India, e.g. the sirdars of the Deccan. Sirdar Bahadur is an Indian military distinction; and Sirdar is now the official title of the commander-in-chief of the Egyptian army.

SIREN, a name derived from the Greek Sirens (see below) for an acoustical signalling instrument specially used in lighthouses, &c. (see LIGHTHOUSE), and applied by analogy to certain other forms of whistle. In zoology the siren (*Siren lacertina*), or "mud-eel" of the Americans, one of the perennibranchiate tailed batrachians, is the type of the family *Sirenidae*, chiefly distinguished from the *Proteidae* by the structure of the jaws, which, instead of being beset with small teeth, are covered by a horny sheath like a beak; there are, however, rasp-like teeth on the palate, and a few on the inner side of the lower jaw, inserted on the splenial bone. The body is eel-like, black or blackish, and only the fore-limbs are present, but are feeble and furnished with four fingers. It grows to a length of three feet and inhabits marshes in North and South Carolina, Florida and Texas. A second closely-allied genus of this family is *Pseudobranchius*, differing in having a single branchial aperture on each side instead

of three, and only three fingers. The only species, *P. striatus*, is a much smaller creature, growing to six inches only, and striated black and yellow; it inhabits Georgia and Florida.

As E. D. Cope has first shown, the siren must be regarded as a degenerate rather than a primitive type. He has observed that in young specimens of *Siren lacertina* (the larva is still unknown) the gills are rudimentary and functionless, and that it is only in large adult specimens that they are fully developed in structure and function; he therefore concludes that the sirens are the descendants of a terrestrial type of batrachians, which passed through a metamorphosis like the other members of their class, but that more recently they have adopted a permanently aquatic life, and have resumed their branchiae by reversion. From what we have said above about *Proteus* and similar forms, it is evident that the "perennibranchiates" do not constitute a natural group.

See E. D. Cope, "Batrachia of North America," *Bull. U.S. Nat. Mus.* No. 34 (1889), p. 223.

SIRENIA, the name (in reference to the supposed mermaid-like appearance of these animals when suckling their young) of an order of aquatic placental mammals, now represented by the manati (or manatee) and dugong, and till recently also by the rhytina. Although in some degree approximating in external form to the Cetacea, these animals differ widely in structure from the members of that order, and have a totally distinct ancestry.

The existing species present the following leading characteristics. The head is rounded and not disproportionate in size as compared with the trunk, from which it is scarcely separated by any externally visible constriction or neck. Nostrils valvular, separate, and placed above the fore-part of the obtuse, truncated muzzle. Eyes very small, with imperfectly formed eyelids, capable, however, of contraction, and with a well-developed nictitating membrane. Ear without any conch. Mouth of small or moderate size, with tumid lips beset with stiff bristles. General form of the body depressed fusiform. No dorsal fin. Tail flattened and horizontally expanded. Fore-limbs paddle-shaped, the digits being enveloped in a common cutaneous covering, though sometimes rudiments of nails are present. No trace of hind-limbs. External surface covered with a tough, finely wrinkled or rugous skin, naked, or with sparsely scattered fine hairs.

The skeleton is remarkable for the massiveness and density of most of the bones, especially the skull and ribs, which add to the specific gravity of these slow-moving animals, and aid in keeping them to the bottom of the shallow waters in which they dwell, while feeding on aquatic vegetables. The skull presents many peculiarities, among which may be indicated the large size and backward position of the nasal aperture, and the downward flexure of the front of both jaws. The nasal bones are absent, or rudimentary and attached to the edge of the frontals, far away from the middle line; but in some extinct species these bones, though small, are normal in situation and relations. In the spinal column none of the vertebrae are united together to form a sacrum, and the flat ends of the bodies do not ossify separately, so as to form disk-like epiphyses in the young state, as in nearly all other mammals. The anterior caudal vertebrae have well-developed chevron-bones. In one genus (*Manatus*) there are only six cervical vertebrae. There are no clavicles. The humerus has a small but distinct trochlear articulation at the elbow-joint; and the bones of the fore-arm are about equally developed, and generally welded together at both extremities. The carpus is short and broad, and the digits five in number, with moderately elongated and flattened phalanges, which are never increased beyond the number usual in Mammalia. The pelvis is rudimentary, consisting of a pair of bones suspended at some distance from the vertebral column.

Two kinds of teeth, incisors and molars, separated by a wide interval, are generally present. The former may be developed into tusks in the upper jaw, or may be quite rudimentary. The molars vary much in character. In one genus (*Rhytina*) no teeth of any kind are present, at least in the adult. In all, the anterior part of the palate, and a corresponding surface on the prolonged symphysis of the lower jaw, are covered with rough horny plates of peculiar structure, which doubtless assist in mastication. The tongue is small and fixed in position, with a surface resembling that of the aforesaid plates. The salivary glands are largely developed. The stomach is compound, being divided by a valvular constriction into two principal cavities, the first of which is provided with a glandular pouch near the cardiac end, and the second usually with a pair of elongated, conical, caecal sacs or diverticula. The intestinal canal is long, and with very muscular walls. There is a caecum, either simple, conical, and with extremely thick walls, as in *Halicore*, or cleft, as in *Manatus*. The apex of the heart is deeply cleft between the ventricles. The principal arteries form extensive and complex network-like structures, *retia mirabilia*. The lungs are long and

narrow, as, owing to the oblique position of the diaphragm, the thoracic cavity extends far back over the abdomen. The epiglottis and arytenoid cartilages of the larynx do not form a tubular prolongation. The brain is comparatively small, with the convolutions on the surface of the cerebrum few and shallow. The kidneys are simple, and the testes abdominal. The uterus is bicornuate. The placenta is non-deciduate and diffuse, the villi being scattered generally over the surface of the chorion except at the poles. The umbilical vesicle disappears early. The teats are two, and pectoral or rather post-axillary in position.

In vol. lxxvii. of the *Zeitschrift für wissenschaftliche Zoologie* Mr L. Freund describes in detail the osteology of the flippers of the dugong as displayed in "sciograph" pictures. These show that the carpus of the adult consists of three large bones. Of the two in the first row, one consists of the fused radiale and intermedium, and the other of the ulnare plus the pisiform and the fifth carpal, the lower bone being composed of the four inner carpalia. In the manati the reduction of the carpus has been carried to a less extent, the radiale being in some instances distinct from the intermedium, while in other cases in which these two bones are fused the four inner carpalia remain separate.

Sirenians pass their whole life in water, being denizens of shallow bays, estuaries, lagoons and large rivers, and not met with in the high seas far away from shore. Their food consists entirely of aquatic plants, either marine algae or freshwater grasses, upon which they browse beneath the surface, as the terrestrial herbivorous mammals do upon the green pastures on shore. To visit these pastures, they come in with the flood-tide and return with the ebb. They are generally gregarious, slow and inactive in their movements, mild, inoffensive, and apparently unintelligent in disposition. Though occasionally found stranded by the tide or waves, there is no evidence that they voluntarily leave the water to bask or feed on the shore. The habit of the dugong of raising its round head out of water, and carrying its young under the fore fin, seems to have given rise, among the early voyagers in the Indian Ocean, to the legendary beings, half human and half fish, in allusion to which the name *Sirenia* was bestowed by Illiger. The species now existing are few. One species, *Rhytina gigas* of the North Pacific, was exterminated through the agency of man during the 18th century; and the others, being valuable for their flesh as food, for their hides, and especially for the oil obtained from the thick layer of fat which lies immediately beneath their skin, diminish in numbers as civilized populations occupy the regions forming their natural habitat. The species are confined to the tropical regions of the shores of both sides of the Atlantic and the great rivers which empty themselves into that ocean, and to the coasts of the Indian Ocean from the Red Sea to North Australia.

As regards dentition (or the want thereof) the three modern genera are remarkably different; and while on this and other grounds some writers refer them to as many separate families, by others they are all included in the *Manatidae*.

In the manatis (*Manatus*) the incisors, $\frac{1}{2}$ in number, are rudimentary, and concealed beneath the horny mouth-plates, and

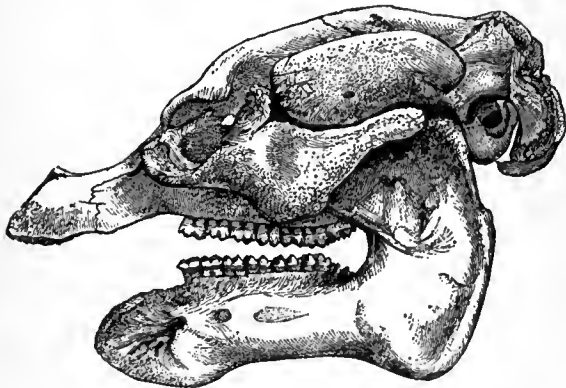

FIG. 1.—Skull of African Manati (*Manatus senegalensis*). $\times \frac{1}{2}$.
From Mus. Roy. Coll. Surgeons.

disappearing before maturity. Molars about $\frac{2}{3}$, but rarely more than $\frac{1}{2}$ present at one time; the anterior teeth falling before the posterior come into use; similar in characters from beginning to

end of the series; with square, enamelled crowns, the grinding surface raised into tuberculated transverse ridges. The upper teeth with two ridges and three roots, the lower with an additional (posterior) ridge or heel and two roots. The cervical vertebrae present the anomaly of being reduced to six in number, the usual vertebral formula being C 6, D 15-18, L and C, a 25-29. Rostrum of the skull, formed by the union of the premaxillae in front of the nasal aperture, shorter than the length of the aperture and scarcely deflected from the basi-cranial axis. Tail entire, rounded or shovel-shaped. Rudimentary nails on the fore-limbs. Caecum cleft.

Manatis inhabit the shores of, and the great rivers which empty themselves into, the Atlantic within the tropics. The American (*M. australis*) and African (*M. senegalensis*) forms are generally considered distinct species, though they differ but little from each other in anatomical characters and in habits. There is also the small *M. inunguis* of the Amazon, which has no nails. They are rather fluviatile than marine, ascending large rivers almost to their sources (see MANATI).

In the dugong (*Halicore*) the upper jaw is furnished with a pair of large, nearly straight, tusk-like incisors, directed downwards and forwards, partially coated with enamel. In the male they have persistent pulps, and bevelled cutting edges, which project a short distance from the mouth, but in the female, though they remain through life in the alveolar cavity, they are not exerted, and the pulp cavity being filled with osteodentine, they soon cease to grow. In the young there is also a second small deciduous incisor on each side above. At this age there are also beneath the horny plate which covers the anterior portion of the mandible four pairs of slender conical teeth lodged in wide socket-like depressions which

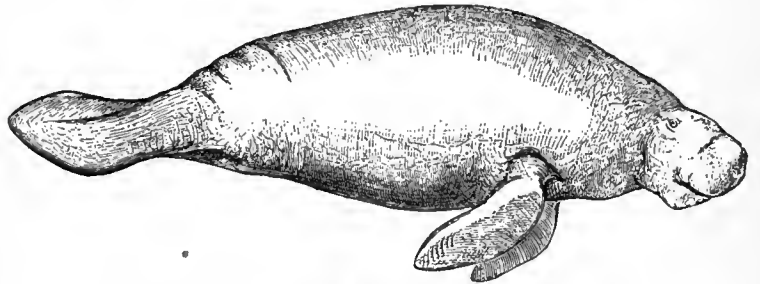

FIG. 2.—American Manati (*Manatus australis*).

become absorbed before the animal reaches maturity. The molars are usually $\frac{2}{3}$, sometimes $\frac{1}{2}$, altogether, but not all in place at once, as the first falls before the last rises above the gum; they are more or less cylindrical in section, except the last, which is compressed and grooved laterally, without distinction into crown and root, increasing in size from before backwards, with persistent pulps and no enamel. The summits of the crowns are tuberculated before wearing, afterwards flattened or slightly concave. Skull with rostrum formed by the union of the premaxillae in front of the nasal aperture, longer than the aperture itself, bending downwards at a right angle with the basi-cranial axis, and enclosing the sockets of the large tusks. Anterior part of the lower jaw bent down in a corresponding manner. Vertebrae: C 7, D 18-19, L and C 30. Tail broadly notched in the middle line, with two pointed lateral lobes. No nails on the fore-limbs. Caecum single. The genus is represented by *H. tabernaculi* from the Red Sea, *H. dugong* from the Indian seas and *H. australis* from Australia. (See DUGONG.)

The last genus is represented only by the extinct *Rhytina gigas*, of Bering Sea, in which there were no teeth, their place being supplied functionally by the dense, strongly-ridged, horny mouth-plates. Premaxillary rostrum about as long as the anterior nasal aperture, and moderately deflected. Vertebrae: C 7, D 19, L and C 34-37. Head very small in proportion to the body. Tail with two lateral pointed lobes. Front limbs small and truncated. Skin naked and covered with a thick, hard, rugged, bark-like epidermis. Stomach without caecal appendages to the pyloric cavity. Caecum simple. See RHYTINA.

Extinct Sirenia.—In past times the Sirenia were represented by a number of extinct generic types ranging over all the temperate and probably tropical regions, and extending from the Pliocene to the Eocene epoch. In the Pliocene of Europe the group is represented by *Felsinotherium*, in the Miocene by *Metaxytherium*, and in the Oligocene by *Halitherium*; the latter having an acetabular cavity to the pelvis and a rudimentary femur. From *Halitherium*, which has a somewhat maniti-like dentition, although there are few cheek-teeth, there is a transition through the other two genera to *Halicore*; *Felsinotherium* having a large pair of tusk-like upper teeth. In *Halitherium* milk-molars were developed. In *Miosiren*, of the Belgian Miocene, the teeth were differentiated into i. $\frac{1}{2}$, p. $\frac{2}{3}$, m. $\frac{1}{2}$. Remains of several early types of sirenians have been obtained from the Eocene deposits of Egypt. The least generalized of these is *Eosiren*, an animal differing from the modern forms chiefly by the retention of traces of the second and third pairs of incisors and of the

canines, and the somewhat less degree of reduction in the pelvis, which has a complete acetabulum for the head of the femur. The front teeth (incisors and canine) have, however, been thrust to the sides of the jaw, possibly to make room for a horny plate on the palate. In the somewhat earlier *Eotherium* the incisors and canines are larger and occupy the normal position in the front of the jaws; while the pelvis has a closed obturator foramen and a complete acetabulum, suggestive that a functional thigh-bone or femur was still retained. The most primitive member of the group with which we are yet acquainted is the very imperfectly known *Prorastomus*, from the Eocene of the West Indies, in which a complete and fully differentiated dentition is accompanied by the absence of that deflection of the front part of the jaws which constitutes one of the most striking features of all the foregoing representatives of the order;—a feature which Dr C. W. Andrews has pointed out must be of great value to short-necked, long-bodied creatures feeding on the herbage at the bottom of the water in which they dwell.

The foregoing Egyptian fossil sirenians afford important evidence with regard to the ancestry of the order. Many years ago it was suggested by the French naturalist de Blainville that the Sirenia are related to the Proboscidea. This is supported by the occurrence of the remains of some of the most primitive sirenians with those of the most primitive proboscideans in the Eocene formations of Egypt; confirmatory evidence being yielded by the similarity of the brain and to some extent of the pelvis in the ancestral forms of the two groups. As regards the living members of the two groups, both have pectoral teats, abdominal testes, and a cleft apex to the heart; while the cheek-teeth of the sirenians are essentially of the same type as those of the early proboscideans. There seems also to be a certain similarity in the mode of succession of the teeth in the more specialized members of the two groups, although in the sirenians this specialization has displayed itself in an abnormal augmentation of the number of the teeth, while in the proboscideans, on the other hand, it has taken the form of an increase in the complexity of the individual teeth, especially those at the hinder part of the series. Finally, although the Proboscidea have a deciduate and the Sirenia a zonary nondeciduate placenta, yet there are certain similarities in the structure of this organ in the two groups which may indicate genetic affinity.

LITERATURE.—O. Thomas and R. Lydekker, "On the Number of Grinding-Teeth possessed by the Manatee," *Proc. Zool. Soc.* (1897); G. R. Lepsius, "*Halitherium schinzi*, die fossile Sirene des Mainzer Beckens," *Abhandl. Mittelrhein. Geol. Vereins* (1881 and 1882); O. Abel, "Die Sirenen der mediterranen Tertiärbildungen Österreichs," *Abhandl. k. k. geol. Reichsanstalt, Wien*, vol. xix. (1904); and "Über *Halitherium bellunense*, eine Übergangsform zur Gattung *Metaxytherium*," *Jahrbuch k. k. geol. Reichsanstalt, Wien*, vol. lv. (1905); C. W. Andrews, *Descriptive Catalogue of the Vertebrata from the Fayum* (British Museum, 1906). (R. L.*)

SIRENS (Gr. *Σειρῆνες*), in Greek mythology, the daughters of Phorcys the sea-god, or, in later legend, of the river-god Achelous and one of the nymphs. In Homer they are two in number (in later writers generally three); their home is an island in the western sea between Aeaea, the island of Circe, and the rock of Scylla. They are nymphs of the sea, who, like the Lorelei of German legend, lured mariners to destruction by their sweet song. Odysseus, warned by Circe, escaped the danger by stopping the ears of his crew with wax and binding himself to the mast until he was out of hearing (*Odyssey* xii.). When the Argonauts were passing by them, Orpheus sang so beautifully that no one had ears for the Sirens, who, since they were to live only until some one heard their song unmoved, flung themselves into the sea and were changed into sunken rocks (Apollodorus i. 9; Hyginus, *Fab.* 141). They were said to have been the playmates of Persephone, and, after her rape by Pluto, to have sought for her in vain over the whole earth (Ovid, *Metam.* v. 552). When the adventures of Odysseus were localized on the Italian and Sicilian coasts, the Sirens were transferred to the neighbourhood of Neapolis and Surrentum, the promontory of Pelorum at the entrance to the Straits of Messina, or elsewhere. The tomb of one of them, Parthenope, was shown in Strabo's (v. p. 246) time at Neapolis, where a gymnastic contest with a torch-race was held in her honour.

Various explanations are given of the Sirens. As sea-nymphs, they represent the treacherous calm of ocean, which conceals destruction beneath its smiling surface; or they signify the enervating influence of the hot wind (compare the name Sirius), which shrivels up the fresh young life of vegetation. Or, they symbolize the magic power of beauty, eloquence and song; hence their images are placed over the graves of beautiful women and maidens, of poets and orators (Sophocles, Isocrates).

Another conception of them is that of singers of the lament for the dead, for which reason they are often used in the adornment of tombs, and represented beating their breasts and tearing their hair or playing the flute or lyre. In early art, they were represented as birds with the heads of women; later, as female figures with the legs of birds, with or without wings.

See H. Schrader, *Die Sirenen* (1868); Preller-Robert, *Griechische Mythologie* (1894), pp. 614–616; G. Weicker, *De Sirenibus quaestiones selectae* (Leipzig, 1895), in which the writer endeavours to show that the Sirens, like the Harpies, were originally the souls of the dead, their employment on tombstones expressing the desire to find a permanent abode for the souls; and *Der Seelenvogel in der alten Literatur und Kunst* (1902), with bibliography; J. E. Harrison, *Myths of the Odyssey* (1882), *Mythology and Monuments of Athens* (1890) and *Prolegomena to the Study of Greek Religion* (1908); J. P. Postgate, in *Journal of Philology*, ix. (1880), who considers the Sirens to have been birds; W. E. Axon, R. Morris, D. Fitzgerald in the *Academy*, Nos. 484, 486, 487 (1881); A. Baumeister, *Denkmäler des klassischen Altertums*, iii. (1888).

SIRGUJA, or **SURGUJA**, one of the Chota Nagpur feudatory states, which was transferred in 1905, from Bengal to the Central Provinces. It is bounded on the N. by the state of Rewa and the districts of Mirzapur and Ranchi, on the E. by Ranchi, on the S. by the Bilaspur district of the Central Provinces and the states of Udaipur and Jashpur, and on the W. by the state of Korea. It is very hilly, with elevated table-lands affording good pasturage, and cut up by numerous ravines. The rivers are the Kanhar, Rer, Mahan, Sone and Sankh, the last being formerly known as the Diamond river. Hot springs exist in the state. Extensive *sāl* forests cover a large area, affording shelter to herds of wild elephant, bison, and many sorts of deer, and also to tigers, bears and other beasts of prey. Area, 6089 sq. m.; pop. (1901) 351,011; estimated revenue, £8000. The residence of the maharaja is at Bistrampur.

SIRHIND, a tract of land in the Punjab, India. It consists of the north-eastern portion of the plain between the Jumna and Sutlej rivers, and is watered by the Sirhind canal. Sirhind is not an administrative division, but historically the name includes the districts of Umballa, Ludhiana, and Ferozepore, together with the states of Patiala, Jind and Nabha.

The Sirhind canal serves the Umballa and Ludhiana districts, and the Patiala, Jind and Nabha states. It draws its water-supply from the Sutlej near Rupar, where the head-works are situated. The canal, which was opened in 1882, has 538 m. of main and branch canals, and irrigates nearly 2000 sq. m.

The town of Sirhind, in the state of Patiala, had a population in 1901 of 5415. It is of very early, but uncertain, foundation, and had a period of great prosperity under the Moguls. Its ancient ruins cover a large extent, and include two fine domed tombs of the 14th century. It is held accused by the Sikhs, owing to the barbarous murder of the son of Guru Govind by the Mahommedan governor in 1704.

SIRICIUS, pope from December 384 to November 399, successor of Damasus. Siricius was averse from countenancing the influence of the monks, and did not treat Jerome with the favour with which he had been honoured by preceding popes, with the result that Jerome left Rome and settled at Bethlehem. Some years later, however, Siricius condemned the anti-ascetic doctrines of Jovinianus. Several of the decretal letters of Siricius are extant, in which, at the request of certain groups of Western bishops, he sets forth the rules of ecclesiastical discipline. It was under his pontificate that a general council was convened at Capua in 391, at which various Eastern affairs were brought forward. Theophilus, bishop of Alexandria, at the request of Siricius, had two important disputes settled by two councils held in 393 at Caesarea and Constantinople, relating respectively to the sees of Antioch and Bostra. The council of Capua, inspired by the pope, deferred to the council of Macedonia the affair of Bonosus, bishop of Sardinia, who had been accused of heresy. To safeguard the authority of the Holy See over the bishops of Illyricum, Siricius entrusted his powers to the bishop of Thessalonica, who was henceforth the vicar of the pope in those provinces. In 386 Siricius had protested against the attitude of Bishop Ithacius, the accuser of Priscillian, and this protest he

resolutely maintained, although he disapproved of the doctrines taught by the Spanish doctor. It was during his pontificate that the last attempt to revive paganism in Rome was made (392-394) by Nicomachus Flavianus. Siricius died on the 26th of November 399. (L. D.*)

SIRKAR (Persian *sarkar*, meaning "head of affairs"), a term used in India in three distinct senses; for the government or supreme authority, for a division of territory under the Moguls, otherwise spelt *circar* (*q.v.*), and for a head servant in Bengal.

SIRMIO, a promontory at the southern end of the Lacus Benacus (Lake of Garda), projecting $2\frac{1}{2}$ m. into the lake. It is celebrated from its connexion with Catullus, for the large ruins of a Roman villa on the promontory have been supposed to be his country house. A post-station bearing the name Sirmio stood on the high-road between Brixia and Verona, near the southern shore of the lake. On the shore below is the little village of Sermione, with sulphur baths.

SIRMOND, JACQUES (1559-1651), French scholar and Jesuit, was born at Riom, Auvergne, on the 12th or the 22nd of October 1559. He was educated at the Jesuit College of Billom; having been a novice at Verdun and then at Pont-à-Mousson, he entered into the order on the 26th of July 1576. After having taught rhetoric at Paris he resided for a long time in Rome as secretary to R. P. Aquaviva (1590-1608); in 1637 he was confessor to Louis XIII. He died on the 7th of October 1651. Father Sirmond was a most industrious scholar, and his criticisms were as enlightened as was possible for a man living in those times. He brought out many editions of Latin and Byzantine chronicles of the middle ages: Ennodius and Flodoard (1611), Sidonius Apollinaris (1614), the life of St Leo IX. by the archdeacon Wibert (1615), Marcellinus and Idatius (1619), Anastasius the librarian (1620), Eusebius of Caesarea (1643), Hincmar (1645), Hrabanus Maurus (1647), Rufinus and Loup de Ferrières (1650), &c., and above all his edition of the capitularies of Charles the Bald (*Karoli Calvi et successorum aliquot Franciæ regum capitula*, 1623) and of the councils of ancient France (*Concilia antiquæ Galliæ*, 1629, 3 vols., new ed. incomplete, 1789). An essay in which he denies the identity of St Denis of Paris and St Denis the Areopagite (1641), caused a very lively controversy from which his opinion came out victorious. His *Opera varia*, where this essay is to be found, as well as a description in Latin verse of his voyage from Paris to Rome in 1590, have appeared in 5 vols. (1696; new ed. Venice, 1728). To him is attributed, and no doubt correctly, *Elogio di cardinale Baronio* (1607).

See the *Bibliothèque des Pères de la Compagnie de Jésus* by Father Carlos Sommervogel, tome vii. (1896).

SIRMUR, or **SARMOR** (also called **NAHAN**, after the chief town), a native state of India, within the Punjab. It occupies the lower ranges of the Himalaya, between Simla and Mussoorie. Area 1108 sq. m. The state is bounded on the N. by the hill states of Balsan and Jubbal, on the E. by the British district of Dehra Dun, from which it is separated by the rivers Tons and Jumna, on the S.W. by Umballa district, and on the N.W. by the states of Patiala and Keonthal. Except a very small tract about Nahan, the chief town and residence of the raja, on the south-western extremity, where a few streams rise and flow south-westward to the Saraswati and Ghaggar rivers, the whole of Sirmur lies in the basin of the Jumna, which receives from this tract the Giri and its feeders the Jalal and the Palur. The Tons, the great western arm of the stream called lower down the Jumna, flows along the eastern boundary of Sirmur, and on the right side receives from it the two small streams Minus and Nairai. The surface generally declines in elevation from north to south; the chief elevations on the northern frontier (Chor peak and station) are about 12,000 ft. above the sea. The valley of the Khiarda Dun, which forms the southern part of the state, is bounded on the S. by the Siwalik range, the hills of which are of recent formation and abound in fossil remains of large vertebrate animals. Though the rocks of Sirmur consist of formations usually metalliferous, the yield of mineral wealth is small. The forests are very dense, so much so that the sportsman finds difficulty in making his way through them in search of deer and

other game, with which they abound. The climate of Sirmur varies with the elevation; the northern extremity has very little rain; but large and excellent crops are everywhere to be obtained by irrigation. The population in 1901 was 135,687, showing an increase of 9% in the decade. Estimated gross revenue, £40,000. The chief, whose title is raja, is a Rajput of high lineage. The raja Shamsheer Perkash, G.C.S.I., who died in 1898, ruled with remarkable ability and success. A younger son commanded the Imperial Service sappers in the Tirah campaign of 1896-97, and was rewarded with the rank of honorary captain in the Indian army and the distinction of C.I.E. Attempts have been made to establish an iron foundry, and to develop mines of slate and mica.

The town of Nahan is situated about 40 m. S. of Simla, 3057 ft. above the sea-level. The palace of the raja and several other houses are built of stone in European style. It had a population in 1901 of 6256.

SIROCCO, a name applied to two quite distinct types of local wind. The first type is the characteristic wind of the winter rainy season in the Mediterranean region, and is associated with the eastern side of local depression or cyclones, in which the weather is moist, cloudy and rainy, the prevailing directions being south and south-east. The second type is the intensely dry dust-laden wind of the desert which receives this name in Sicily and southern Italy especially, where the general direction is south-east or south-west. Local winds of this latter type receive a great variety of names in different parts of the Mediterranean and surrounding regions (see *LEVECHE*, *LESTE*, *KHAMSIN*, *SIMOOM*).

SIROHI, a native state of India, in the Rajputana agency. Area 1964 sq. m. The country is much broken up by hills and rocky ranges; the Aravalli range divides it into two portions, running from north-east to south-west. The south and south-east part of the territory is mountainous and rugged, containing the lofty Mount Abu, an isolated mass of granite rock, culminating in a cluster of hills, enclosing several valleys surrounded by rocky ridges, like great hollows. On both sides of the Aravallis the country is intersected with numerous water channels, which run with considerable force and volume during the height of the rainy season, but are dry for the greater part of the year. The only river of any importance is the Western Banas. A large portion of the state is covered with dense jungle, in which wild animals, including the tiger, bear and leopard, abound. Many splendid ruins bear witness to the former prosperity and civilization of the country. The climate is on the whole dry; in the south and east there is usually a fair amount of rain. On Abu the average annual rainfall is about 64 in., whereas in Erinpura, less than 50 m. to the north, the average fall is only between 12 and 13 in. Pop. (1901) 154,544, showing a decrease of 17% in the decade, due to the results of famine. Gross revenue £28,000, tribute £450.

During the early years of the 19th century, Sirohi suffered much from wars with Jodhpur and the wild Mina hill tribes. The protection of the British was sought in 1817; the pretensions of Jodhpur to suzerainty over Sirohi were disallowed, and in 1823 a treaty was concluded with the British government. For services rendered during the Mutiny of 1857 the chief received a remission of half his tribute. The chief, whose title is maharao, is a Deora Rajput of the Chauhan clan, and claims descent from the last Hindu king of Delhi. The state is traversed by the Rajputana railway.

The town of **SIROHI** is 28 m. N. of Abu-road station. Pop. (1901) 5651. It has manufactures of sword-blades and other weapons. The Crosthwaite hospital, which is built and equipped on modern principles, was opened by Sir Robert Crosthwaite in December 1897.

SIRSA, a town of British India, in Hissar district of the Punjab, situated on a dry bed of the river Ghaggar, and on a branch of the Rajputana railway, midway between Rewari and Ferozepur. Pop. (1901) 15,800. It occupies an ancient site, and was refounded in 1837 as the head-quarters of a British district. It is an important centre of trade with Rajputana, and has manufactures of cotton cloth and pottery. The former district of

Sirsa was part of the territory conquered from the Mahrattas in 1803, when it was almost entirely uninhabited. It required reconquering from the Bhattis in 1818; but it did not come under British administration until 1837. During the Mutiny of 1857 Sirsa was for a time wholly lost to British rule. On the restoration of order the district was administered by Punjab officials, and in the following year, with the remainder of the Delhi territory, it was formally annexed to that province. In 1884 it was subdivided between the districts of Hissar and Ferozepur.

SIS (anc. *Sision* or *Siskia*, later *Flaviopolis* or *Flavias*), the chief town of the Khozan sanjak of the Adana vilayet of Asiatic Turkey, situated on the left bank of the Kirkgen Su, a tributary of the Jihün (Pyramus) and at the south end of a group of passes leading from the Anti-Taurus valleys to the Cilician plain and Adana. It was besieged by the Arabs in 704 but relieved by the Byzantines. The Caliph, Motawakkil took it and refortified it; but it soon returned to Byzantine hands. It was rebuilt in 1186 by Leo II., king of Lesser Armenia, who made it his capital. In 1374 it was taken and demolished by the sultan of Egypt, and it has never recovered its prosperity. It is now only a big village of some 3000 inhabitants. It has had, however, a great place in Armenian ecclesiastical history from the times of St Gregory the Illuminator to our own. Gregory himself was there consecrated the first Catholicus in A.D. 267, but transferred his see to Vagarshabad (Echmiadzin, Etchmiadzin), whence, after the fall of the Arsacids, it passed to Tovin. After the constitution of the kingdom of Lesser Armenia, the catholicate returned to Sis (1294), the capital, and remained there 150 years. In 1441, Sis having fallen from its high estate, the Armenian clergy proposed to remove the see, and on the refusal of the actual Catholicus, Gregory IX., installed a rival at Echmiadzin, who, as soon as Selim I. had conquered Greater Armenia, became the more widely accepted of the two by the Armenian church in the Ottoman empire. The Catholicus of Sis maintained himself nevertheless, and was supported in his pretensions by the Porte up to the middle of the 19th century, when the patriarch Nerses, declaring finally for Echmiadzin, carried the government with him. In 1885 Sis tried to declare Echmiadzin schismatic, and in 1895 its clergy took it on themselves to elect a Catholicus without reference to the patriarch; but the Porte annulled the election, and only allowed it six years later on Sis renouncing its pretensions to independence. The present Catholicus has the right to prepare the sacred *myron* (oil) and to preside over a synod, but is in fact not more than a metropolitan, and regarded by many Armenians as schismatic. The lofty castle and the monastery and church built by Leo II., and containing the coronation chair of the kings of Lesser Armenia, are interesting.

(D. G. H.)

SISAL HEMP, or **HENEQUEN**, of Florida and the Bahamas, the product of *Agave rigida*, variety *sisalana*, a native of Yucatan, but found in other parts of Central America and distributed to the West Indies, where it is being increasingly cultivated.

Agave (*q.v.*) is a member of the order Amaryllidaceae; and a well-known species of the genus, *Agave americana*, the century plant, will suggest the habit of the sisal hemp, which, however, differs in the absence of prickles along the margin of the fleshy leaf. After six or seven years the flowering stalk or "pole" develops from the centre of the leaf-cluster, and grows to the height of 15 or 20 ft. The flowers are borne in dense clusters at the ends of short lateral branches, and closely resemble those of *Agave americana*. After they have begun to wither, buds are developed from the point of union with the flower-stalk; these form tiny plants, which, when several inches long, become detached and fall to the ground. Those that fall in a suitable place take root and are soon large enough to transplant. After flowering the plant perishes, but is renewed by suckers springing from the base of the stem; these suckers are then planted, and the leaves should be ready for cutting in about four years. The other method of planting is by means of "pole" plants just described.

In collecting the fibre the leaves are cut off at the base, the spine at the top end removed, and the leaves carried in bundles to the machines. Here two scraping wheels remove the pulp

from the leaves. The leaves are put into the machine at one side, and delivered clean at the other. One half is cleaned by the first wheel, then the cleaned portion is held while the second wheel cleans the remainder of the leaf; all the operations are automatically performed. In Yucatan, the leaves measure from 4 to 5 ft. in length, about 4 in. in width, and $\frac{1}{2}$ in. in thickness. They are lance-shaped and weigh from $1\frac{1}{2}$ lb to $1\frac{3}{4}$ lb on an average. As only about 3 to 4% of the weight is available for fibre, the average yield of 1000 leaves is from 50 to 60 lb. The yield per acre is estimated at about half a ton. It has been proposed to treat the pulp, &c., with a view to extracting the chemical substances, but we are not aware that any successful attempt has been made. The fibre is yellowish-white, straight, smooth and clean, and a valuable cordage fibre second only to manila fibre in strength. It is used extensively for cordage and binder twine, both alone and in conjunction with manila, and is also used for bags, hammocks and similar articles.

The plants thrive on arid rocky land, growing, for instance, on the Florida Keys upon the almost naked coral rock. Their northern limit of cultivation is determined by frost, which the plants will not stand; in Florida this is represented by the line of 27° N. An inferior fibre is obtained from the leaves of another species, *Agave decipiens*, which is found wild along the coasts and keys of Florida. It is known as the false sisal hemp, and can at once be distinguished from true sisal by its spiny leaf-margin.

SISKIN (Dan. *sidsken*, Ger. *Zeisig* and *Zeising*), long known in England as a cage-bird called by dealers the Aberdévine or Abadavine, names of unknown origin, [the *Fringilla spinus* of Linnaeus, and *Carduelis spinus* of modern writers, belongs to the Passerine family *Fringillidae*. In some of its structural characters it is most nearly allied to the goldfinch (*q.v.*), and both are placed in the same genus by systematists; but in its style of coloration, and still more in its habits; it resembles the redpolls (cf. LINNET), though without their slender figure, being indeed rather short and stout of build. Yet it hardly yields to them in activity or in the grace of its actions, as it seeks its food from the catkins of the alder or birch, regardless of the attitude it assumes while so doing. Of an olive-green above, deeply tinted in some parts with black and in others lightened by yellow, and beneath of a yellowish-white again marked with black, the male of this species has at least a becoming if not a brilliant garb, and possesses a song that is not unmelodious, though the resemblance of some of its notes to the running-down of a piece of clockwork is more remarkable than pleasing. The hen is still more soberly attired; but it is perhaps the siskin's disposition to familiarity that makes it so favourite a captive, and, though as a cage-bird it is not ordinarily long-lived, it readily adapts itself to the loss of liberty. Moreover, if anything like the needful accommodation be afforded, it will build a nest and therein lay its eggs; but it rarely succeeds in bringing up its young in confinement. As a wild bird it breeds constantly, though locally, throughout the greater part of Scotland, and has frequently done so in England, but more rarely in Ireland. The greater portion, however, of the numerous bands which visit the British Islands in autumn and winter doubtless come from the Continent—perhaps even from far to the eastward, since its range stretches across Asia to Japan, in which country it is as favourite a cage-bird as with us. The nest of the siskin is very like that of the goldfinch, but seldom so neatly built; the eggs, except in their smaller size, much resemble those of the greenfinch (*q.v.*).

A larger and more brightly coloured species, *C. spinoides*, inhabits the Himalayas, but the siskin has many other relatives belonging to the New World, and in them serious modifications of structure, especially in the form of the bill, occur. Some of these relatives lead almost insensibly to the greenfinch (*ut supra*) and its allies, others to the goldfinch (*ut supra*), the redpolls and so on. Thus the siskin perhaps may be regarded as one of the less modified descendants of a stock whence such forms as those just mentioned have sprung. Its striated plumage also favours this view, as an evidence of permanent immaturity or generalization of form, since striped feathers are so often the earliest clothing of many of these birds, which only get rid of them at their first moult. On this theory the yellowbird or North-American "goldfinch," *C. tristis*, would seem, with its immediate allies, to rank among the highest forms of the group, and the pine-goldfinch, *C. pinus*, of the same country, to be one of the lowest—

the cock of the former being generally of a bright yellow hue, with black crown, tail and wings—the last conspicuously barred with white, while neither hens nor young exhibit any striations. On the other hand, neither sex of the latter at any age puts off its striped garb—the mark, it may be pretty safely asserted, of an inferior stage of development. The remaining species of the group, mostly South-American, do not seem here to need particular notice. (A. N.)

SISLEY, ALFRED (1840–1899), French landscape painter, was born in Paris in 1839, of English parents. He studied painting under Gleyre, and was afterwards influenced, first by Corot, and then by the impressionists Monet and Renoir. He worked both in France and in England, and made the Seine, the Loing and the Thames the subjects of many pictures that are remarkable for the subtle appreciation of the most delicate colour effects. Success was not given him during his life, which was one of constant poverty and hard struggle. Purchasers of his pictures were few and far between, although the prices rarely exceeded a few pounds. Only after his death, which occurred at Moret-sur-Loing in 1899, did his work find appreciation, and at the Viau sale in Paris, in 1907, his small painting of "The Seine at Port-Marly" realized £652, whilst ten other landscapes sold at prices ranging from £200 to £400. He was essentially a colourist who, like Monet, delighted in recording the changing effects of light in the successive hours of the day, and paid very little attention to composition and draughtsmanship. The impressionist exhibition at the Grafton Galleries, London, in 1905, included several characteristic examples of his work. Sisley is also represented at the Luxembourg in the Caillebotte collection.

SISMONDI, JEAN CHARLES LEONARD DE (1773–1842), whose real name was Simonde, was born at Geneva, on the 9th of May 1773. His father and all his ancestors seem to have borne the name Simonde, at least from the time when they migrated from Dauphiné to Switzerland at the revocation of the edict of Nantes. It was not till after Sismondi had become an author that, observing the identity of his family arms with those of the once flourishing Pisan house of the Sismondi, and finding that some members of that house had migrated to France, he assumed the connexion without further proof and called himself De Sismondi. The Simondes, however, were themselves citizens of Geneva of the upper class, and possessed both rank and property, though the father was also a village pastor. The future historian was well educated, but his family wished him to devote himself to commerce rather than literature, and he became a banker's clerk at Lyons. Then the Revolution broke out, and as it affected Geneva the Simonde family took refuge in England, where they stayed for eighteen months (1793–1794). Disliking, it is said, the climate, they returned to Geneva, but found the state of affairs still unfavourable; there is even a legend that the head of the family was reduced to sell milk himself in the town. The greater part of the family property was sold, and with the proceeds they emigrated to Italy, bought a small farm at Pescia near Lucca, and set to work to cultivate it themselves. Sismondi worked hard here, both with his hands and his mind, and his experiences gave him the material of his first book, *Tableau de l'agriculture toscane*, which, after returning to Geneva, he published there in 1801. In 1803 he published his *Traité de la richesse commerciale*, his first work on the subject of political economy, which, with some differences of view, continued to interest him to the end of his life.

As an economist, Sismondi represented a humanitarian protest against the dominant orthodoxy of his time. In his first book he followed Adam Smith, but in his principal subsequent economic work, *Nouveaux Principes d'économie politique* (1819), he insisted on the fact that economic science studied the means of increasing wealth too much, and the use of wealth for producing happiness too little. He was not a socialist; but, in protesting against *laissez faire* and invoking the intervention of government "to regulate the progress of wealth," he was an interesting precursor of the German "socialists of the chair."

Meanwhile he began to compile his great *Histoire des Républiques Italiennes du moyen âge*, and was introduced to Madame de Stael. With her he became very intimate, and after being

regularly enrolled in the society of Coppet he was invited or commanded (for Madame de Stael's invitations had something of command) to form one of the suite with which the future Corinne made the journey into Italy, resulting in *Corinne* itself during the years 1804–1805. Sismondi was not altogether at his ease here, and he particularly disliked Schlegel, who was also of the company. But during this journey he made the acquaintance of the countess of Albany, Louisa of Stolberg, widow of Charles Edward, and all her life long gifted with a singular faculty of attracting the affection (Platonic and other) of men of letters. She was now an old woman, and Sismondi's relations with her were of the strictly friendly character, but they were close and lasted long, and they produced much valuable and interesting correspondence. In 1807 appeared the first volumes of the above mentioned book on the Italian republics, which (though his essay in political economy had brought him some reputation and the offer of a Russian professorship) first made Sismondi prominent among European men of letters. The completion of this book, which extended to sixteen volumes, occupied him, though by no means entirely, for the next eleven years. He lived at first at Geneva, and delivered there some interesting lectures on the literature of the south of Europe, which were continued from time to time and finally published; and he held an official post—that of secretary of the chamber of commerce for the then department of Lemman. In 1813 he visited Paris for the first time, and abode there for some time, mixing much in literary society. Although a Liberal and in his earlier days almost an Anglo-maniac, he did not welcome the fall of the empire. During the Hundred Days he defended Napoleon's constitutional schemes or promises, and had an interview with the emperor himself, which is one of the chief events of a not very eventful life. After the Restoration he left Paris. On completing (1817) his great book on the Italian republics, he undertook (1818) a still greater, the *Histoire des Français*, which he planned on a vast scale, and of which during the remaining twenty-three years of his life he published twenty-nine volumes. His untiring industry enabled him to compile many other books, but it is on these two that his fame chiefly rests. The earlier displays his qualities in the most favourable light, and has been least injuriously affected by subsequent writings and investigations; but the *Histoire des Français*, as a careful and accurate sketch on the great scale, has now been superseded. Sainte-Beuve has with benevolent sarcasm surnamed the author "the Rollin of French History," and the praise and the blame implied in the comparison are both perfectly well deserved. In April 1819 Sismondi married an English lady, Miss Allen, whose sister was the wife of Sir James Mackintosh, and the marriage appears to have been a very happy one. His later years were chiefly spent at Geneva, in the politics of which city he took a great, though as time and changes went on a more and more chagrined, interest. Indeed, in his later days he became a kind of reactionary. He died at Geneva on the 25th of June 1842.

Besides the works above mentioned he had executed many others, his custom for a long period of years being never to work less than eight hours a day. The chief of these are *Littérature du midi de l'Europe* (1813), an historical novel entitled *Julia Severa ou l'an 492* (1822), *Histoire de la Renaissance de la liberté en Italie* (1832), *Histoire de la chute de l'empire romain* (1835), *Précis de l'histoire des Français*, an abridgment of his own book (1839), with several others, chiefly political pamphlets.

Sismondi's journals and his correspondence with Channing, with the countess of Albany and others have been published chiefly by Mlle. Mongolfier (Paris, 1843) and M. de Saint-René Taillandier (Paris, 1863). The latter work serves as the chief text of two admirable *Lundis* of Sainte-Beuve (September 1863), republished in the *Nouveaux Lundis*, vol. vi.

SISSEK (Hungarian, *Sziszsek*; Croatian, *Sisak*), a town of Croatia-Slavonia, in the county of Agram; situated at the confluence of the Save and Kulpa, 30 m. by rail S.E. by S. of Agram. Pop. (1900) 7047. Sissek has a considerable trade in grain and timber. Its only noteworthy building is an ancient castle, constructed of brick.

As the vestiges of its Roman walls tend to prove, Sissek was a large and flourishing city under Roman rule. Augustus made it

a military station; Tiberius chose it as his headquarters against the Pannonian rebels; and from Septimius Severus, who made it the centre of a military government, it gained the name of *Septimia Sissia*. A *Segesta*, on the Save, is mentioned by Appian, and Strabo distinguishes between this town and the neighbouring *Siscia*. It seems likely, as St Aymour suggests, that two towns, the native *Segesta* and the Roman fortress called by Strabo *ἡ Σίσκία Φρούριον*, ultimately united under the single name of *Siscia*. In the 3rd century, under Gallienus and Probus, the city contained the chief imperial mint and treasury; and an engraved coffer, found in Croatia, dating from the 4th century, and representing the five foremost cities of the Empire, includes *Siscia* along with Rome, Byzantium, Carthage and Nicomedia. Its bishopric was removed to Salona, in 441, when Attila appeared, and thenceforward the city declined. For a brief period, in the 7th and 8th centuries, the conquering Slavs made it one of their *Zupanates*, or governments; but in the 10th century it was sacked by the Magyars, and in 1092 its territories were bestowed upon the cathedral chapter of Agram by Ladislaus I., king of Hungary. Under the walls of its castle, built by this chapter in 1544, the Turks were thrice defeated in 1593. At a fourth venture the city fell, only to be evacuated in 1594. It witnessed a final Turkish defeat in 1641.

See C. de St Aymour, *Les Pays sud-slaves de l'Autriche-Hongrie* (1883), ch. ii.

SISTER, the correlative of brother (*q.v.*), a female in her relation to the other children born of the same parents, also one who has acquired such relationship by marriage, a sister-in-law, or by adoption. The O. Eng. word was *sweostor*; cf. Dutch *zuster*, Ger. *Schwester*, Goth. *swistar*; in M. Eng. this appears as *suster*; the Scandinavian form appears in Icel. *systir*, Swed. *systor*, Dan. *søstor*, and this has curiously taken the place of the true English form *suster*. Outside Teut. are found Lat. *soror* for *sosor*, Skt. *svasti*; the origin is not known, but it may be related with Skt. *svasti*, happiness, joy. The Lat. *consobrinus*, which has given "cousin," is from *con-sobrinus*, *sobrinus*, from the stem of *soror*, sister. As "brother" and "brethren" are used for the male members of a religious body or community, so also is "sister" for the female members; more particularly it is applied to the members of a female religious order or community, a "sisterhood," in the Roman and other churches, who are devoted to a religious life, works of charity or mercy, whether bound by irrevocable vows or not.

SISTERHOODS (MODERN ANGLICAN). The dissolution of religious houses in England (1536-1540) under Henry VIII. swept away more than 140 nunneries, and the Anglican Church was left without sisterhoods for three centuries. But as these had for 900 years formed part of her system, there were protests from time to time and attempts at restoration. Amongst such protests, which generally dwelt a good deal on the want of provision for unmarried women, may be mentioned three in successive centuries. The historian Fuller would have been glad "if such feminine foundations had still continued," those "good shee-schools," only without vows (Bk. vi.). Richardson the novelist, in *Sir Charles Grandison*, wishes there could be a Protestant nunnery in every county, "with a truly worthy divine, at the appointment of the bishop of the diocese, to direct and animate the devotion of such a society"; in 1829 the poet Southey, in his *Colloquies* (cxiii.), trusts that "thirty years hence this reproach also may be effaced, and England may have its Béguines and its sisters of mercy. It is grievously in need of them." Also small practical efforts were made in the religious households of Nicholas Ferrar at Little Gidding, 1625, and of William Law at King's Cliffe, 1743; and under Charles II., says Fr. Bede, *Autob.*, "about 12 Protestant ladies of gentle birth and considerable means" founded a shortlived convent, with Sancroft, then Dean of St Paul's, for director.

Southey's appeal had weight, and before the thirty years had passed, compassion for the needs of the destitute in great cities, and the impulse of a strong Church revival, aroused a body of laymen, among whom were included Mr Gladstone, Sir T. D. Acland, Mr A. J. Beresford-Hope, Lord Lyttelton

and Lord John Manners (chairman), to exertions which restored sisterhoods to the Church of England. On 26th March 1845 the Park Village Community was set on foot in Regent's Park, London, to minister to the poor population of St Pancras. The "Rule" was compiled by Dr Pusey, who also gave spiritual supervision. In the Crimean War the superior and other sisters went out as nurses with Florence Nightingale. The community afterwards united with the Devonport Sisters, founded by Miss Sellon in 1849, and together they form what is known as Ascot Priory. The St Thomas's sisterhood at Oxford commenced in 1847; and the present mother-superior of the Holy Trinity Convent at Oxford, Marian Hughes, dedicated herself before witnesses to such a life as early as 1841 (Liddon's *Life of Dr Pusey*, iii.).

Four sisterhoods stand together as the largest: those of Clewer, Wantage, All Saints and East Grinstead; and the work of the first may stand as a specimen of that of others. The "Community of St John the Baptist" at Clewer, near Windsor, arose in 1849 through the efforts of Mrs Tennant and the vicar, afterwards warden of the society, the Rev. T. T. Carter, to save fallen women. Under the first superior, Harriet Monsell, the numbers grew apace, and are now above 200. Their services to society and the Church include 6 houses for fallen women, 7 orphanages, 9 elementary and high schools and colleges, 5 hospitals, mission work in 13 parishes and visiting in several "married quarters" of barracks. Many of these are important institutions, and their labours extend over a wide area; two of the settlements are in India and two in the United States. A list of 26 sisterhoods is given in the *Official Year-Book of the C.E.* (1900), to which may be added 10 institutions of deaconesses, many of whom live in community under rule. The Episcopal Church of Scotland has 3 sisterhoods; and they are found also at Toronto, "Saint John the Divine"; Brisbane, "Sacred Advent"; Grahamstown, "Resurrection"; Bloemfontein, "St Michael and All Angels"; Maritzburg, "Saint John the Divine." The *Year-Book* (1911) of the Protestant Episcopal Church of America (Anglican) mentions 18 American sisterhoods and 7 deaconess homes and training colleges.

Practically all Anglican sisterhoods originated in works of mercy, and this fact largely accounts for the rapidity with which they have won their way to the good will and confidence of the Church. Their number is believed to exceed 3000, and the demand for their services is greater than the supply. Bishops are often their visitors, and Church Congresses, Convocation and Lambeth Conferences have given them encouragement and regulation. This change in sympathy, again, has gained a hearing from modern historians, who tend more and more to discredit the wholesale defamation of the dissolution period. This charitable activity, however, distinguishes the modern sister from the nuns of primitive and medieval times, who were cloistered and contemplative, and left external works to deaconesses, or to laywomen of a "third order," or to the freer societies like the Béguines. St Vincent de Paul is considered to have begun the new era with his institution of "Sisters of Charity" in 1634. Another modern feature is the fuller recognition of family ties: Rule 29 of the Clewer sisters directs that "the sisters shall have free intercourse with relations, who may visit them at any time." But in most essential respects modern sisterhoods follow the ancient traditions. They devote themselves to the celibate life, have property in common, and observe a common rule of prayer, fellowship and work. Government is by a sister superior, assisted by various officers. The warden and chaplain are clergy, and the visitor is commonly a bishop. In one important regard there has been hesitation, and authorities like Dr Littledale and Bishop Grafton contend strongly for the primitive ideal of the convent as family, with a constitutional government, as against the later and widespread Jesuit ideal of the convent as regiment, with a theory of despotic rule and absolute obedience. If some early mistakes in the restoration of sisterhoods were due to this exaggerated doctrine of obedience, the doctrine itself may be trusted to disappear among a Church and people accustomed to free institutions and to respect for individuality.

AUTHORITIES.—T. T. Carter, *Memoir of Harriet Monsell*; Dr R. F. Littledale, Papers on "Sisterhoods" in the *Monthly Packet* (July 1874-November 1879); Parl. Report on *Convent. and Monast. Inst.* (1870); Lina Eckenstein, *Woman under Monasticism*; Bishop Grafton, *Vocation*. (J. O. N.)

SISTOVA (Bulg. *Svishtov*), the capital of the department of Sistova, Bulgaria, on the right bank of the Danube, 40 m. W.

of Rustchuk. Pop. (1906), 13,408. Despite the lack of railway communication, and the migration of the Turkish inhabitants after the Russo-Turkish War (1877-1878), Sistova is an important commercial centre, exporting wine and grain and importing petroleum.

Sistova is identified with the Roman colony *Novae* mentioned by Ptolemy. The exact site appears to have been Staklen, to the west of the present town, which has gradually moved eastward since the 16th century, when it was almost destroyed in the Turkish wars. It was at Sistova that the peace of 1790 was signed, by which the Austrian-Turkish boundary was determined. The town was burned in 1810 by the Russians; but after 1820 it began to revive, and the introduction of steam traffic on the lower Danube (1835) restored its prosperity. The Walachian town of Alexandria was founded by fugitives from Sistova in 1878.

SISTRUM (Gr. *σείστρον*, Ger. *Rappel*), an ancient Egyptian instrument of percussion of indefinite musical pitch, a kind of metal rattle. The sistrum consists of a metal frame in the shape of an egg, fastened to a handle, frequently surmounted by a grotesque head or by a figure of the sacred lioness Sekhet. The frame is crossed by four metal horizontal rods passing through holes large enough to allow them to rattle when the sistrum is shaken, the rods being prevented from slipping out altogether by little metal stops in the shape of a leaf; sometimes metal rings are threaded over the rods to increase the jingling. The sistrum is played also by beating it with a metal stick. This ancient instrument was extensively used by the priests in the temple of Isis to attract the attention of worshippers to different parts of the ritual. The Egyptians attributed to it, as well as to the tambourine, the power of dispersing and terrifying evil spirits and more especially the Typhon. Queen Cleopatra¹ made use of a large number of sistra at the battle of Actium (31 B.C.), and accordingly the instrument was satirically called Queen Cleopatra's war trumpet. (K. S.)

SISYPHUS, in Greek mythology, son of Aeolus and Enarete, and king of Ephyra (Corinth). He was the father of the sea-god Glaucus and (in post-Homeric legend) of Odysseus. He was said to have founded the Isthmian games in honour of Melicertes, whose body he found lying on the shore of the Isthmus of Corinth (Apollodorus iii. 4). He promoted navigation and commerce, but was avaricious and deceitful. From Homer onwards Sisyphus was famed as the craftiest of men. When Death came to fetch him, Sisyphus put him into fetters, so that no one died till Arcs came and freed Death, and delivered Sisyphus into his custody. But Sisyphus was not yet at the end of his resources. For before he died he told his wife that when he was gone she was not to offer the usual sacrifice to the dead. So in the under world he complained that his wife was neglecting her duty, and he persuaded Hades to allow him to go back to the upper world and expostulate with her. But when he got back to Corinth he positively refused to return, until forcibly carried off by Hermes (Schol. on Pindar, *Ol.* i. 97). In the under world Sisyphus was compelled to roll a big stone up a steep hill; but before it reached the top of the hill the stone always rolled down, and Sisyphus had to begin all over again (*Odyssey*, xi. 593). The reason for this punishment is not mentioned in Homer, and is obscure; according to some, he had revealed the designs of the gods to mortals, according to others, he was in the habit of attacking and murdering travellers. The subject was a commonplace of ancient writers, and was depicted by the painter Polygnotus on the walls of the Lesche at Delphi (Pausanias x. 31). According to the solar theory, Sisyphus is the disk of the sun that rises every day and then sinks below the horizon. Others see in him a personification of the waves rising to a height and then suddenly falling, or of the treacherous sea. It is suggested by Welcker that the legend is symbolical of the vain struggle of man in the pursuit of knowledge. The name Sisyphus is generally explained as a reduplicated form of *σοφός* (= "the very wise"); Gruppe, however, thinks it may be connected with *σίστυς* ("a

goat's skin"), the reference being to a rain-charm in which goats' skins were used. S. Reinach (*Revue archéologique*, 1904) finds the origin of the story in a picture, in which Sisyphus was represented rolling a huge stone up Acrocorinthus, symbolical of the labour and skill involved in the building of the Sisyphæum. When a distinction was made between the souls in the under world, Sisyphus was supposed to be rolling up the stone perpetually as a punishment for some offence committed on earth; and various reasons were invented to account for it.

The way in which Sisyphus cheated Death is not unique in folk-tales. Thus in a Venetian story the ingenious Beppo ties up Death in a bag and keeps him there for eighteen months; there is general rejoicing; nobody dies, and the doctors are in high feather. In a Sicilian story an innkeeper corks up Death in a bottle; so nobody dies for years, and the long white beards are a sight to see. In another Sicilian story a monk keeps Death in his pouch for forty years (T. F. Crane, *Italian Popular Tales*, 1885). The German parallel is Gambling Hansel, who kept Death up a tree for seven years, during which no one died (Grimm, *Household Tales*). The Norse parallel is the tale of the Master Smith (E. W. Dasent, *Popular Tales from the Norse*). For a Lithuanian parallel, see A. Schleicher, *Litauische Märchen, Sprichworte, Rätsel und Lieder* (1857); for Slavonic parallels, F. S. Krauss, *Sagen und Märchen der Südslaven*, ii. Nos. 125, 126; see also Frazer's *Pausanias*, iii. p. 33; O. Gruppe, *Griechische Mythologie* (1906), ii., p. 1021, note 2.

SITAPUR, a town and district of British India in the Lucknow division of the United Provinces. The town is on the river Sarayan, half-way between Lucknow and Shahjahanpur, and on the Lucknow-Bareilly railway, 55 m. N.W. from Lucknow. Pop. (1901) 22,557. It is a cantonment, garrisoned by a portion of a British regiment. It has a considerable trade, principally in grain.

The DISTRICT OF SITAPUR has an area of 2250 sq. m. It presents the appearance of a vast plain, sloping imperceptibly from an elevation of 505 ft. above sea-level in the north-west to 400 ft. in the south-east. The country is well-wooded with numerous groves, and well cultivated, except in those parts where the soil is barren and cut up by ravines. It is intersected by numerous streams, and contains many shallow ponds and natural reservoirs, which overflow during the rains, but become dry in the hot season. Except in the eastern portion, which lies in the doabs between the Kewani and Chauka and the Gogra and Chauka rivers, the soil is as a rule dry, but even this moist tract is interspersed with patches of land covered with saline efflorescence called *reh*. The principal rivers are the Gogra, which is navigable by boats of large tonnage throughout the year, and the Chauka. The climate is considered healthy, and the cantonments of Sitapur are famous for the low mortality of the British troops stationed there. The annual rainfall averages about 38 in.

In 1901 the population was 1,175,473, showing an increase of 9% in the decade. The principal crops are wheat, rice, pulses, millets, barley, sugar-cane and poppy. The district is traversed by the Lucknow-Bareilly section of the Rohilkhand and Kumaon railway. The history of Sitapur is closely associated with that of the rest of Oudh. The district figured prominently in the Mutiny of 1857, when the native troops quartered in the cantonments fired on their officers, many of whom were killed, as were also several military and civil officers, with their families, in attempting to escape.

See *Sitapur District Gazetteer* (Allahabad, 1905).

SITKA (formerly New Archangel), a city and historically the most notable settlement of Alaska, on the W. coast of Baranof Island, in Sitka Sound, in lat. 57° 03' N. and long. 135° 19' W. (from Greenwich), and about 100 m. S.S.W. of Juneau. Pop. (1890) 1193 (300 white and 893 natives); (1900) 1396. It is served by steamer from Seattle, Washington; there is cable connexion with the United States, and a six-day mail service from Pacific ports, via Juneau. The city is prettily situated on an island-studded and mountain-locked harbour, with a background of forest and snow-capped mountain cones; an extinct volcano, Mt Edgcumbe (3467 ft.), on Krúzof Island, is a conspicuous landmark in the bay. Sitka's mean annual temperature is 2° higher than that of Ottawa, and its climate is more equable. The mean annual temperature is about 43° F.; the

¹Virgil, *Aen.* viii. 696; Lucan x. 63; Ovid, *Am.* ii. 13. 11; Mart xiv. 54.

monthly means range from 33° (January) to 56° (August), and the extreme recorded temperature from -4° to 87° F. Two-thirds of the days of the year are cloudy; on about 208 days in the year it rains or snows; the normal rainfall is 88.1 in., the extreme recorded rainfall (in 1886) is 140.26 in. The city includes an American settlement and an adjoining Indian village. In addition to U.S. government buildings (marine hospital and barracks, agricultural experiment station, wireless telegraph station and magnetic observatory), there are two public schools (one for whites and one for Thlinkets), the Sheldon Jackson (ethnological) Museum, which is connected with the Presbyterian Industrial Training School, a parochial school of the Orthodox Greek (Russian) Church, a Russian-Greek Church, built in 1816, and St Peter's-by-the-Sea, a Protestant Episcopal mission, built in 1899. Sitka is the see of a Greek Catholic and of a Protestant Episcopal bishop. In its early history it was the leading trading post of Alaska. After the discoveries of gold in the last decade of the 19th century it wholly lost its commercial primacy, but business improved after the discovery of gold in 1905 on Chicagoff Island, about 50 m. distant. There is a very slight lumber industry; salmon fisheries are of greater importance. In the surrounding region there are gold and silver mines.

Old Sitka or Fort Archangel Gabriel, about 6 m. from the present town, was founded in May 1799. The fort was overwhelmed by the Thlinkets in 1802, but was recaptured by the Russians in September 1804. The settlement was removed at this time by Alexander Baranof to the present site. Thereafter until 1867 it was the chief port and (succeeding Kodiak) the seat of government of Russian America; it is still the headquarters of the Assistant Orthodox Greek bishop of the United States. The formal transfer of Alaska from Russian to American possession took place at Sitka on the 18th of October 1867. During the next ten years Alaska was governed by the department of war, and Sitka was an army post. It was the seat of government of Alaska until 1906, when Juneau became the capital.

SITTINGBOURNE, a market town in the Faversham parliamentary division of Kent, England, on a navigable creek of the Swale, 44½ m. E.S.E. of London by the South Eastern and Chatham railway. Pop. of urban district (1901) 8943. It consists principally of one long street (the Roman Watling Street) and the northern suburb of Milton, a separate urban district (pop. 7086), celebrated for its oysters, the fishery of which used to employ a large number of the inhabitants. Brick and cement making is an important industry, and there are corn and paper mills. The export trade in corn and import trade in coal is considerable. St Michael's church, originally Early English, underwent extensive restoration in 1873. An earthwork known as Castle Rough, in the marshes below Milton, was probably the work of Hasten the Dane in 892, and Bayford Castle, a mile distant, occupies the site of one said to have been built in opposition by King Alfred. Tong Castle is about 2 m. E. of Sittingbourne. It consists of a high mound surrounded by a moat, and is said to have been erected by Hengest. Fragments of masonry exist about the mound. The story of the founding of the castle resembles that connected with the city of Carthage. Vortigern is said to have granted Hengest as much land as an ox-hide could encompass, and the hide being cut into strips the site of Tong Castle was accordingly marked out. The same tradition attaches to Tong Castle in Shropshire. Tradition also asserts, according to the 12th century chronicler, Geoffrey of Monmouth, that it was in Tong Castle that Vortigern met Rowena, Hengest's daughter, and became so enamoured of her as to resign his kingdom to her father. In the time of Richard II. Tong Castle belonged to Edmund Mortimer, earl of March.

Sittingbourne (*Sædunburna*, *Sidynghourn*) is mentioned in Saxon documents in 989 and frequently in contemporary records of the 13th and 14th centuries. The first charter was not obtained until 1573, when it was incorporated by Elizabeth under the title of a "guardian and free tenants" of the town of Sittingbourne. A weekly market was granted, two fairs yearly at Whitsuntide and Michaelmas, and many other privileges. This charter obtained until in 1599 a second one incorporated the

town by the name of "mayor and jurats" and regranted the market and fairs together with some additional privileges, among others that of returning members to parliament, which, however, was never exercised.

SITTING BULL (c. 1837-1890), a chief and medicine man of the Dakota Sioux, was born on Willow Creek in what is now North Dakota about 1837, son of a chief named Jumping Bull. He gained great influence among the reckless and unruly young Indians, and during the Civil War led attacks on white settlements in Iowa and Minnesota. Though he had pretended to make peace in 1866, from 1869 to 1876 he frequently attacked whites or Indians friendly to whites. His refusal to return to the reservation in 1876, led to the campaign in which General George A. Custer (*q.v.*) and his command were massacred. Fearing punishment for his participation in the massacre, Sitting Bull with a large band moved over into Canada. He returned to the United States in 1881, and after 1883 made his home at the Standing Rock Agency. Rumours of a coming Indian Messiah who should sweep away the whites, and Indian dissatisfaction at the sale of their lands, created such great unrest in Dakota in 1889-1890 that it was determined to arrest Sitting Bull as a precaution. He was surprised and captured by Indian police and soldiers on Grand river on the 15th of December 1890, and was killed while his companions were attempting to rescue him.

SIVA, in Hindu mythology, a god who forms the supreme trinity with Brahma and Vishnu. As Brahma is the creator and Vishnu the preserver, so Siva is the destroyer. His name does not occur in the Vedas, but in later Hinduism he is an important divinity. Though Siva's personal appearance is fully described in the Puranas, it is in the form of the *linga* (phallic emblem) that he is almost universally worshipped. Death being a transition to a new form of life, the destroyer is really a re-creator, and thus Siva is styled the Bright or Happy One. He is exclusively a post-Vedic god, though he has been identified by the Hindus with the Rudra of the Vedas, and numerous features of Siva's character and history are developed from those of Rudra. See further BRAHMANISM and HINDUISM.

SIVAGANGA, a town of British India, in the Madura district of Madras, 25 m. E. of Madura. Pop. (1901) 9097. It contains the residence of a *zamindar*, whose estate covers an area of 1680 sq. m. and pays a permanent land revenue of £20,000. The succession has been the subject of prolonged litigation.

SIVAJI (1627-1680), founder of the Mahratta power in India, was born in May 1627. He was the son of Shahji Bhonsla, a Mahratta soldier of fortune who held a *jagir* under the Bijapur government. From an early age he excelled in horsemanship and the use of weapons, and regarded himself as appointed to free the Hindus from the Mahomedan yoke. With this object he formed a national party among the Hindus of the Deccan, and opposed in turn the vassal power of Bijapur and the imperial armies of the Mogul of Delhi. By dint of playing off his enemies against each other and by means of treachery, assassination and hard fighting, Sivaji won for the Mahrattas practical supremacy in western India. In 1659 he lured Afzul Khan, the Bijapur general, into a personal conference, and killed him with his own hand, while his men attacked and routed the Bijapur army. In 1666 he visited the Mogul emperor, Aurangzeb, at Delhi, but on his expressing dissatisfaction at not being treated with sufficient dignity, he was placed under arrest. Having effected his escape in a sweetmeat basket, he raised the standard of revolt, assumed the title of raja, and the prerogative of coining money in his own name. But whilst at the height of his power he died on the 5th of April 1680 at the age of fifty-three. Sivaji was an extraordinary man, showing a genius both for war and for peaceful administration; but he always preferred to attain his ends by fraud rather than by force. He is the national hero of the Mahrattas, by whom he is regarded almost as a deity.

See Grant Duff, *History of the Mahrattas* (1826); Krishnaji Ananta, *Life and Exploits of Sivaji* (1884); and M. G. Ranade, *Rise of the Maratha Power* (Bombay, 1900).

SIVAS, one of the largest and most important vilayets of Asia Minor, lying between 38° 30' and 41° N. and 35° 30' and 39° E. It is rich in mineral wealth—silver, lead, copper, iron, manganese, arsenic, alum, salt and coal; and has several hot and cold mineral springs, and large forests of fir, pine, beech and oak. The climate is good, the average elevation of the province being over 3500 ft., and the soil fertile. Wheat and barley are largely grown on the plateau, and in the lower districts there are extensive fruit orchards and vineyards. The port of the vilayet is Samsun (*q.v.*), whence a *chaussée* runs through Amasia, Tokat, and Sivas to Kharput; but Sivas is also connected by road with the minor Black Sea ports, Unieh, Ordu and Kerasund. The rates for transport are, however, prohibitive. Angora is the nearest railway point.

SIVAS (anc. *Megalopolis-Sebasteia*), altitude 4420 ft., is also the name of the chief town of the vilayet (and of a sanjak of the same name). It is situated in the broad valley of the Kizil Irmak, on one of its right bank tributaries, the Murdan Su. Pop. over 43,000, fully two-thirds Mussulman. The climate is healthy but severe in winter. Coarse cotton cloth and woollen socks are manufactured. The *medresses* (colleges), built in the 13th century by the Seljuk sultans of Rum, are amongst the finest remains of Moslem art in Asia Minor. In one of them is the tomb of its founder, Izz ud-din Kai Kāus I. (1210–1219). Near the town is the Armenian monastery of the Holy Cross, in which are kept the throne of Senekherim and other relics. There are several Armenian churches of interest, a flourishing American mission with church and schools, and a Jesuit mission. Under Diocletian Sebasteia became the capital of Armenia Minor, and in the 7th century that of the Sebasteia Theme. Justinian rebuilt the walls and, under the Byzantine emperors, it was second only to Caesarea in size and wealth. In 1021 Senekherim, king of the Armenian province of Vaspuragan (Van), ceded his dominions to Basil II., and became the Byzantine viceroy of Sebasteia and the surrounding country. This position was held by his successors until the town fell into the hands of the Turks after the defeat of Romanus II. by the Seljuks (1071). After having been ruled for nearly a century by the Danishmand amirs, it was taken (1172) by the Seljuk sultan of Rum, and in 1224 was rebuilt by Sultan Ala-ed-din Kaikobad I. In 1400, when captured by Timur, the city is said to have had 100,000 inhabitants, and to have been famous for its woollen stuffs. On this occasion the bravest defenders were massacred, and 4000 Armenians were buried alive. Mahommed the "Conqueror" restored the citadel, and the place has ever since been an important Ottoman provincial capital. Early in the 19th century, like all other Ottoman towns, it was terrorized by janissaries, with whom Mahmud II. commissioned the great Dere Bey of Yuzgat, Chapan Oglu, to deal in 1818. The news of his drastic success provoked a dangerous riot in Stambül, which postponed by some years the final tragedy of the janissaries. From 1880 to 1882 Sivas was the residence of the British military consul-general for Asia Minor; but it has now only an American vice-consulate. Mechithar, the founder of the Mechitharists (*q.v.*) and of the famous monastery at Venice, was born (1676) at Sivas.

(C. W. W., D. G. H.)

SIVORI, ERNESTO CAMILLO (1815–1894), Italian violinist, was born at Genoa on the 25th of October 1815, and was taught by Restano, Paganini, Costa and Dellepiane. His talent was extraordinarily precocious. From 1827 Sivori began the career of a travelling virtuoso, which lasted almost without interruption until 1864. He played Mendelssohn's concerto for the first time in England, in 1846, and was in England again in the seasons of 1851 and 1864. He lived for many years in Paris, and died at Genoa on the 18th of February 1894.

SIVRI-HISSAR, "Pointed-Castle," a town of Asia Minor, in the Angora vilayet, situated 8 m. N. of the site of Pessinus, at the foot of a lofty double-peaked ridge of rock, which bears the ruins of a Byzantine castle. It is a road and commercial centre, with a trade in opium and mohair. The population includes a large Armenian community. The town occupies the site of ancient *Palia*, re-founded and re-named Justinianopolis by the

emperor Justinian. It was one of the chain of fortresses on the Byzantine military road across Asia Minor, and became the chief city of Galatia Salutaris about A.D. 700, succeeding to the heritage of Pessinus, whose metropolitan transferred his seat to the new capital, and held the title of "archbishop of Pessinus or of Justinianopolis."

SIWA, an oasis in the Libyan Desert, politically part of Egypt. It is also known as the oasis of Ammon or Jupiter Ammon; its ancient Egyptian name was *Sekhet-am*, "Palm-land." The oasis lies about 350 m. W.S.W. of Cairo, its chief town, also called Siwa, being situated in 29° 12' N., 25° 30' E. The oasis is some 6 m. long by 4 to 5 wide. Ten miles north-east is the small oasis of Zetun, and westward of Siwa extends for some 50 m. a chain of little oases. The population of Siwa proper (1907 census) was 3884. The inhabitants are of Libyan (Berber) stock and have a language of their own, but also speak Arabic. The oasis is extremely fertile and contains many thousands of date palms. The town of Siwa is built on two rocks and resembles a fortress. The houses are frequently built on arches spanning the streets, which are narrow and irregular.

The oasis is famous as containing the oracle temple of Ammon, which was already famous in the time of Herodotus, and was consulted by Alexander the Great. The remains of the temple are in the walled village of Aghormi, 2 m. E. of the town of Siwa. It is a small building, with inscriptions dating from the 4th century B.C. The oracle fell into disrepute during the Roman occupation of Egypt, and was reported dumb by Pausanias, c. A.D. 160. Siwa was afterwards used as a place of banishment for criminals and political offenders. After the Mahommedan conquest of Egypt Siwa became independent and so remained until conquered by Mehemet Ali in 1820. It is now governed by its own sheikhs under the supervision of an Egyptian mamur responsible to the mudir of Behera.

Siwa contains many relics of antiquity besides the ruins of the temple of Ammon. Near that temple are the scanty remains of another temple of the same century, Umm Beda, with reliefs depicting the prince of the oasis making offerings to Ammon, "lord of oracles." At Jebel Muta, 1 m. N.E. of Siwa, are tombs of Ptolemaic and Roman date; 10 m. E. of Aghormi is a well-preserved chapel, with Roman graves; at Kasr Rumi is a Doric temple of the Roman period.

The oasis lies close to the Tripolitan frontier and is largely dominated by the sect of the Senussi (*q.v.*), whose headquarters were formerly at Jarabub, 80 m. to the north-west. The Senussi successfully prevented various explorers penetrating westward beyond Siwa. The first European to reach Siwa since Roman time was W. G. Browne, who visited the oasis in 1792. He was followed in 1798 by F. Hornemann. Both these travellers started from Cairo; in 1820 General H. Minutoli gained the oasis from the Gulf of Solum. In 1869 Gerhard Rohlfs reached Siwa via Tripoli, and subsequently the ruins were examined by Professor G. Steindorff. After the occupation of Egypt by the British steps were taken to enforce the authority of the government in Siwa, where order proved difficult to maintain. There were serious disturbances in 1909, and as a result in 1910 a telegraph line was built across the desert from Alexandria to the oasis.

See G. Steindorff, *Durch die Libysche Wüste zur Ammonoase* (Bielefeld and Leipzig, 1904); A. Silva White, *From Sphinx to Oracle* (London n.d., 1898); *Murray's Handbook for Egypt* (11th ed., London, 1907); T. B. Hohler, *Report on the Oasis of Siwa* (Cairo, 1900); also the works of the earlier travellers named. (F. R. C.)

SIWALIK HILLS, a name given to the foot-hills of the Himalayas in Dehra Dun district of the United Provinces of India, and in Nahan state and Hoshiarpur district of the Punjab. The range runs parallel with the Himalayan system from Hardwar on the Ganges to the banks of the Beas, with a length of 200 m. and an average width of 10 m. The elevation varies from 2000 to 3500 ft. Geologically speaking the Siwaliks belong to the tertiary deposits of the outer Himalayas, and are chiefly composed of low sandstone and conglomerate hills, the solidified and upheaved detritus of the great range in their rear. The intermediate valley lying between the outer hills and the Mussoorie

mountains is known as the Dehra Dun (or Dehra valley) and contains a considerable Eurasian colony and some British tea-planters. The principal pass is that of Mohan by which the main road from Saharapur to Dehra and Mussoorie traverses the range. The Siwalik formation (distinguished for its extraordinary wealth of palaeontological remains) is found on the North-West Frontier occupying much the same position relatively to the Suliman range as it does to the Himalayas, *i.e.* it faces the plains and becomes the outermost wall of the hills.

SIWARD (d. 1055), earl of Northumbria, was a Dane by birth and probably came to England with Canute. He became earl of Deira after the death of Eadwulf Cutel, earl of Northumbria, about 1038, and earl of all Northumbria after murdering Eadwulf, earl of Bernicia, in 1041. He supported Edward the Confessor in his quarrel with Earl Godwine in 1051, and was appointed earl of Huntingdon soon after this date. In 1054 Siward invaded Scotland in the interests of his kinsman Malcolm Canmore, and he completely routed King Macbeth in a battle in which his son Osborn was killed. Early in 1055 the earl died at York. Shakespeare introduces Siward and his son, whom he calls young Siward, into the tragedy of *Macbeth*, and represents the old man as saying when he heard that his son's wounds were in front, "Had I as many sons as I have hairs, I would not wish them to a fairer death." Siward, a man of unusual strength and size, is said to have risen from his bed at the approach of death, and to have died dressed in all his armour. He built a minster near York which he dedicated to St Olaf, and where he was buried; and one of his sons was Earl Waltheof.

See E. A. Freeman, *The Norman Conquest*, vols. ii. and iii. (1870-1876); and W. F. Skene, *Celtic Scotland* (1876-1880).

SIXTUS, the name of five popes.

SIXTUS I. (Xystus) was the sixth bishop of Rome (c. 116-125) and took the name on that account. **SIXTUS II.**, successor of Stephanus I. as bishop of Rome in 257, suffered martyrdom under Valerian on the 6th of August 258. He restored the relations with the African and Eastern Churches which had been broken off by his predecessor on the question of heretical baptism. Dionysius succeeded him.

SIXTUS III. was bishop of Rome from the 31st of July 432 to the 19th of August 440. Before his elevation to the pontificate he had been suspected of favouring the Pelagians, but when he became pope he disappointed their expectations, and repelled their attempts to enter again into communion with the Church. During his pontificate the dispute was settled between Cyril of Alexandria and John of Antioch, who had been at variance since the council of Ephesus, but he himself had some difficulties with Proclus of Constantinople with regard to the vicariate of Thessalonica. (L. D.*)

SIXTUS IV. (Francesco della Rovere), pope from the 9th of August 1471 to the 12th of August 1484, was born of a poor family near Savona in 1414. He entered the Franciscan order at an early age and studied philosophy and theology at the universities of Padua and Bologna. He speedily acquired a great reputation as an eloquent preacher, and, after filling the offices of procurator at Rome and provincial of Liguria, he was chosen general of his order in 1464. Three years later he was, to his own surprise, made cardinal-priest of St Pietro in Vincoli by Paul II., whom he succeeded as pope. Some writers have maintained that this sudden elevation of the most recent member of the Sacred College was due to bribery in the conclave, whilst the apologists of Sixtus affirm it was due to the friendship of the powerful and upright Cardinal Bessarion, and explain that the pope, having been brought up in a mendicant order, was inexperienced and did not appreciate the liberality of his donations after his election. There is no doubt that the expenditures of his pontificate were prodigal. Sixtus sent Cardinal Caraffa with a fleet against the Turks, but the expedition was unsuccessful. He continued to condemn the Pragmatic Sanction in France, and denounced especially the ordinance of Louis XI. which required (8th of January 1475) the royal *placet* for the publication of all papal decrees. He likewise continued his predecessor's negotiations with the Tsar Ivan III. for the

reunion of the Russian Church with the Roman see and for support against the Turks, but without result. He was visited in 1474 by King Christian of Denmark and Norway, and in the following year (12th of June) he established the university of Copenhagen. Sixtus soon abandoned his universal policy in order to concentrate attention on Italian politics, and the admirable energy which he had shown at first was clouded by the favours which he now heaped upon unworthy relations. Not content with enriching them by gifts and lucrative offices, he made their aggrandizement the principal object of his policy as a secular prince. Sixtus was cognisant of the conspiracy of the Pazzi, plotted (1478) by his nephew, Cardinal Riario, against Lorenzo de' Medici. He entered into a fruitless and inglorious war with Florence, which kept Italy for two years (1478-80) in confusion. He next incited the Venetians to attack Ferrara, and then, after having been delivered by their general, Roberto Malatesta, from a Neapolitan invasion, he turned upon them and eventually assailed them for refusing to desist from the hostilities which he had himself instigated. He relied on the co-operation of Lodovico Sforza, who speedily forsook him; and vexation at having peace forced upon him by the princes and cities of Italy is said to have hastened his death. Several events of his pontificate are noteworthy: he granted many privileges to the mendicant orders, especially to the Franciscans; he endeavoured to suppress abuses in the Spanish Inquisition; he took measures against the Waldenses; he approved (1475) the office of the Immaculate Conception for the 8th of December; in 1478 he formally annulled the decrees of the council of Constance; and he canonized St Bonaventura (14th of April 1482). The most praiseworthy side of his pontificate was his munificence as a founder or restorer of useful institutions, and a patron of letters and art. He established and richly endowed the first founding hospital, built and repaired numerous churches, constructed the Sistine Chapel and the Sistine Bridge, improved church music and instituted the famous Sistine choir, commissioned paintings on the largest scale, pensioned men of learning, and, above all, immortalized himself as the second founder of the Vatican library. These great works, however, were not accomplished without grievous taxation. Annates were increased and simony flourished. Though himself pious, of blameless morality, hospitable to a fault, and so exempt from avarice, says his secretary Conti, that he could not endure the sight of money, it was Sixtus's misfortune to have had no natural outlet for strong affections except unworthy relatives; and his great vices were nepotism, ambition and extravagance. He died on the 12th of August 1484, and was succeeded by Innocent VIII.

See L. Pastor, *History of the Popes*, vol. iv., trans. by F. I. Antrobus (London, 1898); M. Creighton, *History of the Papacy*, vol. iv. (London, 1901); F. Gregorovius, *Rome in the Middle Ages*, vol. vii., trans. by Mrs G. W. Hamilton (London, 1900-1902); Jacob Burckhardt, *Geschichte der Renaissance in Italien* (4th ed., 1904); J. A. Symonds, *Renaissance in Italy*; E. Frantz, *Sixtus IV. u. die Republik Florenz* (Regensburg, 1880); I. Schlecht, "Sixtus IV. u. die deutschen Drucker in Rom," in S. Ehses, *Festschrift zu elfhundertjährigen Jubiläum des Campo Santo* (Freiburg, 1897); *Aus den Annalen-Registern der Päpste Eugen IV., Pius II., Paul II. u. Sixtus IV.*, ed. by K. Hayn (Cologne, 1896). (C. H. HA.)

SIXTUS V. (Felice Peretti), pope from 1585 to 1590, was born at Grottamara, in Ancona, on the 13th of December 1521. He was reared in extreme poverty; but the story of his having been a swincherd in his youth appears to be open to question. At an early age he entered a Franciscan monastery. He soon gave evidence of rare ability as a preacher and a dialectician. About 1552 he came under the notice of Cardinal Carpi, protector of his order, Ghislieri (later Pius V.) and Caraffa (later Paul IV.), and from that time his advancement was assured. He was sent to Venice as inquisitor general, but carried matters with a high hand, became embroiled in quarrels, and was forced to leave (1560). After a brief term as procurator of his order, he was attached to the Spanish legation headed by Buoncampagno (later Gregory XIII.) 1565. The violent dislike he conceived for Buoncampagno exerted a marked influence upon his subsequent actions. He hurried back to Rome upon the accession of

Pius V., who made him apostolic vicar of his order, and, later (1570), cardinal. During the pontificate of Gregory XIII. he lived in retirement, occupied with the care of his villa and with his studies, one of the fruits of which was an edition of the works of Ambrose; not neglecting, however, to follow the course of affairs, but carefully avoiding every occasion of offence. This discreetness contributed not a little to his election to the papacy on the 24th of April 1585; but the story of his having feigned decrepitude in the Conclave, in order to win votes, is a pure invention. One of the things that commended his candidacy to certain cardinals was his physical vigour, which seemed to promise a long pontificate.

The terrible condition in which Gregory XIII. had left the ecclesiastical states called for prompt and stern measures. Against the prevailing lawlessness Sixtus proceeded with an almost ferocious severity, which only extreme necessity could justify. Thousands of brigands were brought to justice: within a short time the country was again quiet and safe. Sixtus next set to work to repair the finances. By the sale of offices, the establishment of new "Monti" and by levying new taxes, he accumulated a vast surplus, which he stored up against certain specified emergencies, such as a crusade or the defence of the Holy See. Sixtus prided himself upon his hoard, but the method by which it had been amassed was financially unsound: some of the taxes proved ruinous, and the withdrawal of so much money from circulation could not fail to cause distress. Immense sums, however, were spent upon public works. Sixtus set no limit to his plans; and what he achieved in his short pontificate is almost incredible; the completion of the dome of St Peter's; the loggia of Sixtus in the Lateran; the chapel of the Praesepe in Sta Maria Maggiore; additions or repairs to the Quirinal, Lateran and Vatican palaces; the erection of four obelisks, including that in the piazza of St Peter's; the opening of six streets; the restoration of the aqueduct of Severus ("Acqua Felice"); besides numerous roads and bridges, an attempt to drain the Pontine marshes, and the encouragement of agriculture and manufacture. But Sixtus had no appreciation of antiquity: the columns of Trajan and Antoninus were made to serve as pedestals for the statues of SS Peter and Paul; the Minerva of the Capitol was converted into "Christian Rome"; the Septizonium of Severus was demolished for its building materials.

The administrative system of the church owed much to Sixtus. He limited the College of Cardinals to seventy; and doubled the number of the congregations, and enlarged their functions, assigning to them the principal rôle in the transaction of business (1588). The Jesuits Sixtus regarded with disfavour and suspicion. He meditated radical changes in their constitution, but death prevented the execution of his purpose. In 1589 was begun a revision of the Vulgate, the so-called *Editio Sixtina*.

In his larger political relations Sixtus, strangely enough, showed himself visionary and vacillating. He entertained fantastic ambitions, such as the annihilation of the Turks, the conquest of Egypt, the transporting of the Holy Sepulchre to Italy, the accession of his nephew to the throne of France. The situation in which he found himself was embarrassing: he could not countenance the designs of heretical princes, and yet he distrusted Philip II. and viewed with apprehension any extension of his power. So, while he excommunicated Henry of Navarre, and contributed to the League and the Armada, he chafed under his forced alliance with Philip, and looked about for escape. The victories of Henry and the prospect of his conversion to Catholicism raised Sixtus's hopes, and in corresponding degree determined Philip to tighten his grip upon his wavering ally. The pope's negotiations with Henry's representative evoked a bitter and menacing protest and a categorical demand for the performance of promises. Sixtus took refuge in evasion, and temporized until death relieved him of the necessity of coming to a decision (27th of August 1590).

Sixtus died execrated by his own subjects; but posterity has recognized in him one of the greatest popes. He was impulsive, obstinate, severe, autocratic; but his mind was open to large ideas, and he threw himself into his undertakings with an energy

and determination that often compelled success. Few popes can boast of greater enterprise or larger achievements.

Lives of Sixtus are numerous: Cicarella's, in Platina, *De vitis pontiff. Rom.*, is by a contemporary of the pope, but nevertheless of slight importance; Leti's *Vita di Sisto V* (Amsterdam, 1693, translated into English by Farneworth, 1779) is a caricature, full of absurd tales, utterly untrustworthy, wanting even the saving merit of style; Tempesti's *Storia della vita e geste di Sisto Quinto* (Rome, 1754-1755) is valuable for the large use it makes of the original sources, but lacks perspective and is warped by the author's blind admiration for his subject; Cesare's *Vita di Sisto V* (Naples, 1755) is but an abridgment of Tempesti. Of recent works the best are Hübner, *Sixte-Quint*, &c. (Paris, 1870, translated into English by H. E. H. Jerningham, London, 1872); and Capranica, *Papa Sisto, storia del s. XVI* (Milan, 1884). See also Lorentz, *Sixtus V. u. seine Zeit* (Mainz, 1852); Dumesnil, *Hist. de Sixte-Quint* (Paris, 1869, 2nd ed.); Segretain, *Sixte-Quint et Henri IV* (Paris, 1861, strongly Ultramontane); Ranke's masterly portrayal, *Popes* (Eng. trans., Austin), i. 446 sq., ii. 205 sq.; and v. Reumont, *Gesch. der Stadt Rom*, iii. 2, 575 sq., 733 sq. Extended bibliographies may be found in Herzog-Hauck, *Realencyklopädie*, s.v. "Sixtus V.," and *Cambridge Mod. Hist.* iii. 835 sq. (T. F. C.)

SIZAR, one of a class of students at a college of Cambridge University and at Trinity College, Dublin, who, being persons of limited means, are received for lower fees, and obtain free commons, lodgings or other assistance towards their education during their terms of residence. At Oxford there was formerly a similar class, known as "Battlers" or "Batlers," who originally waited on the Fellow of the College who had nominated them, and a still more humble class, the "servitors," who, perhaps, answered more to a "subsizar" at Cambridge. The name "sizar" is to be connected with the "sizes" or "sizings" ("size" being a shortened form of "assize"), that is the specified portions of food and drink issued at a fixed price from the buttery of the college; the sizar was so styled either because as one of his former duties he had to fetch the "sizes" for others, or because he obtained his own free. The menial duties of "sizar" at Cambridge have long become obsolete.

SIZE, a general term for bulk or quantity; also an agglutinant consisting of undried glue. The two words, though they are so widely separate in meaning, are by etymology the same. "Size" (Lat. *assidere*, to sit down to) is a shortened form of "assize," through the French and Italian respectively. The O. Fr. *assis*, *assise*, and Eng. "assize," meant a sitting of a deliberative or other body; hence decree, ordinance of such a body, specifically of such as regulated weights, measures, prices; thus it came to mean a standard of measure price, quantity thus fixed, and so merely quantity or measure, in which sense it remains in the shortened form "size." In the sense of an agglutinant, "size" is an adaptation of Ital. *sisa*, a shortened form of *assisa* (Lat. *assidere*), and seems to have meant by derivation "that which painters use to make the colours sit well or suitably."

SKAGERRACK, the arm of the North Sea which gives access to the Cattegat and so to the Baltic. It is about 140 m. long and 75 broad. On the Danish shore, which is low and beset with sand-banks, the strait is shallow. Towards the steep Norwegian coast its deepest part is found, 443 fathoms.

For the currents, temperature and salinity of the water, &c., see NORTH SEA.

SKAGWAY (a native name said to mean "home of the north wind"), a city in S.E. Alaska, in lat. 59° 28' N. and long. 135° 20' W., at the mouth of the river Skagway, on an indentation of Taiya Inlet, a branch of Chilkoot Inlet, leading out of Lynn Canal. Pop. (1900) 3117. It is the seaward terminus of the Yukon & White Pass railway, by which goods and passengers reach the Klondike; and is connected with Dawson by telegraph and with Seattle by cable, and with Seattle, San Francisco and other Pacific ports by steamers. The climate is comparatively dry (annual precipitation about 21.75 in.); between 1898 and 1902 the minimum recorded temperature was 10° (March), the maximum 92° (July), and the greatest monthly range 73° (March). Though settled somewhat earlier, Skagway first became important during the rush in 1896 for the Klondike gold-fields, for which it is the most convenient entrance by the trail over White Pass, the lower of the two passes to the

headwaters of the Yukon. A post-office was established here in November 1897.

SKARGA, PIOTR (1532–1612), Polish writer and reformer, was born at Grojec near Warsaw in 1532. He was a member of the noble Pawenski family, but his pseudonym of *Skarga* (from "skarga" a "complaint" or "accusation") speedily superseded his real name. Educated at Grojec and Cracow, he began life as a tutor to the family of Andrew Tenczynski, castellan of Cracow, and, some years later, after a visit to Vienna, took orders, and from 1563 was attached to the cathedral church of Lemberg. His oratory was so successful that he determined to become a missionary-preacher among the people, in order the better to combat the social and political evils of the day. By way of preparation he studied theology in Italy from 1568 to 1570, and finally entered the Society of Jesus. On his return he preached successively at Pultusk, Jaroslaw and Plock under the powerful protection of Queen Anne Jagielonika. During a subsequent mission to Lithuania he converted numerous noble families, including the Radziwills, and held for some years the rectorship of the Jesuit Academy at Wilna, where he composed his *Lives of the Saints*. In 1584 he was transferred to the new Jesuit College at Cracow. He was protected by the valiant Stephen Báthory, and the first act of the pious Sigismund III., on ascending the Polish throne, was to make Skarga his court preacher, an office he held for twenty-four years (1588–1611). With perfect fearlessness and piercing eloquence, he rebuked the sloth, the avarice, and the lawlessness of the diets which were doing their best to make government in Poland impossible. Sometimes, as for instance during the insurrection of Zebrzydowski, Skarga intervened personally in politics, and on the side of order and decency, for his loyalty to the crown was as unquestionable as his devotion to the Church. Wearied out at last, he begged to be relieved of his office of preacher, quitted the court, and resided for the last few months of his life at Cracow, where he died on the 27th of September 1612.

The most important of his works are: *Lives of the Saints* (Wilna, 1579, 27th edition, 1884); *Sermons on Sundays and Saints' Days* (1st ed., Cracow, 1595, Latin ed., Cracow, 1691); *Sermons preached before the Diet* (last and best edition, Cracow, 1904) and numerous other volumes of sermons, some of which have already run through thirty editions. Of less importance are his very numerous polemical works, though his famous book *On the Unity of the Church of God* (1st edition, Wilna, 1577) directed against the dissenters, especially the Greek Orthodox schismatics, will always have an historical interest.

See Izydor Dzieduszycki, *Peter Skarga and his Age*. (Pol.) (Cracow, 1850–1851). (R. N. B.)

SKAT, a game of cards, much played in central and northern Germany. It is generally supposed to have been invented about 1817 by an advocate of the name of Hempel in Saxe-Altenburg. There is, however, some reason for believing that the game is of much earlier origin and was played by the Slav inhabitants of Saxe-Altenburg long before that date. In the home of the game of skat (Saxony and Thuringia) the old German single-ended cards are usually employed, while in north and south Germany French cards are ordinarily used. The German cards are thirty-two in number and of four suits,—*Schellen* (bells), the equivalent of diamonds; *Roth* (red), hearts; *Grün* (green), spades; and *Eichel* (acorn), clubs. The eight cards of each suit are the seven, eight, nine, ten, *Wenzel* or knave, queen, king, ace. This arrangement denotes at once the value of the single cards, each following card being higher in value than the preceding; *i.e.* hearts are higher than diamonds, spades than hearts, and clubs (the highest colour) takes spades, hearts and diamonds. Again 8 takes 7, 9 takes 8 and 7; but the knave (called *Wenzel* or *Unter*) is an exception (see below).

The game is played by three persons; where four play, the dealer takes no part in the play though he shares in the winnings and losings of the opponents of the player. The cards are dealt from right to left—or (as skat players say) in the direction the coffee-mill is turned. After the cards have been shuffled and cut, the dealer first deals three cards to each player, then four and again three, laying aside two cards (the skat). Each player has now ten cards in his hand, which he arranges in suits.

The *Wenzel* or knaves occupy a peculiar position. They are not regarded as colour cards, but are essentially trumps and take all other trumps. The player sitting to the left of the dealer is "first hand," and if he himself intends to make a game, invites the others to declare theirs, or if he wishes to reserve all rights to himself, simply says "*Ich bin vorn*"—"I have the lead," and then his next neighbour on the left has to offer a game. If this neighbour holds such cards as to give him no prospect of winning he passes, and his neighbour to the left has the right to offer a game. If he in his turn passes, then the first hand is at liberty to determine the game or declare "*Ramsch*" (see below). But if the first neighbour thinks he can risk a game, he offers one. If the first hand reserves this game (see above "I have the lead"), either because he intends to play it himself or to play a higher game, the second hand must go higher or pass, *i.e.* renounce a game, and then his neighbour to the left has the right to offer, and if he again passes and does not offer a higher game than that which the first hand intends to play, the latter determines the game to be played.

The usual games in skat are the following. First the simple colour game, which is, however, seldom played by skat enthusiasts. The player has here the right to take up the skat, and to determine the suit of the game; but here the rule is that the colour must not be lower in value than that of the game offered, though it may be higher. For instance, if spades are offered, the player cannot take hearts as trumps, though he may take clubs, because they are higher in value than spades.

Next to the colour game comes "tourné," the player turning up one of the skat cards, the suit of which becomes trumps. If a knave be turned up the player may announce "grando." Then comes the game of "solo," where the player declares which suit shall be trumps, and the skat remains intact. The highest "solo," still higher than clubs, is "grando." In this game only the four knaves are trumps. If the hand playing grando thinks he can make all the tricks, he declares open grando—*i.e.* shows his hand. If in open grando a single trick be lost, the player loses the game. If one of the players holds such cards as to enable him to force his opponents to take all the tricks, he can declare nullo. But here the game is lost if even a single trick falls to the player. In nullo, the knaves are regarded as colour, *i.e.* are not trumps. Nullo can be played open, if there is no probability of the player taking a single trick. Simple nullo counts higher than diamond solo; open nullo comes after clubs solo. In Ramsch, which takes place when none of the players will risk a game, each player takes (as in whist) all the tricks he makes—but only knaves are trumps—and the loser is he who makes most points. The value of the individual cards given in figures is as follows. The seven, eight and nine count nothing, the knave counts 2, the queen 3, king 4, ten 10 and ace 11 points. This gives the value of the whole game as 120 points. The game is won if the player gets one above the half of this sum, *i.e.* 61. The hand that does not make 30 is "Schneider," that is "cut," and "Schwarz" (black) if he does not make a single point.

Skat is almost invariably played for money, and the calculation is made thus. Every game and every suit have a set value:—

Colour game	3, 4, 5 and 6, according to the suits.
Tourné	5, 6, 7, 8 and 12 (the last the grando).
Solo	9, 10, 11, 12 and 16 (grando).

These figures are increased by the number of "*matadores*." Suppose a player of club solo holds all four knaves and the ace and ten of clubs, he has a game with 6 matadores. By matadores is accordingly meant an uninterrupted sequence, *e.g.* from the knave of clubs down to the seven of trumps. If the player has then all four knaves and all the cards of the trump suit in his hand (or in the skat), he has a game with 11 matadores. But if a single card is missing in the series, only the matadores of higher value than the missing card count. If, for instance, the knave of hearts is missing, the game in question has only 3 matadores. To the number of matadores is added 1 if the game is simply won, 2 if won with Schneider (cut), and 4 if the opponents are Schwarz (black). Thus, if a spade solo with 5 matadores is won with Schneider, the winner makes $5 + 2 \times 11 = 77$ points.

SKATING (Dutch *schaats*, a skate), a mode of progression on ice with the aid of appliances called skates, attached to the sole of the shoe by straps, clamps or screws. The earliest form of skate that we know is that of the bone "runners" (still preserved in museums) worn by the primitive Norsemen. These were bound to the foot with thongs. The Norse sagas speak with pride of the national achievements in skating, and the early development of the art was due principally to the Norsemen, Swedes, Danes, Finns and the Dutch. Whatever its origin in Great Britain, skating was certainly a common sport in England in the 12th century, as is proved by an old translation of

Fitz-Steven's *Description of London*, published in 1180, in which the following words occur:—

"When the great fenne or moore (which watereth the walls of the cite on the North side) is frozen, many young men play on the yce . . . asome tye bones to their teete and under their heeles, and shoving themselves with a little picked staffe do slide as swiftille as a birde flyeth in the aire or an arrow out of a cross-bow."

At what period the use of metal runners was introduced is unknown, but it was possibly not long after the introduction into northern Europe, in the 3rd century after Christ, of the art of working in iron. By the time of Charles II. skating had become popular, with the aristocracy as well as with the people, as is proved by entries in the diaries of Pepys and Evelyn.

Skating does not appear to have been known in America before its colonization by Europeans, though bone slides were used to a limited extent by certain Eskimo tribes.

The modern skate is in the form of a steel blade mounted upon a wood or metal base. In the old-fashioned skate the wooden base was strapped to the boot and kept firm by low spikes or screws that entered the sole. The next step in development was the "club-skate," originally Canadian, a patent appliance adjusted by clamps to fit the sole. There are several varieties of club-skates still popular. They have a broad blade with slightly curved edge, and are more suitable for figure-skating than for speed. The best skaters now use skates fixed permanently to special skating-boots.

As in ancient times, skating is most practised by the Scandinavians, Finns, Dutch and British, to whom in modern days have been added the Germans, Swiss, Austrians, and especially the Canadians and Americans. All these nations have central organizations which control skating, the British, founded in 1879, being the National Skating Association. The American, founded in 1884, is also called the National Skating Association, and generally co-operates with the Canadian Amateur Skating Association, founded in 1888.

Speed Skating.—Of the earliest skating races no records have been kept. That racing was a popular pastime in Holland two centuries and longer ago is proved by the numerous paintings of the time depicting racing scenes. In England the first skating match recorded was that in which Youngs of Mepal beat Thomson of Wimblingdon, both men of the Fens, in the year 1814. The Fen country has remained the chief English home of skating, owing to the abundance of ice in that district, and most British champions have been Fensmen, notably the Smarts of Welney. In January 1823 the *Sporting Magazine* recorded the first amateur match, which was between teams of six gentlemen from March and Chatteris, Mr Drake of Chatteris finishing first. In the same year a match took place for a silver bowl on the Maze Lake, Hertfordshire, over a course 5 m. long, the winner being Mr Blenkinsop. Racing, more or less intermittent, continued annually, the Fen skaters generally triumphing. In 1854 appeared the celebrated William ("Turkey") Smart, who, after defeating Larmen Register in that year, remained champion for more than a decade. His nephew George ("Fish") Smart won the championship in 1878 and held it until 1889, only to relinquish it to his younger brother James. The first amateur championship of England was held in 1880 at Hendon, and was won by Mr F. Norman, a Fen skater.

Owing to the great area of Canada and the northern United States, and the long and cold winter, the sport of skating is indulged in to a greater extent in North America than anywhere else, and local matches have been held for years in many places. Owing to the reputation of Charles June, who was considered to be the best American skater from 1838 for many years, his place of residence, Newburgh, N.Y., on the Hudson river, became the headquarters of American speed skating. This city also is the birthplace of the Donoghue family, who may be called the Smarts of America. The most noted members of this family were Mr T. Donoghue and his two sons, Tira and J. F. Donoghue, each in his day the fastest skater in the world, Joseph Donoghue winning every event at the international championship meeting at Amsterdam in 1891. There is practically no professional skating in America.

Skating received a great impetus during the last decade of the 19th century, profiting both by the growing devotion of athletics and by increased facilities of communication, which led to international competitions and the institutions of skating clubs in Switzerland and elsewhere, especially those of Davos, St Moritz and Grindelwald, where ice is available every winter. Although skating instruments are so simple, the evolution of the skate has advanced considerably, contributing to marked improvement in the skater's skill. In speed-skating an epoch was marked, first, by the almost universal adoption of the Norwegian type of racing skate; and, secondly, by the institution in 1892, at an international congress held in Holland, of annual races for the championships of Europe and of the world.

The Norwegian skate, introduced and perfected (1887-1902) by Axel Paulsen and Harald Hagen, is constructed with a view to lightness, strength, and diminution of friction. The blade, of specially hardened steel, is set in a hollow horizontal tube of aluminium, and connected by similar vertical tubes with foot-plates riveted to a closely-fitting boot with thin leather sole. It is 16-17 $\frac{3}{4}$ in. long and $\frac{1}{2}$ -2 millimetres thick (*i.e.* .019-0.078 in.), the average employed for hard ice being $\frac{3}{4}$ mm., often thinner towards the heel. This thickness is suitable for hard ice, but for softer ice $\frac{1}{8}$ or $\frac{3}{8}$ in. is preferable. The blade is flat on the ice throughout, except for an inch in front; this flatness distributes the weight, and with the extreme thinness of blade reduces friction to a minimum. The edges are right-angled and sharp.

The skater's style has been modified. The blade, when planted on the ice with weight upon it, describes a nearly straight line, the last few feet only curving slightly outwards as the skate leaves the ice. Hence the stroke of the best modern skaters is almost, if not entirely, on the inside edge, a gain in directness and speed, the outside edge being used for curves only. The length of stroke has tended to diminish. Contrasted with the 12-18 yards' stroke attributed to the old English champion, W. "Turkey" Smart, which was partly on the outside edge, the modern racing stroke rarely exceeds 10 yds., and is usually nearer 6 or 7. Particular instances vary with conditions of ice, &c., but at St Petersburg, in 1896, Eden's stroke in the 10,000 metre race averaged about 7 $\frac{1}{2}$ yds., that of P. Oestlund at Davos, in 1900, the same (for one lap, 8 yds.). J. F. Donoghue's stride in 1891 was computed at about 6 yds. The general effect has been vastly increased speed, and a conjoint cause is the stricter training undergone before important races.

The races held annually since 1892-1893 for the championships of Europe and of the world, under the auspices of the International Skating Union, have assembled representatives from the skating countries of Europe and from America.

The races are four in number, over distances of 500, 1500, 5000 and 10,000 metres, and to obtain the title of champion a skater must win three races and finish in the fourth. In addition, each country, when possible, holds its own championship races.

In England races are still skated, with rare exceptions, on straight courses, with a sharp turn round a post or barrel, the distance prescribed for N.S.A. championships being 1 $\frac{1}{2}$ m. with three turns. The Continental and international system involves a course with straight sides and curved ends of such a radius that no slackening of speed is necessary. In both instances the competitors race two at a time on a double track, and the time test is used. Each skater must keep his own course, to prevent either from using the other as pace-maker or wind-shield. The international regulations (*Eiswettlauf-Ordnung*) prescribe that, if a single track be used, the hindmost skater must keep at a minimum distance of 5 metres from the other, on pain of disqualification. The advantage of inner curve on a Continental course is given alternately, and a space left open between the tracks at one point for the skaters to cross.

The curves are skated with a step-over-step action, and the direction is always from right to left. Hence, on entering the curve the right foot is brought across in front and set down on the inside edge, the left passing behind on the outside edge, and being in its turn set down on an outside edge in front. The strokes thus form a series of tangents to the curve, and are little shorter than in the straight. With a radius of 25 and 30 metres, as at Davos, the curves can be skated with safety at full speed.

The following are the amateur speed records at the principal distances:

Distance.	m. s.	Name.	Nationality.
500 metres (546 yds.)	44 $\frac{1}{2}$	R. Gundersen	Norway
1,000 " (1093 yds.)	1 34	P. Oestlund	"
1,500 " (1639 yds.)	2 22 $\frac{3}{8}$	P. Oestlund	"
5,000 " (3 m. 188 yds.)	8 37 $\frac{3}{8}$	J. Eden	Holland
10,000 " (6 m. 376 yds.)	17 50 $\frac{3}{8}$	P. Oestlund	Norway

The following times and distances have also been recorded in America:

Distance.	h. m. s.	Name.
100 yds.	9 $\frac{1}{2}$	J. S. Johnson
$\frac{1}{4}$ m.	35 $\frac{1}{2}$	H. P. Mosher
1 m.	2 36	J. Neilson
2 m.	5 42 $\frac{3}{4}$	O. Rudd
5 m.	14 24	O. Rudd
10 m.	31 11 $\frac{1}{2}$	J. S. Johnson
50 m.	3 15 59 $\frac{3}{4}$	J. F. Donoghue
100 m.	7 11 38 $\frac{1}{2}$	J. F. Donoghue

See contemporary records in the *Field, Outing*, and other sporting journals, as well as the annual almanacs; *A Bibliography of Skating*, by F. W. Foster (London, 1898); *Skating*, in the Badminton Library (1892); *Skating*, in the Oval Series (1897); "Skating," article in the *Encyclopaedia of Sport* (1899); *Skating*, in the Isthmian Library (1901); *Skating*, by W. T. Richardson (New York, 1903).

Figure Skating.—This variety of skating, as subjected to definite rules, is quite modern, having originated in the 19th century, though the cutting of figures on the ice was regarded as an accomplishment by skaters long before.

Although the "Edinburgh Skating Club," founded in 1642, is the oldest skating organization in Great Britain, the "Skating Club" of London, formed in 1830, is the most important, and for many years practically controlled figure skating. Many other important figure skating clubs now exist in Great Britain, for entrance into which a certain standard of proficiency is demanded. Figure skating championships are now held in many countries under the auspices of the national associations, the world's championship meeting being held by the International Skating Union. In England great impetus has been given to figure skating by the multiplication of clubs (*c.g.* Wimbledon, founded 1870, Thames Valley, Crystal Palace, &c.) in addition to the original "Skating Club" and those in Switzerland already mentioned; and from the construction of numerous artificial rinks, such as at Niagara and Prince's Club in London, as well as by the encouragement afforded by the National Skating Association, which offers 1st, 2nd and 3rd class badges (and a special or "Diamond" badge for figure skating) for figure tests as well as for speed; in 1893 the Association founded a "London Skating Council," while in 1898 and in 1902 it held the figure skating championship of the world in London. In America comparatively little interest is shown in this branch of the sport.

In the British style of figure skating, which is not recognized by the International Skating Union, the body is held as nearly as possible upright, the employed leg is kept straight, the unemployed leg carried behind, the arms hang loosely at the sides, and the head is turned in the direction of progress. In the so-called Anglo-Swiss style, affected by British skaters trained at Davos and St Moritz, the upright, almost rigid position is insisted on, even the unemployed leg being held straight. Much more latitude is allowed by the Continental school, though no definite rules of form have been laid down. The knee of the employed leg is slightly bent, and the unemployed leg is in constant action, being used to balance the body during the execution of the figures. The Continental is less difficult in execution than the British style, but its movements are less graceful. There are, of course, local modifications, the strictest exponents of the English school being the Davos and St Moritz skaters, while the Continental varies from the complete *abandon* of the French to the more restrained style of the Germans; Canadians cultivate also grape-vines and other two-footed figures. The essential features are, however, identical. Thus Englishmen consider of secondary importance loops, cross-cuts, continuous and hand-in-hand skating, though such figures are included in the 1st class test of the N.S.A., and devote themselves mainly to "combined figures." Combined figures have been defined as "symmetrical execution of a figure by one or more pairs of skaters." Originally known as the "skating club figures," they have been gradually developed, and in 1891 delegates from the principal clubs established a regular terminology. The ideal number of skaters for a combined figure is four, though sixes and eights are seen, one being chosen "caller" of the movement to

be skated. Various sets of "calls" are arranged at the discretion of different clubs, and consist ordinarily of "turns" and "changes." The N.S.A. offer a challenge shield for an annual competition in combined figure skating. There has, however, been a marked tendency towards unification of style, through Englishmen adopting Continental methods, rendered almost a necessity by the circumscribed area of artificial rinks. In 1901 the Figure Skating Club was established for this purpose, and its members attained such success that an English lady, Mrs Syers, gained the second place in the world's championship competition in 1902, and with her husband won the International Pair Skating in that year, and again in 1904; and in 1906 she won the ladies' amateur championship of the world, established in that year.

The World's Figure Skating Championship was won in 1896 by Fuchs, Austria; 1897, G. Hügel, Austria; 1898, H. Grenander, Sweden; 1899 and 1900, G. Hügel, Austria; 1901, 1902, 1903, 1904, U. Salchow, Sweden. The competition consists of two parts, (a) compulsory figures, (b) free skating, the latter affording scope for the performance of dance steps and brilliant individual figures, such as the "sitting pirouette," and the "star," consisting of four crosses (forward rocker, back loop, back counter), invented by Herr Engelmann and splendidly rendered by Herr Salchow.

The skates used for the English and Continental styles are shorter than those used for speed-skating, and differ in radius, though both are of the same type, *i.e.* a blade fastened to the boot by sole-plates, the "Mount Charles" pattern being the one generally adopted by Englishmen. The English radius is 7 ft., or now more usually 6 ft.; the foreign, 5 $\frac{1}{2}$ or even 5 ft., and the result is seen in the larger curves skated on the former, and the greater pace obtained owing to decreased friction; at the same time, the difficulty of making a turn is greater. The English skate has generally right-angled edges and blade of same thickness throughout, except in the "Dowler" variety, which is thicker towards the extremities. The foreign skate is sometimes thicker in the middle than at the ends.

See *Skating*, in the Badminton Library (1892); *Skating*, in the Oval Series (1897); *A System of Figure-Skating*, by T. Maxwell Witham (5th ed., 1897); *On the Outside Edge*, by G. H. Fowler (1897); *Combined Figure-Skating*, by George Wood (1899); "Skating," in the *Encyclopaedia of Sport* (1899); *Handbook of Figure-Skating*, by G. H. Brown (Springfield, Mass., 1900); *Lessons in Skating*, by G. A. Meagher (1900); *Figure-Skating*, by M. S. Monier-Williams, in the Isthmian Library (1901); *How to become a Skater*, by G. D. Phillips, in Spalding's Athletic Library, New York. See also ROLLER-SKATING.

SKEAT, WALTER WILLIAM (1835-), English philologist, was born in London on the 21st of November 1835, and educated at King's College, Highgate Grammar School, and Christ's College, Cambridge, of which he became a fellow in July 1860. In 1878 he was elected Ellington and Bosworth Professor of Anglo-Saxon at Cambridge. He completed Mitchell Kemble's edition of the Anglo-Saxon Gospels, and did much other work both in Anglo-Saxon and in Gothic, but is perhaps most generally known for his labours in Middle English, and for his standard editions of Chaucer and *Piers Plowman* (see *LANG-LAND*). As he himself generously declared, he was at first mainly guided in the study of Chaucer by Henry Bradshaw, with whom he was to have participated in the edition of Chaucer planned in 1870 by the University of Oxford, having declined in Bradshaw's favour an offer of the editorship made to himself. Bradshaw's perseverance was not equal to his genius, and the scheme came to nothing for the time, but was eventually resumed and carried into effect by Skeat in an edition of six volumes (1894), a supplementary volume of *Chaucerian Pieces* being published in 1897. He also issued an edition of Chaucer in one volume for general readers, and a separate edition of his *Treatise on the Astrolabe*, with a learned commentary. His edition of *Piers Plowman* in three parallel texts was published in 1886; and, besides the *Treatise on the Astrolabe*, he edited numerous books for the Early English Text Society, including the *Bruce* of John Barbour, the romances of *Havelock the Dane* and *William of Palerne*, and Ælfric's *Lives of the Saints* (4 vols.). For the Scottish Text Society he edited *The Kingis Quair*, usually ascribed to James I. of Scotland, and he published an edition (2 vols., 1871) of Chatterton, with an investigation of the sources

of the obsolete words employed by him. In pure philology Skeat's principal achievement is his *Etymological English Dictionary* (4 parts, 1879-1882; rev. and enlarged, 1910), the most important of all his works, which must be considered in connexion with the numerous publications of the English Dialect Society, in all of which, even when not edited by himself, he had a hand as the founder of the society and afterwards its president.

His other works include: *Specimens of English from 1304 to 1507* (1871); *Specimens of Early English from 1208 to 1303* (1872), in conjunction with R. Morris; *Principles of English Etymology* (2 series, 1887 and 1891); *A Concise Dictionary of Middle English* (1888), in conjunction with A. L. Mayhew; *A Student's Pastime* (1896), a volume of essays; *The Chaucer Canon* (1900); *A Primer of Classical and English Philology* (1905), &c., &c.

SKEFFINGTON, SIR WILLIAM (c. 1465-1535), lord deputy of Ireland, belonged to a Leicestershire family and was sheriff of Leicestershire and Warwickshire under Henry VII. He was master of the ordnance and a member of parliament during the reign of Henry VIII., and in 1529 was appointed deputy in Ireland for Henry's son, the duke of Richmond, the nominal lord lieutenant of that country. He crossed over in August 1829, but his power was so circumscribed by instructions from Henry that the head of the Fitzgeralds, Gerald, 9th earl of Kildare, and not Skeffington, was the real governor of Ireland. This state of affairs lasted for three years and then in 1532 the deputy was recalled. In 1534, Kildare being in prison in England and his son Thomas, afterwards the 10th earl, being in revolt, Skeffington was again appointed deputy. After some delay he landed at Dublin in October 1534 and marched at once to relieve Drogheda, but further progress in the work of crushing the rebellion was seriously delayed by his illness. However, in the spring of 1535 he was again in the field. He took Maynooth, the heavy artillery used by him on this occasion earning for him his surname of "the gunner"; he forced some of Kildare's allies to make peace and he captured Dungarvan. He died on the 31st of December 1535.

SKEGNESS, a seaside resort in the S. Lindsey, or Horncastle parliamentary division of Lincolnshire, England; 131 m. N. by E. from London by the Great Northern railway. Pop. of urban district (1901) 2140. Since 1873, when railway connexion was given with Firby on the Grimsby branch line, the place has undergone a complete transformation, and now possesses good hotels and a pier. There are broad, firm sands, on which account Skegness is much visited. On bank holidays and similar occasions thousands of excursionists come from the manufacturing towns within reach. It is said that a former Skegness, an important haven, was obliterated by the encroachments of the sea; Leland, writing in the middle of the 16th century, states that proofs of this were then extant.

SKELETON. In most animals, and indeed in plants, the shape could not be maintained without a thickening and hardening of certain parts to form a support for the whole. These hardened parts are called the skeleton (Gr. σκέλλω, I dry), because they dry up and remain after the rest of the body has disappeared. In animals the skeleton is usually, and in higher animals always, rendered more rigid and permanent by the deposit in it of lime salts, thus leading to the formation of bone. Sometimes, as in most of the lower or invertebrate animals, the skeleton is on the surface and thus acts as a protection as well as a framework. This is known as an *exoskeleton*. In the higher or vertebrate animals there is an internal or *endoskeleton* and the exoskeleton is either greatly modified or disappears.

The following descriptive account is divided into (1) axial, or skeleton of the trunk, (2) appendicular or skeleton of the limbs, (3) skull, (4) visceral skeleton, or those parts which originally form the gill supports of water breathing vertebrates, (5) the exoskeleton, which is considered under the heading SKIN AND EXOSKELETON. These divisions, although they seem logical, cannot in practice be strictly adhered to, especially in the case of the visceral skeleton, because doing so would involve, among other things, separating the description of the upper jaw from that of the rest of the skull. For the microscopical structure of bone see CONNECTIVE TISSUES.

Axial.

The axial skeleton, from a strictly scientific point of view, should comprise a good deal of the skull as well as the spinal column, ribs and breast bone, but, as the skull (*q.v.*) is dealt with in a separate article, the three latter structures alone are dealt with here.

The SPINE, SPINAL OR VERTEBRAL COLUMN, chine or backbone in man consists of a number of superimposed bones which are named vertebrae, because they can move or turn somewhat on each other. It lies in the middle of the back of the neck and trunk; has the cranium at its summit; the ribs at its sides, which in their turn support the upper limbs; whilst the pelvis, with the lower limbs, is jointed to its lower end. The spine consists in an adult of twenty-six bones, in a young child of thirty-three, certain of the bones in the spine of the child becoming ankylosed or blended with each other in the adult. These blended bones lose their mobility and are called *false vertebrae*; whilst those which retain their mobility are the *true vertebrae*. The bones of the spine are arranged in groups, which are named from their position—vertebrae of the neck or cervical; of the chest, thoracic, formerly called dorsal; of the loins, lumbar; of the pelvis, sacral; and of the tail, coccygeal or caudal; and the number of vertebrae in each group may be expressed in a formula. In man the formula is as follows:—C₇T₁₂L₅S₅Coc₄=33 bones, as seen in the child; but the five sacral vertebrae fuse together into a single bone—the sacrum—and the four coccygeal into the single coccyx. Hence the sacrum and coccyx of the adult are the false, whilst the lumbar, dorsal and cervical are the true vertebrae.

The vertebrae are irregularly-shaped bones, but as a rule have certain characters in common. Each possesses a body and an arch, which enclose a ring, with certain processes and notches. The body, or centrum, is a short cylinder, which by its upper and lower surfaces is connected by means of fibro-cartilage with the bodies of the vertebrae immediately above and below. The collective series of vertebral bodies forms the great column of the spine. The arch, also called neural arch, because it encloses the spinal marrow or nervous axis, springs from the back of the centrum, and consists of two symmetrical halves united behind in the middle line. Each half has an anterior part or pedicle, and a posterior part or lamina. The rings collectively form the spinal canal. The processes usually spring from the arch. The spinous process projects backward from the junction of the two laminae, and the collective series of these processes gives to the entire column the spiny character from which has arisen the term spine, applied to it. The transverse processes project outward, one from each side of the arch.

The articular processes project, two upward and two downward, and are for connecting adjacent vertebrae together. The notches, situated on the upper and lower borders of the pedicles, form in the articulated spine the intervertebral foramina through which the nerves pass out of the spinal canal.

The vertebrae in each group have characters which specially distinguish them. In man and all mammals, with few exceptions, whatever be the length of the neck, the cervical vertebrae are seven in number. In man the body of a cervical vertebra is comparatively small, and its upper surface is transversely concave; the arch has long and obliquely sloping laminae; the ring is large and triangular; the spine is short, bifid, and horizontal; the transverse process consists of two bars of bone, the anterior springing from the side of the body, the posterior from the arch, and uniting externally to enclose a foramen (vertebrarterial) through which, as a rule, the vertebral artery passes; the articular processes are flat and oblique, and the upper pair of notches are deeper than the lower. The first, second and seventh cervical vertebrae have characters which specially distinguish them. The first, or *axis*, has no body or spine: its ring is very large, and on each side of the ring is a thick mass of bone, the *lateral mass*, by

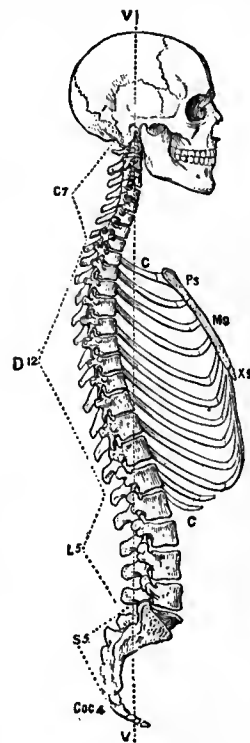

FIG. 1.—The Axial Skeleton.

- C₇ The cervical vertebrae.
 - D₁₂ The thoracic.
 - L₅ The lumbar.
 - S₅ The sacral.
 - Coc₄ The coccygeal.
 - CC The series of twelve ribs on one side.
 - Ps The presternum.
 - Ms The meso-sternum.
 - Xs The xiphisternum.
- The dotted line VV represents the vertical axis of the spine.

Cervical vertebrae.

which it articulates with the occipital bone above and the second vertebra below. The second vertebra, *axis*, or *Vertebra dentata*, has its body surmounted by a thick, tooth-like *odontoid* process, which is regarded as the body of the atlas displaced from its proper vertebra and fused with the axis. This process forms a pivot round which the atlas and head move in turning the head from one side to the other; the spine is large, thick and deeply bifid. The seventh, called *Vertebra prominens*, is distinguished by its long prominent spine, which is not bifid, and by the small size of the foramen at the root of the transverse process. In the human spine the distinguishing character of all the cervical vertebrae is the foramen at the root of the transverse process.

The thoracic vertebrae, formerly called *dorsal*, are twelve in number in the human spine. They are intermediate in size and position to the cervical and lumbar vertebrae, and are all distinguished by having one or two smooth surfaces on each side of the body for articulation with the head of one or two ribs. The arch is short and with imbricated laminae; the ring is nearly circular; the spine is oblique, elongated and bayonet-shaped; the transverse processes are directed back and out, not bifid, and with an articular surface in front for the tubercle of a rib; and the articular processes are flat and nearly vertical. The first, twelfth, eleventh, tenth and sometimes the ninth, thoracic vertebrae are distinguished from the rest. The first is in shape like the seventh cervical, but has no foramen at the root of the transverse process, and has two articular facets on each side of the body; the ninth has sometimes only one facet at the side of the body; the tenth, eleventh, and twelfth have invariably only a single facet on the side of the body, but the eleventh and twelfth have stunted transverse processes, and the twelfth has its lower articular processes shaped like those of a lumbar vertebra.

The lumbar vertebrae in man are five in number. They are the lowest of the true vertebrae, and also the largest, especially in the centrum. The arch has short and deep laminae; the ring is triangular; the spine is massive and hatchet-shaped; the transverse processes are long and pointed; the articular are thick and strong, the superior pair concave, the inferior convex, and the inferior notches, as in the thoracic vertebrae, are deeper than the superior. In the lumbar vertebrae and in the lower thoracic an accessory process projects from the base of each transverse process, and a mammillary tubercle from each superior articular process. The fifth lumbar vertebra has its body much deeper in front than behind and its spine is less massive.

The sacrum is composed of five originally separate vertebrae fused into a single bone. It forms the upper and back wall of the pelvis, is triangular in form, and possesses two surfaces, two borders, a base, and an apex. The anterior or pelvic surface is concave, and is marked by four transverse lines, which indicate its original subdivision into five bones, and by four pairs of foramina, through which are transmitted the anterior sacral nerves. Its posterior surface is convex; in the middle line are four spines, because in the last sacral vertebra the spinal canal is not closed behind. On each side of these are two rows of tubercles, the inner of which are the conjoined articular and mammillary processes, the outer the transverse processes of the originally distinct vertebrae. Between these rows four pairs of foramina are found transmitting the posterior sacral nerves from the sacral canal, which extends

through the bone from base to near the apex, and forms the lower end of the spinal canal. By its borders the sacrum is articulated with the haunch-bones—by its base with the last lumbar vertebra, by its apex with the coccyx. The human sacrum is broader in proportion to its length than in other mammals; this great breadth gives solidity to the lower part of the spine, and, conjoined with the size of the lateral articular surfaces, it permits a more perfect junction with the haunch-bones, and is correlated with the erect position. Owing to the need in woman for a wide pelvis, the sacrum is broader than in man. (For details see A. M. Paterson, "The Human Sacrum," *Sci. Trans. R. Dublin Soc.* vol. v. ser. 2.)

The coccyx consists of four or five vertebrae in the human spine though the last one is sometimes suppressed. It is the rudimentary tail, but instead of projecting back, as in mammals generally, is curved forward, and is not visible externally, an arrangement which is also found in the anthropoid apes and in Hoffmann's sloth. Not only is the tail itself rudimentary in man, but the vertebrae of which it is composed are small, and represent merely the bodies and transverse processes of the true vertebrae. As there are no arches, the ring is not formed, and the spinal canal does not extend, therefore, beyond the fourth piece of the sacrum. The first coccygeal vertebra, in addition to a body, possesses two processes or horns, which are the superior articular processes.

The human spine is more uniform in length in persons of the same race than might be supposed from the individual differences in stature, the variation in the height of the body in adults being due chiefly to differences in the length of the lower limbs. The average length of the spine is 28 in.; its widest part is at the base of the sacrum, from which it tapers down to the tip of the coccyx. It diminishes also in breadth from the base of the sacrum upwards to the region of the neck. Owing to the projection of the spines behind and the transverse processes on each side, it presents an irregular outline on those aspects; but in front it is more uniformly rounded, owing to the convex form of the antero-lateral surfaces of the bodies of its respective vertebrae. In its general contour two series of curves may be seen, an antero-posterior and a lateral. The antero-posterior is the more important. In the infant at the time of birth the sacro-coccygeal part of the spine is concave forward, but the rest of the spine, except a slight forward concavity in the series of thoracic vertebrae, is almost straight. When the infant begins to sit up in the arms of its nurse, a convexity forward in the region of the neck appears, and subsequently, as the child learns to walk, a convexity forward in the region of the loins. Hence in the adult spine a series of convexo-concave curves are found, which are alternate and mutually dependent, and are associated with the erect attitude of man. A lateral curve, convex to the right, opposite the third, fourth, and fifth thoracic vertebrae, with compensatory curve convex to the left immediately above and below, is due apparently to the much greater use of the muscles of the right arm over those of the left, drawing the spine in that region somewhat to the right. In disease of the spine its natural curvatures are much increased, and the deformity known as humpback is produced. As the spine forms the central part of the axial skeleton, it acts as a column to support not only the weight of the body, but of all that can be carried on the head, back and in the upper limbs; by its transverse and spinous processes it serves also to give attachment to numerous muscles, and the transverse processes of its thoracic vertebrae are also for articulation with the ribs.

The THORAX, PECTUS, or CHEST is a cavity or enclosure the walls of which are in part formed of bone and cartilage. Its skeleton consists of the sternum in front, the twelve thoracic vertebrae behind, and the twelve ribs, with their corresponding cartilages, on each side. **Thorax.**

The sternum or breast bone is an elongated bone which inclines downward and forward in the front wall of the chest. It consists of three parts—an upper, called manubrium or presternum; a middle, the gladiolus or mesosternum; and a lower, the ensiform process or xiphisternum. Its anterior and posterior surfaces are marked by transverse lines, which indicate not only the subdivision of the entire bone into three parts, but that of the mesosternum into four originally distinct segments. Each lateral border of the bone is marked by seven depressed surfaces for articulation with the seven upper ribs: at each side of the upper border of the presternum is a sinuous depression, where the clavicle, a bone of the upper limb, articulates with this bone of the axial skeleton. The xiphisternum remains cartilaginous up to a late period of life, and from its pointed form has been named the ensiform cartilage. **Sternum.**

The ribs or costae, twenty-four in number, twelve on each side of the thorax, consist not only of the bony ribs, but of a bar of cartilage continuous with the anterior end of each bone, called a *costal cartilage*, so that they furnish examples of a cartilaginous skeleton in the adult human body; in aged persons these cartilages usually become converted into bone. The upper seven ribs are connected by their costal cartilages to the side of the sternum, and are called *sternal* or *true ribs*; the lower five do not reach the sternum, and are named *a-sternal* or *false*, and of these the two lowest, from being comparatively unattached in front, are called *free* or *floating*. Another and perhaps more useful classification is to speak of the first seven ribs as vertebro-sternal, the next three as vertebro-costal, and the last two as vertebral. All the ribs are **Costae.**

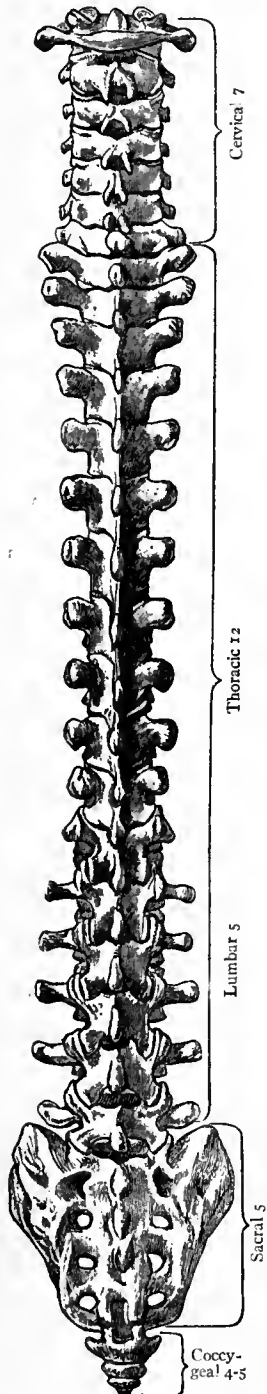

From Arthur Thomson, Cunningham's *Text-Book of Anatomy*.

FIG. 2.—Vertebral Column as seen from behind.

marked by four transverse lines, which indicate its original subdivision into five bones, and by four pairs of foramina, through which are transmitted the anterior sacral nerves. Its posterior surface is convex; in the middle line are four spines, because in the last sacral vertebra the spinal canal is not closed behind. On each side of these are two rows of tubercles, the inner of which are the conjoined articular and mammillary processes, the outer the transverse processes of the originally distinct vertebrae. Between these rows four pairs of foramina are found transmitting the posterior sacral nerves from the sacral canal, which extends

articulated behind to the thoracic vertebrae, and as they are symmetrical on the two sides of the body, the ribs in any given animal are always twice as numerous as the thoracic vertebrae in that animal. They form a series of osseocartilaginous arches, which

allows the passage of the windpipe, gullet, large veins and nerves into the chest, and of several large arteries out of the chest into the neck. The base or lower boundary of the cavity is much larger than the upper, slopes downward and backward, and is occupied by the diaphragm, a muscle which separates the chest from the cavity of the abdomen. The transverse diameter is greater than the antero-posterior, and the antero-posterior is greater laterally, where the lungs are lodged, than in the mesial plane, which is occupied by the heart.

Embryology.—The first appearance of any stiffening of the embryo is the formation of the *notochord*, which in the higher vertebrates is a temporary structure and is not converted into cartilage or bone. It also differs from the bony skeleton in that it is derived from the entoderm or inner of the three layers of the embryo while the bony skeleton is formed from the mesoderm or middle layer and, just as the entoderm is an older layer of the embryo than the mesoderm, so the notochord or entodermal skeleton precedes, both in embryology and in phylogeny or comparative anatomy, the bony mesodermal skeleton.

In the accompanying figure (fig. 4) the notochord is seen in section fully formed and lying between the entoderm and the neural canal. Its first formation is at an earlier period than this, before the neural groove has closed into a canal, and it appears at first as an upward groove from the most dorsal part of the entoderm in what will later on be the cervical region of the embryo. The groove, by the union of its edges, becomes a tube, sometimes spoken of as the chordal tube, but the cavity of this is soon obliterated by the growth of its cells, so that a solid elastic rod is formed which grows forward as far as the pituitary region of the skull and backward to where the end of the coccyx will be.

While the development of the notochord is going on the mesoderm on each side of it is dividing itself into a series of masses called *mesodermic somites* (see fig. 4, PS) or *protovertebrae*. This process begins in the cervical region and proceeds forward and backward until thirty-eight pairs have been formed for the neck and trunk and probably four extra ones for the occipital region of the skull. Each of these somites consists of three parts: that nearest the surface ectoderm is the *cutaneous lamella* (fig. 4, CL). Deep to this and separated in the earlier-formed somites by a space is the muscle layer (fig. 4, ML) while deepest of all and nearest the nerve cord and notochord is the *scleratogenous layer* (fig. 4, SL). It is this layer which gradually meets its fellow of the opposite side and encloses the nerve cord and the notochord in continuous tubes of mesodermal tissue, thus forming the *membranous vertebral column*, which is perforated for the exit of the spinal nerves, but the intervals between the successive mesodermic somites are still marked by the tissue being rather denser there. The next stage is that of chondrification or the conversion into cartilage of each segment of the membranous vertebral column surrounding the notochord. In this way the bodies of the cartilaginous vertebrae are formed and each of these is segmental, that is, it corresponds to a muscle segment and a spinal nerve. The cartilaginous neural arch, however, which surrounds the nerve cord is intersegmental and is formed in the denser fibrous tissue which separates each somite from the next. This also applies to the cartilaginous ribs which appear in the fibrous intervals (myo-

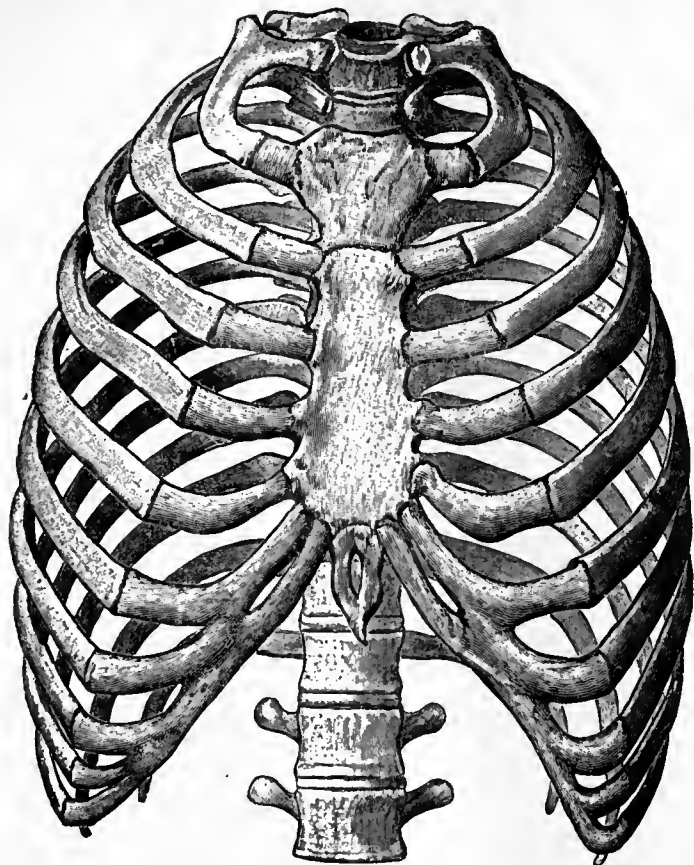

From Arthur Thomson, *Cunningham's Text-Book of Anatomy*.

FIG. 3.—The Thorax as seen from the Front.

extend more or less perfectly around the sides of the chest. A rib is an elongated bone, and as a rule possesses a head, a neck, a tubercle and a shaft. The head usually has two articular surfaces, and is connected to the side of the body of two adjacent thoracic vertebrae; the neck is a constricted part of the bone, uniting the head to the shaft; the tubercle, close to the junction of the shaft and neck, is the part which articulates with the transverse process of the vertebra. The shaft is compressed, possesses an inner and outer surface, and an upper and lower border, but from the shaft being somewhat twisted on itself, the direction of the surfaces and borders is not uniform throughout the length of the bone. The ribs slope from their attachments to the spine, at first outward, downward and backward, then downward and forward, and where the curve changes from the backward to the forward direction an *angle* is formed on the rib. The angle and the tubercle are at the same place in the first rib and in each succeeding rib the angle is a little farther from the tubercle than in the last.

The first, tenth, eleventh and twelfth ribs articulate each with only one vertebra so that there is only one surface on the head. The surface of the first rib which is not in contact with the lung is directed upward, forward and outward while that of the second rib is much more outward; the eleventh and twelfth ribs are rudimentary, have neither neck nor tubercle, and are pointed anteriorly. The ribs are by no means uniform in length: they increase from the first to the seventh or eighth, and then diminish to the twelfth; the first and twelfth are therefore the shortest ribs. The first and second costal cartilages are almost horizontal, but the others are directed upward and inward.

In its general form the chest may be likened to a barrel which is wider below than above. It is rounded at the sides and flattened in front and behind, so that a man can lie either on his back or his belly. Its upper opening slopes downward and forward, is small in size, and

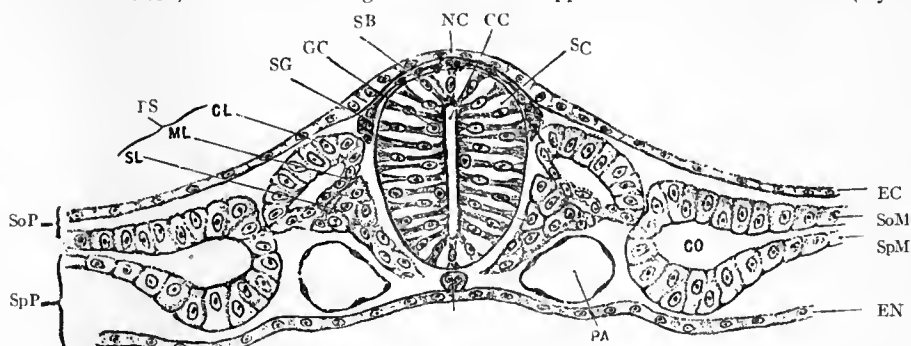

From Alfred H. Young and Arthur Robinson, *Cunningham's Text-Book of Anatomy*.

FIG. 4.—Transverse Section of a Ferret Embryo, showing further differentiation of the mesoderm.

- | | | |
|--|---|---|
| CC Central canal. | ML Muscular layer of mesodermic somite. | SG Spinal ganglion. |
| CL Cutaneous lamella of protovertebral somite. | N Notochord. | SL Scleratogenous layer of protovertebral somite. |
| CO Coelom. | NC Neural crest. | SoM Somatic mesoderm. |
| EC Ectoderm. | PA Primitiv aorta. | SoP Somatopleure. |
| EN Entoderm. | PS Mesodermic somite. | SpM Splanchnic mesoderm. |
| GC Germinal cell. | SB Spongoblast. | SpP Splanchnopleure. |
| | SC Spinal cord. | |

commata) between the muscle plates (myotomes), and so it is easy to realize that each typical rib must articulate with the bodies of two adjacent vertebrae, but with the neural arch, through its transverse process, of only one.

The intersegmental tissue between the bodies of the vertebrae becomes the intervertebral discs and in the centre of these a pulpy

mass is found which contains some remnants of the notochord. Elsewhere this structure is pressed out of existence and there is no further use for it when the cartilaginous vertebrae are once formed. One other series of structures must be mentioned though they do not

but the ventral ends of the ninth and sometimes the eighth probably remain as the xiphisternum, indeed a fibrous band is sometimes seen joining the caudal end of that structure to the ninth rib. The fusion of the two parallel bars begins at their cephalic ends and sometimes is interrupted toward the caudal end, thus leading to cleft or perforate sternum. At the cephalic end of each sternal bar, close to the place where the clavicles articulate, is an imperfectly separated patch of cartilage which usually fuses completely with the presternum, though sometimes it remains distinct and may later acquire a separate centre of ossification and so form a separate episternal bone on each side. If the sternum is to be regarded as the fused ventral ends of the thoracic ribs, the episternal elements are probably the remnants of the ventral ends of the seventh cervical ribs. The question of the morphological meaning of the sternum and surrounding parts cannot be settled entirely by a study of their development even when combined with what we know of their comparative anatomy or phylogeny. Professor A. M. Paterson (*The Human Sternum*, London, 1904) takes a different view from the foregoing and regards the sternum as derived from the shoulder girdle. To this point of view we shall return in the section on comparative anatomy.

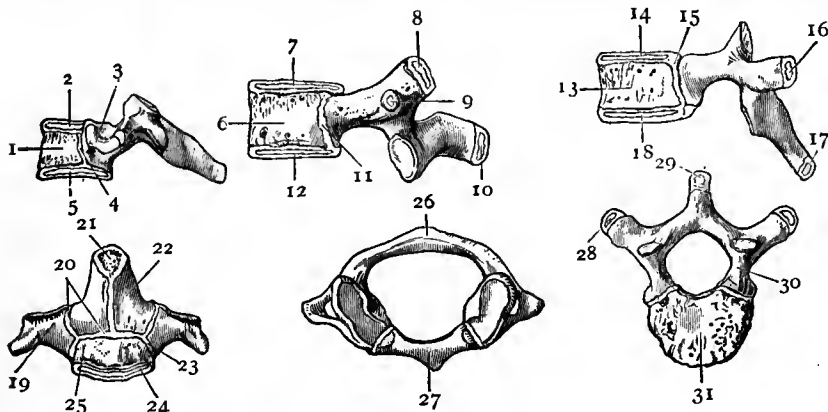

From Arthur Thomson, *Cunningham's Text-Book of Anatomy*.

FIG. 5.—Ossification of Vertebrae.

Cervical Vertebra.

- 1 Centre for body.
- 2 Superior epiphysal plate.
- 3 Anterior bar of transverse process developed by lateral extension from pedicle.
- 4 Neuro-central synchondrosis.
- 5 Inferior epiphysal plate.

Lumbar Vertebra.

- 6 Body.
- 7 Superior epiphysal plate.
- 8 Epiphysis for mammillary process.
- 9 Epiphysis for transverse process.
- 10 Epiphysis for spine.
- 11 Neuro-central synchondrosis.
- 12 Inferior epiphysal plate.

Dorsal Vertebra.

- 13 Centre for body.
- 14 Superior epiphysal plate, appears about puberty; unites at 25th year.
- 15 Neuro-central synchondrosis does not ossify till 5th or 6th year.
- 16 Appears at puberty; unites at 25th year.
- 17 Appears at puberty; unites at 25th year.
- 18 Appears about 6th week.

Axis.

- 19 Centre for transverse process and neural arch; appears about 8th week.
- 20 Synchondroses close about 3rd year.

- 21 Centre for summit of odontoid process; appears 3rd to 5th year, fuses 8th to 12th year.
- 22 Appears about 5th or 6th month; unites with opposite side 7th to 8th month.
- 23 Synchondrosis closes from 4th to 6th year.
- 24 Inferior epiphysal plate; appears about puberty, unites about 25th year.
- 25 Single or double centre for body; appears about 5th month.

Atlas.

- 26 Posterior arch and lateral masses developed from a single centre on either side, which appears about 7th week.
- 27 Anterior arch and portion of superior articular surface developed from single or double centre, appearing during 1st year.

Dorsal Vertebra.

- 28 Epiphysis for transverse process; appears about puberty, unites about 25th year.
- 29 Epiphysis appears about puberty; unites about 25th or 27th year.
- 30 Centre for neural arch on either side; appears about 6th or 7th week, the laminae unite from birth to 15th month.
- 31 Centre for body; appears about 6th week, unites with neural arch from 5th to 6th year.

play any great part in human development. In the intersegmental tissue ventral to each of the intervertebral disks a transverse rod of cells, known as a *hypochordal bar*, is formed which connects the heads of two opposite ribs. In man the greater number of these either disappear or form the middle fasciculus of the stellate ligament which joins the head of the rib to the intervertebral disk, but in the case of the atlas the rod chondrifies to form the anterior (ventral) arch which is therefore intersegmental, while the segmental body of the atlas, through which the notochord is passing, joins the axis to form the odontoid process. These hypochordal bars are interesting as the last remnant in man of the haemal arch of the vertebrae of fishes (see subsection on comparative anatomy). In the cervical region the ribs are very short and form the ventral boundary of the foramen for the vertebral artery. They are so short that little movement occurs between them and the rest of the vertebra, hence no joints are formed and the rib element becomes fused with the centrum and transverse process, leaving the vertebral canal between. Sometimes in the seventh cervical vertebra the rib element is much longer and then of course more movement occurs, and instead of fusing with the rest of the vertebra it remains as a separate cervical rib with definite joints.

The sternum is developed according to G. Ruge by a fusion of the ventral ends of the ribs on each side thus forming two parallel longitudinal bars which chondrify and eventually fuse together in the mid line. The anterior seven or sometimes eight ribs reach the sternum,

by centres which do not appear opposite the attachment of the ribs but alternately with them, so that although the original

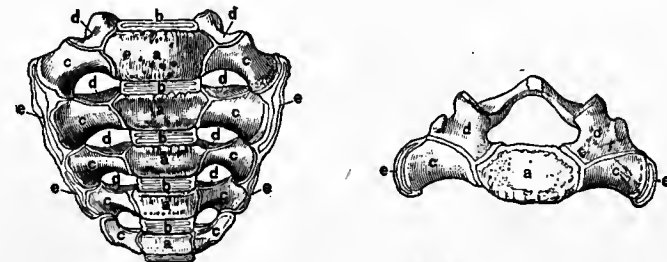

From Arthur Thomson, *Cunningham's Text-Book of Anatomy*.

FIG. 6.—Ossification of Sacrum—*a, a*, Centres for bodies; *b, b*, Epiphysal plates on bodies; *c, c*, Centres for costal elements; *d, d*, Centres for neural arches; *e, e*, Lateral epiphyses.

cartilaginous structure is probably intersegmental the bony segments are segmental like those of the vertebral centra. As seven ribs articulate with the sternum six centres of ossification between them might be looked for, but there is so little room between the points of attachment of the sixth and seventh ribs that centres do not occur

here as a rule. Consequently five centres are found; those for the two higher segments being single while the lower ones are often double. Later on in life a centre for the xiphisternum appears.

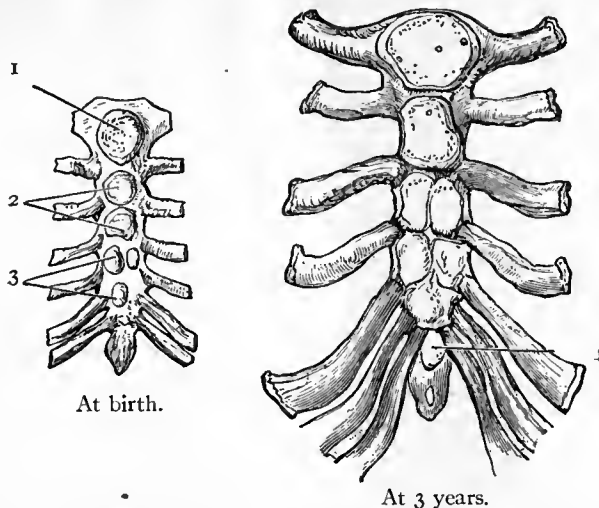

From Arthur Thomson, *Cunningham's Text-Book of Anatomy*.

FIG. 7.—Ossification of the Sternum. In this figure the second as well as the third segment of the body possesses two centres.

- | | | | |
|---|---------------------------------|---|---|
| 1 | Appears about 5th or 6th month; | III. segment unites with II. about puberty; | IV. segment unites with III. early childhood. |
| 2 | Appear about 7th month; | | |
| 3 | Appear about 8th or 9th | 4 | Appears about 3rd year or |

For further details see C. S. McMurrich, *The Development of the Human Body* (London, 1906). This includes bibliography, but G. Ruge's paper on the development of the sternum (*Morph. Jahrb.* vi. 1880) is of special importance.

Comparative Anatomy.—Just as in development the notochord forms the earliest structure for stiffening the embryo, so in the animal kingdom it appears before the true backbone or vertebral column is evolved. This is so important that the older phylum of Vertebrata has now been expanded into that of Chordata to include all animals which either permanently or temporarily possess a notochord. In the subphylum Adelochorda, which includes the worm-like *Balanoglossus*, as well as the colonial forms *Rhabdopleura* and *Cephalodiscus*, an entodermal structure, apparently corresponding to the notochord of higher forms, is found in the dorsal wall of the pharynx. In the subphylum Urochorda or Tunicata, to which the ascidians or sea-squirrels belong, the notochord is present in the tail region only and as a rule disappears after the metamorphosis from the larval to the adult form. In the Acrania, which are represented by *Amphioxus* (the lancelet), and are sometimes classed as the lowest division of the subphylum Vertebrata, the notochord is permanent and extends the whole length of the animal. Both this and the nerve cord dorsal to it are enclosed in tubes of mesodermal connective tissue which are continuous with the fibrous myocommata between the myotomes. Here then is a notochord and a membranous vertebral column resembling a stage in man's development. In the Cyclostomata (hags and lampreys) the notochord and its sheath persist through life, but in the adult lamprey (*Petromyzon*) cartilaginous neural arches are developed. In cartilaginous ganoid fishes like the sturgeon, the notochord is persistent and has a strong fibrous sheath into which the cartilage from the neural arches encroaches while in the elasmobranch fishes (sharks and rays) the cartilaginous centra are formed and grow into the notochord, thus causing its partial absorption. The growth is more marked peripherally than centrally, and so each centrum when removed is seen to be deeply concave toward both the head and tail; such a vertebra is spoken of as *amphicoelous* and with one exception is always found in fishes which have centra. In the body fish (Teleostei) and mud-fish (Dipnoi) the vertebrae are ossified.

If a vertebra from the tail of a bony fish like the herring be examined, it will be seen to have a ventral (haemal) arch surrounding the caudal blood-vessels and corresponding to the dorsal or neural arch which is also present. In the anterior or visceral part of the body the haemal arch is split and its two sides spread out deep to the muscles and lying between them and the coelom to form the ribs. In the elasmobranchs on the other hand the ribs lie among the muscles as they do in higher vertebrates, and the fact that both kinds of ribs are coexistent in the same segments in the interesting and archaic Nilotic fish *Polypterus bichir* shows that they are developed independently of one another. The sternum is never found in fishes with the possible exception of the comb-toothed shark (*Notidanus*). Among the Amphibia the tailed forms (*Urodela*) have amphicoelous vertebrae in embryonic life and so have some of the

adult salamanders, but usually the intercentral remnants of the notochord are pressed out of existence by the forward growth of the centrum behind it, so that in the adult each vertebra is only concave behind (*opisthocelous*). In the Anura (frogs and toads), on the other hand, the centra are usually concave forward (*procoelous*) and some of the posterior ones become fused into a long delicate bone, the *urostyle*. The ribs of urodeles have forked vertebral ends and are thus attached to the centrum as well as to the neural arch of a vertebra; this forking is supposed to be homologous with the double ribs of *Polypterus* already referred to. The sternum as a constant structure first appears in amphibians and is more closely connected with the shoulder girdle than with the ribs, the ventral ends of which, except in the salamander *Necturus*, are rudimentary. It is not certain whether it is the homologue of the sternum of the fish *Notidanus*, but the subject is discussed by T. J. Parker and A. M. Paterson (*The Human Sternum*, London, 1904, p. 50), and still requires further research. If the sternum be regarded as a segmental structure or series of segmental structures corresponding to the centra of the vertebrae there is no reason why it should not develop independently of the intersegmental ribs and, when the ribs are suppressed, gain a secondary connexion with the shoulder girdle. In Reptilia the centra of the vertebrae are usually *procoelous*, though there are a few examples, such as the archaic Tuatera lizard (*Sphenodon*), in which the amphicoelous arrangement persists. There are several cervical vertebrae instead of one, which is all the amphibians have. The odontoid bone is usually separate both from the atlas and axis while, between the atlas and the skull, there are rudiments of an extra intervertebral dorsal structure or *pro-atlas* in some forms such as the crocodile and *Sphenodon* lizard. Two sacral vertebrae (*i.e.* vertebrae articulating with the ilium) are generally present instead of the one of the Amphibia, but they are not fused together as in mammals. In the tail region haemal arches are often found enclosing the caudal artery and vein as they are also in urodele amphibians; in some species these are separate and are then spoken of as *chevron bones*. In the Crocodylia intervertebral disks first appear. Ribs are present in the cervical, thoracic and lumbar regions, and in the Chelonia (tortoises) the cervical ones blend with the vertebrae as they do in higher forms. In crocodiles a definite vertebral canal is established in the cervical region which henceforward becomes permanent. The shafts of the ribs are sometimes all in one piece as in snakes or they may be developed by three separate centres as in *Sphenodon* with intervening joints. In these cases dorsal, intermediate and ventral elements to each shaft are present. In Crocodylia and *Sphenodon* there are spurs from each thoracic rib which overlap the next rib behind and are known as *uncinate processes*; they are developed in connexion with the origin of the external oblique muscle of the abdomen and are very constant in birds. The ventral elements of some of the hinder ribs are found in the Crocodylia lying loose in the myocommata of the rectus and obliquus internus (inscriptions tendineae) and are known as abdominal ribs, while the sacral vertebrae articulate with the ilium through the intervention of short rods of bone, sometimes called *pleurapophyses*, which are no doubt sacral ribs. The sternum of reptiles is a broad plate of cartilage which may be calcified but is seldom converted into true bone; it always articulates with the coracoids (see section *Appendicular*) anteriorly and with a variable number of ribs laterally and posteriorly. It should not be confounded with the dagger-shaped interclavicle which, like the clavicles, is a membrane bone and overlaps the sternum ventrally. It is also probable that the interclavicle is morphologically quite distinct from the episternum, of which vestiges are present in man and are referred to above in the section on embryology (see fig. 27). In birds the characteristics are largely reptilian with some specialized adaptations to their bipedal locomotion and power of flight. One effect of this is that the two true sacral vertebrae become secondarily fused with the adjacent lumbar, caudal and even thoracic, and these again fuse with the ilium so that the posterior part of a bird's trunk is very rigid. The neck, on the other hand, is very movable and the centra articulate by means of saddle-shaped joints which give the maximum of movement combined with strength (see *JOINTS*). The caudal vertebrae are fused into a flattened bone, the *pygostyle*, to support the tail feathers. In the fossil bird *Archaeopteryx* the centra are amphicoelous and the long tail has separate caudal vertebrae. The ribs are few and consist of dorsal (vertebral) and ventral (sternal) parts; the former almost always have uncinate processes. Free cervical ribs are often present and *Archaeopteryx* possessed abdominal ribs. The sternum is very large and in flying birds (*Carinatae*) has a median keel (*carina*) projecting from it, while the non-flying, ostrich-like birds (*Ratitae*) have no such structure.

In Mammalia the centra articulate by means of the intervertebral disks and it is only in this class that the epiphysal plates appear though these are absent in the Monotremata (duck-mole, &c.) and Sirenia (sea-cows). The cervical vertebrae are with a few exceptions (two-toed and three-toed sloths and the manatee or sea-cow) always seven in number, and some, usually all, of them have a vertebral canal in the transverse process. In some of the Cetacea they are fused together. In the Ornithorhynchus the odontoid is a separate bone, as it is in many reptiles, but this part includes the facets by means of which the axis and atlas articulate. The thoracic

vertebrae vary from ten in some of the whales and the peba armadillo to twenty-four in the two-toed sloth, though thirteen or fourteen is the commonest number. In the anterior part of the thoracic region the spines point backward, while in the posterior thoracic and lumbar regions they have a forward direction. There is always one spine in the posterior thoracic region, which is vertical, and the vertebra which bears this is known as the *antitlinal vertebra*. The

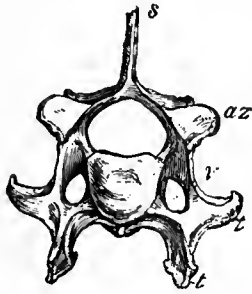

FIG. 8.—Anterior Surface of Sixth Cervical Vertebra of Dog.

- s Spinous process.
- az Anterior zygapophysis.
- v Vertebral arterial canal.
- t Transverse process.
- l' Its costal lamella.

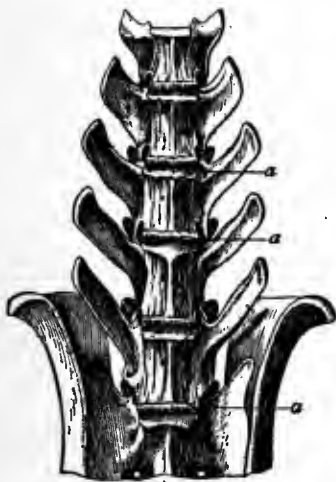

FIG. 9.—Side View of the First Lumbar Vertebra of a Dog (*Canis familiaris*).

- s Spinous process.
- m Metapophysis.
- az Anterior zygapophysis.
- pz Posterior zygapophysis.
- a Anapophysis.
- t Transverse (costal) process.

lumbar vertebrae vary from two in the Ornithorhynchus and some of the armadillos to twenty-one in the dolphin, the average number being probably six. Both the mammillary and accessory tubercles (meta- and ana-pophyses) are in some forms greatly enlarged. It is usually held that the former are morphologically muscular processes while the latter represent the transverse processes of the thoracic vertebrae. In the American edentates additional articular processes (zygapophyses) are developed, so that these animals are sometimes divided from the old-world edentates and spoken of as Xenarthra.

Lying ventral to the intervertebral disks in many mammals small paired ossicles are occasionally found; these are called *intercentra* and are ossifications in the hypochordal bar (see subsection on embryology). They probably represent the places where the chevron bones or haemal arches would be attached and are the serial homologues of the anterior arch of the atlas (see fig. 10).



After F. G. Parsons, "On Anatomy of *Atherura Africana*," *Proc. Zool. Soc.*, 1894.

FIG. 10.—The Intercentra of the Lower Part of the Vertebral Column. a, a, a, Intercentra.

(*Scientif. Trans. R. Dublin Society*, vol. v., ser. II, p. 123). Taking the vertebrae which fuse together as an arbitrary definition of the sacrum, we find that the number may vary from one in *Cercopithecus patas* to thirteen in some of the armadillos, and, if the Cetacea are included, seventeen in the bottle-nosed dolphin, Tursiops. Four seems to be about the average of sacral vertebrae in the mammalian class and of these one or two are true sacral. In some of the Edentata the posterior sacral vertebrae are fused with the ischium, in other words the great sacro-sciatic ligament is ossified. The lateral

centres of ossification which form the articular surface for the ilium probably represent rib elements. The caudal or tail vertebrae vary from none at all in the bat *Megaderma* to forty-nine in the pangolin (*Manis macrura*). The anterior ones are remarkable for usually having chevron bones (shaped like a V) on the ventral surface of the intercentral articulation. These protect the caudal vessels and give attachment to the ventral tail muscles. The ribs in mammals correspond in number to the thoracic vertebrae. In monotremes the three parts of the rib (dorsal, intermediate and ventral) already noticed in the reptiles are found, but usually the intermediate part is suppressed. The ventral part generally remains cartilaginous as it does in man though sometimes it ossifies as in the armadillos. In the typical pronograde mammals the shape of the ribs differs from that of the higher Primates and man: they are so curved that the dorso-ventral diameter of the thorax is greater than the transverse while in the higher Primates the thorax is broader from side to side than it is dorso-ventrally. In this respect the bats agree with man and the lemurs with the pronograde mammals.

In some whales the first rib articulates by an apparently double head with two vertebrae; this is probably the result of a cervical rib joining it a little way from the vertebral column, and the result is homologous with those cases in man in which a cervical rib joins the first thoracic as it sometimes does. In the toothed whales, of which the porpoise is an example, the more posterior ribs lose their heads and necks and only articulate with the transverse processes. The sternum of mammals typically consists of from seven to nine narrow segments or sternbrae, the first of which (presternum) is often broader than those behind. As a rule the second rib articulates with the interval between the first and second pieces, but sometimes, as in the gibbon, it is the third rib which does so. When this is the case, as it sometimes is in man, the first two sternbrae have probably fused (see A. Keith, *Journ. Anat. and Phys.* xxx. 275). The segmental character of the separate sternbrae contrasts strongly with the intersegmental of the ribs. When the pectoralis major muscle is largely developed, as in the mole and bats, the sternum, especially the presternum, develops a keel as in birds. In the toothed whales there is usually a cleft or perforation throughout life between the two lateral halves of the sternum. In the whalebone whales the mesosternum is suppressed and consequently only the first ribs reach the sternum; this is of great interest when the oblique position of the diaphragm (see art. DIAPHRAGM) in these animals is remembered, and makes one suspect that the development of the sternum in mammals is dependent on and subservient to the attachment of the diaphragm. The broadened thorax of the anthropomorpha is accompanied by a broadened sternum and the sternbrae of the mesosternum fuse together early, though in the orang they not only remain separate but each half of them remains separate until the animal is half-grown. The episternum is represented by small ossicles which occasionally occur in man, while in the Ornithorhynchus and the tapir there is a separate bone in front (cephalad) of the presternum which in the former animal is distinct at first from the interclavicle, and this probably represents the episternum, though it was called by W. K. Parker by the noncommittal name of *probsteon*.

For further details and literature see S. H. Reynolds, *The Vertebrate Skeleton* (Cambridge, 1897); W. H. Flower and H. Gadow,

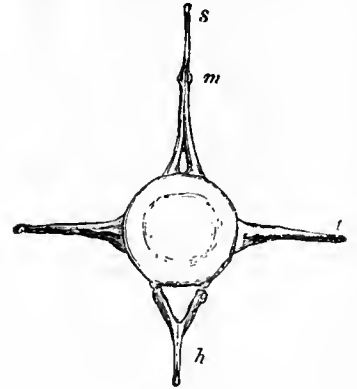

FIG. 11.—Anterior Surface of Fourth Caudal Vertebra of Porpoise (*Phocoena communis*).

- s Spinous process.
- m Metapophysis.
- t Transverse process.
- h Chevron bone.

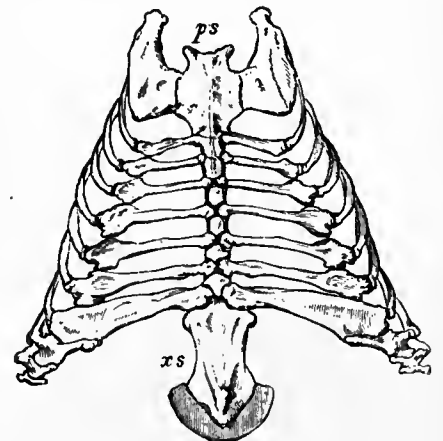

FIG. 12.—Sternum and strongly ossified Sternal Ribs of Great Armadillo (*Priodon gigas*). ps, Presternum; xs, xiphisternum.

The episternum is represented by small ossicles which occasionally occur in man, while in the Ornithorhynchus and the tapir there is a separate bone in front (cephalad) of the presternum which in the former animal is distinct at first from the interclavicle, and this probably represents the episternum, though it was called by W. K. Parker by the noncommittal name of *probsteon*.

Osteology of the Mammalia (London, 1885); R. Wiedersheim, *Comparative Anatomy of Vertebrates*, adapted and translated by W. N. Parker (London, 1907); R. Wiedersheim and G. Howes, *The Structure of Man* (London, 1897); C. Gegenbaur, *Vergleich. Anat. der Wirbeltiere*, Band i. (Leipzig, 1901).

Appendicular.

The bony framework of the two appendages or extremities, as the upper and lower limbs are called, is built up on the same plan in both. Each consists of a limb girdle (shoulder and hip girdles) connecting it with the axial skeleton, a proximal single bone segment (humerus, femur), a distal double bone segment (radius, ulna; tibia, fibula), the hand and foot segments (carpus, metacarpus; tarsus, metatarsus) and the digits (phalanges). It should be understood that in the following descriptions the terms internal and external are used in relation to the mid-line of the body and not to that of the limb.

The upper limb in man may be subdivided into a proximal part or shoulder, a distal part or hand, and an intermediate shaft, which consists of an upper arm or *brachium*, and a forearm or *ante-brachium*. In each of these subdivisions certain bones are found: in the shoulder, the clavicle and scapula; in the upper arm, the humerus; in the forearm, the radius and ulna, the bone of the upper arm in man being longer than the bones of the forearm; in the hand, the carpal and metacarpal bones and the phalanges. The scapula and clavicle together form an imperfect bony arch, the Scapular Arch or Shoulder Girdle; the shaft and hand form a free divergent Appendage. The shoulder girdle is the direct medium of connexion between the axial

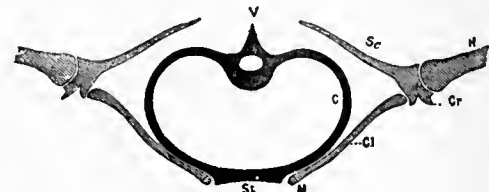

FIG. 13.—Diagrammatic Section to represent the Relations of the Shoulder Girdle to the Trunk.

- V A thoracic vertebra.
- C A rib.
- St The sternum.
- Sc The scapula.
- Cr The coracoid.
- Cl The clavicle.
- M The meniscus at its sternal end.
- H The humerus.

skeleton and the divergent part of the limb; its anterior segment, the clavicle, articulates with the upper end of the sternum, whilst its posterior segment, the scapula, approaches, but does not reach, the dorsal spines.

The clavicle, or collar bone (fig. 14), is an elongated bone which extends from the upper end of the sternum horizontally outward, to articulate with the acromion process of the scapula. It presents a strong sigmoidal curve, which is associated with the transverse and horizontal direction of the axis of the human shoulder. It is slender in the female, but powerful in muscular males; its sternal end thick and somewhat triangular; its acromial end, flattened from above downward, has an oval articular surface for the acromion. Its shaft has four surfaces for the attachment of muscles; and strong ligaments connecting it with the coracoid, is attached to the under surface, near the outer end, whilst near the inner a strong ligament passes between it and the first rib.

The scapula, or shoulder blade (fig. 14), is the most important bone of the shoulder girdle, and is present in all mammals. It lies at the upper and back part of the wall of the chest, reaching from the second to the seventh rib. Its form is plate-like and triangular, with three surfaces, three borders, and three angles. Its costal or ventral surface is in relation to the ribs, from which it is separated by certain muscles: one, called *subscapularis*, arises from the surface itself, which is often termed *subscapular fossa*. The dorsum or back of the scapula is traversed from behind forward by a prominent *spine*, which lies in the proper axis of the scapula, and subdivides this aspect of the bone into a surface above the spine, the *supra-spinous fossa*, and one below the spine, the *infra-spinous fossa*. The spine arches forward to end in a broad flattened process, the *acromion*, which has an oval articular surface for the clavicle; both spine and acromion are largely developed in the human scapula in correlation with the great size of the trapezius and deltoid muscles, which are concerned in the elevation and abduction of the upper limb. The borders of the scapula, directed upward, backward, and downward, give attachment to several muscles. The angles are inferior, antero-superior, and postero-superior. The antero-superior is the most important; it is truncated, and has a large, shallow, oval, smooth surface, the *glenoid fossa*, for articulation with the humerus, to form the shoulder joint. Overhanging the glenoid fossa is a curved beak-like process, the *coracoid*, which is of importance as corresponding with the separate coracoid bone of monotremes, birds and reptiles. The line of demarcation between it and the scapula proper is marked on the upper border of the scapula by the supra-scapular notch

The humerus, or bone of the upper arm (fig. 14), is a long bone, and consists of a shaft and two extremities. The upper extremity possesses a convex spheroidal smooth surface, the *head*, **Humerous.** for articulation with the glenoid fossa of the scapula; it is surrounded by a narrow constricted *neck*, and where the neck and shaft become continuous with each other, two processes or *tuberosities* are found, to which are attached the rotator muscles arising from the scapular fossae. Between the tuberosities is a groove in which the long tendon of the biceps rests. A line drawn through the head of the humerus perpendicular to the middle of its articular surface, forms with the axis of the shaft of the bone an angle of 40°. The shaft of the humerus is triangular in section above, but flattened and expanded below; about midway down the outer surface is a rough ridge for the insertion of the deltoid muscle, and on the inner surface another rough mark for the insertion of the coraco brachialis. A shallow groove winds round the back of the bone, in which the musculo-spiral nerve is lodged. The lower extremity of the humerus consists of an articular and a non-articular portion. The articular has a small head or *capitellum* externally for the radius, and a pulley or *trochlea* internally for the movements of the ulna in flexion and extension of the limb. The non-articular part has a projection both on its inner and outer aspect; these are known as the *internal* and *external* condyles, and of these the internal is the more prominent; each is surmounted by a *supracondylar ridge*, and the internal condyle and ridge attach the muscles passing to the flexor surface of the forearm, while the external are for those passing to the extensor surface.

A small, downwardly directed, hook-like process of bone is occasionally found above the internal condyle and is the vestige of the supracondylar foramen found in so many of the lower animals (see below *Comparative Anatomy*).

Before describing the two bones of the forearm, the range of movement which can take place between them should be noticed. In one position, which is called *supine*, they lie parallel to each other, the radius being the more external bone, and the palm of the hand being directed forward; in the other or *prone* position the radius crosses obliquely in front of the ulna, and the palm of the hand is directed backward. Not only the bones of the forearm, but those of the hand are supposed to be in the supine position when they are described.

The radius (fig. 14) is the outer bone of the forearm, and like all long bones possesses a shaft and two extremities. The upper extremity or *head* has a shallow, smooth cup for moving on the capitellum of the humerus; the outer margin of the cup is also smooth, for articulation with the ulna and orbicular ligament; below the cup is a constricted *neck*, and immediately below the neck a *tuberosity* for the insertion of the biceps. The shaft of the bone possesses three surfaces for the attachment of muscles, and a sharp inner border for the interosseous membrane. The lower end of the bone is much broader than the upper, and is marked posteriorly by grooves for the lodgment of tendons passing to the back of the hand: from its outer border a pointed *styloid* process projects downward; its inner border has a smooth shallow fossa (the sigmoid cavity of the radius) for articulation with the ulna, and its broad lower surface is smooth and concave, for articulation with the scaphoid and semilunar bones of the wrist.

The ulna (fig. 14) is also a long bone. Its upper end is subdivided into two strong processes by a deep fossa, the *greater sigmoid cavity*, which possesses a smooth surface for articulation with the trochlea of the humerus. The anterior or *coronoid* process is rough in front for the insertion of the brachialis anticus, whilst the posterior or *olecranon* process gives insertion to the large triceps muscle of the upper arm. Immediately below the outer border of the great sigmoid cavity is the *small sigmoid cavity* for articulation with the side of the head of the radius. The shaft of

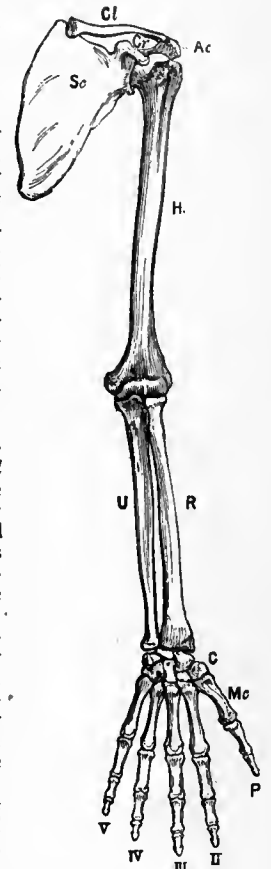

FIG. 14.—The Appendicular Skeleton of the Left Upper Limb.

- Cl Clavicle.
- Sc Scapula.
- Ac Acromion process.
- Cr Coracoid process of scapula.
- H Humerus.
- R Radius.
- U Ulna.
- C Opposite the eight carpal bones.
- Mc Opposite the five metacarpal bones.
- P Pollex, or thumb.
- II. Index.
- III. Middle.
- IV. Ring.
- V. Little finger.

Ulna.

the bone has three surfaces for the attachment of muscles, and a sharp outer border for the interosseous membrane. The lower end, much smaller than the upper, has a pointed *styloid* process and a smooth articular surface, the outer portion of which is for the lower end of the radius, the lower part for moving on a cartilage of the wrist joint called the triangular fibro-cartilage.

The hand consists of the carpus or wrist, of the metacarpus or palm, and of the free digits, the thumb and four fingers. Anatomists describe it with the palm turned to the front, and with its axis in line with the axis of the forearm.

Hand.

The carpal or wrist bones (fig. 14) are eight in number and small in size: they are arranged in two rows, a *proximal*,—i.e. a row next the forearm,—consisting of the scaphoid, semilunar, cuneiform and pisiform; and a *distal*,—i.e. a row next

the bones of the palm,—consisting of a trapezium, trapezoid, os magnum and unciform; the bones in each row being named in the order they are met with, from the radial or outer to the ulnar or inner side of the wrist. It is unnecessary to give a separate description of each bone. Except the pisiform or pea-shaped bone, which articulates with the front of the cuneiform, each carpal bone is short and irregularly cuboidal in shape; its anterior (or palmar) surface and its posterior (or dorsal) being rough, for the attachment of ligaments; its superior and inferior surfaces being invariably smooth, for articulation with adjacent bones; whilst the inner and outer surfaces are also smooth, for articulation, except the outer surfaces of the scaphoid and trapezium (the two external bones of the carpus), and the inner surfaces of the cuneiform and unciform (the two internal bones). Occasionally extra bones are found, but they are apparently the remnants of cartilaginous elements found in the hand of the early embryo (see G. Thilenius, *Morph. Arbeiten*, v., 1896).

The metacarpal bones, or bones of the palm of the hand, are five in number (fig. 14). They are miniature long bones, and each possesses a shaft and two extremities. The metacarpal of the thumb is the shortest, and diverges outward from the rest; its carpal extremity is saddle-shaped, for articulation with the trapezium; its shaft is somewhat compressed, and its phalangeal end is smooth and rounded, for the first phalanx of the thumb. The four other metacarpal bones belong to the four fingers; they are almost parallel to each other, and diminish in size from the second to the fifth. Their carpal ends articulate with the trapezoid, os magnum and unciform: their shafts are three-sided: their phalangeal ends articulate with the proximal phalanges of the fingers.

The number of digits in the hand is five. They are distinguished by the names of pollex or thumb, index, medius, annularis and minimus. Their skeleton consists of fourteen bones, named phalanges, of which the thumb has two, and each of the four fingers three. The phalanx next the metacarpal bone is the proximal, that which carries the nail, the terminal or ungual phalanx, whilst the intermediate bone is the middle phalanx. Each is a miniature long bone, with two articular extremities and an intermediate shaft, except the terminal phalanges, which have an articular surface only at their proximal ends, the distal end being rounded and rough, to afford a surface for the lodgment of the nail.

The INFERIOR or PELVIC EXTREMITY, or LOWER LIMB, consists of a proximal part or haunch, a distal part or foot, and an intermediate shaft subdivided into thigh and leg. Each part has its appropriate skeleton (the thigh-bone in man being longer than the leg-bones). The bone of the haunch (os innominatum) forms an arch or pelvic girdle, which articulates behind with the side of the sacrum, and arches forward to articulate with the opposite

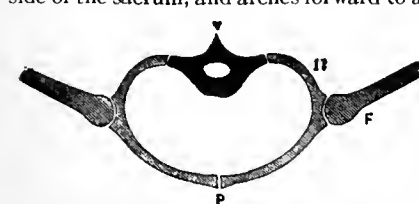

FIG. 15.—Diagrammatic section to represent the relations of the Pelvic Girdle to the Trunk.

- V A sacral vertebra.
- Il The ilium.
- P The two pubic bones meeting in front at the symphysis.
- F The femur.

haunch-bone at the pubic symphysis. It is the direct medium of connexion between the axial skeleton and the shaft and foot, which form a free divergent appendage. The os innominatum, or haunch-bone, is a large irregular plate-like bone, which forms the lateral and inferior boundary of the cavity of the pelvis. In early life it consists of three bones—ilium, ischium and pubis—which unite about the twenty-fifth

Pelvic girdle.

year into a single bone. These bones converge, and join to form a deep fossa or cup, the *acetabulum* or *cotyloid cavity*, on the outer surface of the bone, which lodges the head of the thigh-bone at the hip-joint. One-fifth of this cup is formed by the pubes, and about two-fifths each by the ischium and ilium. At the bottom of the acetabulum is a depression, to the sides of which the ligamentum teres of the hip-joint is attached. From the acetabulum the ilium extends upward and backward, the ischium downward and backward, the pubis forward, inward and

downward. Below the acetabulum is a large hole, the *obturator* or *thyroid foramen*, which is bounded by the ischium and pubes; behind and above the acetabulum is the deep *sciatic notch*, which is bounded by the ischium and ilium, and below this is the *small sciatic notch*.

The ilium (fig. 16) in man is a broad plate-like bone, the lower end of which aids in forming the acetabulum, while the upper end forms the iliac crest, which, in man, in conformity with the general expansion of the bone, is elongated into the sinuous crest of the ilium. This crest is of great importance, for it affords attachment to the broad muscles which form the wall of the abdominal cavity. One surface of the ilium is *external*, and marked by curved lines which subdivide it into areas for the origin of the muscles of the buttock; another surface is *anterior*, and hollowed out to give origin to the iliacus muscle; the third, or *internal*, surface articulates posteriorly with the sacrum, whilst anteriorly it forms a part of the wall of the true pelvis. The external is separated from the anterior surface by a border which joins the anterior end of the crest, where it forms a process, the *anterior superior spine*. About the middle of this border is the *anterior inferior spine*. Between the external and internal surfaces is a border on which are found the *posterior superior* and *inferior spines*; between the anterior and internal surfaces is the *ilio-pectineal line*, which forms part of the line of separation between the true and false pelvis.

The pubis (fig. 16) is also a three-sided, prismatic, rod-like bone, the fundamental form of which is obscured by the modification in shape of its inner end. In human anatomy it is customary to regard it as consisting of a *body* and of two branches, an upper and a lower *ramus*.

The *upper ramus* runs downward, forward and inward from the acetabulum to the *body of the pubis*, which is a plate of bone placed nearly horizontally in the upright position of the subject and articulating with its fellow of the opposite side at the symphysis pubis (see JOINTS). Projecting forward from the junction of the body and upper ramus is the *pubic spine*, an important landmark in surgery, and to this the *ilio-pectineal line*, already mentioned, may be traced.

The *lower ramus* is really more horizontal than the upper (which used to be called the horizontal ramus), and runs backward and outward from the body to meet the *ramus of the ischium* and so form the *subpubic arch*.

The ischium (fig. 16), like the ilium and pubis, has the fundamental form of a three-sided prismatic rod. One extremity (the upper) completes the acetabulum, whilst the lower forms the large prominence, or *tuber ischii*. The surfaces of the bone are *internal* or *pelvic*, *antero-external*, and *postero-external*. The pelvic and postero-external surfaces are separated from each other by a sharp border, on which is seen the *ischial spine*. The pelvic and antero-external surfaces are separated by a border, which forms a part of the boundary of the obturator foramen; but the margin between the antero- and postero-external surfaces is feebly marked. The tuberosity, a thick, rough and strong process, gives origin to several powerful muscles: on it the body rests in the sitting posture; a flattened ramus ascends from it to join the lower ramus of the pubis, and completes both the pubic arch and the margin of the obturator foramen.

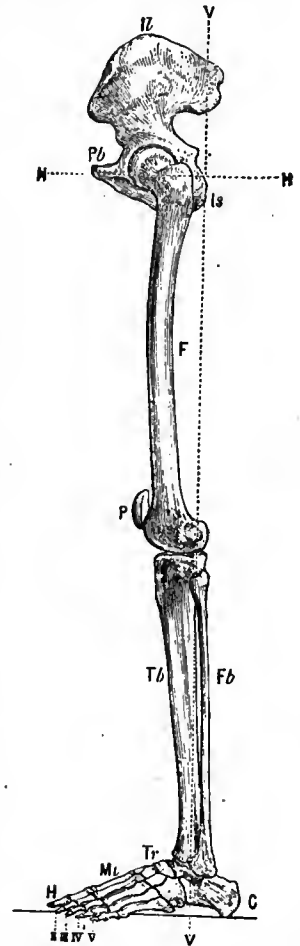

FIG. 16.—The Appendicular Skeleton of the Left Lower Limb.

- Il Ilium.
- Is Ischium.
- Pb Pubis, the three parts of the innominate bone.
- F Femur.
- P Patella.
- Tb Tibia.
- Fb Fibula.
- Tr Opposite the seven tarsal bones.
- C Os calcis, forming prominence of heel.
- Mt Opposite the five metatarsal bones.
- H Hallux or great toe.
- II. Second.
- III. Third.
- IV. Fourth.
- V. Fifth or little toe. The dotted line HH represents the horizontal plane, whilst the dotted line V is in line with the vertical axis of the spine.

By the articulation of the two innominate bones with each other in front at the pubic symphysis, and with the sides of the sacrum behind, the osseous walls of the cavity of the **PELVIS** are formed. This cavity is subdivided into a false and a true pelvis. The false pelvis lies between the expanded wing-like portions of the two ilia. The true pelvis lies below the two ilio-pectineal lines and the base of the sacrum, which surround the upper orifice or brim of the true pelvis, or pelvic inlet; whilst its lower orifice or outlet is bounded behind by the coccyx, laterally by the ischial tuberosities, and in front by the pubic arch. In the erect attitude the pelvis is so inclined that the plane of the brim forms with the horizontal plane an angle of from 60° to 65°. The axis of the cavity is curved, and is represented by a line dropped perpendicularly from the planes of the brim, the cavity and the outlet; at the brim it is directed downward and backward, at the outlet downward and a little forward. Owing to the inclination of the pelvis, the base of the sacrum is nearly 4 in. higher than the upper border of the pubic symphysis. The female pelvis is distinguished from the male by certain sexual characters. The bones are more slender, the ridges and processes for muscular attachment more feeble, the breadth and capacity greater, the depth less, giving the greater breadth to the hips of a woman; the inlet more nearly circular, the pubic arch wider, the distance between the tuberosities greater, and the acetabulum smaller in the female than in the male. The greater capacity of the woman's over the man's pelvis is to afford greater room for the expansion of the uterus during pregnancy, and for the expulsion of the child at the time of birth.

The femur or thigh-bone (fig. 16) is the longest bone in the body, and consists of a shaft and two extremities. The upper extremity or head has a smooth hemispherical surface, in which an oval roughened fossa, for the attachment of the ligamentum teres of the hip, is found; from the head a strong elongated neck passes downward and outward to join the upper end of the shaft; the place of junction is marked by two processes or trochanters; to the external or great trochanter are attached many muscles; the internal or lesser trochanter gives attachment to the psoas and iliacus. A line drawn through the axis of the head and neck forms with a vertical line drawn through the shaft an angle of 30°; in a woman this angle is a little less obtuse than in a man, and the obliquity of the shaft of the femur is slightly greater in the former than in the latter. The shaft is almost cylindrical about its centre, but expanded above and below; its front and sides give origin to the extensor muscles of the leg; behind there is a rough ridge, which, though called *linea aspera*, is really a narrow surface and not a line; it gives attachment to several muscles. The lower end of the bone presents a large smooth articular surface for the knee-joint, the anterior portion of which forms a *trochlea* or pulley for the movements of the patella, whilst the lower and posterior part is subdivided into two convex condyles by a deep fossa which gives attachment to the crucial ligaments of the knee. The inner and outer surfaces of this end of the bone are rough, for the attachment of muscles and the lateral ligaments of the knee.

The femur constitutes usually about 0.275 of the individual stature; but this proportion is not constant, as this bone forms a larger element in the stature of a tall than of a short man. The human femur presents also a concave popliteal surface, thus differing from that of *Pithecanthropus*, whose popliteal surface is convex. In the bones of some races the dorsal ridge of the thigh-bone (*linea aspera*) projects as a prominent crest causing the bones to appear "pilastered," a condition the amount of which is indicated by the increased relative length of the sagittal of the coronal diameter of the bone. Pilastering, though characteristic of lower and primitive races of man, is never found in the anthropoids. The upper third of the femur in some races is sagittally flattened, a condition which is called *platymeria*. Its degree is indicated by the excess of the coronal over the sagittal diameter in this region.

The patella or knee-pan (fig. 16) is a small triangular flattened bone developed in the tendon of the great extensor muscles of the leg. Its anterior surface and sides are rough, for the attachment of the fibres of that tendon; its posterior surface is smooth, and enters into the formation of the knee-joint.

Between the two bones of the leg there are no movements of pronation and supination as between the two bones of the forearm. The tibia and fibula are fixed in position; the fibula is always external, the tibia internal.

The tibia or shin-bone (fig. 16) is the larger and more important of the two bones of the leg; the femur moves and rests upon its upper end, and down it the weight of the body in the

erect position is transmitted to the foot. Except the femur, it is the longest bone of the skeleton, and consists of a shaft and two extremities. The upper extremity is broad, and is expanded into two *tuberosities*, the external of which has a small articular facet inferiorly, for the head of the fibula; superiorly, the tuberosities have two smooth surfaces, for articulation with the condyles of the femur; they are separated by an intermediate rough surface, from which a short *spine* (really a series of elevations) projects, which gives attachments to the interarticular crucial ligaments and semilunar cartilages of the knee, and lies opposite the intercondylar fossa of the femur. The shaft of the bone is three-sided; its inner

surface is subcutaneous, and forms the shin; its outer and posterior surfaces are for the origin of muscles; the anterior border forms the sharp ridge of the shin, and terminates superiorly in a tubercle for the insertion of the extensor tendon of the leg; the outer border of the bone gives attachment to the interosseous membrane of the leg. The lower end of the bone, smaller than the upper, is prolonged into a broad process, *internal malleolus*, which forms the inner prominence of the ankle: its under surface is smooth for articulation with the astragalus; externally it articulates with the lower end of the fibula.

The tibia in most civilized races is triangular in the section of its shaft, but in many savage and prehistoric races it is two-edged. The condition is named *platycnemia*, and is indicated by the proportional excess of the sagittal over the coronal diameter. The foetal tibia has its head slightly bent backward with regard to the shaft, a condition which usually disappears in the adult, but which is shown in the prehistoric tibiae found in the cave of Spy. In races that squat on their heels the front margin of the lower end of the tibia is marked by a small articular facet for the neck of the astragalus.

The fibula, or splint-bone of the leg (fig. 16), is a slender long bone with a shaft and two extremities. The upper end or head articulates with the outer tuberosity of the tibia. The shaft is four-sided, and roughened for the origins of the muscles. Separating the anterior from the internal surface is a slender ridge for the attachment of the interosseous membrane. The lower end has a strong process (*external malleolus*) projecting downward to form the outer prominence of the ankle, and a smooth inner surface for articulation with the astragalus, above which is a rough surface for the attachment of ligaments which bind together the tibia and fibula.

The foot consists of the tarsus, the metatarsus and the five free digits or toes. The human foot is placed in the prone position, with the sole or plantar surface in relation to the ground; the dorsum or back of the foot directed upward; the axis of the foot at about a right angle to the axis of the leg; and the great toe or hallux, which is the corresponding digit to the thumb, at the inner border of the foot. The human foot, therefore, is a pentadactylous, plantigrade foot.

The bones of the tarsus or ankle (fig. 16, Tr), are seven in number, and are arranged in three transverse rows—a proximal, next the astragalus and os calcis, a middle, of the scaphoid and a distal next the metatarsus, consisting of the cuboid, ecto- and ento-cuneiform. If the tarsal bones be looked at along with those of the metatarsus and toes, the bones of the foot may be arranged in two longitudinal columns—an outer, consisting of the os calcis, cuboid and the metatarsal bones and phalanges of the fourth and fifth toes; an inner column consisting of the astragalus, scaphoid, three cuneiform and the metatarsal bones and phalanges of the first, second and third toes. The tarsal, like the carpal bones, are short and, with the exception of the cuneiforms which are wedge-shaped, irregularly cuboidal; the dorsal and plantar surfaces are as a rule rough for ligaments, but as the astragalus is locked in between the bones of the leg and the os calcis, its dorsal and plantar surfaces, as well as the dorsum of the os calcis, are smooth for articulation; similarly, its lateral surfaces are smooth for articulation with the two malleoli. The posterior surface of the os calcis projects backward to form the prominence of the heel. With this exception, the bones have their anterior and posterior surfaces smooth for articulation. Their lateral surfaces are also articular, except the outer surface of the os calcis and cuboid, which form the outer border; and the inner surface of the os calcis, scaphoid and ento-cuneiform, which form the inner border of the tarsus. Supernumerary bones are occasionally found as in the hand.

The metatarsal bones and the phalanges of the toes agree in number and general form with the metacarpal bones and the phalanges in the hand. The bones of the great toe or hallux are more massive than those of the other digits, and this digit, unlike the thumb or pollex, does not diverge from the other digits, but lies almost parallel to them.

Embryology.—The development of the appendicular skeleton takes

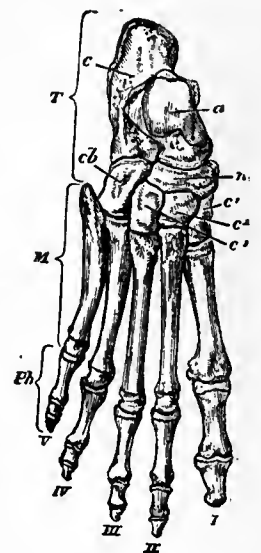

FIG. 17.—Bones of the right Human Foot.

T Tarsus.
M Metatarsus.
Ph Phalanges.
a Astragalus.
c Calcaneum.
cb Cuboid.
n Navicular.
c¹ Internal cuneiform.
c² Middle cuneiform.
c³ External cuneiform.
The digits are indicated by Roman numerals, counting from the tibial to the fibular side.

The digits are indicated by Roman numerals, counting from the tibial to the fibular side.

Toes.

place in the core of mesenchyme in the centre of each limb.¹ This substance first becomes changed into cartilage, except perhaps in the case of the clavicle, though there is at present some doubt as to how much of this bone is chondrified before ossification reaches it.

The present belief is that, although a deposit of lime salts constituting the process of calcification may and frequently does occur in cartilage, true ossification or the orderly disposal of that deposit into bony tissue can only take place through the intervention of osteoblasts and osteoclasts, and as these cells are not formed in cartilage they must make their way in from the surrounding fibrous tissue which constitutes the perichondrium.

The factors which determine the general shape and proportionate size of each limb bone are at work while the cartilage is being formed, because each future bone has a good cartilaginous model laid down before ossification begins. Calcification usually begins at one point in each bone, unless that bone be a compound one formed by the fusion of two or more elements which were distinct in lower vertebrate types, as is the case with the os innominatum.

It is interesting to notice that this centre of calcification, which will later on be the centre of ossification, is usually in the middle of the shaft of a long bone, or, when a cuboidal block of cartilage is dealt with, as in the case of the carpal and tarsal bones, in that place which is farthest away from the periphery, and which is likely to be least well nourished. There seems, too, to be a general tendency for larger masses of cartilage to begin calcifying before smaller ones. Contrasting these facts with the behaviour of tumours, which contain cartilage and which are liable to undergo a process of calcareous degeneration, the present writer is led to suspect that the calcification which precedes ossification in cartilage may be a degenerative change brought about by ill-nutrition. However this may be, there is little doubt that the calcification, once established, acts as an attraction for blood-vessels, which probably bring with them osteoblasts, and the subsequent ossification is a process which needs and receives a plentiful supply of nourishment. After a long bone has reached a certain size it very often has extra centres of ossification developed at its ends as well as at places where important muscles have raised lever-like knobs of cartilage on the model. These extra centres are called *epiphyses*, and it is convenient to distinguish three varieties of these: (a) *pressure epiphyses* at the joint ends of long bones; (b) *traction epiphyses*, where muscles pull; and (c) *atavistic epiphyses*, the mechanical causes of which are more remote, but which represent structures of greater import in the lower vertebrates. With regard to the pressure epiphyses, they form a cap which protects the *epiphysial line*, or plate of cartilage, by means of which the bone increases in length, but they are certainly not essential to the growth of a bone, because they often do not appear until the bone has been growing for a long time, while in birds they are not found at all. The traction epiphyses are, in the opinion of the writer, originally pieces of cartilage which have the same nature as sesamoid cartilages developed in the play of a tendon, where it presses against a neighbouring cartilaginous model of a bone, and which, instead of remaining separate structures throughout life, as is the case with the patella, fuse early with the model against which they are pulled, and so form a knob. For practical purposes the coracoid process of man may be regarded as an example of an atavistic epiphysis or perhaps of two atavistic epiphyses. (For further details on this subject see the writer's papers on epiphyses, *Jour. Anat. and Phys.* vol. xxxvii. p. 315; vol. xxxviii. p. 248; vol. xxxix. p. 402.)

Turning now to the development of the individual bones of the axial skeleton, the clavicle, as has been mentioned, is partly fibrous, and partly cartilaginous, but the exact proportions are still imperfectly

brates, while the human coracoid he looked upon as the equivalent of the epicoracoid. The epiphyses in the vertebral border are atavistic and represent the supra-scapular element (see section below on *Comparative Anatomy*).

In the humerus the centre for the shaft appears about the eighth week of foetal life, which is the usual time for primary centres. The head, trochlea and capitellum have pressure epiphyses, while those for the tuberosities and condyles are of the traction variety.

The ulna is a very interesting bone because there is no pressure epiphysis for its upper end. The upper epiphysis shown in fig. 21 does not encroach upon the articular surface, but is a pure traction epiphysis developed in the triceps tendon and serially homologous with the patella (a sesamoid bone) in the lower limb.

In the radius there are two terminal pressure epiphyses and one traction for the insertion of the biceps.

The carpus ossifies after birth, one centre for each bone occurring in the following order: os magnum, 11 to 12 months; unciform, 12

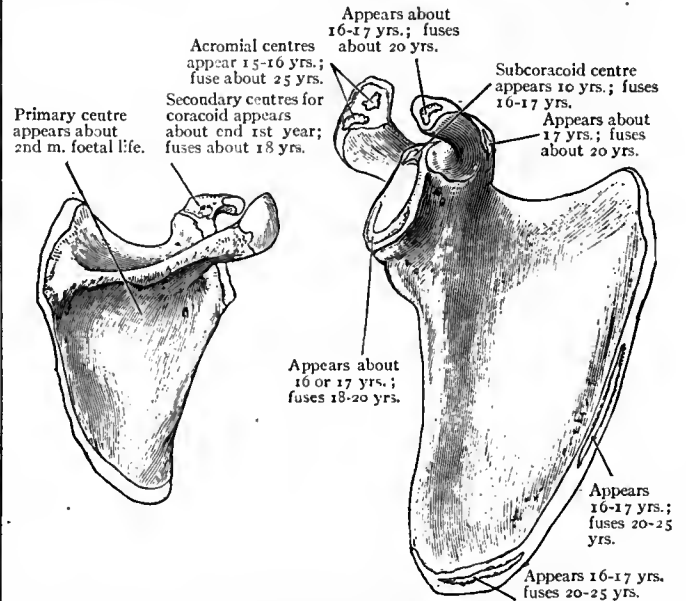

From Arthur Thomson, Cunningham's *Text-Book of Anatomy*. Scapula at end of First Year. Scapula about the Age of Puberty.

FIG. 19.—Ossification of the Scapula.

to 14 months; cuneiform, 3 years; semilunar, 5 to 6 years; trapezium, 6 years; scaphoid, 6 years; trapezoid, 6 to 7 years; pisiform, 10 to 12 years.

Up to the third month of foetal life a separate cartilage for the os centrale (see subsection on comparative anatomy) is found, but this later on fuses with the scaphoid. It will be noticed that, broadly speaking, the larger cartilaginous masses ossify before the smaller.

The metacarpal bones have one centre each for the shaft and one epiphysis for the head, except that for the thumb which has one centre for the shaft and one epiphysis for the proximal end.

The phalanges develop in the same way that the metacarpal bone of the thumb does.

The os innominatum has three primary centres for the ilium, ischium and pubis.

The special centres for the crest of the ilium are probably a serial repetition of those for the vertebral border of the scapula (see fig. 19); that for the anterior inferior spine is a purely human traction epiphysis connected with the use of the straight head of the rectus femoris in the upright position. The centre for the pubic symphysis probably represents the epipubis of amphibians, while that for the tuberosity of the ischium is the hypoischium of reptiles (see subsection on comparative anatomy). The most anterior of the epiphyses in the acetabulum is the os acetabuli of lower mammals, while the occasional one for the spine of the pubis is often looked on as the vestige of the marsupial bone of monotremes and marsupials. It will thus be seen that many of the secondary centres of the os innominatum are of the nature of atavistic epiphyses.

The femur has two pressure epiphyses, one for the head and another for the lower end, and two traction for the great and small trochanters.

The cartilaginous patella does not appear until the third month of foetal life, that is well after the quadriceps extensor cruris, in the tendon of which it is formed, is defined. Its ossification begins in the third year. The patella is usually looked upon as the largest and most typical example of a sesamoid bone in the body.

The tibia has a pressure epiphysis at either end, but that for the upper comes down in front so as to include a good deal of the tubercle. In almost any other mammal, and often in man himself, it may be

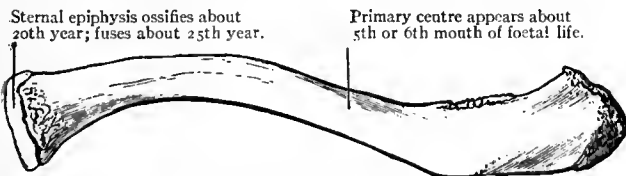

From Arthur Thomson, Cunningham's *Text-Book of Anatomy*. FIG. 18.—Ossification of the Clavicle.

known; its primary centre is the earliest of all in the body to appear, while its sternal epiphysis does not come till the bone is fully grown, and so can have no effect on the growth of the bone. It is probably one of the atavistic class, and is often regarded as the vestige of the precoracoid (see subsection on comparative anatomy), though it may represent the inter-clavicle, which, as has been pointed out in the article on the axial skeleton, is quite distinct from the episternum. It sometimes fails to appear at all.

The centres for the scapula are shown in the accompanying figures (fig. 19). G. B. Howes regarded the subcoracoid centre as the atavistic epiphysis representing the coracoid bone of lower verte-

¹ By mesenchyme is meant that part of the mesoderm, or middle layer of the embryo, in which the cells are irregularly scattered in a matrix, and are not arranged in definite rows or sheets as in the coelomic membrane.

seen that this down-growth is a traction epiphysis developed in the quadriceps tendon below the patella and joining the main upper epiphysis before uniting with the diaphysis or shaft.

The fibula has two pressure epiphyses, the lower of which appears

as a little bone at the back of the astragalus, known as the *os trigonum*.

The centre for the calcaneum appears in the sixth month of foetal life, that for the astragalus in the seventh, the cuboid about birth, the external, middle and internal cuneiforms in the first and second years, while the navicular is the last to appear in the third year. It will be noticed that, although ossification occurs in the bigger cartilaginous masses earliest, e.g. calcaneum astragalus and cuboid, the large navicular is the last cartilage to ossify, and this is an exception to the general rule which is probably caused by some factor which we do not at present understand.

The calcaneum has a very definite traction epiphysis developed in the insertion of the tendo Achillis behind.

The development of the metatarsal bones and phalanges of the foot is the same as that of the hand.

For further details and literature see J. P. M'Murrich's *Development of the Human Body* (London, 1906) and D. J. Cunningham's *Text-Book of Anatomy* (Edinburgh, 1906).

Comparative Anatomy.—It is only when the class of pisces is reached that paired appendages are found, and there are two main theories to account for their first occurrence. The one which is at present most favoured is that in some ancestral fishes two folds ran along the ventro-lateral part of the body, like the bilge keels of a boat, and that these joined one another in the mid-ventral line behind the cloacal orifice to form the median caudal fin. Into these folds the segments of the body including myotomes and myocommata, extended. Later on parts of these ridges were suppressed, but in the pectoral and pelvic regions they were retained to form the paired fins. This theory was first foreshadowed by Goodsir, and has been elaborated by Balfour, Dohrn and many others. It is supported by the fact that in some elasmobranch embryos the whole length of the folds can be traced.

The second theory is that the limbs are elaborated gills; this was proposed by C. Gegenbaur, and has lately been supported by Graham Kerr. It is probable that the limb girdles are of later evolution than the skeleton of the fins themselves.

In the elasmobranch fishes (sharks and rays) there is a crescentic

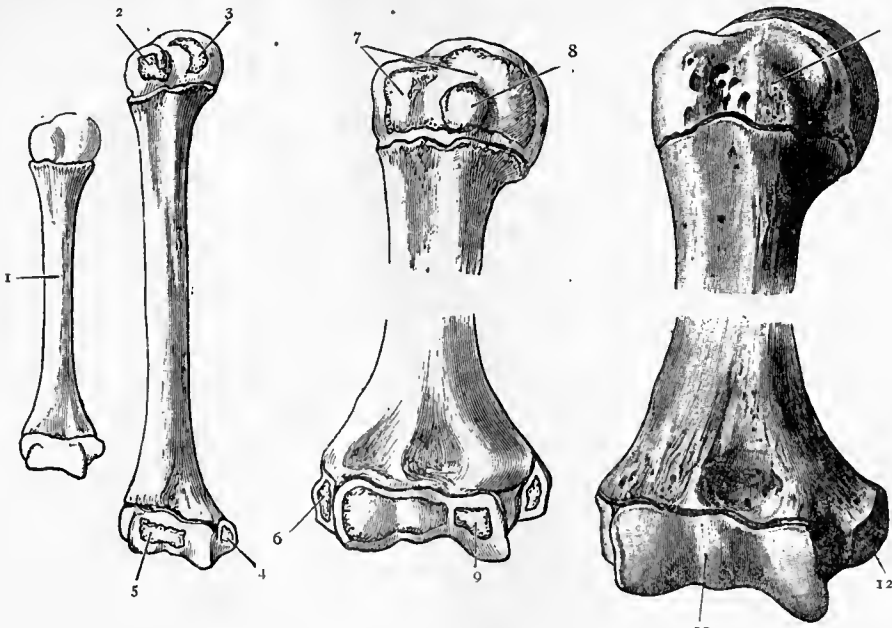

At birth. About 5 years. About 12 years.

From Arthur Thomson, Cunningham's *Text-Book of Anatomy*.

FIG. 20.—Ossification of the Humerus.

- 1 Appears early in 2nd month foetal life.
- 2 For tuberosity, appears 2 to 3 years.
- 3 For head, appears within first 6 months.
- 4 For internal condyle, appears about 5 years.
- 5 For capitellum, appears 2 to 3 years.
- 6 Appears about 12 years.
- 7 Centres for head and great tuberosity coalesce about 5 years.
- 8 Centre for small tuberosity fuses with other centres about 7 years.
- 9 Appears about 11 or 12 years.
- 10 Inferior epiphysis fuses with shaft about 16 to 17 years.
- 11 Superior epiphysis fuses with shaft about 25 years.
- 12 Fuses with shaft about 17 to 18 years.

first. The general rule with the long bones of the extremities is that the epiphysis nearest the elbow or farthest from the knee is the first to appear and the last to join. The writer accounts for the neglect of this rule in the case of the fibula by the fact that the lower cartilaginous end is larger than the upper (see fig. 26).

In the tarsus the cartilages are at an early stage arranged in three

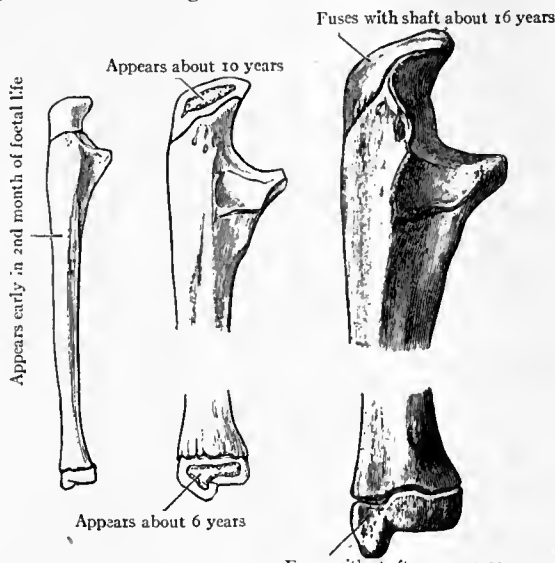

At birth. About 12 years. About 16 years.

From Arthur Thomson, Cunningham's *Text-Book of Anatomy*.

FIG. 21.—The Ossification of the Ulna.

rows in just the same way that those of the hand are, but in the proximal row the middle one (intermedium), corresponding to the semilunar in the hand, fuses with the one on the tibial side to form the astragalus, though sometimes a vestige of it seems to persist

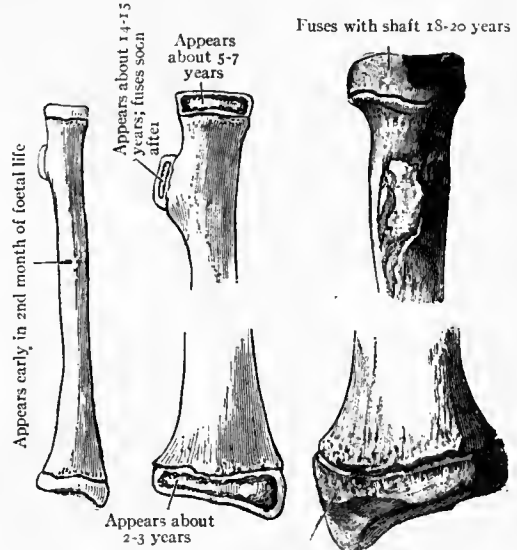

At birth. About 12 years. About 16 years.

From Arthur Thomson, Cunningham's *Text-Book of Anatomy*.

FIG. 22.—The Ossification of the Radius.

bar of cartilage (pectoral girdle), concave upward, which girdles the ventral and lateral parts of the body; it is divided into a dorsal part (scapula) and a ventral part (precoracoid and coracoid) by a

facet for the articulation of the fin. This of course is the glenoid cavity. In some forms, e.g. the shark *Heptanchus*, there is a perforation in the ventral part of the bar on each side, which possibly indicates the division between the precoracoid and coracoid elements.

In many of the bony fish (Teleostei) the outline is obscured by a

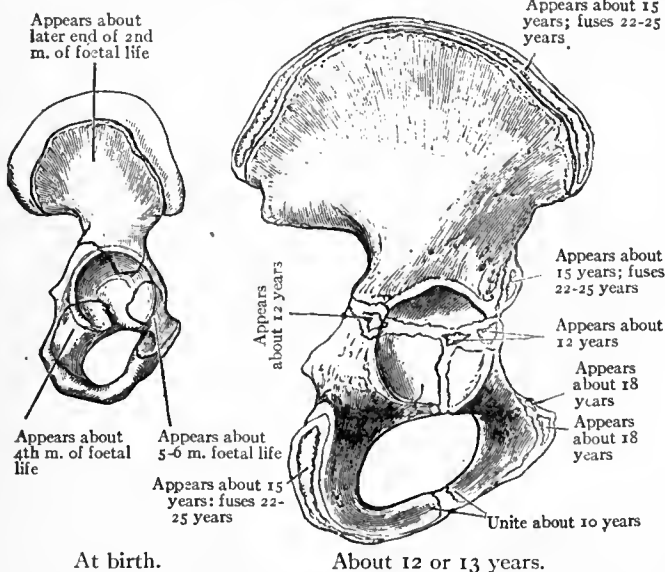

At birth. About 12 or 13 years.
From Arthur Thomson, Cunningham's *Text-Book of Anatomy*.
FIG. 23.—Ossification of the Innominate Bone.

series of bones which connect the girdle with the skull and may be the precursors of the clavicle.

In the Amphibia the dorsally-placed scapula (fig. 27, S) has more dorsally still a cartilaginous plate, the supra-scapula (fig. 27, S.S), which may be calcified. The precoracoid (fig. 27, P.C) and coracoid (C) are quite distinct, the former being in front (cephalad) and overlaid by a dermal bone, the clavicle (Cl). The attachment of the coracoids to the sternum has been noticed in section *Axial* of this article. Uniting the ventral ends of the precoracoid and coracoid is the epicoracoid on each side (fig. 27, E.C).

In the Reptilia the same general plan is evident, but in the lizards

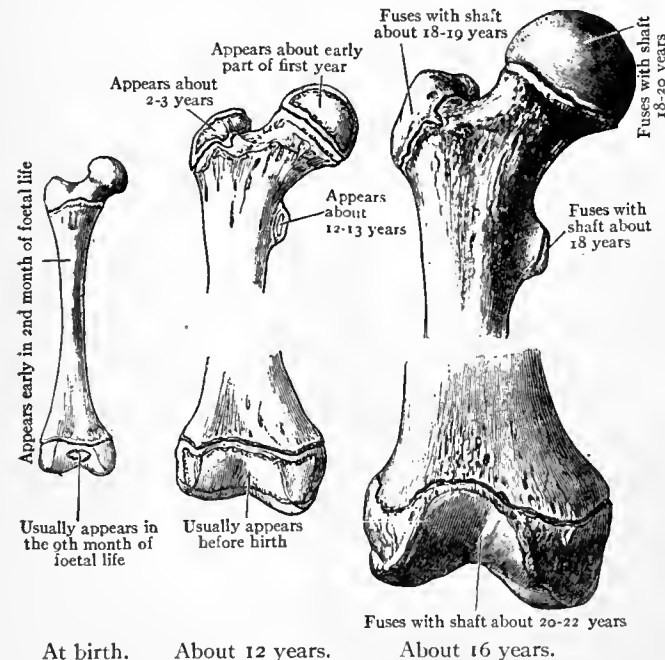

At birth. About 12 years. About 16 years.
From Arthur Thomson, Cunningham's *Text-Book of Anatomy*.
FIG. 24.—Ossification of Femur.

the ventral ends of the two clavicles are united by a median dagger-like dermal bone, the *interclavicle* (fig. 27, I.C), which lies on a plane superficial to the sternum and epicoracoids.

In birds the scapula has the shape of a sabre blade, and there is a rudimentary acromion process, though this is also indicated in some

reptiles. The pre- and epi-coracoids are aborted, but the coracoids are very strong. The clavicles and interclavicle unite into a V-shaped bar which forms the furcula or "merrythought."

In the Mammalia the Monotremata (*Ornithorhynchus* and *Echidna*) retain the reptilian arrangement of large coracoids and epicoracoids articulating with the sternum, while the clavicles and inter-

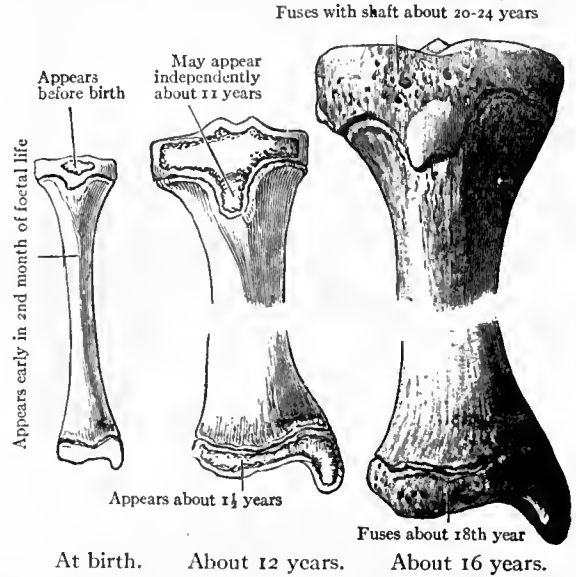

At birth. About 12 years. About 16 years.
From Arthur Thomson, Cunningham's *Text-Book of Anatomy*.
FIG. 25.—Ossification of the Tibia.

clavicle are also largely developed; the scapula too is more bird-like in shape than mammalian. In the higher mammals the scapula develops a spine and usually an acromial process, and has a triangular outline. As long as the forelimb is used for support, the vertebral border is the shortest of the three, and the long axis of the bone runs from this border to the glenoid cavity; but when the extremity is used for prehension, as in the Primates, or for flight, as in the Chiroptera, the vertebral border elongates and the distance from it to the glenoid cavity decreases so that the long axis is now parallel with that of the body instead of being transverse.

Above the monotremes too the coracoid becomes a mere knob for muscles, and no longer articulates with the sternum. There is thus a sudden transition from the way in which the forepart of the body is propped up on the forelimbs when the coracoid is functional (as in reptiles) to the way in which it is suspended like a suspension bridge between the two scapulae in pronograde mammals, the serratus magnus muscles forming the chains of the bridge (see fig. 28).

The clavicle is often entirely suppressed in mammals; this is the case in most of the Ursidae, all the Pinnipedia, *Manis* among edentates, the Cetacea, Sirenia, all Ungulata and some of the Rodentia. It is complete in all the Primates, Chiroptera, Insectivora (except *Potamogale*), many of the Rodentia, most Edentata, and all the Marsupialia except *Perameles*. In the Monotremata it is fused with a well-developed interclavicle, but in other mammals the interclavicle is either suppressed or possibly represented by the sternal epiphysis of the clavicle of the Primates. The precoracoid as a distinct structure entirely disappears, though vestiges of it may remain in the cartilaginous parts of the clavicle.

The chief modifications of the humerus are the development of the *pectoral ridge*, which is large whenever the pectoral muscles are strong, and is represented in man by the outer lip of the bicapital groove and the *supracondylar foramina*. In the tuatera lizard (*Sphenodon*)

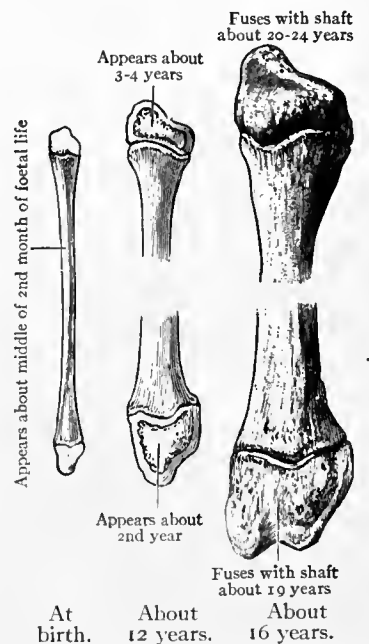

At birth. About 12 years. About 16 years.
From Arthur Thomson, Cunningham's *Text-Book of Anatomy*.
FIG. 26.—Ossification of Fibula.

there are two of these, one on the outer side for the musculo-spiral nerve, and one on the inner for the median nerve; in other living and fossil reptiles one or other of these may be present. The three bars bounding these two foramina in Sphenodon are sometimes regarded as indications that the humerus contains vestiges of three fin rays in its evolution from the fin of the fish. In the mammals the internal supracondylar (entepicondylar)

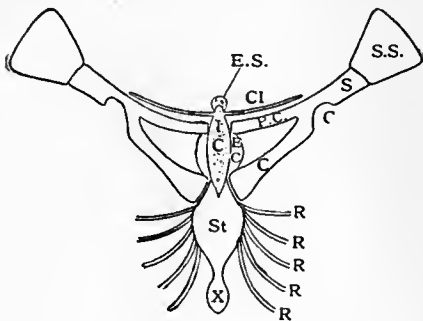

FIG. 27.—Diagrammatic Representation of a Generalized Form of Shoulder Girdle.

S Scapula. E.C Epicoracoid.
C Coracoid. St Sternum.
G Glenoid cavity. E.S Epi- or omosternum (dotted deep to interclavicle).
I.C Interclavicle. P.C Precoracoid.

foramen is most erratic in its appearance and disappearance, very few orders being without some family or genus which shows it. In some mammals, e.g. dog, a supra-trochlear foramen is present just above the trochlea; it transmits nothing. Epiphyses are found in this, as in other long bones, in amphibians, reptiles and mammals, but not in birds.

In the tailless amphibians (Anura) the radius and ulna are fused, while in the Urodela and reptiles they are always distinct. In some lizards (Iguana, Sphenodon, &c.) the olecranon epiphysis remains a distinct sesamoid bone just as the patella does,

and this is also the case in some bats. In the pronograde mammals the radius is in a position of permanent pronation, and is a much more important bone than the ulna, which is sometimes suppressed, so that little more than the olecranon process remains (e.g. horse, giraffe). In the lower Primates the ulna articulates directly with the cuneiform and (sometimes) pisiform bones, and is not shut off from the carpus by a meniscus as in man.

The carpus of the higher vertebrates may be reduced from a generalized type by the fusion or suppression of certain of its elements. A perfect generalized type is not known to exist in any vertebrate, though it is very closely approached by the primitive reptile Sphenodon. In such a type the bones are arranged in three rows; proximal, nearest the forearm, middle and distal. There are five bones in the proximal row, which bear the

The carpus.

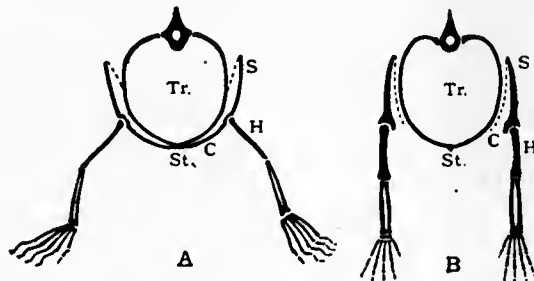

FIG. 28.—Diagrams representing the change of Mechanism in supporting the Thorax in the Reptilian (A) the Mammalian (B) types of Shoulder Girdle.

St Sternum. H Humerus. The dotted line represents the serratus magnus muscle.
C Coracoid. S Scapula.
Tr Section of trunk.

following names, beginning at the outer or radial side of the wrist: (1) *Radiale marginale* (fig. 29, R.M); (2) *Radiale* (R); (3) *Intermedium* (I); (4) *Ulnare* (U); (5) *Ulnare marginale* (U.M). In the middle row there are two: (1) *Centrale radiale* (C.R); (2) *Centrale ulnare* (C.U).¹ In the distal row there are again five bones, which are spoken of as the first, second, third, fourth and fifth *distalia*.

Sphenodon has all these bones except the radiale marginale. In many of the urodele amphibians, e.g. the salamander and newt (Molge), the carpus is very generalized, the only elements wanting being the radiale marginale, ulnare marginale, centrale ulnare and distale V. In the tailless forms (Anura), however, it is more specialized, although the radiale marginale is sometimes present and by some morphologists is spoken of as the *prepollex*. When only four distalia are present it is doubtful whether the fifth is suppressed, or whether it has fused with the fourth.

¹ In the giant salamander of Japan (Megalobatrachus) three centralia are sometimes found, so that possibly the generalized carpus should have three instead of two of these elements in the middle row.

In the Reptilia the carpus is often very generalized, as in Sphenodon and Chelydra (see fig. 30).

In the birds the radiale and ulnare are distinct, but the distal bones are fused with the metacarpus to form a *carpo-metacarpus*. In Mammalia various examples of fusion and suppression occur. All that space will here allow is to attempt to show how the human carpus is derived from the generalized type. In man the radiale, radiale marginale, and centrale radiale fuse to form the scaphoid; the semilunar is the intermedium; the cuneiform the ulnare; and the pisiform the ulnare marginale.

The trapezium and trapezoid are distalia I. and II.; the os magnum distale III. fused with the centrale ulnare; while distalia IV. and V. have either fused to form the unciform, or, as some believe, distale V. has been suppressed.

In some mammals the radiale marginale is very large, e.g. mole and elephant, and is regarded as a stage in the evolution of a digit on the radial side of the pollex, hence named the *prepollex*. In the Cape jumping hare (*Pedetes*) this digit is two-jointed and bears a rudimentary nail. Feebler indications of another digit on the ulnar side of the carpus, called the *post-minimus*, are sometimes seen in relation with the pisiform, which is therefore no longer regarded as a sesamoid bone, but, with the radiale marginale, as a stage in the progress from a pentadactylous to a heptadactylous manus. The centrale radiale

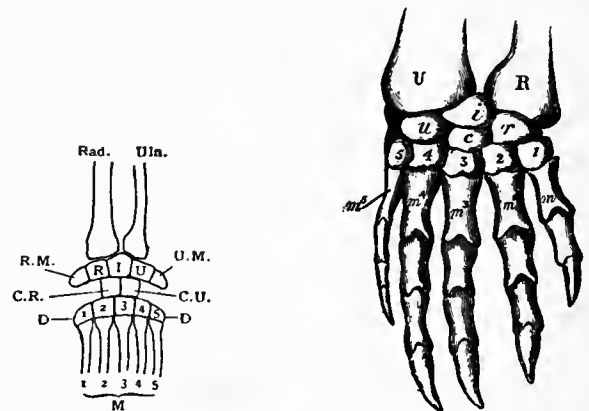

FIG. 29.—Diagram of a generalized carpus.

Rad. Radiale.
Uln. Ulna.
R.M Radiale marginale (prepollex).
R Radiale.
I Intermedium.
U Ulnare.
U.M Ulnare marginale.
C.R Centrale radiale.
C.U Centrale ulnare.
D Distalia.
M Metacarpalia.

FIG. 30.—Dorsal Surface of the Right Manus of a Water Tortoise (*Chelydra serpentina*). After Gegenbaur.

U Ulna.
R Radius.
u Ulnare.
i Intermedium.
r Radiale.
c Centrale.
1-5 The five bones of the distal row of the carpus.
m^{l-m} The five metacarpals.

persists as a distinct bone throughout life in many monkeys, as also does the radiale marginale.

In the suppression of digits in vertebrates a regular sequence occurs; the pollex is the first to go, then the minimus, index and annularis one after another, so that an animal like the horse, which has only one digit, has lost all except the medius.

In the mammals the number of the phalanges usually corresponds with that of man, though in the lower vertebrates they are often much more numerous.

When the extremity is modified to form a paddle, as in Ichthyosaurus and the Cetacea, the phalanges are often greatly increased in number.

In the elasmobranch fishes the pelvic girdle is a repetition of the pectoral though it is not quite so well marked. The acetabulum corresponds to the glenoid cavity, and the part of the girdle dorsal to this is the ilium; the ventral part, uniting with its fellow in the mid-line, is the ischio-pubis, the two elements of which are sometimes separated by a small foramen for the passage of a nerve. When this is the case the anterior (cephalic) part is the pubis, and is in series with the precoracoid, while the ischium (caudad) repeats the coracoid.

Pelvic girdle.

In Amphibia the connexion between the ilium and sacrum becomes established, and some of the extinct Labyrinthodontia have separate pubic and ischial symphyses, though in existing forms the ischium and pubis are generally fused.

In the Urodela there is usually a bifid cartilage just in front (cephalad) of the pubes, in the mid-line, which is called the *epipubis* (see subsection on embryology).

In the Reptilia the ilium always projects backward towards the

tail; the ischia usually meet in a ventral ischial symphysis, from which a cartilage or bone projects backward to support the anterior lip of the cloacal orifice; this is the *hypoischium*, a structure which is traceable throughout the Vertebrata to man (see fig. 31).

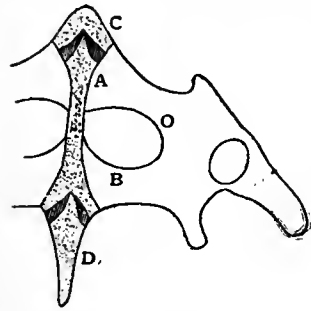

FIG. 31.—Pelvis of *Sphenodon* Lizard.

- A Pubic symphysis.
B Ischial symphysis.
C Epipubis.
D Hypoischium.

(The dotted part is cartilaginous, the white and darkly shaded parts bony.)

though sometimes it is only pubic as in man. In *Echidna* among the monotremes the acetabulum is perforate as in birds. In the monotremes and marsupials part of the external oblique muscle is ossified to form the *marsupial bones*; these are sometimes regarded as part of the epipubis, though it is more probable that they are merely adaptive strengthenings of the external oblique to support the traction of the pouch. A *cotyloid bone* (*os acetabuli*) is usually present, at all events in early life, and it often shuts out the pubis from taking any part in the formation of the acetabulum.

The femur is comparatively a very stable bone. Sometimes, especially in the odd-toed ungulates (*Perissodactyla*), the gluteal ridge forms a large third trochanter, while in most mammals, though not in ungulates, there are two sesamoid bones, called *fabellae*, developed in the gastrocnemius just above the condyles.

The patella first appears in the reptiles, though it is not present in all of them. Most of the *Lacertilia* show it as a small sesamoid structure in the quadriceps extensor tendon. It is present in all birds and mammals, with the exception of some bats. In most marsupials it remains cartilaginous throughout life.

The tibia and fibula fuse in the *Anura* and also in some mammals (e.g. rodents). The fibula is often nearly or quite suppressed in birds and mammals, while in birds the tibia fuses with the proximal row of tarsal bones, so that the ankle joint is obliterated and a tibio-tarsus formed. In the marsupials the upper end of the fibula is large and may articulate with the femur in certain positions of the knee, but, as a whole, it reaches its maximum development in the *Carnivora* in the aquatic suborder of which (*Pinnipedia*) it is as large as the tibia. It is curious that the only epiphysis which occurs in the long bones of birds is in the head of the tibia of the *Gallinae*.

In the tarsus the bones are arranged on the same generalized plan as in the carpus; the proximal row consists of *tibiale marginale*, *tibiale*, *intermedium*, *fibulare* and *fibulare marginale*; the middle row as far as we know only contains one *centrale*, while the distal row has five *distalia*.

It is more difficult to trace the fate of these structures in existing vertebrates than it is with the carpal bones. In man the astragalus probably contains the *tibiale*, *tibiale marginale* and *intermedium*, the latter structure possibly accounting for the occasional *os trigonum*, already mentioned in the subsection on embryology. The *fibulare* and *fibulare marginale* probably form the calcaneum, though it is unlikely that the epiphysis at the back of that bone represents any integral part of a generalized tarsus. The *centrale* persists as the navicular, while the three cuneiform represent tarsalia I., II. and III. and the cuboid tarsalia IV. and V., unless V. is suppressed as some believe. Vestiges of a *prehallux* are found in the Cape jumping hare and other rodents, though they are usually more closely connected with the navicular and internal cuneiform than with the bones of the proximal row. The large size of the hallux in man is an adaptation to the erect position.

Most of the remarks already made about the metacarpals and phalanges of the hand apply equally to the foot, though there is a greater tendency to reduction of digits in the hind limb than in the fore.

For further details and literature see S. H. Reynolds, *The Vertebrate Skeleton* (Cambridge, 1897); W. Flower and H. Gadow, *Osteology of the Mammalia* (London, 1885); R. Wiedersheim, *Comparative Anatomy of Vertebrates*, adapted by W. N. Parker, (London 1907); C. Gegenbaur, *Vergleich Anat. der Wirbeltiere* (Bd. i.) (Leipzig, 1901).

The hypoischium and epipubis are parts of a cartilaginous pelvic sternum, the former representing are xiphisternum and the latter the episternum of the shoulder girdle (see F. G. Parsons, "Epiphyses of the Pelvis," *J. Anat. and Phys.* vol. xxxvii. p. 315). The pubis may or may not form a symphysis; occasionally it is double and then a pre- and post-pubis are recognized.

In birds the ilium extends forward and backward, and is fused with the vertebral column, as has been noticed in section *Axial* of this article. The ischia and pubes do not form a symphysis except in the struthious birds (ostrich and rhea). The acetabulum is always perforate.

In mammals the ilium projects forward toward the head, and an ischio-pubic symphysis is common, though sometimes it is only pubic as in man. In *Echidna* among the monotremes the acetabulum is perforate as in birds. In the monotremes and marsupials part of the external oblique muscle is ossified to form the *marsupial bones*; these are sometimes regarded as part of the epipubis, though it is more probable that they are merely adaptive strengthenings of the external oblique to support the traction of the pouch. A *cotyloid bone* (*os acetabuli*) is usually present, at all events in early life, and it often shuts out the pubis from taking any part in the formation of the acetabulum.

The femur is comparatively a very stable bone. Sometimes, especially in the odd-toed ungulates (*Perissodactyla*), the gluteal ridge forms a large third trochanter, while in most mammals, though not in ungulates, there are two sesamoid bones, called *fabellae*, developed in the gastrocnemius just above the condyles.

The patella first appears in the reptiles, though it is not present in all of them. Most of the *Lacertilia* show it as a small sesamoid structure in the quadriceps extensor tendon. It is present in all birds and mammals, with the exception of some bats. In most marsupials it remains cartilaginous throughout life.

The tibia and fibula fuse in the *Anura* and also in some mammals (e.g. rodents). The fibula is often nearly or quite suppressed in birds and mammals, while in birds the tibia fuses with the proximal row of tarsal bones, so that the ankle joint is obliterated and a tibio-tarsus formed. In the marsupials the upper end of the fibula is large and may articulate with the femur in certain positions of the knee, but, as a whole, it reaches its maximum development in the *Carnivora* in the aquatic suborder of which (*Pinnipedia*) it is as large as the tibia. It is curious that the only epiphysis which occurs in the long bones of birds is in the head of the tibia of the *Gallinae*.

In the tarsus the bones are arranged on the same generalized plan as in the carpus; the proximal row consists of *tibiale marginale*, *tibiale*, *intermedium*, *fibulare* and *fibulare marginale*; the middle row as far as we know only contains one *centrale*, while the distal row has five *distalia*.

It is more difficult to trace the fate of these structures in existing vertebrates than it is with the carpal bones. In man the astragalus probably contains the *tibiale*, *tibiale marginale* and *intermedium*, the latter structure possibly accounting for the occasional *os trigonum*, already mentioned in the subsection on embryology. The *fibulare* and *fibulare marginale* probably form the calcaneum, though it is unlikely that the epiphysis at the back of that bone represents any integral part of a generalized tarsus. The *centrale* persists as the navicular, while the three cuneiform represent tarsalia I., II. and III. and the cuboid tarsalia IV. and V., unless V. is suppressed as some believe. Vestiges of a *prehallux* are found in the Cape jumping hare and other rodents, though they are usually more closely connected with the navicular and internal cuneiform than with the bones of the proximal row. The large size of the hallux in man is an adaptation to the erect position.

Most of the remarks already made about the metacarpals and phalanges of the hand apply equally to the foot, though there is a greater tendency to reduction of digits in the hind limb than in the fore.

For further details and literature see S. H. Reynolds, *The Vertebrate Skeleton* (Cambridge, 1897); W. Flower and H. Gadow, *Osteology of the Mammalia* (London, 1885); R. Wiedersheim, *Comparative Anatomy of Vertebrates*, adapted by W. N. Parker, (London 1907); C. Gegenbaur, *Vergleich Anat. der Wirbeltiere* (Bd. i.) (Leipzig, 1901).

Visceral.

In the lower vertebrates as well as in the embryo of man, a number of cartilaginous or bony arches encircle the mouth and pharynx (anterior part of the food tube), just as hoops encircle a barrel. There is little doubt that, when they first appeared in the history of evolution, all these bars supported gills and bounded gill slits, but in all existing types the first arch has been modified to surround the mouth and to act as both upper and lower jaws, gaining in different animals a more or less complete connexion with the cranium or brain-containing part of the skull. The first of these visceral arches, therefore, is known as the oral or jaw arch and, as has been shown, the muscles in connexion with it are supplied by the fifth nerve (see *MUSCULAR SYSTEM*; and *NERVE: Cranial*). The second visceral arch is the hyoid and is accompanied by the seventh or facial nerve. The third visceral or first branchial arch of most writers has the ninth or glosso-pharyngeal for its nerve supply, while the arches behind this are supplied by the vagus or tenth nerve.

It will be seen, on reading the subsections devoted to embryology and comparative anatomy, that in man the maxilla, palate, internal pterygoid plate, malar and tympanic bones as well as the ear ossicles, mandible, hyoid bone and thyroid cartilage are developed in connexion with this visceral skeleton. Of these the ear ossicles are described in the article *EAR*, the thyroid cartilage in that on the *RESPIRATORY SYSTEM*, while the other bones, with the exception of the hyoid, are treated under the head of *SKULL*. It therefore only remains to describe here the hyoid bone of man.

The *hyoid bone*, so called from its likeness to the Greek letter ν , lies in the upper part of the neck in close connexion with the root of the tongue and just above the thyroid cartilage of the larynx. It consists of a body across the mid-ventral line and a great and small cornu on each side (see fig. 1).

The *body* (*basihyal*) is rectangular with its long axis placed horizontally; behind it is markedly concave both from above down-

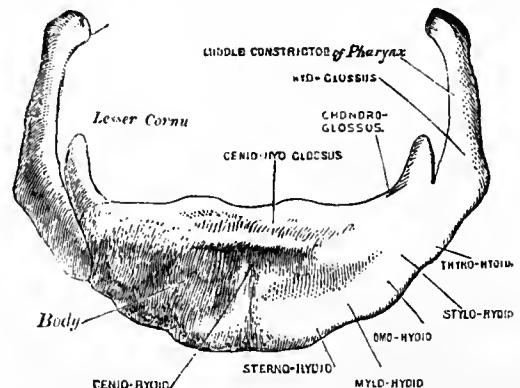

From Gray's *Anatomy, Descriptive and Surgical*.

FIG. 32.—Hyoid Bone, anterior surface (enlarged).

ward and from side to side. In front it attaches several muscles, but behind it is smooth and is separated from the thyrohyoid membrane by a bursa. From its upper border this membrane runs downward to the thyroid cartilage. The *great cornua* (*thyrohyals*) are attached to each side of the body by cartilage until middle life and afterwards by bony union. They curve upward and backward round the side of the pharynx and are laterally compressed. To their inner surfaces the thyrohyoid membrane is attached, while their knob-like ends are connected with the superior cornua of the thyroid cartilage by the lateral thyrohyoid ligaments.

The *small cornua* (*ceratohyals*) are conical structures about a quarter of an inch long attached to the upper part of the body at its junction with the great cornua. It is only in late life that they become united with the body by bony union, if they ever do so. At their apices they are connected with the tips of the styloid processes by the long stylohyoid ligaments (epihyals).

Embryology.—In the early embryo (see *MOUTH* and *SALIVARY GLANDS*) the mandibular processes grow forward on each side of the slit-like stomatodaeum or primitive mouth, and at length join one another in the mid-ventral line. From the proximal part of each of these another process, the maxillary, grows forward (ventrad), only more slowly, to blend with the fronto-nasal process. In each of these processes cartilage is formed in the lower vertebrates, which in the case of the mandible (lower jaw) reaches to the mid-ventral line and

forms what is known as Meckel's cartilage; but in the maxillary process the stage of chondrification is suppressed in man and other mammals, and the palato-quadrangle cartilaginous bar which is so evident in embryo fishes and amphibians is not formed. It will thus be seen that both the maxillary and mandibular bars are derivatives of the first visceral arch. In the maxillary process a membrane bone is formed which blends with the sphenoid to form the internal pterygoid plate, while in front (ventrad) of this the upper jaw (maxilla) is developed in membrane by several centres. Of these, according to the usual description, (1) forms the body of the bone on the outer side of the infraorbital canal; (2) forms the body of the bone on the inner side of that canal; (3) forms the nasal process and the socket for the canine tooth; (4) makes the posterior three-quarters of the palatine process; while (5) and (6) form the premaxilla, each of the latter contributing a socket for one of the two incisor teeth. When these premaxillary sutures fail to unite, the deformity known as "cleft palate" is produced and this may occur either between the lateral incisor and the canine or between the central and lateral incisor teeth. The recent researches of Professor E. Fawcett point to the conclusion that these centres are not really as numerous as is generally thought. He regards (1) and (2) as a single centre which grows up round the infraorbital canal, while the premaxilla he finds need not necessarily have two centres. The maxillary antrum is first developed as an outgrowth from the cartilaginous olfactory capsule into the membranous maxilla, though the cartilage soon disappears. The palate bone is developed by one centre which is formed in what will be the vertical plate of that bone in the membrane, behind the centre or centres for the body of the maxilla and at a little later date (see E. Fawcett, *Journ. Anat. and Phys.* vol. 40, p. 400).

The mandibular or Meckel's cartilage is continued up into the tympanum where it joins the proximal end of the cartilage of the second or hyoid arch, and it is from this junction (hyomandibular plate) that, according to H. Gadow, *Anat. Anzeiger*, Bd. 19, p. 396, the malleus and incus bones of the middle ear are developed (see EAR). Between the slender process of the malleus and the region of the inferior dental foramen, the cartilage later on disappears and its fibrous sheath forms the long internal lateral or sphenomandibular ligament (see fig. 33, L.I.L.).

Hitherto each half of the lower jaw has been considered to be composed of several distinct skeletal elements, homologous with the elements found in the jaws of lower vertebrates. This view is still held by Professor K. von Bardeleben, who contends that there are present in the lower jaws of man and mammals six separate elements, the os mentale, coronoid, condyloid, angular, marginal and dentary. The researches of B. Henneberg, Professor E. Fawcett and of Dr A. Lowe, however, are so complete and correspond so closely that one cannot help believing that the human lower jaw, at all events, is ossified from one centre only on each side, which appears in membrane near the symphysis and extends into a small part of Meckel's cartilage near the incisor tooth germs. From this centre, which represents the dentary of lower vertebrates, the whole adult bony jaw is formed and the greater part of Meckel's cartilage disappears by a process of resorption. But, although this bone is mainly membranous, patches of cartilage appear in the coronoid and condylar processes as well as near the symphysis and perhaps at the angle. These, however, do not ossify by separate centres, but are invaded by the main dentary ossification already described. It seems evident, therefore, that in man the process of ossification is slurred over although some of the original elements of the lower vertebrates are repeated as temporary cartilaginous masses, e.g. coronary, condylar and angular. (See E. Fawcett, "Thesis for the Degree of Doctor of Medicine," University Library, Edinburgh, 1906; also A. Lowe, "Development of Lower Jaw in Man," *Proc. Anal. Soc. of the University of Aberdeen*, 1905, p. 59. In the latter paper the literature is reviewed.)

At birth the two halves of the mandible are separate as they are throughout life in many mammals (e.g. rodents), but in man they join together about the end of the first year.

It has been stated that within the tympanum the dorsal or proximal ends of the first and second visceral arches unite to form the hyomandibular plate from which, following H. Gadow, the malleus and incus are derived. The stapes is also probably formed from the proximal end of the second or hyoid arch (see fig. 33, St), and just ventral to this the cartilage of the arch fuses with that of the periotic capsule, where it is later on ossified as the tympanohyal element of the temporal bone (fig. 33, T.H.). From this point the cartilage becomes free from the skull and runs round the pharynx until it meets its fellow of the opposite side in the mid-ventral line. That part of the cartilage which is nearest the skull remains as the stylohyoid element (fig. 33, S.H.) and this later on ossifies to form the styloid process which fuses with the tympanohyal between twenty and twenty-five. For some distance beyond the stylohyoid element the cartilage degenerates into fibrous tissue forming the stylohyoid ligament; this represents the epiphyal element, and occasionally instead of degenerating it ossifies to form an abnormal bone (fig. 33, E.H.). Near the middle line the cartilage persists as the ceratohyal element or lesser cornu of the hyoid bone (fig. 33, C.H.), while the most ventral part, where it fuses with its fellow of the opposite side as well as with the ventral part of the third arch, is the basihyal or body of the hyoid bone (fig. 33, B.H.).

The dorsal part of the cartilage of the third arch is wanting, but its lateral part forms the thyrohyal or great cornu of the hyoid bone (fig. 33, Th.H.), while its ventral part fuses with its fellow of the opposite side as well as with the ventral part of the second arch to form the body of the hyoid bone. The fourth and fifth arches only develop cartilage in their ventro-lateral parts and fuse to form the thyroid cartilage of the larynx (fig. 33, Th.C) (see RESPIRATORY SYSTEM).

For further details see J. P. McMurrich, *Development of the Human Body* (1906); A. Keith, *Human Embryology and Morphology* (1905); H. Gadow, "Modifications of the first and second Visceral Arches," *Phil. Trans.* vol. 179 (1888), and "The Evolution of the Auditory Ossicles," *Anat. Anzeiger*, Bd. xix. (1901).

Comparative Anatomy.—In the Amphioxus the pharynx is stiffened by chitinous bars which lie between the gill slits, but it is unlikely that

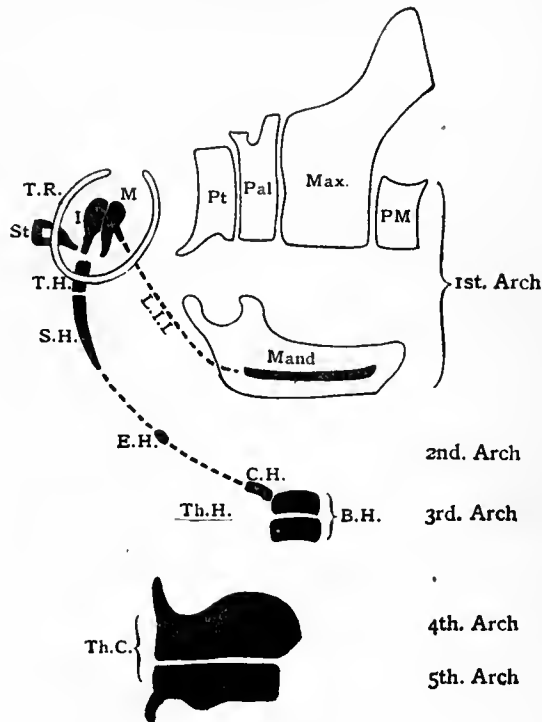

FIG. 33.—Diagram to show the fate of the Visceral Arches in man and (with modifications) other mammals. Membrane bones white. Cartilage and cartilage bones black. Cartilage which has degenerated into ligaments dotted.

P.M	Premaxilla.	St	Stapes.
Max.	Maxilla.	T.H	Tympanohyal.
Pal.	Palate.	S.H	Stylohyoid (styloid process).
Pt	Pterygoid (internal pterygoid plate).	E.H	Occasional epiphyal cartilage or bone in stylohyoid ligament.
T.R	Tympanic ring (quadrate?).	C.H	Ceratohyal (lesser cornu of hyoid bone).
Mand.	Mandible surrounding Meckel's cartilage (black).	B.H	Basihyal (body of hyoid bone).
L.I.L	Long internal lateral ligament.	Th.H	Thyrohyal (great cornu of hyoid bone).
M	Malleus.	Th.C	Thyroid cartilage of larynx.
I	Incus.		

these are really homologous with the visceral skeleton of higher forms, though, in serving the same purpose, they are certainly analogous.

Among the Cyclostomata (hags and lampreys) there is an arrangement known as the "branchial basket," which has a more superficial position than the visceral arches of fish and probably corresponds to the extra-branchials of those vertebrates. The oral and hyoid arches are very rudimentary and probably have degenerated in consequence of the suctorial mode of nourishment. In the Elasmobranchii (sharks and rays) the visceral skeleton is entirely cartilaginous. In the more primitive types such as the comb-toothed shark (Notidanus) the oral and hyoid arches are quite distinct. The oral arch consists of the upper jaw, or palato-quadrangle cartilage, and the lower jaw, or Meckel's cartilage; these articulate with one another posteriorly and also with the skull. Behind these and distinct from them is the hyoid arch. Such a type of suspensorium or jaw articulation is called autostylic. In the rays, on the other hand, the oral arch is connected with the skull by the proximal segment of the hyoid arch, which, since it connects both the hyoid and mandibular (oral) arches with the skull, is called the hyomandibular cartilage. This type of suspensorium is termed hyostylic.

Below the hyomandibular cartilage the hyoid arch has two other

segments, the *ceratohyal* laterally and the *basihyal* ventrally where it fuses with its fellow of the opposite side. Sometimes an *epihyal* intervenes between the hyomandibular and the ceratohyal. Behind the hyoid arch are usually five branchial arches, though in Heptanchus there are as many as seven. These are divided into a number of segments, and outside these there is often another series of arches called *extra-branchials* which are probably homologous with the branchial basket of the Cyclostomata.

The chimaeroid fishes are called Holocephali because in them the palato-quadrate bar is fused with the rest of the skull. In the bony ganoids and teleosteans (Teleostomi) the palato-quadrate bar ossifies to form the palatine, ecto-, meso- and meta-pterygoids and quadrate bones from before backward, while outside these is another row of dermal bones formed by the *premaxilla*, *maxilla* and *jugal* or *malar*.

In the lower jaw, Meckel's cartilage is ossified at its proximal end to form the *articular bone*, but distally it remains and is partly encased by the *dentary*, and more posteriorly by the *angular*, both of

In the Reptilia the site of the palato-quadrate bar is surrounded by the same series of bones that are found in the Amphibia, but in lizards and chelonians a *para-quadrate* bone is found which, according to E. Gaupp, is the precursor of the tympanic ring of mammals. In the crocodiles the maxilla and palate grow inwards to meet one another and so form a hard palate. The mandible has *dentary*, *sphenial*, *angular*, *surangular*, *articular* and *coronoid* ossifications and in some cases a *mento-meckellian* as well. The quadrate bone with which it still articulates is becoming included in the wall of the tympanic cavity, and, according to H. Gadow, it is this bone and not the para-quadrate which will become the tympanic of mammals. The hyoid arch is sometimes suppressed in snakes, but in Sphenodon its continuity with the *columella* or *stapes* can be demonstrated.

The branchial skeleton is reduced with the cessation of branchial respiration and only the ventral parts of two arches can be seen; these unite to form a plate with the hyoid (*basihyobranchial*) and with this the glottis is closely connected. In birds the morphology of the visceral skeleton is on the reptilian plan, and, although the modifications are numerous, they are not of special interest in elucidating the problems of human morphology.

In the Mammalia the *premaxilla*, *maxilla*, *palate* and *pterygoid* bones can be seen in connexion with the region where the palato-quadrate cartilage lay in the lower Vertebrata (see fig. 34). The *premaxilla* bears the incisor teeth, and except in man the suture between it and the maxilla is evident on the face if a young enough animal be looked at. The *maxilla* bears the rest of the teeth and articulates laterally with the *jugal* or *malar*, which in its turn articulates posteriorly with the zygomatic process of the squamosal, so that a zygomatic arch, peculiar to mammals, is formed. Both the maxilla and palate form the hard palate as in crocodiles, though the pterygoid bone does not do so but fuses with the sphenoid to form the internal pterygoid plate (see fig. 34, Pt). The *mandible* no longer articulates with the *quadrate* but forms a new articulation, by means of the condyle, with the *glenoid cavity of the squamosal*, and many modern morphologists, including the writer, are inclined to agree with H. Gadow that the quadrate has probably become the *tympanic bone*. In many mammals (e.g. Carnivora) this bone swells out to form the *bulla tympani*. The derivation of the auditory ossicles has been discussed in the section on embryology as well as in the article EAR. The presence of a chain of ossicles is peculiar to the Mammalia.

In many of the lower mammals (e.g. Ungulata and Carnivora) the hyoid arch is much more completely ossified than it is in man, *tympano-*, *stylo-*, *epi-*, *cerato-* and *basihyal* elements all being bony (see fig. 34). It is of interest to notice that in the hares and rabbits the body of the hyoid has occasionally been found in two pieces, indicating its derivation from the second and third visceral arches. The fourth and fifth arches, which form the thyroid cartilage in mammals, are considered in the article RESPIRATORY SYSTEM.

For further details see S. H. Reynolds, *The Vertebrate Skeleton* (Cambridge, 1897); W. Flower, *Osteology of the Mammalia* (London, 1885); R. Wiedersheim, *Comparative Anatomy of Vertebrates*, adapted and translated by W. N. Parker (London, 1907); C. Gegenbaur, *Vergleich. Anat. der Wirbeltiere*, Bd. i. (Leipzig, 1901). (F. G. P.)

SKELTON, JOHN (c. 1460-1529), English poet, is variously asserted to have belonged to a Cumberland family and to have been a native of Diss in Norfolk. He is said to have been educated at Oxford. He certainly studied at Cambridge, and he is probably the "one Scheklton" mentioned by William Cole (MS. *Athen. Cantabr.*) as taking his M.A. degree in 1484. In 1490 Caxton writes of him, in the preface to *The Boke of Eneydos*

compyled by Vyrgyle, in terms which prove that he had already won a reputation as a scholar. "But I pray mayster John Skelton," he says, "late created poete laureate in the unyversite of Oxenforde, to oversee and correct this sayd booke . . . for him I know for suffycient to expowne and englysshe every dyffcult that is therin. For he hath late translated the epystlys of Tulle, and the boke of dyodorus siculus,¹ and diverse other works . . . in polysshed and ornate termes craftely . . . I suppose he hath drunken of Elycons well." The laureateship referred to was a degree in rhetoric. Skelton received in 1493 the same honour at Cambridge, and also, it is said, at Louvain. He found a patron in the pious and learned countess of Richmond, Henry VII.'s mother, for whom he wrote *Of Mannes Lyfe the Peregrynacioun*, a translation, now lost, of Guillaume de Deguillville's *Pelerinage de la vie humaine*. An elegy "Of the death of the noble prince Kyng Edwarde the forth," included in some of the editions of the *Mirror for Magistrales*, and another (1489)

¹ The MS. of this translation is preserved at Corpus Christi College, Cambridge.

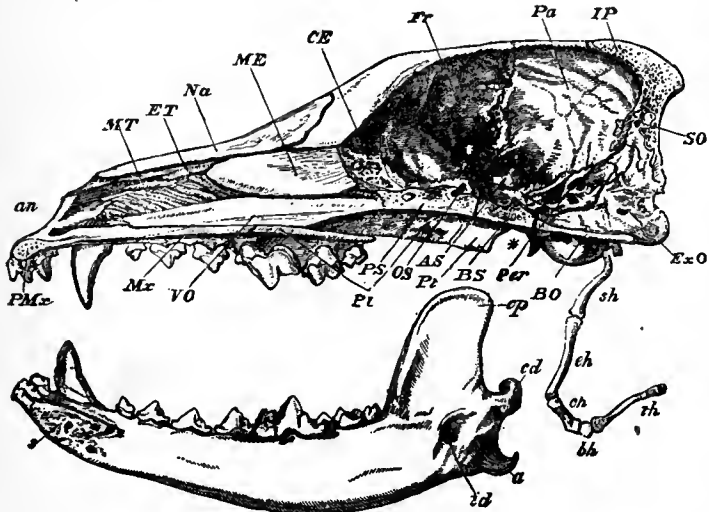

FIG. 34.—Longitudinal and Vertical Section of the Skull of a Dog (*Canis familiaris*), with mandible and hyoid arch.

an	Anterior narial aperture.	PS	Presphenoid.
MT	Maxillo-turbinal bone.	Pl	Palatine.
ET	Ethmo-turbinal.	Vo	Vomer.
Na	Nasal.	Mx	Maxilla.
ME	Ossified portion of the meso-ethmoid.	PMx	Premaxilla.
CE	Cribriform plate of the ethmo-turbinal.	sh	Stylo-hyal.
Fr	Frontal.	eh	Epi-hyal.
Pa	Parietal.	ch	Cerato-hyal.
IP	Interparietal.	bh	Basihyal.
SO	Supra-occipital.	th	Thyro-hyal.
ExO	Ex-occipital.	s	Symphysis of mandible.
BO	Basi-occipital.	cp	Coronoid process.
Per	Periotic.	cd	Condyle.
BS	Basi-sphenoid.	a	Angle.
Pt	Pterygoid.	id	Inferior dental canal.
AS	Alisphenoid.		
OS	Orbito-sphenoid.		

which are membrane bones. The jaw joint therefore is between the quadrate and the articular. In comparing this description with the section on human embryology it will be seen that certain bones, like the palate and pterygoids, which in the fish are ossifications in cartilage, become in the higher vertebrates membrane bones, and so it is clear that too great stress must not be laid on the histological history of a bone in determining its morphological significance.

The branchial arches of the Teleostomi closely resemble those of the Elasmobranchii except that they are ossified and that the extra-branchials have disappeared.

In the Dipnoi (mudfish) the suspensorium is autostylic, and either five or six branchial arches are present. In the Amphibia, too, the suspensorium is autostylic, the palato-quadrate bar remains largely cartilaginous, though its posterior part is often ossified to form the quadrate. The membranous *premaxilla*, *maxilla*, *palatine*, *pterygoid*, *quadratejugal* and *squamosal* bones are developed in connexion with it, though it is interesting to notice that the pterygoid is sometimes partly cartilaginous and the quadrate-jugal is absent in the tailed forms (Urodela). In the lower jaw a *sphenial* element has appeared, and in the frog a cartilaginous *mento-meckellian* bone develops close to the symphysis. In the larval stages there are rudiments of four branchial arches behind the hyoid, but in the adult these are reduced in the Anura and their ventral ends are united into a broad basilingual plate.

on the death of Henry Percy, fourth earl of Northumberland, are among his earliest poems. In the last decade of the century he was appointed tutor to Prince Henry (afterwards Henry VIII.). He wrote for his pupil a lost *Speculum principis*, and Erasmus, in dedicating an ode to the prince in 1500, speaks of Skelton as "unum Britannicarum literarum lumen ac decus." In 1498 he was successively ordained sub-deacon, deacon and priest. He seems to have been imprisoned in 1502, but no reason is known for his disgrace. Two years later he retired from regular attendance at court to become rector of Diss, a benefice which he retained nominally till his death. Skelton frequently signed himself "regius orator" and poet-laureate, but there is no record of any emoluments paid in connexion with these dignities, although the Abbé du Resnel, author of *Recherches sur les poètes couronnés*, asserts that he had seen a patent (1513-1514) in which Skelton was appointed poet-laureate to Henry VIII. As rector of Diss he caused great scandal among his parishioners, who thought him, says Anthony à Wood, more fit for the stage than for the pew or the pulpit. He was secretly married to a woman who lived in his house, and he had earned the hatred of the Dominican monks by his fierce satire. Consequently he came under the formal censure of Richard Nix, the bishop of the diocese, and appears to have been temporarily suspended. After his death a collection of farcical tales, no doubt chiefly, if not entirely, apocryphal, gathered round his name—*The Merie Tales of Skelton*. During the rest of the century he figured in the popular imagination as an incorrigible practical joker. His sarcastic wit made him some enemies, among them Sir Christopher Garnesche or Garnceys, Alexander Barclay, William Lilly and the French scholar, Robert Gaguin (c. 1425-1502). With Garnceys he engaged in a regular "flyting," undertaken, he says, at the king's command, but Skelton's four poems read as if the abuse in them were dictated by genuine anger. Earlier in his career he had found a friend and patron in Cardinal Wolsey, and the dedication to the cardinal of his *Replycacion* is couched in the most flattering terms. But in 1522, when Wolsey in his capacity of legate dissolved convocation at St Paul's, Skelton put in circulation the couplet:

"Gentle Paul, laie doune thy sward
For Peter of Westminster hath shaven thy beard."

In *Colyn Cloute* he incidentally attacked Wolsey in a general satire on the clergy, but *Speke, Parrot* and *Why come ye nat to Courte?* are direct and fierce invectives against the cardinal who is said to have more than once imprisoned the author. To avoid another arrest Skelton took sanctuary in Westminster Abbey. He was kindly received by the abbot, John Islip, who continued to protect him until his death on the 21st of June 1529. The inscription on his tomb in the neighbouring church of St Margaret's described him as *vates pierius*.

In his *Garlande of Laurell* Skelton gives a long list of his works, only a few of which are extant. The garland in question was worked for him in silks, gold and pearls by the ladies of the countess of Surrey at Sheriff Hutton Castle, where he was the guest of the duke of Norfolk. The composition includes complimentary verses to the various ladies concerned, and a good deal of information about himself. But it is as a satirist that Skelton merits attention. *The Bowge of Court* is directed against the vices and dangers of court life. He had already in his *Boke of the Thre Foles* drawn on Alexander Barclay's version of the *Narrenschiff* of Sebastian Brant, and this more elaborate and imaginative poem belongs to the same class. Skelton, falling into a dream at Harwich, sees a stately ship in the harbour called the *Bowge of Court*,¹ the owner of which is the Dame Saunce Pere. Her merchandise is Favour; the helmsman Fortune; and the poet, who figures as Drede (modesty), finds on board Favell (the flatterer), Suspect, Harvy Hafter (the clever thief), Dysdayne, Ryotte, Dyssymuler and Subtylte, who all explain themselves in turn, until at last Drede, who finds they are secretly his enemies, is about to save his life by jumping overboard, when he wakes with a start. Both of these poems are written in the

¹ Bowge—Fr. *bouche*; court rations. The term is explained as the right to eat at the king's table.

seven-lined Chaucerian stanza, but it is in an irregular metre of his own that his most characteristic work was accomplished. *The Boke of Phyllyp Sparowe*, the lament of Jane Scroop, a schoolgirl in the Benedictine convent of Carowe near Norwich, for her dead bird, was no doubt inspired by Catullus. It is a poem of some 1400 lines and takes many liberties with the formularies of the church. The digressions are considerable. We learn what a wide reading Jane had in the romances of Charlemagne, of the Round Table, The Four Sons of Aymon and the Trojan cycle. Skelton finds space to give his opinion of Chaucer, Gower and Lydgate. He seems fully to have realized Chaucer's value as a master of the English language. Gower's matter was, he said, "worth gold," but his English he regarded as antiquated. The verse in which the poem is written, called from its inventor "Skeltonical," is here turned entirely to whimsical use. The lines are usually six-syllabled, but vary in length, and rhyme in groups of two, three, four and even more. It is not far removed from the old alliterative English verse, and well fitted to be chanted by the minstrels who had sung the old ballads. For its comic admixture of Latin Skelton had abundant example in French and Low Latin macaronic verse. He makes frequent use of Latin and French words to carry out his exacting system of frequently recurring rhymes. This breathless, voluble measure was in Skelton's energetic hands an admirable vehicle for invective, but it easily degenerated into doggerel. By the end of the 16th century he was a "rude rayling rimer" (Puttenham, *Arte of English Poesie*), and at the hands of Pope² and Warton he fared even worse. His own criticism is a just one:—

"For though my ryme be ragged,
Tattered and jagged,
Rudely rayne beaten,
Rusty and moughte eaten,
It hath in it some pyth."

Colyn Cloute represents the average country man who gives his opinions on the state of the church. There is no more scathing indictment of the sins of the clergy before the Reformation. He exposes their greed, their ignorance, the ostentation of the bishops and the common practice of simony, but takes care to explain that his accusations do not include all and that he writes in defence of, not against, the church. He repeatedly hits at Wolsey even in this general satire, but not directly. *Speke, Parrot* has only been preserved in a fragmentary form, and is exceedingly obscure. It was apparently composed at different times, but in the latter part of the composition he openly attacks Wolsey. In *Why come ye nat to Courte?* there is no attempt at disguise. The wonder is not that the author had to seek sanctuary, but that he had any opportunity of doing so. He rails at Wolsey's ostentation, at his almost royal authority, his overbearing manner to suitors high and low, and taunts him with his mean extraction. This scathing invective was not allowed to be printed in the cardinal's lifetime, but it was no doubt widely circulated in MS. and by repetition. The charge of coarseness regularly brought against Skelton is based chiefly on *The Tunnyng of Elynoure Rummyng*, a realistic description in the same metre of the drunken women who gathered at a well-known ale-house kept by Elynour Rummyng at Leatherhead, not far from the royal palace of Nonsuch. "Skelton Laureate against the Scottes" is a fierce song of triumph celebrating the victory of Flodden. "Jemmy is ded And closed in led, That was theyr owne Kynge," says the poem; but there was an earlier version written before the news of James IV.'s death had reached London. This, which is the earliest singly printed ballad in the language, was entitled *A Ballade of the Scottysse Kynge*, and was rescued in 1878 from the wooden covers of a copy of *Huon de Bordeaux*. "Howe the douty Duke of Albany, lyke a cowarde knight" deals with the campaign of 1523, and contains a panegyric of Henry VIII. To this is attached an *envoi* to Wolsey, but it must surely have been

² (Spence, *Anecdotes*, p. 87): Pope said: "Skelton's poems are all low and bad, there is nothing in them that is worth reading," and (in *Satires and Epigrams*, v. 38) "And beastly Skelton heads of houses quote."

misplaced, for both the satires on the cardinal are of earlier date.

Skelton also wrote three plays, only one of which survives. *Magnificence* is one of the best examples of the morality play. It deals with the same topic as his satires, the evils of ambition; its moral, "how suddenly worldly wealth doth decay," being a favourite one with him. Thomas Warton in his *History of English Poetry* described another piece *Nigramansir*, printed by Wynkyn de Worde in 1504, and dealing with simony and the love of money in the church; but no copy is known to exist, and some suspicion has been cast on Warton's statement.

Illustration of the hold Skelton had on the public imagination is supplied from the stage. A play (1600) called *Scogan and Skelton*, by Richard Hathway and William Rankins, is mentioned by Henslowe. In Anthony Munday's *Downfall of Robert, earl of Huntingdon*, Skelton acts the part of Friar Tuck, and Ben Jonson in his masque, *The Fortunate Isles*, introduced "Skogan and Skelton in like habits as they lived."

Very few of Skelton's productions are dated, and their titles are here necessarily abbreviated. Wynkyn de Worde printed the *Bowge of Court* twice. *Divers Baletlys and dytys solacious devysed by Master Skelton Laureat, and Skelton Laureate agaynste a comely Coystroune* . . . have no date or printer's name, but are evidently from the press of Richard Pynson, who also printed *Replycacion against certain yong scolers*, dedicated to Wolsey. *The Garlande or Chapelet of Laurell* was printed by Richard Faukes (1523); *Magnificence, A goodly interlude*, . . . probably by John Rastell about 1533, reprinted (1821) for the Roxburghe Club. *Hereafter foloweth the Boke of Phyllyp Sparowe* was printed by Richard Kele (1550?), Robert Toy, Antony Kitson (1560?), Abraham Veale (1570?), John Walley, John Wyght (1560?). *Hereafter foloweth certayne bokes compyled by mayster Skelton* . . . including "Speke, Parrot," "Ware the Hawke," "Elynoure Rummynge" and others, was printed by Richard Lant (1550?), John King and Thomas March (1565?), by John Day (1560). *Hereafter foloweth a litle boke called Colyn Cloute and Hereafter . . . why come ye nat to Courte?* were printed by Richard Kele (1550?) and in numerous subsequent editions. *Pithy, plesaunt and profitable workes of maister Skelton, Poete Laureate. Nowe collected and newly published* was printed in 1568, and reprinted in 1736. A scarce reprint of *Elinour Rummin* by Samuel Rand appeared in 1624.

See *The Poetical Works of John Skelton; with Notes and some account of the author and his writings*, by the Rev. Alexander Dyce (2 vols., 1843). A selection of his works was edited by W. H. Williams (London, 1902). See also *Zur Charakteristik John Skeltons* by Dr Arthur Koelbing (Stuttgart, 1904); F. Brie, "Skelton Studien" in *Englische Studien*, vol. 38 (Heilbronn, 1877, etc.); A. Rey, *Skelton's Satirical Poems* . . . (Berne, 1899); A. Thümmel, *Studien über John Skelton* (Leipzig-Reudnitz, 1905); G. Saintsbury, *Hist. of Eng. Prosody* (vol. i., 1906); and A. Kölbing in the *Cambridge History of English Literature* (vol. iii., 1909).

SKELTON AND BROTTON, an urban district in the Cleveland parliamentary division of the North Riding of Yorkshire, England, 17 m. E. by S. of Middlesbrough by a branch of the North-Eastern railway, with stations at Brotton and North Skelton. Pop. (1901) 13,240. This is one of the largest townships in the Cleveland ironstone district, and its industrial population is wholly employed in the quarries. The modern Skelton Castle incorporates part of the ancient stronghold of Robert de Brus who held it from William the Conqueror. A modern church replaces the ancient one, of which there are ruins, and a fine Norman font is preserved. The large ironstone quarries have not wholly destroyed the beauty of the district. The Cleveland hills rise sharply southward, to elevations sometimes exceeding 1000 ft., and are scored with deep and picturesque glens. On the coast, which is cliff-bound and fine, is the watering-place of Saltburn by the Sea.

SKENE, WILLIAM FORBES (1809-1892), Scottish historian and antiquary, was the second son of Sir Walter Scott's friend, James Skene (1775-1864), of Rubislaw, near Aberdeen, and was born on the 7th of June 1809. He was educated at Edinburgh High School, in Germany and at the university of St Andrews, taking an especial interest in the study of Celtic philology and literature. In 1832 he became a writer to the signet, and shortly afterwards obtained an official appointment in the bill department of the Court of Session, which he held until 1865. His early interest in the history and antiquities of the Scottish Highlands bore its first fruit in 1837, when he published *The Highlanders of Scotland, their Origin, History and Antiquities*. His chief work,

however, is his *Celtic Scotland, a History of Ancient Alban* (3 vols., Edinburgh, 1876-1880), perhaps the most important contribution to Scottish history written during the 19th century. In 1879 he was made a D.C.L. of Oxford, and in 1881 historiographer royal for Scotland. He died in Edinburgh on the 29th of August 1892.

The most important of Skene's other works are: editions of John of Fordun's *Chronica gentis Scotorum* (Edinburgh, 1871-1872); of the *Four Ancient Books of Wales* (Edinburgh, 1868); of the *Chronicles of the Picts and Scots* (Edinburgh, 1867); and of Adamuan's *Vita S. Columbae* (Edinburgh, 1874); an *Essay on the Coronation Stone of Scone* (Edinburgh, 1869); and *Memorials of the Family of Skene of Skene* (Aberdeen, 1887).

SKETCH (directly adapted from Dutch *schets*, which was taken from Ital. *schizzo*, a rough draft, Lat. *schedium*, something hastily made, Gr. *σχεδιος*, sudden, off-hand, *σχεδόν*, near by; Ger. *Skizze* and Fr. *esquisse* are from the same source), a rough or hasty preliminary outline or draft serving as a note or material for a finished work. Though used of literary composition, as for a short slightly constructed play, or of a rapid delineation in words of an event or character, the term is chiefly used of the putting on paper or other material of the immediate impression of an object, figure, landscape, &c., by an artist, or of an artist's first idea or conception of a work whether in painting or sculpture.

SKI (pronounced "skee," Icel. *scidh*, snow-shoe, properly "piece of wood"), the wooden snow-shoe on which the inhabitants of Scandinavia and neighbouring countries travel over the snow. Implements for this purpose were used by many nations of antiquity. Xenophon (*Anab.* iv. 5) describes the shoes or pattens of skins with which the horses of the Armenians were shod, to prevent them from sinking into the snow, and Procopius made mention of the ancient Lapps, known in Scandinavia as "Skrid-Finnen," or sliders. Snow-shoes have always been used by the Mongols of north-western Asia. From the evidence of the old Norse sagas they must have been general in Scandinavia long before the Christian era. Uller, the god of winter, is always spoken of as walking upon skis, the curved toes of which gave rise to the legend that they were really ships upon which the god was wafted over hill and dale. Skis have been used time out of mind by Lapps, Finns and Scandinavians for hunting and journeying across the frozen country. The first skis of which there is any record were elongated, curved frames covered with leather. Those of the Skrid-Finnen of the 16th century were leather shoes, pointed at the toe, about 3 ft. long, into which, a few inches from the rear end, the feet were thrust up to the ankles. The form of the shoe varied in different districts. Modern skis are not, like the North American snow-shoe, made of broad frames covered with a thong web, but long, narrow, nearly flat pieces of ash, oak or spruce, pointed and turned up for about a foot at the toe. Their length is usually the distance their wearer can reach upwards with his hand, that for the average man being about 7 ft. 6 in., although some advocate less length.

Their width at the broadest part is about 5 in., and their greatest thickness (just under the foot) about 1¼ in., tapering towards both ends. The under surface is usually perfectly smooth, although some skis are provided with narrow strips running lengthwise on the under surface, to prevent side-slipping. The feet, encased in stout deer-hide shoes, heelless or nearly so, are fastened to the middle of the skis by an arrangement of straps, called the *binding*. A staff from 4 to 5 ft. long completes the touring outfit. On level ground the skis are allowed to glide over the snow without being lifted from it, the heels being raised while the toes remain fast to the skis. At this gait very long steps can be taken. Climbing hills one must walk zigzag, or even directly sideways step by step. Gentle slopes can be ascended straight ahead by planting the skis obliquely. Downhill the skis become a sledge upon which great velocity is attained. The staff is used as a brake in coasting, and is provided with a small disc a few inches from the lower end, to prevent it sinking into the snow.

Skiing as a sport began about 1860 in the Norwegian district of Telemark and rapidly spread over all the Scandinavian

peninsula. The climax of the racing season is the great international ski tournament held annually in February at Holmenkollen, 6 m. from Christiania. This "Norwegian Derby" is divided into two parts, the first devoted to jumping contests, the other to long-distance racing. The take-off for the jumping contests is built into the side of a hill, and each competitor must jump three times. No staff is allowed and no jump is counted if the jumper falls in alighting. The distances covered are extraordinary, 134½ ft. being the record. The jumper, who starts some distance up the hill, descends at top speed, stoops as he nears the take-off and launches himself into the air with all his force. He maintains an erect position until he reaches the ground, alighting with bended knees, on both feet, one a little in advance of the other, and "giving" with his legs to overcome the force of the fall and to preserve his balance. Another feature is double jumping, performed by two persons hand in hand. The highest prize is the King's Cup. The principal distance race is over a difficult course of about 20 m. The record for 25 kilometres (15½ m.) is 2 hours, 7 min. A Lapp once covered 220 kilometres (about 138 m.) in 21 hrs., 22 min., the country being level. Skiing is very popular in Norway with both men and women; in fact it may be called the national sport of Norway.

The sport has been introduced into other countries where the winter is severe, and has become very popular in Switzerland and the United States, especially in Minnesota and the Rocky Mountain country. The principal club in the British Isles is the "Ski Club of Great Britain." The mails between Chile and the Argentine Republic are carried in winter by relays of Norwegian ski-runners, about 300 being employed. The skis worn by them are usually shod with horn. Skis cannot be used with advantage during a thaw or where the snow is less than 6 in. deep. On this account, and because of their general unwieldiness, they are less convenient in thick forests than the Indian snow-shoe, though faster in the open country.

Ski have been used for military purposes by the Northern peoples for several centuries, and of late years other nations which have mountainous regions of snow have turned their attention to this most useful mode of winter marching. The army of Sweden—under Gustavus Adolphus and his successors one of the foremost in Europe—employed infantry provided with ski in its military operations. In Norway special units so provided were organized in 1710. Recently (1902) the Alpine infantry of France and Italy have taken up the question. In Briançon, attached to the 159th regiment of French infantry, is an *école militaire de ski* (established 1903) which trains the *Chasseurs Alpins* of the 1st line, and also the regional troops which are intended to take part in the defence of the south-eastern frontier of France. These regiments as a rule furnish one officer, one non-commissioned officer and a few soldiers each to every course of instruction, which lasts two months. At the end of the first month the *skieur* is expected in full marching order to cover 60 kilometres (37½ m.) of Alpine territory in the day. The ski are put to a variety of ingenious uses; to form a stretcher-sledge for wounded men; and if rapidity of movement is desired, a horse or pony pulls the *skieur* along by means of long reins attached to the horse's girth. Even camps in the mountains are improvised. The *skieur* is thickly clothed and muffled, and his eyes are protected against snow-blindness by blue or black spectacles. Some of the performances of soldiers on ski have been notable. Captain Bernard, chief of the *école* of Briançon, ascended the *cols* of Arsiné (2400 metres) and of the Cauterel (2080 metres) in 16 hours with a party of 25 men. In Russia some Finland troops in full marching order executed a long hunting march in Carelia. In 29 days they covered 860 kilometres. In Switzerland a *skieur* took less than 1½ hours to cover 25 kilometres, including altitudes of 1547 metres. In order to witness this competition, which took place in Glarus, the soldiers from the S. Gothard garrison made a march of 48 kilometres including the ascent of the Klausengrass (2000 metres). A Norwegian soldier named Holte covered with one leap a distance of 21 m. 20 cm., and his companion Heyderdahl later achieved 24.

In Italy each company of *Alpini* has an annual credit for the provision of ski. Their duties in war time are almost the same as those of mounted infantry—exploration and communication, and the seizure of advanced positions.

In the seven months of snow on these frontiers the garrisons of the lonely posts cannot go out save on ski or snow-shoes, as to the respective merits of which military opinion is divided.

See *Norway's National Sport*, by T. W. Schreiner, *Outing*, vol. 37; *Auf Schneeschuhen durch Grönland*, by F. Nansen (Hamburg, 1891); *Ski-running*, edited by E. C. Richardson (London, 1904); *Year-Book of the Ski Club of Great Britain*.

SKIBBEREEN, a market town of county Cork, Ireland, on the river Ilen about 3 m. from its estuary, 53¾ m. S.W. of Cork by the Cork, Bandon and South Coast railway. Pop. (1901) 3208. The river is navigable for small vessels to Skibbereen itself, and for larger ones to Old Court on the estuary; and the town is a flourishing fishing-station. Trade in corn and other agricultural produce is considerable. This district suffered terribly in the famine of 1847, and hundreds of victims were buried in pits in the graveyard adjoining the ruined Cistercian cell of Abbeystowry, a mile west of the town. The Ilen offers fishing, late in the season, for brown and sea trout. The main railway continues south to Baltimore, and a light railway runs to the pleasant seaside village of Skull (or Schull), 15 m. W. Skibbereen is governed by an urban district council.

SKIEN, a seaport of southern Norway, in Bratsberg amt (county), on the river Skien, 5 m. below its issue from Lake Nord, and 6 m. above its outflow into Frier Fjord. Pop. (1900) 11,343. It was mostly rebuilt after a fire in 1886. Here Henrik Ibsen, the dramatist, was born in 1828. In 1892 a canal ascending 189 ft. by means of 17 locks was made between lakes Bandak and Nord, giving access to the Telemark district by way of Dalen. The whole distance between the lakes is 40 m., and several fine falls, as the Ulefos, Eidsfos, and Vrangfos, are passed. The engineering is noteworthy. In the town and district are numerous saw-mills, planing, cotton-spinning and flour-mills, factories for wood-pulp and domestic commodities, also a copper mine (at Omdal). The exports are ice, timber (including telegraph poles for the British government), wood-pulp and copper, and the imports coal and china-clay. The town (the ancient *Skida*) dates from the 14th century. A fine view is obtained from the Bratsberg Klev, S. E. of the town, with ruins of a chapel.

SKIERNIEWICE, a town of Russian Poland, in the government of Warsaw, 41 m. by rail S.W. from the city of Warsaw. Pop. (1897) 9846. It was formerly the see of the archbishop of Gnesen, primate of Poland. Here is an imperial castle, in which the emperors of Russia, Austria and Germany met in conference on the 15th-17th of September 1884. Cloth and linen are manufactured.

SKIMMER, the English name bestowed by T. Pennant¹ in 1781 on a North American bird which had already been figured and described by M. Catesby (*B. Carolina*, i. pl. 90) as the "Cut-water,"—as it appears still to be called on some parts of the coast,²—remarkable for the unique formation of its bill, in which the maxilla, or so-called upper mandible, is capable of much vertical movement, while the lower mandible, which is considerably the longer of the two, is laterally compressed so as to be as thin as a knife-blade. This bird is the *Rhynchops nigra* of Linnaeus, who, however, united with it what proves to be an allied species from India that, having been indicated many years before by Petiver (*Gazoph. naturae*, tab. 76, fig. 2), on the authority of Buckley, was only technically named and described in 1838 by W. Swainson (*Anim. Menageries*, p. 360) as *R. albicollis*. A third species, *R. flavirostris*, inhabits Africa; and examples from South America, though by many writers regarded as identical with *R. nigra*, are considered by Howard Saunders (*Proc. Zool. Society*, 1882, p. 522) to form a fourth, the *R. melanura* of Swainson (*ut supra*, p. 340). All these

¹ "I call it *Skimmer*, from the manner of its collecting its food with the lower mandible, as it flies along the surface of the water" (*Gen. of Birds*, p. 52).

² Other English names applied to it in America are "Razorbill," "Scissorbill," and "Shearwater."

resemble one another very closely, and, apart from their singularly-formed bill, have the structure and appearance of Terns (*q.v.*). Some authors make a family of the genus *Rhynchops*, but it seems needless to remove it from the *Laridae* (see GULL). In breeding-habits the Skimmers thoroughly agree with the Terns, the largest species of which group they nearly equal in size, and indeed only seem to differ from them in the mode of taking their food, which of course is correlated with the extraordinary formation of their bill.

(A. N.)

SKIN AND EXOSKELETON, in anatomy. The skin (*A.-S. scinn*) is the covering of the whole body, and is continuous at the different orifices with the mucous membrane. It acts firstly as a protective layer, secondly as a regulator of the temperature, thirdly as an excretory organ and fourthly as a tactile and sensory organ in which nerves end.

The skin varies in thickness from .5 mm. in the eyelids to 4 or more mm. in the palms and soles; it is also very thick over the back of the body. Two main layers are recognized in the

the epidermis. In sensitive parts like the palms and soles these papillae are specially prominent and form wavy lines, each of which consists of a double row between which the ducts of the sweat glands pass on their way to the surface. So large are the papillae in these situations that the epidermis is also raised into ridges, and these in the fingers form the characteristic whorls so valuable for purposes of identification. The papillae contain leashes of blood-vessels, and in some of them are special tactile corpuscles in which the nerves end (see NERVOUS SYSTEM).

In the deeper or *reticular layer* of the true skin the fibrous feltwork is looser and encloses pellets of fat. It also contains a network of blood-vessels and nerves, and in some places a layer of striped or unstriped muscle. Where hairs are present the hair follicles lie in this deeper layer, which gradually merges with the subcutaneous fatty tissue (see fig. 2).

As appendages of the skin are found the hairs, the nails and the sebaceous and sweat glands.

Hair.—The hairs are found in man on the scalp, eyelids, eyebrows, armpits, pubic region, vestibule of the nose, external auditory meatus, face, ventral surface of the trunk and dorsal surfaces of the leg, forearm and hand; indeed the only places which are quite free from them are the palms of the hands, soles of the feet and the glans penis. In some places, such as the armpits, pubic region and the face of the male they grow to a considerable length at and after puberty. They are of great anthropological interest since they differ in colour and texture in different races, sometimes being straight, sometimes wavy, sometimes curly. The amount and distribution of long hairs also vary with the race. In section it is only the straight hairs which are circular; wavy and curly hairs are oval. In the centre of each hair is the medulla or pith, though this is not always present; it is composed of nucleated cells containing pigment, fat and air spaces. Outside this is the fibrous layer or cortex, also containing pigment and air spaces, while most superficially is the cuticle made up of overlapping scales. The hair grows at its root from a *hair follicle* (see fig. 2), which is a tubular inpushing of the epidermis into the true skin or, in the case of large hairs, deeper still into the superficial fascia. It is divided into an *inner* and *outer root sheath*, the former representing the more superficial layers of the epidermis, the latter the deeper layers. At the bottom of the follicle the hair enlarges to form the bulb, and into the lower part of this a vascular papilla projects from the true skin. The cells of the hair are derived from, and are continuous at the bulb with those of the outer root sheath, and therefore with the deeper layers of the epidermis.

The hair follicle always projects somewhat obliquely into the skin, and attached to the side toward which it is leaning is a small band of non-striated muscular fibres called *arrector pili*. When this acts it diminishes the obliquity of the hair and so makes it "bristle" or "stand on end," while a general contraction of these small muscles leads to the familiar condition of "gooseflesh."

Nails.—The nails are specially thickened parts of the epidermis, and are divided into a root and a body. The former is concealed by a fold of skin, and the corium on which it lies is known as the *nail matrix*. The body of the nail also lies on the corium, or true skin, which forms the *nail bed* and is very sensitive. This body of the nail is formed by the stratum germinativum and stratum mucosum in its deeper part, and more superficially by the stratum lucidum, which is here very much thickened and converted into keratin or horn. Near the root of each nail is a semi-lunar area which is more opaque than the rest and forms the white *lunula*.

Sweat Glands.—Sebaceous glands are found wherever there are hairs, however rudimentary, and open by their ducts into the superficial part of the hair follicle (see fig. 2). Their deeper or secreting part divides into a number of bag-like alveoli composed of cells, which secrete oil droplets. There may be two or three glands to each hair follicle, and their size does not vary directly with that of the hair, since they are very large in the nose, where the hairs are quite rudimentary. They are also found on the labia minora and nipples, where no hairs are. *Sudoriparous* or sweat glands (see fig. 2) are found all over the surface of the body,

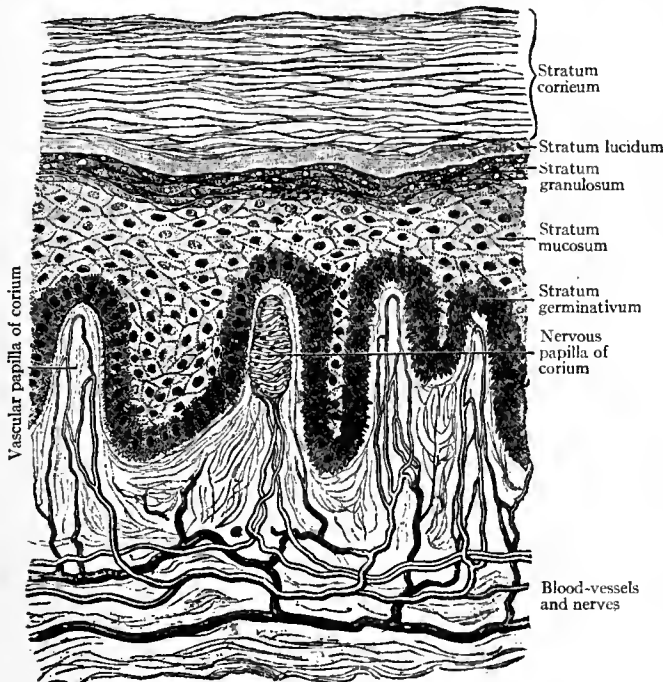

From Robert Howden in Cunningham's *Text-Book of Anatomy*.

FIG. 1.—Vertical section of Epidermis and Papillae of Corium (highly magnified).

skin; superficially there is the scarf skin or epidermis and more deeply the dermis or true skin. The *epidermis* under the microscope is seen to consist of five layers. On the surface is the horny layer or *stratum corneum* (see fig. 1) composed of layers of scale-like cells, the walls of which are turned into the horny substance keratin. Deep to this is a thin layer of scale-like cells without keratin known as the *stratum lucidum*. Deeper still is a layer, the *stratum granulosum*, in which the cells are not so flattened and contain granules of a substance known as eleidin. In the fourth layer, *stratum mucosum* or *stratum Malpighii*, the cells are polygonal and are connected together by delicate prickle-like processes. It is in the deeper layers of these cells that the pigment of the negro's skin is found. The fifth and deepest layer of the epidermis is the *stratum germinativum*, in which there is only one layer of columnar cells. The whole of the epidermis is non-vascular, and it will be noticed that as the different layers approach the surface the cells become more and more flattened. The *true skin*, *dermis* or *corium* is composed of a felted network of white fibrous tissue with a small number of yellow elastic fibres interspersed. It is divided into two layers.

The superficial or *papillary layer* lies next to the epidermis and is raised into a number of papillae or conical projections which fit into corresponding depressions on the deep surface of

but are specially numerous on the palms and soles. It is estimated that in the palm there are nearly 3000 to a square inch, while in the skin of the back they do not reach 500 to the same area. In the armpits and groins they are very large. Each consists of a single long tube, lined by columnar epithelium, and coiled up into a ball or glomerulus in the subcutaneous tissue, after which it pierces the corium and epidermis to reach the surface at the *porus sudoriferus*. Where the stratum corneum of the epidermis is thick the duct is twisted like a corkscrew as it goes through.

The glands of *Moll* in the eyelids and the ceruminous or wax glands of the ear are modified sweat glands; the former, when inflamed, cause a "sty."

EMBRYOLOGY

The skin is derived partly from the ectoderm and partly from the mesoderm of the embryo. The whole of the epidermis

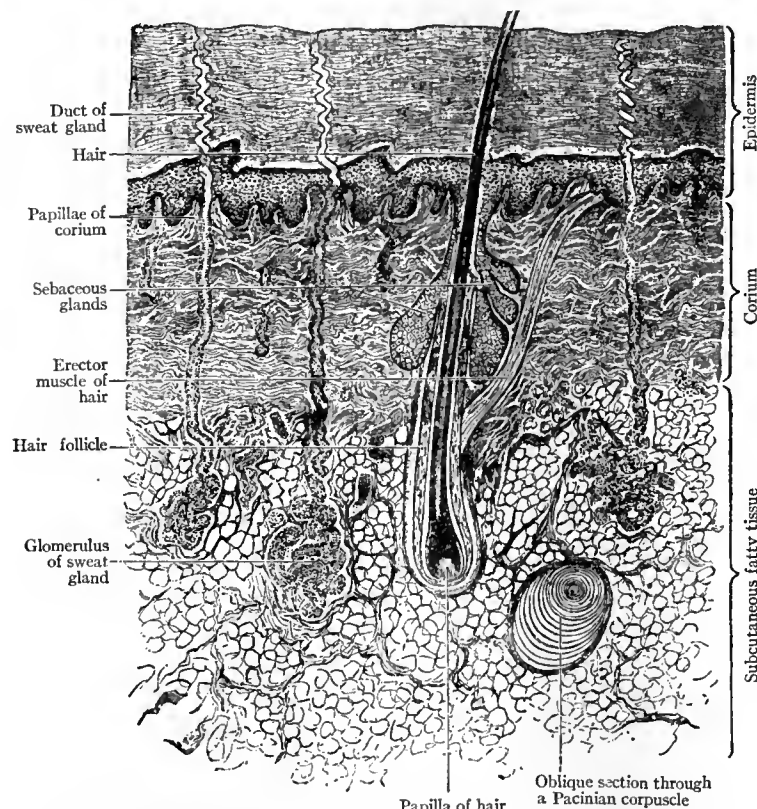

From Robert Howden, in Cunningham's *Text-Book of Anatomy*.

FIG. 2.—Vertical section of the Skin (schematic).

and its appendages are ectodermal, and in the early embryo consist of a single layer of cells; later on this becomes double, and the superficial layer is called the *epitrichium*, which, after the sixth month, is cast off and mixes with the secretion of the large sebaceous glands to form the soapy *vernix caseosa* with which the foetus is coated at birth. In the meantime the cells of the deeper layer divide and form the various layers of the epidermis already enumerated. It is held, however, by some observers that part of the epitrichium remains as the stratum corneum. The mesodermal cells belong to the mesenchyme, and form the fibrous tissue of the true skin as well as the arrectores pilorum muscles and, in the scrotum, the *dartos* layer of unstriated muscle. In the sixth month fatty tissue appears in the deeper parts, and so the fat of the superficial fascia or subcutaneous tissue is formed. The nails are said to appear as thickenings of the epidermis at about the ninth week, quite at the tips of the digits. Later on they shift to the dorsal side, and in doing so carry the nerves in the nail bed with them. This is the only explanation available of the fact that the ventral nerves to the tips of the fingers encroach on the dorsal area. By about the twelfth week the nails are perfectly formed, but they do not reach the level of the finger tips until the eighth month. The hairs are developed in the third month of foetal life by ingrowths of the stratum mucosum of the epidermis into the corium. During the fourth and fifth months the body becomes covered by fine unpigmented hairs which are known as *lanugo*; these begin to disappear about the eighth month, but some remain until after birth. On the scalp, however, the hair at birth is often more deeply pigmented than that which succeeds it. The sebaceous and sweat glands, like the hair follicles, are ingrowths of the stratum mucosum of the epidermis into the corium. The former

become very large in the later months of embryonic life, and secrete a large part of the above-mentioned *vernix caseosa*. The development of the mammary gland from modified sebaceous glands has already been referred to (see MAMMARY GLAND).

For further details see J. P. M'Murich, *Development of the Human Body* (London, 1906); J. C. Heisler, *Text-book of Embryology* (London, 1907); Quain's *Anatomy*, vol. i. (London, 1908).

COMPARATIVE ANATOMY

In the larval (gastrula) stage of the *Amphioxus* (lancelet) cilia are present on the surface, and in the superficial epidermal cells of some fishes and amphibian larvae there is a striated layer on the free edge which is looked upon as a relic of ancestral cilia.

Skin Glands.—The skin glands of the Cyclostomata (hags and lampreys) and fishes are generally unicellular and secrete slime which protects the surface of the body; the amount of slime poured out by some of the cyclostomes is enormous. Many of these slime cells, from their shape, are spoken of as goblet cells. Some of the teleostean fish have poison glands at the bases of their dorsal fins and opercula.

In the mud fish (Dipnoi) and amphibians multicellular spherical glands appear as involutions of the ectoderm. Sometimes, as in the so-called parotids of the toad, these form large masses. Reptiles and birds are singularly wanting in skin glands, though the latter have a large *urophygial gland* at the root of the tail which secretes oil to lubricate the feathers; it is the chief constituent of the "parson's nose" of the fowl. In mammals, except the Cetacea, the sebaceous and sudoriparous glands already described in man are found; some of the former sometimes attain a large size, as in the interdental gland of the sheep, Müller's gland at the back of the pig's knee and the suborbital gland of ruminants. In addition to these, special scent-producing glands are often found in different parts, the most remarkable of which, perhaps, are the scent glands beneath the tail of the skunk, while in male monotremes there is a special poison gland in the leg which is connected with a spur in the foot.

Pigment.—Pigment cells are present both in the dermis and epidermis of fishes and amphibians, and the pigment may be either intra- or extra-cellular. In many cases it is under the control of the nervous system, so that forms like the flat-fish and the common frog can adapt their coloration to that of their background. In animals permanently excluded from the light, pigment is absent. In reptiles movable pigment cells are often found, as in the chameleon, while in birds the pigment is sometimes of great brilliancy in the necks and wattles. In mammals, as in man, the pigment is confined to the cells of the stratum mucosum layer of the epidermis.

Scales.—In the elasmobranch fishes scales are found composed of enamel superficially, and of dentine and bone deeply. They are developed from the epidermis and dermis, and in almost every way resemble the teeth of these animals, which are only modifications of them. The bony basal part of each scale is plate-like, hence this kind of scale is known as *placoid*. In the ganoid fishes, such as the sturgeon, much larger plaques called *ganoid scales* form a complete armature. In the teleostean fishes the scales overlap like tiles and are either *cycloid*, having a smooth border, or *ctenoid*, in which the free posterior border is serrated. Existing amphibians are usually remarkable for absence of any skin armour, though in fossil forms (*Stegocephala*) it was very complete. The reptilian class is specially noticeable for the production of epidermal scales, which undergo many modifications. In the Ophidia they are cast off periodically in one mass as the snake's slough, while in the Chelonia they form the different varieties of tortoise-shell. Bony structures, developed in the dermis, may underlie these epidermal horny thickenings, and are very strongly developed in the dorsal and ventral bony shields of the Chelonia (carapace and plastron), which secondarily fuse with the true endoskeleton. The armadillo is the only mammal which has a true bony exoskeleton.

Feathers.—Birds are remarkable for the possession of feathers, which are highly modified scales. The embryonic or *down feathers* are simple, and consist of a brush of hair-like *barbs* springing from a basal quill or *calamus*. From the whole length of each barb a series of smaller *barbules* comes off like branches of a shrub. The adult or *contour feathers* are formed at the bottom of the same follicles which lodge the down feathers and, by their growth, push these out. At first they are nothing more than enlarged down feathers, but soon one of the barbs grows enormously, and forms a main shaft or *rachis* to which the other barbs are attached on either side. From the sides of the barbs grow the barbules, just as in the down feathers, and these, in the case of the large wing feathers (*remiges*) and tail feathers (*rectrices*), are connected by minute hooks so that the feather *vane*, as opposed to the shaft, has a more resistant texture than it has in the feathers of the back or breast. The bird's moult is comparable to the casting of the scales in the reptiles.

Hairs.—Hairs are only found in the mammalian class, and are divided into the long tactile bristles or vibrissae and the smaller hairs which maintain the warmth of the body. In some animals the hair of the body is composed of long, stiff hairs, which are probably

specialized for protective purposes, and short, soft hairs, which form the fur and keep in the warmth. Sometimes these long hairs are greatly enlarged and hardened to form protective spines as in the porcupine, hedgehog, spiny mouse and spiny ant-eater (*Echidna*).

Horns.—Horns are of three kinds: (1) antlers, (2) hollow horns and (3) hairy horns of the rhinoceros.

Antlers are growths of true bone and, except for their very vascular covering of skin (velvet), are not exoskeletal structures. They grow with great rapidity, and in the deer family are renewed each year. As soon as their growth is finished the skin covering dries up and strips off. The small horns of giraffes are also bony structures though permanent.

The hollow horns of the ruminants (*Bovidae*) are cases of hardened epidermis which fit over a bony core and are permanent. They are found in both sexes, and in this differ from the antlers of the deer, which, except in the reindeer, are confined to the male. In the prongbuck (*Antilocapra*) the hollow horns are shed periodically.

The hairy horns of the rhinoceros are a mass of hairs cemented together by cells. The hairs grow from dermal papillae, but differ from true hairs in not being sunk into hair follicles.

Claws and Hoofs.—These are modifications of nails, but whereas in nails and claws the structures are confined to the dorsal aspect of the digits, in hoofs they spread to the plantar surface as well. It has been shown in the embryological section of this article that the nail appears at the very tip of the digit, and in this position it remains in many amphibians, e.g. giant salamander, while in hoofed mammals it develops both ventrally and dorsally. In the *Felidae* the claws are retractile, but the real movement occurs between the middle and terminal phalanges of the digits.

Spurs.—Spurs are quite distinct from nails and claws; they are very common in birds as horny epidermal sheaths covering bony outgrowths of the radial side of the carpus, metacarpus or metatarsus. The spur-winged goose has a carpal spur; in the screamers (*Palamedea* and *Chauna*) the spur or spurs are metacarpal, while in many gallinaceous birds (e.g. common fowls and pheasants) metatarsal spurs are found. In the mammals the male monotremes (*Echidna* and *Ornithorhynchus*) have spurs attached to an extra (? sesamoid) bone in the hind leg, perforated for the duct of the already mentioned poison gland.

Beaks.—Certain fishes belonging to the family *Mormyridae* have a fleshy prolongation of the lower lip, and are hence termed beaked fishes. In the *Amphibia* *Siren* and the tadpoles of most *Anura* (frogs and toads) have small horny beaks. In the *Reptilia* horny beaks are found in the *Chelonia*, while in birds beaks are constant and replace the teeth in modern species. In mammals a horny beak is found in *Ornithorhynchus*, though it coexists with true teeth in the young and with horny pads in adult specimens. In all these cases the beaks are formed from cornified epidermal scales.

Baleen.—The baleen which is found in the mouths of the *Balaenidae* or whalebone whales is a series of flattened triangular horny plates arranged on either side of the palate. The inner edges and apices of these are frayed out into long fibres which act as strainers. In *Balaena mysticetus*, the Greenland whale, there are nearly four hundred of these plates, the longest of which often exceed 10 ft. In its development baleen resembles rhinoceros horn in that it consists of a number of epidermal hair-like fibres cemented together and growing from dermal papillae, though not from true hair follicles.

For further details and literature see R. Wiedersheim, *Comparative Anatomy of Vertebrates*, translated by W. N. Parker (London, 1907); S. H. Reynolds, *The Vertebrate Skeleton* (Cambridge, 1897).
(F. G. P.)

ETHNOLOGY

The colour of the human skin has always held an important place among physical criteria of race. Physiology explains colour as a consequence of climate and even diet. The pigment or colouring matter under the epidermis, or rather under the second or Malpighian skin, is not peculiar to the Negroid and other coloured races, but is common to all human beings. It is simply more abundant in certain peoples, and this abundance is attributed to the stimulating action of the solar heat, combined with moisture and an excess of vegetable food, yielding more carbon than can be assimilated, the character being then fixed by heredity. Theodor Waitz quotes examples proving "that hot and damp countries favour the darkening of the skin," and that the same race inclines to be darker in low marshy districts than on the hills. C. R. Lepsius asserts that the hotter the climate the darker the negro, pointing out that if you follow the line of greatest heat from Africa into Asia, it is in those regions of the latter continent that the darkest Asiatics are found. Many apparent exceptions to this general law occur, but they may be explainable as due to local causes. Thus Schweinfurth (*Heart of Africa*) believes that the reddish tint of the Bongos and other of the peoples inhabiting the hot, moist White Nile district is due to the

ferruginous nature of the laterite soil: the hue of the A-Zandeh (*Niam-Niam*) of the Welle valley being possibly explicable in the same way. In South America all shades of complexion intermingle. Thus in Bolivia the coppery Maropas, the dark brown Aymaras, the yellowish Moxos, and the light Mosenos, Siriones, and Guarayos are, so to speak, neighbours. In Australasia there is the contrast between the yellow-brown Malays and the sooty-black Tasmanians. Such deviations from the colour-law may be attributed to descent (dark peoples migrating to cold, light to tropical countries), or to such varied causes as dryness, moisture, food and the vegetable peculiarities of the land, by all of which the complexion may be affected, and the influence of temperature mitigated.

The colour of the human skin cannot, then, be regarded as an entirely trustworthy racial test, even blackness not being an exclusively negro characteristic. It serves, however, to divide Man into three fundamental types corresponding to the three great ethnic groups, viz. the White, the Yellow and the Black man. The first predominate in Europe, the second in Asia, while the third have their chief centres in Africa and Melanesia. Interbreeding and, in a lesser degree, the influence of environment have caused the occurrence within the three main groups of almost every shade and tint of complexion. Thus the colour of the skin affords a faulty basis of ethnological classification, since in the same ethnic group it varies so widely and races of one group resemble in this particular races of another. The so-called Red Indians are usually classified as a fourth group, but they are not really red-skinned. The name has come about through their custom of smearing their faces with red ochre. But among the American aborigines, side by side with the yellow, olive brown or even black (e.g. the Charruas of Uruguay), there are tribes of reddish-yellow or coppery hue. This tint is found also in certain African tribes. The palms of the hands and the soles of the feet of negroes are never black, but always yellowish, and in all coloured races the back of the body is a shade darker than the front.

It is noteworthy that the skin of the coloured races is always of a lighter tint in the newly-born than in the adult; the negro baby is born a light grey colour, and the dark pigment is absent in the negro foetus. On the eighth day, sometimes as early as the third, the negro infant changes its colour to a hue nearly as dark as that of its parents. It would seem as if the blackness is associated with the general thickening of the skin and is an accompaniment of the general organic adaptation of the negro to his hot malarious climate. The effects of sunburn vary with different races. It is with the races having intermediate pigmentation, such as the dark Europeans and the yellow peoples, that the effect is most noticeable. With the former the sun burns the skin uniformly, making them of the tint of mulattoes. The colour so acquired is merely temporary. It diminishes in winter, and disappears entirely on their return to a cold temperate climate. With the Asiatics the sun causes different tints. The skins of the Indo-Chinese and the Malays become dark olive. The Fuegians and Galibis turn brick-colour or dull red. The Chinese skin turns darker in winter and paler in summer. Among certain peoples whose skins are naturally dark the parts of the body exposed to the light and air are often lighter than those covered by their clothes. This is the case with the Fuegians and the Sandwich Islanders. The fair European skin reddens under the sun, passing from pale red to brick red or to patches of deep red.

SKIN DISEASES. The diseases of the skin do not essentially differ from those of the other organs of the body. Like these, the skin is composed of cells resting on a connective tissue framework, in which run the vessels which nourish it and the nerves which keep up its communications with the rest of the body. But it has certain differences from other organs, some dependent on its structure and some on its exposed position. Thus, instead of, like the kidney, to which it may best be compared, having its epithelium faced by epithelium, all lies open, and the various processes are all "one-sided." There are no depths to be attacked, and any diseases, if they spread, must do so superficially; spreading as they often do equally in all directions, the diseases of the skin have a tendency to assume a circular form, independently of any parasitic cause, though when such cause is present the patches are of a more perfectly circular shape. Further, from the extent of its superficial area and its exposed position, the skin is liable to be attacked by more forms

of irritation, parasitic or other, than any other organ of the body. Every stage and variety of disease is open to view; minute differences, minor or important, are at once noted; and thus it is that the recognized distinct maladies of the skin are so numerous. In no other organ, with the partial exception of the eye, can the changes be watched from day to day; in none can so many stages of the same disease be simultaneously observed; and in no other is it so simple a matter to remove and instantly fix for microscopic examination the living tissue.

The multitude of its affections renders the difficulties of arranging the diseases of the skin very great, and the absence of any generally accepted scheme of classification has always been and still remains one of the main obstacles to their intelligent study. The older systems, constructed before the days of bacteriology, were commonly based on the form which the eruption assumed (scaly, moist, purulent), but they usually contained in addition a certain number of diseases under the heading of *Parasitic*. Though obviously illogical, such systems served well enough while the recognized parasitic diseases were few, such as those caused by such gross parasites as the *Acarus scabiei* (the itch mite), the *pediculi* (lice), and the hyphomycetic fungi such as the *Achorion Schönleinii*. The discoveries of bacteriology have enormously enlarged this class, but the difficulty is that one and the same disease is regarded as parasitic by one authority, as dependent on nerve influence by another, while a third assumes an agnostic position.

The following is a useful working classification.

I. THE DERMATONEUROSES.—(a) Sensory: *anaesthesia*, *hyperaesthesia*, *pruritus*; (b) vaso-motor: *urticaria*, *erythema multiforme*, *angio-neurotic oedema*, *pellagra*, *purpura*, certain forms of *eczema*, *erythema pernio* (chilblains), *erythema nodosum*, *herpes*, *cheiropompholyx*, alterations of pigment; (c) trophic: *scleroderma*, *perforating ulcer*, *Charcot's bed-sore*, the lesions of certain forms of *leprosy*, *Raynaud's disease*, *Morvan's disease*, *pemphigus*, *lupus erythematosus*, the skin lesions of *syringomyelia*; (d) glandular, according to the gland affected,—as the sweat-glands, *hyperhidrosis*, *haematidrosis*, *bromidrosis*, *miliaria papulosa*, or *prickly heat*; the sebaceous glands, *rosacea*, *seborrhoea*; the hair follicles, *alopecia*, *greyness*.

2. LOCAL INOCULABLE DISEASES.—The agents producing these are parasitic in origin and may be divided into those caused by animal parasites, vegetable parasites and various micro-organisms. (a) Animal parasites: *scabies*, due to the *Acarus scabiei* or itch mite; *pediculosis*, *guinea-worm disease*, due to the *Dracunculus medinensis*; *trichinosis*, due to the *cysticercus cellulosae*; *elephantiasis*, due to the *filaria sanguinis hominis*; various eruptions produced by accidental parasites such as the harvest bug (*leptus autumnalis*), the jigger or sand flea (*Dermatophilus penetrans*), met with in the tropics. (b) Vegetable parasites: *ringworm*, caused by the *Trichophyton tonsurans*; *favus*, caused by the *Achorion Schönleinii*; *tinea versicolor*, caused by the *Microsporon Furfur*; *erythrasma*, due to the *Microsporon minutissimum*; *actinomycosis*, due to the *Actinomyces* or ray fungi; *mycetoma* or *Madura foot*, due to *Dyscomyces*; *aspergillosis* and *pinto*, caused by an unknown fungus; *streptothrix infections* other than from the ray fungus, *sporotrichosis*; *blastomycetic dermatitis*, due to a fungus of the yeast family. (c) Micro-organisms: *impetigo contagiosa*, caused by inoculation with streptococci; *furunculosis* or boils, due to the staphylococcus pyogenes aureus and albus; *carbuncle*, a deeper infection also caused by staphylococci; *anthrax*, caused by the bacillus anthracis; *sycosis*, due to a staphylococcal infection of the hairy parts; *acne*, due to a bacillus called by Gilchrist the bacillus acnes, thought to be identical with the micro-organism of Sabouraud and Unna; *furunculosis orientalis* (Delhi boil, Aleppo boil, Biskra button), a tropical disease in which the parasite is not yet identified; certain forms of *eczema*, notably the *pustular* forms.

3. GENERAL INOCULABLE DISEASES.—*Tuberculosis*, manifesting itself as *lupus vulgaris*, *verruca necrogenica*, *erythema induratum* or as tuberculous ulcerations. In all these Koch's bacillus has been identified. *Syphilis*, caused by the *Spirochaeta pallida* of Schaudinn and Hoffmann, in which there are primary, secondary and tertiary skin lesions. *Leprosy* due to the bacillus lepra. *Yaws* (framboesia), caused by a specific parasite, the *Spirochaeta pertenius*. *Glanders*, due to inoculation with the *bacillus mallei*. Added to these are erysipelas and the various exanthematous fevers.

4. DISEASES OF UNCERTAIN AETIOLOGY.—*Psoriasis*, *pityriasis rubra*, *pityriasis rosea*.

5. ERUPTIONS DUE TO DRUGS.—These may follow on the internal administration of chloral belladonna, copaiba, phenazone, mercury, quinine, tar, stramonium, sulphonal, salicylic acid and the salicylates and bromides.

6. NEW GROWTHS.—Benign: *cheloid* and *fibroma*, *naevus pigmentosus*, *vascular naevi*, *telangiectasis*, *lymphangioma*, *myoma*, *mycosis fungoides*, *papilloma*, *adenoma*, *moluscum contagiosum*, *rhinoscleroma*,

cysts and *warts* (including corns and horny growths). Malignant: *sarcoma*, *carcinoma*, *rodent ulcer*, *Paget's disease*.

The skin is liable to the same pathological conditions as other structures of the body, such as changes in vascularity, inflammations, invasion by parasites and new growths together with changes due to the special structure of the skin such as hypertrophy and atrophy, disorders of the sweat glands and sebaceous glands and alterations of pigment. Some of the groups of diseases classed as the dermatoneuroses are manifestations of widely different diseases; thus anaesthesia and hyperaesthesia occur in hysteria; while the acute bed-sore of Charcot (a form of local gangrene) and perforating ulcer are generally due to an inflammatory condition of the nerve trunks. In the group of diseases known as *purpura*, where haemorrhages of varying size make their appearance on different parts of the skin, the lesion is considered to be due to a toxin or autotoxin acting directly on the vascular walls. In some cases we know it to be inorganic, such as phosphorus or mercury, in others organic as smallpox, measles, typhus or tuberculosis; or the haemorrhages may occur in connexion with new growths such as sarcoma and lymphadenoma. Why these very different causes should combine to produce the phenomenon of haemorrhage is not clear.

The disease known as *urticaria* or nettle-rash is probably due to some irritant poison circulating in the blood, but the causes producing it vary from constitutional diseases such as gout and malaria to certain articles of diet which act as gastro-intestinal irritants such as pork and shell-fish. It has been known also to follow on mental emotion and is said to be frequent in the neurotic diathesis, but an attack may be set up by any local irritant such as stings or bites. The pathology of the lesions in this disease is as follows: reacting to some irritant, the blood-vessels dilate, serum is poured out from them into the tissues around, and compressing the vessels from without empties them of blood. This explains the white centre of the urticarial weal, the red margin of which is the clinical expression of the dilated and uncompressed vessels at the border. In those diseases grouped together under the name of *erythema*, although the majority of authors place them under the heading of inflammation, there is a good deal suggestive of a close relation to *urticaria*. Some cases are caused by the ingestion of certain drugs, a good many are directly associated with the rheumatic poison, while others are apparently connected with fermentative changes in the gastro-intestinal tract. Thus all these examples of the disease with the cause of which we are approximately acquainted are readily enough attributed to some circulating irritant. This disease differs histologically from *urticaria* in the persistent dilatation of the vessels. Although serum is poured out from them as freely as in *urticaria*, the dilatation of the vessels is so active that they are not compressed as in that disease, while the presence of numerous cells around the vessels seems to suggest a more severe irritant, and the fact that the lesions are clinically more persistent further confirms that suggestion.

When certain irritants are applied to the skin we know beforehand what effects they will produce. Thus croton oil produces a vesicular and pustular eruption, that of cantharides is vesicular or bulbous, while other drugs are followed by results dependent on their concentration, ranging from a mere redness produced by dilute applications to actual death of the skin from concentrated ones. With the milder irritants which produce the results clinically known as *eczema* we have invariably more or less pronounced certain definite phenomena. The blood-vessels dilate; serum is exuded from them—it may be merely into the deeper layers of the skin, or it may reach into and among the epidermic cells, or burst its way through these and appear in drops on the surface. The epithelial cells are, immediately if the irritation be slight, later if it be more severe, stimulated to increased activity of growth and production; and this activity, often misdirected, is so great that the normal process of hardening in the cells is interfered with, and we have what is known as *parakeratosis* (irregular cornification) and the consequent production of scales. Should this be the prominent pathological change, the exudation spends itself among the cells of the scales, and a condition pathologically moist appears to the clinical observer as a dry eruption. Thus according to the reaction—which is presumably largely dependent on the irritant to which it is due—we have various degrees and forms of inflammation of the skin, all of them covered clinically by the term *eczema*. When such a dermatitis is produced experimentally by the application of such an irritant as croton oil we can more or less accurately predict the duration of the inflammation, which gradually becomes less and less and usually terminates in dry scaling. So in *eczema*, as long as the irritant continues to act, so long will its results be evident on the skin. Unfortunately the irritant which is the cause of *eczema* is still a matter of dispute.

In studying other inflammations we have the advantage of definitely knowing their cause. Thus in *impetigo contagiosa* we know, mainly owing to the work of Sabouraud, that the cause of the disease is the streptococcus pyogenes. The first result of inoculation is a minute red spot (dilatation of the vessels), which is rapidly followed by the appearance on the surface of a vesicle or bleb (exudation of serum), which is soon converted into a pustule, the whole dries up into a scab, which when thrown off discloses a healthy or slightly reddened skin. Fresh areas may be constantly attacked.

In *ringworm*, where the cause of the disease is the growth in the

superficial layers of the skin of one or other of the different varieties of fungus grouped together under the common name of ringworm, a reaction more resembling that of *eczema* is produced. There is the same dilatation of the vessel with exudation of fluid, sometimes reaching the surface in the form of vesicles, sometimes spending itself through and among the epidermic cells and only evidenced clinically by the presence of more or less scaling. In other cases the exudation early becomes purulent (this is said to occur regularly when the disease is contracted from the horse), a change which, though occasionally noted, is by no means frequent in *eczema*.

The inflammations of the corium or deeper layer of the skin are due, with very few exceptions, to the growth of well-known organisms. *Erysipelas*, *furuncle*, *anthrax* and *glanders* are diseases which run an acute course and rapidly terminate, the two former usually in recovery, the two latter often fatally. The other more chronic affections all follow one course; in their earlier stages there is a new growth of connective tissue cells in their lowest forms (granuloma), and this later breaks down, either rapidly, as in *syphilis*, or slowly, as in *tuberculosis* and *leprosy*. Most of these diseases leave behind them a well-defined scar.

The new growths of the skin are the same as those found elsewhere. Only two present special characters requiring notice here. *Keloid* is a peculiar form of fibroma which, although benignant as regards any general infection, invariably recurs locally after removal. *Rodent ulcer* is a form of cancer which occurs usually on the face, and whose malignancy is almost entirely local. The class of atrophies of the skin comprises those diseases where the atrophy is primary, and those where it succeeds to previous hypertrophic or inflammatory changes. Anomalies of pigmentation are those of excess and lack. *Chloasma*, in which dark patches appear, most frequently on the face, is usually associated with disease of some internal organ, such as the liver or uterus, being frequently observed in pregnancy. The cause of *vitiligo*, in which the pigment normally present disappears from certain areas, a phenomenon more striking in coloured than in white races, is unknown.

Diseases of the skin tend to manifest themselves in certain parts of the body; i.e. certain diseases exert a selective influence on the sites of their eruption. Symmetry is characteristic of *eczema*, *psoriasis*, drug rashes and the eruptions of specific fevers, while others, such as herpes zoster, ringworm, tertiary syphilis and new growths, tend to be asymmetrical. *Eczema* selects the flexor aspect of the limbs and the neighbourhood of folds of skin and opposed surfaces, while *psoriasis* favours the extensor surfaces and the outer side of the elbows and knees. In certain diseases of nervous origin, notably in herpes zoster, the eruption follows the course of a certain nerve. In the face we get erythema, lupus erythematosus, rosacea, *eczema*, actinomycosis, &c., and syphilitic and malignant ulcers. Rodent ulcer usually selects the face, and generally the nose or orbit. The face too is usually the selective site of lupus vulgaris. The scalp is the chief site of two varieties of lesion—the pustular, as in pustular *eczema* and *impetigo contagiosa*, or the dry and scaly eruptions, as *psoriasis*, ringworm and squamous syphilides. The genital organs are the seat of vesicular eruptions such as herpes or *eczema* or occasionally scabies; they are also the seat of ulcers, chiefly venereal, and of secondary syphilides. Scabies or itch tends to occur on the hands, and the characteristic burrows are noticeable between the fingers. The hands too are subject to various forms of eruption known as *trade eruptions*, due to the handling of paraffin, tar, sugar, salt, lime, sulphur, &c. The lesions mostly simulate *eczema*, and are frequent amongst tanners, dyers, chemists, bakers and washerwomen, and workers in the electro-plating trade. Exposure to the X-rays sets up a form of dermatitis, either an acute erythematous form due to a single prolonged exposure or a chronic form affecting operators who have been exposed over prolonged periods. Ulceration and considerable destruction of the epidermis may take place together with the occurrence of warty growths which tend to become epitheliomatous.

For an account of the treatment of the best known skin diseases see under their separate headings.

SKINNER, JAMES (1778–1841), British military adventurer in India, son of Lieut.-Colonel Hercules Skinner, was born in India in 1778, his mother being a Rajput lady. At the age of eighteen he entered the Mahratta army under de Boigne, where he soon showed military talents; and he remained in the same service under Perron until 1803, when, on the outbreak of the Mahratta War, he refused to serve against his countrymen. He joined Lord Lake, and raised a regiment of irregular horse called "Skinner's Horse" or the "Yellow Boys," which became the most famous regiment of light cavalry in the India of that day. He was present at the siege of Bharatpur, and in 1818 was granted a *jagir* yielding Rs. 20,000 a year, appointed lieutenant-colonel in the British service and made C.B. He had an intimate knowledge of the character of the natives of India, and his advice was highly valued by successive governor-generals and com-

manders-in-chief. He died at Hansi on the 4th of December 1841, and was buried in a church at Delhi which is called after his name.

See J. Baillie Fraser, *Military Memoir of Lieut.-Colonel James Skinner* (1851).

SKINNER, JOHN (1721–1807), Scottish author, son of John Skinner, a parish schoolmaster, was born at Balfour, Aberdeenshire, on the 3rd of October 1721. He had been intended for the Presbyterian ministry, but, after passing through Marischal College, Aberdeen, and teaching for a few years, he took orders in the Episcopal Church, and was appointed to the charge of Longside in 1742. Very soon after Skinner joined the Episcopalians they became, in consequence of the Jacobite rebellion in 1745, a much persecuted remnant. Skinner's church was burnt; his house was plundered; for some years he had to minister to his congregation by stealth; and in 1753 he suffered six months' imprisonment for having officiated to more than four persons besides his own family. After 1760 the penal laws were less strictly enforced, but throughout the century the lot of the Episcopalian ministers in Scotland was far from comfortable, and only the humblest provisions for church services were tolerated. He died at the house of his son, John Skinner, bishop of Aberdeen, on the 16th of June 1807. It is by his few songs that Skinner is generally known. A correspondence took place between him and Burns, who considered his "Tullochgorum" "the best Scotch song Scotland ever saw," and procured his collaboration for Johnson's *Musical Museum*. Other of his lyrics are: "The Monymusk Christmas Ba'ing," a football idyll; "The Ewie wi' the Crookit Horn" and "John o' Badenyon." His best songs had stolen into print; a collection was not published till 1809, under the title of *Amusements of Leisure Hours*. Throughout his life Skinner was a vigorous student, and published in 1788 an *Ecclesiastical History of Scotland* (2 vols.) in the form of letters.

A *Life of Skinner*, in connexion with the history of Episcopacy in the north of Scotland, was published by the Rev. W. Walker in 1883. His songs and poems were edited by H. G. Reid (1859).

SKINNER'S CASE, the name usually given to the celebrated dispute between the House of Lords and the House of Commons over the question of the original jurisdiction of the former house in civil suits. In 1668 a London merchant named Thomas Skinner presented a petition to Charles II. asserting that he could not obtain any redress against the East India Company, which, he asserted, had injured his property. The case was referred to the House of Lords, and Skinner obtained a verdict for £5000. The company complained to the House of Commons which declared that the proceedings in the other House were illegal. The Lords defended their action, and after two conferences between the Houses had produced no result the Commons ordered Skinner to be put in prison on a charge of breach of privilege; to this the Lords replied by fining and imprisoning Sir Samuel Barnardiston, the chairman of the company. Then for about a year the dispute slumbered, but it was renewed in 1669, when Charles II. advised the two Houses to stop all proceedings and to erase all mention of the case from their records. This was done and since this time the House of Lords has tacitly abandoned all claim to original jurisdiction in civil suits.

See Lord Holles, *The Grand Question concerning the Judicature of the House of Peers* (1689); T. P. Taswell-Langmead, *English Constitutional History* (1905); L. O. Pike, *Constitutional History of the House of Lords* (1894); and H. Hallam, *Constitutional History*, vol. iii. (1885).

SKIPPON, PHILIP (d. 1660), English soldier in the Civil Wars, was born at West Lexham, Norfolk. At an early age he adopted the military profession and in 1622 was serving with Sir Horace Vere in the Palatinate. He took part in most of the battles and sieges of the time in the Low Countries. At the sieges of Breda in 1625 and 1637 he was wounded, and under his old commander, Lord Vere, he was present when Bois-le-Duc ('s Hertogenbosch) and Maestricht were attacked in 1629. A veteran of considerable experience, Captain Skippon returned to England in 1639, and was immediately appointed to a command in the (Honourable) Artillery Company. In 1642 the Civil War was fast approaching, and in January Skippon was made

commander of the City troops. He was not present at Edgehill, but he rode up and down the lines of his raw militiamen at Turnham Green, cheering and encouraging them in the face of the king's victorious army. Essex, the Lord General of the Parliament forces, soon made Skippon his major-general, a post which carried with it the command of the foot and the complicated duty of arranging the line of battle. He was with Essex at Gloucester, and at the first battle of Newbury distinguished himself at the head of the infantry. At the end of 1644 the amazing desertion of Essex when his army was surrounded at Lostwithiel left Skippon in command; compelled to surrender without firing a shot, the old soldier bore himself with calmness and fortitude in this adversity. At the second battle of Newbury he and Essex's old foot had the satisfaction of recapturing six of the guns they had lost at Lostwithiel. The appointment as major-general of the New Model Army soon followed, as, apart from his distinguished services, there was scarcely another man in England with the knowledge of detail requisite for the post. In this capacity he supported Fairfax as loyally as he supported Essex, and at Naseby, though dangerously wounded, he would not quit the field. For his conduct on this decisive field the two Houses of Parliament thanked him, and they sent him special physicians to cure him of his wound. It was long before he was fit to serve in the field again. He only reappeared at the siege of Oxford, which he directed. At the end of the war he was selected for the command of the forthcoming Irish expedition, with the rank of marshal-general. The discontent of the soldiery, however, which ended in open mutiny, put an end to a command which Skippon had only accepted under great pressure. He bore a part in all the movements which the army leaders now carried out. A Presbyterian himself, he endeavoured to preserve a middle position between his own sect and the Independents, and to secure by any means a firm treaty with the king. The army outstripped Fairfax and Skippon in action. The major-general was named as one of the king's judges, but, like his chief, did not take his place. During the Commonwealth period he held high office, military and civil, but ceased to influence passing events. He was one of the members of Cromwell's House of Lords, and, in general, was universally respected and beloved. Age and infirmities prevented him from taking any part in the revolutions which culminated in the restoration of the Monarchy, and in March 1660 he died. Skippon was a deeply religious man, and wrote several books of devotion for the use of soldiers. One of his few sayings in Parliament, that on the fanatic Naylor, has become famous: "If this be liberty, God deliver us from such liberty!"

See Vicars, *English Worthies* (1647).

SKIPTON, a market town in the Skipton parliamentary division of the West Riding of Yorkshire, England, 26 m. N.W. of Leeds by the Midland railway, served also by the Lancashire and Yorkshire railway. Pop. of urban district (1901) 11,986. It is picturesquely situated in the hilly district of the upper valley of the river Aire, the course of which is followed by the Leeds and Liverpool canal. The strong castle built by Robert de Romille in the time of the Conqueror was partly demolished in 1648, but was restored by the countess of Pembroke. Of the ancient building of de Romille all that remains is the western doorway of the inner castle. In the castle grounds are the remains of the ancient chapel of St John. The church of the Holy Trinity, mainly Perpendicular, was also partly demolished during the Civil War, but was restored by the countess of Pembroke. The free grammar-school was founded in 1548 by William Ermysted, a canon of St Paul's, London. There are also science and art schools. There are extensive woollen and cotton factories, and, in the neighbourhood, a large limestone quarry.

Skipton was the capital of the ancient district of Craven. At the Norman accession it became part of the possessions of Earl Edwin, and was granted to Robert de Romille. Subsequently it went to the Albemarle family, but was again vested in the Crown, and Edward II. bestowed it on Piers de Gaveston. In 1311 it came into the possession of the Cliffords. The castle

was taken by the parliamentary forces in 1645 after a desultory siege of three years.

SKIRRET, known botanically as *Sium Sisarum* (natural order Umbelliferae), a fleshy-rooted perennial, the roots of which are boiled, and afterwards served up like salsify. It requires a free, deep and much enriched soil, and is generally raised from seeds, which should be sown in drills a foot apart about the end of March, the bed being well-watered in dry weather. The roots will be in use about November, and will continue fresh through the winter if carefully stored.

SKIRVING, ADAM (1719-1803), Scottish song-writer, was born in Haddington in 1719. He became a farmer at Garleton, near Haddington, and died in April 1803. He was buried at Athelstaneford. His reputation rests on two Jacobite ballads on the battle of Prestonpans, one of which, "Hey, Johnnie Cope, are Ye Waking Yet?" has a well-deserved place in most collections of Scottish songs.

SKITTLES (from O. Eng. *sceoten*, to shoot), a game played on the green or an alley with a number of "pins" of wood, which are knocked down by an oval, flattened missile called the *cheese*, about 10 lb in weight, thrown by the player. The game has been in existence for centuries in many countries under different names, *quilles* in France, *Kegelspiel* in Germany, *skayles*, *kails*, *closh*, *cloddyng*, *roly-poly*, *Dutch bowls*, &c., in Great Britain. In early days in England "sheep's joyns" were thrown at the pins, and in many varieties of the game, for instance in the German and Dutch, balls were used, which were rolled along the ground at the pins. As now played, nine large, oval-headed pins are set up in a square, three pins on each side, with a corner angle presented to the player, who stands about 21 ft. from the pins. One step in advance is allowed in delivery. The object is to knock down the greatest number of pins in the fewest throws. In the eastern counties of England four pins only, one on each corner, are generally used. In Dutch skittles the centre pin is called the "king-pin" and often has a crown on its head. The object of this game is to knock down the "king" without touching any of the other pins, or to knock down all the other pins and leave the king. In Germany and Holland balls have always been used, and the game in that form was introduced into America from the latter country early in the 18th century, but is not now played there, being replaced by bowling.

SKOBELEV, MIKHAIL DIMITRIÉVICH (1843-1882), Russian general, was born near Moscow on the 29th of September 1843. After graduating as a staff officer at St Petersburg he was sent to Turkestan in 1868 and, with the exception of an interval of two years, during which he was on the staff of the grand duke Michael in the Caucasus, remained in Central Asia until 1877. He commanded the advanced guard of General Lomakine's column from Kinderly Bay, in the Caspian, to join General Verefkin, from Orenburg, in the expedition to Khiva in 1874, and, after great suffering on the desert march, took a prominent part in the capture of the Khivan capital. Dressed as a Turkoman, he intrepidly explored in a hostile country the route from Khiva to Igdy, and also the old bed of the Oxus. In 1875 he was given an important command in the expedition against Khokand under General Kaufmann, showing great capacity in the action of Makram, where he out-manœuvred a greatly superior force and captured 58 guns, and in a brilliant night attack in the retreat from Andijan, when he routed a large force with a handful of cavalry. He was promoted to be major-general, decorated with the order of St George, and appointed the first governor of Fergana. In the Turkish War of 1877 he seized the bridge over the Sereth at Barborchi in April, and in June crossed the Danube with the 8th corps. He commanded the Caucasian Cossack Brigade in the attack of the Green Hills at the second battle of Plevna. He captured Lovtcha on the 3rd of September, and distinguished himself again in the desperate fighting on the Green Hills in the third battle of Plevna. Promoted to be lieutenant-general, and given the command of the 16th Division, he took part in the investment of Plevna and also in the fight of the 9th of December, when Osman Pasha surrendered, with his army. In January 1878 he crossed the Balkans in a severe snowstorm,

defeating the Turks at Senova, near Schipka, and capturing 36,000 men and 90 guns. Dressed with care in white uniform and mounted on a white horse, and always in the thickest of the fray, he was known and adored by his soldiers as the "White General." He returned to Turkestan after the war, and in 1880 and 1881 further distinguished himself in retrieving the disasters inflicted by the Tekke Turkomans, captured Geok-Tepe, and, after much slaughter, reduced the Akhal-Teke country to submission. He was advancing on Askabad and Kalat i-Nadiri when he was disavowed and recalled. He was given the command at Minsk. In the last years of his short life he engaged actively in politics, and made speeches in Paris and in Moscow in the beginning of 1882 in favour of a militant Panslavism, predicting a desperate strife between Teuton and Slav. He was at once recalled to St Petersburg. He was staying at a Moscow hotel, on his way from Minsk to his estate close by, when he died suddenly of heart disease on the 7th of July 1882.

SKOPTSI (Russian *skopets*, a eunuch), a secret religious sect of Russia. It is an offshoot of the sect known as the "People of God" or *Khlysti* (see *RUSSIA: Religion*). It was in 1771 in the government of Orel that the Skoptsi were first discovered by the authorities. A peasant, Andrei Ivanov, was convicted of having persuaded thirteen other peasants to mutilate themselves. His assistant was another peasant, known as Selivanov. A legal investigation followed. Ivanov was knouted and sent to Siberia; Selivanov fled, but was arrested in 1775. Skoptism, however, increased, and Selivanov escaped from Siberia and proclaimed himself the Son of God incarnate in the person of Peter III. Peter had been popular among the *Raskolniki* (schismatics, or dissidents) because he granted them liberty of conscience, and among the peasants because when pillaging the convents he divided their lands among the labourers. Selivanov claimed the title "God of Gods and King of Kings," and announced his accomplishment of the salvation of believers through a self-inflicted mutilation. For eighteen years he lived in St Petersburg, in the house of one of his disciples, receiving double homage as Christ and tsar. In 1797 he was rearrested by order of Paul I. and imprisoned in a madhouse. Under Alexander I. Selivanov regained his liberty, but in 1820 was again shut up, this time in a monastery at Suzdal, where he died in 1832 in his hundredth year. Skoptism was, however, not exterminated, and grave scandals constantly arose. The most remarkable feature of this extraordinary sect has always been the type of people who joined it. Nobles, military and naval officers, civil servants, priests and merchants were to be found in its ranks, and so rapidly did the numbers increase that 515 men and 240 women were transported to Siberia between 1847 and 1866 without seriously threatening its existence. In 1872 many trials of Skoptsi took place all over Russia. In 1874 the sect numbered at least 5444, including 1465 women. Of these 703 men and 160 women had mutilated themselves. Repressive measures proving useless, an unsuccessful attempt was made to kill the sect by ridicule: Skoptsi were dressed up in women's clothes and paraded with fools' caps on through the villages. In 1876 130 Skoptsi were sentenced in a batch to transportation. To escape prosecution some of the sect have emigrated, generally to Rumania, where they are known as Lipovans. But though the law is strict—every eunuch being compelled to register—Skoptism still continues to hold its own in Russia.

As their title indicates, the main feature of the sect is sexual mutilation. This they call their "baptism of fire." Of this there are two kinds, the "lesser" and "greater seal" (*i.e.* partial and complete mutilation). In this the Skoptsi maintain that they are fulfilling Christ's counsel of perfection in Matt. xix. 12 and xviii. 8, 9. A terrible operation with similar purpose is sometimes performed on the women. The earliest records of such female mutilations date from 1815. Usually the breasts only are amputated. The Skoptsi do not absolutely condemn marriage, and some are allowed to have one child, those at Bucharest two, before being fully admitted. They are not pessimists, desiring the end of the species, but aim rather at the perfection of the individual. Their religious ceremonies include hymn-singing, addresses and frenzied dancing ending in ecstasy, like that of the *Khlysti* and the Mussulman dancing der-vishes. Strict oaths of secrecy are demanded from all members,

who form a kind of mutual-aid association. Meetings are held late at night in cellars, and last till dawn. At these the men wear long, wide, white shirts of a peculiar cut with a girdle and large white trousers. Women also dress in white. Either all present wear white stockings or are barefoot. They call themselves "White Doves." They have a kind of eucharist, at which pieces of bread consecrated by being placed for a while on the monument erected at Schlüsselberg to Selivanov are given the communicants. The society has not always been content with proselytism. Bribes and violence have been often used. Children are bought from poor parents and brought up in the faith. The Skoptsi are millenarians, and look for a Messiah who will establish an empire of the saints, *i.e.* the pure. But the Messiah, they believe, will not come till the Skoptsi number 144,000 (Rev. xiv. 1, 4), and all their efforts are directed to reaching this total. The Skoptsi's favourite trade is that of money-changer, and on 'Change in St Petersburg there was for long a bench known as the "Skoptsi's bench." Of late years there is said to have been a tendency on the part of many Skoptsi to consider their creed fulfilled by chaste living merely.

See Anatole Leroy-Beaulien, *The Empire of the Tsars* (Eng. trans., 1896), vol. iii.; E. Pelikan, *Geschichtlich-medizinische Untersuchungen über das Skopzentum in Russland* (Giessen, 1876); K. K. Grass, *Die geheime heilige Schrift der Skopzen* (Leipzig, 1904) and *Die russischen Sekten* (Leipzig, 1907, &c.).

SKOWHEGAN, a township and the county-seat of Somerset county, Maine, U.S.A., on the Kennebec river, about 39 m. N. of Augusta. Pop. (1890) 5068, (1900) 5180, of whom 4266 were inhabitants of Skowhegan village; (1910) 5341. Skowhegan is the terminus of a branch of the Maine Central railway. The township covers an area of about 50 sq. m., and has a public library, a fine court house and Coburn Park. The farms of the township are devoted largely to dairying. Paper and pulp, wooden-ware, woollen and worsted goods, &c., are manufactured. Skowhegan was settled as a part of Canaan about 1770. In 1814 the township of Bloomfield was erected out of the southern portion of Canaan. In 1823 a second township was erected out of what then remained; this was called Milburn at first, but in 1836 the former Indian name, Skowhegan, said to mean "spearing" or "watching place," was adopted. Bloomfield was annexed to Skowhegan in 1861. The village of Skowhegan was incorporated about 1856.

SKRAM, PEDER (c. 1500–1581), Danish senator and naval hero, born between 1491 and 1503, at his father's estate at Urup near Horsens in Jutland. He first saw service in the Swedish war of Christian II. at the battle of Brannkyrka, 1518, and at the battle of Upsala two years later he saved the life of the Danish standard-bearer. For his services in this war he was rewarded with an estate in Norway, where he settled for a time with his young consort Elsebe Krabbe. During "Grevens Fejde," or "the Count's War," Skram, whose reputation as a sailor was already established, was sent by the Danish government to assist Gustavus Vasa, then in alliance with Christian III. against the partisans of Christian II., to organize the untried Swedish fleet; and Skram seems, for the point is still obscure, to have shared the chief command with the Swedish Admiral Måns Some. Skram greatly hampered the movements of the Hanseatic fleets who fought on the side of Christian II., captured a whole Lübeck squadron off Svendborg, and prevented the revictualling of Copenhagen by Lübeck. But the incurable suspicion of Gustavus I. minimized the successes of the allied fleets throughout 1535. Skram's services were richly rewarded by Christian III., who knighted him at his coronation, made him a senator and endowed him with ample estates. The broad-shouldered, yellow-haired admiral was an out-and-out patriot and greatly contributed as a senator to the victory of the Danish party over the German in the councils of Christian III. In 1555, feeling too infirm to go to sea, he resigned his post of admiral; but when the Scandinavian Seven Years' War broke out seven years later, and the new king, Frederick II., offered Skram the chief command, the old hero did not hesitate a moment. With a large fleet he put to sea in August 1562 and compelled the Swedish admiral, after a successful engagement off the coast of Gotland, to take refuge behind the Skerries. This, however, was his sole achievement, and he was superseded at the end of the year by Herluf Trolle. Skram now retired from active service, but was twice (1565–1568) unsuccessfully besieged by the Swedes in his castle of Laholm, which he and his

wife defended with great intrepidity. His estates in Halland were also repeatedly ravaged by the enemy. Skram died, at an advanced age, at Urup on the 11th of July 1581.

Skram's audacity won for him the nickname of "Denmark's dare-devil," and he contributed perhaps more than any other Dane of his day to destroy the Hanseatic dominion of the Baltic. His humanity was equally remarkable; he often imperilled his life by preventing his crews from plundering.

See Axel Larsen, *Dansk-Norske Heltrethistorier* (Copenhagen, 1893). (R. N. B.)

SKRZYNECKI, JAN ZYGMUNT (1787-1860), Polish general, was born in Galicia in 1787. After completing his education at the university of Lemberg, he entered the Polish Legion formed in the grand duchy of Warsaw, as a common soldier and won his lieutenantcy at the battle of Raszyn in 1809. At the battle of Leipzig he greatly distinguished himself and at Arcis-sur-Aube, in 1814, saved Napoleon from the sudden onslaught of the enemy by sheltering him in the midst of his battalion. On the formation of the kingdom of Poland in 1815 Skrzynecki was put in command of five infantry regiments of the line, and on joining the insurrection of 1830 was entrusted with the organization of the Polish army. After the battle of Grochow, he superseded Prince Radziwill as commander in chief; but avoided all decisive operations as he hoped for the pacific intervention of the powers in favour of Poland. In the beginning of March 1831 he even entered into correspondence with the Russian Field-marshal Diebitsch, who was taken very ill both at Paris and London. When at last Skrzynecki did take the offensive his opportunity was gone, and he committed more than one tactical blunder. At Ostrolenka (26th of May 1831) he showed his usual valour and considerable ability, but after a bloody contest Diebitsch prevailed and Skrzynecki fell back upon Warsaw, where he demanded a reconstruction of the government and his own appointment as dictator. To this the diet would not consent, though it gave Skrzynecki a vote of confidence. But public opinion was now running strongly against him and he was forced on the 10th of August, in his camp at Bolimow, to place his resignation in the hands of his successor, Dembinski. Skrzynecki thereupon joined a guerilla corps and on the 22nd of September took refuge in Austrian territory. Subsequently he resided at Prague, but migrated to Brussels where he was made commander in chief of the Belgian army, an appointment he was forced to resign by the combined and emphatic protest of Russia, Austria and Prussia, in 1839. With the permission of the Austrian government he finally settled at Cracow, where he died in 1860. Skrzynecki was remarkable for his personal courage and made an excellent general of division, but he was unequal to the heavier responsibility of supreme command, and did much harm in that capacity by his irresolution. He wrote *Two Victorious Days* (Pol.) (Warsaw, 1831); and *Mes Erreurs* (Paris, 1835).

See S. J. N. Montalembert *et sa correspondance inédite avec le généralissime Skrzynecki* (Montligeon, 1903); Ignacy Pradzynski, *The last four Polish Commanders* (Pol.) (Posen, 1865). (R. N. B.)

SKUA,¹ the name for a long while given to certain of the *Laridae* (see GULL), birds which sufficiently differ in structure, appearance and habits to justify their separation as a distinct genus, *Stercorarius* (*Lestrus* of some writers), or even subfamily, *Stercorariinae*. Swift of flight, powerfully armed, but above all endowed with extraordinary courage, they pursue their weaker cousins, making the latter disgorge their already swallowed prey, which is nimbly caught before it reaches the water; and this habit, often observed by sailors and fishermen, has made these predatory, and parasitic birds locally known as "Teasers," "Boatswains,"² and from a misconception of their

¹ Thus written by Hoier (*circa* 1604) as that of a Faeroese bird (*hodie* Skúir) an example of which he sent to Clusius (*Exotic. Auc-tarium*, p. 367). The word being thence copied by Willughby has been generally adopted by English authors, and applied by them to all the congeners of the species to which it was originally peculiar.

² This name in seamen's ornithology applies to several other kinds of birds, and, though perhaps first given to those of this group, is nowadays most commonly used for the species of TROPIC-BIRD (*q.v.*), the projecting middle feathers of the tail in each kind being

intent, "Dunghunters." On land, however, whither they resort to breed, they seek food of their own taking, whether small mammals, little birds, insects or berries; but even here their uncommon courage is exhibited, and they will defend their homes and offspring with the utmost spirit against any intruder, repeatedly shooting down on man or dog that invades their haunts, while every bird almost, from an eagle downwards, is repelled by buffets or something worse.

The largest species known is the *Stercorarius catarrhactes* of ornithologists—the "Skooi" or "Bonxie" of the Shetlanders, a bird in size equalling a herring-gull, *Larus argentatus*. The sexes do not differ appreciably in colour, which is of a dark brown, somewhat lighter beneath; but the primaries have at the base a patch of white, visible even when the wings are closed, and forming, when they are spread, a conspicuous band. The bill and feet are black. This is a species of comparatively limited range, breeding only in some two or three localities in the Shetlands, about half a dozen in the Faeroes,³ and hardly more in Iceland. Out of the breeding-season it shows itself in most parts of the North Atlantic, but never seems to stray farther south than Gibraltar or Morocco, and it is therefore a matter of much interest to find the Southern Ocean inhabited by a bird—the "Port Egmont Hen" of Cook's *Voyages*—which so closely resembles the Skua as to have been for a long while regarded as specifically identical with it, but is now usually recognized as distinct under the name of *S. antarcticus*. This bird, characterized by its stout deep bill and want of rufous tint on its lower plumage, has an extensive range, and would seem to exhibit a tendency to further differentiation, since Howard Saunders, in a monograph of the group (*Proc. Zool. Society*, 1876, pp. 317-332), says that it presents three local forms—one occurring from New Zealand to Norfolk Island and past Kerguelen Land to the Cape of Good Hope, another restricted to the Falklands, and the third hitherto only met with near the south-polar ice. On the western coast of South America, making its way into the Straits of Magellan, and passing along the coast so far as Rio Janeiro, is found *S. chilensis*, distinguished among other characters by the cinnamon tint of its lower plumage. Three other smaller species of the genus are known, and each is more widely distributed than those just mentioned, but the home of all is in the more northern parts of the earth, though in winter two of them go very far south, and, crossing the equator, show themselves on the seas that wash the Cape of Good Hope, Australia, New Zealand and Peru. The first of them is *S. pomatorhinus* (often incorrectly spelt *pomarinus*), about the size of a common gull, *Larus canus*, and presenting, irrespective of sex, two very distinct phases of plumage, one almost wholly sooty-brown, the other parti-coloured—dark above and white on the breast, the sides of the neck being of a glossy straw-colour, and the lower part of the neck and the sides of the body barred with brown; but a singular feature in the adults of this species is that the two median tail-feathers, which are elongated, have their shaft twisted towards the tip, so that in flight the lower surfaces of their webs are pressed together vertically, giving the bird the appearance of having a disk attached to its tail. The second and third species so closely resemble each other, except in size, that their distinctness was for many years unperceived, and in consequence their nomenclature is an almost bewildering puzzle. H. Saunders (*loc. cit.*) thinks that the larger of them, which is about the size of a black-headed gull, should stand as *S. crepidatus*, and the smaller as *S. parasiticus*, though the latter name has been generally used for the larger when that is not termed, as it often is, *S. richardsoni*, a name that correctly applies only to whole-coloured examples, for this species too is dimorphic. Even its proper English name⁴ is disputable, but it has been frequently called the Arctic gull or Arctic skua, and it is by far the commonest of the genus in Britain, and perhaps throughout the northern hemisphere. It breeds abundantly on many of the Scottish islands, and in most countries lying to the northward. The nest is generally in long heather, and contains two eggs of a dark olive-colour, suffused with still darker brown patches. Birds of either phase of plumage pair indiscriminately, and the young show by their earliest feathers whether they will prove whole or parti-coloured; but in their immature plumage the upper surface is barred with pale reddish brown. The smallest species, commonly known in English as the long-tailed or Buffon's

generally likened to the marlinespike that is identified with the boatswain's position; but perhaps the authoritative character assumed by both bird and officer originally suggested the name.

³ It has long been subjected to persecution in these islands, a reward being paid for its head. On the other hand, in the Shetlands a fine was exacted for its death, as it was believed to protect the sheep against eagles. Yet for all this it would long ago have been extirpated there, and have ceased to be a British bird in all but name, but for the special protection afforded it by several members of two families (Edmonston and Scott of Melby), long before it was protected by modern legislation.

⁴ It is the "Fasgadair" of the Hebrides, the "Shooi" of the Shetlands, and the "Scouti-allen" of the fishermen on the east coast of Scotland.

skua, is not known to exhibit the remarkable dimorphism to which the two preceding are subject. It breeds abundantly in some seasons on the fells of Lapland, its appearance depending chiefly on the presence of lemmings (*Lemmus norvegicus*), on which it mainly preys. All these three species occasionally visit the southern coasts of Europe in large flocks, but their visitations are highly irregular.

(A. N.)

SKULL, the skeleton of the head, composed of 22 bones, 8 of which form the skeleton of the cranium, 14 that of the face. Except the lower jaw, which is movable, the bones are all firmly united by immovable joints. In the following article it is considered more profitable to treat the skull as a whole than to detail the bones separately, and for this purpose a normal European skull will be studied from in front (*norma facialis*), from above (*norma verticalis*), from the side (*norma lateralis*), from behind (*norma occipitalis*) and from below (*norma basalis*). Afterwards the interior of it will be considered by means of sections.

THE SKULL FROM IN FRONT (*norma facialis*) (see fig. 1). The forehead region is formed by the frontal bone, the two halves of which usually unite in the second year; sometimes, however, they fail to do so and then a suture (*metopic*) may remain to an advanced age. The lower limit of the forehead is formed by the upper margin of the orbit on each side, and by the articulation between the frontal and nasal bones near the mid line. At the junction of the inner and middle third of each supra-orbital margin is the supra-orbital notch for the nerve of that name. Above each supra-orbital margin is an elevation, better marked in adult males, called the supra-ciliary ridge, while between these ridges in the middle line is a slight prominence, the *glabella*. Below the forehead the two *nasal bones* form the skeleton of the upper part of the nose; they articulate with one another in the mid line, but laterally they are joined by a suture to the nasal processes of the maxillae which run up to articulate with the frontal at the internal orbital process, thus forming the inner margin of the orbit.



FIG. 1.

Externally the malar bones (fig. 1, g) articulate with the frontal at the external orbital process and form the lower and outer quadrant of the orbital margin.

The *maxillae* or upper jaws (fig. 1, M) form the greater part of the skeleton of the face; they complete the lower and inner quadrant of the orbit, and below the nasal bones leave the anterior nasal aperture (*apertura pyriformis*) between them, and project slightly at the middle of the lower border of this aperture to form the anterior nasal spine. About a quarter of an inch below the infra-orbital margin and just below the articulation with the malar the *infra-orbital foramen*, for the infra-orbital branch of the fifth nerve, is seen on each side. The lower parts of the maxillae form the *alveolar margin* in which all the upper teeth are set. Laterally each maxilla is prolonged out into a buttress, the *zygomatic process*, which supports the malar bone.

Below the maxillae the *mandible* or lower jaw is seen in perspective (fig. 1, m). The horizontal part or body is in two halves up to the second year, but after that complete bony union takes place, forming the symphysis. Above the body of the mandible is an alveolar margin containing the sockets of the lower teeth, while below, near the mid line, the bone projects forward to a variable extent and so forms the *mental prominence* (fig. 1, o), one of the special characteristics of a human skull. Below the second bicuspid tooth on each side is the *mental foramen* for the exit of the mental branch of the fifth nerve.

The Orbit.—Each orbit is a pyramidal cavity, the base of the pyramid being in front, at the orbital margin, and the apex behind, at the optic foramen, where the optic nerve and ophthalmic artery pass through. The four sides of the pyramid form the roof, floor, inner and outer walls of the orbit. The roof is arched from side to side and is made up of the frontal bone anteriorly, and the lesser wing of the sphenoid posteriorly. The floor is chiefly formed by the maxilla, though the malar forms a little of it in front. There is a groove for the infra-orbital nerve running forward in it, but before the margin of the orbit is reached the groove becomes a tunnel. The inner wall is antero-posterior and parallel with its fellow of the

opposite orbit; in front it is formed by the nasal process of the maxilla, behind which the *lacrimal bone* articulates; together they enclose a vertical groove, for the lacrimal sac, which leads down into the nose, through the *naso-lacrimal canal*, transmitting the nasal duct (see EYE). Behind the lacrimal bone is the *orbital plate of the ethmoid* and in the suture between this and the frontal the *anterior and posterior ethmoidal foramina* are seen. Posteriorly the ethmoid articulates with the sphenoid, while at its lower and hinder part a small piece of the palate bone comes into the orbit. The outer wall of the orbit slopes backward and inward, the two opposite sides therefore converge as they run back. The malar bone, in front, and the great wing of the sphenoid, behind, form this wall. Between the roof and the outer wall there is a slit in the posterior part of the orbit called the *sphenoidal fissure* because it lies between the great and small wings of the sphenoid; it transmits the third, fourth, first division of the fifth and sixth cranial nerves, as well as the ophthalmic vein.

Another slit called the *spheno-maxillary fissure* lies in the line of junction of the outer wall and floor, it leads into the spheno-maxillary and zygomatic fossae and transmits the second division of the fifth nerve and some veins.

THE SKULL FROM ABOVE (*norma verticalis*). When looked at from above the frontal bone is seen forming the anterior part of the vertex and articulating with the two parietals posteriorly by a nearly transverse serrated suture (*coronal suture*). Running back from the middle of this is the median *sagittal suture* extending as far as the lambda on the *norma occipitalis*. The point where the sagittal and coronal sutures join is the *bregma*, the site of the lozenge-shaped *anterior fontanelle* in the infant's skull, but this closes during the second year of life. Small ossicles called *Wormian bones* are often found in the cranial sutures, and one of these (the *interfrontal* or *os anti-epilepticum*) is sometimes found at the bregma. About two-thirds of the way back the sagittal suture becomes less serrated and on each side of it the small *parietal foramen* may be seen. This only transmits a small emissary vein (see VEINS) in the adult, but, as will be seen later, is of considerable morphological interest. As middle life is reached the cranial sutures tend to become obliterated and the bones can no longer be separated; this fusion begins at the places where the sutures are least deeply serrated, and as a rule the sagittal suture disappears between the two parietal foramina between thirty and forty years of age.

THE SKULL FROM THE SIDE (*norma lateralis*). On looking at the accompanying figure (fig. 2) it will be seen that the *calvaria* or brain

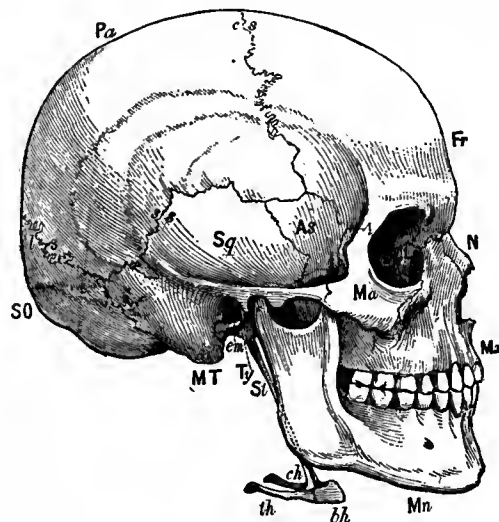

FIG. 2.—Profile of the Skull.

- | | |
|--------------------------|------------------------|
| Fr, Frontal bone. | Mx, Superior maxilla. |
| Pa, Parietal. | Ma, Malar. |
| SO, Supra-occipital. | Mn, Mandible. |
| Sq, Squamous-temporal. | bh, Basi-hyal. |
| MT, Mastoid-temporal. | th, Thyro-hyal. |
| Ty, Tympanic. | ch, Cerato-hyal. |
| St, Styloid-temporal. | em, External meatus. |
| As, Ali-sphenoid. | cs, Coronal suture. |
| E, Os planum of ethmoid. | ls, Lambdoidal suture. |
| L, Lacrymal. | ss, Squamous suture. |
| N, Nasal. | |

case forms all the upper part, while the face is below the anterior half. Taking the calvaria first the side view of the frontal bone (fig. 2, Fr) is seen extending back as far as the coronal suture (cs). Just above Fr is an elevation on each side, the *frontal eminence*, better seen in female than in male skulls. The junction between the frontal and malar (Ma) at the outer margin of the orbit has already been referred to as the external angular process and is an important

landmark for measurements, and from it a curved line (the temporal crest) runs back crossing the coronal suture to reach the parietal bone (Pa, fig. 2); as it runs back this line divides into two. Below the crossing of the temporal crest the coronal suture is less serrated than above, and here it becomes obliterated first. The quadrilateral outline of the parietal bone is seen as well as its articulations; above it touches its fellow of the opposite side; in front, the frontal (Fr); below the great wing of the sphenoid or alisphenoid (As), the squamous part of the temporal or squamosal (Sq) and the mastoid part of the temporal (MT), while behind it articulates with the supra-occipital (SO), through the lambdoid suture (*ls*). All four angles of the parietal are points of special interest; the antero-superior angle or *bregma* has been already noticed, and it will be seen to lie nearly above the ear opening or *external auditory meatus* in the temporal bone (*em*). The antero-inferior angle where the frontal, parietal and alisphenoid meet is the *pterion* and is the site of an occasional Wormian bone (*epipteric*). The posterior superior angle is the lambda and will be better seen on the norma occipitalis, while the posterior inferior angle, where the parietal, supra-occipital, and mastoid temporal bones meet, is known as the *asterion* and marks the lateral sinus within the cranium. A little above and behind the middle of the parietal bone, and just above the superior temporal crest, is the *parietal eminence* where ossification starts. The *squamous part of the temporal bone* overlaps the parietal at the *squamous suture*, while from its lower part the *zygomatic process* projects forward to articulate with the malar. At the root of this process is the *glenoid cavity* where the condyle of the lower jaw articulates, and just behind this the *external auditory meatus* is seen (*em*). Behind this again the mastoid temporal is prolonged down into a nipple-shaped swelling, the *mastoid process* (MT), containing air cells and only found in the adult human skull, while just in front of the external auditory meatus is the *styloid process* (St), connected with the hyoid bone by the stylo-hyoid ligament (dotted). In the side view of the face the nasal and maxillary bones are seen, and from this point of view it will be noticed that just below the nasal aperture the maxillae, where they join, are produced forward into a little spur, the *anterior nasal spine*, which is a purely human characteristic. At the side of the maxilla the *malar or jugal* (Ma) bone is placed, and its lozenge-shaped outline is apparent; it forms the anterior part of the zygomatic arch. When the mandible is disarticulated and removed the posterior part of the maxilla is seen, and behind it the *external pterygoid plate* of the sphenoid. Between these two bones there is a vertical slit-like opening into a cave, the *spheno-maxillary fossa*, which communicates with the orbit through the *spheno-maxillary fissure*, with the nasal cavity through the *spheno-palatine foramen*, with the cranial cavity through the *foramen rotundum*, and with the mouth through the *posterior palatine canal*, as well as having other smaller openings.

The side view of the *mandible* or lower jaw shows the body, already seen from in front, and the ramus projecting up from the back part of it at an angle of from 110° to 120° in the adult. Before the teeth come and after they are lost the angle is greater. The point just above *ch* (fig. 2) is known as the *angle of the jaw*. At the upper part of the ramus are two projections; the most anterior is the *coronoid process* for the attachment of the temporal muscle, while posteriorly is the *condyle* which articulates with the glenoid cavity of the temporal bone.

THE SKULL FROM BEHIND (*norma occipitalis*) (fig. 3). From this point of view the posterior ends of the parietal bones (PP), with the sagittal suture between them, are seen. Below these comes the *supra-occipital bone* (fig. 3, O) separated from them by the *lambdoid suture* which is deeply serrated and a frequent site of Wormian bones. Where the sagittal and lambdoid sutures meet is the *lambda* (L), and here a small Wormian bone is sometimes found, called the *preinter parietal*. In the mid line about a hand's breadth (2½-3 in.) below the lambda is a prominence, the *external occipital protuberance* or *inion*, for the attachment of the *ligamentum nuchae*, while running out on each side from this are the *superior curved lines* which attach muscles of the neck.

THE SKULL FROM BELOW (*norma basalis*) (fig. 4). Starting from in front, the *superior alveolar arcade* with the teeth sockets is seen. This in a European skull approaches a semicircle, but in lower races the sides become more parallel; this is known as a *hypsiloid arcade*. Within the arcade is the *hard palate* formed by the maxillae in front (fig. 4, *m*), and the palate bones (*p*) behind.

At the front of the median suture between the maxillae is the *anterior palatine canal* which, if it is looked into closely, will be seen to lead into four small foramina, two antero-posterior known as *Scarpa's foramina*, for the naso-palatine nerves, and two lateral called *Stensen's foramina* for small arteries and the remains of the mouth opening of Jacobson's organ (see OLFACATORY SYSTEM). In young skulls a suture runs outward from the anterior palatine canal to between the lateral incisor and canine sockets, and sometimes another runs from the same place to between the central and lateral incisor teeth.

At each postero-lateral angle of the palate are the posterior palatine canals for the descending palatine nerves. The posterior margin of the hard palate is a free edge which forms the lower boundary of the *posterior nasal apertures* or *choanae* and attaches the soft palate (see PHARYNX). Behind the alveolar arcade on each side are the *external and internal pterygoid plates* of the sphenoid; the external is a muscular process for the attachment of the pterygoid muscles, while the internal ends below in the hook-like hamular process which is directed backward and outward. Dividing the posterior nasal aperture into two is the vertical hind edge of the *vomer* (*v*), which articulates above with the body of the sphenoid (basi-sphenoid), and just behind this the sphenoid is united by bone with the basioccipital (*b*), though up to twenty years of age there is a synchondrosis (see JOINTS) called the *basilar suture* between them. It is therefore very easy to tell an adult's skull from that of a young person. Passing back in the mid line the *foramen magnum* (*f*) is seen, through which pass the spinal cord and its membranes, the vertebral arteries and the spinal accessory nerves. A little in front of this is a small tubercle, the *pharyngeal spine*, to which the constrictors of the pharynx are attached. On each side of the foramen magnum and in front of its mid transverse diameter are the condyles (*c*), which articulate with the atlas, while just above these are the *anterior condylar foramina*, one on each side, for the exit of the hypoglossal nerves.

External to the pterygoid plates the base of the skull is formed by the ali-sphenoid, which projects backward into a point, the *spine of the sphenoid*, and just in front of this is the small *foramen spinosum* for the passage of the middle meningeal artery. In front and a little internal to the foramen spinosum is a larger opening, the *foramen ovale*, through which the third division of the fifth nerve leaves the skull. Into the re-entering angle between the ali-sphenoid and basi-occipital is fitted the *petrous part of the temporal*, which, however, does not quite fill the gap but leaves a space on each side of the site of the basilar suture to be closed in by fibro-cartilage, and this is known as the *middle lacerated foramen*. On the lower surface of the petrous bone is the round opening of the *carotid canal* through which the internal carotid artery and its accompanying sympathetic nerves pass into the skull, while more externally the *styloid process* projects downward and forward and is more or less ensheathed at its root by the rampart-like ridge of the *vaginal process*. Between the styloid process and the occipital condyle lies the *jugular* or *posterior lacerated foramen* through which pass the lateral and inferior petrosal sinuses, and the glosso-pharyngeal, vagus and spinal accessory nerves. The bone which bounds this foramen behind, and which bears the posterior two-thirds of the occipital condyle, is the *ex-occipital* part of the occipital. A little behind and external to the styloid process is the tip of the mastoid process, just internal to which is the deep antero-posterior groove for the digastric muscle, and internal to that another slighter groove for the occipital artery. Behind the styloid process and between it and the mastoid is the stylo-mastoid foramen through which the facial nerve passes, while in front of the process the glenoid cavity can be seen in its entirety, bounded in front by the *eminencia articularis* and divided into an anterior articular part and a posterior *tympanic plate* by the *Glaserian fissure*. Just internal to the glenoid cavity is the opening of the bony *Eustachian tube*.

The posterior part of the norma basalis behind the foramen magnum is formed by the *supra-occipital* part of the occipital bone, so that all the four parts of the bone, which are separate up to the third year, help in the formation of that large opening. Between the foramen magnum and the external occipital protuberance and superior curved line already noticed, the bone attaches the deep muscles of the neck.

THE INTERIOR OF THE CRANIUM. If the roof of the skull be sawn off the interior or cerebral surface of both the vault and the base

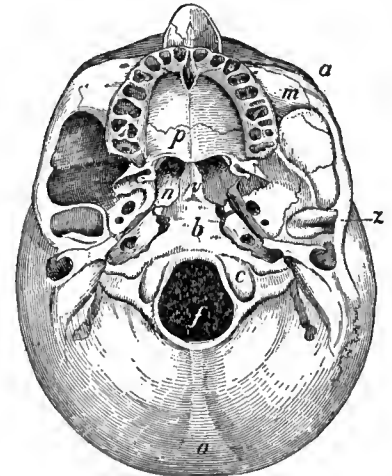

FIG. 4.

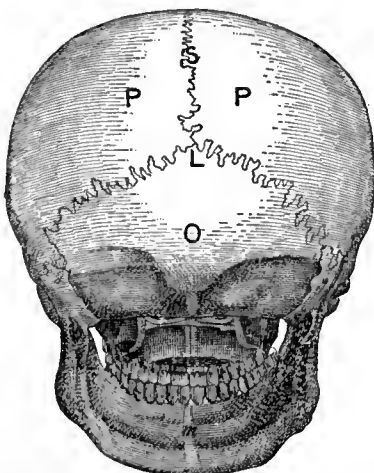

FIG. 3.

may be examined. The vault shows the cerebral aspects of parts of the frontal, parietal and occipital bones, and of the sutures between them. In the mid line is a shallow antero-posterior groove for the superior longitudinal blood sinus, and on each side of this

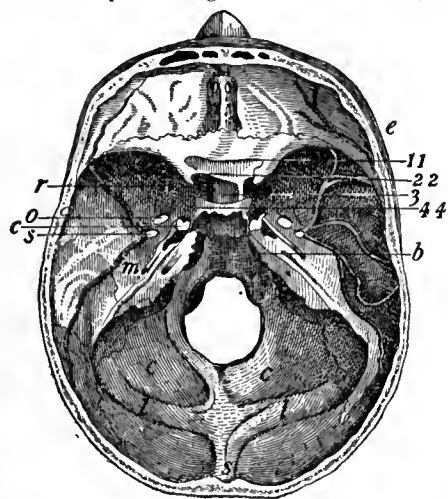

FIG. 5.

irregular depressions are often seen for the Pacchionian bodies (see BRAIN). The *base* (fig. 5) is divided into three fossae, anterior, middle and posterior, each being behind and on a lower level than the one in front of it. The *anterior cranial fossa* is formed by the *cribriform plate of the ethmoid*, near the mid line, freely perforated for the passage of the olfactory nerves. In the mid line, near the front, is a triangular plate rising up which attaches the *falx cerebri* (see BRAIN) and is called the *crista galli*. On each side of this is the *nasal slit* for the nasal branch of the first division of the fifth nerve. On each side of the cribriform plate is the *orbital plate* of the frontal, while the back part of the fossa has for its floor the body of the sphenoid (pre-sphenoid) near the mid line and the lesser wing (*orbito-sphenoid*) on each side. Each lesser wing is prolonged back into a tongue-like process, the *anterior clinoid process*, just internal to which is the *optic foramen* (fig. 5, 11), and the two foramina are joined by the *optic groove* for the optic commissure. Behind this groove is a transverse elevation, the *olivary eminence* (22), which marks the junction of the *pre- and basi-sphenoid* parts of the body of the sphenoid bone.

The *middle cranial fossa* is like an hour-glass placed transversely, as there is a central constricted, and two lateral expanded, parts. The central part forms the *pituitary fossa* (fig. 5, 3) for the pituitary body (see BRAIN) and is bounded behind by the wall-like *dorsum sellae*, at the sides of which are the *posterior clinoid processes* (5, 4). The olivary eminence, pituitary fossa and dorsum sellae together resemble a Turkish saddle and are often called the *sella turcica*. The lateral expanded part of the middle cranial fossa is bounded in front by the great wing of the sphenoid (alisphenoid), behind by the front of the petrous part of the temporal (*petrotic*) and laterally by the squamous part of the temporal (*squamosal*). Between the alisphenoid and orbitosphenoid is the *sphenoidal fissure* already noticed in the orbit, and a little behind this, piercing the alisphenoid, is the posterior opening of the *foramen rotundum*, through which the second division of the fifth nerve passes into the spheno-maxillary fossa. Further back the alisphenoid is pierced by the *foramen ovale* (o) and *foramen spinosum* (s), both of which have been already noticed on the *norma basalis*. From the latter a groove for the middle meningeal artery runs forward and outward, and soon divides into anterior and posterior branches, the former of which deepens into a tunnel near the pterion. At the apex of the petrous bone and at the side of the dorsum sellae is the *middle lacerated foramen* (c), already noticed, and running inward to this from an aperture in the petrous bone is a groove for the great superficial petrosal nerve which is overlaid by the Casserian ganglion of the fifth nerve.

The *posterior cranial fossa* is pentagonal in outline, having an anterior border formed by the dorsum sellae, two antero-lateral borders, by the upper borders of the petrous bones, and two postero-lateral curved borders, by the grooves for the lateral sinuses (fig. 5, 11). In the middle of this fossa is the *foramen magnum*, bounded by the four parts of the occipital bone, which unite during childhood. In front of the foramen magnum the floor of the fossa is formed by the basi-occipital and basi-sphenoid bones, which unite soon after twenty and form a steep slope, downward and backward, known as the *clivus* (b). This is slightly grooved from side to side, and lodges the pons and medulla (see BRAIN) and the basilar artery.

On each side of the basi-occipital the posterior surface of the petrous bone bounds the fossa, and lying over the suture between them is the groove for the inferior petrosal venous sinus which leads backward and outward to the *jugular foramen* already noticed on the *norma basalis*. About the middle of the posterior surface of the petrous bone is the *internal auditory meatus*, through which pass the facial and auditory nerves, the *pars intermedia* (see NERVES, CRANIAL) and the auditory artery. Close to the antero-lateral part of the foramen magnum is the inner opening of the *anterior condylar foramen* which is sometimes double for the two bundles of the hypoglossal nerve, and a little in front of and outside this is a heaping up of bone called the *tuberculum jugulare*, which marks the union of

the basi- and ex-occipital bones. The hindmost limit of the posterior fossa in the mid line is marked by an elevation called the *internal occipital protuberance*, and at this point the grooves for the superior longitudinal (s), and two lateral sinuses (11) join to form the *torcular Herophili* (see VEINS). Running from the internal occipital protuberance toward the foramen magnum in the mid line is the *internal occipital crest*, which attaches the *falx cerebelli* (see BRAIN) and on each side of this is the cerebellar fossa.

From the internal occipital protuberance the two wide grooves for the lateral venous sinuses (11) run nearly horizontally outward till they reach the posterior inferior angles of the parietal bones; here they turn downward with an S-shaped curve, grooving the mastoid portion of the temporal and later on the exoccipital bones, until they reach the jugular foramina. To the edges of the horizontal parts of these grooves, and to the upper edge of the petrous bones the *tentorium cerebelli* is attached.

THE SKULL IN SAGITTAL SECTION. If the skull be sawn down just to the right of the mid line and the left half be looked at, the appearance will be that reproduced in fig. 6. The section of the cranial bones shows that they are formed of an *outer and inner table* of hard bone, while between the two is a layer of cancellous tissue called the *diploe*. In certain places the diploe is invaded by ingrowths from the air passage which separate the two tables and form the air sinuses of the skull, though it is important not to confuse these with the intracranial blood or venous sinuses. In the section under consideration two of these spaces, the *frontal* (fs) and the *sphenoidal* (PS) *air sinuses* are seen. Behind the frontal sinus is the *crista*

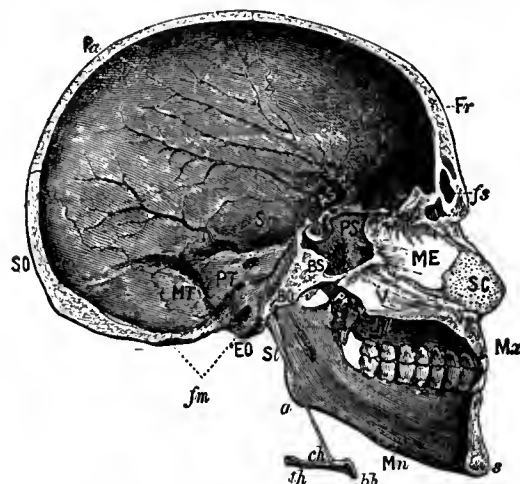

FIG. 6.—Section through the Skull immediately to the right of the Mesial Plane (see also lettering in fig. 2):

- | | |
|--|-------------------------------|
| BO, Basi-occipital. | SC, Septal cartilage of nose. |
| EO, Ex-occipital. | V, Vomer. |
| PT, Petrous-temporal. | Pl, Palate. |
| BS, Basi-sphenoid. | Pt, Pterygoid of sphenoid. |
| PS, Pre-sphenoid (the letters are placed in the sphenoidal sinus). | fs, Frontal sinus. |
| OS, Orbito-sphenoid. | Pf, Pituitary fossa. |
| ME, Mes-ethmoid. | fm, Foramen magnum. |
| | a, Angle. |
| | s, Symphysis of lower jaw. |

galli already mentioned, while below is the bony septum of the nose formed, by the *mes-ethmoid plate* (ME), the *vomer* (V), and the line of junction of the palatine processes of the two maxillae and two palate bones. The re-entering angle between the mes-ethmoid and vomer is filled in the recent state by the septal cartilage (SC).

Below the face is the inner surface of the body and ramus of the *mandible*, and half-way down the latter is the *inferior dental foramen* where the inferior dental branch of the fifth nerve accompanied by its artery passes into the *inferior dental canal* in the substance of the bone to supply the lower teeth. Just in front of this foramen is a little tongue of bone called the *lingula* attaching the *spheno-mandibular* (*long internal lateral*) *ligament*, while running downward and forward from this is the *mylo-hyoid ridge* with the groove of the same name just below it.

If the cut surface of the right half of the skull be looked at, the outer wall of the nasal cavity will be seen with the three turbinated bones each overhanging its own meatus, but the anatomy of this part has already been dealt with in the article on the olfactory system (q.v.).

For further details see any standard anatomical textbook—Quain, Gray, Cunningham, &c. For charm of style, *The Human Skeleton* by G. M. Humphry (London, 1858), although somewhat out of date, is unsurpassed.

Embryology.

The *notochord* (see SKELETON: *Axial*) extends forward to the ventral surface of the middle cerebral vesicle (see BRAIN) or as far

as the place where the dorsum sellae will be. It is partly surrounded by the mesenchyme just as it is completely in the rest of the axial skeleton, and this mesenchyme extends dorsally on each side to wrap round the nerve cord, which is here the brain. In this way the brain becomes enclosed in a primitive membranous cranium, the inner part of which persists in its primitive condition as the dura mater, while the outer part may chondrify, chondrify and ossify, or ossify without a cartilage stage. That part of the cranium which is in front of the notochord is called *prechordal*, while the posterior part into which the notochord extends is *chordal*. On each side of the notochord chondrification takes place and a basicranial plate of cartilage is formed which soon meets its fellow of the opposite side, and forms the floor of the skull as far forward as the dorsum sellae, and as far back as the external occipital protuberance. Laterally it comes in contact with the mesenchyme surrounding the internal ear, which is also chondrifying to form the cartilaginous *periotic capsule*, and the two structures fuse together to form a continuous floor for the back of the skull. A. Froriep has shown that in the hinder occipital region of the calf there are evidences of four vertebrae having been incorporated with the basicranial plate, that is to say that the plate and its coalesced vertebrae represent five mesodermic somites ("Zur Entwicklungsgeschichte der Wirbelsäule, insbesondere des Atlas und Epistropheus und der Occipitalregion," *Archiv für Anat. u. Phys., Anat. Abth.*, 1886). It has more recently been shown by Levi that the same thing is true for man. K. Gegenbauer has pointed out that the primitive membranous skull shows, in the chordal region, signs of metameric segmentation in the way in which the cranial nerves pierce the dura mater one behind the other. These segments, however, had lost their distinctness even before the cartilaginous cranium had become developed, so that there is no real segmental value in the elements of this, still less in those of the bony skull. The only place in which segmental elements can be distinguished is in the occipital region, which is in structure transitional between the head and vertebral column. The notochord, it has been shown, ends just behind the place where the stomodaeum pouches up through the cranial base to form the anterior part of the pituitary body (see BRAIN). Where it ends two curved bars of cartilage are formed, which run forward till they meet the olfactory capsules, which are also now chondrifying. These bars are the *prechordal cartilages* or *trabeculae cranii* and enclose between them the *cranio-pharyngeal canal* by which the pituitary body ascends, but later on, as they grow, they join together and cut off the pituitary body from the pharynx. By their growth outward they form the floor of the prechordal part of the chondro-cranium, so that from them is developed that part of the cartilaginous skull which will later on be part of the basisphenoid, the presphenoid, orbito-sphenoid and alisphenoid regions. It has hitherto been assumed that this process held good for man, but recent research shows that the anterior part of the base of the skull chondrifies in the same way that ice appears on a pond and that the trabeculae are at no time definite structures. Chondrification of the nasal capsules is later than that of the parts of the skull behind, so that there is a steady progress in the process from the occipital to the ethmoidal region. There is a median centre of chondrification, the *mesethmoid cartilage*, which projects down into the fronto-nasal process (see OLFACATORY SYSTEM), and two lateral *ectethmoid cartilages* which eventually join with the mesethmoid to form the cartilaginous ethmoid.

The cartilaginous base of the cranium is now formed, but the vault is membranous. While the base has been developing the two anterior visceral arches have been also forming and have gained an attachment to the cranium, but the formation and fate of these is recorded in the article SKELETON (*Visceral*). About the sixth week of foetal life ossification begins at different points in the membranous vault of the skull. In this way the frontal, parietal, supra-occipital, and a little later the squamous part of the temporal bones are formed. About the eighth week, too, the lachrymal, nasal and vomer appear in the membrane lying superficial to different parts of the olfactory capsule. All these are dermal bones, comparable to the deeper parts of the scales of fishes, and developed in the mesenchyme lying deep to and in contact with the ectoderm. It is therefore

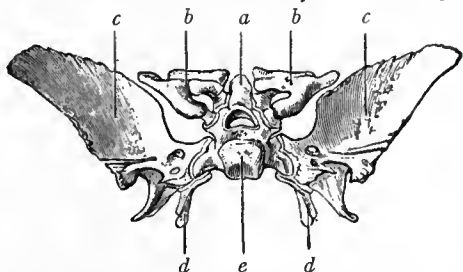

Arthur Thomson, in Cunningham's *Text-Book of Anatomy*.

FIG. 7.—Ossification of Sphenoid.—a, Presphenoid; b, Orbito-sphenoids; c, Alisphenoids; d, Internal pterygoid plates; e, Basisphenoid.

necessary to think of the primitive skull as a three-layered structure, the deepest layer persisting as the dura mater, the middle forming the chondro-cranium, which ossifies to form the base, and a superficial layer close to the skin or mucous membrane (ectoderm), from which the bones of the vault and superficial parts of the olfactory

capsules are derived. At the four angles of the parietal, ossification is checked for some time to form *fontanelles*, of which the *bregma* is the most important, and at each of these points, as well as elsewhere in the sutures, accessory centres of ossification may occur to form *Wormian bones*.

Along the middle line of the base of the skull the same progress of ossification from behind forward is seen that was noticed in the process of chondrification. Bilateral centres for the basioccipital appear about the sixth week, for the basisphenoid in the eighth, and for the presphenoid in the tenth, while the lateral mass of the ethmoid does not ossify till the fifth month and the mesethmoid not until the first year of extra-uterine life. In the lateral part of the base the exoccipitals and alisphenoids begin to ossify about the eighth week and the presphenoids about the tenth. In connexion with the alisphenoid there is a small extra centre of morphological interest only, which forms a little tongue-shaped process called the *lingula*, projecting back into the middle lacerated foramen and apparently corresponding to the *sphenotic* bone of lower vertebrates.

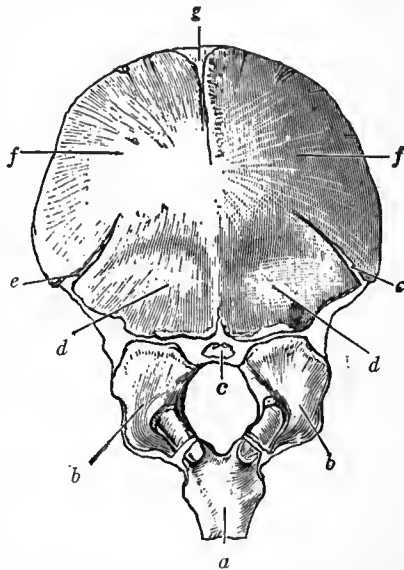

Arthur Thomson, in Cunningham's *Text-Book of Anatomy*.

FIG. 8.—Ossification of Occipital Bone. a, Basilar centre. b, Exoccipital. c, Ossicle of Kerkring. d, Supra-occipital (from cartilage). e, Fissure between supra-occipital and interparietal. f, Interparietal (from membrane). g, Fissure between interparietals.

The auditory or *periotic capsule*, like the olfactory, is late in ossifying; it has four centres (pro-otic, epiotic, opisthotic and pterotic) which do not come until the fifth month.

Some parts of the chondro-cranium do not ossify at all; this is the case in the anterior part of the mesethmoid, which remains as the septal cartilage of the nose, while, as has been already pointed out, a buffer of cartilage persists between the basioccipital and basisphenoid until the twentieth year of life.

From what has been said it is evident, and it will be still more evident if the article SKELETON (*Visceral*) be looked at, that some of the bones of the adult skull are compounded of various contributions from the different elements which make up the adult cranium. These, recapitulated, are (1) the dura mater or entocranium, which in man does not ossify except perhaps in the crista galli. (2) The chondro-cranium or mesocranium. (3) The superficial part of the mesenchyme (ectocranium) from which dermal bones are formed. (4) The olfactory and auditory sense capsules. (5) The visceral arches. (6) Some fused vertebrae posteriorly.

The occipital bone, for example, has the basioccipital, exoccipital and basal part of the supra-occipital derived from the chondro-cranium and fused vertebrae, while the vault part of the supra-occipital has four dermal centres of ossification corresponding to the interparietal and preinterparietal bones of lower mammals (see fig. 4). In the accompanying figure the latter centres have fused with the interparietal, but an indication of their line of junction is seen on each side of g. The bone of Kerkring (c) is an abnormality, the meaning of which is not understood.

The temporal is also a very composite bone; in it the petromastoid portion represents the auditory sense capsule; the tabular

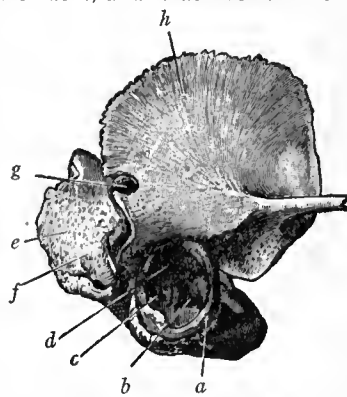

Arthur Thomson, in Cunningham's *Text-Book of Anatomy*.

FIG. 9.—The Outer Surface of the Right Temporal Bone at Birth. a, Tympaniè ring. b, Inner wall of tympanum. c, Fenestra rotunda. d, Foramen ovale. e, Mastoid. f, Mastoid process. g, Masto-squamosal suture, with foramen for transmission of vessels. h, Squamo-zygomatic.

external auditory meatus is formed by the outgrowth of the tympanic ring (fig. 9, a) which is probably part of the first visceral arch (see SKELETON, *Visceral*); the squamozygomatic part is a dermal bone, while the styloid process is a part of the second visceral arch.

The mastoid process is not present at birth, but appears about the second year and becomes pneumatic about puberty. From what has been seen of the skull bones in the above necessarily concentrated and abridged account, it is obvious that they do not correspond to the traces of segmentation as indicated by the cranial nerves, and for this and other reasons the "vertebrate theory of the skull" is no longer believed in.

For further details and references see Quain's *Anatomy* (London, 1908); Cunningham's *Anatomy* (Edinburgh, 1906); *The Development of the Human Body*, J. P. McMurrich (London, 1906).

Comparative Anatomy.

In this section only those parts of the skull which form the covering for the brain and the capsules for the olfactory and auditory apparatus are considered. Those parts of the face and jaws which are developed in connexion with the visceral arches are dealt with in the article SKELETON (*Visceral*). In the Acrania (Amphioxus) the enlarged anterior end of the nerve cord is merely surrounded by fibrous tissue continuous with the sheath of the rest of the nerve cord; there is therefore, in a sense, no true cranium.

In the Cyclostomata (hags and lampreys) a cartilaginous cranium is developed, the anterior part of which forms an unpaired olfactory capsule connected with the rest of the cranium by fibrous tissue only. In the floor, just in front of the anterior end of the notochord, an aperture, the *basi-cranial fontanelle*, remains unchondrified for the passage of the pituitary diverticulum into the skull.

In the Elasmobranchii (sharks and rays) and Holocephali (Chimaera) among the fishes the skull is still a complete cartilaginous box, though calcification of the cartilage often takes place. Taking the skull of the dogfish as a type, two large olfactory capsules are seen in front, and behind these the cranial brain-box is narrowed, being excavated at its sides for the great orbits. More posteriorly the auditory capsules widen the skull, and on the posterior (caudal) aspect the foramen magnum is seen with an occipital condyle on each side of it for the first vertebra to articulate with. On the upper (dorsal) surface of the skull are two apertures in the middle line; the more anterior of these is sometimes called the *anterior fontanelle*, though it has nothing to do with the bregma, described in man's skull, but forms a rudimentary median orbit for the pineal eye (see BRAIN). The posterior fontanelle is a depression which leads into two lateral tubes, each of which passes into the auditory capsule and is known as an *aqueductus vestibuli* (see EAR).

In the cartilaginous ganoid fishes (sturgeon), which, like the elasmobranchs, are of great antiquity, the chondro-cranium is partly ossified so that ali- and orbito-sphenoids are found; in addition to this a large number of dermal bones have made their appearance, such as *nasals*, *frontals*, *parietals*, *supra* and *post temporals*, while in the roof of the mouth and pharynx a long membrane bone, the *parasphenoid*, is formed, and lies ventral to and strengthens the cartilaginous base of the skull. It will be noticed that these fish are important morphological landmarks, because in them the almost unchanged chondro-cranium coexists with a dermal ectocranium.

In the bony ganoids such as the "bow fin" (*Amia*) the dermal bones are still more numerous and, among others, squamosals, prootics and exoccipitals appear. These fish are also remarkable for a fusion of the anterior part of the vertebral column with the occipital region of the skull, an arrangement recalling Froriep's observations on the skull of the calf embryo mentioned in the section on embryology.

In the bony fishes (Teleostei) the membrane or dermal bones are still more numerous, and many of them are unrepresented in the mammalian skull, while others, which are there quite rudimentary, are very large. The chondro-cranium tends to disappear in the vault, but the base is fully ossified. Among other cartilage bones the five ossifications of the auditory capsule are seen, the pro-, epi-, opisth-, pter- and sphen-otics, all of which are found as centres of ossification in man. In the cod, for example, the sphenotic, which is represented in man by the little lingula sphenoidalis, is larger than the alisphenoid.

In the Dipnoi (mud-fish) the chondro-cranium is very slightly ossified, only exoccipitals being found, but there is the same coalescence with anterior vertebrae which was noticed in the ganoids. Dermal bones are plentiful.

In the Amphibia the chondro-cranium persists and is only ossified in front by the girdle bone or sphenethmoid, and behind by the prootics and exoccipitals, the latter of which bear the two condyles. The anterior fontanelle is well marked in the chondro-cranium, but is completely overlaid and concealed by the dermal fronto-parietals. The membrane bones though large are much less numerous than in the bony fishes.

In the Reptilia the skull varies immensely in the different orders, but speaking broadly, the chondro-cranium is less distinct than in

the Amphibia, except in the ethmoidal region. In the base of the skull the basioccipital and basisphenoid are tending to replace the membranous parasphenoid, and instead of two exoccipital condyles only one in the mid line is present, though this in many forms (e.g. *Chelonia*) consists of three parts, a median borne on the basioccipital and two lateral on the exoccipitals. The parietal foramen is usually definitely marked in the dermal part of the skull and forms a median orbit for the pineal eye; this is especially the case in the Lacertilia (lizards). Except in the Ophidia (snakes) and Amphisbaenidae (worm-like lizards) there is a fibro-cartilaginous septum between the orbits so that the cranial cavity does not reach forward to the ethmoidal region. The pro-, epi- and opisth-otic bones are all developed, but the epiotic usually fuses with the supra-occipital and the opisthotic with the exoccipital.

In the Crocodilia the first attempt at pneumaticity is seen in the basisphenoid, which is traversed by a complicated system of Eustachian passages leading eventually to the tympanum. In the class Aves the general scheme of the reptilian skull is maintained, though the bones fuse together very early, thus obliterating the sutures between them. Almost all of them have air in their interior, and so are said to be pneumatic.

The single occipital condyle, if looked at in a young specimen, is seen to consist of a basioccipital and two exoccipital elements, though these are indistinguishable in the adult. The parasphenoid is represented by a broad plate which is called the basitemporal. The pro-, epi- and opisth-otic bones fuse together to form the auditory capsule.

In the Mammalia the calvaria varies considerably in the different orders, the characteristic features being best marked in adult males. Usually the different bones are interlocked by sutures, as in man, until adult life, but in some orders (e.g. Monotremata, Edentata and Carnivora) they fuse together quite early.

In the basicranium the cartilage bones presphenoid, basisphenoid, and basioccipital, are so well developed that the parasphenoid has disappeared. In the basisphenoid of the rabbit the cranio-pharyngeal canal (see section on embryology) persists as a foramen at the bottom of the pituitary fossa. In the lower orders the face lies well in front of the brain case, as it does in reptiles and amphibians, but as the Primates are reached the increasing size of the calvaria causes it to overlie the face. Many of the bones are pneumatic, the process reaching its maximum in the elephant and the adult male gorilla. The petiotic capsule blends with the squamosal and tympanic to form the petrous bone, though it is practically only in man that the second visceral arch ossifies on to this as a styloid process. There are usually two occipital condyles which have basi- and exoccipital elements, though there are many mammals in which there is one large crescentic condyle surrounding the anterior half of the foramen magnum.

Ossification of the processes of the dura mater occurs in the tentorium cerebelli of the carnivora and in the falx cerebri of the ornithorhynchus and porpoise. The orbits are in most mammals continuous with the temporal fossae. Sometimes, as in many of the ungulates and in the lemurs, they are outlined by a bony ring, but it is not until the higher Primates are reached that the two cavities are shut off and even then a vestige of their original continuity remains in the sphenomaxillary fissure.

For further details see W. H. Flower, *Osteology of the Mammalia* (London, 1885); S. H. Reynolds, *The Vertebrate Skeleton* (Cambridge, 1897); R. Wiedersheim; C. Gegenbaur, *Vergleich. Anat. der Wirbelthiere* (Leipzig, 1901). (F. G. P.)

CRANIAL SURGERY

Surgery of the Skull.—Fractures of the vault of the skull may occur without the bone being driven in to compress the brain, and in such cases their existence may be revealed only after death. But if there is also a severe scalp wound the line of fracture may be traced in the bare bone as a thin red crack. "Think lightly," said the old physician, "of no injury to the head." The patient with a suspected fracture of the skull is put to bed in a dark, quiet room, and he is watched. It may be that the crack has extended across a bony groove in which an artery is running, and, the artery being torn, haemorrhage may take place within the skull and the symptoms of compression of the brain may supervene. Experiments upon the lower animals have taught the surgeon how to recognize the exact spot at which the compression is situated. One set of muscles after another being thrown out of work in regular order, he knows exactly where the bleeding is going on, so, having made a hole in the skull by trephining, he turns out the clot and secures the leaking vessel.

Compression of the brain may be the direct and immediate result of a head-injury, a piece of the vault of the skull being driven in, and a local or a general paralysis of muscles being at

once observed. In addition to the muscular paralysis, which may enable the surgeon to localize the spot at which there is pressure upon the brain, there is the grave symptom of coma or insensibility. And, as in deep sleep, there is often loud snoring, due to the vibration of the paralysed soft-palate. The heart being loaded with imperfectly aerated blood, the face is dusky or livid, and the pulse is slow and full. No notice is taken by the man of a loud shout into his ear, and on the surgeon raising his eyelids the pupils are found dilated and fixed, which signifies that the reflex to light is lost—a very grave sign. There may be complete paralysis of one side or of both sides of the body. Not only may the pressure of a blood-clot, an abscess, a foreign body (such as a bullet) or a depressed piece of the skull-wall give rise to coma, but so may a syphilitic, a malignant or an innocent tumour, and in cases in which the administration of iodide of potassium fails to afford relief, the operation of trephining may perhaps be resorted to, as giving the only chance of recovery. As regards treatment—short of trephining—it may be advisable to relieve the heart by bleeding. Inasmuch as the reflex actions are in abeyance, it will be necessary to have the bladder regularly emptied. The man should be placed on his side in bed, so that his tongue may not fall back and choke him, and if it is thought inadvisable to bleed him, a full dose of calomel should be administered.

For the operation of trephining, the head is shaved and the skin rendered aseptic, a large horse-shoe flap is then turned down and the skull laid bare. With an instrument on the principle of a centre-bit, a disk of bone of the size of a florin, a crown or a napkin-ring—or even larger—is then taken out of the skull wall, and the dura mater is opened up if the cause of the compression is beneath it; otherwise, on the disk of bone being removed, the particular condition is dealt with without opening the dura mater. When the clot or the tumour, or whatever it is, has been removed, the disk of bone which, during the operation, has been kept in a warm liquid, is cut up into pieces which are put back into the opening and the skull flap is brought up into its proper position.

Fractures of the base of the skull are always serious, in that they may run across important nerves and large blood-vessels; passing through the roof of the nose, or the ear, they may be compound—that is to say, they may communicate with air-cavities from which pathogenic germs may readily enter the injured tissues. Thus, the dangers of sepsis are added to those of concussion or compression of the brain. Fractures of the base of the skull are often associated with bleeding from the nose, mouth or ear, or with extravasation of blood over the eyeball. Facial paralysis is the result of the line of fracture passing across the bony channel in which the seventh or facial nerve is running. When the fracture passes across the temporal bone and the middle ear, and ruptures the membrane of the tympanum, not only blood may escape from the ear, but an apparently unlimited amount of cerebro-spinal fluid. In all cases the ear should be made surgically clean, and watch and guard kept against the entrance of septic micro-organisms. When the fracture extends through the anterior part of the base of the skull this same clear fluid may escape from the nose. In both cases its appearance implies that the dura mater has been lacerated and the sub-dural space opened.

Concussion of the brain (stunning) may result from a blow upon the head or from a fall from a height. The symptoms may be those of a mere giddiness, and a feeling of stupidity, which may quickly pass off, or they may be those of severe shock (see SHOCK). The person may die from the concussion, or he may slowly or quickly recover. The insensibility may be for a time complete. The pulse may be small, quick and imperceptible, and, no blood being pumped up by the enfeebled heart, the face will be pale and the surface of the body cold. The respiratory movements are likely to be sighing and shallow, or scarcely perceptible. As a rule, the pupils react to light, contracting as the lids are raised. This shows that the light-reflex is not lost, and is a good omen. One of the first signs of returning consciousness is that the person vomits, and after this he gradually comes round.

As a result of the injury, however, he may remain irritable, and liable to severe headaches or to lapses of memory.

Surgery of the Brain.—Abscess of the brain is most likely to be the result of extension inwards of septic inflammation from the middle ear, or of a fracture of the skull which passes across the aural, nasal or pharyngeal air-space, giving the opportunity for the entrance of the germs of suppuration. As the collection of pus forms, persistent headache is complained of together with, perhaps, localized pain or tenderness. A constant feature of intra-cranial pressure, whether the result of tumour or of abscess, is the presence of headache and of vomiting. Later the patient becomes drowsy. On looking into the back of the eyeball by the ophthalmoscope, it is noticed that the optic nerve is congested (“choked”), the result of the increased intra-cranial pressure. The pulse becomes strangely slow, and is apt to drop a beat now and then. The temperature is high. The patient may have attacks of giddiness, and he is subject to fits of an epileptic nature; growing steadily worse, he may be found paralysed on one side, or on both sides, and, becoming insensible, may pass away in the deep sleep known as coma.

The symptoms of tumour of the brain are much like those of abscess, though they come on more slowly and steadily; and inasmuch as the disease is not septic, the temperature may be undisturbed, or but little raised above normal. In the case of the abscess or the tumour being on the left side of the brain, and involving the speech centre (Broca's convolution), the patient becomes aphasic.

Tumours of the brain are likely to be sarcomatous (see CANCER), but they may occur as the result of tuberculous or syphilitic deposit, or of infection by the ova of the dog's tape-worm—hydatid cyst.

In cases of suspected cerebral tumours in which there is even a bare possibility of the patient having been the subject of syphilis, iodide of potassium is prescribed in large doses. Indeed, whilst waiting the development of further symptoms in any obscure case, it is usual to try the effect of this drug, the good influence of which is by no means confined to cases of syphilis. If in spite of the administration of the iodide the symptoms are increasing, the question of opening the skull and exploring the region may arise. Before the days of anaesthetics and of antiseptics such a procedure could scarcely have been considered, but now the operation can be undertaken in suitable cases with a good hope of success.

If the case be one of abscess secondary to disease of the middle ear, the skull will probably be opened in the continuation of the operation by which the septic disease in the temporal bone was cleared away, the aperture having been enlarged by the use of the trephine, gouge or chisel. The side of the head is shaved and rendered aseptic before the operation is begun, and when the dura mater has been incised search is made for pus by the use of a grooved director. Pus having been found, the cavity is treated by gentle irrigation and drainage. When the operation is undertaken for a cerebral tumour the whole of the head is shaved and the skin duly prepared, so that the operation may be carried out with the least possible risk of the occurrence of sepsis. A large horse-shoe incision having been made, the flap of skin and muscle is turned down, and a disk of the skull-wall, about 2 in. in diameter, is removed by a trephine, worked by electricity or by the hand. The thick covering of the brain, the dura mater, is thus exposed, and if the presence of a tumour (or an abscess) has caused an excess of intra-cranial pressure, the membrane will bulge into the opening. The dura mater is then incised and turned down, and if the tumour is upon the cortex of the brain, and not too extensive, it is taken away. It may be necessary, however, to enlarge the opening made in the skull, and to break through a considerable mass of brain-tissue before the tumour can be removed. Bleeding having been arrested by pressure with a firm plug of gauze, a soft drainage tube is introduced and the dura mater is stitched in position. The disk of bone (which, since its removal, has been kept in some salted warm water) may be replaced before the horse-shoe flap is stitched in position, a notch having been cut in its border to allow for the drainage. In some

cases the large horse-shoe flap is so made as to include a part of the bony wall of the skull. The flap of bone is shaped by wire saws and then forcibly broken out by elevators.

The general result of operations for the removal of tumours of the brain is far from being satisfactory. But it must be remembered that without operation the outlook is without hope. Inasmuch as many of the tumours are destitute of a limiting wall, a considerable mass of brain-tissue has to be traversed in order to remove the growth, and the ultimate result, so far as the impairment of functions is concerned, is a serious disappointment. If, however, the tumour is found to be encapsuled, its removal is sometimes quite easily effected, and perfect recovery is then likely to be the result. (E. O.)*

SKUNK (probably derived from "Seecawk," the Cree name for the skunk; another form given is "seganku"), an evil-smelling North American carnivorous mammal. Its existence was first notified to European naturalists in 1636, in Gabriel Sagard-Theodat's *History of Canada*, where, in commencing his account, he describes it as "enfants du diable, que les Hurons appelle Scangaressc, . . . une beste fort puante," &c. This shows in what reputation the skunk was then held, a reputation which has become so notorious that the mere name of skunk is one of opprobrium. The skunks, of whom there are several species, arranged in three genera, are members of the family *Mustelidae* (see CARNIVORA). The common skunk (*Mephitis mephitis*) is a native of North America, extending from Hudson Bay to the middle United States. It is a beautiful animal, about the size of a cat, though of a stouter and heavier build, with rich lustrous black fur, varied on the back by a patch or streak of white. The muzzle is long and pointed, the eyes are sharp and bead-like, and the grey or white tail is long and unusually bushy. The premolars number $\frac{3}{2}$.

The following account of the skunk is extracted from Dr C. H. Merriam's *Mammals of the Adirondack Region*, New York, 1884:

"The skunk preys upon mice, salamanders, frogs and the eggs of birds that nest on or within reach from the ground. At times he eats carrion, and if he chances to stumble upon a hen's nest the eggs are liable to suffer; and once in a while he acquires the evil habit of robbing the hen-roost, but as a rule skunks are not addicted to this vice. Of all our native mammals perhaps no one is so universally abused and has so many unpleasant things said about it as the innocent subject of the present biography; and yet no other species is half so valuable to the farmer. Pre-eminently an insect-eater, he destroys more beetles, grasshoppers and the like than all our other mammals together, and in addition to these he devours vast numbers of mice.

"He does not evince that dread of man that is so manifest in the vast majority of our mammals, and when met during any of his circambulations rarely thinks of running away. He is slow in movement and deliberate in action and does not often hurry himself in whatever he does. His ordinary gait is a measured walk, but when pressed for time he breaks into a low shuffling gallop. It is hard to intimidate a skunk, but when once really frightened he manages to get over the ground at a very fair pace. Skunks remain active throughout the greater part of the year in this region, and hibernate only during the severest portion of the winter. They differ from most of our hibernating mammals in that the inactive period is apparently dependent solely on the temperature, while the mere amount of snow has no influence whatever upon their movements.

"Skunks have large families, from six to ten young being commonly raised each season; and as a rule they all live in the same hole until the following spring."

The overpowering odour which has brought the skunk into such notoriety arises from the secretion of the anal glands. These glands, although present in all *Mustelidae*, are especially developed in skunks, but are so entirely under control that at ordinary times these animals are cleanly and free from smell. Similar glands are possessed by nearly all Carnivora, but in the skunks are enormously enlarged, and provided with thick muscular coats. The secretion—often propelled by the muscles surrounding to a distance of from 8 to 12 ft.—is a clear yellowish liquid, with a marvellously penetrating ammoniacal and nauseous smell. Dr Merriam writes, "I have known the scent to become strikingly apparent in every part of a well-closed house, in winter, within five minutes after a skunk had been killed at a distance of more than a hundred yards," and under favourable conditions

it may be perceived at a distance of more than a mile. Instances are also on record of persons having become unconscious after inhaling the smell.

The long-tailed skunk (*M. macrura*), a native of central and southern Mexico, differs from the typical species by having two white stripes along its sides, and by its longer and bushier tail. The little striped skunk (*Spilogale putorius*), found in the southern United States, and ranging southwards to Yucatan and Guatemala, is smaller than *M. mephitis*, and marked with four interrupted longitudinal white stripes on a black ground. There are likewise differences in the skull; and this species is also distinguished from other skunks by its arboreal habits.

The conepatl (*Conepatus mapurito*) represents a third genus, with several species, confined to tropical and South America. In this group there is one pair less of premolars (p. $\frac{3}{2}$); the build is heavier than in *Mephitis*; the snout and head are more pig-like, and the nostrils open downwards and forwards instead of laterally on the sides of the muzzle. (O. T.; R. L.)*

SKY (M. Eng. *skie*, cloud; O. Eng. *skua*, shade; connected with an Indo-European root *sku*, cover, whence "scum," Lat. *obscurus*, dark, &c.), the apparent covering of the atmosphere, the overarching heaven.

The Colour of the Sky.—It is a matter of common observation that the blue of the sky is highly variable, even on days that are free from clouds. The colour usually deepens toward the zenith and also with the elevation of the observer. It is evident that the normal blue is more or less diluted with extraneous white light, having its origin in reflections from the grosser particles of foreign matter with which the air is usually charged. Closely associated with the colour is the *polarization* of the light from the sky. This takes place in a plane passing through the sun, and attains a maximum about 90° therefrom. Under favourable conditions more than half the light is polarized.

As to the origin of the normal blue, very discrepant views have been held. Some writers, even of good reputation, have held that the blue is the true body colour of the air, or of some ingredient in it such as ozone. It is a sufficient answer to remark that on this theory the blue would reach its maximum development in the colour of the setting sun. It should be evident that what we have first to explain is the fact that we receive any light from the sky at all. Were the atmosphere non-existent or absolutely transparent, the sky would necessarily be black. There must be something capable of *reflecting* light in the wider sense of that term.

A theory that has received much support in the past attributes the reflections to thin bubbles of water, similar to soap-bubbles, in which form vapour was supposed to condense. According to it, sky blue would be the blue of the first order in Newton's scale. The theory was developed by R. Clausius (*Pogg. Ann.* vols. 72, 76, 88), who regarded it as meeting the requirements of the case. It must be noticed, however, that the angle of maximum polarization would be about 76° instead of 90° .

Apart from the difficulty of seeing how the bubbles could arise, there is a formidable objection, mentioned by E. W. Brücke (*Pogg. Ann.* 88, 363), that the blue of the sky is a much richer colour than the blue of the first order. Brücke also brought forward an experiment of great importance, in which he showed that gum mastic, precipitated from an alcoholic solution poured into a large quantity of water, scatters light of a blue tint. He remarks that it is impossible to suppose that the particles of mastic are in the form of bubbles. Another point of great importance is well brought out in the experiments of John Tyndall (*Phil. Mag.* (4), 137, 388) upon clouds precipitated by the chemical action of light. Whenever the particles are sufficiently fine, the light emitted laterally is blue in colour and, in a direction perpendicular to the incident beam, is *completely polarized*.

About the colour there can be no *prima facie* difficulty; for, as soon as the question is raised, it is seen that the standard of linear dimension, with reference to which the particles are called small, is the wave-length of light, and that a given set of particles would (on any conceivable view as to their mode of action)

produce a continually increasing disturbance as we pass along the spectrum towards the more refrangible end.

On the other hand, that the direction of complete polarization should be independent of the refracting power of the matter composing the cloud has been considered mysterious. Of course, on the theory of thin plates, this direction would be determined by Brewster's law; but, if the particles of foreign matter are small in all their dimensions, the circumstances are materially different from those under which Brewster's law is applicable.

The investigation of this question upon the elastic solid theory will depend upon how we suppose the solid to vary from one optical medium to another. The slower propagation of light in gas or water than in air or vacuum may be attributed to a greater density, or to a less rigidity, in the former case; or we may adopt the more complicated supposition that both these quantities vary, subject only to the condition which restricts the ratio of velocities to equality with the known refractive index. It will presently appear that the original hypothesis of Fresnel, that the rigidity remains the same in both media, is the only one that can be reconciled with the facts; and we will therefore investigate upon this basis the nature of the secondary waves dispersed by small particles.

Conceive a beam of plane polarized light to move among a number of particles, all small compared with any of the wave-lengths. According to our hypothesis, the foreign matter may be supposed to *load* the aether, so as to increase its *inertia* without altering its resistance to distortion. If the particles were away, the wave would pass on unbroken and no light would be emitted laterally. Even with the particles retarding the motion of the aether, the same will be true if, to counterbalance the increased inertia, suitable forces are caused to act on the aether at all points where the inertia is altered. These forces have the same period and direction as the undisturbed luminous vibrations themselves. The light actually emitted laterally is thus the same as would be caused by forces exactly the opposite of these acting on the medium otherwise free from disturbance, and it only remains to see what the effect of such force would be.

On account of the smallness of the particles, the forces acting throughout the volume of any individual particle are all of the same intensity and direction, and may be considered as a whole. The determination of the motion in the aether, due to the action of a periodic force at a given point, is discussed in the article DIFFRACTION OF LIGHT (§ 11). Before applying the solution to a mathematical investigation of the present question, it may be well to consider the matter for a few moments from a more general point of view.

In the first place, there is necessarily a complete symmetry round the direction of the force. The disturbance, consisting of transverse vibrations, is propagated outwards in all directions from the centre; and, in consequence of the symmetry, the direction of vibration in any ray lies in the plane containing the ray and the axis of symmetry; that is to say, the direction of vibration in the scattered or diffracted ray makes with the direction of vibration in the incident or primary ray the least possible angle. The symmetry also requires that the intensity of the scattered light should vanish for the ray which would be propagated along the axis; for there is nothing to distinguish one direction transverse to the ray from another. The application of this is obvious. Suppose, for distinctness of statement, that the primary ray is vertical, and that the plane of vibration is that of the meridian. The intensity of the light scattered by a small particle is constant, and a maximum, for rays which lie in the vertical plane running east and west, while there is *no scattered ray along the north and south line*. If the primary ray is unpolarized, the light scattered north and south is entirely due to that component which vibrates east and west, and is therefore *perfectly polarized*, the direction of its vibration being also east and west. Similarly any other ray scattered horizontally is perfectly polarized, and the vibration is performed in the horizontal plane. In other directions the polarization becomes less and less complete as we approach the vertical.

The observed facts as to polarization are thus readily explained,

and the general law connecting the intensity, of the scattered light with the wave-length follows almost as easily from considerations of *dimensions*.

The object is to compare the intensities of the incident and scattered light, for these will clearly be proportional. The number (*i*) expressing the ratio of the two amplitudes is a function of the following quantities:—(T) the volume of the disturbing particle; (*r*) the distance of the point under consideration from it; (λ) the wave-length; (*b*) the velocity of propagation of light; (D) and (D') the original and altered densities: of which the first three depend only upon space, the fourth on space and time, while the fifth and sixth introduce the consideration of mass. Other elements of the problem there are none, except mere numbers and angles, which do not depend upon the fundamental measurements of space, time and mass. Since the ratio (*i*), whose expression we seek, is of no dimensions in mass, it follows at once that D and D' occur only under the form D : D', which is a simple number and may therefore be disregarded. It remains to find how *i* varies with T, *r*, λ , *b*.

Now, of these quantities, *b* is the only one depending on time; and therefore, as *i* is of no dimensions in time, *b* cannot occur in its expression. Moreover, since the same amount of energy is propagated across all spheres concentric with the particle, we recognize that *i* varies as *r*. It is equally evident that *i* varies as T, and therefore that it must be proportional to T/ λr , T being of three dimensions in space. In passing from one part of the spectrum to another, λ is the only quantity which varies, and we have the important law:—

When light is scattered by particles which are very small compared with any of the wave-lengths, the ratio of the amplitudes of the vibrations of the scattered and incident lights varies inversely as the square of the wave-length, and the ratio of *intensities* as the inverse fourth power.

The light scattered from small particles is of a much richer blue than the blue of the first order as reflected from a very thin plate. From the general theory (see INTERFERENCE OF LIGHT, § 8), or by the method of dimensions, it is easy to prove that in the latter case the intensity varies as λ^{-2} , instead of λ^{-4} .

The principle of energy makes it clear that the light emitted laterally is not a new creation, but only diverted from the main stream. If I represent the intensity of the primary light after traversing a thickness *x* of the turbid medium, we have

$$dI = -hI\lambda^{-4}dx,$$

where *h* is a constant independent of λ . On integration,

$$\log(I/I_0) = -h\lambda^{-4}x \quad \dots \quad (1)$$

if I_0 correspond to $x=0$,—a law altogether similar to that of absorption, and showing how the light tends to become yellow and finally red as the thickness of the medium increases (*Phil. Mag.*, 1871, 41, pp. 107, 274).

Sir William Abney has found that the above law agrees remarkably well with his observations on the transmission of light through water in which particles of mastic are suspended (*Proc. Roy. Soc.*, 1886).

We may now investigate the mathematical expression for the disturbance propagated in any direction from a small particle upon which a beam of light strikes. Let the particle be at the origin of coordinates, and let the expression for the primary vibration be

$$\zeta = \sin(nt - kx) \quad \dots \quad (2)$$

The acceleration of the element at the origin is $-n^2 \sin nt$; so that the force which would have to be applied to the parts where the density is D' (instead of D), in order that the waves might pass on undisturbed, is, per unit of volume,

$$(D' - D)n^2 \sin nt.$$

To obtain the total force which must be supposed to act, the factor T (representing the volume of the particle) must be introduced. The opposite of this, conceived to act at the origin, would give the same disturbance as is actually caused by the presence of the particle. Thus by equation (18) of § 11 of the article DIFFRACTION OF LIGHT, the secondary disturbance is expressed by

$$\begin{aligned} \zeta &= \frac{D' - D}{D} \frac{n^2 T \sin \phi \sin (nt - kr)}{4\pi b^2 r} \\ &= \frac{D' - D}{D} \frac{\pi T \sin \phi}{\lambda^2 r} \sin (nt - kr) \quad \dots \quad (3)^1, \end{aligned}$$

The preceding investigation is based upon the assumption that in passing from one medium to another the rigidity of the aether does not change. If we forego this assumption, the question is

¹ In strictness the force must be supposed to act upon the medium in its actual condition, whereas in (18), previously cited, the medium is supposed to be absolutely uniform. It is not difficult to prove that (3) remains unaltered, when this circumstance is taken into account; and it is evident in any case that a correction would depend upon the square of (D' - D).

necessarily more complicated; but, on the supposition that the changes of rigidity (ΔN) and of density (ΔD) are relatively small, the results are fairly simple. If the primary wave be represented by

$$\zeta = e^{-ikx} \dots \dots \dots (4)$$

the component rotations in the secondary wave are

$$\left. \begin{aligned} \tilde{\omega}_3 &= P \left(-\frac{\Delta N}{N} \frac{yz}{r^2} \right), \\ \tilde{\omega}_1 &= P \left(\frac{\Delta D}{D} \frac{y}{r} + \frac{\Delta N}{N} \frac{xy}{r^2} \right), \\ \tilde{\omega}_2 &= P \left(-\frac{\Delta D}{D} \frac{x}{r} + \frac{\Delta N}{N} \frac{z^2 - x^2}{r^2} \right) \end{aligned} \right\} \dots \dots (5)$$

where

$$P = \frac{ik^3 T}{4\pi} \frac{e^{-ikr}}{r} \dots \dots \dots (6)$$

The expression for the resultant rotation in the general case would be rather complicated, and is not needed for our purpose. It is easily seen to be about an axis perpendicular to the scattered ray (x, y, z), inasmuch as

$$x\tilde{\omega}_1 + y\tilde{\omega}_2 + z\tilde{\omega}_3 = 0.$$

Let us consider the more special case of a ray scattered normally to the incident ray, so that $x=0$. We have

$$\tilde{\omega}^2 = \tilde{\omega}_1^2 + \tilde{\omega}_2^2 + \tilde{\omega}_3^2 = P^2 \left(\frac{\Delta N}{N} \right)^2 \frac{z^2}{r^2} + P^2 \left(\frac{\Delta D}{D} \right)^2 \frac{y^2}{r^2} \dots (7).$$

If $\Delta N, \Delta D$ be both finite, we learn from (7) that there is no direction perpendicular to the primary (polarized) ray in which the secondary light vanishes. Now experiment tells us plainly that there is such a direction, and therefore we are driven to the conclusion that either ΔN or ΔD must vanish.

The consequences of supposing ΔN to be zero have already been traced. They agree very well with experiment, and require us to suppose that the vibrations are perpendicular to the plane of polarization. So far as (7) is concerned the alternative supposition that ΔD vanishes would answer equally well, if we suppose the vibrations to be executed in the plane of polarization; but let us now revert to (5), which gives

$$\tilde{\omega}_3 = -\frac{PAN}{N} \frac{yz}{r^2}, \quad \tilde{\omega}_1 = +\frac{PAN}{N} \frac{xy}{r^2}, \quad \tilde{\omega}_2 = +\frac{PAN}{N} \frac{z^2 - x^2}{r^2} \dots (8)$$

According to these equations there would be, in all, six directions from O along which there is no scattered light,—two along the axis of y normal to the original ray, and four ($y=0, z=\pm x$) at angles of 45° with that ray. So long as the particles are small no such vanishing of light in oblique directions is observed, and we are thus led to the conclusion that the hypothesis of a finite ΔN and of vibrations in the plane of polarization cannot be reconciled with the facts. No form of the elastic solid theory is admissible except that in which the vibrations are supposed to be perpendicular to the plane of polarization, and the difference between one medium and another to be a difference of density only (*Phil. Mag.*, 1871, 41, p. 447).

It is of interest to pursue the applications of equation (3) so as to connect the intensity of the scattered and transmitted light with the number and size of the particles (see *Phil. Mag.*, 1899, 47, p. 375). In order to find the whole emission of energy from one particle (T), we have to integrate the square of (3) over the surface of a sphere of radius r . The element of area being $2\pi r^2 \sin \phi d\phi$, we have

$$\int_0^\pi \frac{\pi \sin^2 \phi}{r^2} 2\pi r^2 \sin^2 \phi d\phi = \frac{8\pi}{3},$$

so that the energy emitted from T is represented by

$$\frac{8\pi^3}{3} \frac{(D' - D)^2 T^2}{D^2 \lambda^4} \dots \dots \dots (9)$$

on such a scale that the energy of the primary wave is unity per unit of wave-front area.

The above relates to a single particle. If there be n similar particles per unit volume, the energy emitted from a stratum of thickness dx and of unit area is found from (9) by the introduction of the factor ndx . Since there is no waste of energy upon the whole, this represents the loss of energy in the primary wave. Accordingly, if E be the energy of the primary wave,

$$\frac{1}{E} \frac{dE}{dx} = -\frac{8\pi^2 n}{3} \frac{(D' - D)^2 T^2}{D^2 \lambda^4} \dots \dots \dots (10)$$

whence

$$E = E_0 e^{-hx} \dots \dots \dots (11)$$

where

$$h = \frac{8\pi^2 n}{3} \frac{(D' - D)^2 T^2}{D^2 \lambda^4} \dots \dots \dots (12)$$

If we had a sufficiently complete expression for the scattered light, we might investigate (12) somewhat more directly by considering the

resultant of the primary vibration and of the secondary vibrations which travel in the same direction. If, however, we apply this process to (3), we find that it fails to lead us to (12), though it furnishes another result of interest. The combination of the secondary waves which travel in the direction in question have this peculiarity: that the phases are no more distributed at random. The intensity of the secondary light is no longer to be arrived at by addition of individual intensities, but must be calculated with consideration of the particular phases involved. If we consider a number of particles which all lie upon a primary ray, we see that the phases of the secondary vibrations which issue along this line are all the same.

The actual calculation follows a similar course to that by which Huygens's conception of the resolution of a wave into components corresponding to the various parts of the wave-front is usually verified (see DIFFRACTION OF LIGHT). Consider the particles which occupy a thin stratum dx perpendicular to the primary ray x . Let AP (fig. 1) be this stratum, and O the point where the vibration is to be estimated. If $AP = \rho$, the element of volume is $dx 2\pi \rho d\rho$, and the number of particles to be found in it is deduced by the introduction of the factor n . Moreover, if $OP = r$, and $AO = x$, then $r^2 = x^2 + \rho^2$, and $\rho d\rho = r dr$.

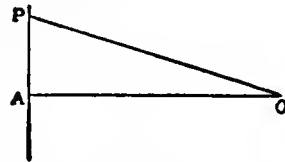

FIG. 1.

The resultant at O of all the secondary vibrations which issue from the stratum dx is by (3), with $\sin \phi$ equal to unity,

$$ndx \int_x^\infty \frac{D' - D}{D} \frac{\pi T}{r \lambda^3} \cos \frac{2\pi}{\lambda} (bt - r) 2\pi r dr,$$

or

$$ndx \frac{D' - D}{D} \frac{\pi T}{\lambda} \sin \frac{2\pi}{\lambda} (bt - x) \dots \dots (13)$$

To this is to be added the expression for the primary wave itself, supposed to advance undisturbed, viz. $\cos(2\pi/\lambda)(bt - x)$, and the resultant will then represent the whole actual disturbance at O as modified by the particles in the stratum dx .

It appears, therefore, that to the order of approximation afforded by (3), the effect of the particles in dx is to modify the phase, but not the intensity, of the light which passes them. If this be represented by

$$\cos \frac{2\pi}{\lambda} (bt - x - \delta), \dots \dots \dots (14)$$

δ is the retardation due to the particles, and we have

$$\delta = nT dx (D' - D) / 2D \dots \dots \dots (15)$$

If μ be the refractive index of the medium as modified by the particles, that of the original medium being taken as unity, then $\delta = (\mu - 1) dx$, and

$$\mu - 1 = nT (D' - D) / 2D \dots \dots \dots (16)$$

If μ' denote the refractive index of the material composing the particles regarded as continuous, $D'/D = \mu'^2$, and

$$\mu - 1 = \frac{1}{2} nT (\mu'^2 - 1), \dots \dots \dots (17)$$

reducing to

$$\mu - 1 = nT (\mu' - 1), \dots \dots \dots (18)$$

in the case when $(\mu' - 1)$ can be regarded as small.

It is only in the latter case that the formulae of the elastic solid theory are applicable to light. On the electric theory, now generally accepted, the results are more complicated, in that when $(\mu' - 1)$ is not small, the scattered ray depends upon the shape and not merely upon the volume of the small obstacle. In the case of spheres, we are to replace $(D' - D)/D$ by $3(K' - K)/(K' + 2K)$, where K, K' are the dielectric constants proper to the medium and to the obstacle respectively (*Phil. Mag.*, 1881, 12, p. 98); so that instead of (17)

$$\mu - 1 = \frac{3nT}{12} \frac{\mu'^2 - 1}{\mu'^2 + 1} \dots \dots \dots (19)$$

On the same suppositions (12) is replaced by

$$h = 24\pi^2 n \left(\frac{\mu'^2 - 1}{\mu'^2 + 1} \right)^2 \frac{T^2}{\lambda^4} \dots \dots \dots (20)$$

On either theory

$$h = 32\pi^3 (\mu - 1)^2 / 3n\lambda^4, \dots \dots \dots (21)$$

a formula giving the coefficient of transmission in terms of the refraction, and of the number of particles per unit volume. As Lord Kelvin has shown (*Baltimore Lectures*, p. 304, 1904) (16) may also be obtained by the consideration of the mean density of the altered medium.

Let us now imagine what degree of transparency of air is admitted by its molecular constituents, viz. in the absence of all foreign

matter. We may take $\lambda = 6 \times 10^{-5}$ cms., $\mu - 1 = 0.0003$; whence from (21) we obtain as the distance x , equal to $1/h$, which light must travel in order to undergo alteration in the ratio $e : 1$,

$$x = 4.4 \times 10^{-13} \times n. \quad (22)$$

The completion of the calculation requires a knowledge of the value of n , the number of molecules in unit volume under standard conditions, which, according to Avogadro's law, is the same for all gases. Maxwell estimated 1.9×10^{19} , but modern work suggests a higher number, such as 4.3×10^{19} (H. A. Wilson, *Phil. Mag.*, 1903; see A. Schuster, *Theory of Optics*, § 178). If we substitute the latter value in (22) we find $x = 19 \times 10^6$ cm. = 190 kilometres.

Although Mount Everest appears fairly bright at 100 miles' distance, as seen from the neighbourhood of Darjeeling, we cannot suppose that the atmosphere is as transparent as is implied in the above numbers; and, of course, this is not to be expected, since there is certainly suspended matter to be reckoned with. Perhaps the best data for a comparison are those afforded by the varying brightness of stars at different altitudes. P. Bouguer and others estimate about 0.8 for the transmission of light through the entire atmosphere from a star in the zenith. This corresponds to 8.3 kilometres of air at standard pressure. At this rate the transmission through 190 kilometres would be $(.8)^{23}$ or 0.006 in place of e^{-1} or 0.37. Or again if we inquire what, according to (21), would be the transmission through 8.3 kilometres, we find $1 - 0.044 = 0.956$.

The general conclusion would appear to be that, while as seen from the earth's surface much of the light from the sky is due to comparatively gross suspended matter, yet an appreciable proportion is attributable to the molecules of air themselves, and that at high elevations where the blue is purer, the latter part may become predominant.

For a further discussion founded upon the observations of Q. Majorana and A. Sella, reference may be made to Lord Kelvin's *Baltimore Lectures*, p. 317, where a higher estimate of the value of n is favoured. It may be remarked that it is only the constant part of sky-light that can be due to detached molecules. Ordinary observation of the landscape shows that there is another part, highly variable from day to day, and due to suspended matter, much of which is fine enough to scatter light of blue quality.

The experiments of Tyndall upon precipitated clouds have been already referred to. So long as the precipitated particles are very fine, the light dispersed in a perpendicular direction is sky-blue and fully polarized. At a further stage of their growth the particles disperse in the perpendicular direction a light which is no longer fully polarized. When quenched as far as possible by rotation of a Nicol prism, it exhibits a residue of a more intense blue colour; and further it is found that the direction of the most nearly complete polarization becomes inclined to the direction of the primary rays.

A discussion of these and other questions upon the basis of the electromagnetic theory of light is given in the *Phil. Mag.*, 1881, 12, p. 81. Here we must be content with a statement of some of the results. So long as the particles are supposed to be very small and to differ little from their environment in optical properties, there is little difference between the electric and the elastic solid theories, and the results expressing the character of the scattered light are equivalent to (5). Whatever may be the shape or size of the particles, there is no scattered light in a direction parallel to the primary electric displacements. In order to render an account of Tyndall's "residual blue" it is necessary to pursue the approximation further, taking for simplicity the case of spherical shape. We learn that the light dispersed in the direction of primary vibration is not only of higher order in the difference of optical quality, but is also of order k^2c^2 in comparison with that dispersed in other directions, where c is the radius of the sphere, and $k = 2\pi/\lambda$ as before. The incident light being white, the intensity of the component colours scattered in this direction varies as the inverse eighth power of the wave-length, so that the resultant light is a rich blue.

As regards the polarization of the dispersed light as dependent on the angle at which it is emitted, we find that although, when terms of the second order are included, the scattered light no longer vanishes in the same direction as before, the peculiarity is not lost but merely transferred to another direction. The angle θ through which the displacement occurs is measured backwards, *i.e.* towards the incident ray, and its value is given by

$$\theta = \frac{\Delta K}{K} \frac{k^2.2}{25}, \quad (23)$$

ΔK being the difference of specific inductive capacities.

Experiments upon this subject are not difficult. In a darkened room a beam of sunlight (or electric light) is concentrated by a

large lens of 2 or 3 ft. focus; and in the path of the light is placed a glass beaker containing a dilute solution of sodium thiosulphate (hyposulphite of soda). On the addition, well stirred, of a small quantity of dilute sulphuric acid, a precipitate of sulphur slowly forms, and during its growth manifests exceedingly well the phenomena under consideration. The more dilute the solutions, the slower is the progress of the precipitation. A strength such that there is a delay of 4 or 5 minutes before any effect is apparent will be found suitable, but no great nicety of adjustment is necessary.

In the optical examination we may, if we prefer it, polarize the primary light; but it is usually more convenient to analyse the scattered light. In the early stages of the precipitation the polarization is complete in a perpendicular direction, and incomplete in oblique directions. After an interval the polarization begins to be incomplete in the perpendicular direction, the light which reaches the eye when the Nicol is set to minimum transmission being of a beautiful blue, much richer than anything that can be seen in the earlier stages. This is the moment to examine whether there is a more complete polarization in a direction somewhat oblique; and it is found that with θ positive there is, in fact, a direction of more complete polarization, while with θ negative the polarization is more imperfect than in the perpendicular direction itself.

The polarization in a distinctly oblique direction, however, is not perfect, a feature for which more than one reason may be put forward. In the first place, with a given size of particles, the direction of complete polarization indicated by (23) is a function of the colour of the light, the value of θ being 3 or 4 times as large for the violet as for the red end of the spectrum. The experiment is, in fact, much improved by passing the primary light through a coloured glass. Not only is the oblique direction of maximum polarization more definite and the polarization itself more complete, but the observation is easier than with white light in consequence of the uniformity in the colour of the light scattered in various directions. If we begin with a blue glass, we may observe the gradually increasing obliquity of the direction of maximum polarization; and then by exchanging the blue glass for a red one, we may revert to the original condition of things, and observe the transition from perpendicularity to obliquity over again. The change in the wave-length of the light has the same effect in this respect as a change in the size of the particles, and the comparison gives curious information as to the rate of growth.

But even with homogeneous light it would be unreasonable to expect an oblique direction of perfect polarization. So long as the particles are all very small in comparison with the wave-length, there is complete polarization in the perpendicular direction; but when the size is such that obliquity sets in, the degree of obliquity will vary with the size of the particles, and the polarization will be complete only on the very unlikely condition that the size is the same for them all. It must not be forgotten, too, that a very moderate increase of dimensions may carry the particles beyond the reach of our approximations.

The fact that at this stage the polarization is a maximum, when the angle through which the light is turned exceeds a right angle, is the more worthy of note, as the opposite result would probably have been expected. By Brewster's law (see POLARIZATION OF LIGHT) this angle in the case of regular reflection from a plate is less than a right angle; so that not only is the law of polarization for a very small particle different from that applicable to a plate, but the first effect of an increase of size is to augment the difference.

The simple theory of the dispersion of light by small particles suffices to explain not only the blue of the zenith, but the comparative absence of small wave-lengths from the direct solar rays, and the brilliant orange and red coloration of the setting sun and of the clouds illuminated by his rays. The hyposulphite experiment here again affords an excellent illustration. But we must not expect a simple theory to cover all the facts. It is obvious that the aerial particles are illuminated not only by the direct solar rays, but also by light dispersed from other parts of the atmosphere and from the earth's surface. On this and other accounts the coloration of the sky is highly variable. The transition from blue to orange or red at sunset is usually through green, but exceptional conditions may easily disturb the normal state of things. The brilliant sunset effects observed in Europe after the Krakatoa eruption may naturally be attributed to dust of unusual quality or quantity in the upper regions of the atmosphere (see DUST).

Related to abnormalities of colour we may expect to find corresponding polarization effects. Of this nature are the neutral points, where the polarization changes character, observed by F. J. D. Arago, J. Babinet and Sir D. Brewster, for an account of which reference may be made to E. Mascart, *Traité d'optique*. The normal polarization at the zenith, as dependent upon the position of the sun, was the foundation of Sir C. Wheatstone's polar clock. (R.)

SKYE, the largest island of the Inner Hebrides, Inverness-shire, Scotland. From the mainland it is separated by the Sound of Sleat, Kyle Rhea, Loch Alsh and the Inner Sound, and from the Outer Hebrides by the Minch and Little Minch. At Kyle Rhea and Kyleakin, on the western end of Loch Alsh, the channel is only about $\frac{1}{4}$ m. wide, and there is a ferry at both points. The length of the island from S.E. to N.W. is $48\frac{1}{2}$ m., but its coast is deeply indented, so that no part of the interior is more than 5 m. from the sea. It has a total area of 411,703 acres or 643 sq. m. From 20,627 in 1821 its population had grown to 23,082 in 1841, but since that date it has steadily diminished and was 15,763 in 1891, and in 1901 only 13,833 (or 21 to the sq. m.), 2858 of whom spoke Gaelic only and 9837 Gaelic and English. The chief arms of the sea are Lochs Snizort and Dunvegan in the N., Loch Bracadale in the W., Lochs Scavaig and Eishort in the S. and Loch Sligachan in the E. The mountains generally assume commanding and picturesque shapes. The jagged mass of the Cuillins (Coolins) dominates the view whether by land or sea. Their highest point is Sgurr na Banachdich (3234 ft.), and at least six other peaks exceed 3000 ft. To the north of Loch Slapin stands the group of Red Hills, of which the highest points are Ben Caillich (2403) and Ben Dearg More (2323 ft.), and north of Lord Macdonald's forest near Loch Ainort rises Ben Glamaig (2537 ft.). About 8 m. N. of Portree is the curious basaltic group of the Storr (2360), consisting of pinnacles and towers, the most remarkable of which, "The Old Man," forms a landmark for sailors. Towards the north of the island, not far from Staffin Bay, is Quiraing (1779 ft.), a basaltic mass with a variety of quaint shapes, of which the best known are "The Needle," "The Prison" and "The Table," the last named a plateau of level turf 1500 ft. above sea-level, measuring 120 ft. by 60 ft. In the peninsula of Duirinish are the two circular hills of Healaval More (1538 ft.) and Healaval Beg (1601), usually styled "MacLeod's Tables," while the two pyramidal rocks rising out of the sea, near the southernmost point of Duirinish, are called "MacLeod's Maidens." The only important lake is the wild and gloomy Loch Coruisk, overshadowed by the precipices of the Cuillin. It is commonly approached by boat from Loch Scavaig, from the shore of which it is about 1 m. distant. It is $1\frac{1}{2}$ m. long by $\frac{1}{4}$ m. broad.

The greater part of the island, all the western and central part, is occupied by igneous plateaux consisting of basaltic lava flows of Tertiary age alternating with intrusive sills of dolerite; they are penetrated by numerous basic dikes and by a smaller number of acid ones. The Cuillin hills owe their striking features to the intrusion of a great laccolitic mass of gabbro within the basalts. East of these hills a large area is covered by acid intrusions—granite felsite, &c.—including the Red Hills, Marseo and Glamaig. The western portion of the island has suffered the disturbances of the N.W. highland thrusting. Torridonian rocks occupy the whole of Sleat, with the exception of a strip between the Point of Sleat and Ormsay Island which is composed of Dalradian schists. In the north of Sleat the Torridonian Sandstones have been thrust on top of Cambrian Durness limestones. Soay is wholly Torridonian. In the narrow part of the island between Broadford Bay on the N.E. and Lochs Staffin, Eishart and Scavaig on the S.W., and in a narrow strip on the east coast, also in Loch Bay, there is an interesting series of Mesozoic rocks beginning with Triassic conglomerates and marls, and passing upwards through Rhaetic, Lower Lias (Broadford Bay), Middle Lias and Upper Lias (Strathaird, Portsea, Prince Charlie's Cove), to beds representing the Great Oolite and Oxford Clay (Loch Staffin, Uig, &c.). A lignite bed of Tertiary age has been worked in a small way at Portsea, and diatomite is excavated from some ancient lake deposits at Loch Cuithir, Loch Monkstadt, Loch Mealt and other places. There is abundant evidence of glacial action on the lower ground.

The rainfall amounts to 80 in. for the year. The mean temperature for the year is $47^{\circ}\cdot 5$ F., for January $39^{\circ}\cdot 5$ F. and for July $56^{\circ}\cdot 5$ F. Most of the land is moor and hill pasture, with cultivated patches here and there, chiefly on Lochs Snizort and Bracadale, the Sound of Sleat, Kyleakin and Portree. The crofters do best with turnips and potatoes. The climate is better adapted for sheep and cattle (West Highland) than for crops, and the sheep farms include some of the finest in Scotland and carry famous stocks, principally black-faced with some Cheviots. The condition of the crofters, which was pitiable in the extreme, has been improved by the Crofters' Holdings Act of 1886. The old black huts have been replaced, in those parishes where stone is obtainable, by well-built houses. Between 1840 and 1880 ejection had certainly been carried to great lengths,

and, in consequence of the emigration that followed, was mainly responsible for the serious decline of the population. The railways to Strome Ferry, Kyle of Loch Alsh and Mallaig, by rendering markets more accessible, effected an improvement in the fisheries, which have always been a mainstay of the inhabitants. The fisheries include herring, cod, ling and salmon, and oysters are reared in some places. Seals are not uncommon at certain points, but the walrus and sperm whale, once occasional visitants, are now rarely if ever seen. It is significant of the change in the circumstances of the people that recruiting is now sluggish, though once Skye supplied more soldiers to the British army than any other area of similar size and population. Whisky is distilled at several places, the Talisker brand of the distillery at Carbost, on the western shore of Loch Harport, being well known.

The inhabited isles off the coast of Skye are mainly situated near the eastern shore. Of these the principal is Raasay (pop. 419). Brochel Castle, now a ruin, stands on the eastern coast. The island is 13 m. long, by about $3\frac{1}{2}$ m. at its widest. Off its north-western shore lies the isle of Flodda. To the north of Raasay, separated by a narrow strait, is South Rona (Seal Island, from the Gaelic *ron*, a seal), $4\frac{1}{2}$ m. long with a maximum breadth of $1\frac{1}{4}$ m., and is a lighthouse, the light of which is visible for 21 m. Scalpay, immediately south of Raasay, has a hill of 1298 ft., and the Sound of Scalpay, parting it from the mainland, abounds with oysters. The other isles are Pabbay in Broadford Bay, Ormsay in the Sound of Sleat, and Soay near Loch Scavaig.

Portree (pop. 872), the capital, lies at the head of a fine harbour about the middle of the eastern seaboard. Steamers run daily in connexion with the mail train at Mallaig, and there is, besides, other communication by steamer with Oban and other ports on the mainland and in the islands. Among the buildings in the town are the Episcopal church of St. Columba, erected in 1884 to the memory of Bishop George R. Mackarness, the Ross Cottage Hospital, the Combination poorhouse and the courthouse, and there is a factory for tweeds, plaids, carpets and other woollens. The exports are principally sheep, cattle, wool, salmon and other fish. The name of the town was derived from the fact that James V. landed there on the occasion of his tour in the Western Highlands. The place thus became, in Gaelic, *Port-an-Righ*, or the King's Harbour. It was to Portree that Flora Macdonald (1722-1790) conducted Prince Charles Edward when he escaped from Benbecula. Prince Charlie's Cave is situated on the coast about 5 m. north of the harbour. Among other places in Skye associated with the Young Pretender are Prince Charles's Point near Monkstadt, on the west of the peninsula of Trotternish, where he landed with Flora Macdonald, and Kingsburgh, on the eastern shore of Loch Snizort. The castle at Dunvegan, of the Macleods of Macleod, was erected in the 9th century and extended by later chieftains, especially by Alastair Crotach, or the Humpback, in 1458, and by Rory (Roderick) More, who was knighted by James VI. Built on a rocky promontory which is difficult of access, the fortress must have been almost impregnable in the era of clan warfare. Among the interesting relics preserved in it are the Fairy Flag, a yellow silk banner captured from a Saracen general by a crusading Macleod, and Rory More's drinking-horn, which held two quarts and had to be drained at a single draught by the new chief before he could wield authority. The MacCrimmons, the famous race of hereditary pipers, hailed from this quarter of Skye and were attached to the Macleods of Dunvegan. At Duntulm is the ancient castle of the Macdonalds, another of the great Skye chieftains. Close to it is the Hill of Pleas, where, in former days, the chieftain sat dispensing justice in the fashion of primitive times. The modern seat of Lord Macdonald is Armadale Castle, a fine Gothic mansion on the shore of the Sound of Sleat.

SLADE, FELIX (1790-1868), English art collector and patron, was born at Lambeth, London, in August 1790, the son of Robert Slade, a Surrey landowner, from whom he inherited considerable means. He became widely known as a purchaser of books and engravings, and made a valuable collection of glass. He died unmarried on the 29th of March 1868, leaving personalty to the value of £160,000. He bequeathed the bulk of his art collection to the British Museum, and £35,000 for the endowment of art professorships, to be known as Slade Professorships, at Oxford,

Cambridge, and University College, London. University College received the additional bequest of six art scholarships.

SLANDER, a false tale or report, defamation. The word is a doublet of "scandal" and comes through the O. Fr. *esclandre*, which, through the earlier forms *scandele*, *escandele*, *escandre*, is derived from Lat. *scandalum* (see further SCANDAL). In law, slander is the malicious defamation of a person in his reputation, profession or business, by words (see LIBEL AND SLANDER).

SLANG, in what is now the usual sense, a general name for the class of words and senses of words, more or less artificial or affected in origin or use, which are not recognized as belonging to the standard vocabulary of the language into which they have been introduced, but have an extensive currency in some section of society either as a means of concealing secrets or as intentionally undignified substitutes for those modes of expression that are employed by persons who value themselves on propriety of speech.

As thus defined, slang includes many varieties of speech, which are current respectively among different sections of the population. The one, however, which most perfectly answers to the definition, and may be regarded as the primary type, is the artificial jargon, partly cryptic and partly facetious, used by vagrants and professional thieves. It is true that the name of slang is now seldom applied to this jargon; it is more commonly designated by its older name of "cant." Nevertheless in the 18th century it was chiefly used in this particular application. The earliest example of the word hitherto discovered occurs in Toldervy's *History of Two Orphans*, published in 1756. One of the characters in this story is a man who, "in return for the numerous lies which he told, was called the cannon-traveller"; and it is said of him that "he had been upon the town, and knew the slang well." It is not clear whether "slang" here has its modern sense, or whether it means the ways of fast life in London. A more unequivocal instance, two years later in date, is quoted in J. C. Hotten's *Slang Dictionary* (1864) from a book entitled *Jonathan Wild's Advice to his Successor*, apparently one of the many catchpenny publications that were called forth by the popularity of Fielding's burlesque romances. No copy of this book is in the British Museum or the Bodleian Library, and inquiries have failed to discover any trace of its existence; but there is no reason to doubt that Hotten had seen it. The passage, as quoted by him, is as follows: "Let proper Nurses be assigned to take care of these Babes of Grace (*i.e.* young thieves). . . . The Master who teaches them should be a man well versed in the Cant Language, commonly called the Slang Patter, in which they should by all means excel." Four years later, in 1762, the word is found with a different and now obsolete meaning, in Foote's play *The Orators*. A fast young Oxford man, invited to attend a lecture on oratory, is asked, "Have you not seen the bills?" He replies, "What, about the lectures? ay, but that's all slang, I suppose." Here the word seems to be equivalent to "humbug." In the 1st edition of Hugh Kelly's comedy, *The School for Wives*, there is a passage (omitted in some of the later reprints) in which one of a company of sharpers, who pretend to be foreigners and speak broken English, says: "There's a language called slang, that we sometimes talk in. . . . It's a little rim tongue, that we understand among von another." Francis Grose's *Dictionary of the Vulgar Tongue* (1785) has the entry "*Slang*, the cant language"; and after this instances of the word are abundant. In the early part of the 19th century it appears in literature chiefly as a general term of condemnation for "low-lived" and undignified modes of expression. It seems probable that the word came from some dialect of the north of England; but this is difficult to establish, as most of the dialect glossaries date from a time long after it had obtained general currency, so that it would escape the notice of the compilers as being outside their proper scope. The *English Dialect Dictionary* mentions only the sense of "abusive language," which is said to be current in Yorkshire and the Lake Country. Some reason for believing that the word is genuinely dialectal—an inheritance from the language of the Scandinavian settlers in the north of England—is afforded by the coincidence of its uses with those

of the modern Norwegian verb *slengja* (etymologically equivalent to the English "to sling") and related words, as given in the dictionary of Ivar Aasen. *Slengja kjeften* (literally, to sling the jaw), means to pour out abuse; the compound *slengje-ord* (*ord*=word) is explained by Aasen as "a new word without any proper reason," which comes very near to the notion of a "slang word." The English word has, in cant speech, certain applications to matters other than those of language; and although these have not been found recorded at any very early date, they may possibly be old, and may contribute to the determination of the primary sense. Any particular mode of thieving or of making a living by fraudulent means is called a "slang"; and the same term is applied to the particular line of business of a showman or a troupe of strolling players. Further, the word is used adjectively to designate fraudulent weights and measures, and the early slang dictionaries explain the verb *slang* as meaning "to defraud." The precise relation between these various senses cannot be determined, but they seem to agree in having some reference to what is lawless or irregular, and this general notion may be regarded as having a certain affinity to the meaning of the verb "to sling," with which the word is probably etymologically allied. It is unlikely that the word *slang*, in the senses here under consideration, has any direct connexion with the homophonous word meaning "a strip of land."

The modern extended application of the term, which is closely paralleled by that of the French synonym *argot*, is not difficult to account for. In the first place, the boundaries of the world in which slang—in the original sense—is current are somewhat indeterminate. It is, for instance, not easy to draw the line between the peculiar language of "rogues and vagabonds" and that of the lowest order of travelling showmen and strolling players, or between this latter and the strictly analogous body of expressions common to all grades of the histrionic profession. Similarly, the prize-ring, the turf, the gaming-table and all the varieties of "fast" and "Bohemian" life have their own eccentric vocabularies, partly identical with, and in general character altogether resembling, the slang of the criminal and vagrant classes. In the second place, a little consideration is sufficient to show that thieves' cant is only one species of an extensive genus, its specific difference consisting in the unessential circumstance that its use is confined to one particular class of persons.

Although the term "slang" is sometimes used with more or less intentional inexactness, and has often been carelessly defined, the notion to which it corresponds in general use seems to be tolerably precise. There are two principal characteristics which, taken in conjunction, may serve to distinguish what is properly called slang from certain other varieties of diction that in some respects resemble it. The first of these is that slang is a conscious offence against some conventional standard of propriety. A mere vulgarity is not slang, except when it is purposely adopted, and acquires an artificial currency, among some class of persons to whom it is not native. The other distinctive feature of slang is that it is neither a part of the ordinary language, nor an attempt to supply its deficiencies. The slang word is a deliberate substitute for a word of the vernacular, just as the characters of a cipher are substitutes for the letters of the alphabet, or as a nickname is a substitute for a personal name. The latter comparison is the more exact of the two; indeed nicknames, as a general rule, may be accurately described as a kind of slang. A slang expression, like a nickname, may be used for the purpose of concealing the meaning from uninitiated hearers, or it may be employed sportively or out of aversion to dignity or formality of speech. The essential point is that it does not, like the words of ordinary language, originate in the desire to be understood. The slang word is not invented or used because it is in any respect better than the accepted term, but because it is different. No doubt it may accidentally happen that a word which originates as slang is superior in expressiveness to its regular synonym (much as a nickname may identify a person better than his name does), or that in time it develops a shade of meaning which the ordinary language cannot convey. But when such a word comes

to be used mainly on account of its intrinsic merit, and not because it is a wrong word, it is already ceasing to be slang. So long as the usage of good society continues to proscribe it, it may be called a vulgarism; but unless the need which it serves is supplied in some other way, it is likely to find its way into the standard speech.

The account here given of the distinctive characteristics of slang conflicts with the view of those writers who so define the term as to make it include all words and uses of words that are current only among persons belonging to some particular class, trade or profession. But such an extended application of the word is not supported by general usage. It is true that it is not uncommon to apply the name of slang to the technical language of trades and professions, or even of arts and sciences. This, however, is really a consciously metaphorical use, and is intended to convey the imputation that the employment of technical language has no better motive than the desire to be unintelligible to the uninitiated, to or excite admiration by a display of learning. If the imputation were true, the designation would be strictly applicable. Technical and scientific terms may justly be stigmatized as slang when they are used pretentiously without any good reason, but not when they are chosen because, to those who understand them, they afford a clearer, more precise, or more convenient expression of the meaning than is found in the ordinary vocabulary. At the same time, it is true that every trade or profession has a real slang of its own; that is to say, a body of peculiar words and expressions that serve as flippant or undignified substitutes for the terms that are recognized as correct. It happens not infrequently that words of this kind, owing to frequency of use and the development of specific meanings, lose the character of slang and pass into the category of accepted technicalities.

A class of words that has a certain affinity with slang, though admitting of being clearly distinguished from it, consists of those which are proscribed from the intercourse of reputable society because they express too plainly ideas that are deemed indelicate, or because they are brutally insulting. Such words share with slang the characteristic that they are ordinarily employed only in intentional defiance of propriety; they differ from it in being really part of the original vernacular, and not of an artificial vocabulary which is substituted for it. The customary euphemisms which take the place of these condemned words are, of course, far removed from slang; but the name is strictly applicable to those grotesque metaphors which are sometimes substituted, and emphasize the offensiveness of the notion instead of veiling it.

The known history of European slang begins (leaving out of account the meagre references in German documents hereafter to be mentioned) with the "Ballades" of François Villon in the 15th century. The French *argot* of these compositions contains much that is still obscure, but the origin of some of its words is evident enough. Facetious expressions relating to the destined end of the malefactor are prominent. *Paroir* and *montjoie* (for which later the less ironical *monte à regret* was substituted) are nicknames for the scaffold. *Acollez*, hanged, corresponds to the English "scragged"; the synonymous *grup* seems to be an onomatopoeic formation suggestive of choking. There are some derivatives formed with the suffix *art*: *riflart* is a police-officer, *abrouart* fog. A few words from foreign languages occur: *audinos*, prayer, is the Latin *audi nos* of the litanies; *arion*, bread, is obviously Greek, and its appearance in the 15th century is somewhat hard to account for. *Moller*, to eat, may perhaps be the Latin *molere* to grind. *Anse*, the ear, is no doubt the Latin *ansa*, handle. In the 15th century and later the ranks of vagabondage were often recruited from the class of poor students, so that the presence of some words of learned origin in the vocabulary of the vagrant and criminal classes is not surprising. Among the prominent features of later French slang may be noted the use of the suffix *mare* to form derivatives such as *perruquemare*, a wig-maker, and the practice of rendering conversation unintelligible to outsiders by tacking on some unmeaning ending to every word.

In Germany the word *Rotwalsch* (the modern *Rotwelsch*, still the name for the cant of vagrants) occurs as early as the middle of the 13th century, and during the following century there appear lists of slang terms for various species of malefactors and begging impostors. The earliest attempt at a vocabulary of "Rotwelsch" is that of Gerold Edlibach, compiled about 1490. A second vocabulary, containing nearly the same set of words, is contained in the famous *Liber vagatorum*, first printed in 1510 in High German; versions in

Low German and the dialect of the Lower Rhine appeared shortly afterwards. An edition of this work printed in 1529 has a preface by Martin Luther. The most remarkable feature of the jargon represented in these early glossaries is the large number of Hebrew words that it contains. It is not clear whether this fact indicates that Jews formed a large proportion of the German vagabond class at the beginning of the 16th century; the explanation may be simply that the Hebrew words contributed by Jewish vagrants found acceptance because they were unintelligible to ordinary people. However this may be, the later dictionaries of "Rotwelsch" not only retain most of the Hebrew words found in the earliest authorities, but add greatly to their number. There are some words from Italian, as *bregan*, to beg, from *pregare*, and *barlen*, to speak, from *parlare*. The language of the gipsies seems to have contributed nothing, nor are there any words from Latin or Greek. Some of the words are ordinary German words used metaphorically, like *wetterhan* (weathercock) for a hat, *zwicker* (*zwitcher*) for the hangman, *brief* (letter) for a playing-card. Others are descriptive compounds such as *breitfuss* (broad-foot) for a duck or goose, or derivatives formed by means of the suffixes *-hart* (or *-art*) and *-ling*, as *grunhart* (from *grün*, green), a field, *glathart* (from *glatt*, smooth), a table, *fluckart* (from *flug*, flight), a bird, *funckart* (from *funke*, spark), fire, *flossart* (from *floss*, stream), water, *flossling*, a fish, *lüssling* (from *lüssen* to listen), the ear. It is noteworthy that modern Dutch thieves' cant, as presented in the dictionary of I. Teirlinck, is closely similar in its principles of formation, and in many of its actual words, to that of the early German vocabularies.

The earliest English "cant" or "Pedlers' French," as exhibited in R. Copland's *The Hye Waye to the Spytell House* (1517), John Awdeley's *Fraternitye of Vacabondes* (1561), Thomas Harman's *Caueat for Cursetours* (1567) and various later writers, bears a close resemblance in its general character to the German *Rotwelsch* of the *Liber vagatorum*, the most noteworthy point of difference being the absence of Hebrew words. The suffix corresponding to the *-hart* and *-ling* of German slang is *-mans*, as in *lightmans*, day, *darkmans*, night, *ruffmans*, the woods. The word *cheat*, a thing (whether this is etymologically connected with the verb *to cheat* is uncertain), is used to form a great variety of descriptive compounds, such as *grunting cheat*, a pig, *bleting cheat*, a sheep, *cackling cheat*, a cock or capon, *moffling cheat*, a napkin, *smelling cheat*, the nose, *pralling cheat*, the tongue. There are some ordinary English words used as descriptive nicknames for things, as *glasyers*, eyes, *stampes*, legs, *stampers*, shoes, *prauncer*, a horse, *glymmar*, fire, *lap*, buttermilk or whey, *high pad*, the highway, *pek*, meat. Obviously of Latin origin are *grannam*, corn, *pannam*, bread, *cassan*, cheese. *Commission*, a shirt, is from the Late Latin *camisia*; it afterwards appears shortened to *mish*. Perhaps *boon* and *bene*, good, may be Latin, but a French origin is possible. *Vyle*, a town, is probably French; *deuse a vyle*, the country, seems to be a compound of this. A few words seem to be of Dutch or Low German origin, as *bung*, a purse (Low Ger. *pung*), *kinchin*, a child, *cranke*, a malingering, and perhaps *feague* or *feak* (Low Ger. *fege*), which appears in modern slang as *fake*. Certainly from this source is the gambling term *foist*, to palm a die, which has become recognized English in a figurative sense. Harman's list includes a considerable number of words of obscure and perhaps undiscoverable origin, as *lowre*, to see, *lowre*, money, *wyn*, a penny, *trine*, to hang, *cofe* or *cove*, a man, *mort*, a woman. Attempts to discover an etymology for some of these in Romany are unsuccessful. *Ken*, a house, is used by English gipsies, but may be an importation from cant. Even in later English slang the number of Romany words is surprisingly small; *pal*, originally meaning brother, is one of the few certain examples.

From the 17th century onwards it has been more and more difficult to distinguish between the cant of thieves and vagrants and the slang of other classes more or less characterized by disorderly habits of life, such as pugilists, the lower orders of strolling players, professional gamblers and persons of all ranks addicted to low pleasures. Many words that were once peculiar to the outcasts from society are now in general slang use. While a few of the words of the "Pedlers' French" of the 16th century have survived to the present or recent times, the majority have been superseded by later inventions. The older slang names of coins or sums of money, for instance, are nearly all obsolete, and their modern synonyms, mostly of obscure origin, cannot be traced very far back. *Quid*, a guinea or sovereign, was used in the 17th century; *bob*, a shilling, *bull*, a crown piece, *tanner*, a sixpence, and others, are of 19th-century date. In recent times the vocabulary of low-class slang has obtained several words from Yiddish or Jewish-German, such as *gonnof*, a thief (Hebrew *gannābh* as pronounced by German Jews), *foont*, a pound (German *Pfund*), *oostish*, contracted to *oof*, money (from the German *aufischen*, to regale a person with something). A peculiar growth of the 19th century is the so-called "back slang," current chiefly among London costermongers, which is a cryptic jargon formed by pronouncing words backwards, as in *ecilop* or *slop* for "police," "eno dunop and a flah," one pound and a half, thirty shillings. What is called "riming slang," consisting of such fantastic expressions as *mutton-pie* for eye, *lord of the manor* for "tanner," i.e. sixpence, is a jocular invention which does not seem to have had any considerable currency except in the columns of the sporting newspapers.

The varieties of slang that have their origin and currency in the reputable classes of society owe their existence partly to impatience with the constraint of ceremonious propriety of speech, and partly to the kind of *esprit de corps* which leads those who are associated in any common pursuit, or whose mutual intercourse is especially intimate, to take pleasure in the possession of modes of speech that are peculiar to their own "set." The former feeling is naturally strongest among those who are under the control of superiors in whose presence they have to observe an uncongenial formality of expression. It is therefore only what might be expected that every public school and every university has its own elaborately developed slang vocabulary, and that there is also a good deal of slang that is common to schoolboys and to undergraduates in general. Even among persons of riper years there are many to whom ceremonious speech is unwelcome. The motive for the creation of slang is therefore widely diffused throughout all classes. Besides the general slang that is current among all who rebel against the laws of conventional decorum of language, there are innumerable special varieties. As a rule, every trade and profession, and every closely associated group of persons, has its own slang; indeed, there are probably few family circles that have not certain peculiar expressions used only within the household. It may be noted that some classes of workmen—printers and tailors for example—are more than others remarkable for the copiousness of their trade slang. The theatrical profession has in all countries an abundant vocabulary of sportively metaphorical and allusive words and phrases. The slang current in the orderly portions of society, in England at least, does not present many insoluble puzzles of etymology, the words of obscure origin being for the most part such as have been imported from a lower level. There is no difficulty in accounting for the many jocularly simulative uses of ordinary words, such as "tin" for money, "bags" for trousers, "tile" for hat. Especially characteristic of university slang is the distortion of the form of words, sometimes with the appending of a conventional termination, as in the German student's "schleo" for *schlecht*, "Kneo" for *Kneipe*, "Bim" for *Busen*, "Respum" for *Respekt*, or the English "rigger" and "soccer" for the Rugby and Association varieties of the game of football, "tosher" for unattached student, "progging" for the disciplinary function of the proctor, "ekker" for exercise, "congratters" or "congraggers" for congratulations. Such shortened forms of words as "thou" for thousand, "exes" for expenses, "exam" for examination, "vac" for vacation, "photo" for photograph, "bike" for bicycle, may reasonably be classed as slang when they are used with intentional impropriety or flippancy, but many such forms, on account of their convenient brevity, have acquired a degree of currency that entitles them to rank as respectable colloquial English.

It is generally admitted that in the United States the currency of slang is wider, and its vocabulary more extensive, than in other English-speaking countries. Indeed, an American encyclopaedia has the entry "Slang, see Americanisms." The two things, of course, are not identical, and some of those American expressions that are in England regarded and used as slang have no such character in their native country. But the invention of new words of grotesque sound and ludicrously descriptive point is a favourite form of humour in America, and the freedom with which these coinages are used in many newspapers contrasts with the more sober journalistic style usual in England. Much of the current slang of America is used only in the land of its origin, and it is not uncommon to meet with newspaper articles of which an untravelled Englishman would hardly be able to understand a sentence, and on which the dictionaries of Americanisms afford little light. The American contribution to the current slang of the British Isles consists mainly of words and expressions that are recommended by their oddity, such as "scallywag," "absquatulate," "skedaddle," "vamoose" (from the Span. *vamos*, let us go), and words relating to political life, such as "mugwump" (originally an Indian word meaning "great chief"), "carpet-bagger," and "gerrymander." Australia,

also, as may be seen from the novels of Rolf Boldrewood and other writers, possesses an ample store of slang peculiar to itself, but of this "larrikin" is the only word that has found its way into general use in the mother-country.

To the philologist the most interesting question connected with slang is that relating to the importance of the share which it has in the development of ordinary language. It is probably true that the standard vocabulary of every modern European language includes some words that were originally slang; but there is certainly much exaggeration in the view that has been sometimes maintained, that slang is one of the chief sources from which languages obtain additions to their means of expression. The advocates of this view point to the fact that a certain number of Italian and French words descend, not from the Latin words of identical meaning, but from other words which in vulgar Latin were substituted for these by way of jocular metaphor. Thus the Italian *testa*, Fr. *tête*, head, represent the Lat. *testa*, pot or shell; the Fr. *joue*, cheek, corresponds by strict phonetic law to the Late Lat. *gabata*, porringer. It may be conceded that in these instances, and a few others, words of popular Latin slang have become the accepted words in the languages descended from Latin. But the number of instances of this kind is, after all, inconsiderable in comparison with the extent of the whole popular vocabulary; and the conditions under which the Romanic languages were developed (from Latin as spoken by peoples mainly of non-Latin origin) are somewhat abnormal. A consideration of the essential characteristics of slang, as previously explained in this article, will show that it is only to a limited extent that it is likely to be absorbed into the general language. It has been pointed out that slang words, for the most part, do not express notions which ordinary language cannot express quite as efficiently. This fact implies a noteworthy limitation of the capabilities of slang as a source from which the deficiencies of a language can be supplied. As the prevailing tendency of words is toward degradation of meaning, one of the most frequently recurring needs of language is that of words of dignified and serious import to take the place of those which have become cheapened through ignoble use. It is obvious that slang can do nothing to meet this demand. The less frequent want of terms of contempt or reprobation may, of course, be supplied by adoptions from slang; and in the exceptional instances in which, as has already been indicated, a slang word has no synonym in ordinary speech, it may very naturally find its way into recognized use.

On the whole, the debt of modern standard English to slang of all kinds is probably smaller than most persons would suppose. A few words have been furnished by thieves' cant, and, as might be expected, most of these relate to criminal or vicious practices. No one will be surprised to learn that *rogue* and *bully*, and the verbs *to filch* and *to foist*, are derived from this source. On the other hand, one would hardly have expected to find "*drawers*, *hosen*" in Harman's vocabulary of "Pedlers' French" in 1567. The word soon came into general use, probably because (though not euphemistic in original intention) it suited the same affected notion of delicacy which led to the substitution of "shift" for "smock." There are some words, such as *prig*, to steal, which were once vagrant slang, but are now universally understood and widely used, without, however, losing their "slangy" character. The utmost that can be said is that they are on the debatable ground between slang and merely jocular language.

Although it often happens that words belonging to the more reputable kinds of slang undergo some improvement in status—acquiring some degree of toleration in refined circles where they would once have been considered offensive—there are few instances in which such a word has come to be regarded as unexceptionable English. One example of this is *prig* (a distinct word from the term of thieves' cant already mentioned), which originally denoted a person over-scrupulous in his attire and demeanour, but has now acquired a different sense, in which it supplies a real need of the language. Other words that were once slang but are so no longer are *mob*, *humbug*, *tandem* (apparently

a university joke founded on "at length" as the dictionary rendering of the Latin adverb).

BIBLIOGRAPHY.—English: Most of the authorities for the early history of English vagrant slang are reprinted in vol. ix. of the Extra Series of the Early English Text Society, edited by E. Viles and F. J. Furnivall (1869), which contains John Awdley's *The Fraternitye of Vacabondes* (from the edition of 1575), Thomas Harman's *Caueat for Commen Cursetours* (1567–1573), and *The Ground-work of Conny-catching* (anonymous, 1592), besides extracts from other early works which furnish glossaries. *The Dictionary of the Canting Crew*, by B. E. (no date, but printed at the end of the 17th century; photographic reprint by J. S. Farmer), is valuable as containing the earliest known record of many words still in use; while mainly treating of thieves' and vagrants' language, it includes much that belongs to slang in the wider sense. Among the many later works, only the following need be mentioned here: Francis Grose's *Classical Dictionary of the Vulgar Tongue* (3rd ed., 1796); *The Slang Dictionary*, anonymous, but understood to be by the publisher, J. C. Hotten (new edition, 1874), a work of considerable merit, with an excellent bibliography; *A Dictionary of Slang, Jargon and Cant*, by A. Barrère and C. G. Leland (1889); and *Slang and its Analogues*, by J. S. Farmer and W. E. Henley (1890–1904), which surpasses all similar works in extent of vocabulary and abundance of illustrative matter, though the dates and even the text of the quotations are often inaccurate. For the slang of public schools see *The Winchester Word-book*, by R. G. K. Wrench (1901) and *The Eton Glossary*, by C. R. Stone (1902).

French: The earliest systematic treatment of *argot* is found in *La Vie gènéreuse des Mallois, Gueux Bohémiens et Cagoux*, by Pechon de Ruby (a pseudonym), which went through several editions in the early part of the 17th century, and has been reprinted in 1831 and 1868. The slang of the 15th century is discussed in *Le Jargon au quinzième siècle*, by Auguste Vitu (1883), which includes an edition of the *Ballades of Villon*; in *Le Jargon et jobelin de F. Villon*, by Lucien Schöne (1887), and in *L'Argot ancien*, by L. Sainéan (1907). Françoise Michel's *Études de philologie comparée sur l'argot* (1856) is important for its rich collection of material and its copious references to sources. Later works deserving attention are *Dictionnaire de la langue verte*, by Alfred Delvau (2nd ed., 1867), and *Dictionnaire de l'argot*, by Lorédan Larchey (1889). For modern slang, taken in a very comprehensive sense, the chief authority is Lucien Rigaud, *Dictionnaire de l'argot moderne* (1881). For the special slang of printers, see Eugène Boutmy, *Dictionnaire de l'argot des typographes* (1883).

German: An admirable collection of the original documents for the history of thieves' and vagrant slang from the earliest period has been published by F. Kluge, under the title *Rotwelsch* (1901). An earlier book of great importance is Avé-Lallemant, *Das deutsche Gaunertum* (1858). For modern popular slang see A. Genthe, *Deutsches Slang* (1892). University slang is ably treated in *Deutsche Studentensprache*, by F. Kluge (1895).

Dutch: Isidor Teirlinck, *Woordenboek van Bargoensch* (1886).

Italian and Spanish: F. Michel, in *Études de philologie comparée sur l'argot* (see above), gives a vocabulary of Italian thieves' slang from *Nuovo modo da intendere la lingua zerga* (1619, reprinted at the end of the *Trattato dei Bianchi*, 1828), and one of Spanish slang from *Romances de Germania* (ed. 6, shortly before 1800). For Spanish thieves' language see also A. Besses, *Argot español* (Barcelona, no date); a large proportion of the words given by this writer is gipsy. (H. BR.)

SLATE (properly CLAY SLATE; in M. Eng. *slat* or *sclat*, from O. Fr. *esclat*, a small piece of wood used as a tile; *esclater*, to break into pieces, whence modern Fr. *éclat*, the root being seen also in Ger. *schleissen*, to split), in geology, a fissile, fine-grained argillaceous rock which cleaves or splits readily into thin slabs having great tensile strength and durability. Many other rocks are improperly called slate, if they are thin bedded and can be used for roofing and similar purposes. One of the best known of these is the Stonesfield slate, which is a Jurassic limestone occurring near Oxford and famous for its fossils. Slates properly so-called do not, except on rare occasions, split along the bedding, but along planes of cleavage, which intersect the bedding usually at high angles. The original material was a fine clay, sometimes with more or less of sand or ashy ingredients, occasionally with some lime; and the bedding may be indicated by alternating bands of different lithological character, crossing the cleavage faces of the slates, and often interrupting the cleavage, or rendering it imperfect. Cleavage is thus a superinduced structure, and its explanation is to be found in the rearrangement of the minerals, and the development of a certain degree of crystallization by pressure acting on the rock. Slates belong mostly to the older geological systems, being commonest in Pre-Cambrian, Cambrian and Silurian districts, though they may be found of Carboniferous

or even of Tertiary age, where mountain-building processes have folded and compressed these more recent formations. The action of pressure is shown also by the fossils which sometimes occur in slates; they have been drawn out and distorted in such a way as to prove that the rock has undergone deformation and has behaved like a plastic mass. Evidence of the same kind is afforded by the shape of the knots and concretions sometimes present in the slate. If the bedding be traced, either in the slates or in the other rocks which accompany them, flexures will be frequently observed (the folding often being of an isoclinal type), while reversed faulting, or thrusting, is usually also conspicuous.

The origin of slaty cleavage is in some measure obscure. This structure is by no means confined to slates, though always

best exemplified in them, owing probably to the fine-grained, argillaceous materials of which they consist. Grits, igneous rocks, ash-beds and limestones may and often do show cleavage. Coarse rocks and rocks consisting of hard minerals are always imperfectly cleaved. The cleavage of slates must be distinguished from cleavage of minerals, the latter being due to different degrees of cohesion along definite crystallographic planes. The connexion of cleavage with pressure, however, is unmistakable. It is never exhibited except by rocks which have been sub-

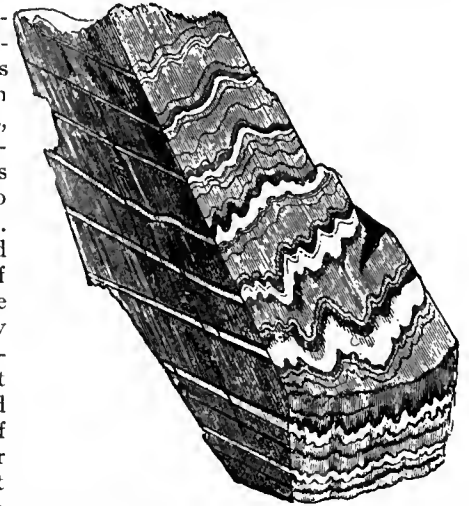

jected to the tangential stresses set up in the earth's crust by folding. These stresses may operate in several ways. They will alter the shape of mineral particles by broadening them in a direction at right angles to the principal pressures, while they are thinned in the direction in which the pressure acted. Probably the size of the particle will be slightly reduced. This method of reasoning, however, does not carry us far, as the minerals of slates vary considerably in form. Pressure will also tend to produce an expansion of the rock mass in a direction (usually nearly vertical) at right angles to the compression, for such rocks as slates are distinctly plastic in great masses. This flowage will help to orientate the particles in the direction of movement, and, operating conjointly with the flattening above explained, will accentuate the liability to cleave in a definite set of planes. The recrystallization induced by pressure is probably of still greater importance. Slates consist largely of thin plates of mica arranged parallel to the cleavage faces. This mica has developed in the rock as it was folded and compressed. In the moist and plastic slate the mineral particles slowly enlarged by the addition of new crystalline molecules. Those faces which were perpendicular to the pressure would grow slowly, as the great pressure would promote solution, and inhibit deposition; the edges or sides, on the other hand, being less exposed to the pressure would receive fresh deposits. In this way thin laminae would form, lying at right angles to the direction of greatest stress. Micaceous and other platy minerals (such as chlorite), which naturally grow most rapidly on their edges, would show this tendency best, and such minerals usually form a large part of the best slates; but even

quartz and felspar, which under ordinary conditions form more equidimensional crystals, would assume lenticular forms. In the necessary co-operation of these three causes, viz. flattening of particles by compression, orientation of particles by flow and formation of laminar crystals, the fundamental explanation of slaty cleavage is found. The planes of cleavage will be approximately perpendicular to the earth pressures which acted in the district; hence the strike of the cleavage (*i.e.* its trend when followed across the country) will be persistent over considerable areas.

Where the rock masses are not homogeneous (*e.g.* slates alternating with gritty bands), the cleavage is most perfect in the finest grained rocks. In passing from a slate to a grit the direction of the cleavage changes so that it tends to be more nearly perpendicular to the bedding planes. A structure akin to cleavage, often exemplified by slates especially when they have been somewhat contorted or gnarled, is the *Ausweichungsschivage* of Albert Heim. It is produced by minute crumplings on the cleavage faces all arranged so that they lie along definite planes crossing the cleavage. These slight inflections of the cleavage may be sharp-sided, and may pass into small faults or steps along which dislocation has taken place. A secondary or false cleavage, less perfect than the true cleavage, may thus be produced (see PETROLOGY, Pl. IV. fig. 7). The faces of slates have usually a slightly silky lustre due to the abundance of minute scales of mica all lying parallel and reflecting light simultaneously from their pearly basal planes. In microscopic section the best slates show much colourless mica in small, thin, irregular scales. Green chlorite is usually also abundant in flakes like those of the mica. The principal additional ingredient is quartz in minute lens-shaped grains. The size of the individual particles may be approximately one-five-hundredth of an inch. Minute rods or needles of rutile are also common in slates, and well-formed cubes of pyrites are often visible on the splitting faces. The brownish colour of some slates is due to limonite and haematite, but magnetite occurs in the darker coloured varieties. Other minerals which occur in the rocks of this group are calcite, garnet, biotite, chloritoid, epidote, tourmaline and graphite or dark carbonaceous materials.

By advancing crystallization and increased size of their components, slates pass gradually into phyllites, which consist also of quartz, muscovite and chlorite. In the neighbourhood of intrusive granites and similar plutonic igneous rocks, slates undergo "contact alteration," and great changes ensue in their appearance, structure and mineral composition. They lose their facile cleavage and become hard, dark-coloured, slightly lustrous rocks, which have a splintery character or break into small cuboidal fragments. These are known as "hornfels" (*q.v.*). Farther away from the granite the slates are not so much altered, but generally show small rounded or ovoid spots, which may be darker or lighter in colour than the matrix. The spots contain a variety of minerals, sometimes mainly white mica or chlorite. In these spotted slates andalusite, chiastolite, garnet and cordierite often occur; chiastolite is especially characteristic; cordierite occurs only where the alteration is intense. The chiastolite-slates show elongated, straight-sided crystals with black cores (see PETROLOGY, Pl. IV. fig. 9), which, on transverse section, have the form of a cross constituting the two diagonals of the rhombic or squarish pattern of the mineral. These crystals may be half an inch to several inches in length; they are usually more or less completely weathered to white mica and kaolin. In other cases, especially near mineral veins, slates are filled with black needles of tourmaline or are bleached to pale grey and white colours, or are silicified and impregnated with mineral ores. Frequently in districts where slates are much crumpled they are traversed by numerous quartz veins, which have a thickness varying from several inches up to many feet, and may occasionally be auriferous. (J. S. F.)

Slates are widely used for roofing houses and buildings of every description, and for such purposes they are unequalled, the better sorts possessing all the qualities necessary for protection against wind, rain and storm. The finer varieties are made into writing

slates, and in districts where cross cleavage exists slate pencils are made. Slabs are also manufactured, and, being readily cut, planed, dressed and enamelled, are used for chimney pieces, billiard tables, wall linings, cisterns, paving, tomb-stones, ridge rolls, electrical switch-boards and various other architectural and industrial purposes.

Slate rocks are quarried both above ground and below ground, according as they lie near to or distant from the surface. When they are near the surface, and their dip corresponds with the slope of the ground, they are in the most favourable position, and are worked in terraces or galleries formed along the strike of the beds and having a height of about 50 ft. The galleries are generally carried on in sections of 10 yds., worked across the beds, and may rise to any height or be sunk below the surrounding level by excavations. When the rock is much removed from the surface, or inconveniently situated for open workings, it is quarried in underground chambers reached by levels driven through the intervening mass and across or along the beds. Or it may be necessary to sink shafts as in coal-pits before the rock is arrived at, but the cost of doing so forms a serious drawback. The material is sometimes won by the aid of channelling machines which make a series of cuts at right angles to each other in the face of the rock; a block is then broken off at its base by wedges forced into the cuts, and its removal permits access to other blocks. When blasting is resorted to, advantage is taken of the natural cuts or joints, as the rock is readily thrown or worked off these. The explosive used should be of such a character as to throw out or detach masses of rock without much splintering, which would destroy the blocks for slate-making. From the mass thrown out by the blast, or loosened so as readily to come away by the use of crowbars, the men select and sort all good blocks and send them in waggons to the slate huts to be split and dressed into slates. Two men are employed at this operation—one splitting and the other dressing, performing their work in a sitting posture. The splitter places a block on end between his knees, and with chisel and mallet splits it into as many plates as possible of the usual thickness for roofing purposes—namely, a quarter of an inch more or less according to the size and strength required. These plates are then placed horizontally by the dresser on a vertical iron "stand," and cut with a sharp knife into slates of various sizes suitable for the market. For an enumeration of these sizes, see ROOFS, where also will be found an account of the different varieties of slates and of the ways in which they are fixed.

SLATE ISLANDS, a group belonging to the parish of Kilbrandon and Kilchattan off the coast of Lorne, Argyllshire, Scotland. They comprise Seil, Easdale, Torsay, Luig and Shuna, and owe their name to the fact that they are composed mainly of metamorphic rocks, Easdale, Torsay and Luig being entirely slate, Seil mostly slate with some porphyrite in the north, and Shuna gneissose. The quarries provide occupation for most of the inhabitants. The steamers to and from Oban usually call at Luig and Easdale. SEIL (pop. 424), the most northerly, is connected with the mainland by means of Clachan bridge on its north-east side, near Rue. It measures 4 m. N. and S. by 2 m. E. and W. at its widest, and contains Kilbrandon church. Off a promontory on its west coast, divided only by a narrow strait, is the comparatively flat island of EASDALE (pop. 284), measuring roughly $\frac{1}{2}$ m. each way. The quarries have been worked since 1630 and yield some eight million slates every year. The experiment of leasing them to the workers on co-operative lines has been tried unsuccessfully. LUIG (pop. 620) is situated S. of Seil, is 6 m. long and $1\frac{1}{2}$ m. broad. TORSAY (pop. 7), 1 m. long by $\frac{1}{2}$ m. broad, lies off its north-east, and SHUNA (pop. 8), $2\frac{1}{2}$ m. long by $1\frac{1}{2}$ m. broad, off its south-east, shore.

SLATER, JOHN FOX (1815–1884), American philanthropist, son of John Slater (Samuel Slater's brother and partner), was born in Slatersville, Rhode Island, on the 4th of March 1815. He was educated in academies at Plainfield, Connecticut, and Wrentham and Wilbraham, Massachusetts. At seventeen he entered his father's woollen mill in Hopeville, Conn., of which he took charge in 1836. This and other mills he owned in partnership with his brother, William S. Slater, until 1873, when his brother took over the Slatersville Mills and he assumed sole ownership of the mills at Jewett City, Conn. In 1842 he removed from Jewett City to Norwich; there he helped to endow the Norwich Free Academy, to which his son presented the Slater Memorial Hall; and there he died on the 7th of May 1884. In 1882 he had made over to a board of ten trustees, incorporated in New York state, \$1,000,000 for "the uplifting of the lately emancipated population of the Southern states,

and their posterity, by conferring on them the benefits of Christian education." Among the original trustees of the Slater Fund were Rutherford B. Hayes, Morrison R. Waite, William E. Dodge, Phillips Brooks, Daniel C. Gilman, Morris K. Jesup and the donor's son, William A. Slater; and among members chosen later were Melville W. Fuller, William E. Dodge, Jr., Henry C. Potter, Cleveland H. Dodge and Seth Low. In 1909 by careful investment the fund had increased, in spite of expenditures, to more than \$1,500,000. The fund has been of great value in aiding industrial schools in the South, its largest beneficiaries being the Hampton Normal and Agricultural Institute of Hampton, Virginia, the Tuskegee Normal and Industrial Institute of Tuskegee, Alabama, Spelman Seminary in Atlanta, Georgia, Claflin University in Orangeburg, S.C., and Fisk University, in Nashville, Tennessee. At Winston-Salem, N.C., is the Slater State Normal and Industrial School, founded in 1892 and named after the founder of the fund. Other state normal schools for negroes have received assistance from the fund; and in some cases it has contributed directly to the school boards of Southern cities.

SLATER, SAMUEL (1768-1835), American textile manufacturer, was born in Belper, Derbyshire, England, on the 9th of June 1768. In 1783, the year after his father's death, he was apprenticed to Jedediah Strutt, his neighbour and a partner of Richard Arkwright in spinning cotton, and served under him six and a half years. Learning that the Pennsylvania legislature had granted £100 in 1789 to the inventor of a power carding machine, he removed to the United States in that year, but was unable because of British laws to bring with him drawings of cotton-spinning machinery. He wrote to Moses Brown of Providence, R.I., who had made unsuccessful attempts to manufacture cotton cloth, and in January 1790 on Brown's invitation went to Pawtucket, R.I., where he entered into a partnership with William Almy (Moses Brown's son-in-law) and Smith Brown, a kinsman of Moses Brown, designed (from memory) machines for cotton-spinning, and turned out some yarn in December of the same year. In 1799 he established in his mills one of the first Sunday Schools in America. In 1801 he built a factory in Rehoboth, Mass., and with his brother John, who joined him in 1804, established in 1806 the manufacturing village of Slatersville, in Smithfield township, Rhode Island. He began the manufacture of woollen cloth in 1815-1816 at Oxford, now Webster, Mass., where he had built cotton mills in 1812. In his later years he was interested in other textile mills and in iron foundries in Rhode Island. He died at Webster, Mass., on the 21st of April 1835. He has been called the "father of American manufactures" and it is no exaggeration to call him the founder of American cotton manufacturing.

See G.S. White, *Memoir of Samuel Slater* (2nd ed., Philadelphia, 1846).

SLATIN, SIR RUDOLF CARL VON (1857-), Anglo-Austrian soldier and administrator in the Sudan, was born on the 27th of June 1857 at Ober St Veit near Vienna. At the age of seventeen he made his first journey to the Sudan, reaching Khartoum by the Nile route in October 1875 in company with Theodor von Heuglin (*q.v.*). Thence he went through Kordofan to Dar Nuba, exploring the mountains of that region. He returned to Khartoum in consequence of a revolt of the Arabs against the Egyptian government. There Slatin met Dr Emin (Emin Pasha) and with him purposed visiting General C. G. Gordon at Lado, Gordon at that time being governor of the equatorial provinces. Slatin, however, was obliged to return to Austria without accomplishing his desire, but Emin went to Lado and at Slatin's request recommended the young traveller to Gordon for employment in the Sudan. In 1878, while Slatin was serving as a lieutenant in the crown prince Rudolf's regiment in the Bosnian campaign he received a letter from Gordon inviting him to the Sudan, of which country Gordon had become governor-general. At the close of the campaign Slatin received permission to go to Africa and he arrived at Khartoum in January 1879. After a brief period during which he was financial

inspector, Slatin was appointed mudir (governor) of Dara, the south-western part of Darfur, a post he held until early in 1881, when he was promoted governor-general of Darfur and given the rank of bey. While administering Dara, Slatin conducted a successful campaign against one of the Darfur princes in revolt, and as governor of Darfur he endeavoured to remedy many abuses. He had soon to meet the rising power of the mahdi Mahommed Ahmed (*q.v.*). Early in 1882 the Arabs in southern Darfur were in revolt. With insufficient resources and no succour from Khartoum, Slatin gallantly defended his province. Though victorious in several engagements he lost ground. His followers attributing his non-success to the fact that he was a Christian, Slatin nominally adopted Islam. But all hope of maintaining Egyptian authority vanished with the news of the destruction of Hicks Pasha's army and in December 1883 Slatin surrendered, refusing to make any further sacrifice of life in a hopeless cause. In the camp of the mahdi an attempt was made to use him to induce Gordon to surrender. This failing, Slatin was placed in chains, and on the morning of the 26th of January 1885, an hour or two after the fall of Khartoum, the head of Gordon was brought to the camp and shown to the captive. Slatin was kept at Omdurman by the khalifa, being treated alternately with savage cruelty and comparative indulgence. At length, after over eleven years' captivity, he was enabled, through the instrumentality of Sir Reginald (then Major) Wingate of the Egyptian Intelligence Department, to escape, reaching Egypt in March 1895. In a remarkable book, *Fire and Sword in the Sudan*, written in the same year and issued in English and German in 1896, Slatin gave not only, as stated in the sub-title, "a personal narrative of fighting and serving the dervishes" but a connected account of the Sudan under the rule of the khalifa. Raised to the rank of pasha by the khedive, Slatin received from Queen Victoria the Companionship of the Bath. On the eve of his surrender to the mahdi at Christmas 1883 he had resolved, if he regained his liberty, to use the knowledge he would acquire while in captivity for the eventual benefit of the country, and after a year's rest he took part, as an officer on the staff of the Egyptian army, in the campaigns of 1897-98 which ended in the capture of Omdurman. For his services in these campaigns he was made a K.C.M.G. and in 1899 was ennobled by the emperor of Austria. In 1900 he was appointed Inspector-General of the Sudan, in which capacity his mastery of Arabic and his profound knowledge of the land and peoples proved invaluable in the work of reconstruction undertaken by the Anglo-Egyptian government in that country. In 1907 he was made an honorary major-general in the British army.

SLAUGHTER-HOUSE, or ABATTOIR. In the United Kingdom slaughter-houses are of two kinds, those which belong to individual butchers and those which belong to public authorities; the former are usually called private slaughter-houses, the latter public slaughter-houses. Private slaughter-houses in existence in England before the passing of the Public Health Act 1875 were established without licence by the local authority, except in those towns to which the provisions of the Towns Improvement Clauses Act 1847, relating to slaughter-houses, were applied by special Act. By the Act of 1875 these provisions were extended to all urban districts. Subsequently to 1890 urban authorities adopting Part III. of the Public Health (Amendment Act) of that year could license for limited periods of not less than one year all slaughter-houses coming into existence after such adoption. In London, slaughter-houses have been licensed since 1855. Private slaughter-houses are frequently situated at the rear of the shop in which the meat is sold. Each consists of a compartment in which the animals are killed, and in association with this are the pounds in which a few animals can be kept pending slaughter. These buildings are regulated by by-laws made under the Public Health Act by the several urban sanitary authorities. The by-laws usually provide for the floor to be made of jointless paving, to ensure that the earth shall not be fouled in the process of slaughtering; for the walls to be cemented to a certain height above the floor, to provide a surface which can be easily cleaned; for the doors

to be of sufficient width to enable cattle to enter the slaughter-house without difficulty; and for the poundage to have floor-space sufficient for each animal. These by-laws also provide for water-supply to the slaughter-house for cleansing, and to the pounds for the use of the animals, for the periodical lime-whiting of the premises, and for the observance of care to prevent the blood escaping into the drains. Private slaughter-houses, especially those which were established without licence, are often in too close proximity to inhabited buildings. In towns in which by-laws are not strictly enforced they are often sources of nuisance. Private slaughter-houses are also objectionable on other grounds. They lead to the driving of cattle through the towns on the way to the slaughter-house, sometimes to the danger of the inhabitants, and they render impossible any systematic inspection of meat. It is in connexion with the increasing demand for such meat-inspection that the objections to private slaughter-houses are most manifested; and hence, in countries in which the law provides for the obligatory inspection of meat, private slaughter-houses are ceasing to exist, and public abattoirs are being substituted for them.

Public slaughter-houses are of great antiquity and owe their beginnings to Roman civilization. In 300 B.C. animals were slaughtered in the open air in the Forum in Rome.

Public. Later, to meet the convenience of butchers, a house on the river Tiber was given to them for the purposes of their trade. This house had been occupied by a Roman citizen named Macellus. The building appears to have retained his name, and hence the *macellum* of Livy's time subsequently erected in the Forum, which, *inter alia*, is believed to have contained rooms for the slaughter of animals. The rooms actually used for slaughter were *lanienae*, from *laniare*, but the word *macellum* has been preserved in the Italian *macellare*, to slaughter, and in the German *metzen* or *metzeln*, and in the English *massacre*.

Public slaughter-houses existed in many large towns of Germany in medieval times under the name of *Kuttelhöfe*; they were mostly situated on the rivers, which provided an ample supply of water, and afforded means for the removal of blood. Some of these *Kuttelhöfe* continued to exist within recent years. No law other than a town law governed their establishment and management. They were owned or controlled by the butchers' corporations or guilds, but all butchers were not members of the guilds; and this appears to have led to a ministerial order in Prussia in 1826, which made it inadmissible to require every butcher to slaughter in them. Shortly after the middle of the 19th century the prevalence of trichinosis compelled a return to the use of public slaughter-houses; and the enactment of laws in 1868 and 1881 in Prussia, and similar laws in other German states, empowered urban authorities to require that all animals killed in towns should be slaughtered in public slaughter-houses. (Schwarz, *Bau, Einrichtung und Betrieb öffentlicher Schlacht- und Viehhöfe*.)

In France, in the 15th and 16th centuries, numerous towns were provided with public slaughter-houses. It was required that they should be used by all persons killing animals the flesh of which was to be sold; but their position and the conditions they created were such as urgently to demand amelioration, and some effort was made in this direction in 1567. It was not, however, until the time of Napoleon I. that it was decided that the atrocious nuisance which these slaughter-houses created should be removed. By decrees passed in 1807 and 1810 public slaughter-houses were required to be provided in all large towns in France, the needs of Paris being determined by a Commission, which recommended the establishment of five abattoirs or public slaughter-houses. In 1838 the requirement that public slaughter-houses should be provided in large centres was extended to all towns in France, and it was further required that the slaughter-houses should be situated at a distance from dwelling-houses.

In 1867 the large abattoir of La Villette was constructed to meet the needs of Paris, two of the five constructed under the decrees of Napoleon being closed. In 1898 the additional abattoir of Vaugirard was opened, and the remainder of the five were

closed except Villejuif, which was restricted in its use to the slaughter of horses for human food.

In Belgium public slaughter-houses have been provided in all the large and many of the small towns. In Switzerland there are public slaughter-houses in nearly all places having more than two thousand inhabitants. In Italy a law of 1890 required that public slaughter-houses should be erected in all communities of more than six thousand inhabitants. In Austria a law of 1850 required the provision of such places in all the large and medium-sized towns. In Norway and Sweden a law of 1892 required the provision of public slaughter-houses; but it has only partially been fulfilled. In Denmark there are public slaughter-houses in a few towns, including Copenhagen. In the Netherlands and Rumania a number of public slaughter-houses have been provided. It is in Germany, however, that the greatest progress has been made, and especially in Prussia, where, Professor Ostertag of Berlin states, they have "grown out of the ground" (*Handbuch der Fleischbeschau*); so much so that in 1897 there were 321 public slaughter-houses in the kingdom, 40 of which were provided in the period 1895-1897. A later work (*Les Abattoirs publics*, by J. de Loverdo, H. Martel and Mallet, 1906) gives the number of public slaughter-houses as 839 in Germany, 84 in England, 912 in France and nearly 200 in Austria. In some other countries public slaughter-houses have been provided, but they are of a primitive form.

In England the power to provide public slaughter-houses was given by the Public Health Act 1848 to the local authorities of cities, towns, boroughs, &c., to which the Act was applied by Order; and later, was given to all urban sanitary authorities by section 169 of the Public Health Act 1875. These authorities have, however, suffered from the disadvantage that they have had no power to control the continuance of private slaughter-houses (except in so far as these were annually licensed), and they have therefore been unable to ensure that the public provision would be used by the butchers. In Ireland and Scotland much the same powers exist; but in Scotland, if the burgh commissioners provide a public slaughter-house, no other slaughter-house can be used. Some English local authorities have obtained in local acts powers similar to those possessed by the burgh commissioners in Scotland. The need for still wider control is, however, manifest. Belfast may be cited as an illustration of a town in which a public slaughter-house has been provided, and in which there are no private slaughter-houses, but which receives a quantity of meat from private slaughter-houses erected beyond the boundaries of the city. The outcome of these difficulties is that the power of local authorities to provide public slaughter-houses has been but sparingly used. There is no law requiring that meat shall be inspected before sale for human food, hence there is no obligation upon butchers to make use of public establishments for the slaughter of their cattle. This, indeed, is the position of some of the Continental slaughter-houses; but the increasing strictness of the laws as to meat-inspection, and especially in requiring that all animals shall be inspected at the time of slaughter, is making the use of public slaughter-houses obligatory. Such a law now exists in Belgium, where it has served as a model to other countries. An Imperial German law of 1900 extends to all parts of that country the same requirement, and enacts that "neat cattle, swine, sheep, goats, horses, and dogs, the meat of which is intended to be used for food for man, shall be subjected to an official inspection both before and after slaughter." Antecedent to that year it was in force in southern Germany, in Brunswick and Saxony, but only in some parts of northern, western and central Germany. A similar law exists in Norway and Sweden, but, as already stated, provision of public slaughter-houses is still meagre; in Austria-Hungary there is a similar requirement, but Ostertag states that the administration is lacking in uniformity; in Italy, he writes, the regulation of meat-inspection having been left to provincial authorities, thorough reform is impossible. In the British colonies advance is being made. New Zealand has a number of public slaughter-houses. The Meat Supervision Act of Victoria empowers the Board of Health to make regulations for ensuring the wholesomeness of meat supplies. Regulations have been made for Melbourne. Cattle are killed in public slaughter-houses and the carcasses are stamped, thus showing in which slaughter-house they have been killed.

The planning and construction of public slaughter-houses have been the subject of excellent treatises by German writers, among whom may be mentioned Dr Oscar Schwarz, of Stolp, and Herr Osthoff, a former city architect of Berlin, to whose works the writer of this article is largely indebted for information. After inspection of the public slaughter-houses in England and in a number of Continental cities, the writer considers that those of Germany are most deserving of description.

The slaughter-house should be situated outside the town, or so

SLAUGHTER-HOUSE

placed as to be isolated, and approached by wide roads, so that if cattle are driven through them there should not be interference with the traffic. If possible, the slaughter-house should be connected with the railway system by a branch line, with a platform which has an impervious surface capable of being readily cleansed and disinfected. The most convenient shape of the site is a rectangle or square, having one side abutting on the principal road and another side bounded by the railway. A cattle-market is usually provided in connexion with the slaughter-house, and the position should be such that cattle brought by train can be taken immediately into the cattle-market and from the market or the railway to the slaughter-house. The cattle-market should be entirely separate from the slaughter-house area. Osthoff states (*Schlachthöfe für kleine und mittelgrosse Städte*) that the area of the slaughter-house should be as follows:—

Towns of 5,000– 7,000 inhabitants	Sq. Metres.	0.40 per inhabitant.
" 7,000–10,000 "	" 0.35 "	" "
" 10,000–50,000 "	" 0.30 "	" "
" over 50,000 "	" 0.25 "	" "

It is of course assumed that the population derives the whole of its meat-supply from this source.

The parts required, according to Dr Oscar Schwarz, are: (1) an administrative block; (2) a slaughtering-hall, with a special room for scalding swine; (3) cattle lairs; (4) room for scalding and cleansing tripe and intestines; (5) an engine-house; (6) separate slaughtering-room, with lairs for animals suffering from, or suspected to be suffering from, contagious disease.

In small towns the slaughtering-hall and room for cleansing intestines may, to save cost of construction, be under the same roof. A necessary adjunct is a cold chamber, to which carcasses can be removed from the slaughtering-hall. The actual slaughtering compartment has been built on two plans—one providing a separate slaughtering-room for each butcher, the other a common slaughtering-hall. The latter is greatly to be preferred, inasmuch as it is the only arrangement which gives adequate opportunity for inspection by the officials whose duty it is to examine the meat. The slaughter-house in Berlin was constructed on the separate-room system; but the system gave rise to difficulties of inspection. During recent years in Germany the practice has been to construct slaughter-houses with common halls. The part occupied by each butcher at the time of slaughtering is, however, sufficiently distinguishable, and at Hamburg the position of the hooks hanging from above divides the hall into separate areas, each of which has an entrance from without. Schwarz gives the following as the most convenient arrangement of the buildings: The administrative building (with the house of the superintendent) at the entrance, so that from it the entrance and whole place can be seen. In the vicinity should be a weighing-machine for cattle. The centre of the area is occupied by the slaughtering-halls, and the lairs belonging to them are only separated from them by a road or passage way. The manure-house and tripe-house must be easily accessible from all the slaughtering-halls, but not in direct communication with them, or smell from them may enter the hall.

The manure-house must abut upon a road, to enable its contents to be removed without passing through the premises. Next to the tripe and pig-scalding houses is the engine-house. The building for diseased animals, with the slaughter-house for them, must be isolated from all other buildings. All buildings should be so arranged that they may be capable of extension as the population of the town increases. By the provision of grass plots and trees every effort should be made to relieve the premises of the dreary appearance they will otherwise present.

Cold chambers, although not included among the absolute essentials for small slaughter-houses, are an almost necessary adjunct, for they serve for the preservation of the meat after slaughter, and are indeed absolutely necessary when the slaughter-house is of large size. The cold chamber should be situated opposite the slaughtering-halls, so that carcasses can be conveyed by overhead carriers directly from these halls to it. Within the cold chamber are separate compartments or cages of different sizes, rented by butchers, who are thus able to preserve their meat and draw upon their supply as their business may require. The cold chamber is therefore a great convenience to the butchers, and is a source of profit to the authority owning the slaughter-house. A frequent adjunct to large German slaughter-houses is the "Freibank," at which is sold at low price cooked meat of quality which renders it unfit to be sold under ordinary conditions.

Much depends upon the design and details of construction of the several component parts of a public slaughter-house, upon the provision of adequate lighting and ventilation of the buildings, upon the construction of walls, floors, and fittings which are impermeable and can be readily cleansed, and upon the provision of an abundant water-supply. It is essential that the buildings should be well lighted, especially those which are used for the slaughtering operations, or for any detailed examination of meat which may be needed—such, for instance, as for trichinae. The material generally used for the floor of the slaughtering-hall is cement or granolithic pavement, which must not present so smooth a surface as to be

slippery. The floor must have an adequate fall, so that the washings may discharge into a system of drainage.

The plans of the public slaughter-house of Neusalz on the Oder and of Düsseldorf well illustrate the provision which is now made respectively for a small and for a large town. The writer is indebted to Dr Schwarz for the plan and a description of the slaughter-house at Neusalz. It was completed in October 1899, and is erected on the Oder below the town, on land of an area of 8500 square metres. The building was carefully planned by the town architect, Herr Brannaschk, so as to admit of increase within the next 10-20 years. Brickwork is used for the construction of the buildings, and the roofs are of wood and cement. The walls of all the rooms except those of the administrative block are lined partly with polished stone, partly with cement, to a height of two metres above the floor. The floors consist of stone slabs set in cement (fig. 1).

The administrative block (A) is situated at the entrance and is a three-storey building, containing an office, a room for examination of meat for trichinae, and dwelling-rooms for the superintendent. In the central block (B) two slaughter-halls are provided (a) for swine and (b) for cattle and sheep. With these are associated (c) an engine-house, (d) a boiler and fuel room, (e) a workshop, (f) a passage communicating with the two slaughter-halls, (g) a cold chamber, (h) ante-rooms to the cold chamber, (i) dressing-rooms for assistants, and (k) stabling. The cold chamber has an area of 169 square metres and contains 28 cells of various sizes. In order to attain an even temperature of 2° C. to 4° C., air rendered cold by

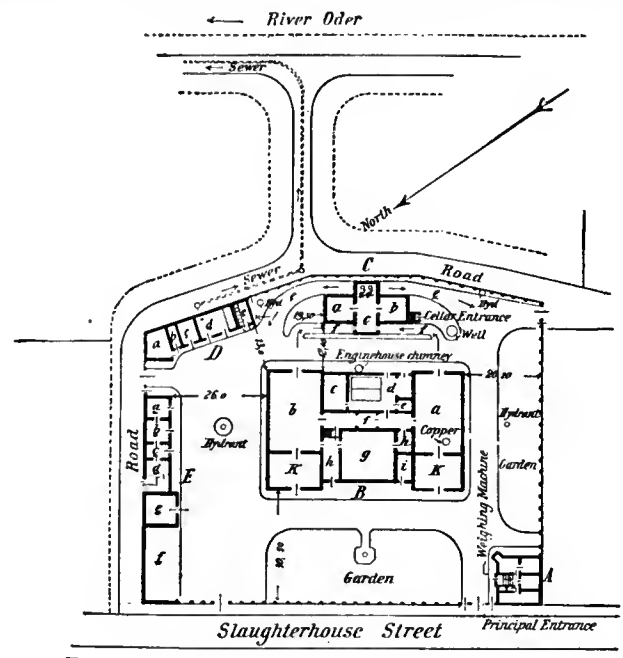

The figures give measurements in metres.

FIG. 1.—Plan of Public Slaughter-house at Neusalz on the Oder (1899).

the ammonia process is conveyed to the room by channels. In the engine-house (c) are a 48-horse-power engine, the cooling machines, and the water-pump, which pumps water from a well into two cisterns situated in a water-tower over the passage between the two slaughter-halls. In the outbuilding (C) are (a) and (b) the gut-washing rooms for cattle and swine respectively, (c) an ante-room with (d) openings for manure to be thrown into carts. The road (e) slopes downwards, so as to enable a cart to be driven below the openings through which the manure is discharged. In the outbuilding (D) are (a) a horse slaughtering-room, (b) a stable, (c) a bathroom, (d) a room in which the floor washings are treated chemically or by filtration before discharge into the river, and (e) a urinal. In the outbuilding (E) are (a) a stable for sick animals, (b) a slaughter-house for diseased animals, (c) a sterilizing-room for meat to be subsequently sold in (d) the "Freibank," (e) a stable for horses, and (f) a cart-shed. The slaughter-house is lighted with electric light. The cost of the buildings is about £19,000, and provides for a population of 20,000 to 25,000 inhabitants.

The slaughter-house at Düsseldorf is on a more extensive scale. It was erected at an estimated cost of from £162,000 to £175,000, and covers an area of about 23.2 acres. Provision is made for each department to be practically doubled in size. It is unnecessary to describe it in any detail, but it may be noted that it has a market associated with it, and that separate slaughter-halls are provided for large cattle, for small cattle (sheep and calves), and for swine (fig. 2). The population of Düsseldorf was 212,949 in 1900

carcase made to travel along the line. The carcase is next lowered to the floor, the hide taken off, the head and feet cut off, and the internal parts removed. The carcase again travels along the trolley-line to a place where it is divided into halves, which then, after washing, travel to the refrigeration-room, being trimmed while on the way. The extent of the business may be judged by the fact that over 400 cattle are killed per hour in the slaughtering-room. The cooling-rooms are so large that 13,000 halves of beef hang there at one time. The method of dealing with sheep is very similar. The animals are driven into narrow alleys, then into the slaughter-room, where their throats are cut. They next travel along a route where their skins and the internal organs are removed, and finally pass into the cooling-rooms. Swine are raised in the slaughter-room on to the trolley-line by a chain attached to the animals' feet and to a solid disk or wheel, which in revolving carries them until a mechanical contrivance throws the chain upon the trolley-line, where a knife is plunged into their throat. In its subsequent passage the carcase is scalded, scraped by a machine through which it passes, later-decapitated, the internal parts removed, and the interior washed. The carcase then travels to the cooling-room.

In 1904 a British departmental (Admiralty) committee on the humane slaughtering of animals recommended that all animals should be stunned before being bled, and, with a view to sparing animals awaiting slaughter the sights and smells of the slaughter-house, that "cattle should, when possible, be slaughtered screened off from their fellows. This can be arranged in moderate-sized abattoirs by dividing up the side of the slaughter-chamber opposite to the entrance doors into stalls somewhat similar to those in a stable, but considerably wider. For quiet home-grown cattle a width of 10 ft. is sufficient, but where wilder cattle have to be killed a wider space is probably desirable. It is important that these stalls should be so arranged as not to screen the operations of slaughter from the view of the inspecting officials. Immediately after the carcasses have been bled, they should be moved on to and 'dressed' in an adjoining room, screened off from the view of animals entering the slaughter-chamber. This is easily accomplished by hitching a rope (from the winch, if necessary) round the head or forelegs of the carcase, and by dragging it along the floor for the short distance into the 'dressing room.' The slaughter-stall should then at once be flushed down with the hose, so as to remove all traces of blood. This method leaves the slaughter spaces clear for the next batch of animals, whereas under the existing system there is either a loss of time through the slaughter spaces being blocked up with dressing operations, or else the next batch of animals on being brought into the slaughter-chamber are confronted with mutilated and disembowelled carcasses."

The provision of public slaughter-houses enables control to be exercised over the methods of slaughtering. The above-mentioned committee state that they practically tested a large number of appliances designed for felling and stunning animals previous to "pithing," among which they mention the Bruneau and Baxter masks, the Greener patent killer, the Blitz instrument, and the Wackett punch, all of which are suitable for quiet cattle or horses. In view of the difficulty of adjusting these instruments in the case of wild or restive animals, the committee express the opinion that the poll-axe when used by an expert is on the whole the most satisfactory implement, but they recommend that no man should be permitted to use the poll-axe on a living animal until he has gone through a thorough course of training, firstly upon a dummy animal and secondly upon dead bodies. Calves, the committee state, should be stunned by a blow on the head with a club. With respect to the method of slaughter of sheep the committee discuss the method usually adopted in England, which is "to lay the sheep on a wooden crutch and then to thrust a knife through the neck below the ears, and with a second motion to insert the point, from within, between the joints of the vertebrae, thus severing the spinal cord." Observations made for the committee by Professor Starling showed that the interval between the first thrust of the knife and complete loss of sensibility varied from five to thirty seconds, and they therefore recommended that sheep should be stunned before being stuck, a practice required in Denmark, many parts of Germany, and Switzerland. It is necessary that the sheep should be struck on the top of the head between the ears and not on the forehead. The insensibility produced by the blow was found to last fully twenty seconds, a period sufficiently long for the killing to be completed if the animal is laid on the crutch before being stunned. The stunning of pigs, the committee recommended, should be insisted upon in all cases, and not, as sometimes at present, only practised in the case of large pigs which give trouble or with a view to the avoidance of noise.

The Jewish method of slaughter by cutting the throat is condemned by the committee after careful observation and after receiving reports by Sir Michael Foster and Professor Starling, the chief objection to this method being that it fails in the primary requirements of rapidity, freedom from unnecessary pain, and instantaneous loss of sensibility.

The use of public slaughter-houses has not been found to affect the prices of meat, although one of the numerous arguments used by butchers against being required to slaughter in public slaughter-houses was that they would have this effect. Inquiry on this

subject by a Swedish veterinary surgeon of Stockholm, Kjerrulf, of 560 towns possessing public slaughter-houses, elicited replies from 388. Of these, 261 towns declared that as a result of the compulsory use of the abattoirs and compulsory meat inspection the price of meat had not been raised. In the case of twenty-two towns prices rose temporarily but soon reverted to their normal level. In many cases it was alleged that the temporary rise was due, not to the abattoir, but to other causes, notably the scarcity of live stock (*Our Slaughter-house System* by C. Cash, and *The German Abattoir* by Hugo Heiss, 1907).

The increasing recognition in European countries of the need for inspection, at the time of slaughter, of the flesh of all cattle intended to supply food for man, the necessity for the provision of public slaughter-houses to make such inspection practicable, the convenience which these slaughter-houses afford to those engaged in the business of butcher, combine to ensure that, at any rate in all populous places, they will in time entirely supersede private slaughter-houses, which offer none of these advantages. No doubt the provision of public slaughter-houses will continue to be opposed by the butchers' trade so long as private slaughter houses are permitted, and, as already stated, local authorities in England are discouraged from making public provision by their inability to prevent the continuance of the use of all existing private slaughter-houses. Probably the extension to English local authorities of the power which the law of Scotland gives to the commissioners of Scottish burghs of closing private slaughter-houses when a public slaughter-house has been provided, would facilitate the much-needed substitution of public for private slaughter-houses. (S. F. M.)

SLAVE COAST. The name given to that part of the coast of West Africa extending from the river Volta to the Niger delta; forming part of the Guinea coast (see GUINEA). From the beginning of the 16th to the end of the 18th century this region was a principal resort of the Europeans engaged in the slave trade. Politically the Slave Coast is divided between Germany, France and Great Britain, the German section forming part of Togoland (*q.v.*), the French section the seaboard of Dahomey (*q.v.*), and the British section the Lagos province of Nigeria (see LAGOS).

SLAVERY. It appears to be true that, in the words of Dunoyer, the economic régime of every society which has recently become sedentary is founded on the slavery of the industrial professions. In the hunter period the savage warrior does not enslave his vanquished enemy, but slays him; the women of a conquered tribe he may, however, carry off and appropriate as wives or as servants, for in this period domestic labour falls almost altogether on their sex. In the pastoral stage slaves will be captured only to be sold, with the exception of a few who may be required for the care of flocks or the small amount of cultivation which is then undertaken. It is in proportion as a sedentary life prevails, and agricultural exploitation is practised on a larger scale, whilst warlike habits continue to exist, that the labour of slaves is increasingly introduced to provide food for the master, and at the same time save him from irksome toil. Of this stage in the social movement slavery seems to have been, as we have said, a universal and inevitable accompaniment.

But wherever theocratic organizations established themselves slavery in the ordinary sense did not become a vital element in the social system. The members of the lowest class were not in a state of individual subjection: the entire caste to which they belonged was collectively subject. It is in the communities in which the military order obtained an ascendancy over the sacerdotal, and which were directly organized for war, that slavery (as the word is commonly understood) had its natural and appropriate place. It is not merely that in its first establishment slavery was an immense advance by substituting for the immolation of captives, often accompanied by cannibalism, their occupation in labour for the benefit of the victor. This advantage, recalled by an old though erroneous¹

¹ *Servus* is not cognate with *servare*, as has often been supposed; it is really related to the Homeric *εἰσπερος* and the verb *εἶρω*, with which the Latin *sero* is to be connected. It may be here mentioned that *slave* was originally a national name; it meant a man of Slavonic race captured and made a bondman to the Germans. "From the Euxine to the Adriatic, in the state of captives or subjects, . . . they [the Slavonians] overspread the land, and the national appellation of the *Slaves* has been degraded by chance or malice from the signification of glory to that of servitude" (Gibbon, *Decline and Fall*, ch. lv.). The historian alludes to the derivation of the national name from *slava*, glory. See Skeat's *Etym. Dict.*, s.v.; see also SLAVS.

etymology, is generally acknowledged. But it is not so well understood that slavery discharged important offices in the later social evolution—first, by enabling military action to prevail with the degree of intensity and continuity requisite for the system of incorporation by conquest which was its final destination; and, secondly, by forcing the captives, who with their descendants came to form the majority of the population in the conquering community, to an industrial life, in spite of the antipathy to regular and sustained labour which is deeply rooted in human nature. As regards the latter consideration, it is enough to say that nowhere has productive industry developed itself in the form of voluntary effort; in every country of which we have any knowledge it was imposed by the strong upon the weak, and was wrought into the habits of the people only by the stern discipline of constraint. From the former point of view the freeman, then essentially a warrior, and the slave were mutual auxiliaries, simultaneously exercising different and complementary functions—each necessary to the community. In modern slavery, on the other hand, where the occupations of both parties were industrial, the existence of a servile class only guaranteed for some of them the possibility of self-indulgent ease, whilst it imposed on others the necessity of indigent idleness.

It was in the Roman state that military action—in Greece often purposeless and, except in the resistance to Persia, on the whole fruitless—worked out the social mission which formed its true justification. Hence at Rome slavery also most properly found its place, so long as that mission was in progress of accomplishment. As soon as the march of conquest had reached its natural limit, slavery began to be modified; and when the empire was divided into the several states which had grown up under it, and the system of defence characteristic of the middle ages was substituted for the aggressive system of antiquity, slavery gradually disappeared, and was replaced by serfdom.

We have so far dealt with the political results of ancient slavery, and have found it to have been in certain respects not only useful but indispensable. When we consider its moral effects, whilst endeavouring to avoid exaggeration, we must yet pronounce its influence to have been profoundly detrimental. In its action on the slave it marred in a great measure the happy effects of habitual industry by preventing the development of the sense of human dignity which lies at the foundation of morals. On the morality of the masters—whether personal, domestic, or social—the effects of the institution were disastrous. The habit of absolute rule, always dangerous, was peculiarly corrupting when it penetrated every department of daily life, and when no external interference checked individual caprice in its action on the feelings and fortunes of inferiors. It tended to destroy the power of self-command, and exposed the master to the baneful influences of flattery. As regards domestic morality, the system offered constant facilities for libertinism, and tended to subvert domestic peace by compromising the dignity and ruining the happiness of the wife. The sons of the family were familiarized with vice, and the general tone of the younger generation was lowered by their intimate association with a despised and degraded class. These deplorable results were, of course, not universally produced; there were admirable exceptions both among masters and among slaves—instances of benevolent protection on the one side and of unselfish devotion on the other; but the evil effects without doubt greatly preponderated.

Greece.—We find slavery fully established in the Homeric period. The prisoners taken in war are retained as slaves, or sold (*Il.* xxiv. 752) or held at ransom (*Il.* vi. 427) by the captor. Sometimes the men of a conquered town or district are slain and the women carried off (*Od.* ix. 40). Not unfrequently free persons were kidnapped by pirates and sold in other regions, like Eumæus in the *Odyssey*. The slave might thus be by birth of equal rank with his master, who knew that the same fate might befall himself or some of the members of his family. The institution does not present itself in a very harsh form in Homer, especially if we consider (as Grote suggests) that "all classes were much on a level in taste, sentiment and instruction." The male slaves were employed in the tillage of the land and the tending of cattle, and the females in domestic work and household manufactures. The principal slaves often enjoyed the confidence of their masters and had important duties entrusted to them; and, after lengthened and meritorious

service, were put in possession of a house and property of their own (*Od.* xiv. 64). Grote's idea that the women slaves were in a more pitiable condition than the males does not seem justified, except perhaps in the case of the *aletrides*, who turned the household mills which ground the flour consumed in the family, and who were sometimes overworked by unfeeling masters (*Od.* xx. 110-119). Homer marks in a celebrated couplet his sense of the moral deterioration commonly wrought by the condition of slavery (*Od.* xvii. 322).

It is, however, in historic Greece, where we have ample documentary information, that it is most important to study the system. The sources of slavery in Greece were: (1) Birth, the condition being hereditary. This was not an abundant source, women slaves being less numerous than men, and wise masters making the union of the sexes rather a reward of good service than a matter of speculation (*Xen. Oecon.* 9. 5). It was in general cheaper to buy a slave than to rear one to the age of labour. (2) Sale of children by their free parents, which was tolerated, except in Attica, or their exposure, which was permitted, except at Thebes. The consequence of the latter was sometimes to subject them to a servitude worse than death, as is seen in the plays of Plautus and Terence, which, as is well known, depict Greek, not Roman, manners. Freemen, through indigence, sometimes sold themselves, and at Athens, up to the time of Solon, an insolvent debtor became the slave of his creditor. (3) Capture in war. Not only Asiatics and Thracians thus became slaves, but in the many wars between Grecian states, continental or colonial, Greeks were reduced to slavery by men of their own race. Callicratidas pronounced against the enslavement of Greeks by Greeks, but violated his own principle, to which, however, Epaminondas and Pelopidas appear to have been faithful. (4) Piracy and kidnapping. The descents of pirates on the coasts were a perpetual source of danger; the pirate was a gainer either by the sale or by the redemption of his captives. If ransomed, the victim became by Athenian law the slave of his redeemer till he paid in money or labour the price which had been given for him. Kidnappers (*andrapodistæ*) carried off children even in cities, and reared them as slaves. Whether from hostile forays or from piracy, any Greek was exposed to the risk of enslavement. (5) Commerce. Besides the sale of slaves which took place as a result of the capture of cities or other military operations, there was a systematic slave trade. Syria, Pontus, Lydia, Galatia, and above all Thrace were sources of supply. Egypt and Ethiopia also furnished a certain number, and Italy a few. Of foreigners, the Asiatics bore the greatest value, as most amenable to command, and most versed in the arts of luxurious refinement. But Greeks were highest of all in esteem, and they were much sought for foreign sale. Greece proper and Ionia supplied the petty Eastern princes with courtesans and female musicians and dancers. Athens was an important slave market, and the state profited by a tax on the sales; but the principal markets were those of Cyprus, Samos, Ephesus and especially Chios.

The slaves were employed either in domestic service—as household managers, attendants or personal escorts—or in work of other kinds, agricultural or urban. In early Attica, and even down to the time of Pericles, the landowners lived in the country. The Peloponnesian War introduced a change; and after that time the proprietors resided at Athens, and the cultivation was in the hands of slaves. In manufactures and commerce, also, servile gradually displaced free labour. Speculators either directly employed slaves as artisans or commercial and banking agents, or hired them out, sometimes for work in mines or factories, sometimes for service in private houses, as cooks, flute-players, &c., or for viler uses. There were also public slaves; of these some belonged to temples, to which they were presented as offerings, amongst them being the courtesans who acted as *hieroduli* at Corinth and at Eryx in Sicily; others were appropriated to the service of the magistrates or to public works; there were at Athens 1200 Scythian archers for the police of the city; slaves served, too, in the fleets, and were employed in the armies,—commonly as workmen, and exceptionally as soldiers.

The condition of slaves at Athens was not in general a wretched one. Demosthenes (*In Mid.* p. 530) says that, if the barbarians from whom the slaves were bought were informed of the mild treatment they received, they would entertain a great esteem for the Athenians. Plautus in more than one place thinks it necessary to explain to the spectators of his plays that slaves at Athens enjoyed such privileges, and even licence, as must be surprising to a Roman audience. The slave was introduced with certain customary rites into his position in the family; he was in practice, though not by law, permitted to accumulate a private fund of his own; his marriage was also recognized by custom; though in general excluded from sacred ceremonies and public sacrifices, slaves were admissible to religious associations of a private kind; there were some popular festivals in which they were allowed to participate; they had even special ones for themselves both at Athens and in other Greek centres. Their remains were deposited in the family tomb of their master, who sometimes erected monuments in testimony of his affection and regret. They often lived on terms of intimacy either with the head of the house or its younger members; but it is to be feared that too often this intimacy was founded, not on mutual respect, as in the heroic example of Ulysses and Eumæus, but on insolent self-assertion on the one side and a spirit of

Historic period—sources of slavery.

Employments of slaves.

Condition.

unworthy compliance on the other, the latter having its *raison d'être* in degrading services rendered by the slave. Aristophanes and Plautus show us how often resort was had to the discipline of the lash even in the case of domestic slaves. Those employed in workshops, whose overseers were themselves most commonly of servile status, had probably a harder lot than domestics; and the agricultural labourers were not infrequently chained, and treated much in the same way as beasts of burden. The displeasure of the master sometimes dismissed his domestics to the more oppressive labours of the mill or the mine. A refuge from cruel treatment was afforded by the temples and altars of the gods and by the sacred groves. Nor did Athenian law leave the slave without protection. He had, as Demosthenes boasts, an action for outrage like a freeman, and his death at the hand of a stranger was avenged like that of a citizen (Eurip. *Hec.* 288), whilst, if caused by his master's violence, it had to be atoned for by exile and a religious expiation. Even when the slave had killed his master, the relatives of the house could not themselves inflict punishment; they were obliged to hand him over to the magistrate to be dealt with by legal process. The slave who had just grounds of complaint against his master could demand to be sold; when he alleged his right to liberty, the law granted him a defender and the sanctuaries offered him an asylum till judgment should be given. Securities were taken against the revolt of slaves by not associating those of the same nationality and language; they were sometimes fettered to prevent flight, and, after a first attempt at escape, branded to facilitate their recovery. There were treaties between states for the extradition of fugitives, and contracts of mutual assurance between individuals against their loss by flight. Their inclination to take advantage of opportunities for this purpose is shown by the number that escaped from Athens to join the Spartans when occupying Decleia. There were formidable revolts at the mines of Laurium, and more than once in Chios. The evidence of slaves—women as well as men—was often, with the consent of their masters, taken by torture; and that method is generally commended by the orators as a sure means of arriving at the truth.

The slave could purchase his liberty with his *peculium* by agreement with his master. He could be liberated by will, or, during his master's life, by proclamation in the theatre, the law courts, or other public places, or by having his name inscribed in the public registers, or, in the later age of Greece, by sale or donation to certain temples—an act which did not make the slave a hierodulus but a freeman. Conditions were sometimes attached to emancipation, as of remaining for life or a definite time with the former master, or another person named by him, or of performing some special service; payments or rights of succession to property might also be reserved. By manumission the Athenian slave became in relation to the state a metic, in relation to his master a client. He was thus in an intermediate condition between slavery and complete freedom. If the freedman violated his duties to his patron he was subject to an action at law, and if the decision were against him he was again reduced to slavery. He became a full member of the state only, as in the case of foreigners, by a vote in an assembly of six thousand citizens; and even this vote might be set aside by a *graphê paranomôn*. Slaves who had rendered eminent services to the public, as those who fought at Arginusae and at Chaeronea, were at once admitted to the status of citizens in the class of (so-called) Plataeans. But it would appear that even in their case some civic rights were reserved and accorded only to their children by a female citizen. The number of freedmen at Athens seems never to have been great. (See further GREECE, *Ancient History*, § 5.)

It is well known that Aristotle held slavery to be necessary and natural, and, under just conditions, beneficial to both parties in the relation—views which were correct enough from the political side, regard being had to the contemporary social state. His practical motto, if he is the author of the *Economics* attributed to him, is—"no outrage, and no familiarity." There ought, he says, to be held out to the slave the hope of liberty as the reward of his service. Plato condemned the practice, which the theory of Aristotle also by implication sets aside as inadmissible, of Greeks having Greeks for slaves. In the *Laws* he accepts the institution as a necessary though embarrassing one, and recommends for the safety of the masters that natives of different countries should be mixed and that they should all be well treated. But, whilst condemning harshness towards them, he encourages the feeling of contempt for them as a class. The later moral schools of Greece scarcely at all concern themselves with the institution. The Epicurean had no scruple about the servitude of those whose labours contributed to his own indulgence and tranquillity. The Stoic regarded the condition of freedom or slavery as an external accident, indifferent in the eye of wisdom; to him it was irrational to see in liberty a ground of pride or in slavery a subject of complaint; from intolerable indignity suicide was an ever-open means of escape. The poets—especially the authors of the New Comedy—strongly inculcate humanity, and insist on the fundamental equality of the slave. The celebrated "homo sum" is a translation from Alexis, and the spirit of it breathes in many passages of the Greek drama. A fragment of Philemon declares, as if in reply to Aristotle, that not nature, but fortune, makes the slave. Euripides, as might be expected from his humanitarian cast of sentiment, and

the "premature modernism" which has been remarked in him, rises above the ordinary feelings of his time in regard to the slaves. As Paley says, he loves "to record their fidelity to their masters, their sympathy in the trials of life, their gratitude for kindness and considerate treatment, and their pride in bearing the character of honourable men. . . . He allows them to reason, to advise, to suggest; and he even makes them philosophize on the follies and the indiscretions of their superiors" (compare *Med.* 54; *Orest.* 869; *Hel.* 728; *Ion.* 854; *Frag. Melan.* 506; *Phrix.* 823). But we are not to suppose that even he, latitudinarian and innovator as he was, could have conceived the possibility of abolishing an institution so deeply rooted in the social conditions, as well as in the ideas, of his time.

(For the Helots in Laconia, see HELOTS.)

Rome.—We have already observed that the Roman system of life was that in which slavery had its most natural and relatively legitimate place; and accordingly it was at Rome that, as Blair has remarked, the institution was more than anywhere else "extended in its operation and methodized in its details."

We must distinguish from the later slavery at Rome what Mommsen calls "the old, in some measure innocent," slavery, under which the farmer tilled the land along with his slave, or, if he possessed more land than he could manage, placed the slave—either as a steward, or as a sort of lessee obliged to render up a portion of the produce—over a detached farm. Though slaves were obtained by the early victories of Rome over her Italian neighbours, no large number was employed on the small holdings of those periods. But the extension of properties in the hands of the patricians, and the continued absences of citizens required by the expanding system of conquest, necessarily brought with them a demand for slave labour, which was increasingly supplied by captives taken in war. Of the number furnished from this source a few particulars from the time of the mature republic and the first century of the empire will give some idea. In Epirus, after the victories of Aemilius Paullus, 150,000 captives were sold. The prisoners at Aquæ Sextiac and Vercellae were 90,000 Teutons and 60,000 Cimbric. Caesar sold on a single occasion in Gaul 63,000 captives. But slavery, as Hume has shown, is unfavourable to population. Hence a regular commerce in slaves was established, which was based on the "systematically-prosecuted hunting of man," and indicated an entire perversion of the primitive institution, which was essentially connected with conquest. The pirates sold great numbers of slaves at Delos, where was the chief market for this kind of wares; and these sales went on as really, though more obscurely, after the successful expedition of Pompey. There was a regular importation to Rome of slaves, brought to some extent from Africa, Spain and Gaul, but chiefly from Asiatic countries—Bithynia, Galatia, Cappadocia and Syria. A *portorium*—apparently one-eighth for eunuchs, one-fortieth for others—was paid on their import or export, and a duty of 2 or 4% on their sale.

There were other sources from which slavery was alimeted, though of course in a much less degree. Certain offences reduced the guilty persons to slavery (*servi poenae*), and they were employed in public work in the quarries or the mines. Originally, a father could sell his children. A creditor could hold his insolvent debtor as a slave, or sell him out of the city (*trans Tiberim*). The enslavement of creditors, overwhelmed with usury in consequence of losses by hostile raids or their own absence on military service, led to the secession to the Mons Sacer (493 B.C.). The Poetelian law (326 B.C.) restricted the creditor's lien (by virtue of a *nexum*) to the goods of his debtor, and enacted that for the future no debtor should be put in chains; but we hear of debtors *addicti* to their creditors by the tribunals long after—even in the time of the Punic Wars.

There were *servi publici* as well as *privati*. The service of the magistrates was at first in the hands of freemen; but the lower offices, as of couriers, servants of the law courts, of prisons and of temples, were afterwards filled by slaves. The execution of public works also came to be largely committed to them—as the construction of roads, the cleansing of the sewers and the maintenance of the aqueducts. Both kinds of functions were discharged by slaves, not only at Rome, but in the rural and provincial municipalities. The slaves of a private Roman were divided between the *familia rustica* and the *familia urbana*. At the head of the *familia rustica* was the *villicus*, himself a slave, with the wife who was given him at once to aid him and to bind him to his duties. Under him were the several groups employed in the different branches of the exploitation and the care of the cattle and flocks, as well as those who kept or prepared the food, clothing and tools of the whole staff and those who attended on the master in the various species of rural sports. A slave prison (*ergastulum*) was part of such an establishment, and there were slaves whose office it was to punish the offences of their fellows. To the *familia urbana* belonged those who discharged the duties of domestic attendance, the service of the toilet, bath, table and kitchen, besides the entertainment of the master and his guests by dancing, singing and other arts. There were, besides, the slaves who accompanied the master and mistress out of doors, and were chosen for their beauty and grace as guards of honour, for their strength as chairmen or porters,

Sources.

Employments.

or for their readiness and address in remembering names, delivering messages of courtesy and the like. There were also attached to a great household physicians, artists, secretaries, librarians, copyists, preparers of parchment, as well as pedagogues and preceptors of different kinds—readers, grammarians, men of letters and even philosophers—all of servile condition, besides accountants, managers and agents for the transaction of business. Actors, comic and tragic, pantomimi, and the performers of the circus were commonly slaves, as were also the gladiators. These last were chosen from the most warlike races—as the Samnites, Gauls and Thracians. *Familiae* of gladiators were kept by private speculators, who hired them out; they were sometimes owned by men of high rank.

Several special examples and other indirect indications show that the wealthier Romans possessed large *familiae*. This may be inferred from the *columbaria* of the house of Livia and of other great houses. The slaves of Pedanius Secundus, who, in spite of a threatened outbreak of the indignant populace, were all put to death because they had been under their master's roof when he was murdered, were four hundred in number. Pliny tells us that Caccilius, a freedman of the time of Augustus, left by his will as many as 4116. The question as to the total number of slaves at Rome or in Italy is a very difficult one, and it is not, perhaps, possible to arrive with any degree of certainty at an approximate estimate. Gibbon supposes that there were in the Roman world in the reign of Claudius at least as many slaves as free inhabitants. But Blair seems right in believing that this number, though probably correct for an earlier period, is much under the truth for the age to which it is assigned. He fixes the proportion of slaves to free men as that of three to one for the time between the conquest of Greece (146 B.C.) and the reign of Alexander Severus (A.D. 222-235). The entire number of slaves in Italy would thus have been, in the reign of Claudius, 20,832,000.

By the original Roman law the master was clothed with absolute dominion over the slave, extending to the power of life and death, which is not surprising when we consider the nature of the *patria potestas*. The slave could not possess property of any kind; whatever he acquired was legally his master's. He was, however, in practice permitted to enjoy and accumulate chance earnings or savings, or a share of what he produced, under the name of *peculium*. A master could not enter into a contract with his slave, nor could he accuse him of theft before the law; for, if the slave took anything, this was not a subtraction, but only a displacement, of property. The union of a male and female slave had not the legal character of a marriage; it was a cohabitation (*contubernium*) merely, which was tolerated, and might be terminated at will, by the master; a slave was, therefore, not capable of the crime of adultery. Yet general sentiment seems to have given a stronger sanction to this sort of connexion; the names of husband and wife are freely used in relation to slaves on the stage, and even in the laws, and in the language of the tombs. For entering the military service or taking on him any state office a slave was punished with death. He could not in general be examined as a witness, except by torture. A master, when accused, could offer his slaves for the "question," or demand for the same purpose the slaves of another; and, if in the latter case they were injured or killed in the process, their owner was indemnified. A slave could not accuse his master, except of adultery or incest (under the latter name being included the violation of sacred things or places); the case of high treason was afterwards added to these. An accused slave could not invoke the aid of the tribunes. The penalties of the law for crime were specially severe on slaves.

Columella, like Xenophon, favours a certain friendliness and familiarity in one's intercourse with his farm slaves. Cato ate and drank the same coarse victuals as his slaves, and even had the children suckled by his wife, that they might imbibe a fondness for the family. But he had a strict eye to profit in all his dealings with them. He allowed the *contubernium* of male and female slaves at the price of a money payment from their *peculium*. Columella regarded the gains from the births as a sufficient motive for encouraging these unions, and thought that mothers should be rewarded for their fecundity; Varro, too, seems to have taken this view. The immense extension of the rural estates (*latifundia*) made it impossible for masters to know their slaves, even if they were disposed to take trouble for the purpose. Effective superintendence even by overseers became less easy; the use of chains was introduced, and these were worn not only in the field during working hours but at night in the *ergastulum* where the slaves slept. Urban slaves had probably often a life as little enviable, especially those who worked at trades for speculators. Even in private houses at Rome, so late as the time of Ovid, the porter was chained. In the *familia urbana* the favourites of the master had good treatment, and might exercise some influence over him which would lead to their receiving flattery and gifts from those who sought his vote or solicited his support. Doubtless there was often genuine mutual affection; slaves sometimes, as in noted instances during the civil wars, showed the noblest spirit of devotion to their masters. Those who were not inmates of the household, but were employed outside of it as keepers of a shop or boat, chiefs of workshops, or clerks in a mercantile business, had the advantage of greater freedom of action. The slaves of the *leno* and the *lanista* were probably in most cases not only degraded but unhappy. The lighter punish-

ments inflicted by masters were commonly personal chastisement or banishment from the town house to rural labour; the severer were employment in the mill (*pistrinum*) or relegation to the mines or quarries. To the mines also speculators sent slaves; they worked half-naked, men and women, in chains, under the lash and guarded by soldiers. Vedius Pollio, in the time of Augustus, was said to have thrown his slaves, condemned sometimes for trivial mistakes or even accidents, to the lampreys in his fishpond. Cato advised the agriculturist to sell his old oxen and his old slaves, as well as his sick ones; and sick slaves were exposed in the island of Aesculapius in the Tiber; by a decree of Claudius slaves so exposed, if they recovered, could not be reclaimed by their masters.

Though the Roman slaves were not, like the Spartan Helots, kept obedient by systematic terrorism, their large numbers were a constant source of danger. The law under which the slaves of Pedanius were put to death, probably introduced under Augustus and more fully enacted under Nero, is sufficient proof of this anxiety, which indeed is strongly stated by Tacitus in his narrative of the facts. There had been many conspiracies amongst the slaves in the course of Roman history, and some formidable insurrections. The growth of the *latifundia* made the slaves more and more numerous and formidable. Free labour was discountenanced. Cato, Varro and Columella all agree that slave labour was to be preferred to free except in unhealthy regions and for large occasional operations, which probably transcended the capacity of the permanent *familia rustica*. Cicero and Livy bear testimony to the disappearance of a free plebs from the country districts and its replacement by gangs of slaves working on great estates. The worst form of such praedial slavery existed in Sicily, whither Mommsen supposes that its peculiarly harsh features had been brought by the Carthaginians. In Sicily, accordingly, the first really serious servile insurrections took place. The rising under Eunus in 133 B.C. was with some difficulty suppressed by Rupilius. Partial revolts in Italy succeeded; and then came the second Sicilian insurrection under Trypho and Athenio, followed by the Servile War in Italy under Spartacus (*q.v.*). Clodius and Milo used bands of gladiators in their city riots, and this action on the part of the latter was approved by Cicero. In the First Civil War they were to be found in both camps, and the murderers of Caesar were escorted to the Capitol by gladiators. Antony, Octavius, and Sextus Pompeius employed them in the Second Civil War; and it is recorded by Augustus on the Monumentum Ancyranum that he gave back to their masters for punishment about 30,000 slaves who had absconded and borne arms against the state. Under Tiberius, at the death of Caligula, and in the reign of Nero there were threatening movements of the slaves. In the wars from Otho to Vespasian they were employed, as Tacitus tells us, even by the most scrupulous generals.

Blair, in comparing the Greek and Roman systems of slavery, points with justice to the greater facility and frequency of emancipation as the great superiority of the latter. No Roman slave, he says, "needed to despair of becoming both a freeman and a citizen." Manumission was of two kinds—*justa* or regular, and *minus justa*. Of *manumissio justa* there were four modes: (1) by adoption, rarely resorted to; (2) by testament, already recognized in the Twelve Tables; (3) by *census*, which was of exceptional use, and did not exist later than the time of Vespasian; and (4) by *vindicta*, which was the usual form. In the last method the master turned the slave round, with the words "liber esto," in the presence of the praetor, that officer or his licitor at the same time striking the slave with his rod. The *manumissio minus justa* was effected by a sufficient manifestation of the will of the master, as by letter, by words, by putting the *pileus* (or cap of liberty) on the slave, or by any other formality which had by usage become significant of the intention to liberate, or by such an act as making the slave the guardian of his children. This extra-legal sort of manumission was incomplete and precarious; even after the *lex Junia Norbana* (A.D. 19), which assimilated the position of those so liberated to that of the Latin colonists, under the name of Latini juniores, the person remained in the eye of the law a slave till his death and could not dispose of his *peculium*.

A freedman, unless he became such by operation of law, remained client of his master, and both were bound by the mutual obligations arising out of that relation. These obligations existed also in the case of freedmen of the state, of cities, temples and corporations. The freedman took his former master's name; he owed him deference (*obsequium*) and aid (*officium*); and neglect of these obligations was punished, in extreme cases even with loss of liberty. Conditions might be annexed by the master to the gift of freedom, as of continued residence with him, or of general service or some particular duty to be performed, or of a money payment to be made. But the praetor Rutilius, about the beginning of the 1st century B.C., limited the excessive imposition of such conditions, and his restrictions were carried further by the later jurists and the imperial constitutions. Failing natural heirs of an intestate freedman, the master, now patron, succeeded to his property at his death; and he could dispose by will of only half his possessions, the patron receiving the other half. Freedmen and their sons were subject to civil disabilities; the third generation became *ingenui* (full citizens). Thus, the slave element tended to merge itself in the general popular body.

It was often a pecuniary advantage to the master to liberate his slave; he obtained a payment which enabled him to buy a substitute, and at the same time gained a client. This of course presupposes the

recognition of the right of the slave to his *peculium*; and the same is implied in Cicero's statement that a diligent slave could in six years purchase his freedom. Augustus set himself against the undue multiplication of manumissions, probably considering the rapid succession of new citizens a source of social instability, and recommended a similar policy to his successor. The *lex Aelia Sentia* (about A.D. 3) forbade manumission, except in strictly limited cases, by masters under 20 years of age or of slaves under 30; and the *lex Furia Caninia* (about A.D. 7) fixed the proportion of a man's slaves which he could liberate by testament, and forbade more than a hundred being so enfranchised, whatever might be the number of the *familia*. Under the empire the freedmen rose steadily in influence; they became admissible to the rank of equites and to the senate; they obtained provincial governments, and were appointed to offices in the imperial household which virtually placed them at the head of administrative departments (see PALLAS and NARCISSUS). Freedmen of humbler rank, on the other hand, filled the minor offices in the administrative service, in the city cohorts, and in the army; and we shall find that they entered largely into the trades and professions when free labour began to revive. They appeared also in literature, e.g. Tiro, the amanuensis of Cicero; Hyginus, the librarian of Augustus; Livius Andronicus, Cæcilius, Statius, Terence, Publilius Syrus, Phædrus and Epictetus.

In the 2nd century of the Christian era we find a marked change with respect to the institution of slavery, both in the region of thought and in that of law. Already the principles of reason and humanity had been applied to the subject by Seneca. But it was in the 2nd century, as we have said, that "the victory of moral ideas" in this, as in other departments of life, became "decisive. . . . Dio Chrysostom, the adviser of Trajan, is the first Greek writer who has pronounced the principle of slavery to be contrary to the law of nature" (Mark Pattison). And a parallel change is found in the practical policy of the state. The military vocation of Rome was now felt to have reached its normal limits; and the emperors, understanding that, in the future, industrial activity must prevail, prepared the abolition of slavery as far as was then possible, by honouring the freedmen, by protecting the slave against his master, and by facilitating manumissions. The general tendency both of the imperial constitutions and of the maxims of the legists is in favour of liberty. The practices of exposure and sale of children, and of giving them in pledge for debt, are forbidden. Diocletian forbade a free man to sell himself. Kidnappers (*plagiarii*) were punished with death. The insolvent debtor was withdrawn from the yoke of his creditor. While the slave trade was permitted, the mutilation of boys and young men, too often practised, was punished with exile and even with death. In redhibitory actions (for the annulment of sales), if a slave were returned to the seller, so must also be his parents, brothers and *personae contubernio conjunctae*. In the interpretation of testaments it was to be assumed that members of the same family were not to be separated by the division of the succession. The law also favoured in special cases the security of the *peculium*, though in general principle it still remained the property of the master. The state granted to public slaves the right of bequeathing half their possessions; and private persons sometimes permitted similar dispositions even to a greater extent, though only within the *familia*. Hadrian took from masters the power of life and death and abolished the subterranean prisons. Antoninus Pius punished him who killed his own slave as if he had killed another's. Already in the time of Nero the magistrates had been ordered to receive the slave's complaint of ill-treatment; and the *lex Petronia*, belonging to the same or an earlier period, forbade masters to hand over their slaves to combats with wild beasts. Antoninus directed that slaves treated with excessive cruelty, who had taken refuge at an altar or imperial image, should be sold; and this provision was extended to cases in which the master had employed a slave in a way degrading to him or beneath his character. M. Aurelius gave to masters an action against their slaves for any cause of complaint, thus bringing their relation more directly under the surveillance of law and public opinion. A slave's oath could still not be taken in a court of law; he was interrogated by the "question"; but the emperors and jurists limited in various ways the application of torture, adding, however, as we have mentioned, to the cases in which it could previously be appealed to that of the crime of *majestas*. For certain alleged offences of the master the slave could bring an action, being represented for the purpose by an *adsertor*. Emancipation was facilitated. The power of imposing conditions on testamentary manumissions was restricted, and these conditions interpreted in the sense most favourable to freedom. The emperor could confer liberty by presenting a gold ring to a slave with the consent of the master, and the legal process called *restitutio natalium* made him a full citizen. It was decided that liberty could not be forfeited even by a prescription of sixty years' duration.

The rise of Christianity in the Roman world still further improved the condition of the slave. The sentiments it created were not only favourable to the humane treatment of the class in the present, but were the germs out of which its entire liberation was destined, at a later period, in part to arise. It is sometimes objected that the Christian church did not denounce slavery as a social crime and insist on its abolition. We have seen that slavery was a fundamental element of the old Roman

constitution. When the work of conquest had been achieved, it could not be expected that a radical alteration should be suddenly wrought either in the social system which was in harmony with it, or even in the general ideas which had grown up under its influence. The latter would, indeed, be gradually affected; and accordingly we have observed a change in the policy of the law, indicating a change in sentiment with respect to the slave class, which does not appear to have been at all due to Christian teaching. But the institution itself could not be at once seriously disturbed. The results must have been disastrous, most of all to the slave population itself. Before that end could be accomplished, an essentially new social situation must come into existence. But in the meantime much might be done towards further mitigating the evils of slavery, especially by impressing on master and slave their relative duties and controlling their behaviour towards one another by the exercise of an independent moral authority. This was the work open to the Christian priesthood, and it cannot be denied that it was well discharged. Whilst the fathers agree with the Stoics of the 2nd century in representing slavery as an indifferent circumstance in the eye of religion and morality, the contempt for the class which the Stoics too often exhibited is in them replaced by a genuine sympathy. They protested against the multiplication of slaves from motives of vanity in the houses of the great, against the gladiatorial combats (ultimately abolished by the noble self-devotion of a monk) and against the consignment of slaves to the theatrical profession, which was often a school of corruption. The church also encouraged the emancipation of individual slaves and the redemption of captives. And its influence is to be seen in the legislation of the Christian emperors, which softened some of the harshest features that still marked the institution. But a stronger influence of Christianity appears in Theodosius, and this influence is at the highest in the legislation of Justinian. Its systematic effort is, in his own words, "*pro libertate, quam et fovere et tueri Romanis legibus et præcipue nostro munimi peculiare est.*" Law still refused in general to recognize the marriages of slaves; but Justinian gave them a legal value after emancipation in establishing rights of succession. Unions between slaves and free women, or between a freeman and the female slave of another, continued to be forbidden, and were long punished in certain circumstances with atrocious severity. As witness, the slave was still subject to the question; as criminal, he was punished with greater rigour than the freeman. If he accused his master of a crime, unless the charge was of treason, he was burnt. But he could maintain a legal claim to his own liberty, not now merely through an *adsertor*, but in person. A female slave was still held incapable of the offence of adultery; but Justinian visited with death alike the rape of a slave or freedwoman and that of a free maiden. Already the master who killed his slave had been punished as for homicide, except in the case of his unintended death under correction; Constantine treated as homicide a number of specially-enumerated acts of cruelty. Even under Theodosius the combats of the amphitheatre were permitted, if not encouraged, by the state authorities; these sports were still expected from the candidates for public honours. Combats of men with beasts were longest continued; they had not ceased even in the early years of the reign of Justinian. A new process of manumission was now established, to be performed in the churches through the intervention of the ministers of religion; and it was provided that clerics could at any time by mere expression of will liberate their slaves. Slaves who were admitted to holy orders, or who entered a monastery, became freemen, under certain restrictions framed to prevent fraud or injustice. Justinian abolished the personal conditions which the legislation of Augustus had required to be satisfied by the master who emancipated and the slave who was manumitted, and removed the limitation of number. The liberated slave, whatever the process by which he had obtained his freedom, became at once a full citizen, his former master, however, retaining the right of patronage, the abolition of which would probably have discouraged emancipation.

Transition to Serfdom.—The slavery of the working classes was not directly changed into the system of personal freedom. There was an intermediate stage which has not always been sufficiently discriminated from slavery. We mean the régime of serfdom. In studying the origin of this transitional state of things, four principal considerations have to be kept in view. (1) As Gibbon observes, the completion of the Roman system of conquest reduced the supply of slaves. It is true that, when the barbarian invasions began in the 3rd century, many captives were made, who, when not enrolled in the army, were employed in agriculture or domestic service; but the regular importation was increasingly diminished. This improved the condition of the slave by rendering his existence an object of greater value to his master. It was clearly to the interest of each family to preserve indefinitely its own hereditary slaves. Hence the abolition of the external slave trade tended, in fact, to put an end to internal sales, and the slaves became attached to the households or lands of their masters. (2) The diminished supply

of slaves further acted in the direction of the rehabilitation of free labour. A general movement of this kind is noticeable from the 2nd century onwards. Freeman had always been to some extent employed in the public service. In private service superior posts were often filled by freedmen; the higher arts—as medicine, grammar, painting—were partly in the hands of freedmen and even of *ingenui*; the more successful actors and gladiators were often freedmen. In the factories or workshops kept by wealthy persons slave labour was mainly employed; but free artisans sometimes offered their services to these establishments or formed associations to compete with them. We have seen that free persons had all along been to some extent employed in the cultivation of land as hired labourers, and, as we shall presently find, also as tenants on the great estates. How all this operated we shall understand when we examine the remarkable organization of the state introduced by Diocletian and his successors. (3) This organization established in the Roman world a personal and hereditary fixity of professions and situations which was not very far removed from the caste system of the East. The purpose of this was doubtless to resist by a strong internal consolidation the shock of the invasions, to secure public order, to enforce industrious habits, and to guarantee the financial resources of the state. Personal independence was largely sacrificed, but those still more important ends were in a great measure attained. This system, by diminishing the freeman's mastery over himself and his power to determine his occupation, reduced the interval between him and the slave; and the latter on the one hand, the free domestic servant and workshop labourer on the other, both passed insensibly into the common condition of serfdom. (4) The corresponding change, in the case of the rural slaves, took place through their being merged in the order of *coloni*. The Roman colonus was originally a free person who took land on lease, contracting to pay to the proprietor either a fixed sum annually or (when a *colonus partiaris*) a certain proportion of the produce of the farm. Under the emperors of the 4th century the name designated a cultivator who, though personally free, was attached to the soil, and transmitted his condition to his descendants; and this became the regular status of the mass of Roman cultivators. The class of *coloni* appears to have been composed partly of tenants by contract who had incurred large arrears of rent and were detained on the estates as debtors (*obaerati*), partly of foreign captives or immigrants who were settled in this condition on the land, and partly of small proprietors and other poor men who voluntarily adopted the status as an improvement in their position. They paid a fixed proportion of the produce (*pars agraria*) to the owner of the estate, and gave a determinate amount of labour (*operae*) on the portion of the domain which he kept in his own hands (*mansus dominicus*). The law for a long time took no notice of these customary tenures, and did not systematically constitute them until the 4th century. It was indeed the requirements of the fiscus and the conscription which impelled the imperial government to regulate the system. The *coloni* were inscribed (*adscripti*) on the registers of the census as paying taxes to the state, for which the proprietor was responsible, reimbursing himself for the amount. In a constitution of Constantine (A.D. 332) we find the colonus recognized as permanently attached to the land. If he abandoned his holding he was brought back and punished; and any one who received him had not only to restore him but to pay a penalty. He could not marry out of the domain; if he took for wife a *colona* of another proprietor, she was restored to her original locality, and the offspring of the union were divided between the estates. The children of a colonus were fixed in the same status. They and their descendants were retained, in the words of a law of Theodosius, "quodam aeternitatis jure," and by no process could be relieved from their obligations. By a law of Anastasius, at the end of the 5th century, a colonus who had voluntarily come into an estate was by a tenure of thirty years for ever attached to it. The master (*dominus*) could inflict on his *coloni* "moderate chastisement," and could chain them if they attempted to escape, but they had a legal remedy against him for unjust demands or injury to them or

theirs. In no case could the rent or the labour dues be increased. The colonus could possess property of his own, but could not alienate it without the consent of the master. Thus, whilst the members of the class were personally free, their condition had some incidents of a semi-servile character. They are actually designated by Theodosius, "servi terrae cui nati sunt." And Salvian treats the proposition "*coloni divitum fiunt*" as equivalent to "*vertuntur in servos*." This is indeed an exaggeration; the colonatus was not an oppressive system; it afforded real security against unreasonable demands and wanton disturbance, and it was a great advance on the system of the *familia rustica*. But the point which is important is that there was a certain approximation between the condition of the colonus and the slave which tended towards the fusion of both in a single class.

Besides the *coloni* there were on a great estate—and those of the 4th century were on a specially large scale—a number of praedial slaves, who worked collectively under overseers on the part of the property which the owner himself cultivated. But it was a common practice to settle certain of the slaves (and possibly also of the freedmen) on other portions of the estate, giving them small farms on conditions similar to those to which the *coloni* were subject. These slaves are, in fact, described by Ulpian as *quasi coloni*. They had their own households and were hence distinguished as *casati*. In law these slaves were at first absolutely at the disposal of their masters; they had no property in the strict sense of the word, and could be sold to another proprietor and separated from their families. But the landlord's interest and the general tone of feeling alike modified practice even before the intervention of legislation; they were habitually continued in their holdings, and came to possess in fact a perpetual and hereditary enjoyment of them. By a law of Valentinian I. (377) the sale of these slaves was interdicted unless the land they occupied were at the same time sold. The legal distinction between the *coloni* and the slave tenants continued to exist after the invasions; but the practical difference was greatly attenuated. The colonus often occupied a servile *mansus*, and the slave a *mansus* originally appropriated to a colonus. Intermarriages of the two classes became frequent. Already at the end of the 7th century it does not appear that the distinction between them had any substantial existence.

The influence of the Northern invasions on the change from slavery to serfdom was, in all probability, of little account. The change would have taken place, though perhaps not so speedily, if they had never occurred. For the developments of the Middle Ages see SERFDOM and VILLENAGE.

Modern Slave Trade.—Not very long after the disappearance of serfdom in the most advanced communities comes into sight the new system of colonial slavery, which, instead of being the spontaneous outgrowth of social necessities and subserving a temporary need of human development, was politically as well as morally a monstrous aberration.

In 1442, when the Portuguese under Prince Henry the Navigator were exploring the Atlantic coast of Africa, one of his officers, Antam Gonsalves, who had captured some Moors, was directed by the prince to carry them back to Africa. He received from the Moors in exchange for them ten blacks and a quantity of gold dust. This excited the cupidity of his fellow-countrymen; and they fitted out a large number of ships for the trade, and built several forts on the African coast. Many negroes were brought into Spain from these Portuguese settlements, and the colonial slave trade first appears in the form of the introduction into the newly-discovered western world of descendants of these negroes. When Nicolas de Ovando was sent out in 1502 as governor of Haiti, whilst regulations, destined to prove illusory, were made for the protection of the natives of the island, permission was given to carry to the colony negro slaves, born in Seville and other parts of Spain, who had been instructed in the Christian faith. It appears from a letter of Ovando in 1503 that there were at that time numbers of negroes in Haiti; he requested that no more might be permitted to be brought out. In 1510 and the following years

Spanish colonies.

King Ferdinand ordered a number of Africans to be sent to that colony for the working of the mines.

Before this time Columbus had proposed an exchange of his Carib prisoners as slaves against live stock to be furnished to Haiti by Spanish merchants. He actually sent home, in 1494, above 500 Indian prisoners taken in wars with the caciques, who, he suggested, might be sold as slaves at Seville. But, after a royal order had been issued for their sale, Queen Isabella, interested by what she had heard of the gentle and hospitable character of the natives and of their docility, procured a letter to be written to Bishop Fonseca, the superintendent of Indian affairs, suspending the order until inquiry should be made into the causes for which they had been made prisoners, and into the lawfulness of their sale. Theologians differed on the latter question, and Isabella directed that these Indians should be sent back to their native country.

Bartolomé de las Casas, the celebrated bishop of Chiapa, accompanied Ovando to Haiti, and was a witness of the cruelties from which the Indians suffered under his administration. He came to Spain in 1517 to obtain measures in their favour, and he then made the suggestion to Charles that each Spanish resident in Haiti should have licence to import a dozen negro slaves. Las Casas, in his *Historia de las Indias* (lib. iii. cap. 101), confesses the error into which he thus fell. Other good men appear to have given similar advice about the same time, and, as has been shown, the practice was not absolutely new; indeed the young king had in 1516, whilst still in Flanders, granted licences to his courtiers for the importation of negroes into the colonies, though Jimenes, as regent of Castile, by a decree of the same year forbade the practice. The suggestion of Las Casas was no doubt made on the ground that the negroes could, better than the Indians, bear the labour in the mines, which was rapidly exhausting the numbers of the latter.¹ He has sometimes on this plea been exonerated from all censure; but, though entitled to honour for the zeal which he showed on behalf of the natives, he must bear the blame for his violation or neglect of moral principle. His advice was unfortunately adopted. "Charles," says Robertson, "granted a patent to one of his Flemish favourites, containing an exclusive right" of supplying 4000 negroes annually to Haiti, Cuba, Jamaica and Porto Rico. "The favourite sold his patent to some Genoese merchants for 25,000 ducats"; these merchants obtained the slaves from the Portuguese; and thus was first systematized the slave trade between Africa and America.

The first Englishman who engaged in the traffic was Sir John Hawkins (*q.v.*). The English slave traders were at first altogether occupied in supplying the Spanish settlements. Indeed the reign of Elizabeth passed without any English colony having been permanently established in America. But in 1620 a Dutch ship from the coast of Guinea visited Jamestown in Virginia, and sold a part of her cargo of negroes to the tobacco-planters. This was the first beginning of slavery in British America; the number of negroes was afterwards continually increased—though apparently at first slowly—by importation, and the field-labour was more and more performed by servile hands, so that in 1790 the state of Virginia contained 200,000 negroes.

The African trade of England was long in the hands of exclusive companies; but by an act of the first year of William and Mary it became free and open to all subjects of the crown. The African Company, however, continued to exist, and obtained from time to time large parliamentary grants. By the treaty of Utrecht the asiento,² or contract for supplying the Spanish colonies with 4800 negroes annually, which had previously passed from the Dutch to the French, was transferred to Great Britain; an English company was to enjoy the monopoly for a period of thirty years from 1st May 1713. But the contract came to an end in 1739, when the complaints of the English merchants on one side and of the Spanish officials on the other rose to such a height that Philip V. declared his

determination to revoke the asiento, and Sir Robert Walpole was forced by popular feeling into war with Spain. Between 1680 and 1700 about 140,000 negroes were exported by the African Company, and 160,000 more by private adventurers, making a total of 300,000. Between 1700 and the end of 1786 as many as 610,000 were transported to Jamaica alone, which had been an English possession since 1655. Bryan Edwards estimated the total import into all the British colonies of America and the West Indies from 1680 to 1786 at 2,130,000, being an annual average of 20,095. The British slave trade reached its utmost extension shortly before the War of American Independence. It was then carried on principally from Liverpool, but also from London, Bristol and Lancaster; the entire number of slave ships sailing from those ports was 192, and in them space was provided for the transport of 47,146 negroes. During the war the number decreased, but on its termination the trade immediately revived. When Edwards wrote (1791), the number of European factories on the coasts of Africa was 40; of these 14 were English, 3 French, 15 Dutch, 4 Portuguese and 4 Danish. As correct a notion as can be obtained of the numbers annually exported from the continent about the year 1790 by traders of the several European countries engaged in the traffic is supplied by the following statement:—"By the British, 38,000; by the French, 20,000; by the Dutch, 4000; by the Danes, 2000; by the Portuguese, 10,000; total 74,000." Thus more than half the trade was in British hands.

The hunting of human beings to make them slaves was greatly aggravated by the demand of the European colonies. The native chiefs engaged in forays, sometimes even on their own subjects, for the purpose of procuring slaves to be exchanged for Western commodities. They often set fire to a village by night and captured the inhabitants when trying to escape. Thus all that was shocking in the barbarism of Africa was multiplied and intensified by this foreign stimulation. Exclusive of the slaves who died before they sailed from Africa, 12½% were lost during their passage to the West Indies; at Jamaica 4½% died whilst in the harbours or before the sale and one-third more in the "seasoning." Thus, out of every lot of 100 shipped from Africa 17 died in about 9 weeks, and not more than 50 lived to be effective labourers in the islands. The circumstances of their subsequent life on the plantations were not favourable to the increase of their numbers. In Jamaica there were in 1690, 40,000; from that year till 1820 there were imported 800,000; yet at the latter date there were only 340,000 in the island. One cause which prevented the natural increase of population was the inequality in the numbers of the sexes; in Jamaica alone there was in 1789 an excess of 30,000 males.

Effects of the slave trade.

Movement against the Slave Trade.—When the nature of the slave trade began to be understood by the public, all that was best in England was adverse to it. Among those who denounced it—besides some whose names are now little known, but are recorded in the pages of Clarkson—were Baxter, Sir Richard Steele (in *Inkle and Yarico*), the poets Southern (in *Oroonoko*), Pope, Thomson, Shenstone, Dyer, Savage and above all Cowper (see his *Charity*, and *Task*, bk. 2), Thomas Day (author of *Sandford and Merton*), Sterne, Warburton, Hutcheson, Beattie, John Wesley, Whitfield, Adam Smith, Millar, Robertson, Dr Johnson, Paley, Gregory, Gilbert Wakefield, Bishop Porteus, Dean Tucker. The question of the legal existence of slavery in Great Britain and Ireland was raised in consequence of an opinion given in 1729 by Yorke and Talbot, attorney-general and solicitor-general at the time, to the effect that a slave by coming into those countries from the West Indies did not become free, and might be compelled by his master to return to the plantations. Chief-Justice Holt had expressed a contrary opinion; and the matter was brought to a final issue by Granville Sharp in the case of the negro Somerset. It was decided by Lord Mansfield, in the name of the whole bench, on the 22nd of June 1772, that as soon as a slave set his foot on the soil of the British islands he became free. In 1776 it was moved in the House of Commons by David Hartley, son of the author of *Observations on Man*, that "the slave trade was contrary to the laws of God and the rights of men"; but this motion—the first which was made on the subject—failed.

The first persons in England who took united practical action against the slave trade were the Quakers, following the expression of sentiment which had emanated so early as 1671 from their founder George Fox. In 1727 they declared it to be "not a commendable or allowed" practice; in 1761 they excluded from their society all who should be found concerned in it, and issued appeals to their members and the public against the system. In 1783 there was formed among them an association "for the relief and liberation of the negro slaves in the West

¹The Spaniards, in the space of fifteen years subsequent to the discovery of the West Indies, had, as Robertson mentions, reduced the natives of Haiti from a million to 60,000.

²The Spaniards were prevented from forming establishments on the African coast by the Bull of Demarcation ("Inter caetera") of Pope Alexander VI. (1493), which forbade their acquiring territory to the east of the meridian line of 100 m. west of the Azores. They could therefore supply their American possessions with slaves only by contracts with other powers.

Indies, and for the discouragement of the slave trade on the coast of Africa." This was the first society established in England for the purpose. The Quakers in America had taken action on the subject still earlier than those in England. The Pennsylvanian Quakers advised their members against the trade in 1696; in 1754 they issued to their brethren a strong dissuasive against encouraging it in any manner; in 1774 all persons concerned in the traffic, and in 1776 all slave holders who would not emancipate their slaves, were excluded from membership. The Quakers in the other American provinces followed the lead of their brethren in Pennsylvania. The individuals among the American Quakers who laboured most earnestly and indefatigably on behalf of the Africans were John Woolman (1720-1773) and Anthony Benezet (1713-1784), the latter a son of a French Huguenot driven from France by the revocation of the edict of Nantes. The former confined his efforts chiefly to America and indeed to his coreligionists there; the latter sought, not without success, to found a universal propaganda in favour of abolition. A Pennsylvanian society was formed in 1774 by James Pemberton and Dr Benjamin Rush, and in 1787 (after the war) was reconstructed on an enlarged basis under the presidency of Franklin. Other similar associations were founded about the same time in different parts of the United States. The next important movement took place in England. Dr Peckard, vice-chancellor of the university of Cambridge, who entertained strong convictions against the slave trade, proposed in 1785 as subject for a Latin prize dissertation the question, "An liceat invitos in servitutum dare." Thomas Clarkson obtained the first prize, translated his essay into English in an expanded form, and published it in 1786 with the title *Essay on the Slavery and Commerce of the Human Species*. In the process of its publication he was brought into contact with several persons already deeply interested in the question; amongst others with Granville Sharp, William Dillwyn (an American by birth, who had known Benezet), and the Rev. James Ramsay, who had lived nineteen years in St Christopher, and had published an *Essay on the Treatment and Conversion of the African Slaves in the British Sugar Colonies*. The distribution of Clarkson's book led to his forming connexions with many persons of influence, and especially with William Wilberforce (q.v.). A committee was formed on the 22nd of May 1787 for the abolition of the slave trade, under the presidency of Granville Sharp. It is unquestionable that the principal motive power which originated and sustained their efforts was Christian principle and feeling. The most earnest and unremitting exertions were made by the persons so associated in investigating facts and collecting evidence, in forming branch committees and procuring petitions, information and support of those who pleaded the cause in parliament. To the original members were afterwards added several remarkable persons, amongst whom were Josiah Wedgwood, Bennet Langton (Dr Johnson's friend), and, later, Zachary Macaulay, Henry Brougham and James Stephen.

In consequence of the numerous petitions presented to parliament, a committee of privy council was appointed by the crown in 1788 to inquire concerning the slave trade; and Pitt moved that the House of Commons should early in the next session take the subject into consideration. Wilberforce's first motion for a committee of the whole House upon the question was made on the 19th of March 1789, and this committee proceeded to business on the 12th of May of the same year. After an admirable speech, Wilberforce laid on the table twelve resolutions which were intended as the basis of a future motion for the abolition of the trade. The discussion of these was postponed to the next session, and in 1790-1791 evidence was taken upon them. At length, on the 18th of April of the latter year, a motion was made for the introduction of a bill to prevent the further importation of slaves into the British colonies in the West Indies. Opinion had been prejudiced by the insurrections in St Domingo and Martinique, and in the British island of Dominica; and the motion was defeated by 163 votes against 88. Legislative sanction was, however, given to the establishment of the Sierra Leone Company, for the colonization of a district on the west coast of Africa and the discouragement of

the slave trade there. It was hoped at the time that that place would become the centre from which the civilization of Africa would proceed; but this expectation was not fulfilled. On the 2nd of April 1792 Wilberforce again moved that the trade ought to be abolished; an amendment in favour of gradual abolition was carried, and it was finally resolved that the trade should cease on the 1st of January 1796. When a similar motion was brought forward in the Lords the consideration of it was postponed to the following year, in order to give time for the examination of witnesses by a committee of the House. A bill in the Commons in the following year to abolish that part of the trade by which British merchants supplied foreign settlements with slaves was lost on the third reading; it was renewed in the Commons in 1794 and carried there, but defeated in the Lords. Then followed several years during which efforts were made by the abolitionists in parliament with little success. But in 1806, Lord Grenville and Fox having come into power, a bill was passed in both Houses to put an end to the British slave trade for foreign supply, and to forbid the importation of slaves into the colonies won by the British arms in the course of the war. On the 10th of June of the same year Fox brought forward a resolution "that effectual measures should be taken for the abolition of the African slave trade in such a manner and at such a period as should be deemed advisable," which was carried by a large majority. A similar resolution was successful in the House of Lords. A bill was then passed through both Houses forbidding the employment of any new vessel in the trade. Finally, in 1807, a bill was presented by Lord Grenville in the House of Lords providing for the abolition of the trade, was passed by a large majority, was then sent to the Commons (where it was moved by Lord Howick), was there amended and passed, and received the royal assent on the 25th of March. The bill enacted that no vessel should clear out for slaves from any port within the British dominions after the 1st of May 1807, and that no slave should be landed in the colonies after the 1st of March 1808.

In 1807 the African Institution was formed, with the primary objects of keeping a vigilant watch on the slave traders and procuring, if possible, the abolition of the slave trade by the other European nations. It was also to be made an instrument for promoting the instruction of the negro races and diffusing information respecting the African continent.

The Act of 1807 was habitually violated, as the traders knew that, if one voyage in three was successful, they were abundantly remunerated for their losses. This state of things, it was plain, must continue as long as the trade was only a contraband commerce, involving merely pecuniary penalties. Accordingly, in 1811, Brougham carried through parliament a bill declaring the traffic to be a felony punishable with transportation. Some years later another act was passed, making it a capital offence; but this was afterwards repealed. The law of 1811 proved effectual and brought the slave trade to an end so far as the British dominions were concerned. Mauritius, indeed, continued it for a time. That island, which had been ceded by France in 1810, three years after the abolition, had special facilities for escaping observation in consequence of the proximity of the African coast; but it was soon obliged to conform.

The abolition of the French slave trade was preceded by struggles and excesses. The western part of St Domingo, nominally belonging to Spain, had been occupied by buccaneers, who were recognized and supported by the French government, and had been ceded to France at the peace of Ryswick in 1697. So vast was the annual importation of enslaved negroes into this colony before 1791 that the ratio of the blacks to the whites was as 16 to 1. In that year there were in French St Domingo 480,000 blacks, 24,000 mulattoes and only 30,000 whites. The French law for the regulation of slavery in the plantations, known as the *Code Noir* (framed under Louis XIV. in 1685), was humane in its spirit; but we are informed that its provisions were habitually disregarded by the planters, whilst the free mulattoes laboured under serious grievances and were exposed to irritating indignities. A "Société des Amis des Noirs" was formed in Paris in 1788 for the abolition, not only of the slave trade, but of slavery itself. The president was Condorcet, and amongst the members were the duc de la Rochefoucauld, the Abbé Gregoire, Brissot, Clavière, Pétion and La Fayette; Mirabeau was an active sympathizer. The great motor

of the parallel effort in England was the Christian spirit; in France it was the enthusiasm of humanity which was associated with the revolutionary movement. There were in 1789 a number of mulattoes in Paris, who had come from San Domingo to assert the rights of the people of colour in that colony before the national assembly. The Declaration of the Rights of Man in August 1789 seemed to meet their claims, but in March 1790 the assembly, alarmed by rumours of the discontent and disaffection of the planters in San Domingo, passed a resolution that it had not been intended to comprehend the internal government of the colonies in the constitution framed for the mother country. Vincent Ogé, one of the mulatto delegates in Paris, disgusted at the overthrow of the hopes of his race, returned to San Domingo, and on landing in October 1790 addressed a letter to the governor announcing his intention of taking up arms on behalf of the mulattoes if their wrongs were not redressed. He rose accordingly with a few followers, but was soon defeated and forced to take refuge in the Spanish part of the island. He was afterwards surrendered, tried and sentenced to be broken on the wheel. When the news of this reached Paris, it created a strong feeling against the planters; and on the motion of the Abbé Gregoire it was resolved by the assembly on the 15th of May 1791 "that the people of colour resident in the French colonies, born of free parents, were entitled to, as of right, and should be allowed, the enjoyment of all the privileges of French citizens, and among others those of being eligible to seats both in the parochial and colonial assemblies." On the 23rd of August a rebellion of the negroes broke out in the northern province of San Domingo, and soon extended to the western province, where the mulattoes and blacks combined. Many enormities were committed by the insurgents, and were avenged with scarcely inferior barbarity. The French assembly, fearing the loss of the colony, repealed on the 24th of September the decree of the preceding May. This vacillation put an end to all hope of a reconciliation of parties in the island. Civil commissioners sent out from France quarrelled with the governor and called the revolted negroes to their assistance. The white inhabitants of Cape François were massacred and the city in great part destroyed by fire. The planters now offered their allegiance to Great Britain; and an English force landed in the colony. But it was insufficient to encounter the hostility of the republican troops and the revolted negroes and mulattoes; it suffered from disease, and was obliged to evacuate the island in 1798. On the departure of the British the government remained in the hands of Toussaint l'Ouverture (*q.v.*). Slavery had disappeared; the blacks were employed as hired servants, receiving for their remuneration the third part of the crops they raised; and the population was rapidly rising in civilization and comfort. The whole island was now French, the Spanish portion having been ceded by the treaty of Basel. The wish of Toussaint was that San Domingo should enjoy a practical independence whilst recognizing the sovereignty and exclusive commercial rights of France. The issue of the violent and treacherous conduct of Bonaparte towards the island was that the blacks drove from their soil the forces sent to subdue them, and founded a constitution of their own, which was more than once modified. There can be no doubt that the government of the Restoration, in seeking to obtain possession of the island, had the intention of re-establishing slavery, and even of reopening the slave trade for the purpose of recruiting the diminished population. But Bonaparte abolished that trade during the Hundred Days, though he also failed to win back the people of San Domingo, or, as it was now called by its original name, Haiti, to obedience. The Bourbons, when again restored, could not reintroduce the slave trade; the notion of conquering the island had to be given up; and its independence was formally recognized in 1825 (see HAITI).

England had not been the first European power to abolish the slave trade; that honour belongs to Denmark; a royal order was issued on the 16th of May 1792 that the traffic should cease in the Danish possessions from the end of 1802. The United States had in 1794 forbidden any participation by American subjects in the slave trade to foreign countries; they now prohibited the importation of slaves from Africa into their own dominions. This act was passed on the 2nd of March 1807; it did not, however, come into force till 1st January 1808. At the congress of Vienna (November 1814) the principle was acknowledged that the slave trade should be abolished as soon as possible; but the determination of the limit of time was reserved for separate negotiation between the powers. It had been provided in a treaty between France and Great Britain (May 30, 1814) that no foreigner should in future introduce slaves into the French colonies, and that the trade should be absolutely interdicted to the French themselves after the 1st of June 1819. This postponement of abolition was dictated by the wish to introduce a fresh stock of slaves into Haiti, if that island should be recovered. Bonaparte, as we have seen, abolished the French slave trade during his brief restoration, and this abolition was confirmed at the second peace of Paris on the 20th of November, 1815, but it

was not effectually carried out by French legislation until March 1818. In January 1815 Portuguese subjects were prohibited from prosecuting the trade north of the equator, and the term after which the traffic should be everywhere unlawful was fixed to end on the 21st of January 1823, but was afterwards extended to February 1830; England paid £300,000 as a compensation to the Portuguese. A royal decree was issued on the 10th of December 1836 forbidding the export of slaves from any Portuguese possession. But this decree was often violated. It was agreed that the Spanish slave trade should come to an end in 1820, England paying to Spain an indemnification of £400,000. The Dutch trade was closed in 1814; the Swedish had been abolished in 1813. By the peace of Ghent, December 1814, the United States and England mutually bound themselves to do all in their power to extinguish the traffic. It was at once prohibited in several of the South American states when they acquired independence, as in La Plata, Venezuela and Chile. In 1831 and 1833 Great Britain entered into an arrangement with France for a mutual right of search within certain seas, to which most of the other powers acceded; and by the Ashburton treaty (1842) with the United States provision was made for the joint maintenance of squadrons on the west coast of Africa. By all these measures the slave trade, so far as it was carried on under the flags of European nations or for the supply of their colonies, ceased to exist.

Meantime another and more radical reform had been in preparation and was already in progress, namely, the abolition of slavery itself in the foreign possessions of the several states of Europe. When the English slave trade had been closed, it was found that the evils of the traffic, as still continued by several other nations, were greatly aggravated. In consequence of the activity of the British cruisers the traders made great efforts to carry as many slaves as possible in every voyage, and practised atrocities to get rid of the slaves when capture was imminent. It was, besides, the interest of the cruisers, who shared the price of the captured slave-ship, rather to allow the slaves to be taken on board than to prevent their being shipped at all. Thrice as great a number of negroes as before, it was said, was exported from Africa, and two-thirds of these were murdered on the high seas. It was found also that the abolition of the British slave trade did not lead to an improved treatment of the negroes in the West Indies. The slaves were overworked now that fresh supplies were stopped, and their numbers rapidly decreased. In 1807 there were in the West Indies 800,000; in 1830 they were reduced to 700,000. It became more and more evident that the evil could be stopped only by abolishing slavery altogether.

An appeal was made by Wilberforce in 1821 to Thomas Fowell Buxton to undertake the conduct of this new question in parliament. An anti-slavery society was established in 1823, the principal members of which, besides Wilberforce and Buxton, were Zachary Macaulay, Dr Lushington and Lord Suffield. Buxton moved on the 5th of May 1823 that the House should take into consideration the state of slavery in the British colonies. The object he and his associates had then in view was gradual abolition by establishing something like a system of serfdom for existing slaves, and passing at the same time a measure emancipating all their children born after a certain day. Canning carried against Buxton and his friends a motion to the effect that the desired ameliorations in the condition and treatment of the slaves should be recommended by the home government to the colonial legislatures, and enforced only in case of their resistance, direct action being taken in the single instance of Trinidad, which, being a crown colony, had no legislature of its own. A well-conceived series of measures of reform was accordingly proposed to the colonial authorities. Thereupon a general outcry was raised by the planters at the acquiescence of the government in the principles of the anti-slavery party. A vain attempt being made in Demerara to conceal from the knowledge of the slaves the arrival of the order in council, they became impressed with the idea that they had been set free, and accordingly refused to work, and, compulsion being resorted to, offered resistance. Martial law was proclaimed; the disturbances were repressed with great severity; and the treatment of the missionary Smith, which was taken up and handled with great ability by Brougham, awakened strong feeling in England against the planters. The question, however, made little progress in parliament for some years, though Buxton, William Smith, Lushington, Brougham, Mackintosh, Butterworth, and Denman, with the aid of Z. Macaulay, James

**Progress
of the
movement.**

**Anti-
slavery
movement.**

Stephen, and others, continued the struggle, only suspending it during a period allowed to the local legislatures for carrying into effect the measures expected from them. In 1828 the free people of colour in the colonies were placed on a footing of legal equality with their fellow-citizens. In 1830 the public began to be aroused to a serious prosecution of the main issue. It was becoming plain that the planters would take no steps tending to the future liberation of the slaves, and the leaders of the movement determined to urge the entire abolition of slavery at the earliest practicable period. The government continued to hesitate and to press for mitigations of the existing system. At length in 1833 the ministry of Earl Grey took the question in hand and carried the abolition with little difficulty, the measure passing the House of Commons on the 7th of August 1833 and receiving the Royal assent on the 28th. A sum of 20 millions sterling was voted as compensation to the planters. A system of apprenticeship for seven years was established as a transitional preparation for liberty. The slaves were bound to work for their masters during this period for three-fourths of the day, and were to be liable to corporal punishment if they did not give the due amount of labour. The master was, in return, to supply them with food and clothing. All children under six years of age were to be at once free, and provision was to be made for their religious and moral instruction. Many thought the postponement of emancipation unwise. Immediate liberation was carried out in Antigua, and public tranquillity was so far from being disturbed there that the Christmas of 1833 was the first for twenty years during which martial law was not proclaimed in order to preserve the peace. Notwithstanding protracted and strenuous opposition on the part of the government, the House of Commons passed a resolution against the continuance of the transitional system. When this was done the local legislatures saw that the slaves would no longer work for the masters; they accordingly cut off two years of the indentured apprenticeship, and gave freedom to the slaves in August 1838 instead of 1840.

The example of Great Britain was gradually followed by the other European states, and some American ones had already taken action of the same kind. The immediate emancipation of the slaves in the French colonies was decreed by the provisional government of 1848. In 1858 it was enacted that every slave belonging to a Portuguese subject should be free⁶ in twenty years from that date, a system of tutelage being established in the meantime. This law came into operation on the 20th of April 1878, and the status of slavery was thenceforth illegal throughout the Portuguese possessions. The Dutch emancipated their slaves in 1863. Several of the Spanish American states, on declaring their independence, had adopted measures for the discontinuance of slavery within their limits. It was abolished by a decree of the Mexican republic on 15th September 1829. The government of Buenos Aires enacted that all children born to slaves after the 31st of January 1813 should be free; and in Colombia it was provided that those born after the 16th of July 1821 should be liberated on attaining their eighteenth year.

Three of the most important slave systems still remained in which no steps towards emancipation had been taken—those of the Southern United States, of Cuba and of Brazil.

Slavery was far from being approved in principle by the most eminent of the fathers of the American Union. Washington in his will provided for the emancipation of his own slaves; he said to Jefferson that it was "among his first wishes to see some plan adopted by which slavery in his country might be abolished by law," and again he wrote that to this subject his own suffrage should never be wanting. John Adams declared his abhorrence of the practice of slaveholding, and said that "every measure of prudence ought to be assumed for the eventual total extirpation of slavery from the United States." Franklin's opinions we have already indicated; and Madison, Hamilton, and Patrick Henry all reprobated the principle of the system. Jefferson declared in regard to slavery, "I tremble for my country when I reflect that God is just." The last-named statesman, at the first Continental Congress after the evacuation by the British forces, proposed a draft ordinance (March 1st 1784) for the government of the North-West Territory, in which it was provided that "after the year 1800 there shall be neither slavery nor involuntary servitude in any of the said states, otherwise than in punishment of crime." This proviso, however, was lost; but in the Ordinance of 1787 (13 July) for the government of the territory

of the United States north-west of the Ohio river, which was introduced by Nathan Dane and probably drafted by Manasseh Cutler, slavery was forbidden in the Territory. At the convention of Philadelphia in 1787, where the constitution was drafted, the sentiments of the framers were against slavery; but South Carolina and Georgia insisted on its recognition as a condition of their joining the Union, and even an engagement for the mutual rendition of fugitive slaves was embodied in the federal pact. The words "slave" and "slavery" were, however, excluded from the constitution, "because," as Madison says, "they did not choose to admit the right of property in man" in direct terms; and it was at the same time provided that Congress might interdict the foreign slave trade after the expiration of twenty years. It must not be forgotten that either before or soon after the formation of the Union the Northern States—beginning with Vermont in 1777, and ending with New Jersey in 1804—either abolished slavery or adopted measures to effect its gradual abolition within their boundaries. But the principal operation of (at least) the latter change was simply to transfer Northern slaves to Southern markets.

We cannot follow in detail the several steps by which the slave power for a long time persistently increased its influence in the Union. The acquisition of Louisiana in 1803, which gave a new field for the growth of the slave power, though not made in its interest, the Missouri Compromise (1820), the annexation of Texas (1845), the Fugitive Slave Law (1850), the Kansas-Nebraska bill (1854), the Dred Scott decision (1857), the attempts to acquire Cuba (especially in 1854) and to reopen the foreign slave trade (1859-1860), were the principal steps—only some of them successful—in its career of aggression. They roused a determined spirit of opposition, founded on deep-seated convictions. The pioneer of the more recent abolitionist movement was Benjamin Lundy (1789-1839). He was followed by William Lloyd Garrison (1805-1879), Elijah P. Lovejoy (1802-1837)—a martyr, if ever there was one—Wendell Phillips, Charles Sumner, John Brown (b. 1800, hanged 1859), all of whom were in their several ways leading apostles or promoters of the cause. The best intellect of America outside the region of practical politics has been on the anti-slavery side. William E. Channing, R. W. Emerson, the poets Bryant, Longfellow, pre-eminently Whittier and Whitman, have spoken on this theme with no uncertain sound. The South, and its partisans in the North, made desperate efforts to prevent the free expression of opinion respecting the institution, and even the Christian churches in the slave states used their influence in favour of the maintenance of slavery. But in spite of every such effort opinion steadily grew. Public sentiment in the North was deeply stirred by the *Uncle Tom's Cabin* (1852) of Mrs Harriet Beecher Stowe, which, as Senior said, under the disguise of a novel was really a pamphlet against the Fugitive Slave Law. It gradually became apparent that the question could not be settled without an armed conflict. The election of Abraham Lincoln as president in November 1860 was the signal for the rising of the South. The North at first took arms simply to maintain the Union; but the far-sighted politicians from the first, and soon the whole nation, saw that the real issue was the continued existence or the total abolition of slavery. (See UNITED STATES.)

The war was practically closed by the surrender at Appomattox (9th April 1865), but already in 1862 slavery in the Territories had been abolished by Congress; on the 22nd of September of the same year Lincoln (*q.v.*) had issued the preliminary emancipation proclamation, followed on the 1st of January 1863 by the emancipation of all slaves in the states in arms against the Union; and in December 1865 a constitutional amendment was ratified abolishing and forever prohibiting slavery throughout the United States.

The Spanish slave code, promulgated in 1789, is admitted on all hands to have been very humane in its character; and, in consequence of this, after Trinidad had become an English possession, the anti-slavery party resisted—and successfully—the attempt of the planters (1811) to have the Spanish law in that island replaced by the British. But notwithstanding this

Cuba.

mildness of the code, its provisions were habitually and glaringly violated in the colonies of Spain, and in Cuba particularly the conditions of slavery were very bad. The slave population of the island was estimated in 1792 at 84,000; in 1817 at 179,000; in 1827 at 286,000; and in 1843 at 436,000. An act was passed by the Spanish legislature in 1870, providing that every slave who had then passed, or should thereafter pass, the age of sixty should be at once free, and that all yet unborn children of slaves should also be free. The latter, however, were to be maintained at the expense of the proprietors up to their eighteenth year, and during that time to be kept, as apprentices, to such work as was suitable for their age. This was known as the Moret Law, having been carried through the house of representatives by Señor Moret y Prendergast, then minister for the colonies. By the census of 1867 there was in Cuba a total population of 1,370,211 persons, of whom 764,750 were whites and 605,461 black or coloured; and of the latter number 225,938 were free and 379,523 were slaves. In 1873 the Cubans roughly estimated the population at 1,500,000—of whom 500,000, or one-third, were slaves. Mr Crowe, consul-general in the island, in 1885, stated that "the institution was rapidly dying,—that in a year, or at most two, slavery, even in its then mild form, would be extinct."

There was a convention between Great Britain and Brazil in 1826 for the abolition of the slave trade, but it was habitually violated in spite of the English cruisers. In 1830 the traffic was declared piracy by the emperor of Brazil. England asserted by the Aberdeen Act (1845) the right of seizing suspected craft in Brazilian waters. Yet by the connivance of the local administrative authorities 54,000 Africans continued to be annually imported. In 1850 the trade is said to have been decisively put down. The planters and mine proprietors cried out against this as a national calamity. The closing of the traffic made the labour of the slaves more severe, and led to the employment on the plantations of many who before had been engaged in domestic work; but the slavery of Brazil had always been lighter than that of the United States. On 28th September 1871 the Brazilian chambers decreed that slavery should be abolished throughout the empire. Though existing slaves were to remain slaves still, with the exception of those possessed by the government, who were liberated by the act, facilities for emancipation were given; and it was provided that all children born of female slaves after the day on which the law passed should be free. They were, however, bound to serve the owners of their mothers for a term of 21 years. A clause was inserted to the effect that a certain sum should be annually set aside from fines to aid each province in emancipating slaves by purchase. Seven years before the passing of this act the emperor, whose influence had always been exerted in favour of freedom, had liberated his private slaves, and many Brazilians after 1871 followed his example. Finally, in 1888 the chambers decreed the total abolition of slavery, some 700,000 persons being accordingly freed.

In the colonies of more than one European country, after the prohibition of the slave trade, attempts were made to replace it by a system of importing labourers of the inferior races under contracts for a somewhat lengthened term; and this was in several instances found to degenerate into a sort of legalized slave traffic. About 1867 we began to hear of a system of this kind which was in operation between the South Sea Islands and New Caledonia and the white settlements in Fiji. It seems to have begun in really voluntary agreements; but for these the unscrupulous greed of the traders soon substituted methods of fraud and violence. The natives were decoyed into the labour ships under false pretences, and then detained by force; or they were seized on shore or in their canoes and carried on board. The nature of the engagements to go and work on the plantations was not fully explained to them, and they were hired for periods exceeding the legal term. The area of this trade was ere long further extended. In 1884 attention was drawn in a special decree to the Queensland traffic in Pacific Islanders by the "Hopeful" trials, and a government commission was appointed to inquire into the methods followed by labour ships in recruiting the natives of New Guinea, the Louisiade Archipelago, and the D'Entrecasteaux group of islands. The result of the investigations, during which nearly five hundred witnesses were examined, was the disclosure of a system which in treachery and atrocity was little inferior to the old African slave trade. These shameful deeds made the islanders regard it as a duty to avenge their wrongs on any white men they could entice upon their shores. The bishop of Melanesia, John Coleridge Patteson, fell a victim to this retaliation on the island of Nukapu 20th September 1871.

We have seen that the last vestiges of the monstrous anomaly of modern colonial slavery are disappearing from all civilized states and their foreign possessions. It now remains to consider the slavery of primitive origin which has existed within recent times, or continues to exist, outside of the Western world.

In Russia, a country which had not the same historical antecedents with the Western nations, properly so called, and which is in fact more correctly classed as Eastern, whilst slavery had disappeared, serfdom was in force down to our own days. The rural population of that country, at the earliest period accessible to

our inquiries, consisted of (1) slaves, (2) free agricultural labourers, and (3) peasants proper, who were small farmers or cottiers and members of a commune. The sources of slavery were there, as elsewhere, capture in war, voluntary sale by poor freemen of themselves, sale of insolvent debtors, and the action of the law in certain criminal cases. In the 18th century we find the distinction between the three classes named above effaced and all of them merged in the class of serfs, who were the property either of the landed proprietors or of the state. They were not even *adscripti glebæ*, though forbidden to migrate; an imperial ukase of 1721 says, "the proprietors sell their peasants and domestic servants, not even in families, but one by one, like cattle." This practice, at first tacitly sanctioned by the government, which received dues on the sales, was at length formally recognized by several imperial ukases. Peter the Great imposed a poll-tax on all the members of the rural population, making the proprietors responsible for the tax charged on their serfs; and the "free wandering people" who were not willing to enter the army were required to settle on the land either as members of a commune or as serfs of some proprietor. The system of serfdom attained its fullest development in the reign of Catherine II. The serfs were bought, sold, and given in presents, sometimes with the land, sometimes without it, sometimes in families and sometimes individually, sale by public auction being alone forbidden, as "unbecoming in a European state." The proprietors could transport without trial their unruly serfs to Siberia or send them to the mines for life, and those who presented complaints against their masters were punished with the knout and condemned to the mines. The first symptoms of a reaction appear in the reign of Paul (1796–1801). He issued an ukase that the serfs should not be forced to work for their masters more than three days in each week. There were several feeble attempts at further reform, and even abortive projects of emancipation, from the commencement of the 19th century. But no decisive measures were taken before the accession of Alexander II. (1855). That emperor, after the Crimean War, created a secret committee composed of the great officers of state, called the chief committee for peasant affairs, to study the subject of serf-emancipation. Of this body the grand-duke Constantine was an energetic member. To accelerate the proceedings of the committee advantage was taken of the following incident. In the Lithuanian provinces the relations of the masters and serfs were regulated in the time of Nicholas by what were called inventories. "The nobles, dissatisfied with these, now sought to have them revised. The government interpreted the application as implying a wish for the abolition of serfdom, and issued a rescript authorizing the formation of committees to prepare definite proposals for a gradual emancipation. A circular was soon after sent to the governors and marshals of the nobility all over Russia proper, informing them of this desire of the Lithuanian nobles, and setting out the fundamental principles which should be observed "if the nobles of the provinces should express a similar desire." Public opinion strongly favoured the projected reform; and even the masters who were opposed to it saw that, if the operation became necessary, it would be more safely for their interests entrusted to the nobles than to the bureaucracy. Accordingly during 1858 a committee was created in nearly every province in which serfdom existed. From the schemes prepared by these committees, a general plan had to be elaborated, and the government appointed a special imperial commission for this purpose. The plan was formed, and, in spite of some opposition from the nobles, which was suppressed, it became law, and serfdom was abolished (19th February = 3rd March 1861). (See RUSSIA.) The total number of serfs belonging to proprietors at the time of the emancipation was 21,625,609, of whom 20,158,231 were peasant serfs and 1,467,378 domestic serfs. This number does not include the state serfs, who formed about one-half of the rural population. Their position had been better, as a rule, than that of the serfs on private estates; it might indeed, Mr (afterwards Sir) R. D. M. Wallace says, be regarded as "an intermediate position between serfage and freedom." Amongst them were the serfs on the lands formerly belonging to the church, which had been secularized and transformed into state demesnes by Catherine II. There were also serfs on the apanages affected to the use of the imperial family; these amounted to nearly three and a half millions. Thus by the law of 1861 more than forty millions of serfs were emancipated.

The slavery of the Mahomedan East is usually not the slavery of the field but of the household. The slave is a member of the family, and is treated with tenderness and affection. The Koran breathes a considerate and kindly spirit towards the class, and encourages manumission. The child of a slave girl by her master is born free, and the mother is usually raised to be a free wife. The traffic in slaves has been repeatedly declared by the Ottoman Porte to be illegal throughout its dominions, and a law for its suppression was published in 1889, but it cannot be said to be extinct, owing to the laxity and too often the complicity of the government officials. In Egypt it has practically died out.

In the days of the colonial slave trade its African centre was the region about the mouths of the rivers Calabar and Bonny, whither the captive negroes were brought from great distances in the interior. As many slaves, Clarkson tells us, came annually from this part of the coast as from all the rest of Africa besides. The principal centres from which the supply was furnished

Russian serfdom.

Mahomedan slavery.

Africa.

to Egypt, Turkey, Arabia, and Persia were three in number. (1) The central Sudan appeared to be one vast hunting-ground. Captives were brought thence to the slave market of Kuka in Bornu, where, after being bought by dealers, they were, to the number of about 10,000 annually, marched across the Sahara to Murzuk in Fezzan, from which place they were distributed to the northern and eastern Mediterranean coasts. Their sufferings on the route were dreadful; many succumbed and were abandoned. Rohlf's informs us that "any one who did not know the way" by which the caravans passed "would only have to follow the bones which lie right and left of the track." Negroes were also brought to Morocco from the Western Sudan and from Timbuktu. The centre of the traffic in Morocco was Sidi Hamed ibn Musa, seven days' journey south of Mogador, where a great yearly fair was held. The slaves were forwarded thence in gangs to different towns, especially to Marrakesh, Fez and Mequinez. About 4000 were thus annually imported, and an *ad valorem* duty was levied by the sultan, which produced about £4800 of annual revenue. The control now exercised by the French over the greater part of the western Sudan has deprived Morocco of its chief sources of supply. Slavery, however, still flourishes in that empire. (2) The basin of the Upper Nile, extending to the great lakes, was another region infested by the slave trade; the slaves were either smuggled into Egypt or sent by the Red Sea to Turkey. The khedive Ismail in 1869 appointed Sir Samuel Baker to the command of a large force with which he was "to strike a direct blow at the slave trade in its distant nest." The work begun by him was continued by Colonel C. G. Gordon (1874 to 1879), but under the Mahdi and the Khalifa the slave trade was revived. Since the reconquest of the eastern Sudan by an Anglo-Egyptian force in 1898 effective measures have been taken to suppress slave raiding and as far as possible slavery itself. The conquest of the central Sudan states by France—completed in 1910 by the subjugation of Wadai—has practically ended the caravan trade in slaves across the Sahara. (3) There was for long a slave trade from the Portuguese possessions on the East African coast. The stream of supply came mainly from the southern Nyasa districts by three or four routes to Ibo, Mozambique, Angoche and Quilimane. Madagascar and the Comoro Islands obtained most of their slaves from the Mozambique coast. It was believed in 1862 that about 19,000 passed every year from the Nyasa regions to Zanzibar, whence large supplies were drawn for the markets of Arabia and Persia up to 1873. The mission of Sir Bartle Frere to the sultan of Zanzibar in 1873 brought about a treaty for the suppression of the slave trade. It is said that, whereas 10,000 slaves formerly passed the southern end of the Nyasa every year, in 1876 not more than 38 were known to have been conveyed by that route. Lieutenant O'Neill, British consul at Mozambique, writing in 1880, fixed at about 3000 the number then annually exported from the coast between the rivers Rovuma and Zambesi. With the establishment of a British protectorate at Zanzibar, and of British and German protectorates on the mainland of East Africa and in the region of the head-waters of the Nile, the East African slave trade received its death-blow. Slavery itself has been abolished in the Zanzibar, British, German and Portuguese dominions, and had ceased in Madagascar even before its conquest by the French. The complete control of the seaboard by European powers has rendered the smuggling of slaves to Arabia and Persia a difficult and dangerous occupation.

A new era was opened up by the discovery of the course of the Congo by H. M. Stanley, the founding of the Congo Free State by Leopold II. of Belgium and the partition of the greater part of Africa between various European powers. Though the history of the Congo Free State affords a painful contrast to the philanthropic professions of its founder, in other parts of the continent the establishment of protectorates by Great Britain, France and Germany was followed by strenuous, and largely successful, efforts to put down slave raiding. In parts where European authority remained weak, as in the hinterland of the Portuguese province of Angola and the adjacent regions of Central Africa, native potentates continued to raid their neighbours, and from this region many labourers were (up to 1910) forcibly taken to work on the cocoa plantation in St Thomas (*q.v.*). With the accession of Albert I. to the Belgian throne in 1909 a serious endeavour was made to improve the state of affairs in the Congo. At the close of the first decade of the 20th century it might be said that over the greater part of Africa slave raiding was a thing of the past.

Clarkson first, and Buxton afterwards, whilst they urged all other means for the suppression or discouragement of the slave trade and slavery, saw clearly that the only thoroughly effectual method would be the development of legitimate commerce in Africa itself. When Buxton published in 1840 his book entitled *The Slave Trade and its Remedy*, this was the remedy he contemplated. The unfortunate Niger expedition of 1841 was directed to similar ends; and it has been more and more felt by all who were interested in the subject that here lies the radical solution of the great problem. It was for some time thought that from Sierra Leone as a centre industry and civilization might be diffused amongst the nations of the continent; and in 1822 the colony (which in 1847 became the independent republic) of Liberia had been founded by Americans with a similar object; but in neither case have these expectations been adequately fulfilled.

BIBLIOGRAPHY.—On the several branches of the subject of slavery and serfdom information may be obtained from the following works:—

On Ancient Slavery: H. Wallon, *Histoire de l'esclavage dans l'antiquité* (3 vols., 1847; 2nd ed., 1879); A. Boeckh, *Public Economy of Athens*, Eng. trans. by G. Cornwell Lewis (1828; 2nd ed., 1842); William Blair, *Inquiry into the State of Slavery among the Romans, from the Earliest Period to the Establishment of the Lombards in Italy* (1833); Dureau de la Malle, *Économie politique des Romains* (2 vols., 1840); M. Troplong, *De l'influence du Christianisme sur le droit civil des Romains* (2nd ed., 1855); Ebeling, *Die Sklaverei von den ältesten Zeiten bis auf die Gegenwart* (Paderborn, 1889); W. W. Buckland, *The Roman Law of Slavery* (Cambridge, 1909); A. Calderini, *La Manomissione dei liberti in Grecia* (Milan, 1908).

On Medieval Slavery and Serfdom: G. Humbert, article "Colonat" in the *Dictionnaire des antiquités grecques et romaines* of Daremberg and Saglio; J. Yanoski, *De l'abolition de l'esclavage ancien au moyen âge et de sa transformation en servitude de la glèbe* (Wallon and Yanoski had jointly composed a memoir to compete for a prize offered by the Academy of Moral and Political Sciences in 1837; Wallon's portion of the memoir became the foundation of his *Histoire de l'esclavage dans l'antiquité* above mentioned; Yanoski's part, the expansion of which was prevented by his early death, was posthumously published in 1860; it is no more than a slight sketch); Benjamin Guérard, *Prolégomènes au Polyptyque d'Irminon* (1844); Fustel de Coulanges, *Histoire des institutions politiques de l'ancienne France* (2nd ed., 1877), and *Recherches sur quelques problèmes d'histoire* (1885) (the latter work contains an admirable discussion of the whole subject of the *colonatus*, founded throughout on the original texts); Stubbs, *Constitutional History of England* (3 vols., 1874–1878). On the Colonial Slave Trade and Slavery: Washington Irving, *Life and Voyages of Christopher Columbus* (1828), several times reprinted; Arthur Helps, *Life of Las Casas* (1868); Bryan Edwards, *History, Civil and Commercial, of the British West Indies* (1793; 5th ed. in 5 vols., 1819); Thomas Clarkson, *History of the Rise, Progress, and Accomplishment of the Abolition of the African Slave Trade by the British Parliament* (2 vols., 1808); T. Fowell Buxton, *African Slave Trade* (2nd ed., 1838), and *The Remedy, a Sequel* (1840); *Memoirs of Sir T. F. Buxton*, edited by his son Charles Buxton (3rd ed., 1849). On North American Slavery: G. M. Stroud, *Laws relating to Slavery in America* (2nd ed., 1856); H. Greeley, *The American Conflict* (1865); John E. Cairnes, *The Slave Power, its Character, Career, and Probable Designs* (1862; 2nd ed., 1863); H. Wilson, *History of the Rise and Fall of the Slave Power in America* (Boston, 1872); *Johns Hopkins University Studies in Historical and Political Science* (Baltimore, 1889–1902); Du Bois, *Suppression of the African Slave Trade to the United States* (New York, 1896); Merriam, *The Negro and the Nation* (New York, 1906); Sir H. H. Johnston, *The Negro in the New World* (London, 1910); Ballagh, *A History of Slavery in Virginia* (Baltimore, 1902); B. B. Munford, *Virginia's Attitude toward Slavery* (London, 1909), and A. Johnston, *History of American Politics* (New York, 4th ed., 1898); H. E. von Holst, *The Constitutional and Political History of the United States* (Chicago, 1899). On Brazilian: Fletcher and Kidder, *Brazil and the Brazilians* (9th ed., 1879). On Russian Serfdom: D. Mackenzie Wallace, *Russia* (1877). For the African slave trade, and Egyptian and Turkish slavery, the *Ismailia* of Sir S. Baker, the writings of Livingstone, and the biographies of Gordon may be consulted, besides the many documents on these subjects published by the British and Foreign Anti-Slavery Society. There are two volumes by A. Tourmagne, entitled respectively *Histoire de l'esclavage ancien et moderne* (1880) and *Histoire du servage ancien et moderne* (1879), which bring together many facts relating to slavery and serfdom; but they are somewhat loose and uncritical; the author, too, repeats himself much, and dwells on many topics scarcely if at all connected with his main themes; see also H. J. Nieboer, *Slavery as an Industrial System* (The Hague, 1900); W. H. Smith, *Political History of Slavery* (London, 1903). The largest and most philosophical views on slavery generally will be found in Hume's essay "On the Populousness of Antient Nations," and in Comte's *Philosophie positive*, vol. v., and *Politique positive*, vol. iii. For its economic effects, when it is regarded as an organization of labour, reference may be had to Smith's *Wealth of Nations*, book iii. chap. 2, J. S. Mill's *Political Economy*, book ii. chap. 5, and J. E. Cairnes's *Slave Power*, chap. 2. (J. K. I.; X.)

SLAVONIC, OLD. In the article SLAVS (under *Languages*) will be found a fairly complete account of Old Slavonic in its first form, as it is taken as representing, save for a few peculiarities noticed in their place, the Proto-Slavonic. The reasons are there given for believing it to be the dialect of Slavs settled somewhere between Thessalonica and Constantinople and represented now by the Bulgarians and Macedonians.

After the language had been fixed by the original translations of the New Testament and other Church books it was no more consciously adapted to the dialects of the various peoples, but was used equally among the Croats (whose books were accommodated to the Roman use and written in Glagolitic), Serbs and

Russians. These insensibly altered them to make the words easier and allowed their native languages to show through; and the same was the case with the Bulgarians, whose language soon began to lose some of the characteristics of O.S. Hence our earliest MSS. already show departure from the norm which can be established by comparison; about a dozen (8 Glagolitic) MSS. and fragments afford trustworthy material dating from the 10th and 11th centuries, but even then the S. Slavs were weak in distinguishing *i* and *y*, the Russians mixed up *q* with *u*, *ę* with *ja* and so on; but in the actual texts great conservatism prevailed, whereas any additions, such as colophons or marks of ownership, betray the dialect of the writer more clearly, and such scraps and a few deeds are our earliest authorities for Servian and Russian. But the Church language as insensibly modified continued to be the literary language of Croatia until the 16th century, of Russia until 1700, and of Bulgaria, Servia and Rumania until the early part of the 19th century, and is still the liturgical language of Dalmatia, the Balkans, Russia and the Ruthenian Uniates.

Its literature was enriched in the second generation by the works of Clement, bishop of Ochrida, and John, exarch of Bulgaria, and other writers of the time of Tsar Simeon, but it is almost all ecclesiastical in character. Perhaps the most interesting book in Church Slavonic is the Russian chronicle, but that has many old Russian forms. Otherwise certain translations of Greek Apocrypha are of importance, especially when the Greek original is lost, e.g. the Book of Enoch; other Apocrypha in Church Slavonic are said to have been written by Jeremias, a Bogomil priest, but they are probably derived from Eastern sources. The Slavonic text of the Bible is not of importance for textual criticism, as the translation was made late, and even so has never been studied from that point of view. The whole Bible was not finished till the 15th century, some of the less necessary books being translated from the Vulgate.

SLAVS. Judged by the language test, and no other is readily available, the Slavs are the most numerous race in Europe, amounting to some 140,000,000 souls. Outside Europe there are the Russians in Siberia, a mere extension of the main body, and a large number of emigrants settled in America, where, however, although most of the nationalities have their own newspapers, the second generation of immigrants tends to be assimilated.

Divisions and Distribution.—The Slavs are divided geographically into three main groups, Eastern, North-Western and Southern; linguistically also the same division is convenient.

The Russians stand by themselves as the Eastern group. They hold all the East European plain from the 27th meridian to the Urals, the Finnish and Tatar tribes making up but a small proportion of the population: beyond these limits to the east they stretch into central Siberia and thence in narrow bands along the rivers all the way to the Pacific; on the west the Ruthenians (*q.v.*) of Galicia form a wedge between the Poles and the Magyars and almost touch the 20th meridian. The Russians must number 100,000,000.

The North-Western group includes the Poles, about 15,000,000, in the basin of the Vistula; the Kashubes (*q.v.*), about 200,000, on the coast north-west of Danzig; the High and Low Sorbs (*q.v.*) or Wends in Lusatia, 180,000 Slavs completely surrounded by Germans; the Čechs (Czech, *q.v.*) in the square of Bohemia, making up with their eastern neighbours, the Moravians, a people of 6,000,000 in northern Austria surrounded on three sides by Germans. In the north of Hungary, connecting up Ruthenians, Poles and Moravians, but most closely akin to the latter, are 2,500,000 Slovaks (*q.v.*). With the Sorbs, Poles and Kashubes are to be classed the now teutonized Slavs of central Germany, who once stretched as far to the north-west as Rügen and Holstein and to the south-west to the Saale. They are generally called Polabs (*q.v.*), of Slavson the Elbe, as their last survivors were found on that river in the eastern corner of Hanover.

The Southern Slavs, Slovenes (*q.v.*), Serbo-Croats (see *SERVIA*) and Bulgarians (see *BULGARIA*), are cut off from the main body by the Germans of Austria proper and the Magyars, both

of whom occupy soil once Slavonic, and have absorbed much Slavonic blood, and by the Rumanians of Transylvania and the Lower Danube, who represent the original Dacians romanized. These Slavs occupy the main mass of the Balkan Peninsula downwards from the Julian Alps and the line of the Muhr, Drave and Danube. North of this all three races have considerable settlements in southern Hungary. Their southern boundary is very ill-defined, various nationalities being closely intermingled. To the south-west the Slavs march with the Albanians, to the south-east with the Turks, and to the south and along the Aegean coasts they have the Greeks as neighbours.

Although the Southern Slavs fall into these three divisions, linguistically the separation is not sharp, nor does it coincide with the political frontiers. Roughly speaking, the eastern half of the peninsula is held by the Bulgarians, some 5,000,000 in number, the western half by the Serbo-Croats, of whom there must be about 8,000,000. This is the most divided of the Slavonic races; its members profess three forms of religion and use three alphabets—the Serbs and Bosnians being mostly Orthodox and using the Cyrillic alphabet, but including many Mussulmans; the Croats being Roman Catholics, writing with Latin letters; and the Dalmatians also Roman Catholics, but using, some of them, the ancient Glagolitic script for their Slavonic liturgy. The language also falls into three dialects independent of the religions, and across all these lines run the frontiers of the political divisions—the kingdom of Servia (more correctly written *Serbia*); the kingdom of Montenegro; the Turkish provinces of Old Servia and Novibazar, still in Turkish hands; those of Bosnia and Herzegovina, annexed by Austria; the coast-line and islands of Istria and Dalmatia, which also form part of Austria; and the kingdom of Croatia, which is included in the dominion of Hungary, to say nothing of outlying colonies in Hungary itself and in Italy. In the extreme north-west, in Carniola, in the southern parts of Styria and Carinthia, and over the Italian border in the province of Udine and the Vale of Resia live the Slovenes, something under 1,500,000, much divided dialectically. Between the Slovenes and the Croats there are transition dialects, and about 1840 there was an attempt (Illyrism) to establish a common literary language. In Macedonia and along the border are special varieties of Bulgarian, some of which approach Servian. Akin to the Macedonians were the Slavs, who once occupied the whole of Greece and left traces in the place-names, though they long ago disappeared among the older population. Akin to the Slovenes were the old inhabitants of Austria and south-west Hungary before the intrusion of the Germans and Magyars.

History.—This distribution of the Slavs can be accounted for historically. In spite of traditions (e.g. the first Russian chronicle of Pseudo-Nestor) which bring them from the basin of the Danube, most evidence goes to show that when they formed one people they were settled to the north-east of the Carpathians in the basins of the Vistula, Pripet and Upper Dněstr (Dniester). To the N. they had their nearest relatives, the ancestors of the Baltic tribes, Prussians, Lithuanians and Letts; to the E. Finns; to the S.E. the Iranian population of the Steppes of Scythia (*q.v.*); to the S.W., on the other side of the Carpathians, various Thracian tribes; to the N.W. the Germans; between the Germans and Thracians they seem to have had some contact with the Celts, but this was not the first state of things, as the Illyrians, Greeks and Italians probably came between. This location, arrived at by a comparison of the fragmentary accounts of Slavonic migrations and their distribution in historic time, is confirmed by its agreement with the place taken by the Slavonic language among the other Indo-European languages (see below), and by what we know of the place-names of eastern Europe, in that for this area they seem exclusively Slavonic, outside it the oldest names belong to other languages. The archaeological evidence is not yet cleared up, as, for the period we have to consider, the late neolithic and early bronze age, the region above defined is divided between three different cultures, represented by the fields of urns in Lusatia and Silesia, cist graves with cremation in Poland, and the poor and little-known graves of the Dněpr

(Dnieper) basin. This variety may to some extent be due to the various cultural influences to which the same race was exposed, the western division lying on the route between the Baltic and Mediterranean, the central being quite inaccessible, the eastern part in time showing in its graves the influence of the Steppe people and the Greek colonies in Scythia. There is a gradual transition to cemeteries with Roman objects which shade off into such as are certainly Slavonic.

The physical type of the Slavs is not sufficiently clear to help in throwing light upon the past of the race. Most of the modern Slavs are rather short-headed, the Balkan Slavs being tall and dark, those of central Europe dark and of medium height, the Russians on the whole rather short though the White and Little Russians are of medium height; in complexion the southern Russians are dark, the northern light, but with less decided colour than fair western Europeans. In spite of the prevalent brachycephaly of the modern Slavs, measurements of skulls from cemeteries and ancient graves which are certainly Slavonic have shown, against all expectation, that the farther back we go the greater is the proportion of long heads, and the race appears to have been originally dolichocephalic and osteologically indistinguishable from its German, Baltic and Finnish neighbours. In its present seats it must have assimilated foreign elements, German and Celtic in central Europe, Finnish and Turkish in Great and Little Russia, all these together with Thracian and Illyrian in the Balkans; but how much the differences between the various Slavonic nations are due to admixture, how much to their new homes, has not been made clear.

In spite of the vast area which the Slavs have occupied in historic times there is no reason to claim for them before the migrations a wider homeland than that above defined beyond the Carpathians; given favourable circumstances a nation multiplies so fast (e.g. the Anglo-Saxons in the last hundred and twenty years) that we can set no limits to the area that a comparatively small race could cover in the course of four centuries. Therefore the mere necessity of providing them with ancestors sufficiently numerous does not compel us to seek for the Slavs among any of the populous nations of the ancient world. Various investigators have seen Slavs in Scythians, Sarmatians, Thracians, Illyrians, and in fact in almost all the barbarous tribes which have been mentioned in the east of Europe, but we can refer most of such tribes to their real affinities much better than the ancients, and at any rate we can be sure that none of these were Slavs.

There is no evidence that the Slavs made any considerable migration from their first home until the 1st century A.D. Their first Transcarpathian seat lay singularly remote from the knowledge of the Mediterranean peoples. Herodotus (iv. 17, 51, 105) does seem to mention the Slavs under the name of Neuri (q.v.), at least the Neuri on the upper waters of the Dněstr are in the right place for Slavs, and their lycanthropy suggests modern Slavonic superstitions; so we are justified in equating Neuri and Slavs, though we have no direct statement of their identity. Other classical writers down to and including Strabo tell us nothing of eastern Europe beyond the immediate neighbourhood of the Euxine.

Pliny (*N.H.* iv. 97) is the first to give the Slavs a name which can leave us in no doubt. He speaks of the *Venedi* (cf. Tacitus, *Germania*, 46, *Venedi*); Ptolemy (*Geog.* iii. 5. 7, 8) calls them *Venedae* and puts them along the Vistula and by the Venedic gulf, by which he seems to mean the Gulf of Danzig; he also speaks of the Venedic mountains to the south of the sources of the Vistula, that is, probably the northern Carpathians. The name *Venedae* is clearly Wend, the name that the Germans have always applied to the Slavs. Its meaning is unknown. It has been the cause of much confusion because of the Armorican *Venedi*, the Paphlagonian *Enetae*, and above all the *Enetae-Venetae* at the head of the Adriatic. Enthusiasts have set all of these down as Slavs, and the last with some show of reason, as nowadays we have Slovenes just north of Venice. However, inscriptions in the Venetian language are sufficient to prove that it was not Slavonic. Other names in Ptolemy which almost certainly denote Slavonic tribes are the *Veltae* on the Baltic,

ancestors of the Wiltzi, a division of the Polabs (q.v.), the Sulani and the Saboci, whose name is a Slavonic translation of the Transmontani of another source.

Unless we are to conjecture *Stlavani* for Ptolemy's *Stavani*, or to insist on the resemblance of his *Suobeni* to Slovene, the name Slav first occurs in Pseudo-Caesarius (*Dialogues*, ii. 110; Migne, *P.G.* xxxviii. 985, early 6th century), but the earliest definite account of them under that name is given by Jordanes (*Getica*, v. 34, 35, c. 550 A.D.): *Dacia . . . ad coronae speciem arduis Alpibus emunita, iuxta quorum sinistrum latus, qui in aquilone vergit, ab ortu Vistulae fluminis per immensa spatia Venetharum populosa natio consedit. Quorum nomina licet nunc per varias familias et loca mutentur, principaliter tamen Sclaveni et Antes nominantur. Sclaveni a civitate Novietunense (Noviodunum, Isakča on the Danube Delta) . . . usque ad Danastrum et in boream Viscla tenuis commorantur . . . Antes vero, qui sunt eorum fortissimi, qua Ponticum mare curvatur a Danastro extenduntur usque ad Danaprum*; cf. xxiii. 119, where these tribes are said to form part of the dominions of Hermanrich. *Sclaveni*, or something like it, has been the regular name for the Slavs from that day to this. The native form is *Slověne*; in some cases, e.g. in modern Russian under foreign influence, we have an *a* instead of the *o*. The combination *sl* was difficult to the Greeks and Romans and they inserted *t*, *th* or most commonly *c*, which continues to crop up. So too in Arabic *Saqaliba*, *Saqalāb*. The name has been derived from *slovo*, a word, or *slava*, glory, either directly or through the *-slav* which forms the second element in so many Slavonic proper names, but no explanation is satisfactory. The word "slave" and its cognates in most European languages date from the time when the Germans supplied the slave-markets of Europe with Slavonic captives. The name *Antes* we find applied to the Eastern Slavs by Jordanes; it may be another form of *Wend*. *Antae* is used by Procopius (*B.G.* iii. 14). He likewise distinguishes them from the *Sclaveni*, but says that both spoke the same language and both were formerly called *Spori*, which has been identified with *Serb*, the racial name now surviving in *Lusatia* and *Servia*. Elsewhere he speaks of the measureless tribes of the *Antae*; this appellation is used by the Byzantines until the middle of the 7th century.

The sudden appearance in the 6th-century writers of definite names for the Slavs and their divisions means that by then the race had made itself familiar to the Graeco-Roman world, that it had spread well beyond its original narrow limits, and had some time before come into contact with civilisation. This may have been going on since the 1st century A.D., and evidence of it has been seen in the southward movement of the *Costoboci* into northern *Dacia* (Ptolemy) and of the *Carpi* to the Danube (A.D. 200), but their Slavonic character is not established. A few ancient names on the Danube, notably that of the river *Tsierna* (*Černa*, black), have a Slavonic look, but a coincidence is quite possible. The gradual spread of the Slavs was masked by the wholesale migrations of the Goths, who for two centuries lorded it over the Slavs, at first on the Vistula and then in south Russia. We hear more of their movements because they were more immediately threatening for the Empire. In dealing with Ptolemy's location of the Goths and Slavs we must regard the former as superimposed upon the latter and occupying the same territories. This domination of the Goths was of enormous importance in the development of the Slavs. By this we may explain the presence of a large number of Germanic loan words common to all the Slavonic languages, many of them words of cultural significance. "King, penny, house, loaf, earring" all appear in Slavonic; the words must have come from the Goths and prove their strong influence, although the things must have been familiar before. On the other hand "plough" is said to be Slavonic, but that is not certain. When the Huns succeeded the Goths as masters of central Europe, they probably made the Slavs supply them with contingents. Indeed their easy victory may have been due to the dissatisfaction of the Slavs. Priscus (Müller, *F.H.G.* iv. p. 69, cf. *Jord. Get.* xlix. 258) in his account of the camp of Attila mentions words which may be Slavonic, but have also been explained from German. After the fall of

the Hunnish power the Eastern Goths and Gepidae pressed southwards and westwards to the conquest of the Empire, and the Lombards and Heruli followed in their tracks. When next we get a view of northern Germany we find it full of Slavs, e.g. from Procopius (*B.G.* ii. 15) we know that they held the Mark of Brandenburg by 512; but this settlement was effected without attracting the attention of any contemporary writer. Modern historians seem to adopt their attitude to the process according to their view of the Slavs; German writers, in their contempt for the Slavs, mostly deny the possibility of their having forced German tribes to leave their homes, and assume that the riches of southern Europe attracted the latter so that they willingly gave up their barren northern plains; most Slavonic authors have taken the same view in accordance with the idealistic picture of the peaceful, kindly, democratic Slavs who contrast so favourably with the savage Germans and their war-lords; but of late they have realised that their ancestors were no more peaceful than any one else, and have wished to put down to warlike pressure from the Slavs all the southward movements of the German tribes, to whom no choice was left but to try to break through the Roman defences. A reasonable view is that the expansion of the Eastern Germans in the last centuries B.C. was made at the expense of the Slavs, who, while no more peaceful than the Germans, were less capable than they of combining for successful war, so that Goths and others were dwelling among them and lording it over them; that the mutual competitions of the Germans drove some of these against the Empire, and when this had become weakened, so that it invited attack, some tribes and parts of tribes moved forward without any pressure from behind; this took away the strength of the German element, and the Slavs, not improbably under German organization, regained the upper hand in their own lands and could even spread westwards at the expense of the German remnant.

Almost as uncertain is the exact time when the Southern Slavs began to move towards the Balkans. If already at the time of Trajan's conquests there were Slavs in Dacia, it would account for the story in Ps. Nestor that certain Volchi or Vlachi, i.e. Romance speakers, had conquered the Slavs upon the Danube and driven them to the Vistula, for the place that the name of Trajan has in Slavonic tradition, and for the presence of an agricultural population, the Sarmatae Limigantes subject to the nomad Sarmatae (*q.v.*), on the Theiss. In any case, we cannot say that the Slavs occupied any large parts of the Balkan Peninsula before the beginning of the 6th century, when they appear in Byzantine history as a new terror; there seems to have been an invasion in the time of Justin, and another followed in 527 (Procopius, *B.G.* iii. 40 and *Hist. Arc.* 18). At the same time as the Slavs, the Huns, the Bulgars, and after 558 the Avars, were also making invasions from the same direction. The first and last disappeared like all nomads, but the Bulgars, making themselves lords of one section of the Slavs, gave it their own name. By 584 the Slavs had overrun all Greece, and were the worst western neighbours of the Eastern Empire. Hence the directions how to deal with Slavs in the *Strategicum* of the emperor Maurice (*c.* 600) and the *Tactics* of Leo.

By the end of the following century they were permanently settled throughout the whole of the Balkan Peninsula. (For their further history see SERBIA, BULGARIA, BOSNIA, DALMATIA, CROATIA-SLAVONIA.) These Southern Slavs, though divided into nationalities, are closely akin to one another. There is no reason to think the Serbo-Croats an intrusive wedge, although Constantine Porphyrogenitus (*De adm. Imp.* 30-33) speaks of their coming from the north in the time of Heraclius—the middle of the 7th century. Their dialects shade into one another, and there is no trace of any influence of the North-Western group. Constantine was probably led astray by the occurrence of the same tribal names in different parts of the Slavonic world. Meanwhile the Southern Slavs were cut off from the rest of the race by the foundation in the 6th century of the Avar kingdom in Pannonia, and after its destruction in the 7th, by the spread of the Germans south-eastwards, and finally by the incursion of

another Asiatic horde, that of the Magyars, who have maintained themselves in the midst of Slavs for a thousand years. Their conquests were made chiefly at the expense of the Slovenes and the Slovaks, and from their languages they have borrowed many words in forms which have now disappeared.

Of the history of the Eastern Slavs, who were to become the Russian people, we know little before the coming of the Swedish Rus, who gave them their name and organization; we have but the mention of Antae acting in concert with the other Slavs and the Avars in attacking the Empire on the lower Danube, and scattered accounts of Mussulman travellers, which show that they had reached the Don and Volga and stretched up northward to Lake Ilmen. The more southerly tribes were tributary to the Khazars. An exact definition of the territory occupied by each Slavonic people, and a sketch of its history from the time that it settled in its permanent abode, will be found either under its own name or under that of its country.

Culture and Religion.—For all the works treating of Slavonic antiquities we cannot draw a portrait of the race and show many distinguishing features. Savage nations as described by the Greeks and Romans are mostly very much alike, and the testimony of language is not very easy to use. The general impression is one of a people which lived in small communistic groups, and was so impatient of authority that they scarcely combined for their own defence, and in spite of individual bravery only became formidable to others when cemented together by some alien element: hence they all at one time or another fell under an alien yoke; the last survivals of Slavonic licence being the *veče* of Novgorod, and the Polish diet with its unpractical regard for any minority. The Slavs were acquainted with the beginnings of the domestic arts, and were probably more given to agriculture than the early Germans, though they practised it after a fashion which did not long tie them to any particular district—for all writers agree in telling of their errant nature. They were specially given to the production of honey, from which they brewed mead. They also appear to have been notable swimmers and to have been skilled in the navigation of rivers, and even to have indulged in maritime piracy on the Aegean, the Dalmatian coast and most of all the Baltic, where the island of Rügen was a menace to the Scandinavian and German sea-power. The Oriental sources also speak of some aptitude for commerce. Their talent for music and singing was already noticeable. Of their religion it is strangely difficult to gain any real information. The word Bogŭ, "god," is reckoned a loan word from the Iranian Baga. The chief deity was the Thunderer Perŭn (*cf.* Lith. Perkŭnas), with whom is identified Svarog, the god of heaven; other chief gods were called sons of Svarog, Dažbog the sun, Chors and Veles, the god of cattle. The place of this latter was taken by St Blasius. A hostile deity was Stribog, god of storms. There seem to have been no priests, temples or images among the early Slavs. In Russia Vladimir set up idols and pulled them down upon his conversion to Christianity; only the Polabs had a highly developed cult with a temple and statues and a definite priesthood. But this may have been in imitation of Norse or even Christian institutions. Their chief deity was called Triglav, or the three-headed; he was the same as Světovit, apparently a sky god in whose name the monks naturally recognized Saint Vitus. The goddesses are colourless personifications, such as Vesna, spring, and Morana, the goddess of death and winter. The Slavs also believed, and many still believe, in Vily and Rusalki, nymphs of streams and woodlands; also in the Bába-Jagá, a kind of man-eating witch, and in Běsy, evil spirits, as well as in vampires and werewolves. They had a full belief in the immortality of the soul, but no very clear ideas as to its fate. It was mostly supposed to go a long journey to a paradise (*raj*) at the end of the world and had to be equipped for this. Also the soul of the ancestor seems to have developed into the house or hearth god (*Domovŭj, Křet*) who guarded the family. The usual survivals of pagan festivals at the solstices and equinoxes have continued under the form of church festivals.

Christianity among the Slavs.—The means by which was effected the conversion to Christianity of the various Slavonic

nations has probably had more influence upon their subsequent history than racial distinctions or geographical conditions.

Wherever heathen Slavonic tribes met Christendom missionary effort naturally came into being. This seems first to have been the case along the Dalmatian coast, where the cities retained their Romance population and their Christian faith. From the 7th century the Croats were nominally Christian, and subject to the archbishops of Salona at Spalato and their suffragans. From the beginning of the 9th century Merseburg, Salzburg and Passau were the centres for spreading the Gospel among the Slavonic tribes on the south-eastern marches of the Frankish empire, in Bohemia, Moravia, Pannonia and Carinthia. Though we need not doubt the true zeal of these missionaries, it was still a fact that as Germans they belonged to a nation which was once more encroaching upon the Slavs, and as Latins (though the Great Schism had not yet taken place) they were not favourable to the use of their converts' native language. Still they were probably the first to reduce the Slavonic tongues to writing, naturally using Latin letters and lacking the skill to adapt them satisfactorily. Traces of such attempts are rare; the best are the Freisingen fragments of Old Slovene now at Munich.

In the eastern half of the Balkan Peninsula the Slavs had already begun to turn to Christianity before their conquest by the Bulgars. These latter were hostile until Boris, under the influence of his sister and of one Methodius (certainly not the famous one), adopted the new faith and put to the sword those that resisted conversion (A.D. 865). Though his Christianity came from Byzantium, Boris seems to have feared the influence of the Greek clergy and applied to the Pope for teachers, submitting to him a whole series of questions. The Pope sent clergy, but would not grant the Bulgarians as much independence as they asked, and Boris seems to have repented of his application to him. He raised the question at the Council of Constantinople (A.D. 870), which decided that Bulgaria was subject to the Eastern Church.

Cyril and Methodius.—In the same way Rostislav, prince of Greater Moravia, fearing the influence of Latin missionaries, applied to Byzantium for teachers who should preach in the vulgar tongue (A.D. 861). The emperor chose two brothers, sons of a Thessalonian Greek, Methodius and Constantine (generally known as Cyril by the name he adopted upon becoming a monk). The former was an organizer, the latter a scholar, a philosopher and a linguist. His gifts had been already exercised in a mission to the Crimea; he had brought thence the relics of S. Clement, which he finally laid in their resting-place in Rome. But the main reason for the choice was that the Thessalonians, surrounded as they were by Slavonic tribes, were well known to speak Slavonic perfectly. On their arrival in Moravia the brothers began to teach letters and the Gospel, and also to translate the necessary liturgical books and instruct the young in them. But soon (in 864) Rostislav was attacked by Louis the German and reduced to complete obedience, so that there could be no question of setting up a hierarchy in opposition to the dominant Franks, and the attempts to establish the Slavonic liturgy were strongly opposed. Hearing of the brother's work Pope Nicholas I. sent for them to Rome. On their way they spent some time with Kocel, a Slavonic prince of Pannonia, about Platten See, and he much favoured the Slavonic books. In Venice the brothers had disputes as to the use of Slavonic service-books; perhaps at this time these found their way to Croatia and Dalmatia. On their arrival in Rome Nicholas was dead, but Adrian II. was favourable to them and their translations, and had the pupils they brought with them ordained. In Rome Constantine fell ill, took monastic vows and the name of Cyril, and died on the 14th of February 869. Methodius was consecrated archbishop of Pannonia and Moravia, about 870, but Kocel could not help him much, and the German bishops had him tried and thrown into prison; also in that very year Rostislav was dethroned by Svatopluk, who, though he threw off the Frankish yoke, was not steadfast in supporting the Slavonic liturgy. In 873 Pope John VIII. commanded the liberation of Methodius and allowed Slavonic services, and for the next few years the work of Methodius went well. In 879 he was again called to

Rome, and in 880 the Pope distinctly pronounced in his favour and restored him to his archbishopric, but made a German, Wiching, his suffragan. Methodius died in 885, and Wiching, having a new pope, Stephen V. (VI.), on his side, became his successor. So the Slavonic service-books and those that used them were driven out by Svatopluk and took refuge in Bulgaria, where the ground had been made ready for them. Boris, having decided to abide by the Greek Church, welcomed Clement, Gorazd and other disciples of Methodius. Clement, who was the most active in literary work, laboured in Ochrida and others in various parts of the kingdom.

In spite of the triumph of the Latino-German party, the Slavonic liturgy was not quite stamped out in the west; it seems to have survived in out-of-the-way corners of Great Moravia until that principality was destroyed by the Magyars. Also during the life of Methodius it appears to have penetrated into Bohemia, Poland and Croatia, but all these countries finally accepted the Latin Church, and so were permanently cut off from the Orthodox Servians, Bulgarians and Russians.

These details of ecclesiastical history are of great importance for understanding the fate of various Slavonic languages, scripts and even literatures. From what has been said above it appears that Cyril invented a Slavonic alphabet, translated at any rate a Gospel lectionary, perhaps the Psalter and the chief service-books, into a Slavonic dialect, and it seems that Methodius translated the Epistles, some part of the Old Testament, a manual of canon law and further liturgical matter. Clement continued the task and turned many works of the Fathers into Slavonic, and is said to have made clearer the forms of letters. What was the alphabet which Cyril invented, where were the invention and the earliest translations made by him, and who were the speakers of the dialect he used, the language we call Old Church Slavonic (O.S.)? As to the alphabet we have the further testimony of Chrabr, a Bulgarian monk of the next generation, who says that the Slavs at first practised divination by means of marks and cuts upon wood; then after their baptism they were compelled to write the Slavonic tongue with Greek and Latin letters without proper rules; finally, by God's mercy Constantine the Philosopher, called Cyril, made them an alphabet of 38 letters. He gives the date as 855, six or seven years before the request of Rostislav. If we take this to be exact Cyril must have been working at his translations before ever he went to Moravia, and the language was presumably that with which he had been familiar at Thessalonica—that of southern Macedonia, and this is on the whole the most satisfactory view.

At any rate the phonetic framework of the language is more near to certain Bulgarian dialects than to any other, but the vocabulary seems to have been modified in Moravia by the inclusion of certain German and Latin words, especially those touching things of the Church. These would appear to have been already familiar to the Moravians through the work of the German missionaries. Some of them were superseded when O.S. became the language of Orthodox Slavs. Kopitar and Miklosich maintained that O.S. was Old Slovene as spoken by the subjects of Kocel, but in their decision much was due to racial patriotism. Something indeed was done to adapt the language of the Translations to the native Moravian; we have the Kiev fragments, prayers after the Roman use in which occur Moravisms, notably *c* and *z* where O.S. has *št* and *zd*, and fragments at Prague with Eastern ritual but Čech peculiarities. Further, the Freisingen fragments, though their language is in the main Old Slovene and their alphabet Latin, have some connexion with the texts of an O.S. Euchologium from Sinai.

Alphabets.—Slavonic languages are written in three alphabets according to religious dependence; Latin adapted to express Slavonic sounds either by diacritical marks or else by conventional combinations of letters among those who had Latin services; so-called Cyrillic, which is the Greek Liturgical Uncial of the 9th century enriched with special signs for Slavonic letters—this is used by all Orthodox Slavs; and Glagolitic, in the "spectacled" form of which certain very early O.S. documents were written, and which in another, the "square," form has survived

O.S. Old
Bulgarian.

as a liturgical script in Dalmatia, where the Roman Church still allows the Slavonic liturgy in the dioceses of Veglia, Spalato, Zara and Sebenico, and in Montenegro; the Croats now employ Latin letters for civil purposes.

The annexed table gives these alphabets—the Glagolitic in both forms with numerical values (columns 1-3); the Cyrillic in its fullest development (4, 5), with the modern version of it made for Russian (6) by Peter the Great's orders; Bulgarian uses more or less all the Russian letters but the reversed *e* and the last two, while keeping more old Cyrillic letters, but its orthography is in such a confused state that it is difficult to say which letters may be regarded as obsolete; Servian (7) was reformed by Karadžić (Karajich (*q.v.*)) on the model of Russian, with special letters and ligatures added and with unnecessary signs omitted. The old ways of writing Slavonic with Latin letters were so confused and variable that none of them are given. The Čechs first attained to a satisfactory system, using diacritical marks invented by Hus; their alphabet has served more or less as a model for all the other Slavonic languages which use Latin letters, and for that used in scientific grammars, not only of Slavonic but of Oriental languages. Column 8 gives the system as applied to Croat, and corresponding exactly to Karadžić's reformed Cyrillic. Column 9 gives the Čech alphabet with the exception of the long vowels, which are marked by an accent; in brackets are added further signs used in other Slavonic languages, *e.g.* Slovene and Sorb, or in strict transliterations of Cyrillic. Polish (10) still offers a compromise between the old arbitrary combinations of letters and the Čech principle of diacritical marks. The last column shows a convenient system of transliterating Cyrillic into Latin letters for the use of English readers without the use of diacritical marks; it is used in most of the non-linguistic articles in the *Encyclopaedia Britannica* which deal with Slavs. With regard to Glagolitic (derived from *Glagol*, a word) and Cyrillic, it is clear that they are closely connected. The language of the earliest Glagolitic MSS. is earlier than that of the Cyrillic, though the earliest dated Slavonic writing surviving is a Cyrillic inscription of Tsar Samuel of Bulgaria (A.D. 993). On the whole Glagolitic is likely to be the earlier, if only that no one would have made it who knew the simpler Cyrillic. It certainly bears the impress of a definite mind, which thought out very exactly the phonetics of the dialect it was to express, but made its letters too uniformly complicated by a love for little circles. A sufficiently large number of the letters can be traced back to Greek minuscules to make it probable that all of them derive thence, though agreement has not yet been reached as to the particular combinations which were modified to make each letter. Of course the modern Greek phonetic values alone form the basis. The numerical values were set out according to the order of the letters. Some subsequent improvement, especially in the pre-iotized vowels, can be traced in later documents. The presumption is that this is the alphabet invented by Cyril for the Slavs who formerly used Greek and Latin letters without system.

When brought or brought back to Bulgaria by Clement and the other pupils of Methodius, Glagolitic took root in the west, but in the east some one, probably at the court of Simeon, where everything Greek was in favour, had the idea of taking the arrangement of the Glagolitic alphabet, but making the signs like those of the Uncial Greek then in use for liturgical books, using actual Greek letters as far as they would serve, and for specifically Slavonic sounds the Glagolitic signs simplified and made to match the rest. Where this was impossible in the case of the complicated signs for the vowels, he seems to have made variations on the letters A and B. With the uncials he took the Greek numerical values, though his alphabet kept the Glagolitic order. Probably the Glagolitic letters for *š* and *š'* have exchanged places, and the value 800 belonged to *š*, as the order in Cyrillic is *ш, ѡ, ш, ѡ*. Who invented Cyrillic we know not; Clement has been said to have made letters clearer, but only in a secondary source and he seems to have been particularly devoted to the tradition of Methodius, and he was bishop of Ochrida, just where Glagolitic survived longest.

GLAGOLITIC			CYRILLIC			LATIN				PHONETIC VALUES
Old 1	New 2	Num. 3	Old 4	Num. 5	Russ. 6	Serb. 7	Croat 8	Čech 9	Polish 10	VALUES 11
Ɀ	Ɀ	1	А	А	Аа	Аа	а	а	а	а
ⱸ	ⱸ	2	Б	Б	Бб	Бб	б	б	б	б
ⱹ	ⱹ	3	В	В	Вв	Вв	в	в	в	в
ⱺ	ⱺ	4	Г	Г	Гг	Гг	г	г	г	г
ⱻ	ⱻ	5	Д	Д	Дд	Дд	д	д	д	д
ⱼ	ⱼ	6	Е	Е	Ее	Ее	е	е	е	е
ⱽ	ⱽ	7	Ж	Ж	Жж	Жж	ž	ž	ž	zh-Frj
Ȿ	Ȿ	8	С	С			(dz) dz	hard dz		dz
Ɀ	Ɀ	9	З	З			z	z	z	z
Ɀ	Ɀ	10	И	И	Ии	Ии	і	і	і	і
Ɀ	Ɀ	20	І	І	Іі	Іі	і	і	і	і
Ɀ	Ɀ	30	Ї	Ї	Її	Її	ij	ij	ij	y consonantal
Ɀ	Ɀ	40	К	К	Кк	Кк	к	к	к	к
Ɀ	Ɀ	50	Л	Л	Лл	Лл	l	l	l	l
Ɀ	Ɀ	60	М	М	Мм	Мм	m	m	m	m
Ɀ	Ɀ	70	Н	Н	Нн	Нн	n	n	n	n
Ɀ	Ɀ	80	О	О	Оо	Оо	o	o	o	o
Ɀ	Ɀ	90	П	П	Пп	Пп	p	p	p	p
Ɀ	Ɀ	100	Р	Р	Рр	Рр	r	r	r	r
Ɀ	Ɀ	200	С	С	Сс	Сс	s	s	s	s
Ɀ	Ɀ	300	Т	Т	Тт	Тт	t	t	t	t
Ɀ	Ɀ	400	У	У	Уу	Уу	u	u	u	u
Ɀ	Ɀ	500	Ф	Ф	Фф	Фф	f	f	f	f
Ɀ	Ɀ	600	Х	Х	Хх	Хх	h	ch	ch	kh - Germ. ch h or gh
Ɀ	Ɀ	700	Ш	Ш			o			Gr. ω
Ɀ	Ɀ	800	Щ	Щ	Щщ	Щщ	št	št	št	sht šch in Ashchurch
Ɀ	Ɀ	900	Ц	Ц	Цц	Цц	c	c	c	ts
Ɀ	Ɀ	1000	Ч	Ч	Чч	Чч	č	č	č	between c & z, ting Eng. j creature!
Ɀ	Ɀ		Ш	Ш	Шш	Шш	š	š	sz	Ch in church
Ɀ	Ɀ		Ъ	Ъ			(u)			ū in but mute
Ɀ	Ɀ		Ы	Ы	Ыы	Ыы	(i)			y between i & u cf. Eng. rhythm
Ɀ	Ɀ		Ь	Ь			(i)			i mute, softens preceding conson.
Ɀ	Ɀ		Ѧ	Ѧ	ѦѦ	ѦѦ	je	je	je	ye in Fr. fin ya
Ɀ	Ɀ		Ѩ	Ѩ	ѨѨ	ѨѨ	ju	ju	ju	on in Fr. son
Ɀ	Ɀ		Ѫ	Ѫ	ѪѪ	ѪѪ	ja	ja	ja	ien in Fr. sien
Ɀ	Ɀ		Ѭ	Ѭ	ѬѬ	ѬѬ	ja	ja	ja	ion in Fr. action
Ɀ	Ɀ		Ѯ	Ѯ	ѮѮ	ѮѮ	je	je	je	yū X Gr. t
Ɀ	Ɀ		Ѱ	Ѱ	ѰѰ	ѰѰ	ps	ps	ps	ps Gr. ψ
Ɀ	Ɀ		Ѳ	Ѳ	ѲѲ	ѲѲ				Gr. θ but pron. f
Ɀ	Ɀ		Ѵ	Ѵ	ѴѴ	ѴѴ				Gr. υ and so pron. i or v

Mention must be made of Brückner's theory that Cyril invented Cyrillic first, but degraded it into Glagolitic to hide its Greek origin from the Latin clergy, the whole object of his mission

being hostility to Rome, whereas in Orthodox countries this caution was soon seen to be unnecessary. The Glagolitic alphabets in the table are copied from Codex Marianus (11th century) and the Reims gospel, an O.S. MS. of the 14th century, on which the kings of France took their coronation oath.

As to the special sounds which these various scripts expressed, we may notice in the vocalism a tendency to broaden the short vowels and to narrow the long ones, a process which has left results even where distinctions of quantity no longer exist; further, the many changes which can be followed in historic time and are due to the destruction of the old rule of open syllables by the disappearance of the half vowels *ǐ* and *ǔ*, or to their developing into full vowels where indispensable for pronunciation (No. I. *inf.*). But the ruling principle which has determined the physiognomy of Slavonic speech is the degree in which consonants have been affected by the following vowel. Where this has been broad *a*, *o*, *u*, *y*, *g*, *ǔ*, this has resulted only in an occasional labialization most noticeable in the case of *l*; where it has been narrow, *i*, *e*, *ě*, (once *ea* or *ē*), *ɛ*, *ɣ*, and *ǐ*, the result has been palatalization or "softening" in various degrees, ranging from a slight change in the position of the tongue producing a faint *j* sound in or just after the consonant—expressed in column 9 by the sign *ʹ*, and in Cyrillic by the pre-iotizing of the following vowel—to the development out of straightforward mutes and sibilants of the sibilants, palato-sibilants and affricates *z*, *s*, *ž*, *š*, *ř*, *dz*, *c*, *dž*, *č*, *šč*, &c. (see No. 9 and V. *inf.*).

Slavonic Languages.—The Slavonic languages belong to the Indo-European (I.E.) family. Within that family they are very closely connected with the Baltic group, Old Prussian, Lithuanian (Lithu.) and Lettish, and we must regard the linguistic ancestors of both groups as having formed one for some time after they had become separated from their neighbours. If the original home of the I.E. family is to be set in Europe, we may take the Balto-Slavs to have represented the north-eastern extension of it. The Balto-Slavs have much in common with the northerly or German group, and with the easterly or Aryan group, their next neighbours on each side. The Aryans likewise split into two divisions, Iranian and Indian, whereof the former, in the Sarmatians, remained in contact with the Slavs until after the Christian era, and gave them some loan words, e.g. *Bogǔ*—Pers. *Baga* (god); Russian, *Sobaka*; Median, *Čpaka* (dog). The south-eastern or Thracian group (Armenian) and beyond it the Illyrian (Albanian) made up the four groups which have sibilants for I.E. non-velar gutturals (see *inf.* No. 9), and in this stand apart from most European groups, but in other respects the Balto-Slavs were quite European.

The Baltic group and the Slavs were separated by the marshes of White Russia, and after their early oneness did not have much communication until the Slavs began to spread. Since then the Baltic languages have borrowed many Slavonic words. After the Aryans had moved eastwards Slavonic was left in contact with Thracian, but we know so little about it that we cannot measure their mutual influence. On the other side the Germans, beginning as the next group to the Balto-Slavs, and having thereby much in common with them (so much so that Schleicher wanted to make a Germano-Slavo-Baltic group), have never ceased to influence them, have given them loan words at every stage and have received a few in return.

After the Baltic group had separated from the Slavonic, we must imagine a long period when Slavonic (Sl.) was a bundle of dialects, showing some of the peculiarities of the future languages, but on the whole so much alike that we may say that such and such forms were common to them all. This stage may be called Proto-Slavonic. Except for the few cases where Old Church Slavonic (O.S.) has either definitely South Slavonic characteristics or peculiar characteristics of its own, as written down by Cyril it represents with wonderful completeness Proto-Slavonic at the moment of its falling apart, and words cited below may be taken to be O.S. unless otherwise designated. Some of the main characteristics of the Slavonic languages as a whole in relation to I.E. are indicated below; restrictions and secondary factors are necessarily omitted. As a rule O.S.

represents the Slavonic languages fairly well, while Latin or Greek equivalents are given as the most familiar examples of I.E. Hypothetical forms are starred.

1. I.E. *ī* becomes (>) *i*, *gosti*: *hostis* (acc. pl.); I.E. *ǵ* > *ž*, *vidova*: *vidua*; I.E. *j* > *j*, *jucha*: *jus* (broth).

2. I.E. *ē* becomes *ě*, *sěme*: *sēmen*; I.E. *ǵ* > *ě* *bera*: *fero*.

3. I.E. *ǝ* and *ǔ* are alike *o* in Sl., *orati*: *arare*; *osmǝ*: *octo*; I.E. *ǝ* in end syllables, > *ǔ*; *vozǔ*: *ὄχος*; I.E. *ā* and *ō* are alike *a*, *bratrǔ*: *frater*; *dǔva*: *duo*.

4. I.E. *ū* becomes *y*, *ty*: *tu*; I.E. *ǔ* > *ǔ*, *snǔcha*: *nurus*, Sanskr. *snušā*: I.E. *u* > *v*, *vezǔ*: *veho*.

5. I.E. *ř* and *l* both long and short survived as vowels, **vřkǔ* written *vřkǔ*, Sanskr. *vřkas*, "wolf"; consonantal *r* and *l* survived unchanged.

6. I.E. *ŋ* and *ŋ* both long and short: the former gave *ř* or *ǔ*; *sǔto*: *centum*; the latter *ɛ* or *a*, *desęłł*: *decem*. Consonantal *m* and *n* mostly survived before a vowel, after it they coalesced with it to make the nasal vowels *a* and *ɛ*; *pǔti*: *pontis*; *pętǔ*: *πέμπτος*.

7. I.E. Aspirates are represented by corresponding sonants, *berǔ*: *fero*; *medǔ* ("honey," "mead"): *μέθυ*; *mǔgla*: *ὄμιχλη*.

8. I.E. *s* often becomes *ch*; *vetǔchǔ*: *vetus*; not always, *synǔ*: Lithu. *sǔnǔs*, "son"; otherwise *ch* generally renders Gothic *h* in loan words; *chlębǔ*: *hlaihs*, "loaf"; *chyzǔ*: *hus*, "house."

9. I.E. velar gutturals *k*, *g*, *gh* and labio-velars, *q*, *g*, *gh* become in Sl. *k*, *g*, *g*, *klǔčǔ*: *clavis*; *aglǔ*: *angulus*; *mǔgla*: *ὄμιχλη*; *kǔto*: *quis*, *govedo*: *βοδός*, Sanskr. *gāuš*; *snęgǔ*: *nix*, *nivem*, but the Palato-gutturals *k*, *g*, *gh* become Sl. *s*, *z*, *z*; *desęłł*: *decem*; *zřǔno*: *granum*; *zǔma*: *hiems*; Lithu. *š*, *ž*, *ž*; *deszǔmtis*, *žřǔnis*, *žęma*.

10. (a) Gutturals *k*, *g*, *ch* (for *s*) before *e*, *ě* (for *ē*), *i*, *ɛ*, *ǐ* and *j* early in the Proto-Sl. period became *č*, *ž*, *š*, *vřčę*, voc. of *vřkǔ*: *λίκε*; *želǔdi*: *glandis*; *plǔšę*, 3rd pl. fr. *plǔchǔ*: *ἔπλευσαν*.

(b) Later *k*, *g*, *ch* before *ě*, *i* (for *oi* or *ai*), and sometimes after *ǔ*, *i*, *ɛ*, > *c*, *dz* (*z*), *s*. *Vřčę* loc. cf. *οἶκοι*; *lezi*, imperat. of *leǔa*, "lie": *λέγους*; *dusi*, *dusęchǔ*, nom. loc. pl. of *duchǔ*, "spirit"; *kǔnęžł*: Ger. *kuning*: "king."

(c) I.E. or Proto-Sl. *sj*, *zj* became *š*, *ž*, *šiti*, Lithu. *siuti*, Lat. *suo*, "sew"; *nožł* for **nozjo*, "knife."

(d) Non-guttural consonants followed by *j* (*tj*, *dj*, *nj*; *řj*, *bj*, *vj*, *mj*) gave different results (except *nj*) in different languages (see below No. V.), but in Proto-Sl. there was already a tendency for the *j* to melt into and so change the consonant.

11. Proto-Sl. gradually got rid of all its closed syllables, hence—

(a) Final consonants were dropped. *Domǔ*: *domus*.

(b) Diphthongs became simple vowels *ai*, *oi* > *ě*; *lęvǔ*: *laevus*; *vędę*: *oida*; *ei* > *i*; *vidǔ*: *eidos*; *au*, *eu*, *ou* > *u*; *ucho*: *auris*.

12. Proto-Slavonic had long, short and very short or half vowels (those expressed above by *ǐ* and *ǔ*). It had a musical accent, free in its position with different intonations when it fell upon long syllables. (For the fate of these in different modern languages see below, No. VIII.)

13. The phenomena of vowel gradation (*Ablaut*) as presented by Slavonic are too complicated to be put shortly. In the main they answer to the I.E., e.g. O.S. *brǔati*, *berǔa*, *sǔborǔ*: *δι-φρος*, *φέρω*, *φóρος*.

In their morphology the Sl. languages have preserved or developed many interesting forms. Nouns have three genders, three numbers in O.S., Slovene, Serbo-Croat and Sorb (other tongues have more or less numerous traces of the Dual), and, except Bulgarian, seven cases—Nom., Voc. (not in Gt. Russian or Slovene), Acc., Gen., Dat., Instrumental and Locative. The Abl. has coincided with the Genitive.

The *-o*, *-a* and *-i* declensions have gained at the expense of the consonantal stems, and phonetic change has caused many cases to coincide especially in the *-i* decl. The comparative of the Adj. is formed on I.E. models with *š* < *sj* corresponding to Latin *r* < *s*, *mǔnǔ*, gen. *mǔnǔša*, cf. *minus*, *minoris*. The pronominal declension is less well preserved. There is no article, but *i* (*ǝs*) has been added to the adj. to make it definite; also in Bulgarian and in some dialects of Russian *ǔ* is postfixed as a real article.

The Sl. verb has lost most of the I.E. voices, moods and tenses.

The passive only survives in the pres. and past participles; of the finite moods there are but the ind. and opt. (almost always used as an imperat.) left; its only old tenses are the pres. and the aor., to which it has added an impf. of its own. There is an inf. (in *-ti*, being an old dat.) and a supine in *-tū*, an accusative. Of active participles there are a pres. and a past and a second past part. used in making compound tenses. There are a solitary perfect form, *vědě: oīda*, and a solitary fut. part. *byšę*, gen. *byšęšta: fúšow, fúšowros*. The verb has two stems; from the pres. stem is formed the ind. pres. and impf., the imperat. and the act. and pass. pres. participles. All other forms are based upon the infinitive stem.

Personal Endings:—

		PRIMARY.						SECONDARY.				
Non-Thematic.			Thematic.									
	Sing.	Du.	Plur.	Sing.	Du.	Plur.	Sing.	Du.	Plur.	Sing.	Du.	Plur.
1.	<i>-mŭ</i>	<i>-vĕ</i>	<i>-mŭ</i>	<i>-(m)</i>	<i>-vĕ</i>	<i>-mŭ</i>	<i>-(m)</i>	<i>-vĕ</i>	<i>-mŭ</i>	<i>-(s)</i>	<i>-ta</i>	<i>-te</i>
2.	<i>-si</i>	<i>-ta</i>	<i>-te</i>	<i>-ši</i>	<i>-ta</i>	<i>-te</i>	<i>-(s)</i>	<i>-ta</i>	<i>-te</i>			
3.	<i>-tŭ</i>	<i>-te</i>	<i>-ętŭ</i>	<i>-tŭ</i>	<i>-te</i>	<i>-(n)tŭ</i>	<i>-(t)</i>	<i>-te</i>	<i>-(nt)</i>			

1st Sing. In thematic verbs the vowel + *m* has given *ę*, but there has been a tendency to replace it according to the non-thematic analogy, which has necessitated changes in 1st plur.

2nd Sing. *-ši* has given *-šŭ* everywhere but in O.S.

3rd Sing. *-tŭ* has been dropped everywhere but in Russian, where the literary language has *tŭ*. The Dual only survives in Serb, Sorb, Slovene and O.S., and in these the forms are confused.

1st plur. *-mŭ* has developed a full vowel where the 1st sing. has replaced the *-m*.

The secondary endings have lost their *-m*, *-s*, *-t* and *-nt* by phonetic change.

Non-thematic presents are, *jesmŭ, eŭm, sum; damŭ* (redupl. for **dadmŭ*), *didwum; jamŭ, edo; vĕmŭ*, Sanskr. *vedmi*, "I wit"; *imamŭ* (new form of *emo*), "I have."

The aorist has no augment; it is sigmatic and non-sigmatic. The latter or 2nd aor. (cf. Hom. impf. *φέρων, φέρε*) survived only in consonant stems and that in O.S. and Old Čech, *pekŭ = ęπεσσων*. It was common in the 2nd and 3rd sing. (where the *-s* forms would not be clear) *peĕe < *peke-s, *peke-t = ęπεσσε, ęπεσσε*. The sigmatic aorist very rarely and only in consonant stems in O.S. keeps its *-s*, *vĕsŭ < *vedsŭ*. In stems ending in *k, r* or a vowel, *s > ch; bychŭ = ęφῶσα* and this *ch > š* before *ę*. The ordinary later form for consonant stems inserts a vowel, *vedochŭ*. The aorist has survived in S. Slavonic and in Sorb, and is found in the older stages of the other tongues. The same languages (except Slovene) have kept the impf. which was present in Proto-Sl. but does not go back to I.E., being formed on the analogy of the aor. With the aor. has coalesced the opt. *bimŭ*, "be," used with the 2nd past part. to make a conditional. Stem of pres. part. act. ends in *-nt* but the consonant decl. has become an *-ŭo* decl., so we have *vezŭ < I.E. *weĝhonts = ęχων*, gen. *vezęšta < *vezontŭja* as against *ęχωνros*. Pres. part. pass. ends in *-mŭ*; it has survived more or less in Russian, elsewhere is obsolescent. Past part. act. I. is formed with I.E. *-ues-*; nom. sing. masc. *-uōs (eīdōs)* gave *ŭ, vedŭ*, having led, *byvŭ*, having been; but in fem. and oblique cases formed as from *-ŭo-* stem *s* remained, hence Russian *vedšŭj, byvšŭj*. Past part. act. II. in *-l-* cf. Lat. *bibulus* from *bibo*, used with an auxiliary to form past and conditional. Past part. pass. in *-l-* or *-n-*; *tertŭ = tritus*. *Znamŭ = known*. I.E. future having been lost, futurity is expressed by an auxiliary *będq (ero) choštę* (will), &c. with the inf. or by the pres. form of the perfective verb. The passive is expressed either by the use of the passive participles or by the reflexive *ęę*, which can refer to the 1st and 2nd persons as well as to the 3rd.

Syntactical peculiarities of the Slavonic languages that may be noted are a tendency to use the genitive instead of the accusative (which has often coincided in form with the nominative) in the case of living beings, masculine *-o-* stems, and in the plur.; the use of the genitive for the accusative or even nominative in negative clauses; the dative absolute and the dative as subject to an infinitive; the instrumental instead of the nominative as

a predicate, and in *oratio obliqua* the preservation of the tense of the original statement instead of our way of throwing it into the past.

In the use of the verbs the development of "aspects" makes up for the few tenses. Actions (or states) expressed by a verbal form have a beginning, a continuance and an end. There are, however, some (momentaneous) actions whose beginning and end come together and allow no continuance. All verbs fall into two great divisions, *imperfective*, which express the continuance of an action, without regard to its beginning or end, and *perfective*, which express the points of beginning or ending. The continuance of an action may be unbroken or may consist of like acts which are repeated. So imperfective verbs are divided into *durative*, as *nesŭ*, "to be carrying," and *iterative*, as *nosŭ*, "to be wont to carry"; the repeated acts of the iterative can either be each of them momentaneous, e.g. Čech, *střŭleti*, "to shoot," i.e. "be firing single shots," or each have some continuance, e.g. *nosŭ* above, or we can even express the occasional repetition of groups of momentaneous actions, e.g. Čech. *střŭlŭvati*, "to have the habit of going out shooting."

Among perfective verbs we have (1) *momentaneous*, expressing action which has no continuance, *kriknŭti*, "to give a cry," *sĕsti*, "to take a seat"; (2) *finitive*, expressing not the continuance of the action, though that there has been, but its end or completion, *naplŭnŭti*, "to fill to the brim"; (3) *ingressive*, expressing the moment of beginning an action, *vŭdŭ ubŭti*, "to fall in love with."

As perfective verbs do not express continuance, an idea implied in the present, they cannot require a present form, so this is used for perfective futures; e.g. *ędq* (pres. form from perfective *sĕsti*) = "I shall take a seat," as opposed to imperfective *będq sidĕti*, "I shall be sitting." If a preposition is compounded with a durative verb as *nesŭ*, "to carry" (in general), "to be carrying," it makes it perfective, as *iznesŭ*, "to carry out" (one single action brought to a conclusion), so Eng. "sit" is usually imperfective, "sit down" perfective. If an iterative has a preposition it is mostly used as a durative; *iznosŭ* can mean "habitually to carry out" but more often = "to be carrying out," that is, it supplies the imperfective form to *iznesŭ*. The development of this system has enabled some Slavonic languages, e.g. Russian, to do with only two tenses, pres. and past, to each verb morphologically considered, perfective and imperfective verbs supplementing each other; e.g. if we take a Greek verb, the pres. (ind. and inf.) and imperf. correspond to the present, inf. and past of a Russian imperfective verb; the aor. indic. and inf. are represented by the perfective past and inf., which has also to do duty for the Greek perfect and plup.; the future and the future perfect in Greek do not express the same distinctions as the imperfective future and perfective future (in form a present) in Sl., the Greek giving chronological order of action, but not giving the distinction of aspect, though the future perfect is naturally perfective.

The prepositions are very much like those in other I.E. languages both in actual forms and in use.

The formation of the sentence is not naturally complicated; but Sl. has in times past been largely influenced by Greek, Latin and German with their involved periods; latterly there has been a tendency to follow the simpler models of French and English.

Such being the Slavonic languages as a whole and regarded in their relationship to I.E., they may now be considered in their relationship to each other, and some of the principal characteristics enumerated upon which their internal classification has been founded. More or less complete accounts of each language will be found under its name.

*Distinctive Points of Different Sl. Languages.*¹—I. (*ŭ, ŭ*). The fate of the Proto-Sl. half vowels *ŭ, ŭ*, still preserved in O.S., e.g. *sŭmŭ*, "sleep," *dŭnŭ*, "day," is various; as a rule they disappear, *ŭ* entirely (though when final still written in R.), *ŭ* leaves a trace by softening the preceding consonant. But if needed to eke out

¹ Bulg. = Bulgarian; Č. = Čech; Kaš. = Kašube; Lit. R. = Little Russian; P. = Polish; R. = Russian, i.e. Great Russian; Ser. = Servian; Wh. R. = White Russian.

consonants, in Sorb, Slovak, Lit. R. and mostly in Gt. R., ů, ž develop into full vowels o, e—R. *sonŭ*, gen. *sna*; *d'enŭ*, gen. *dn'a*. In Polish and Čech both > e, but in P. ž softens the preceding cons., in Č. it usually does not—P. *sen*, *dzień*; Č. *sen*, *den*; in Slovene and Ser. they are not distinguished, Slovene ů, a or e, *san*, *dan* or *den*=Ser. a, *san*, *dan*, gen. *dana*, Ser. keeping the middle vowel which is elsewhere dropped. Bulgarian varies dialectically.

II. (y.) y only remains in Gt. Russian, Polish and Sorb though still written in Čech; it has elsewhere become i, but in Polish it becomes i after k and g, in Sorb and R. after k, g, ch—O.S. *kysnati*, "go sour," *gybnati*, "perish," *chytrŭ*, "cunning"; P. *kisnac*, *ginac*, *chyter*; R. *kisnutŭ*, *gibnutŭ*, *chit'erŭ*.

III. (r, l.) The treatment of the liquids varies greatly.

(a) r is always a lingual trill, never alveolar. In S. Slav. it is only softened before j and ž—O.S. *zorja*, "dawn." In N.W. and E. Slav. r became r' before ž, i, e, ě, ě and j. Russian and Slovak have remained at this stage, Č., Polish, Kaš. have made ř into ř (rz) in which r and ž are run into one. (See Table I.) But

Č. *srdce*, *trh*, *vlk*, *sluce*; P. *serce*, *targ*, *wilk*, *stońce*; R. *s'erdce*, *torgŭ*, *volkŭ*, *solnce*.

(e) Proto-Sl. ř, ř, ľ, ľ had in S. Slav. and partly in Č. the same fate as ř, ľ; in Polish and R. the vowel comes after the liquid. O.S. *brŭvŭ*, "brow," *krŭstŭ*, "cross," *plŭttŭ*, "flesh," *slza*, "tear"; Ser. *brv*, *krst*, *put*, *suza*; Slovene, *brv*, *krst*, *polť*, *solza*; Č. *brv*, but *plet'*; P. *brew*, *krzest*, *pieć*, (s) *lza*; R. *brovŭ*, *kr'estŭ*, *plotŭ*, *sl'ez*a.

(f) Proto-Sl. -or-, -ol-, -er-, -el- before a consonant.

(i.) Type *ort*, *olt* (*ert*, *elt* are not certain) beginning a word.—The liquid mostly comes first, sometimes the same vowel persists in all languages, e.g. Proto-Sl. **ordlo* (Lithu. *arklas*, *ararum*), O.S., Bulg., Ser., Slovene, R. *ralo*, Č. Polab. P., *radlo*. But Proto-Sl. **eldii* (Lithu. *eldija*), O.S. *alŭdiji*, *ladiji*, "boat," Ser., Slovene, *ladja*, R. *lodŭja*, Č. *lodi*, Polab. *lud'a* and **orvn* (Pruss. *arwis*), O.S. *ravŭnŭ*, "even," Ser. *ravan*, Bulg. Slovene, *raven*, R. *rov'enŭ*, Č. *rovny*, P. *równy* show Russian agreeing with N.W. Slav against S. Slav. The difference probably depends on intonation.

(ii.) Type *tort*, *tolt*, *tert*, *telt* with a consonant before as well:

TABLE I.

	ř	i	e	· ě	ě	j
O.S. . . .	<i>zvĕrŭ</i> , "beast"	<i>vĕriti</i> , "believe"	<i>remĕnŭ</i> , "strap"	<i>trĕsa trĕseši</i> , "tremo"	<i>rĕka</i> , "river"	<i>zorja</i> , "dawn"
Russian . . .	<i>zvĕrŭ</i>	<i>vĕr'itŭ</i>	<i>r'em'enŭ</i>	<i>tr'asu tr'as'ošŭ</i>	<i>r'ĕka</i>	<i>zor'a</i>
Polish . . .	<i>zwierz</i>	<i>wierzyć</i>	<i>rzemień</i>	<i>trząsę trzęsiesz</i>	<i>rzeka</i>	<i>zorza</i>

P. ě for orig. q does not soften—P. *rĕka*: O.S. *raka*, "hand."

In Sorb such a change only happened after k, p, t, in which case High S. has ř (written ř), Low S. ř, but in Low S., r after k, p, t becomes ř even before hard vowels: Proto-Sl. *tri*, "three," High S. *tři*, Low S. *tři*; Proto-Sl. *kraj*, "edge," High S. *kraj*, Low S. *křaj*.

(b) l occurs in three varieties, l, l', l'', but each language has generally either middle l alone or else l and l'. Lit. R. and Bulg. have all three. l has been arrived at in Č. and Slovene by the loss of the distinctions, perhaps under German influence; Ser. has l and l', final l > o; but l occurs in dialects of all languages and was no doubt in O.S., Proto-Sl. and even Balto-Slav. It has a velar and a labial element and in most languages tends

to appear as o, u, v or w, though this is only written in Ser. and Lit. R. O.S. *dalŭ*, "gave," R. *dalŭ*, Lit. R. *dav*, Wh. R. *dav*, *daw*, P. *dat* (dialect *day*), Č. *dal*, Ser. *dao*. l' is very soft, like Fr. *ville*.

(c) N.W. Slav. keeps -l- -dl- whereas S. Slav. (except some cases of Slovene *padl*, *pletla*, &c.) and R. drop the t and d—Č. *padl*, "fell," *radlo*, "ararum," *pletl*, "plaited"; O.S. and R. *palŭ*, *ralo*, *pletŭ*, but R. drops l of masc. sing. past part. II. after other consonants. O.S. *neslŭ*, Č. *nesl*, R. *n'esŭ*, "carried."

(d) Proto-Sl. ř, ľ or perhaps řr, řľ, řľ, řľ gave S. Slav., Č. and Slovak ř, ř written in O.S. *rŭ*, *rĕ*, *lŭ*, *lĕ* indifferently, though soft

the various treatments of this combination are among the chief criteria for classification, esp. the Russian speciality called full vocalism (*polnoglasie*) *torot*, *tolot*, *teret*, *telet* (or *tolot*, *telot*) which is probably archaic, is one of the chief reasons for putting Russian in a separate division; Polish and Sorb come nearest to it, with *trot*, *tlot*, *tret*, *tlet*, but the N.W. division is not uniform as Kašube and the extinct Polab have the interesting forms *tort*, *tlat*, *trit*, *tlat*, which are partly archaic, partly a transition to the most novel forms of the southern group to which Čech and Slovak in this particular accede, *trat*, *tlat*, *trĕt*, *tĕt*, but after ě and ž Čech has *tlat* for *tĕt*. Deviations due to intonation have not been set forth. (See Table II.)

TABLE II.

Proto-Sl. Stem.	R.	P.	Polab, Kaš.	Č.	S. Sl. e.g. O.S.
* <i>gord</i> —"hortus," "town"	<i>gorodŭ</i>	<i>gród</i>	<i>gord</i>	<i>hrad</i>	<i>gradŭ</i>
* <i>molt</i> —"hammer"	<i>molotŭ</i>	<i>młot</i>	<i>mlat</i>	<i>mlat</i>	<i>mlatŭ</i>
* <i>berg</i> -Ger. "berg," "shore"	<i>b'er'egŭ</i>	<i>brzeg</i>	<i>brig</i>	<i>břeh</i>	<i>brĕgŭ</i>
* <i>melk</i> —"milk"	<i>moloko</i>	<i>mleko</i>	<i>mlak</i> —	<i>mlĕko</i>	<i>mlĕko</i>
* <i>helm</i> —"helm"	<i>šel'emŭ</i> or <i>šelomŭ</i>				<i>šlĕmŭ</i>
* <i>gelb</i> —"groove"	<i>želobŭ</i>	<i>żłób</i>	(Kaš.) <i>žlob</i>	<i>žlab</i>	<i>žlĕbŭ</i>

IV. The Proto-Slavonic nasals q and ě could be either long or short. This distribution is fairly kept in languages which have quantity and governs the results in Polish in which the nasal sound is preserved. The examples below show the main representatives. Traces of nasal pronunciation survive in Bulgarian, Slovene and Kašube. (See Table III.)

TABLE III.

Proto-Sl. ǫn, ǫn; ęn, ęn.	O.S. q; ě.	Bulg. usu. ǫ, or ǫ; e.	Ser. u; e.	Slovene. ǫ, ǫ; e, ě.	Č. u, ou; e, ě.	Sorb, High, Low. u; a, je; e, ě.	R. u; ja.	P. e, a; ję, ję.	Kašube. q; i, ě.
* <i>mǫnka</i> , "pain"	<i>mąka</i>	<i>mŭka</i>	<i>mŭka</i>	<i>mǫka</i> , <i>monka</i>	<i>muka</i>	<i>muka</i>	<i>mŭka</i>	<i>męka</i>	<i>mąka</i>
* <i>mǫnká</i> , "flour"	<i>mąka</i>	<i>mŭnka</i>	<i>mŭka</i>	<i>mǫka</i> , <i>mŭka</i>	<i>mouka</i>	<i>muka</i>	<i>muká</i>	<i>mąka</i>	<i>mąka</i>
* <i>desęmŭl</i> , "ten"	<i>desętl</i>	<i>desętl</i>	<i>desętl</i>	<i>desętl</i>	<i>desętl</i>	<i>dęsač</i> , <i>ęasač</i>	<i>d'ęs'atŭ</i>	<i>dziesięć</i>	<i>dęsętl</i>
* <i>pęntŭ</i> , "five"	<i>pętl</i>	<i>pętl</i>	<i>pętl</i>	<i>pętl</i>	<i>pętl</i>	<i>pjęć</i> , <i>pęs</i>	<i>p'atŭ</i>	<i>pięć</i> > <i>pięć</i>	<i>pętl</i> or <i>pętlę</i>

and hard may once have been distinguished. Of this group Slovene and Ser. later allowed the ě to become ol, ou or u. Sorb, Polish and R. developed various vowels, partly according to the original quality, partly according to other influences, e.g. O.S. *srdŭce*, "heart," *trŭgŭ*, "market," *vlkŭ*, "wolf," *slŭnŭce*, "sol"; Ser. *srdce*, *trg*, *vuk*, *sunce*; Slovene *srdce*, *trg*, *volk*, *solnce*;

In Kašube q remains; ě becomes nasalized i or ě and this may lose the nasal or restore it as a full n or m; it has also nasalized all the other vowels and has the power of using nasals in loan-words, e.g. *testamęt*, as did O.S. e.g. *kolęda*, *kalendę*, *sędŭ*=*sund*. Polab has q and ě—*ronka*, O.S. *rąka*, "hand," *męngsę*=*męsa*, "carnis," but *swante*=*swętlŭ*, "holy."

V. Softening (Palatalization, &c.).—Nothing has so much affected Slavonic speech as the effect of *ʎ, i, e, ě, ě* and *j* on preceding consonants, and the variations produced are among the chief points of difference between the languages.

(a) The gutturals felt this first of all, *k, g, ch*, become (I.) *č, ž, š* and (II.) *c, dz(z), s*, and these changes are universal (see 10, *kv. gv.* *a, b* above) except that after the separation of the Slavs the same process was continued in the S. and E. branches even when a *v* intervened, whereas the N.W. branch remained untouched. Proto-Sl. **květŭ*, "flower," **gvězda*, "star" (*vŭlchvi*), *magi*; O.S. *cvětŭ, dzvėsda, (vlŭsvi)*; R. *cvětŭ, zvězda*; but Čech *květ, hvězda*; P. *kwiat, gwiazda*.

(b) The action of *j* was the most general, influencing the dentals in all languages and in some the labials as well, whereas the narrow vowels act on the dentals only and that not in all languages. The results of Proto-Sl. *tj, dj* in O.S. and Bulg. are the most surprising, giving *št', žd'*, by way of *šč* and *ždž* (as is shown by their agreeing with the results of Proto-Sl.

VII. Common Slav *je* and *ju* beginning a word appear in R. as *o* and *u*; O.S. *jedinŭ*, "one," *jucha*, "broth"; R. *odinŭ, ucha*.

VIII. Proto-Sl., as we have seen, had long, short and very short or half vowels and a musical accent with differing intonations. O.S. was probably similar, but we have no sufficient materials for determining its quantities or accents as systematic writing of the latter only came in from the 14th century. The fate of the half vowels we have seen (I.). Traces of former long vowels are very clearly to be seen in Sorb, Polish and Lit. R., and less clearly in Bulg. and Gt. R., all of which have lost distinctions of quantity; Slovene can have long vowels only under the accent. In Kašube, Č., Slovak and Serbo-Cr. there are also unaccented long syllables. Russian has kept the place of the original accent best, next to it Bulgarian; consequently it seems very capricious, appearing on different syllables in different flexions, but it has become merely expiratory. In Slovene it is still musical, but is, so to speak, steadier. For the

Accent and quantity.

Proto-Slav.	O.S.	Bulg.	Mac.	Serbo-Croat and Slovene.	Č.	P.	R.
* <i>světja</i> , "candle" . .	<i>svěšt'a</i>	<i>svěšta</i>	<i>svek'a</i>	<i>svijet'a svječa svěča</i>	<i>svíce</i>	<i>swieca</i>	<i>svěča</i>
* <i>medja</i> , "boundary" . .	<i>mežd'a</i>	<i>mežda</i>	<i>meg'a</i>	<i>med'a mežža meja</i>	<i>meze</i>	<i>miedza</i>	<i>m'eča</i>
* <i>pektj</i> , "stove" . . .	<i>peštj</i>	<i>peštj</i>		<i>peč peč peč</i>	<i>pec</i>	<i>piec</i>	<i>p'ečj</i>
* <i>mogtj</i> , "power" . . .	<i>moštj</i>	<i>moštj</i>		<i>moč moč moč</i>	<i>moc</i>	<i>moc</i>	<i>močj</i>

stj, skj, e.g. přelš't'enŭ, "deceived," *išt'q*, "I seek," cf. R. *liščenŭ, iščŭ*). Some Macedonians have the strange result *k'* and *g'*. Among the Serbo-Croats we find every grade between *l', d'*, and *c', dz'*, or *č, dž*, the Slovenes having *c', j* (our *y*), the Čechs and Sorbs *c, z*, the Poles and Polabs *c, dz*, and the Russians *č* and *ž*; the fate of *ktj* and *gtj* has been the same as that of *tj* throughout.

(c) Before the narrow sounds *ʎ, i, e, ě* and the descendants of *e* there has resulted a later softening which has gone farthest in Low Sorb, producing *š* and *ž*, and in High Sorb and Polish, *ś* and *ź*, not so far in Gt. R. where *l' d'* remain, Wh. R. is intermediate with now *č, dž*, now *l', d'*; in Č. even *l' d'* only come before *ʎ, i* and *ě*. In S. Slavonic this effect is dialectical. Č. *tělo*, "body," *dělati*, "make," *deset*, "ten"; P. *cielo, dzieło, dziesięć*; High Sorb, *dzesat'*; Low Sorb, *žases'*; Wh. R. *čelo, dzieło, dziesiąt'*; Gt. R. *l'ělo, d'ělo, d'es'atj*.

(d) *S, z, n*, before *j* gave *š, ž, n'* throughout (No. 10, *c, d*, above). Before the narrow vowels they give *š, ž, ŋ* in Sorb, Polish, Slovak and Russian, but Čech has no *š* or *ž* or *ŋ* before *e* nor always before *ʎ*; S. Slavonic has *n'* before *j*. Otherwise in it such softening is only dialectical, but Bulgarian forms a transition to Russian.

(e) In Polish and Sorb we have the labials *p', b' (f'), v', m'* softening before *j* and the narrow vowels, in Čech only before *ě*, in Slovak nowhere. In S. Slavonic they only soften before *j* and then the *j* appears as *l' (pl', bl', vl', ml')*, invariably in Serb, generally in Slovene, generally too in Russian, but there before the narrow sounds of newer formation they can all be softened in the ordinary way (*p', b', f', v', m'*), in Bulgarian this *l* has disappeared and we have *p', b', v', m'*. But O.S. followed the S. Slav. rule; and the *l* was probably once present in N.W. Slav. It remains everywhere in one or two roots—O.S. *pl'ujq* (*πρωω for σπρωω*), R. *pl'uju*, P. *pluje*, otherwise O.S. *zeml'a*, R. *z'eml'a*, P. *ziemia*, "humus."

On the whole the various languages do not differ much in principle in the treatment of *j*, but softening before *ʎ, i, e, ě, ě*, seems to have its extreme point in P., Kaš. and Polab, spreading from them to Sorb, White Russian and Gt. Russian; Čech, Slovak and Lit. Russian have it in a far less degree, and in S. Slavonic it is very little developed.

VI. Right across the Slavonic world from W. to E. *g* has become *h*, leaving the N. and the S. untouched. This change is found in Čech, Slovak, High but not Low Sorb, is traceable in Polish, and characteristic in White, South Gt. Russian and Lit. Russian, also in the Russian pronunciation of Ch. Slavonic. The *h* produced is rather the spirant *gh* than the true aspirate. Low Sorb, R., O.S., &c., *gora*, P. *góra*, "mountain." Č., Slovak, High Sorb, Wh. and Lit. R. *hora*.

g > h.

intonations Serbo-Croat is the chief guide, but here the accent intonation is spread over two syllables, in Croatian (*ča* dialect), the main stress is usually on the old place, in Servian (*što* dialect) it has shifted back one. In N.W. Slavonic, with the exception of Kašube, in which it is free, the accent is fixed, in Č., Slovak and Sorb on the first syllable of the word, in Polish on the penultimate.

On the whole it may be said that the geographical classification of the Slavs into N.W., S. and E. Slavs is justified linguistically, though too much stress must not be laid upon it as the lines of division are made less definite by the approximation of the languages which come next each other, the special characteristics of each group are generally represented in dialects of the others if not in the written languages; also some peculiarities (*e.g.* VI., *g > h*) run right across all boundaries, and secondary softening runs from N. to S., becoming less as it goes away from Poland (V., *c*). In fact, the triple division might be purely arbitrary but for the fact that the belt of Germans, Magyars and Rumanians has made impossible the survival of transitional dialects connecting up Čech with Slovene, Slovak with Servian, Russian with Bulgarian. Slovak, as it were, just fails to be a universal link: in the north Russian and Polish have much in common, but Lithuania made some sort of barrier and the difference of religion favoured separate development.

In the north Polish is closely connected with Kašube, and this with Polab, making the group of L'ach dialects in which the nasals survived (IV.). The two Sorb dialects link the L'achs on to the Čechs and Slovaks, the whole making the N.W. group with its preference for *c, z, s* as against *č, ž, š* (which were perhaps unknown to Polab, V. *b*), its *b'* as against *bl'* (V. *e*), its keeping *kv'* and *gv'* (V. *a*), *il* and *dl* (III. *c*), its *ř* (III. *a*, not in Slovak) and the fixed accent (VIII. not in Kaš.). The whole group (except Sorb) agrees with R. in having lost the aor. and impf. Yet Č. and Slovak agree with S. Slav. in *trat, trět* (III. *f, ii.*) in survival of *r* and *l'* (III. *d*) and of quantity (VIII.). Again, Slovene has occasional *tl, dl* (III. *c*), and its accent and quantity are not quite southerly, but its many dialects shade across to Croat and Servian, and they must all be classed together for the fate of *tj, dj* (V. *b*) and *a, e* (IV.). The Šopcy and Macedonians, among their numerous dialects, make a bridge between Servian and Bulgarian. The special mark of the latter is *tj, dj > št, žd*, which is the main philological argument for making O.S. Bulgarian. In general S. Slav. shows less soft letters than N.W. and E. (V. *c* and *d*). It shares with Russian *bl < bj* (V. *e*), *tl, dl > l* (III. *c*), *kv' > cv* *zv* (V. *a*) and the general loss of *a, e* (IV.), and is closer to it in the fate of *tj, dj* (V. *b*). Bulgarian, especially in some dialects, is, as it were, a transition to Russian, *e.g.* in accentuation.

Russian stands by itself by its *torot, tolot* (III. *f, ii.*) and its

treatment of *tj* and *dj* (V. *b*) and the place of its accent (VIII.) in all of which it is rather archaic, while *je > o*, *ju > u* (VII.) is its own innovation. In its secondary softening Lit. R., Gt. R. and Wh. R. make a gradual bridge between S. Slav and Polish (V. *c-e*). In common with Polish, R. further has the retention of *y* (II.) and the loss of the aor. and impf.

Finally, within historic time certain dialects have influenced others through literary and political intercourse. O.S. has influenced all the Orthodox Slavs and the Croats, so that Russian is full of words with O.S. forms pronounced *à la Russe* (*q > u*, *ę > ja*, *šl' > šč*, &c.). Čech has almost overshadowed Slovak and early afforded literary models to Polish. Polish has overshadowed Kašube and much influenced Little and White Russian and Great Russian in a less degree. Russian has in its turn supplied modern Bulgarian with a model. Again, other tongues have contributed something; in common Slavonic there are already German loan words, and others have followed in various periods, especially in Čech and Polish, while the very structure of Slovene and Sorb has been affected. Polish has adopted many Latin words. Bulgarian and Servian received many Turkish words. Russian took over many Eastern words in the Tatar period, and the common vocabulary of Western civilization since the time of Peter the Great, but on the whole, though the Slav easily takes to a fresh language, he has kept his own free from great admixture.

BIBLIOGRAPHY.—I. *Ethnography*: M. F. Mirkovič and A. S. Budilovič, *Etnografičeskaja Karta Slavjanskich Narodnostej* (Ethnographical Map of Sl. Peoples) (St Petersburg, 1875); Le Monnier, *Sprachenkarte von Osterreich-Ungarn* (Vienna, 1888); *Osterreich-Ungarn im Wort und Bild* (Vienna and Teschen). 2. *Antiquities and Early History*: P. J. Šafařík, *Slavské Starožitnosti* (Slavonic Antiquities: German and Russian Translations) (Prague, 1862–1863); A. Th. Hilferding, *Collected Works* (St P., 1868); A. Harkavy, *Skazania Musul'manskich Pisatelej o Slavjanach i Russach* (Information of Muslim writers about the Sl. and Rus.) (St P., 1870); M. Drinov, *Zaselenie Balkanskago Poluostrova Slavjanami* (Occupation of the Balkan Peninsula by the Sl.) (Moscow, 1873); G. Krek, *Einführung in die slavische Literaturgeschichte* (Graz, 1886); Th. Braun, *Razyskania v oblasti Goto-Slavjanskich Otnošenij* (Investigations into the province of Gotho-Slavonic Relations) (St P., 1899); J. Marquart, *Osteuropäische und ostasiatische Streifzüge* (Leipzig, 1903); L. Niederle, *Lidstvo v době předhistorické* (Prague, 1893). "Man in Prehistoric Time," Russian Trans. (St P., 1898), *Slavské Starožitnosti* (Slavonic Antiquities, a splendid review of the whole subject) (Prague, 1902—). 3. *Proto-Slavonic and Comparative Grammars, &c.*: A. Schleicher, *Vergleichende Grammatik der indogermanischen Sprachen* (Weimar, 1866); J. Schmidt, *Die Verwandtschaftsverhältnisse der I.-G. Sprachen* (Weimar, 1872); O. Schrader, *Reallexikon d. I.-G. Altertumskunde* (Strassburg, 1907); V. Jagić, "Einige Streitfragen: 3. Eine einheitliche slavische Ursprache," in *Arch. f. slav. Phil.* xxii. (1900); Fr. Miklosich, *Vergleichende Grammatik der sl. Spr.* (Vienna, 1875–1883); T. Florinskij, *Lekcii po Slavjanskomyjazykoznaniju* (Lectures on Slavonic Linguistics. Both Miklosich and Florinskij give short grammars of each language) (Kiev, 1895–1897); V. Vondrák, *Vergleichende slavische Grammatik* (a true comparative grammar) (Göttingen, 1906–1908); F. Miklosich, *Elymologisches Wörterbuch der slavischen Sprachen* (Vienna, 1886); R. Th. Brandt, *Načertanie Slavjanskaj Akcentologii* (Outline of Sl. Accentuation) (St P., 1880); E. Berneker, *Slavische Chrestomathie mit Glossaren* (specimens of all Sl. tongues) (Strassburg, 1902). The central organ for Slavonic studies is *Archiv für slavische Philologie*, conducted by V. Jagić (Berlin, 1876—). 4. *Literary History*: A. N. Pypin and Spasowicz, *Istoria slavjanskich Literatur* (2nd ed., St P., 1879); W. R. Morfill, *Slavonic Literature* (S.P.C.K., London, 1883). 5. *O.S. Grammar, &c.*: F. Miklosich, *Altslovenische Formenlehre in Paradigmen* (Vienna, 1874); A. Leskien, *Handbuch der altbulgarischen (altkirchenslavischen) Sprache* (with Texts) (4th ed., Weimar, 1905), Russian trans. with account of Ostromir Gospel by Ščepkin and Šachmatov (Moscow, 1890); V. Vondrák, *Altkirchenslavische Grammatik* (Berlin, 1900); F. Miklosich, *Lexicon Palaeoslovenicum-Graeco-Latinum* (Vienna, 1862–1865). 6. *O.S. Texts: Evangelium Zographense* (glag.), ed. Jagić (Berlin, 1879); *Evangelium Marianum* (glag.), ed. Jagić (St P., 1883); *Evangelium Assemani* (glag.), ed. Črnič (Rome, 1878); *Psalterium et Euchologium Sinaitica* (glag.), ed. Geitler (Agram, 1882–1883); *Glagolita Clozianus*, ed. Vondrák (Prague, 1893); "Fragmenta Kieviana" (glag.), ed. Jagić, *Denkschr. k. Akad. d. W., phil.-hist. Kl.* xxxviii. (Vienna, 1890); *Codex Suprasliensis* (cyr.), ed. Miklosich (Vienna, 1851); *Evangelium Savvae* (cyr.), ed. Ščepkin (St P., 1900); *Evangelium Ostromiri* (cyr.), ed. Savvinkov (St P., 1889). 7. *Alphabets*: P. J. Šafařík, *Über den Ursprung und Heimat des Glagolismus* (Prague, 1858); I. Taylor, *The Alphabet*, vol. ii. (London, 1883); L. Geitler, *Die*

albanesischen und slavischen Schriften (facsimiles) (Vienna, 1883); V. Jagić, *Cetyre Paleografičeskia Statji* (Four Palaeographical Articles) (St P., 1884); *Id.* "Zur Entstehungsgeschichte der kirchenslavischen Sprache," in *Denkschr. d. k. Akad. d. Wiss., phil.-hist. Kl.* xlvii. (Vienna, 1902); *id.* "Einige Streitfragen 5." (numerical value and nasals in glag.), in *Arch. f. sl. Phil.* xxiii. (1901); A. Leskien, "Zur glagolitischen Schrift," *ib.* xxvi. (1905); A. Brückner, "Thesen zur Cyrillo-Methodianischen Frage," *ib.* xxvii. (1906); E. Th. Karskij, *Öčerk Slavjanskaj Kirillovskoj Paleografii* (Outline of Sl. Cyrillic Palaeography) (Warsaw, 1901). (E. H. M.)

SLAVYANSK, a town of Russia, in the government of Kharkov, 158 m. by rail S.E. of the town of Kharkov, on the Torets river and close by several salt lakes, from which salt is extracted. Pop. (1897) 15,644. There are soap, candle and tallow-works. Slavyansk carries on a brisk trade in salt, cattle and tallow. The ancient name of Slavyansk was Tor. The town, which is supposed to occupy the site of a former settlement of the Turks (Turks), who inhabited the steppes of the Don, was founded in 1676 by the Russians to protect the salt marshes. Having an open steppe behind it, this fort was often destroyed by the Tatars. Its salt trade became insignificant in the 18th century and only revived towards the end of the 19th century.

SLEAFORD, a market town in the North Kesteven or Sleaford parliamentary division of Lincolnshire, England, in a fertile and partly fenny district on the river Sleac. Pop. of urban district (1901) 5468. It is 112 m. N. by W. from London by the Great Northern railway, being the junction for several branch lines and for the March-Doncaster joint line of the Great Northern and Great Eastern companies. The church of St Denis is one of the finest in the county, exhibiting transitional Norman work in the base of the western tower, which is crowned by an Early English spire, which, however, is mainly a copy of the original. The nave is of beautiful late Decorated work with an ornate south porch. There is a splendid carved rood screen of oak. The chancel is Perpendicular. There are a few picturesque old houses. The district is very fertile, and the trade of the town is principally agricultural, while malting is also carried on.

The discovery of numerous coins of the Constantine period, the earthworks of the castle-area, and its proximity to the ford by which Ermine Street crossed the Witham, point to the probability of Sleaford (*Slaforde*, *Lafford*) being on the site of a Roman settlement or camp, and that the Saxons occupied the site before their conversion to Christianity is evident from the large cemetery discovered here. Domesday Book records that the manor had been held from the time of Edward the Confessor by the bishops of Lindsey, whose successors, the bishops of Lincoln, retained it until it was surrendered to the Crown in 1546. It soon afterwards passed to the family of Carr and from them, by marriage, in 1688 to John Hervey, afterwards earl of Bristol. The quadrilateral castle, with its square towers and massive keep, was built by Alexander, bishop of Lincoln, and became one of the chief episcopal strongholds. King John rested here in 1216 after his disastrous passage of the Wash, and in 1430 Bishop Richard Fleming died here. The castle was in good repair on its surrender in 1546, but was dismantled before 1600. Sleaford never became a municipal or parliamentary borough, and the government was manorial, the bishops possessing full jurisdiction. The town-folk were, however, largely organized in the guilds of Corpus Christi, St John and Holy Trinity, accounts for which are extant from the year 1477. The origin of the markets and fairs is unknown, but in answer to a writ of *quo warranto* of the reign of Edward I., the bishop declared that they had been held from time immemorial.

See *Victoria County History, Lincolnshire*; G. W. Thomas, "On Excavations in an Anglo-Saxon Cemetery at Sleaford, Lincolnshire," *Archaeologia*, vol. i. (London, 1887); Edward Trollope, *Sleaford and the Wapentakes of Flaxwell and Aswardhurn in the county of Lincoln* (London, 1872).

SLEEMAN, SIR WILLIAM HENRY (1788–1856), Indian soldier and administrator, was born at Stratton, Cornwall, on the 8th of August 1788. He was the son of Philip Sleeman, yeoman and supervisor of excise. In 1809 he joined the Bengal army, served in the Nepal War (1814–1816), and in 1820 became assistant to the governor-general's agent in the Saugor and Nerbudda

territories. He is best known for his suppression of the Thugs or religious murderers in India, becoming superintendent of the operations against them in 1835, and commissioner for the suppression of Thuggi and Dacoity in 1839. During these operations more than 1400 Thugs were hanged or transported for life, one of whom confessed to having committed over 700 murders. Detection was only possible by means of informers, for whose protection from the vengeance of their associates a special gaol was established at Jubbulpore. Sleeman was resident at Gwalior 1843-1849, and at Lucknow 1849-1856. He was opposed to the annexation of Oudh by Lord Dalhousie, but his advice was disregarded. He died at sea on his way home on the 10th of February 1856.

See Sir H. Sleeman, *Rambles and Recollections of an Indian Official* (1844; 2nd edition, 1893), and *A Journey through Oudh* (1858).

SLEEP (O. Eng. *slæpan*; Ger. *schlafen*; cf. Lat. *labi*, to glide, and "slip"), a normal condition of the body, occurring periodically, in which there is a greater or less degree of unconsciousness due to inactivity of the nervous system and more especially of the brain and spinal cord. It may be regarded as the condition of rest of the nervous system during which there is a renewal of the energy that has been expended in the hours of wakefulness; for in the nervous system the general law holds good that periods of physiological rest must alternate with periods of physiological activity, and, as the nervous system is the dominating mechanism in the body, when it reposes all the other systems enjoy the same condition to a greater or less extent. Rest alternates with work in all vital phenomena. After a muscle has contracted frequently at short intervals, a period of relaxation is necessary for the removal of waste products and the restitution of energy; the pulsating heart, apparently working without intermission, is in reality not doing so, as there are short intervals of relaxation between individual beats in which there is no expenditure of energy; the cells in a secreting gland do not always elaborate, but have periods when the protoplasm is comparatively at rest. Nervous action also involves physico-chemical changes of matter and the expenditure of energy. This is true even of the activity of the brain associated with sensation, perception, emotion, volition and other psychical phenomena, and therefore the higher nervous centres require rest, during which they are protected from the stream of impressions flowing in from the sense-organs, and in which waste matters are removed and the cerebral material is recuperated for another time of wakeful activity. (See also HYPNOTISM, and the physiological sections of the articles BRAIN, and MUSCLE AND NERVE.)

The coincidence of the time of sleep with the occurrence of the great terrestrial phenomena that cause night is more apparent than real. The oscillations of vital activity are not correlated to the terrestrial revolutions as effect and cause, but the occurrence of sleep, in the majority of cases, on the advent of night is largely the result of habit. Whilst the darkness and stillness of night are favourable to sleep, the state of physiological repose is determined more by the condition of the body itself. Fatigue will normally cause sleep at any time of the twenty-four hours. Thus many of the lower animals habitually sleep during the day and prowl in search of food in the night; some hibernate during the winter season, passing into long periods of sleep during both day and night; and men whose avocations require them to work during the night find that they can maintain health and activity by sleeping the requisite time during the day.

The approach of sleep is usually marked by a desire for sleep, or sleepiness, embracing an obscure and complicated group of sensations, resembling such bodily states of feeling as hunger, thirst, the necessity of breathing, &c. All of these bodily states, although on the whole ill-defined, are referred with some precision to special organs. Thus hunger, although due to a general bodily want, is referred to the stomach, thirst to the fauces, and breathing to the chest; and in like manner the desire for sleep is referred chiefly to the region of the head and neck. There is a sensation of weight in the upper eyelids, intermittent spasm of the sub-hyoid muscles causing yawning, and drooping of the head. Along with these signs there is obscuration of the

intelligence, depression both of general sensibility and of the special senses, and relaxation of the muscular system. The half-closed eyelids tend more and more to close; the inspirations become slower and deeper; the muscles supporting the lower jaw become relaxed, so that the mouth opens; the muscles of the back of the neck that tend to support the head also relax and the chin droops on the breast; and the limbs relax and tend to fall into a line with the body. At the same time the hesitating utterances of the sleepy man indicate vagueness of thought, and external objects gradually cease to make an impression on the senses. These are the chief phenomena of the advent of sleep. After it has supervened there are many gradations in its depth and character. In some cases the sleep may be so light that the individual is partially conscious of external impressions and of the disordered trains of thought and feeling that pass through his mind, constituting dreams, and these may be more or less vivid, according to the degree of consciousness remaining. On the other hand, the sleep may be so profound as to abolish all psychical phenomena: there are no dreams, and when the sleeper awakes the time passed in this unconscious state is a blank. The first period of sleep is the most profound. After a variable period, usually from five to six hours of deep sleep, the faculties awaken, not simultaneously but often fitfully, so that there are transient periods of consciousness. This is the time of dreaming. As the period of waking approaches the sensibility becomes more acute, so that external impressions are faintly perceived. These impressions may influence and mould the flow of images in the mind of the sleeper, frequently altering the nature of his dreams or making them more vivid. The moment of waking is usually not instantaneous, but is preceded by an intermediate state of partial consciousness, and a strange play of the mental faculties that has more of the character of an "intellectual mirage" than of consecutive thought.

The intensity of sleep has been measured by Kohlschütter by the intensity of the sound necessary to awaken the sleeper. This intensity increases rapidly during the first hour, then decreases, sometimes rapidly, sometimes slowly, during the next two or three hours, and then very slowly until the time of waking. This statement agrees generally with experience. As a rule the deeper the sleep the longer it lasts.

Various physiological changes have been observed during sleep, but much remains to be done in this direction. The pulse becomes less frequent; the respiratory movements are fewer in number and are almost wholly thoracic, not abdominal; all the secretions are reduced in quantity; the gastric and intestinal peristaltic movements are less rapid; the pupils of the eye are contracted and during profound sleep are not affected by light; and the eyeballs are rotated upwards. The pupils dilate slightly when strong sensory or auditory stimuli are applied, and they dilate the more the lighter the sleep; at the moment of waking they become widely dilated. Whilst muscular relaxation is general, there seems to be increased contraction of certain sphincter muscles, as the circular fibres of the iris and the fibres concerned in closing the eyelids. The state of the circulation of the brain has been frequently investigated. The older view was that there was a degree of plethora or congestion of the vessels of the brain, as is the state of matters in coma, to which the state of sleep has a superficial resemblance. Coma, however, is not sleep, but a condition of inactivity of the cerebral matter owing to the accumulation of dark venous blood in its vessels. This has been actually observed in cases where it was possible to see the brain. During sleep the surface of the exposed brain has been observed to become pale and to shrink somewhat from the sides of the opening (Johann Blumenbach, 1752-1840). A careful experimental research was conducted by Arthur E. Durham in 1860, in which he trephined a portion of bone as large as a shilling from the parietal region of a dog, and, to obviate the effects of atmospheric pressure, inserted a watch glass into the aperture so that the surface of the brain could be seen. His results are summarized thus:—

"(1) Pressure of distended veins on the brain is not the cause of sleep, for during sleep the veins are not distended; and, when they

are, symptoms and appearances arise which differ from those which characterize sleep. (2) During sleep the brain is in a comparatively bloodless condition, and the blood in the encephalic vessels is not only diminished in quantity, but moves with diminished rapidity. (3) The condition of the cerebral circulation during sleep is, from physical causes, that which is most favourable to the nutrition of the brain tissue; and, on the other hand, the condition which prevails during waking is associated with mental activity, because it is that which is most favourable to oxidation of the brain substance, and to various changes in its chemical constitution. (4) The blood which is derived from the brain during sleep is distributed to the alimentary and excretory organs. (5) Whatever increases the activity of the cerebral circulation tends to preserve wakefulness; and whatever decreases the activity of the cerebral circulation, and, at the same time, is not inconsistent with the general health of the body, tends to induce and favour sleep. Such circumstances may act primarily through the nervous or through the vascular system. Among those which act through the nervous system may be instanced the presence or absence of impressions upon the senses, and the presence or absence of exciting ideas. Among those which act through the vascular system may be mentioned unnaturally or naturally increased or decreased force or frequency of the heart's action."

Dr William A. Hammond and Dr Silas Weir Mitchell (b. 1830) repeated and extended Durham's observations, with the same general results (1866), and Ehrmann, Salathé (1877), François Franck (1877) and Mosso (1881), by more refined methods of observation arrived at the same general conclusions. Angelo Mosso (b. 1846) in particular applied with great success the graphic method of registration to the study of the movements of the brain and of the circulation during sleep. He made observations on three persons who had lost a portion of the cranial vault and in whom there was a soft pulsating cicatrix. They were a woman of thirty-seven years of age, a man of thirty-seven years and a child of about twelve years. By special arrangements, Mosso took simultaneous tracings of the pulse at the wrist, of the beat of the heart, of the movements of the wall of the chest in respiration, and of the movements of the denuded brain. Further, by means of the plethysmograph—an instrument of Mosso's own invention—he obtained tracings showing changes in the volume of the hand and forearm; and he succeeded in showing that during sleep there is a diminished amount of blood in the brain, and at the same time an increased amount in the extremities. He showed further that there are frequent adjustments in the distribution of the blood, even during sleep. Thus a strong stimulus to the skin or to a sense organ—but not strong enough to awaken the sleeper—caused a contraction of the vessels of the forearm, an increase of blood pressure, and a determination of blood towards the brain; and, on the other hand, on suddenly awakening the sleeper, there was a contraction of the vessels of the brain, a general rise of pressure, and an accelerated flow of blood through the hemispheres of the brain. So sensitive is the whole organism in this respect, even during sleep, that a loudly spoken word, a sound, a touch, the action of light or any moderate sensory impression modified the rhythm of respiration, determined a contraction of the vessels of the forearm, increased the general pressure of the blood, caused an increased flow to the brain, and quickened the frequency of the beats of the heart. These observations show how a physiological explanation can be suggested of the influence of external impressions in modifying the dreams of a sleeper. Further, Mosso found that during very profound sleep these oscillations disappear: the pulsatory movements are uniform and are not affected by sensory impressions, and probably this condition exists when there is the absolute unconsciousness of a "dead" sleep. By such methods as have been employed by Mosso, three movements of the brain have been observed—(1) *pulsations*, corresponding to the beats of the heart; (2) *oscillations*, or longer waves, sometimes coinciding with the heart beats, or more generally consisting of longer festoons, carrying each a number of smaller waves, and believed to correspond generally to the respiratory movements; and (3) *undulations*, still longer and less marked elevations and depressions, first clearly observed by Mosso, and believed by him to indicate rhythmic contractions of the vessels of the pia mater and of the brain. This view is in keeping with the observations of Franz Cornelius Donders (b. 1818), Adolf Kussmaul

(b. 1822), Tenner and others on changes of calibre observed in the cerebral vessels, and with the experiments of many physiologists, showing that the vessels of the pia mater, like other vessels, are controlled by the vaso-motor system of nerves. It may therefore be considered certain that during sleep there is an anaemia, or partially bloodless condition, of the brain, and that the blood is drawn off to other organs, whilst at the same time this anaemic condition may be modified by changes in the circulation or in the respiratory mechanism caused by position, by sensory impressions or by sudden changes in the state of repose of the muscles. The examination of the retina (which may be regarded as a cerebral outwork) by the ophthalmoscope during sleep also shows a comparatively bloodless condition. Such are the facts; the deficiency in the way of a theoretical explanation is that physiologists cannot satisfactorily account for the anaemic condition causing unconsciousness. Sudden haemorrhage from the brain and nerve-centres, or a sudden cessation of the supply of blood to the brain, as occurs in syncope (failure of the heart's action—a faint), no doubt causes unconsciousness, but in these circumstances there is a tendency to convulsive spasm. Such spasm is usually absent in sleep, but sudden jerks of the limbs may sometimes be observed during the time when there is the confusion of ideas preceding the passage into sleep.

During sleep the amount of carbonic acid eliminated is very much reduced, indicating that molecular changes in the tissues do not occur to the same extent as in the waking state. This is also shown by the fact that less heat is produced. Hermann von Helmholtz (b. 1821) states that the amount of heat produced by a man weighing 67 kilogrammes (147·4lb) is about 40 calories per hour during sleep, as against 112 calories per hour while awake. This diminished production of heat may be largely accounted for by the quiet condition of the muscles of locomotion, but it also indicates diminished tissue changes throughout the body. In profound sleep the bodily temperature may fall from 0.6° to 0.2° Fahr. In consequence of diminished oxidation changes during sleep, it is not improbable that excess of nutrient matter may then be stored up in the form of fat, and that thus the proverb "He who sleeps dines" is based on a correct appreciation of the fact that sleep tends to produce plethora or obesity.

Whilst it is easy to state that sleep is caused by fatigue of the nervous system, it is more difficult to explain what the precise changes are that produce the state of unconsciousness. Various hypotheses have been advanced, but it cannot be said that any one is wholly satisfactory. Aware that the fatigue of muscle is associated with the accumulation of sarcolactic acid, Thierry William Preyer (b. 1841) surmised that the activity of nervous matter might be interfered with by the accumulation in the nerve-centres of some such acid, or of its soda salt (lactate of soda), but this view has not been supported by the results of experiment, as the injection into the blood of a dose of lactate of soda has not produced sleep. Pflüger has observed that frogs deprived for a considerable time of oxygen passed gradually into a state resembling profound sleep, and he has advanced the theory that there is no organ of the body so quickly affected by deprivation of oxygen as the brain. According to Eduard F. W. Pflüger (b. 1829), the phenomena of life depend on a dissociation of living matter, and in particular the activity of the cerebral substance connected with psychical states depends on dissociation changes in the grey matter. To excite the dissociation, however, oxygen is necessary. The oxygen unites with certain of the compounds set free by the dissociation, forming, amongst other substances, carbonic acid. If such matters as these that unite with oxygen are in sufficient amount to use up all the oxygen, the grey matter of the brain suffers from a deficiency of oxygen (or from its absence), and also from the accumulation of carbonic acid. According to such a theory, cerebral activity depends on cerebral respiration, and sleep is a kind of cerebral asphyxia. Some such condition is not improbable, but it must be stated that the evidence at present in support of it is meagre. Possibly, in attempting to account for the phenomenon of sleep, too much importance has been attributed to the changes occurring in the

brain, forgetting that not merely brain matter but every tissue of the body becomes exhausted by work, and that sleep may be partly due to phenomena occurring throughout the body and not in the brain alone.

All the phenomena of sleep point to a diminished excitability of the cerebral nerve-centres and of the spinal cord. Contrary to what is often stated, there can be no doubt that reflex action is in partial abeyance and that the spinal cord is in a state of partial inactivity as well as the brain. The only nerve-centres that do not sleep are those absolutely essential to life, such as those connected with the heart, with respiratory movements, and with the distribution of blood by the vaso-motor arrangements; and Mosso's experiments indicate that even these have a certain amount of repose in profound sleep.

There is little doubt that all living beings require periods of repose alternating with periods of activity. Many plants close their flowers and bend their petioles at certain times of the day. These phenomena, called "the sleep of plants," depend apparently on changes in solar radiation, and there is no reason to believe that during the time of quiescence any reparative processes go on, as during the sleeping period of animals. Naturalists have observed many of the lower animals apparently in a state of sleep. Insects, crustaceans, fishes, reptiles, may all be observed occasionally to be almost motionless for considerable periods of time. The sleeping of birds is familiar to all, and in these there are anatomical arrangements by which the bird may, like the crane, sleep perched on one leg, or grasping a branch with both feet, like perching birds generally, without any muscular effort and consequently without fatigue.

The amount of sleep required by man varies according to age, sex and habit. The popular notion that a child sleeps half its time, an adult one-third, whilst an old person may do little except eat and sleep is not far wrong. In early life the cerebral faculties appear to be easily exhausted and during the frequent and prolonged sleeps of infancy the brain rests and the vegetative changes connected with nutrition and growth go on actively. As life advances, less sleep is required, until in adult life a period of seven or eight hours is sufficient. As a rule, women require more sleep than men; but much depends on habit. Thus most women bear the loss of sleep in the first instance better than men, because they have been accustomed more to loss or irregularity of sleep. The effect of habit is well seen in nurses, both male and female, who will often be able to work for weeks continuously with snatches of sleep, not amounting to more than two or three hours daily. Sooner or later, however, even in these cases nature asserts her demands, and prolonged sleep is necessary to maintain health and vigour. Wakefulness during the time when one ought to be asleep is frequently a distressing condition, undermining the strength and incapacitating for active and efficient work (see INSOMNIA).

It is a matter of common observation not only that certain persons require more sleep than others but that they have less power of resisting its onset and of awaking. This condition may become morbid, constituting a veritable nervous disease, to which the name "maladie du sommeil" or *hypnosia* may be given. It may be described as invincible sleep, and it may continue for weeks and for months, terminating in convulsive seizures, and even death. A persistent drooping of the upper eyelid has been observed even during waking hours. Dr W. Ogle has observed in such cases an engorgement of the cervical ganglia of the sympathetic; but this may have nothing to do with the condition. Cases of very prolonged sleep are not uncommon, especially amongst hysterical persons, lasting four, seven or ten days. On awaking the patient is exhausted and pale, with cold extremities, and not infrequently, after a brief interval of waking, passes off into another lethargic sleep. Something similar to this may be seen in very aged persons towards the close of life. (See also DREAMS, SOMNAMBULISM and HYPNOTISM.)

Among older works, see article "Sommeil" in the *Dictionnaire encyclopédique des sciences médicales*, where a bibliography is given and where also there is an account of the medico-legal questions connected with sleep and somnambulism; Macnish, *Physiology of Sleep*; Durham, "On the Physiology of Sleep," in Guy's *Hospital Reports* (1860); Kohlschütter, "Die Mechanik des Schlafes," in *Z. f. ration. Med.*, vol. xxxiii. (1869); Pflüger, "Theorie des Schlafes," in *Pflüger's Archiv*, vol. x. (1875); Mosso, *Über den Kreislauf des Blutes im menschlichen Gehirn* (Leipzig, 1881). Also Manacéine, *Sleep, its Physiology, Pathology, Hygiene and Psychology* (Eng. trans. 1897), with bibliography. (J. G. M.)

SLEEPER, a term used with many technical applications for a piece of timber, metal, &c., used as a support; in carpentry it is such a piece of timber laid on low cross walls as a plate to receive ground joists; in shipbuilding, a strengthening timber for the bows and stern frame; the most frequent use of the term is for a timber or steel support on which the chairs are fixed for carrying the rails on a railway; in America these are called

"ties" (see RAILWAYS). The common explanation of the origin of the word is to connect it with "sleep," the timbers supposed to be lying at rest. The real source of the word is the Norwegian *sleep*, a piece of timber used for dragging things over, a roller, especially used of timbers laid in a row in making a road. This word Skeat (*Etymol. Dict.*, 1898) connects with "slab," a flat piece of stone or wood. The French term *dormant* is used in carpentry, but as part of the frame of a window or door.

SLEEPING-SICKNESS (*Trypanosomiasis*), a remarkable parasitic disease, familiar among West African natives since the beginning of the 19th century, and characterized by protracted lethargy, fever and wasting. It is attributed to the *trypanosoma gambiense*, a parasite which was discovered in the frog by Gruby in 1847, and in 1880 by Griffith Evans in horses afflicted with the disease called "surra" in India. In 1895 Surgeon-Major (afterwards Sir) D. Bruce found a trypanosoma similar to Evans's in cases of what was known in cattle as "tsetse-fly disease"; and though the trypanosoma had not then actually been found in man, Bruce suggested that this was akin to the human "sleeping-sickness" which had now extended into the Congo Free State, Uganda and elsewhere, and was causing great mortality, many Europeans having died of the disease. In 1903 Castalani found the trypanosoma in the cerebro-spinal fluid of human patients afflicted with the disease. The question of the pathology of "sleeping-sickness" was vigorously taken up, and in June 1907 an international conference was held in London for the purpose of organizing research on the subject. As was pointed out by Lord Fitzmaurice (18th of June), in his opening address, it was already accepted that *trypanosoma gambiense* was the cause of the disease, and it was even then "all but proved" that the parasite was conveyed by at least one species of tsetse fly (*glossina palpalis*), the distribution of which was limited to the neighbourhood of open water. It had further been ascertained, experimentally in animals, and therapeutically in man, that the infection once acquired could be controlled, to some extent, by various substances—arsenic, certain colours, dyes, in combinations of arsenic and colour dyes, e.g. atoxyl—and by mercury. It remained a question how far certain unascertained factors were at work in the spread of the disease, and for this purpose the British government invited the co-operation of all the powers interested in tropical Africa in considering certain problems, annual or biennial conferences being suggested, and the formation of a central bureau, in order to organize the research. These problems were: (1) to determine whether the tsetse fly (*glossina palpalis*) was a direct or indirect conveyor of the parasite; (2) whether the parasite underwent necessary developmental changes in the tsetse fly; (3) if so, whether the developed germs were conveyed by the original fly or its larva when arrived at the imago stage; (4) how long an infected *glossina palpalis* remained infected; (5) whether other species of *glossina* were concerned; (6) the geographical distribution and habits of the fly; (7) whether and how far the spread of infection was the work of any of the vertebrate fauna (other than man); (8) to suggest preventive methods for exterminating the *glossina*, or protecting uninfected districts by segregation or otherwise; (9) to study the therapeutics of the disease. In the history of modern pathology, this organization of research in respect of "sleeping-sickness" must hold an important place as the application of state effort on behalf of the advancement of science. (See NEUROPATHOLOGY and PARASITIC DISEASES.)

AUTHORITIES.—Sir P. Manson, *Lane Lectures on Tropical Diseases* (1905); W. F. M. Marshall, "Trypanosomiasis or Sleeping-Sickness," in *Review of Neurology and Psychiatry* (February 1906); F. W. Mott, *Archives of Neurology*, vol. iii. (1907); *Reports of the Sleeping-Sickness Commission*; Castellani, "Researches on the Aetiology of Sleeping-Sickness," *Journal of Tropical Medicine* (June 1903).

SLEET (either from Nor. *sletta*, of the same meaning, or related to Ger. *Schlosse*, hailstone), that form of precipitation of water vapour condensed from the atmosphere, which reaches the ground in a partly frozen condition. Sleet may originate in the upper atmosphere either as rain, in which case, to become partly frozen, it must have fallen into a stratum of air colder than that in which it originated, or as snow, when the opposite must have

taken place, *i.e.* the snow in its descent must have encountered an air-temperature slightly above the freezing-point.

SLEEVE (O. Eng. *sleeve*, *slyf*, a word allied to "slip," cf. Dutch *sloof*, apron), that part of a garment which covers the arm, or through which the arm passes or slips. The pattern of the sleeve is one of the characteristics of fashion in dress, varying in every country and period. Various survivals of the early forms of sleeve are still found in the different types of academic or other robes (*q.v.*). Where the long hanging sleeve is worn it has, as still in China and Japan, been used as a pocket, whence has come the phrase "to have up one's sleeve," to have something concealed ready to produce. There are many other proverbial and metaphorical expressions associated with the sleeve, such as "to wear one's heart upon one's sleeve," "to laugh in one's sleeve," &c. In technical usage a "sleeve" is a tube into which another tube is inserted, which in the case of small tubes is called a thimble.

SLEIDANUS, JOHANNES (1506–1556), German historian, the annalist of the Reformation, was born at Schleiden near Aix-la-Chapelle. He studied ancient languages and literatures at Liège and Cologne, and law and jurisprudence at Paris and Orleans. Whilst among the humanists of Liège, he had adopted Protestant opinions, and entering the service of Cardinal du Bellay, was employed in the futile negotiations of the French court to make an alliance with the German Protestants against the emperor Charles V. In 1542 he settled at Strassburg. Sleidanus had been accustomed to copy all papers bearing upon the Reformation to which he had access, and Martin Bucer, who had seen his collection, proposed to Philip of Hesse to appoint him historian of the Reformation, giving him a salary and access to all necessary documents. After some delay the heads of the league of Schmalkalden agreed to the proposal, and Sleidanus began his great work, finishing the first volume in 1545. In that year he was recalled to diplomacy, and went to England in a French embassy to Henry VIII. While there he collected materials for his history. On his return he represented Strassburg at the diets of Frankfort and Worms, and went on to Marburg to explore the archives of Philip of Hesse. The war of the league of Schmalkalden interfered with this work, and also prevented the payment of Sleidanus, who in his difficulties applied to England for aid, and at Cranmer's intercession received a yearly pension from Edward VI., which, however, was not long continued. In 1551 Sleidanus went to the council of Trent as representative from Strassburg, charged also with full powers to act for the imperial cities of Esslingen, Ravensburg, Reutlingen, Biberach and Lindau. He was afterwards appointed professor of law in Strassburg, and finished his great task in 1554, though lack of money and other misfortunes compelled him to delay printing. Sleidanus died in poverty at Strassburg in October 1556. The book appeared in the preceding year—*Commentariorum de statu religionis et reipublicae, Carolo V. Caesare, libri XXVI.*; it was translated into English by John Daws in 1560 and by G. Bohum in 1689. It was so impartial that it pleased no one, not even Melancthon. It remains the most valuable contemporary history of the times of the Reformation, and contains the largest collection of important documents.

See H. Baumgarten, *Über Sleidanus Leben und Briefwechsel* (1878), and *Sleidans Briefwechsel* (1881); and A. Hasenclever, *Sleidan-Studien* (Bonn, 1905).

SLEIGH, SLED or SLEDGE (Dan. *slæde*, Dutch *slede*, akin to "slide"), a vehicle on runners instead of wheels, for travelling over snow or ice. Various forms are used according as the object is utility or sport. The sleighs used in COASTING are referred to in the article under that heading; but for ordinary means of conveyance horse-drawn sleighs are employed as carriages in countries such as Russia, Scandinavia, and North America, where the roads are snow-bound in the cold season; and in the Arctic regions dogs are harnessed to them.

SLIDELL, JOHN (1793–1871), American political leader and diplomatist, was born in New York City in 1793. He graduated from Columbia College in 1810, engaged in business for a short time, then studied law, and became one of the leaders of the

bar at New Orleans, Louisiana, where he settled permanently in 1825. He was a member of the national House of Representatives as a state's rights Democrat from 1843 to 1845, when he resigned and was sent by President Polk on a secret mission to Mexico, with power to adjust the difficulties growing out of the annexation of Texas to the United States, and to acquire by purchase both New Mexico (including the present Arizona,) and Upper California. He was not, however, received by the Mexican government. From 1853 to 1861 he was a representative of Louisiana in the United States Senate, and was an influential working member of important committees, though he seldom took part in debate. During this period he was intimately associated with James Buchanan, and is supposed to have had an important part in bringing about Buchanan's nomination for the presidency in 1856. When Louisiana seceded in 1861, Slidell withdrew from the Senate, and late in 1861 was sent by the Confederate Government as commissioner to France. With James M. Mason (*q.v.*), the Confederate commissioner to England, he was taken from the British steamer "Trent" by Captain Charles Wilkes of the United States navy, and was imprisoned at Fort Warren in Boston harbour. In January 1862, at the demand of England, the Confederate commissioners were released, and Slidell proceeded to France. His mission there was to secure the recognition of the Confederate States; in this he was unsuccessful, but he was able to keep France sympathetic, and to help to secure supplies for the Confederate army and navy. After the war he remained abroad, settling in England, and his daughter married a French nobleman. He died in London on the 29th of July 1871.

SLIGO, a county of Ireland in the province of Connaught, bounded N. by the Atlantic, E. by Leitrim, S.E. by Roscommon, and S. and W. by Mayo. The area is 452,356 acres or about 707 sq. m. The coast-line is very irregular, and in some places rises into grand escarpments and terraces. The principal inlets are Killala Bay and Sligo Bay, the latter subdivided into Brown Bay, Drumcliffe Bay and Ballysadare Bay. Near the coast are the islands of Inishmurray and Coney and other smaller islets. Though Sligo cannot be compared for scenery with the western parts and north coast of County Mayo, it is well wooded and possesses several beautiful lakes and rivers and some ranges of hills finely situated and grouped. In the north are the limestone elevations of Ben Bulbin (1712 ft.) and Knocknarea (1078), contrasting with the adjacent rugged gneiss mountains, among which are King's Mountain (1527) and Gullagherboy (1430). On the boundary with Leitrim, Truskmore reaches a height of 2113 ft. In the west are the ranges of the Slieve Gamph and Ox Mountains, upwards of 1300 and 1600 ft. respectively. The Curlew Mountains, an abrupt ridge of limestone gravel, upwards of 800 ft. in height, with flattened summit, separate Sligo from Roscommon. The principal rivers are the Moy, forming for a part of its course the boundary with Mayo, and flowing south-westward and then northward into Killala Bay; the Easky, flowing northward from Lough Easky; and Ballysadare, with its branches the Owenmore, Owenbeg, and Arrow, or Unshin; and the Garvogue, or Garavogue, flowing from Lough Gill. Except the finely-situated Lough Gill (extending into Leitrim), Lough Arrow, and Lough Gara, all of which exceed 3000 acres in extent, none of the lakes has so large an area as 400 acres. The salmon, sea-trout and trout fishing is generally excellent in these waters, especially during the autumn, but Lough Arrow also provides sport during the Mayfly season.

This county essentially consists of Carboniferous Limestone, broken by the Dalradian axis of the Ox Mountains. The gneisses of this range, which obviously result from the intermingling of granite and a series of schists and quartzites, form a ridge of rocky hills, smoothed by glaciation, on the flanks of which Carboniferous shales rest. Above these, the limestone is boldly developed, forming great scarped tablelands north of Sligo, with some sandstone on the summit of Truskmore. Knocknarea, conspicuous from Sligo, is an outlier of the Upper Limestone. Lough Gill is picturesquely bounded by the gneissic range on the south and these high carboniferous masses on the north. The limestone also produces fine features in the south of the county, in Keishcorran and round Lough Arrow. East of this point, it forms the slopes of the Leitrim and Roscommon

coalfield, the summits being capped by the Millstone Grit series; while on the south, bounded by a fault, rises the Old Red Sandstone range of the Curlew Hills. Lead was mined at Ballysadare, and the clay-ironstone from the east of the county was at one time smelted.

Industries.—There is considerable variety both in the character of the soil and in the agricultural advancement in different parts of the county. In some parts it is a light sandy loam resting on a freestone bottom, and in the lower districts a rich and deep mould prevails resting on a substratum of limestone. Owing to the moistness of the climate cattle feeding is found to be the most remunerative method of farming, as may be gathered from the increasing or well-maintained numbers of cattle, sheep and poultry. Oats and potatoes are the principal crops, but the acreage devoted to them decreases, and the proportion of tillage to pasturage is roughly as 1 to 3½. Coarse woollens and linens are manufactured for home consumption, and there are tanneries, distilleries, and breweries in the principal towns. A considerable general trade is carried on at the ports of Ballina (on the Moy) and Sligo. The fisheries on the coast are valuable, and there are important salmon fisheries at the mouths of the rivers. The town of Sligo is the chief centre.

The Sligo branch of the Midland Great Western railway enters the county from the S.E., with a branch S.W. from Kilfree to Ballagherreen in county Mayo; the Limerick and Sligo line of the Great Southern and Western enters from S.W.; and the Sligo, Leitrim and Northern counties, from Enniskillen (county Fermanagh), and Manor Hamilton (county Leitrim), from the N.E. These lines unite at Collooney and share the railway from this junction to the town of Sligo.

Population and Administration.—The population (94,416 in 1891, 84,083 in 1901) decreases at a rate considerably above the average of the Irish counties, and emigration is heavy. Of the total about 90% are Roman Catholics and about 7% Protestant Episcopalians. About 88% is rural population. The county town is Sligo (pop. 10,870); Ballymote and Tobercurry (or Tubbercurry) are small inland market towns. The county is divided into six baronies. Assizes are held at Sligo and quarter-sessions at Ballymote, Easky and Sligo. For parliamentary representation the county has since 1885 formed two divisions (North and South), each returning a member. The county is mainly in the Protestant diocese of Kilmore, and in the Roman Catholic dioceses of Ardagh, Achonry, Elphin and Killala.

History.—The county was created by Sir Henry Sydney in 1579. On Carrowmore, between Sligo and Ballysadare, there is a remarkable collection of ancient stone monuments (see SLIGO, town). At Drumcliffe (½ m. N. of Sligo) are the only round tower remaining in the county and a beautiful Celtic cross 13 ft. in height. The principal monastic ruins are the abbey of St Fechan at Ballysadare, with a church of the 11th or 12th century; the abbey of Sligo; and a remarkable group of buildings on the island Inishmurray, which include a cashel or walled enclosure; three oratories, one of which contains an oaken figure in ecclesiastical garb; two holy wells; and also altars, pillar stones, inscribed slabs (one of which is unique among those of its kind in Ireland in having an inscription partly in Latin), and several examples of beehive cells. This settlement is associated with Molaise, a saint of the early 6th century (not identical with the Molaise of Devenish in Loch Erne), and the remains still attract pilgrims, who revere the oaken figure mentioned as an image of the saint, though it is more probably the figurehead of a vessel.

SLIGO, a municipal borough, seaport and market town, and the county town of county Sligo, Ireland. Pop. (1901) 10,870. It lies at the head of an arm of Sligo Bay on the north-west coast, on the river Garvogue, 134¼ m. N.W. from Dublin by the Midland Great Western railway. This company shares with the Great Southern and Western and the Sligo, Leitrim, and Northern Counties railways the line to Collooney Junction, 6½ m. S., from which the former runs S. to Limerick and the latter E. to Enniskillen. The situation of Sligo is beautiful; the bay is separated from the fine Lough Gill by less than 4 m. of a richly wooded valley, with flanking hills exceeding 1000 ft. in elevation. Sligo takes rank with Galway and Limerick as one of the three principal ports of the west coast of Ireland. Regular communication by steamer is maintained with Liverpool and Glasgow, and a considerable export trade is carried on in grain, flour, pork and cattle; while coals, iron, timber and provisions are imported. There is a depth on the harbour bar of 16 ft. at low water, and there are commodious quays and basins. Harbour commissioners control the port. Brewing, flour-milling and saw-milling are the

chief industries, and there is an important butter-market. Monthly fairs are held. Sligo is a centre of salmon and sea-fishing industries.

The Dominican Abbey, founded in 1252 by Maurice Fitzgerald, Lord-Justice, is one of the finest monastic ruins in Ireland. It was partly destroyed by fire in 1414 and again in 1642. Three sides of the cloisters remain, and the lofty quadrangular tower at the junction of the nave and chancel is entire. The east window is of the date of the original structure. The principal modern church is the Roman Catholic cathedral (1869) for the diocese of Elphin in the Norman style with a finely sculptured doorway. There is also a Roman Catholic college.

A castle was built at Sligo by Maurice Fitzgerald in 1242, which in 1270 was taken and destroyed by O'Donnel; in 1310 it was rebuilt by Richard, earl of Ulster, and was again partly destroyed in 1369 and 1394. Of this and the walls with which the town was fortified there are no remains. Early in the reign of James I. the town received a market and two annual fairs; in 1613 it was incorporated and received the privileges of a borough; and in 1621 it received a charter of the staple. In 1641 it was besieged by the Parliamentary forces under Sir Charles Coote, but was afterwards evacuated, and occupied by the Royalists till the termination of the war. In 1688 it declared in favour of James II., and, after being captured by the Enniskilleners, was retaken by General Sarsfield, but ultimately surrendered to the earl of Granard. The borough was disfranchised in 1870. Under the Local Government (Ireland) Act, 1898 it retains its mayor and corporation, but the latter has practically the status of an urban district council.

The country neighbouring to Sligo presents fine coast scenery, west coast of Ireland, while inland it is wild and mountainous. Three m. S.W. of the town, on Carrowmore, is a remarkable collection of megalithic remains, including cromlechs, stone circles, and burial cairns, which has been taken to mark the site of the traditional battle of North Moytura. On Knocknarea (1078 ft.), south of Sligo, is a huge cairn, which tradition sets down as the burial-place of Queen Mab (Meave of Connaught). Five m. N. of Sligo is Drumcliffe, with its round tower and Celtic cross. Rosses, on Sligo Bay, is a favourite resort. Sligo is a centre for salmon and trout fishing.

SLING (from M. Eng. *slingen*, to fling, throw with a jerk, Icel. *slyngva*, cf. Ger. *schlingen*, to twist), an implement for casting missiles, also from its resemblance in form to the implement, a hanging loop used as a support for a wounded limb, a chain with hooks used for raising or lowering heavy goods or objects, &c. The sling as a weapon is probably the earliest form of device known to mankind by which an increase of force and range was given to the arm of a thrower of missiles. Sling stones from the stone age have been frequently found (see ARMS AND ARMOUR). The form of the weapon is of two kinds; the sling proper consists of a small strap or socket of leather or hide to which two cords are attached; the slinger holds the two ends in one hand, whirls the socket and missile rapidly round the head and, loosing one cord sharply, despatches the missile; the other type is the staff sling, in which the sling itself is attached to a short staff, held in both hands. This was used for heavier missiles especially in siege operations during the middle ages. There are many references to slings and to slingers in the Bible; the left-handed slingers of Benjamin were famous (Judges xx. 16). The Assyrian monuments show the sling of the ordinary type and slingers were used in the ancient Egyptian army, but not before the 8th century B.C. The sling (Gr. *σφενδύρη*, Lat. *funda*) is not mentioned in Homer; Herodotus (vii. 158) speaks of the slingers in the army offered by Gelon to serve against the Persians; it seems to have been a weapon chiefly used by barbarian troops. The Acarnanians, however, were expert slingers (Thuc. ii. 81), and so also were the Achaeans, who later invented the sling which discharged a shaft with an iron bolt head (Livy xlii. 65, from Polybius). In the Roman army by the time of the Punic Wars the slingers (*funditores*) were auxiliaries from Greece, Syria and Africa. The Balearic islanders, who were in Hannibal's army, were always famous as slingers. In medieval times the sling was much used in the Frankish army, especially in defending trenches, while the staff-sling was used against fortifications

in the 14th century. They were used down to the 16th and 17th centuries to throw grenades.

SLIVEN, **SLIVNO** or formerly **SELIMNIA** (Turk. *Islimye*), a town of Bulgaria, in Eastern Rumelia, at the southern foot of the Balkan Mountains, 105 m. E.N.E. of Philippopolis and near the southern entrance of the defile known as the Iron Gate. Pop. (1906), 25,049. There are numerous mosques in the town, but the greater part of the Turkish population emigrated after the Russo-Turkish War of 1877-78. Sliven contains the government factory, founded in 1834, for the manufacture of military clothing; it is the chief centre in Bulgaria for the rough and fine homespun known as *aba* and *shayak*, and its wine is locally celebrated. Extensive mulberry orchards have been planted in connexion with the silk industry.

Sliven, the Stlifanos of the Byzantine writers, owed its former strategic importance to its position on one of the trans-Balkan highways to Adrianople and the south. In the middle ages it was a subject of dispute between Byzantium and Bulgaria. After its capture by the Turks (1388) it was one of the *voynik* towns which remained exempt from taxes and were allowed to elect their own *voivode*; but these privileges were lost in the 16th century. In 1829 Sliven was occupied by the Russian army under Rudiger and Gorchakov.

SLOANE, SIR HANS (1660-1753), British collector and physician, was born on the 16th of April 1660 at Killyleagh in county Down, Ireland, where his father had settled at the head of a Scotch colony sent over by James I. He had as a youth a taste for collecting objects of natural history and other curiosities. This led him to the study of medicine, which he went to London to pursue, directing his attention to botany, materia medica and pharmacy. His collecting propensities made him useful to John Ray and Robert Boyle. After four years in London he travelled through France, spending some time at Paris and Montpellier, and taking his M.D. degree at the university of Orange in 1683. He returned to London with a considerable collection of plants and other curiosities, of which the former were sent to Ray and utilized by him for his *History of Plants*. Sloane was quickly elected into the Royal Society, and at the same time he attracted the notice of Thomas Sydenham, who gave him valuable introductions to practice. In 1687 he became fellow of the College of Physicians, and proceeded to Jamaica the same year as physician in the suite of the duke of Albemarle. The duke died soon after landing, and Sloane's visit lasted only fifteen months; but during that time he got together about 800 new species of plants, the island being virgin ground to the botanist. Of these he published an elaborate catalogue in Latin in 1696; and at a later date (1707-1725) he made the experiences of his visit the subject of two folio volumes. He became secretary to the Royal Society in 1693, and edited the *Philosophical Transactions* for twenty years. His practice as a physician among the upper classes was large. In the pamphlets written concerning the sale by Dr William Cockburn (1669-1739) of his secret remedy for dysentery and other fluxes, it was stated for the defence that Sloane himself did not disdain the same kind of professional conduct; and some colour is given to that charge by the fact that his only medical publication, an *Account of a Medicine for Soreness, Weakness and other Distempers of the Eyes* (London, 1745) was not given to the world until its author was in his eighty-fifth year and had retired from practice.

In 1716 Sloane was created a baronet, being the first medical practitioner to receive an hereditary title, and in 1719 he became president of the College of Physicians, holding the office sixteen years. In 1722 he was appointed physician-general to the army, and in 1727 first physician to George II. In 1727 also he succeeded Sir Isaac Newton in the presidential chair of the Royal Society; he retired from it at the age of eighty. Sloane's memory survives more by his judicious investments than by anything that he contributed to the subject matter of natural science or even of his own profession. His purchase of the manor of Chelsea in 1712 has perpetuated his memory in the name of a "place," a street, and a square. His great stroke as a collector was to acquire (by bequest, conditional on paying off

certain debts) in 1701 the cabinet of William Courten, who had made collecting the business of his life. When Sloane retired from active work in 1741 his library and cabinet of curiosities, which he took with him from Bloomsbury to his house in Chelsea, had grown to be of unique value. On his death on the 11th of January 1753 he bequeathed his books, manuscripts, prints, drawings, pictures, medals, coins, seals, cameos and other curiosities to the nation, on condition that parliament should pay to his executors £20,000, which was a good deal less than the value of the collection. The bequest was accepted on those terms by an act passed the same year, and the collection, together with George II.'s royal library, &c., was opened to the public at Bloomsbury as the British Museum in 1759. Among his other acts of munificence may be mentioned his gift to the Apothecaries' Company of the botanical or physic garden, which they had rented from the Chelsea estate since 1673.

See Weld, *History of the Royal Society*, i. 450 (London, 1848); and Munk, *Roll of the College of Physicians*, 2nd ed., i. 466 (London, 1878).

SLOCUM, HENRY WARNER (1827-1894), American general, was born at Delphi, Onondaga county, New York, on the 24th of September 1827, and graduated at the United States Military Academy in 1852. He resigned from the army in 1856 to practise law at Syracuse, N.Y., and in 1859 he was a member of the state Assembly. When the Civil War broke out he became colonel (May 1861) of the 27th New York Volunteers, and was promoted brigadier-general of volunteers (August 1861) and major-general of volunteers (July 1862). He fought in all the Virginia campaigns from the first battle of Bull Run, where he led a regiment, to Gettysburg, where he commanded the XII. corps. With that corps he was transferred in the autumn of 1863 under Hooker's command to the Tennessee Valley, and took part in the battle of Chattanooga. He remained with the Army of the Cumberland after his corps was merged into that of Hooker, took part in the Atlanta campaign, and after Hooker's retirement succeeded to the command of the XX. corps (late XI. and XII.). He commanded the Atlanta garrison, and with Sherman took part in the "march to the sea," and subsequently in the Carolinas campaign from Savannah to Goldsboro, as commander of the left wing. He resigned from the army in September 1865, resumed professional practice at Brooklyn, and was a Democratic representative in Congress in 1869-1873 and again in 1883-1885. In 1876-1884 he was president of the Brooklyn city board of public works. He died at Brooklyn on the 14th of April 1894. A monument of General Slocum by Frederick MacMonnies was unveiled at Brooklyn, N.Y., on the 30th of May 1905.

SLODTZ, RENÉ MICHEL or **MICHEL ANGE** (1705-1764), French sculptor, was born at Paris. He passed seventeen years at Rome, where he was chosen to execute a statue of St Bruno, one of the best modern works of the class in St Peter's. He was also the sculptor of the tomb of Marquis Capponi in St John of the Florentines. Other works of his are to be seen at the church of St Louis of France and at Santa Maria della Scala. After his return to France in 1747, Slodtz, in conjunction with his brothers, Antoine Sébastien and Paul, produced many decorative works in the churches of Paris, and, though much has been destroyed, his most considerable achievement—the tomb of Languet de Gergy in St Sulpice (commissioned in 1750)—still exists. Slodtz was, like his brothers, a member of the Academy of Painting and Sculpture, and many particulars of his life are preserved in a memoir written by Cochin, and also in a letter from the same to the *Gazette littéraire*, which was reproduced by Castilhon in the *Nécrologe* of 1766.

Slodtz's father, Sébastien (1655-1726), was also a sculptor, born at Antwerp; he became a pupil of Girardon and worked mostly under him at Versailles and the Tuileries. His chief works were "Hannibal" in the Tuileries garden, a statue of St Ambrose in the Palais des Invalides, and a bas-relief "Saint Louis sending missionaries to India."

See C. N. Cochin, *Mém. inéd.* (Paris, 1881); Barbet de Jouy, *Sculpture moderne du Louvre* (Paris, 1856); Duissieux, *Artistes français à l'étranger* (Paris, 1852).

SLOGAN, the war-cry of the Highland clans. It was the gathering call of the clan, often the name of the clan, the place of meeting, and the like, and was uttered when charging in battle. The Gaelic word, of which "slogan" is the English adaptation, is *sluagh-ghairm*, from *sluagh*, army, host, and *gairm*, call, cry. A variant form of "slogan" is "slogorne," which has given rise to an invented word "slughorn," used by Chatterton (*Battle of Hastings*, ii. 10) and by Browning (*Childe Roland*) as if the term meant some kind of war-trumpet or horn. Skeat (*Etym. Dict.* 1898, *Errata and Addenda*) has shown that Chatterton used an edition of Gavin Douglas's translation of Virgil, where "slogorne" is spelled "slughorne," and the context, "The deaucht trumpet blawis the brag of were; the slughorne, enseule or the wache cry went for the battall all suld be reddy," misled him.

SLONIM, a town of Russia, in the government of Grodno, 155 m. by rail S.E. of the city of Grodno and 20 m. from the railway from Moscow to Warsaw, on the high craggy banks of the Shchara. Pop. (1883), 21,110; (1897) 15,893, including many Jews. It derives its importance from the river, which is navigable and joins the Oginsky canal, connecting the Niemen with the Dnieper. Corn, tar, and especially timber are exported. Slonim is mentioned in 1040, when Yaroslav, prince of Kiev, defeated the Lithuanians in its neighbourhood. In 1241 the Mongols pillaged it and burned its wooden fort. Owing to its position between Galician Russia and Lithuania it often changed hands, until it was conquered by the Lithuanians in the 14th century. From 1631 to 1685 it was the seat of the Lithuanian diet and became a flourishing city. In the 18th century, under the hetman Oginsky, a canal was dug to connect the Shchara with the Dnieper. Oginsky embellished the city and founded there a printing-office. Russia annexed the town in 1795.

SLOOP, a type of small sailing-vessels which have one mast rigged "fore and aft," carrying a mainsail, gaff-topsail, jib and fore staysail. There is little in rig to distinguish a sloop from a "cutter," and the terms are used indiscriminately; sometimes a distinction is drawn by a sloop having a fixed and a cutter a running bowsprit. In the sailing and early steam days of naval warfare, a "sloop" was a small corvette, ship-rigged, with all the guns mounted on the upper deck. Like so many nautical terms the word was borrowed from the Dutch, viz. *sloop*, boat. This is generally taken to be an adaptation of the Fr. *chaloupe*, Span. and Port. *chalupa*, cf. Ital. *sciapluppa*, Eng. "shallop," a light boat. These probably represent some native word borrowed by Spanish or Portuguese sailors in the East or American Indies. Other etymologists distinguish the Dutch and French words and refer *sloop* to the common Teutonic root, meaning to glide, to creep, seen in "slip," Ger. *schleifen*, *schlafen*, &c.

SLOTH, the name for the various representatives of a group of arboreal tropical American mammals belonging to the order Edentata (*q.v.*). Sloths are some of the most completely arboreal of all mammals, living entirely among the branches of trees; and usually hanging beneath them, back downwards, and clinging with the hook-line organs to which the terminations of their limbs are reduced. When obliged to descend to the ground, which they rarely, if ever, do voluntarily, sloths—owing to the unequal length of their limbs and the peculiar conformation of their feet, which allow the animals to rest only on the outer edge—crawl along a level surface with considerable difficulty. Though generally slow and inactive, even when in their natural haunts, they can on occasions travel with considerable rapidity along the branches, and as they do not leap, like most other arboreal creatures, they avail themselves of the swaying of the boughs by the wind to pass from tree to tree. They feed on leaves and young shoots and fruits, which they gather in their mouth, the fore-limbs aiding in dragging boughs within reach, but not being used as hands. When sleeping, sloths roll themselves up in a ball, and, owing to the dry shaggy character of their hair, are inconspicuous among the mosses and lichens with which the trees of their native forests abound. The concealment thus afforded is heightened in some species by the peculiar greenish tint of the hair, due not to the colour of the

hair itself, but to the presence upon its surface of an alga, the lodgment of which is facilitated by the fluted or rough surface of the exterior, and its growth is promoted by the dampness of the atmosphere in the gloomy tropical forests. Sloths are



The Unau or Two-toed Sloth (*Choloepus hoffmanni*).

nocturnal, silent, inoffensive and solitary animals, and produce usually but one young at birth. They appear to show an almost reptilian tenacity of life, surviving the most severe injuries and large doses of poisons, and exhibiting longer persistence of irritability of muscular tissue after death than other mammals. Several other animals, such as the African potto-lemurs, and the Asiatic lorises, are popularly called sloths.

SLOUGH, a market town in the Wycombe parliamentary division of Buckinghamshire, England, 18 m. W. of London by the Great Western railway. Pop. of urban district (1901), 11,453. It lies in the flat valley of the Thames, nearly 2 m. from the river at Eton and Windsor, and is wholly modern in appearance. The chief public building is the Leopold Institute and Public Hall (1887), a memorial of Prince Leopold, Duke of Albany. The British Orphan Asylum is also in the town. The parish church of Upton-cum-Chalvey, St Laurence, has a Norman doorway and other portions of the same period. It is the burial-place of Sir William Herschel, who lived in the vicinity, set up his great telescope here, and made many of his astronomical discoveries.

SLOVAKS (*Slovák*, fem. *Slovenka*, adj. *slovenský*, formerly called *Slovene*, but to be distinguished from the Slovenes of Carinthia, in Magyar *Tót*), a Slav people numbering about 2,500,000 and mostly living in the northern counties of Hungary. On the west they extend into the neighbouring districts of Lower Austria and Moravia where they march with the Germans and the kindred Moravians, being bounded by the river Morava and the Jablunka Mountains; on the north they touch the Poles along the frontiers of Silesia and Galicia; on the east about 22° E. they meet the Little Russians along an indented boundary; on the south they have the Magyars as neighbours along a line joining Pressburg and Zemplín. Within these limits, save for the Germans in the towns, the Slovaks are not much mixed: they have isolated settlements throughout the western half of Hungary extending far enough south to meet similar settlements of Servians. Their chief centre is S. Marton on the Turocz. The Slovaks seem to have occupied this territory in the 5th or 6th century A.D. and also to have stretched far to the south; they formed part of Samo's empire (middle of 7th century), but were subject to the Avars and the Franks, and then formed part of Great Moravia until that kingdom was in 907 conquered by the Magyars, who displaced or assimilated the southern Slovaks and have ever since been lords of the rest, save for a short time when they were under Boleslav the Brave (A.D. 973) of Poland, and early in the 14th century when a local

magnate, Count Matthew of Trenčín, made himself an independent ruler. In 1848–1849, when the Magyars rose against Austria, the Slovaks rose against the Magyars, but were handed back to them on the conclusion of peace. The Magyars have always treated the Slovaks as an inferior race and have succeeded in assimilating many districts where the prefix *Tót* in place-names shows the former presence of Slovaks: those who take the Magyar language and attitude are called Magyarones. The Magyars, in pursuance of this policy, do their best to suppress the Slovak nationality in every way, even to the extent of taking away Slovak children to be brought up as Magyars, and denying them the right to use their language in church and school. The result is a large emigration to America. (See letters by Scotus Viator in *Speclator*, 1906 sqq.)

The Slovaks are a peaceful, rather slow race or peasants (their aristocracy is Magyarized), living almost exclusively upon the land, which they till after the most primitive methods. Where this does not yield sufficient, they wander as labourers and especially as tinkers all over Austria-Hungary and even into South Russia. They are fond of music, and their songs have been collected.

The Slovak language is most closely connected with Čech, the difference being bridged by the transitional dialects of Moravia: though Miklosich has classed it as a variety of Čech, it is better to take it separately, since it has not been subjected to the special changes which have in that language assimilated the vowels to the foregoing palatal consonants, nor developed the *ř* which is characteristic of the other North-Western Slavonic tongues, but has remained in a more primitive stage and preserved (as might be expected from its central position in the Slavonic world) many points of agreement, phonetic, morphological and lexical, with South Slavonic and Russian. The alphabet is founded on the Čech, the accent is always on the first syllable, long vowels are indicated by acute accents. There are usually reckoned to be three groups of dialects, Western, Central and Eastern; the first being nearest to Čech, the last to Little Russian; the Central dialects exhibit less decided features. The Slovak dialects spoken in Moravia have been well investigated by Bartoš, the others still await satisfactory treatment, as does the question of the relation of Slovak to other Slavonic groups.

From the time of the Hussites and still more after the Reformation, Čech missionaries, colonists and refugees had brought with them their Bible and service books; Čech became the literary language, and is still the church language of the Slovak Protestants. The use of the local tongue was the result of a desire on the part of the Roman Catholic clergy to get at their people. A. Bernolák (1762–1813), who first systematized the orthography and made a dictionary, taking Western Slovak as his basis, was a priest, and so was Jan Holly (1785–1849), who wrote epics and odes in the classical taste. A new start was made in the 'forties by L'udevít Štúr, Josef Hurban and M. Hodža who adopted the central dialect, united the Catholic and Protestant Slovaks in its use and successfully opposed the attempts to keep the Slovaks to the use of Čech. However, Safářík the great Slavist and the poet Kollár continued to write in Čech, the argument being that Slavs should unite to oppose the enemies of the race: but without their language the Slovaks, having no traditions of independent political life, would have nothing to cling to. The chief Slovak writers since Štúr (mostly poets) have been O. Sladkovič, S. Chalupka, V. Paulíný-Tót, and at present Ország-Hviezdoslav and Svetozár Hurban-Vajanský. During the 'sixties the Slovaks founded three gymnasia and a *Matica*, or literary, linguistic and educational society, such as has been the centre of revival for the national life of other Slavonic nations. These were all closed and their property confiscated by the Magyars in the early 'seventies, but the struggle continues, and national self-consciousness is too strong for the attempts at Magyarization to have much probability of success.

BIBLIOGRAPHY.—R. W. Seton-Watson, *Racial Problems in Hungary: a History of the Slovaks* (1909), gives all that can be required, with special chapters on Popular Art, Poetry and Music by D. Jurkovič the architect, S. Hurban-Vajanský and M. Lichard the composer. See also T. Čapek, *The Slovaks* (New York, 1906); Dr E. Stodola, *Prispevek ku Statistike Slovenska* (contribution to statistics of Slovakia) (Turocz S. Marton, 1902); Fr. Sasinek, *Die Slovaken* (Prague, 1875); S. Czambel, in *Die österreichische Monarchie in Wort und Bild; Ungarn*; vol. v. pp. 434 sqq. (Vienna); K. Kálal, *Die Unterdrückung der Slovaken* (Prague, 1903); J. Borbis, *Die evangelisch-lutheranische Kirche Ungarns* (Nordlingen, 1861), gives the religious history; J. Vlček, *Dejiny Literatúry Slovenskej* (history of Slovak literature) (Turocz S. Marton, 1889; Russian trans., Kiev, 1889); *Sborník Slovenských Národních písní* (collection of Slovak Popular Songs, &c.), published by the *Matica* (1870–1874); *Slovenské Spevy* (Slovak Ballads) (Tur. S. Mart., 1882); D. Jurkovič, *Les Ouvrages populaires des Slovaques*, text in Čech, headings in French (Vienna, 1906); J. Loos, *Wörterbuch der slovakischen, ungarischen*

und magyarischen Sprache (Budapest, 1871); L. Štúr, *Nauka reči Slovenskej* (Science of Slovak Speech) (Pressburg, 1846); J. Victorin, *Grammatik der slovakischen Sprache* (Practical) (Budapest, 1878); S. Czambel, *Prispevky k dejinám jazyka Slovenského* (Budapest, 1887); *Rukovät Spisovnej reči Slovenskej* (Handbook of Literary Slovak) (Tur. S. Mart., 1902); *Slováci a ich reč* (Slovaks and their speech) (Budapest, 1903), cf. a review in *Archiv f. Slav. Phil.* xxvi. p. 290; Fr. Pastrnek, *Beiträge zur Lautlehre der slovakischen Sprache* (Vienna, 1888); Fr. Barto, *Dialektologie Moravská* with specimens (Brünn, 1886); A. Sembera, *Základové Dialektologie Čecho-slovenské* (Foundations of Čecho-Slovak Dialectology) (Vienna, 1864).

(E. H. M.)

SLOVENES [*Slovinci*, Ger. *Winden*, to be distinguished from the Slovaks (*q.v.*) and from the Slovinci (see KASHUBES) west of Danzig], a Slavonic people numbering about 1,300,000. The chief mass of them lives in Austria, occupying Carniola (Krajina, Krain), the southern half of Carinthia (Chorutania, Koroško, Kärnten) and Styria (Stajersko, Steiermark) and some of the northern part of Istria; a small division of them is found over the Italian border in the vale of Resia; others in the extreme south-west of Hungary. Their neighbours on the south-west are Italians, on the west and north Germans: history and place-names point to Slovenes having formerly held parts of Tirol, Salzburg and Austria Proper; and on the east they have given up south-west Hungary to the Magyars; to the south they have the kindred race of the Croats. The boundary on this side is difficult to fix, as the transition is gradual and a certain dialect of Croatian (marked by the use of *kaj* = "what") is by some considered to have been originally Slovene (see CROATIA-SLAVONIA). Even within the limits above defined the Slovenes are much mixed with Germans, especially in the towns; only in Carniola are they fairly solid. Here they call themselves *Krajinci* rather than Slovenes, in fact everywhere the general term gives place to local names, because the race is so much split up geographically, dialectically and politically that consciousness of unity is of rather recent growth. The main intellectual centre has been Laibach (Ljubljana) and next to it Klagenfurt (Celovec); in Graz (Gradec) the German element, and in Görz (Gorica) the Italian, predominates.

The Slovenes arrived in these parts in the 7th century, apparently pressed westwards by the Avars. By A.D. 595 they were already at war with the Bavarians, later they formed part of Samo's great Slavonic empire and were not quite out of touch with other Slavs. On its collapse they fell under the yoke of the Bavarians and Franks. At first they had their own princes, but in time these gave place to German dukes and margraves, who had, however, to use the native tongue on certain occasions. These fiefs of the empire finally fell to the Habsburgs and never gave them any trouble, hence their language has had freer play than that of most of the Austrian Slavs: they have been allowed to use it in primary and secondary schools and to some extent in local administration. The Slovenes were very early (beginning with the 8th century) Christianized by Italian and German missionaries; to them we owe the Freisingen fragments, confessions and part of a sermon, the earliest monuments, not merely of Slovene but of any Slavonic. The MS. dates from c. 1000, but the composition is older. The language is not pure Slovene, but seems to be an adaptation of an Old Slavonic translation. Yet it is enough to show that Old Slavonic is not Old Slovene. Kocel, a prince on the Platten See, to whom Cyril and Methodius (see SLAVS) preached on their way to Rome, was probably a Slovene, but no traces of their work survive in this quarter. Except for a few 15th-century prayers and formulae we do not find any more specimens of Slovene until the Reformation, when Primus Truber translated a catechism, the New Testament and other works (Tübingen, 1550–1582), and J. Dalmatin issued a splendid Bible (Wittemberg, 1584), with an interesting vocabulary to make his work intelligible to any Slovene or Croat: at the same time and place A. Bohorizh (*zh*=*ž*) issued a good grammar (*Arcticae Horulae*, &c.). To counteract this the Roman Catholics translated the work of their English apologist Stapleton, but their final policy was to burn all the Slovene books they could find, so that these are extremely rare. The policy was successful and only about 15% of the

Slovenes are Protestants. Slovene woke to a new life in the latter part of the 18th century. Valentin Vodnik was the first poet (see *Arch. f. Slav. Phil.* (1901), xxiii. 386, xxiv. 74), but his successor France Prešeren (1800–1849) appears to have been really great, worthy of a larger circle of readers. Other poets have been A. Jancžič, S. Gregorčič and Murn-Aleksandrov; Erjavec was a story-teller, Jurčič a novelist, but as usual with these beginnings of literature the same man may make a grammar, issue an almanack, and try all kinds of poetry. The two great Slavists Kopitar and Miklosich were Slovenes, but were led astray by race feeling to insist upon Old Slavonic being Old Slovene. They were succeeded by G. Krek and V. Oblak.

The chief centres of Slovene letters are the *Matica* or Linguistic and Literary Society and the Lyceum at Laibach. The *Matica* publishes a chronicle (*Letopis*) and there are many periodicals, chief of which are the *Ljubljansky Zvon* and *Kres*, the latter published at Klagenfurt. The liberal and clerical organs carry on a lively polemic.

The Slovene language is the most westerly of the South Slavonic group. It is very closely allied to Serbo-Croatian, but shows some points of resemblance to Čech (retaining *dl* and *tl*, loss of aorist, &c.). It is split into eight dialects which differ among themselves widely. The people of Resia are sometimes classed quite apart. In phonetics Slovene is remarkable for the change of the original *tj dj* into *č* and *j* (our *y*) respectively, of *ž* into *u*, and for the coincidence of the old half vowels *i* and *ü* in a dull *e*. In morphology it has retained the dual of both nouns and verbs more perfectly than any other living language, also the supine and several periphrastic tenses: it has lost its aorist and imperfect, and its participles have mostly been fixed as so-called gerunds or verbal adverbs. The language has suffered much from Germanisms and even developed an article which has since been purified away. There is a free accent and the accented syllables may be long or short. The Resia dialect has preserved the Proto-Slavonic accent very exactly. The Slovenes have always used the Latin alphabet more or less clumsily: recently the orthography has been reformed after the manner of Čech, but uniformity has not yet been reached.

BIBLIOGRAPHY.—J. Šuman, "Die Slovenen" in *Die Völker Österreich-Ungarns*, vol. x. (Vienna, 1881); J. Sket, *Slovenisches Sprach- und Übungsbuch* (Klagenfurt, 1888); *Slovenska Slovtovena Citanka* ("Slovene literary reading-book") (2nd ed., 1906); C. Pečnik, *Praktisches Lehrbuch der slovenischen Sprache* (Leipzig, 1890); M. Pletersnik, *Slovensko-Nemški Slovar* (Sl. Ger. Dict.) (Laibach, 1894–1895); Freisingen Fragments, best ed. V. Vondrák, *Čech Akad.*, pt. iii. (Prague, 1896); V. Oblak, many articles on Sl. Grammar in *Archiv f. slav. Philologie* (1889 sqq.); J. Baudouin de Courtenay, *Opyt fonetiki Režjanskich Govorov* ("Attempt at phonetics of the dialects of Resia," Russian) (Warsaw, 1875); K. Strekelj, *Slovenske narodne Pesmi* ("Slovene popular songs") (Laibach, 1895 sqq.). (E. H. M.)

SLUM, a squalid, dirty street or quarter in a city, town or village, inhabited by the very poor, destitute or criminal classes; over-crowding is frequently another characteristic (see **HOUSING**). The word is a comparatively recent one and is of uncertain origin. It has been doubtfully connected with a dialectal use of "slump" in the sense of a marshy, swampy place; cf. Ger. *Schlamm*, mud, and Eng. dialect *slammock*, slattern (Sket, *Etym. Dict.*, 1910).

SLUYS, BATTLE OF, fought on Saturday the 24th of June 1330, one of the two sea-fights in which King Edward III. of England commanded in person, the other being that called Espagnols-sur-Mer (*q.v.*). The place of the encounter was in front of the town of Sluis, Sluys, or in French Écluse, on the inlet between West Flanders and Zeeland. In the middle of the 14th century this was an open roadstead capable of holding large fleets. It has now been silted up by the river Eede. A French fleet, which the king, in a letter to his son Edward the Black Prince, puts at 190 sail, had been collected in preparation for an invasion of England. It was under the command of Hue Quiéret, admiral for the king of France, and of Nicholas Béhuchet, who had been one of the king's treasurers, and was probably a lawyer. Part of the fleet consisted of Genoese galleys serving as mercenaries under the command of Barbavera. Although English historians speak of King Edward's fleet as inferior in number to the French, it is certain that he sailed from Orwell on the 22nd of June with 200 sail, and that he was joined on the coast of Flanders by his admiral for the North Sea, Sir Robert Morley, with 50 others. Some of this swarm of vessels were no

doubt mere transports, for the king brought with him the household of his queen, Philippa of Hainault, who was then at Bruges. As, however, one of the queen's ladies was killed in the battle, it would appear that all the English vessels were employed. Edward anchored at Blankenberghe on the afternoon of the 23rd and sent three squires to reconnoitre the position of the French. The Genoese Barbavera advised his colleagues to go to sea, but Béhuchet, who as constable exercised the general command, refused to leave the anchorage. He probably wished to occupy it in order to bar the king's road to Bruges. The disposition of the French was made in accordance with the usual medieval tactics of a fleet fighting on the defensive. Quiéret and Béhuchet formed their force into three or four lines, with the ships tied to one another, and with a few of the largest stationed in front as outposts. King Edward entered the roadstead on the morning of the 24th, and after manœuvring to place his ships to windward, and to bring the sun behind him, attacked. In his letter to his son he says that the enemy made a noble defence "all that day and the night after." His ships were arranged in two lines, and it may be presumed that the first attacked in front, while the second would be able to turn the flanks of the opponent. The battle was a long succession of hand-to-hand conflicts to board or to repel boarders. King Edward makes no mention of any actual help given him by his Flemish allies, though he says they were willing, but the French say that they joined after dark. They also assert that the king was wounded by Béhuchet, but this is not certain, and there is no testimony save a legendary one for a personal encounter between him and the French commander, though it would not be improbable. The battle ended with the almost total destruction of the French. Quiéret was slain, and Béhuchet is said to have been hanged by King Edward's orders. Barbavera escaped to sea with his squadron on the morning of the 25th, carrying off two English prizes. English chroniclers claim that the victory was won with small cost of life, and that the loss of the French was 30,000 men. But no reliance can be placed on medieval estimates of numbers. After the battle King Edward remained at anchor several days, and it is probable that his fleet had suffered heavily.

AUTHORITIES.—The story of the battle of Sluys is told from the English side by Sir Harris Nicolas, in his *History of the Royal Navy*, vol. ii. (London, 1847); and from the French side by M. C. de la Roncière, *Histoire de la marine française*, vol. i. (Paris, 1899). Both make copious references to original sources. (D. H.)

SLYPE, a variant of "slip" in the sense of a narrow passage; in architecture, the name for the covered passage usually found in monasteries between the transept and the chapter-house, as at Winchester, Gloucester, Exeter and St Albans.

SMACK, a general term for a small decked or half-decked vessel, sailing under various rigs and used principally for fishing. The word, like so many sea terms, was borrowed from the Dutch, where *smak*, earlier *smacke*, is the name of a coasting vessel; it is generally taken as a corruption of *snack*, cf. Swed. *snäcka*, Dan. *snackke*, a small sailing-vessel, and is to be referred to the root seen in "snake," "snail," the original meaning a gliding, creeping thing. "Smack," taste, and "smack," a smart sounding blow or slap, also used of the sound of the lips in kissing or tasting, must be distinguished. In the first case the word is in O.E. *smaec* and is common to Teutonic languages, cf. Dan. *smag*, Ger. *schmecken*, &c.; the second word is onomatopoeic, cf. "smash," and is also found in other Teutonic languages. It is not connected with the word meaning "taste," though no doubt confused owing to the sense of smacking the lips.

SMALL ISLES, a parish of islands of the Inner Hebrides, Inverness-shire, Scotland. It consists of the islands of Canna, Sanday, Rum, Eigg and Muck, lying, in the order named, like a crescent with a trend from N.W. to S.E., Canna being the most northerly and Muck the most southerly. They are separated from Skye by Cuillin Sound and from the mainland by the Sound of Ardnamurchan. The surface is moorland, pasture and mountain. They are rich in sea-fowl, the most common being the eider duck, puffin, Manx shearwater, black

guillemot, kittiwake and herring gull. The fisheries include cod, ling and herring. The rainfall amounts to 56 in. for the year, and the temperature is fairly high, the mean for the year being $47^{\circ} 5' F$. Steamers call at Eigg at regular intervals and less often at Rum and Canna. Canna (pop. 49), an island of basaltic rock, is situated about 10 m. from the nearest point of Skye, and measures $4\frac{1}{2}$ m. from E. to W. and $1\frac{1}{4}$ m. from N. to S. Potatoes, barley and a little oats are grown, and the pasture being good the cattle are larger than most of the Hebridean breeds. The harbour is screened from south-westerly gales by the isle of Sanday. The antiquarian remains include a weather-worn sculptured stone cross and the ruins of a chapel of St Columba. Compass Hill (450 ft.) on the E. is so named from the alleged disturbance of the compasses of vessels passing within its sphere of influence. Sanday (pop. 44), another basaltic island, lies close to the S.E. of Canna. It measures $1\frac{3}{4}$ m. from E. to W. and $3\frac{1}{4}$ m. from N. to S. Some $3\frac{3}{4}$ m. S.E. of Canna is the island of Rum (pop. 149), which is situated $8\frac{1}{2}$ m. from the nearest point of Skye, and measures $8\frac{1}{2}$ m. N. to S. and 8 m. from E. to W. Geologically, its northern half is composed of Torridonian sandstone, with basalt at points between the West coast and the centre, of gabbro in the south-east, with a belt of gneissose rocks on its east seaboard and of quartz-porphry in the south-west. It is mountainous in the south. Among the higher peaks are Askival (2659 ft.), Ashval (2552), Sgor-nan-Gillean (2503) and Allival (2368). On the north-west shore is a cliff where bloodstones are quarried. The mountains are a haunt of red deer. The harbour of the village of Kinloch, at the head of Loch Sresort, is resorted to during gales from the N.W. and S. Fully 4 m. S.E. and $7\frac{1}{2}$ m. from the nearest point of the mainland lies the island of Eigg, or Egg (pop. 211), measuring from N. to S. 5 m. and from E. to W. $3\frac{1}{2}$ m. It is in the main basaltic, but a band of quartz-porphry runs from the centre in a north-westerly direction to the coast, and there is some oolitic rock on the north shores. On the north-east coast is a cave with a narrow mouth, opening into a hollow 255 ft. long. In it Macleod of Skye, towards the end of the 16th century, ordered 200 Macdonalds, inhabitants of the isle—men, women and children—to be suffocated, their bones being found long afterwards. The people are chiefly engaged in fisheries and cattle-rearing. Three m. S.W. is the island of Muck (pop. 42), which is about $1\frac{1}{3}$ m. long by $2\frac{1}{3}$ m. broad and lies fully 5 m. from the nearest point of Ardnamurchan. It is almost wholly basaltic, but has some oolite at the head of the bay on its north side.

SMALLPOX, or *VARIOLA (varus, "a pimple")*, an acute infectious disease characterized by fever and by the appearance on the surface of the body of an eruption, which, after passing through various stages, dries up, leaving more or less distinct cicatrices. (For pathology see PARASITIC DISEASES.) Few diseases have been so destructive to human life as smallpox, and it has ever been regarded with horror alike from its fatality, its loathsome accompaniments and disfiguring effects, and from the fact that no age and condition of life are exempt from liability to its occurrence. Although in most civilized countries its ravages have been greatly limited by the protection afforded by vaccination, yet epidemic outbreaks are far from uncommon, affecting especially those who are unprotected, or whose protection has become weakened by lapse of time.

Much obscurity surrounds the early history of smallpox. It appears to have been imported into Europe from Asia, where it had been known and recognized from remote antiquity. The earliest accounts of its existence reach back to the middle and end of the 6th century, when it was described by Procopius and Gregory of Tours as occurring in epidemic form in Arabia, Egypt and the south of Europe. In one of the narratives of the expedition of the Abyssinians against Mecca (c. 550) the usual miraculous details are combined with a notice of smallpox breaking out among the invaders.¹ Not a few authorities, however,

regard these accounts as referring not to smallpox, but to plague. The most trustworthy statements as to the early existence of the disease are found in an account by the 9th-century Arabian physician Rhazes, by whom its symptoms were clearly described, its pathology explained by a humoral or fermentation theory, and directions given for its treatment. During the period of the Crusades smallpox appears to have spread extensively through Europe, and hospitals for its treatment were erected in many countries. But at this period and for centuries afterwards the references to the subject include in all likelihood other diseases, no precise distinction being made between the different forms of eruptive fever. Smallpox was known in England as early as the 13th century, and had probably existed there before. It appears to have been introduced into America by the Spaniards in the early 16th century, and there, as in Europe and throughout the known world, epidemics were of frequent occurrence during succeeding centuries.

The only known factor in the origin of smallpox is contagion—this malady being probably the most contagious of all diseases. Its outbreak in epidemic form in a locality may frequently be traced to the introduction of a single case from a distance. The most direct means of communicating smallpox is inoculation. By far the most common cause of conveyance of the disease, however, is contact with the persons or the immediate surroundings of those already affected. The atmosphere around a smallpox patient is charged with the products of the disease, which likewise cling to clothing, furniture &c. The disease is probably communicable from its earliest manifestations onwards to its close, but it is generally held that the most infectious period extends from the appearance of the eruption till the drying up of the pustules. Smallpox may also readily be communicated by the bodies of those who have died from its effects. No age is exempt from susceptibility to smallpox. Infants are occasionally born with the eruption or its marks upon their bodies, proving that they had undergone the disease *in utero*. Dark-skinned races are said to suffer more readily and severely than whites. One attack of smallpox as a rule confers immunity from any recurrence, but there are numerous exceptions to this rule. Overcrowding and all insanitary surroundings favour the spread of smallpox where it has broken out; but the most influential condition of all is the amount of protection afforded to a community by previous attacks and by vaccination (*q.v.*). Such protection, although for a time most effectual, tends to become exhausted unless renewed. Hence in a large population there is always likely to be an increasing number of individuals who have become susceptible to smallpox. This probably explains its occasional and even apparently periodic epidemic outbreaks in large centres, and the well-known fact that the most severe cases occur at the beginning—those least protected being necessarily more liable to be first and most seriously attacked.

Symptoms.—While the symptoms of smallpox are essentially the same in character in all cases, they are variously modified according to the form which the disease may assume, there being certain well-marked varieties of this as of most other infectious maladies. The following description applies to an average case. After the reception into the system of the smallpox contagion the onset of the symptoms is preceded by a period of incubation, during which the patient may or may not complain. This period is believed to be from about ten to fourteen days. In cases of direct inoculation of the virus it is considerably shorter. The invasion of the symptoms is sudden and severe, in the form of a rigor followed by fever (the *primary fever*), in which the temperature rises to 103° or 104° Fahr. or higher, notwithstanding that perspiration may be going on. A quick pulse is present, together with thirst and constipation, while intense headache accompanied with vomiting and pain in the back is among the most characteristic of the initial symptoms. Occasionally the disease is ushered in by convulsions. These symptoms continue with greater or less intensity throughout two entire days, and during their course there may occasionally be noticed on various parts of the body, especially on the lower part of the abdomen and inner sides of the thighs, a diffuse redness accompanied by

¹See Nöldeke, *Geschichte der Perser . . . aus Tabari* (Leiden, 1879), p. 218. Nöldeke thinks that this notice may be taken from genuine historical tradition, and seems to find an allusion to it in an old poem.

slight spots of extravasation (*petechiae*), the appearance somewhat resembling that of scarlet fever. These "prodromal rashes," as they are termed, appear to be more frequent in some epidemics than in others, and they do not seem to have any special significance. They are probably more frequently seen in cases of the mildest form of smallpox (formerly termed varioloid), referred to below as modified smallpox. On the third day the characteristic eruption begins to make its appearance. It is almost always first seen on the face, particularly about the forehead and roots of the hair, in the form of a general redness; but upon this surface there may be felt by the finger numerous elevated points more or less thickly set together. The eruption, which is accompanied by heat and itching, spreads over the face, trunk and extremities in the course of a few hours—continuing, however, to come out more abundantly for one or two days. It is always most marked on the exposed parts; but in such a case as that now described the individual "pocks" are separated from each other (discrete). On the second or third day after its appearance the eruption undergoes a change—the pocks becoming vesicles filled with a clear fluid. These vesicles attain to about the size of a pea, and in their centre there is a slight depression, giving the characteristic umbilicated appearance to the pock. The clear contents of these vesicles gradually become turbid, and by the eighth or ninth day they are changed into pustules containing yellow matter, while at the same time they increase still further in size and lose the central depression. Accompanying this change there are great surrounding inflammation and swelling of the skin, which, where the eruption is thickly set, produce much disfigurement and render the features unrecognizable, while the affected parts emit an offensive odour, particularly if, as often happens, the pustules break. The eruption is present not only on the skin, but on mucous membranes, that of the mouth and throat being affected at an early period; and the swelling produced here is not only a source of great discomfort, but even of danger, from the obstruction thus occasioned in the upper portion of the air-passages. The voice is hoarse and a copious flow of saliva comes from the mouth. The mucous membrane of the nostrils is similarly affected, while that of the eyes may also be involved, to the danger of permanent impairment of sight. The febrile symptoms which ushered in the disease undergo marked abatement on the appearance of the eruption on the third day, but on the eighth or ninth, when the vesicles become converted into pustules, there is a return of the fever (*secondary* or *suppurative fever*), often to a severe extent, and not infrequently accompanied by prominent nervous phenomena, such as great restlessness, delirium or coma. On the eleventh or twelfth day the pustules show signs of drying up (desiccation), and along with this the febrile symptoms decline. Great itching of the skin attends this stage. The scabs produced by the dried pustules gradually fall off and a reddish brown spot remains, which, according to the depth of skin involved in the disease, leaves a permanent white depressed scar—this "pitting" so characteristic of smallpox being specially marked on the face. Convalescence in this form of the disease is as a rule uninterrupted.

Varieties.—There are certain varieties of smallpox depending upon the form it assumes or the intensity of the symptoms. *Confluent smallpox* (*variola confluens*), while essentially the same in its general characters as the form already described, differs from it in the much greater severity of all the symptoms even from the onset, and particularly in regard to the eruption, which, instead of showing itself in isolated pocks, appears in large patches run together, giving a blistered aspect to the affected skin. This confluent condition is almost entirely confined to the face, and produces shocking disfigurement, while subsequently deep scars remain and the hair may be lost. The mucous membranes suffer in a similar degree of severity, and dangerous complications may arise from the presence of the disease in the mouth, throat and eyes. Both the primary and secondary fevers are extremely severe. The mortality is very high, and it is generally estimated that at least 50% of such cases prove fatal, either from the violence of the disease or from one or other of the numerous complications which are specially apt to attend

upon it. Convalescence is apt to be slow and interrupted. Another variety is that in which the eruption assumes the *haemorrhagic* form owing to bleeding taking place into the pocks after their formation. This is apt to be accompanied with haemorrhages from various mucous surfaces (particularly in the case of females), occasionally to a dangerous degree and with symptoms of great prostration. Many of such cases prove fatal. A still more serious form is that termed *malignant, toxic or purpuric smallpox*, in which there is intense streptococcus septicaemia, and the patient is from the onset overwhelmed with the poison and quickly succumbs—the rash scarcely, if at all, appearing or showing the haemorrhagic or purpuric character. Such cases are, however, comparatively rare. The term *modified smallpox* is applied to cases occurring in persons constitutionally but little susceptible to the disease, or in whom the protective influence of vaccination or a previous attack of smallpox still to some extent exists. Cases of this mild kind are of very common occurrence where vaccination has been systematically carried out. As compared with an average case of the unmodified disease as above described this form is very marked, the differences extending to all the phenomena of the disease. (1) As regards its onset, the initial fever is much milder and the premonitory symptoms altogether less in severity. (2) As regards the eruption, the number of pocks is smaller, often only a few and mostly upon the body. They not infrequently abort before reaching the stage of suppuration; but should they proceed to this stage the secondary fever is extremely slight or even absent. There is little or no pitting. (3) As regards complications and injurious results, these are rarely seen and the risk to life is insignificant.

Various circumstances affect the mortality in ordinary smallpox and increase the dangers attendant upon it. The character of the epidemic has an important influence. In some outbreaks the type of the disease is much more severe than in others, and the mortality consequently greater.

In 1901 and 1903 there were epidemics in the United States in which it was only 2%. The mortality in the Philadelphia epidemic is given by Welch and Schamberg as 26.89% in 7204 cases, while in the Glasgow epidemic of 1900-1901, it reached 51.6% in the unvaccinated and 10.4% in the vaccinated. Below are some particulars of the annual death rate.

Smallpox Death Rate, England and Wales.

Years.	Number of Deaths from Smallpox.*	Deaths from Smallpox to every Million living.
1902	2464	75
1903	760	23
1904	507	15
1905	116	4
1906	21	0.6
1907	10	0.3
1908	12	0.3

*Deaths entered as being from chicken-pox are not included, though many are probably due to the graver disease.

Smallpox is most fatal at the extremes of life, except in the case of vaccinated infants, in whom there is immunity from the disease. Again, any ordinary case with discrete eruption is serious, and a case of confluent or even semi-confluent character is much more grave, while the haemorrhagic variety is frequently, and the toxic always, fatal. Numerous and often dangerous complications, although liable to arise in all cases, are more apt to occur in the severer forms, and in general at or after the supervention of the secondary fever. The most important are inflammatory affections of the respiratory organs, such as bronchitis, pleurisy or pneumonia, diphtheritic conditions of the throat, and swelling of the mucous membrane of the larynx and trachea. Destructive ulceration affecting the eyes or ears is a well-known and formidable danger, while various affections of the skin, in the form of erysipelas, abscess or carbuncles, are of not infrequent occurrence.

The prophylaxis of smallpox depends on successful vaccination and re-vaccination (see VACCINATION), together with the establishment of smallpox hospitals for the treatment of the disease when it has broken out, to which the patient should be at once removed, and those who have been in contact with the patient should be promptly re-vaccinated. The efficiency of the

protection given by vaccination and systematic re-vaccination is demonstrated by the almost entire suppression of the disease in

Germany (see Dr Bruce Low's *Report to the Local Government Board*, 1903-1904). Mrs Garrett Anderson, writing to *The Times* in September 1903, showed the enormous expense laid on the rates in England for the maintenance of smallpox hospitals in order to counteract inefficient vaccination. London with a population of $6\frac{1}{2}$ millions reserves 2500 beds in a hospital removed from the city; Berlin with a population of 2 millions reserves 12 beds in the pavilion of a general hospital; Dresden with a population of 500,000 reserves 20 beds in the Friedrichstadt Hospital, but no case was admitted for 10 years previous to the Report. In Stuttgart (population 200,000) a hut of six beds is set aside for smallpox, but it has fallen into bad repair from disuse. Smallpox cases in Germany are usually sporadic cases introduced by foreigners. Where persons have been exposed to the infection of smallpox, if immediate vaccination fails to protect them from the disease, it has been shown to considerably modify the type. The plan of identification and surveillance of all contact cases has given good results. In the Bristol epidemic of 1908 there were 35 cases and 9 deaths. The contacts numbered 1354, and 16,398 visits of inspection were paid.

The patient should lie on a soft bed in a well-ventilated but somewhat darkened room and be fed with the lighter forms of nutriment, such as milk, soups, &c. The skin should be sponged occasionally with tepid water, and the mouth and throat washed with an antiseptic solution. In a severe case, with evidence of much prostration, stimulants may be advantageously employed. The patient should be always carefully watched, and special vigilance is called for where delirium exists. This symptom may sometimes be lessened by sedatives, such as opium, bromides or chloral. With the view of preventing pitting many applications have been proposed, but probably the best are cold or tepid compresses of light weight kept constantly applied over the face and eyes. The water out of which these are wrung may be a weak solution of carbolic or boracic acid. When the pustules have dried up the itching this produces may be much relieved by the application of oil or vaseline.

What is known as the *red light treatment*, in which the actinic or chemical rays are excluded, has been advocated by Prof. Niels Finsen of Copenhagen and others. He considers it valuable only in that it protects the pustule from the deleterious effects of light, and he and other observers claim that if resorted to early it abolishes suppuration in the pustules, lessens scarring and shortens the course of the disease. Medical opinion in England is divided as to its merit. Herbert Peck of Chesterfield, in 244 cases so treated in 1902-1905, had only 6 deaths, a mortality of 2.4%, while the case mortality during the same period was, Lancashire 5.8%, Derbyshire 6%, Cheshire 6.4%, Liverpool 2.7% and Manchester 5.6% in cases treated without red light. An interesting fact in connection with the treatment is its great antiquity in China and Japan, while in England in the middle ages smallpox patients wore red garments and lay in beds where the light filtered through red curtains.

Complications are to be dealt with as they arise, and the severer forms of the disease treated in reference to the special symptoms presented. In cases where the eruption is tardy of appearing and the attack threatens to assume the toxic form, marked benefit attends the use of the wet pack. Disinfectants should be abundantly employed in the room and its vicinity, and all clothing, &c., in contact with the patient should be exposed to the vapour of formalin. Bécclère, Thomson and Brownlee have advocated the use of the serum of immunized heifers. The dose, however, requires to be very large, being equivalent to one-fiftieth part of the body weight in adults and one-twentieth part in children.

Inoculation.—Previously to the introduction of vaccination (*q.v.*) the method of preventive treatment by what was known as inoculation had been employed. This consisted in introducing into the system—in a similar way to the method now commonly employed in vaccination—the smallpox virus from a mild case with the view of producing the disease also in a mild form in the person inoculated, and

thus affording him protection from further attack. This plan had apparently been resorted to by Eastern nations from an early period in the history of the disease. During the latter part of the Ming dynasty there was introduced into China a system of inoculation in which the method was to blow the pulverized germ-laden crusts from a small-pox pustule through a silver tube into the nostril, the left being chosen in a male, the right in a female. Inoculation was known to be extensively practised in Turkey in the beginning of the 18th century, when, chiefly through the letters of Lady Mary Wortley Montagu, it became known and was speedily adopted in England. There is no doubt, both from the statistics of the Smallpox and Inoculation Hospital, London, and from the testimony of physicians throughout the country, that this practice made a marked impression upon the fatality of the disease, and was itself attended with extremely little risk to life. The objections to it, however, were great, for, although usually conveying the smallpox in a mild form, it not infrequently took effect severely, and, while death might be averted, the disfiguring results of the disease remained. Further, each inoculated person upon whom the operation took effect became for the time being a possible source of infection to others, and in point of fact the practice tended to spread the disease and so to increase the general mortality. Although inoculation continued to be practised for a number of years subsequently to Jenner's great discovery, it gradually became displaced by vaccination, and in 1840 an Act of Parliament was passed rendering smallpox inoculation unlawful in England.

SMALRIDGE, GEORGE (1663-1719), English bishop, was born at Lichfield, where he received his early education, this being completed at Westminster school and at Christ Church, Oxford. His political opinions were largely modelled on those of his friend Francis Atterbury, with whom he was associated at Oxford and elsewhere. After being a tutor at Christ Church, he was minister of two chapels in London, and for six or seven years he acted as deputy for the regius professor of divinity at Oxford; his Jacobite opinions, however, prevented him from securing this position when it fell vacant in 1707. In 1711 he was made dean of Carlisle and canon of Christ Church, and in 1713 he succeeded Atterbury as dean of Christ Church. In the following year he was appointed bishop of Bristol, but retained his deanery. In 1715 Smalridge refused to sign the declaration against the pretender, James Edward, defending his action in his *Reasons for not signing the Declaration*. In other ways also he showed animus against the house of Hanover, but his only punishment was his removal from the post of lord almoner to the king. He died on the 27th of September 1719. The bishop was esteemed by Swift, Steele, Whiston and other famous men of his day, while Dr Johnson declared his sermons to be of the highest class. His *Sixty Sermons, preached on Several Occasions*, was published in 1726; other editions 1827, 1832, 1853 and 1862.

SMALTITE, a mineral consisting of cobalt diarsenide (CoAs₂). It crystallizes in the cubic system with the same hemihedral symmetry as pyrites; crystals have usually the form of cubes or cubo-octahedra, but are imperfectly developed and of somewhat rare occurrence. More often the mineral is found as compact or granular masses. The colour is tin-white to steel-grey, with a metallic lustre; the streak is greyish black. Hardness $5\frac{1}{2}$; specific gravity 6.5. The cobalt is partly replaced by iron and nickel, and as the latter increases in amount there is a passage to the isomorphous species chloanthite (NiAs₂). It occurs in veins with ores of cobalt, nickel, copper and silver: the best known locality is Schneeberg in Saxony. The name smaltite was given by F. S. Beudant, in 1832, because the mineral was used in the preparation of smalt for producing a blue colour in porcelain and glass. (L. J. S.)

SMART, CHRISTOPHER (1722-1771), English poet, son of Peter Smart, of an old north country family, was born at Shipbourne, Kent, on the 11th of April 1722. His father was steward for the Kentish estates of William, Viscount Vane, younger son of Lord Barnard of Raby Castle, Durham. Christopher Smart received his first schooling at Maidstone, and then at the grammar school of Durham. He spent part of his vacations at Raby Castle, and his gifts as a poet gained him the patronage of the Vane family. Henrietta, duchess of Cleveland, allowed him a pension of £40 which was paid until her death in 1742. Thomas Gray, writing to his friend Thomas Wharton in 1747, warned him to keep silence about Smart's delinquencies lest they should

come to the ears of Henry Vane (afterwards earl of Darlington), and endanger his allowance. At Cambridge, where he was entered at Pembroke College in 1739, he spent much of his time in taverns, and got badly into debt, but in spite of his irregularities he became fellow of his college, praelector in philosophy and keeper of the common chest in 1745. In November 1747 he was compelled to remain in his rooms for fear of his creditors. At Cambridge he won the Seaton prize for a poem on "one of the attributes of the Supreme Being" in 1750 (he won the same prize in 1751, 1752, 1753 and 1755); and a farce entitled *A Trip to Cambridge, or The Grateful Fair*, acted in 1747 by the students of Pembroke, was from his pen. In 1750 he contributed to *The Student, or The Oxford and Cambridge Monthly Miscellany*. During one of his visits to London he had made the acquaintance of John Newbery, the publisher, whose step-daughter, Anna Maria Carman, he married, with the result of forfeiting his fellowship in 1753. About 1752 he permanently left Cambridge for London, though he kept his name on the college books, as he had to do in order to compete for the Seaton prize. He wrote in London under the pseudonym of "Mary Midnight" and "Pent-wenzle." He had edited *The Midwife, or the Old Woman's Magazine* (1751-1753), and had a hand in many other "Grub Street" productions. Some criticisms made by "Sir" John Hill (1716?-1775) on his *Poems on Several Occasions* (1752) provoked his satire of the *Hilliad* (1753), noteworthy as providing the model for the *Rolliad*. In 1756 he finished a prose translation of Horace, which was widely used, but brought him little profit. He agreed in the same year to produce a weekly paper entitled *The Universal Visitor*, for which Samuel Johnson wrote some numbers. In 1751 Smart had shown symptoms of mental aberration, which developed into religious mania, and between 1756 and 1758 he was in an asylum. Dr Johnson visited him and thought that he ought to have been at large. During his confinement he conceived the idea of the single poem that has made him famous, "A Song to David," though the story that it was indented with a key on the panels of his cell, and shaded in with charcoal, may be received with caution. It shows no trace of morbid origin. After his release Smart produced other religious poems, but none of them shows the same inspiration. His wife and children had gone to live with friends as he was unable to support them, and for some time before his death, which took place on the 21st of May 1771, he lived in the rules of King's Bench, and was supported by small subscriptions raised by Dr Burney and other friends.

Of all that he wrote, "A Song to David" will alone bear the test of time. Unlike in its simple forceful treatment and impressive directness of expression, as has been said, to anything else in 18th-century poetry, the poem on analysis is found to depend for its unique effect also upon a certain ingenuity of construction, and the novel way in which David's ideal qualities are enlarged upon. This will be more readily understood on reference to the following verse, the first twelve words of which become in turn the key-notes, so to speak, of the twelve succeeding verses:—

"Great, valiant, pious, good, and clean,
Sublime, contemplative, serene,
Strong, constant, pleasant, wise!
Bright effluence of exceeding grace;
Best man!—the swiftness, and the race,
The peril, and the prize."

The last line is characteristic of another peculiarity in "A Song to David," the effective use of alliteration to complete the initial energy of the stanza in many instances. But in the poem throughout is revealed a poetic quality which eludes critical analysis.

From the *Poems of the late Christopher Smart* (1791) the "Song to David" (pr. 1763) was excluded as forming a proof of his mental aberration. It was reprinted in 1819, and has since received abundant praise. In an abridged form it is included in T. H. Ward's *English Poets*, vol. iii., and was reprinted in 1895, and in 1901 with an introduction by R. A. Streatfeild. Smart's other poems are included in Anderson's *British Poets*. Christopher Smart is one of Robert Browning's subjects in *The Parleyings with Certain People* (1887). See also the contributions to *Notes and Queries* of March 25th and May 6th, 1905, by the Rev. D. C. Tovey, who has read, and in some places revised, the above article.

SMART, SIR GEORGE THOMAS (1776-1867), English musician, was born in London, his father being a music-seller. He was a choir-boy at the Chapel Royal, and was educated in

music, becoming an expert violinist, organist, teacher of singing and conductor; and in 1811 he was knighted by the lord-lieutenant of Ireland, having conducted a number of successful concerts in Dublin. Sir George Smart was, from that time onwards, one of the chief musical leaders and organizers in England, conducting at the Philharmonic, Covent Garden, the provincial festivals, &c., and in 1838 being appointed composer to the Chapel Royal. He was a master of the Handelian traditions, was personally acquainted with Beethoven and a close friend of Weber, who died in his house. His church music and glees include some well-known compositions. He died in London on the 23rd of February 1867. His brother Henry (1778-1823), father of the composer Henry Smart (*q.v.*), was also a prominent musician in his day.

SMART, HENRY (1813-1879), English organist and musical composer, born in London on the 26th of October 1813, was a nephew of Sir George Smart (*q.v.*). He studied first for the law, but soon gave this up for music. In 1831 he became organist of Blackburn parish church, where he wrote his first important work, a Reformation anthem; then of St Giles's, Cripplegate; St Luke's, Old Street; and finally of St Pancras, in 1864, which last post he held at the time of his death on the 6th of July 1879, less than a month after receiving a government pension of £100 per annum. Although Smart is now known chiefly by his compositions for the organ, which are numerous, effective and melodious, if not strikingly original, he wrote many vocal works, including some of the best specimens of modern part songs. His cantata, *The Bride of Dunkerron*, was written for the Birmingham festival of 1864; *Jacob* for Glasgow, in 1873; and his opera, *Bertha*, was produced with some success at the Haymarket in 1855. In the last fifteen years of his life Smart was practically blind.

SMART, JOHN (c. 1740-1811), English miniature painter, was born in Norfolk; he became a pupil of Cosway, and is frequently alluded to in his correspondence. This artist was director and vice-president of the Incorporated Society of Artists, and exhibited with that society. He went to India in 1788 and obtained a number of commissions in that country. He settled down in London in 1797 and there died. He married Edith Vere, and is believed to have had only one son, who died in Madras in 1809. He was a little man, of simple habits, and a member of the Society of Sandemanians. Many of his pencil drawings still exist in the possession of the descendants of a great friend of his only sister. Several of his miniatures are in Australia and belong to a cadet branch of the family. His work is entirely different to that of Cosway, quiet and grey in its colouring, with the flesh tints elaborated with much subtlety and modelled in exquisite fashion. He possessed a great knowledge of anatomy, and his portraits are drawn with greater anatomical accuracy and possess more distinction than those of any miniature painter of his time.

See *The History of Portrait Miniatures*, by G. C. Williamson, vol. ii. (London, 1904). (G. C. W.)

SMEATON, JOHN (1724-1792), English civil engineer, was born at Austhorpe Lodge, near Leeds, on the 8th of June 1724. He received a good education at the grammar school of Leeds. At an early age he showed a liking for the use of mechanical tools, and in his fourteenth or fifteenth year contrived to make a turning-lathe. On leaving school in his sixteenth year he was employed in the office of his father, an attorney, but, after attending for some months in 1742 the courts at Westminster Hall, he requested to be allowed to follow some mechanical profession. He became apprentice to a philosophical instrument maker, and in 1750 set up in business on his own account. Besides improving various mathematical instruments used in navigation and astronomy, he carried on experiments in regard to other mechanical appliances, amongst the most important being a series on which he founded a paper—for which he received the Copley medal of the Royal Society in 1759—entitled *An Experimental Inquiry concerning the Native Powers of Water and Wind to turn Mills and other Machines depending on a Circular Motion*. In 1754 he made a tour of the Low Countries to study the great canal

works of foreign engineers. Already by his papers read before the Royal Society and his intercourse with scientific men his abilities as an engineer had become well known, and in 1756 application was made to him to reconstruct the Eddystone lighthouse, which had been burnt down in December of the previous year. After the completion of the new tower in 1759, Smeaton's advice was frequently sought in regard to important engineering projects, including the construction of canals (especially the Forth and Clyde canal), the drainage of fens, the designing of harbours and the repair and erection of bridges, though many of the schemes he drew up were not carried out on account of the general lack of capital. He was also employed in designing numerous waterwheels, windmills, pumps, and other mechanical appliances. A considerable portion of his time was devoted to astronomical studies and observations, on which he read various papers before the Royal Society. A year before his death he announced that he wished "to dedicate the chief part of his remaining time to the description of the several works performed under his direction," but he completed nothing more than the *Narrative of the Building of the Eddystone Lighthouse*, which had already appeared. He died at Austhorpe on the 28th of October 1792, and was buried in the old parish church of Whitkirk.

See John Holmes, *A Short Narrative of the Genius, Life and Works of the late Mr John Smeaton* (1793); and S. Smiles, *Lives of the Engineers*.

SMEDLEY, FRANCIS [FRANK] EDWARD (1818–1864), English novelist, was born at Great Marlow, Buckinghamshire, on the 4th of October 1818, a member of a Flintshire family. A cripple from his birth, he was educated privately, and contributed his first book, *Scenes from the Life of a Private Pupil*, anonymously to *Sharpe's London Magazine* in 1846–1848. His first essay proved so successful that it was expanded into *Frank Fairleigh*, and published in book-form in 1850. His next book *Lewis Arundel: or the Railroad of Life* was originally contributed to the same magazine, which he for some time edited, and was published in book-form in 1852. Of his other writings the best-known is *Harry Coverdale's Courtship* (1855). These are all capital stories, racily told. Either Hablot Knight Browne ("Phiz") or George Cruikshank supplied illustrations for most of his books. Smedley died in London on the 1st of May 1864.

SMEDLEY, WILLIAM THOMAS (1858–), American artist, was born in Chester county, Pennsylvania, of a Quaker family, on the 26th of March 1858. He worked on a newspaper, then studied engraving and art in Philadelphia, in the Pennsylvania Academy of the Fine Arts, and—after making a tour of the South Seas—in Paris under Jean Paul Laurens. He settled in New York City in 1880; in 1882 went with the Marquis of Lorne through Canada, preparing sketches for *Picturesque Canada*; and in 1905 became a member of the National Academy of Design. Most of his work was magazine and book illustration for stories of modern life, but he painted portraits and water colours, and received the Evans Prize of the American Water Color Society in 1890, and a bronze medal at the Paris Exposition of 1900.

SMELL (connected etymologically with "smoulder" and "smoke"), a sensation excited by the contact with the olfactory region (see OLFATORY ORGAN, for anatomy) of certain substances, usually in a gaseous condition and necessarily in a state of fine subdivision. The sense is widely distributed throughout the animal kingdom. The lower animals, especially those breathing in water, become cognizant of the presence of odoriferous matter near them without touch, vision or hearing, and we suppose that they do so by some sense of taste or smell, or a combination of both. In such cases smell has been appropriately termed "taste at a distance," by which is meant that particles of matter may be diffused through the water so as to come into contact with the terminal organ, and give rise to a sensation such as would have been excited had the matter from which the particles emanated come directly into contact with the nerve-endings. It is therefore of no great importance whether such sensations in humble aquatic organisms are termed taste or smell. In the

higher air-breathing animals, however, the senses are differentiated: that of taste is found at the entrance of the alimentary canal, whilst that of smell guards the opening of the respiratory tract. This view assists in the interpretation of various structures met with in the lower forms which have been fairly regarded by naturalists as olfactory organs. It has not yet been decided whether the sense of smell depends, in the first instance, on a chemical or on a physical process. All that can be said is that sensory impulses are excited when odoriferous particles come into contact with the free ends of peculiar rod-like cells found in the olfactory mucous membrane. The free olfactory surface is always covered with a thin layer of fluid, and all odoriferous matters must be dissolved in this fluid so as to reach the rod-cells. There is here an analogy with the conditions found in the sense of taste, where sapid substances must be soluble in the fluid of the mouth. The intensity of the sensation of smell depends on the size of the area of the olfactory membrane affected. No satisfactory classification of odours can be given.

The interior of the nose (see OLFATORY ORGAN and EPITHELIAL AND ENDOTHELIAL TISSUE) is divided physiologically into two portions—(1) the upper (*regio olfactoria*), which embraces the upper part of the septum, the upper turbinated

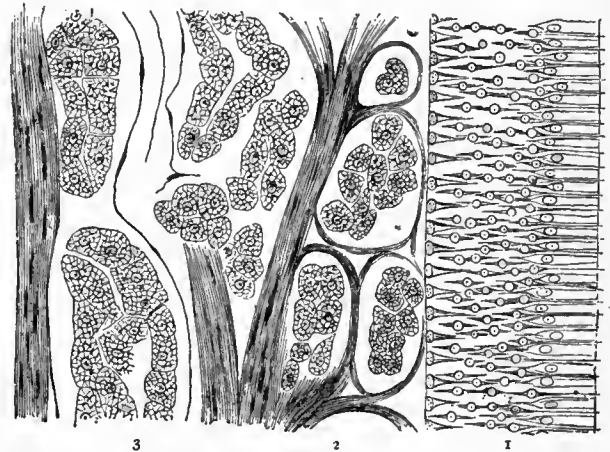

From Klein's *Atlas of Histology*.

Longitudinal section through the olfactory membrane of guinea-pig. X about 400. 1, Olfactory epithelium on free surface; 2, Plexus of olfactory nerve-fibres; 3, Pouches of serous glands containing epithelial cells.

bone, and a portion of the middle turbinated bone; and (2) the lower portion of the cavity (*regio respiratoria*). The olfactory region proper has a thicker mucous membrane than the respiratory; it is covered by a single layer of epithelial cells, often branched at their lower ends and containing a yellow or brownish red pigment; and it contains peculiar tubular glands named "Bowman's glands." The respiratory portion contains ordinary serous glands. In the olfactory region also are the terminal organs of smell. These are long narrow cells passing to the surface between the columnar epithelium covering the surface. The body of the cell is spindle-shaped and it sends up to the surface a delicate rod-like filament, whilst the deeper part is continuous with varicose nerve-filaments, the ends of the olfactory nerve.

Physical Causes of Smell.—Electrical or thermal stimuli do not usually give rise to olfactory sensations. J. Althaus states that electrical stimulation caused a sensation of the smell of phosphorus. To excite smell it is usually supposed that substances must be present in the atmosphere in a state of fine subdivision, or existing as vapours or gases. The fineness of the particles is remarkable, because if the air conveying an odour be filtered through a tube packed with cotton wool and inserted into the nose a smell is still discernible. This proceeding completely removes from the air micro-organisms less than the $\frac{1}{1000000}$ th of an inch in diameter. A grain or two of musk will scent an apartment for years and at the end of the time no appreciable loss of weight can be detected. Substances exciting smell are no doubt usually gases or vapours. Sir William Ramsay has endeavoured to connect the sense with the chemical

constitution of the substance. The following gases have no smell:—hydrogen, oxygen, nitrogen, water gas, marsh gas, olefiant gas, carbon monoxide, hydrochloric acid, formic acid vapour, nitrous oxide and ammonia. (It is necessary, of course, to distinguish between the sensation of smell and the irritant action of such a gas as ammonia.) The gases exciting smell are chlorine, bromine, iodine, the compounds of the first two with oxygen and water, nitric peroxide, vapours of phosphorus and sulphur, arsenic, antimony, sulphurous acid, carbonic acid, almost all the volatile compounds of carbon except those already mentioned, some compounds of selenium and tellurium, the compounds of chlorine, bromine and iodine with the above-named elements, and some metals. Chlorine, bromine, iodine, sulphur, selenium and tellurium, which are volatile and give off vapour at ordinary temperatures, have each a characteristic smell. Ramsay points out that as a general rule substances having a low molecular weight have either no smell or simply cause irritation of the nostrils. He also shows that in the carbon compounds increase of specific gravity as a gas is associated to a certain point with a sensation of smell. Take the marsh gas or methane series commonly called the paraffins. The first two have no smell; ethane (fifteen times as heavy as hydrogen) has a faint smell; and it is not till butane (thirty times heavier than hydrogen) that a distinct sensation of smell is noticed. Again, a similar relation exists among the alcohols. Methyl alcohol has no smell. Ethyl, or ordinary alcohol free from ethers and water, has a faint smell; “and the odour rapidly becomes more marked as we rise in the series, till the limit of volatility is reached, and we arrive at solids with such a low vapour tension that they give off no appreciable amount of vapour at the ordinary temperature.” Acids gain in odour with increase in density in the form of gas. Thus formic acid is devoid of smell; acetic acid has a characteristic smell; and the higher acids of the series—propionic, butyric, valerianic—increase in odour. It would appear also that “the character of a smell is a property of the element or group which enters into the body producing the smell, and tends to make it generic.” Many compounds of chlorine, hydrogen, compounds of sulphur, selenium and tellurium, the paraffins, the alcohols, the acids, the nitrites, the amines, the pyridine series, the benzene group, have each a characteristic odour. To produce the sensation of smell a substance must have a molecular weight at least fifteen times that of hydrogen. For instance, the specific gravity of marsh gas is eight (no smell), of ethane fifteen (faint smell), of propane twenty-two (distinct smell). Again prussic acid has a specific gravity of fifteen, and many persons fail to detect its odour. There is a relation between the molecular weight of a gas and the presence or absence of odour. Gases of less than a certain molecular weight are odourless, and it is significant that to some persons hydrocyanic acid, which has a low molecular weight, gives rise to no sensation of smell. It has also been pointed out by J. B. Haycraft that chemical compounds of elements belonging to the same group, according to the well-known periodic law of Mendéleeff, have sometimes odours of a similar character (see article “Smell,” Schäfer’s *Physiology*, vol. ii. p. 1254). T. Graham pointed out that odorous substances are in general readily oxidized. J. Tyndall showed that many odorous vapours have a considerable power of absorbing heat. Taking the absorptive capacity of the air as unity, the following absorptions were observed in the respective cases:—

Name of Perfume.	Absorption per 100.	Name of Perfume.	Absorption per 100.
Patchouli	30	Lavender	60
Sandal-wood . . .	32	Lemon	65
Geranium	33	Portugal	67
Oil of cloves . . .	33.5	Thyme	68
Otto of roses . . .	36.5	Rosemary	74
Bergamot	44	Oil of laurel . . .	80
Neroli	47	Cassia	109

In comparison with the air introduced in the experiments the weight of the odours must be almost infinitely small. “Still we find that the least energetic in the list produces thirty times the

effect of the air, whilst the most energetic produces 109 times the same effect.”¹

Venturi, B. Prévost and Liégeois have studied the well-known movements of odoriferous particles, such as camphor, succinic acid, &c., when placed on the surface of water, and they have suggested that all odoriferous substances in a state of fine subdivision may move in a similar way on the moist surface of the olfactory membrane, and thus mechanically irritate the nerve-endings. This explanation is too coarse; but it is well known that the odours of flowers are most distinctly perceived in the morning, or after a shower, when the atmosphere contains a considerable amount of aqueous vapour. It would appear also that the odours of animal effluvia are of a higher specific gravity than the air, and do not readily diffuse—a fact which may account for the pointer and bloodhound keeping their noses to the ground. Such smells are very persistent and are apparently difficult to remove from any surface to which they have become attached. The smell of a corpse may haunt a living person for days, notwithstanding copious ablutions and change of clothes.

Special Physiology of Smell.—It is necessary that the air containing the odour be driven forcibly against the membrane. Thus the nostrils may be filled with eau de Cologne in normal saline solution, or with air impregnated with sulphuretted hydrogen, and still no odour is experienced if the person does not breathe. When a sniff is made the air within the nasal passages is rarefied, and, as the air rushes in to equilibrate the pressure, it is forcibly propelled against the olfactory surface. When the air stream enters the nostrils, it passes vertically upwards, bends round and sweeps backwards and downwards at the level of the middle turbinated bones towards the posterior nares. There is a motion of the air over the olfactory surface. The olfactory surface must be moist; if it is dry, or is covered with too thick a layer of mucus (as in catarrh), the sense is much weakened or lost. The first moment of contact is the most acute and the sense quickly becomes blunted. The first scent of a flower is the strongest and sweetest; and after a few minutes' exposure the intensity of even a foetid odour may not be perceived. This fact may be accounted for on the supposition that the olfactory membrane becomes quickly coated with a thin layer of matter, and that the most intense effect is produced when the odoriferous substances are applied to a clean surface. The intensity of smell depends on (1) the area of olfactory surface affected, and (2) the degree of concentration of the odoriferous matter. It is said that musk to the amount of the two-millionth of a milligram, and one part of sulphuretted hydrogen in 1,000,000 parts of air, may be perceived. The smell of mercaptan has been experimentally detected when the dilution was 1 to 50,000,000,000, and it was calculated that the weight of mercaptan so detected in 50 cc. of air was 1/400,000,000 of a milligram (E. Fischer and Penzoldt). If the two nostrils are filled with different odorous substances, there is no mixture of the odours, but we smell sometimes the one and sometimes the other. Morphia, mixed with sugar and taken as snuff, paralyses the olfactory apparatus, while strychnine makes it more sensitive (Lichtenfels and Frölich). There is no evidence that there are in the olfactory region different end organs or olfactory cells for different odours. The sense, however, may be fatigued by one odour so that other odours are not experienced. Thus camphor may so fatigue the sense that ether and eau de Cologne cannot excite smell.

As a rule, we experience odours by the simultaneous use of both nostrils. Stimulation of either nostril would give rise to the sensation, while there is a fusion of sensations when both are affected. If, by means of a tube, an odour is conveyed into one nostril, while an odour of a different kind is directed into the other, there may be either a compound sensational effect, a sort of double-odour, or one odour may so predominate as entirely to destroy the other. The fusion of odours is not complete, and it is similar to the effect of combining, say blue and red, in stereoscopic vision. When one odour destroys the other, the obliteration must take place in the cerebral centre. Certain odours are antagonistic, such as musk and oil of bitter almonds, volatile oils and iodoform, ammonia and acetic acid. It is not unlikely that when one odour predominates among many, this may be due not to any chemical action of one substance over another, but that the missing sensations may be accounted for by their failure to excite the olfactory region of the cerebrum in the presence of a stronger stimulus.

The delicacy of the sense is much greater in many of the lower animals than in man, and it is highly probable that the dog or cat obtain information by means of this sense which a human being cannot get. Odours may excite in the minds of many animals vivid impressions, and they have probably a memory of smells which the human being does not possess. Even in man the sense may be greatly improved by exercising it. A boy, James Mitchell, was born

¹ Tyndall, *Contributions to Molecular Physics in Domain of Radiant Heat*, p. 99.

blind, deaf and dumb, and chiefly depended on smell for keeping up a connexion with the outer world. He readily observed the presence of a stranger in the room and he formed his opinions of persons apparently from their characteristic smells (see Dugald Stewart's *Works*, iv. 300). In some rare cases, the sense of smell is congenitally absent in human beings, and it may be much injured by the practice of snuffing or by diseases of the nose affecting the olfactory membrane. Subjective impressions of smells, like spectral illusions or sounds in the ears, are occasionally, but rarely, observed in cases of hysteria and in the insane. Excessive smoking injures the sense. Finally, it may be observed that the sense of odour gives information as to the characters of food and drink and as to the purity of the air. Some persons are sensitive to certain smells while they do not recognize others, such as hydrocyanic acid or mignonette. In the lower animals also, the sense is associated with the sexual functions. (J. G. M.)

SMELT (*Osmerus eperlanus*; Fr. *éperlan*; Scotch sparring or spirling), the common small European fish of the genus *Osmerus*, family *Salmonidae*. It breeds, unless land-locked, in salt or brackish water, and though it often enters rivers it does not ascend beyond tidal influence. Like other British Salmonids it spawns in winter. The true smelt inhabits the coasts of northern and central Europe, and allied species are known from the Atlantic and Pacific coasts of North America (*Osmerus mordax*, *O. thaleichthys*, *O. Japonicus*).

SMERDIS (Pers. *Bardiya*; by Ctesias, *Pers.* 8, called *Tanyoxares*; by Xenophon, *Cyrop.* viii. 7. 11, who takes the name from Ctesias, *Tanaxares*; by Justin i. 9, *Mergis*; in Aeschylus, *Pers.* 774, *Mardos*), a Persian king of infamous memory; the prevalent Greek form Smerdis has assimilated the Persian name to the Greek (Asiatic) name Smerdis or Smerdies, which occurs in the poems of Alcaeus and Anacreon. Smerdis was the younger son of Cyrus the Great who, according to Ctesias, on his deathbed appointed him governor of the eastern provinces (cf. Xen. *Cyrop.* viii. 7, 11). Before Cambyses set out to Egypt, he secretly caused him to be murdered (Darius in the Behistun Inscr. i. 10), being afraid that he might attempt a rebellion during his absence. His death was not known to the people, and so in the spring of 522 a usurper pretended to be Smerdis and proclaimed himself king on a mountain near the Persian town Pishiyavūda. Owing to the despotic rule of Cambyses and his long absence in Egypt, "the whole people, Persians, Medes and all the other nations," acknowledged the usurper, especially as he granted a remission of taxes for three years (Herod. iii. 68). Cambyses began to march against him, but seeing that his cause was hopeless, killed himself in the spring of 521 (but see further CAMBYSES). The real name of the usurper was, as Darius tells us, Gaumāta, a Magian priest from Media; this name has been preserved by Justin i. 9 (from Charon of Lampsacus?), but given to his brother (called by Herodotus Patizeithes), who is said to have been the real promoter of the intrigue; the true name of the usurper is here given as *Oropastes*; by Ctesias as *Sphendadates*.

The history of the false Smerdis is narrated by Herodotus and Ctesias according to official traditions; Cambyses before his death confessed to the murder of his brother, and in public explained the whole fraud. But, as Darius said, nobody had the courage to oppose the new king, who ruled for seven months over the whole empire. Some contracts dating from his reign have been found in Babylonia, where his name is spelt *Barziya* (for the chronology cf. Ed. Meyer, *Forschungen zur alten Geschichte*, ii. 472 ff.). Darius says that he destroyed some temples, which Darius restored, and took away the herds and houses of the people (Behistun Inscr. i. 14). We have no means of explaining this statement, nor can we fully understand all the incidents connected with his usurpation; but the attempts of modern authors to prove that Gaumāta in reality was the genuine Smerdis and Darius a usurper have failed. It is certain that Smerdis transferred the seat of government to Media; and here in a castle in the district of Nisaya he was surprised and killed by Darius and his six associates in October 521. His death was annually celebrated in Persia by a feast called "the killing of the magian," at which no magian was allowed to show himself (Herod. iii. 79, Ctes. *Pers.* 15).

In the next year, another pseudo-Smerdis, named Vahyazdāta, rose against Darius in eastern Persia and met with great success. But he was finally defeated, taken prisoner and executed (Behistun Inscr. iii. 40 ff.; perhaps he is identical with the King Maraphis "the Maraphian," name of a Persian tribe, who occurs as successor in the list of Persian kings given by Aeschylus, *Pers.* 778).

See DARIUS (I.) and PERSIA, *Ancient History*. (ED. M.)

SMETANA, FRIEDRICH (1824–1884), Bohemian composer and pianist, was born at Leitomischl in Bohemia on the 2nd of March 1824. He made such rapid progress in his studies under Ikavec, at Neuhaus, that at the age of six he appeared in public as pianist so successfully that his father's opposition to a musician's career was overcome. He then went to Proksch, at Prague, until he left for Leipzig to make the acquaintance of Schumann and Mendelssohn. Limited means prevented him from studying with the latter, and he returned to Prague, where he at once became Konzert-meister to the Emperor Ferdinand. In 1848 he married Katharina Kolar, pianist, and with her founded a music school at Prague. At the same time he met Liszt, who subsequently influenced him greatly, and with whom he afterwards stayed at Weimar. In 1856 Smetana accepted Alexander Dreyschock's suggestion to go as conductor of the Philharmonic Society at Gothenburg. There he remained five years, when, owing to his wife's ill-health, he returned to Prague after a successful concert tour. The death of his wife at Dresden on their return caused Smetana to change his mind, and he went back to Sweden. But the opening of the Interims Theater in 1866, and the offer of its conductorship, induced his return. In Sweden he had already written *Hakon Jarl*, *Richard III.*, and *Wallenstein's Lager*, and had completed his opera *Die Brandenburger in Böhmen* (5th January 1866). Five months later it was followed by his best-known opera, *Die verkaufte Braut*, and in 1868 *Dalibor* was given. Between 1874 and 1882 he produced *Zwei Witwen*, *Hubicka (Der Kuss)*, *Tajewstvi (Das Geheimnis)*, *Certova Stena*, and *Die Teufelsmauer*, as well as the "grand prize" opera *Libuse*, written for the opening of the National Theatre at Prague, 11th June 1881. In *Die Teufelsmauer* were clear signs of decay in Smetana's powers, he having already in 1874 lost his sense of hearing. To celebrate his sixtieth birthday a fête was arranged by the combined Bohemian musical societies; but on that day Smetana lost his reason and was removed to a lunatic asylum, where he died on the 12th of May 1884. A great deal of his pianoforte music is interesting, the *Stammuchblätter*, for example; while his series of symphonic poems, entitled *Mein Vaterland (Vlast)*, and his beautiful string-quartet, *Aus meinem Leben*, have made the tour of the civilized world. He was an admirable pianist, and in many ways justified his countrymen's title of the "Czechisch Beethoven."

SMETHWICK, a municipal and county borough in the Handsworth parliamentary division of Staffordshire, England, 3 m. W. of Birmingham on the Great Western and the London & North Western railways. Pop. (1891) 36,106; (1901) 54,539. There are large glass, chemical and machine works; nuts and bolts are made, and lighthouse fittings are a specialty. Adjoining Smethwick on the E. is the district of Soho, famous as the scene of the engineering experiments of James Watt during his partnership with Matthew Boulton (c. 1770). The town of Smethwick is a modern growth about an ancient village, the name of which appears in Domesday. The borough, incorporated in 1899 (county borough, 1907), is under a mayor, 6 aldermen and 18 councillors. Area, 1929 acres.

SMILES, SAMUEL (1812–1904), British author, was born at Haddington, Scotland, on the 23rd of December 1812. He was the eldest of eleven children left, on their father's death, to be supported by their mother on slender means. To her spirit and example must be attributed some of the enthusiasm for self-reliance and self-education, that was later embodied in Dr Smiles's writings and led to their popularity and influence. Educated at the Haddington Grammar School and at Edinburgh University, where he studied medicine and graduated in 1832, Smiles tried, unsuccessfully, to practise in his native village among 3000 healthy Scotsmen and in competition with seven

other doctors. He added to his income by lecturing on chemistry and by writing for the press, and, finally abandoning the medical profession, he confined himself to journalism, and from 1838 till 1844 edited the weekly *Leeds Times*. Though he gave up regular journalism in 1844, he continued to be a frequent contributor to periodicals. From 1845 till 1854 he was secretary of the Leeds and Thirsk railway, and from 1854 till 1866 of the South Eastern railway. During his residence in Leeds he had opportunities of studying the characters of the remarkable men whose biographies he afterwards wrote. Here he came in contact with George Stephenson, whose *Life* by him, published in 1857, passed through five editions in its first year and was the precursor of a series of biographies of leaders in the world of industry, such as *Lives of the Engineers* (3 vols., 1861-1862), *Industrial Biography* (1863), *James Brindley and the Early Engineers* (1864), *Lives of Boulton and Watt* (1865), *Life of Thomas Telford* (1867), *The Life of a Scotch Naturalist* (Thomas Edward) (1876), *Robert Dick* (1878), *George Moore* (1878), *Men of Invention and Industry* (1884), *Life and Labour* (1887), *A Publisher and his Friends* (a history of the house of John Murray) (1891), *Jasmin* (1891), *Josiah Wedgwood* (1894). In 1859 had appeared his most successful book, *Self-Help*, a volume of popular ethics; 20,000 copies were sold the first year, and by 1889 the sales had reached 150,000 copies, while the book had been translated into 17 languages. Its success suggested others of similar purpose, like *Character* (1871), *Thrift* (1875), *Duty* (1880). Smiles also published two works dealing with the history of the Huguenots and a *History of Ireland*. His works are not only admirable for their simple and yet forcible style, but for the many useful and practical lessons which they enforce. Wholesome and stimulating, their whole tendency is to inculcate sound principles of life and the building up of manly and upright character. Dr Smiles was made hon. LL.D. of Edinburgh University in 1878, and in 1897 received from the king of Servia the Cross of Knight Commander of the Order of St Sava. He died in Kensington in his ninety-second year, on the 16th of April 1904.

His *Autobiography* was edited (1905) by T. Mackay.

SMILLIE, JAMES DAVID (1833-1909), American artist, was born in New York City on the 16th of January 1833. His father, James Smillie (1807-1885), a Scottish engraver, emigrated to New York in 1829, was elected to the National Academy of Design in 1851, did much, with his brother William Cumming (1813-1908), to develop the engraving of bank-notes, and was an excellent landscape-engraver. The son studied with him and in the National Academy of Design; engraved on steel vignettes for bank-notes and some illustrations, notably F. O. C. Darley's pictures for Cooper's novels; was elected an associate of the National Academy in 1865—the year after he first began painting—and an academician in 1876; and was a founder (1866) of the American Water Color Society, of which he was treasurer in 1866-1873 and president in 1873-1878, and of the New York Etching Club. Among his paintings, in oils, are "Evening among the Sierras" (1876) and "The Cliffs of Normandy" (1885), and in water colour, "A Scrub Race" (1876) and "The Passing Herd" (1888). He wrote and illustrated the article on the Yosemite in *Picturesque America*. He died on the 14th of September 1909. His brother, **GEORGE HENRY SMILLIE** (1840-), studied under his father and under James M. Hart, became a member of the National Academy of Design in 1882, and, like his brother, painted both in oils and in water colour. His favourite subjects were scenes along the New England coast. In 1881 he married **NELLIE SHELDON JACOBS** (b. 1854), a painter of *genre* pictures in oils and water colour.

SMIRKE, ROBERT (1752-1845), English painter, was born at Wigton near Carlisle in 1752. In his thirteenth year he was apprenticed in London with an heraldic painter, and at the age of twenty he began to study in the schools of the Royal Academy, to whose exhibition he contributed in 1786 a "Narcissus" and a "Sabrina," which were followed by many works, usually small in size, illustrative of the English poets, especially Thomson. In 1791 Smirke was elected an associate of the Royal Academy, and two years later a full member. In 1814 he was nominated

keeper to the Academy, but the king refused to sanction the appointment on account of the artist's revolutionary opinions. He was engaged upon the Shakespeare gallery, for which he painted "Katharina and Petruchio," "Prince Henry and Falstaff" and other subjects. He also executed many clever and popular book-illustrations. His works, which are frequently humorous, are pleasing and graceful, accomplished in draughtsmanship and handled with considerable spirit. He died in London on the 5th of January 1845.

SMITH, ADAM (1723-1790), English economist, was the only child of Adam Smith, comptroller of the customs at Kirkcaldy in Fifeshire, Scotland, and of Margaret Douglas, daughter of Mr Douglas of Strathendry, near Leslie. He was born at Kirkcaldy on the 5th of June 1723, some months after the death of his father. When he was three years old he was taken on a visit to his uncle at Strathendry, and when playing alone was carried off by a party of "tinkers." He was at once missed, and the vagrants pursued and overtaken in Leslie wood. He received his early education in the school of Kirkcaldy under David Miller, amongst whose pupils were many who were afterwards distinguished men. Smith showed great fondness for books and remarkable powers of memory; and he was popular among his schoolfellows. He was sent in 1737 to the university of Glasgow, where he attended the lectures of Dr Hutcheson; and in 1740 he went to Balliol College, Oxford, as exhibitioner on Snell's foundation. He remained at that university for seven years. At Glasgow his favourite studies had been mathematics and natural philosophy; but at Oxford he appears to have devoted himself almost entirely to moral and political science and to ancient and modern languages. He also laboured to improve his English style by translation, particularly from the French. After his return to Kirkcaldy he resided there two years with his mother, continuing his studies, not having yet adopted any plan for his future life. In 1748 he removed to Edinburgh, and there, under the patronage of Lord Kames, gave lectures on rhetoric and belles-lettres. About this time began his acquaintance with David Hume, which afterwards ripened into friendship. In 1751 he was elected professor of logic at Glasgow, and in 1752 was transferred to the chair of moral philosophy, which had become vacant by the death of Thomas Craigie, the successor of Hutcheson. This position he occupied for nearly twelve years, which he long afterwards declared to have been "by far the most useful, and therefore by far the happiest and most honourable period of his life." His course of lectures was divided into four parts—(1) natural theology; (2) ethics; (3) a treatment of that branch of morality which relates to justice, a subject which he handled historically after the manner of Montesquieu; (4) a study of those political regulations which are founded, not upon the principle of justice, but that of expediency, and which are calculated to increase the riches, the power and the prosperity of a state. Under this view he considered the political institutions relating to commerce, to finances, to ecclesiastical and military establishments. He first appeared as an author by contributing two articles to the *Edinburgh Review* (an earlier journal than the present, which was commenced in 1755, but of which only two numbers¹ were published),—one on Johnson's *Dictionary* and the other a letter to the editors on the state of literature in the different countries of Europe. In 1759 appeared his *Theory of Moral Sentiments*, embodying the second portion of his university course, to which was added in the 2nd edition an appendix with the title, "Considerations concerning the first Formation of Languages." After the publication of this work his ethical doctrines occupied less space in his lectures, and a larger development was given to the subjects of jurisprudence and political economy. Stewart gives us to understand that he had, as early as 1752, adopted the liberal views of commercial policy which he afterwards preached; and this we should have been inclined to believe independently from the fact that such views

¹ These two numbers were reprinted in 1818. Smith's letter to the editors is specially interesting for its account of the *Encyclopédie* and its criticism of Rousseau's pictures of savage life.

were propounded in that year in the *Political Discourses* of Hume.

In 1762 the senatus academicus of Glasgow conferred on him the honorary degree of doctor of laws. In 1763 he was invited to take charge of the young duke of Buccleuch on his travels. He accepted, and resigned his professorship. He went abroad with his pupil in February 1764; they remained only a few days at Paris and then settled at Toulouse, at that time the seat of a parlement, where they spent eighteen months in the best society of the place, afterwards making a tour in the south of France and passing two months at Geneva. Returning to Paris about Christmas of 1765, they remained there till the October of the following year. Smith at this time lived in the society of Quesnay, Turgot, d'Alembert, Morellet, Helvétius, Marmontel and the duke de la Rochefoucauld. His regard for the young nobleman¹ last named dictated the omission in the later editions of his *Moral Sentiments* of the name of the celebrated ancestor of the duke, whom he had associated with Mandeville as author of one of the "licentious systems" reviewed in the seventh part of that work. Smith was much influenced by his contact with the members of the physiocratic school, especially with its chief, though Dupont de Nemours probably goes too far in speaking of Smith and himself as having been "con-disciples chez M. Quesnay." Smith afterwards described Quesnay as a man "of the greatest modesty and simplicity," and declared his system of political economy to be, "with all its imperfections, the nearest approximation to truth that had yet been published on the principles of that science." In October 1766 tutor and pupil returned home, and they ever afterwards retained strong feelings of mutual esteem. For the next ten years Smith lived with his mother at Kirkcaldy, only paying occasional visits to Edinburgh and London; he was engaged in close study during most of this time. He describes himself to Hume during this period as being extremely happy. "He was occupied on his *Inquiry into the Nature and Causes of the Wealth of Nations*, which there is some reason for believing he had begun at Toulouse. That great work appeared in 1776.² After its publication, and only a few months before his own death, Hume wrote to congratulate his friend—"Euge! belle! dear Mr Smith, I am much pleased with your performance, and the perusal of it has taken me from a state of great anxiety. It was a work of so much expectation, by yourself, by your friends, and by the public, that I trembled for its appearance, but am now much relieved. Not but that the reading of it necessarily requires so much attention, and the public is disposed to give so little, that I shall still doubt for some time of its being at first very popular, but it has depth, and solidity, and acuteness, and is so much illustrated by curious facts that it must at last attract the public attention." Smith attended Hume during a part of his last illness, and soon after the death of the philosopher there was published, along with his autobiography a letter from Smith to W. Strahan (Smith's publisher) in which he gave an account of the closing scenes of his friend's life and expressed warm admiration for his character. This letter excited some rancour among the theologians, and Dr George Horne, afterwards bishop of Norwich, published in 1777 *A Letter to Adam Smith on the Life, Death and Philosophy of his Friend David Hume, by one of the people called Christians*. But Smith took no notice of this effusion.³ He was also attacked by Arch-

¹ The duke undertook a translation of the *Theory of Moral Sentiments*, but the Abbé Blavet's version appeared (1774) before his was completed and he then relinquished the design. An earlier French translation had been published (1764) under the title *Métaphysique de l'âme*; and there is a later one—the best—by the marquis de Condorcet (1798, 2nd ed., 1830).

² J. E. Thorold Rogers published in the *Academy*, 28th February 1885, a letter of Smith to William Pulteney, written in 1772, from which he thought it probable that the work lay "unrevised and unaltered" in the author's desk for four years. A similar conclusion seems to follow from a letter of Hume in Burton's *Life*, ii. 461.

³ A story was told by Sir Walter Scott, and is also related in the *Edinburgh Review*, of an "unfortunate rencontre," arising out of the publication of the same letter, between Smith and Dr Johnson, during the visit of the latter to Glasgow. The same story is given in a note in Wilberforce's *Correspondence*, the scene being somewhat vaguely laid in "Scotland." But it cannot be true; for Johnson

bishop W. Magee (1766–1831) for the omission in subsequent editions of a passage of the *Moral Sentiments* which that prelate had cited with high commendation as among the ablest illustrations of the doctrine of the atonement. Smith had omitted the paragraph in question (an omission which had escaped notice for twenty years) on the ground that it was unnecessary and misplaced; but Magee suspected him of having been influenced by deeper reasons.

The greater part of the two years which followed the publication of the *Wealth of Nations* Smith spent in London, enjoying the society of eminent persons, amongst whom were Gibbon, Burke, Reynolds and Topham Beauclerk. In 1778 he was appointed, through the influence of the duke of Buccleuch, one of the commissioners of customs in Scotland, and in consequence of this fixed his residence at Edinburgh. His mother, now in extreme old age, lived with him, as did also his cousin, Miss Jane Douglas, who superintended his household. Much of his now ample income is believed to have been spent in secret charities, and he kept a simple table at which, "without the formality of an invitation, he was always happy to receive his friends." "His Sunday suppers," says M'Culloch, "were long celebrated at Edinburgh." One of his favourite places of resort in these years was a club of which Dr Hutton, Dr Black, Dr Adam Ferguson, John Clerk the naval tactician, Robert Adam the architect, as well as Smith himself, were original members, and to which Dugald Stewart, Professor Playfair and other eminent men were afterwards admitted. Another source of enjoyment was his small but excellent library; it is still preserved in his family.⁴ In 1787 he was elected lord rector of the university of Glasgow, an honour which he received with "heartfelt joy." If we can believe a note in Wilberforce's *Correspondence*, he visited London in the spring of the same year, and was introduced by Dundas⁵ to Pitt, Wilberforce and others. From the death of his mother in 1784, and that of Miss Douglas in 1788, his health declined, and after a painful illness he died on the 17th of July 1790.

Before his decease Smith directed that all his manuscripts except a few selected essays should be destroyed, and they were accordingly committed to the flames. Of the pieces preserved by his desire the most valuable is his tract on the history of astronomy, which he himself described as a "fragment of a great work"; it was doubtless a portion of the "connected history of the liberal sciences and elegant arts" which, we are told, he had projected in early life. Among the papers destroyed were probably, as Stewart suggests, the lectures on natural religion and jurisprudence which formed part of his course at Glasgow, and also the lectures on rhetoric which he delivered at Edinburgh in 1748. To the latter Hugh Blair seems to refer when, in his work on *Rhetoric and Belles-Lettres* (1783), he acknowledges his obligations to a manuscript treatise on rhetoric by Smith, part of which its author had shown to him many years before, and which he hoped that Smith would give to the public. Smith had promised at the end of his *Theory of Moral Sentiments* a treatise on jurisprudence from the historical point of view.

As a moral philosopher Smith cannot be said to have won much acceptance for his fundamental doctrine. This doctrine is that all our moral sentiments arise from sympathy, that is, from the principle of our nature "which leads us to enter into the situations of other men and to partake with them in the passions which those situations have a tendency to excite." Our direct sympathy with the agent in the circumstances in which he is placed gives rise, according to this view, to our notion of the propriety of his action, whilst our indirect sympathy with those whom his actions have benefited or injured gives rise to our notions of merit and demerit in the agent himself. It seems justly alleged against this system by Dr Thomas Brown that "the moral sentiments, the origin of which it ascribes to our secondary feelings of mere sympathy, are assumed as previously existing in the original emotions with which the secondary feelings are said to be in unison." A second objection urged, perhaps with less justice, against the theory is that it fails to account for the

made his tour in 1773, whilst Hume's death did not take place till 1776. Smith seems not to have met Johnson in Scotland at all. It appears, however, from Boswell's *Life*, under date of 29th April 1778, that Johnson had on one occasion quarrelled with Smith at Strahan's house, apparently in London; it is clear that the "unlucky altercation" at Strahan's must have occurred in 1761 or 1763, and could have had nothing to do with the letter on Hume's death.

⁴ See *Catalogue of the Library of Adam Smith*, edited with notes and introduction, by James Bonar (1894).

⁵ An interesting letter of Smith to Dundas (1st November 1779) on free trade for Ireland is printed in the *Eng. Hist. Review*, No. 2.

authoritative character which is felt to be inherent in our sense of right and wrong—for what Butler calls the “supremacy of conscience.”

It is on the *Wealth of Nations* that Smith's fame rests. But it must at once be said that it is plainly contrary to fact to represent him, as some have done, as the creator of political economy. The subject of social wealth had always in some degree, and increasingly in recent times, engaged the attention of philosophic minds. The study had even indisputably assumed a systematic character, and, from being an assemblage of fragmentary disquisitions on particular questions of national interest, had taken the form, notably in Turgot's *Réflexions*, of an organized body of doctrine. The truth is that Smith took up the science when it was already considerably advanced; and it was this very circumstance which enabled him, by the production of a classical treatise, to render most of his predecessors obsolete.

Even those who do not fall into the error of making Smith the creator of the science, often separate him too broadly from Quesnay and his followers, and represent the history of modern economics as consisting of the successive rise and reign of three doctrines—the mercantile, the physiocratic and the Smithian. The last two are, it is true, at variance in some even important respects. But it is evident, and Smith himself felt, that their agreements were much more fundamental than their differences; and, if we regard them as historical forces, they must be considered as working towards identical ends. They both urged society towards the abolition of the previously prevailing industrial policy of European governments; and their arguments against that policy rested essentially on the same grounds.

The history of economic opinion in modern times, down to the third decade of the 19th century, is, in fact, strictly bipartite. The first stage is filled with the mercantile system, which was rather a practical policy than a speculative doctrine, and which came into existence as the spontaneous growth of social conditions acting on minds not trained to scientific habits. The second stage is occupied with the gradual rise and ultimate ascendancy of another system founded on the idea of the right of the individual to an unimpeded sphere for the exercise of his economic activity. With the latter, which is best designated as the “system of natural liberty,” we ought to associate the memory of the physiocrats as well as that of Smith, without, however, maintaining their services to have been equal to his.

The teaching of political economy was associated in the Scottish universities with that of moral philosophy. Smith conceived the entire subject he had to treat in his public lectures as divisible into four beads, the first of which was natural theology, the second ethics, the third jurisprudence; whilst in the fourth “he examined those political regulations which are founded upon expediency, and which are calculated to increase the riches, the power, and the prosperity of a state.” The last two branches of inquiry are regarded as forming but a single body of doctrine in the well-known passage of the *Theory of Moral Sentiments* in which the author promises to give in another discourse “an account of the general principles of law and government, and of the different revolutions they have undergone in the different ages and periods of society, not only in what concerns justice, but in what concerns police, revenue and arms, and whatever else is the subject of law.” This shows how little it was Smith's habit to separate (except provisionally), in his conceptions or his researches, the economic phenomena of society from all the rest. The words above quoted have, indeed, been not unjustly described as containing “an anticipation, wonderful for his period, of general sociology.”

There has been much discussion on the question—What is the scientific method followed by Smith in his great work? By some it is considered to have been purely deductive, a view which Buckle has perhaps carried to the greatest extreme. He asserts that in Scotland the inductive method was unknown, and that although Smith spent some of the most important years of his youth in England, where the inductive method was supreme, he yet adopted the deductive method because it was habitually followed in Scotland. That the inductive spirit exercised no influence on Scottish philosophers is certainly not

true; Montesquieu, whose method is essentially inductive, was in Smith's time closely studied by Smith's fellow-countrymen. What may justly be said of Smith is that the deductive bent was not the predominant character of his mind, nor did his great excellence lie in the “dialectic skill” which Buckle ascribes to him. What strikes us most in his book is his wide and keen observation of social facts, and his perpetual tendency to dwell on these and elicit their significance, instead of drawing conclusions from abstract principles by elaborate chains of reasoning.

That Smith does, however, largely employ the deductive method is certain; and that method is legitimate when the premises from which the deduction sets out are known universal facts of human nature and properties of external objects. But there is another species of deduction which, as Cliffe Leslie has shown, seriously tainted the philosophy of Smith—in which the premises are not facts ascertained by observation, but the a priori assumptions which we found in the physiocrats. In his view, Nature has made provision for social wellbeing by the principle of the human constitution which prompts every man to better his condition; the individual aims only at his private gain, but is “led by an invisible hand” to promote the public good; human institutions, by interfering with this principle in the name of the public interest, defeat their own end; but, when all systems of preference or restraint are taken away, “the obvious and simple system of natural liberty establishes itself of its own accord.” This theory is, of course, not explicitly presented by Smith as a foundation of his economic doctrines, but it is really the secret substratum on which they rest. Yet, whilst such latent postulates warped his view of things, they did not entirely determine his method. His native bent towards the study of things as they are preserved him from extravagances into which many of his followers have fallen. But besides this, as Leslie has pointed out, the influence of Montesquieu tended to counterbalance the theoretic prepossessions produced by the doctrine of the *jus naturae*. We are even informed that Smith himself in his later years was occupied in preparing a commentary on the *Esprit des lois*. He was thus affected by two different and incongruous systems of thought—one setting out from an imaginary code of nature intended for the benefit of man, and leading to an optimistic view of the economic constitution founded on enlightened self-interest; the other following inductive processes, and seeking to explain the several states in which the human societies are found existing, as results of circumstances or institutions which have been in actual operation. And we find accordingly in his great work a combination of inductive inquiry with a priori speculation founded on the “Nature” hypothesis.

Some have represented Smith's work as of so loose a texture and so defective in arrangement that it may be justly described as consisting of a series of monographs. But this is certainly an exaggeration. The book, it is true, is not framed on a rigid mould, nor is there any parade of systematic divisions and subdivisions. But, as a body of exposition, it has the real unity which results from a mode of thinking homogeneous throughout and the general absence of such contradictions as would arise from an imperfect digestion of the subject.

Smith sets out from the thought that the annual labour of a nation is the source from which it derives its supply of the necessaries and conveniences of life. He does not of course contemplate labour as the only factor in production; but it has been supposed that by emphasizing it at the outset he at once strikes the note of difference between himself on the one hand, and both the mercantilists and the physiocrats on the other. The improvement in the productiveness of labour depends largely on its division; and he proceeds accordingly to give his unrivalled exposition of that principle, of the grounds on which it rests, and of its greater applicability to manufactures than to agriculture, in consequence of which the latter relatively lags behind in the course of economic development. The origin of the division of labour he finds in the propensity of human nature “to truck, barter or exchange one thing for another.” He shows that a certain accumulation of capital is a condition precedent of this division, and that the degree to which it can be carried is dependent on the extent of the market. When the division of labour has been established, each member of the society must have recourse to the others for the supply of most of his wants; a medium of exchange is thus found to be necessary, and money comes into use. The exchange of goods

against each other or against money gives rise to the notion of value. This word has two meanings—that of utility, and that of purchasing power; the one may be called value in use, the other value in exchange. Merely mentioning the former, Smith goes on to study the latter. What, he asks, is the measure of value? what regulates the amount of one thing which will be given for another? "Labour," Smith answers, "is the real measure of the exchangeable value of all commodities." "Equal quantities of labour at all times and places, are of equal value to the labourer." "Labour alone, therefore, never varying in its own value, is alone the ultimate and real standard by which the value of all commodities can at all times and places be estimated and compared. It is their real price; money is their nominal price only." Money, however, is in men's actual transactions the measure of value, as well as the vehicle of exchange; and the precious metals are best suited for this function, as varying little in their own value for periods of moderate length; for distant times, corn is a better standard of comparison. In relation to the earliest social stage, we need consider nothing but the amount of labour employed in the production of an article as determining its exchange value; but in more advanced periods price is complex, and consists in the most general case of three elements—wages, profit and rent. Wages are the reward of labour. Profit arises as soon as stock, being accumulated in the hands of one person, is employed by him in setting others to work, and supplying them with materials and subsistence, in order to make a gain by what they produce. Rent arises as soon as the land of a country has all become private property; "the landlords, like all other men, love to reap where they never sowed, and demand a rent even for its natural produce." In every improved society, then, these three elements enter more or less into the price of the far greater part of commodities. There is in every society or neighbourhood, an ordinary or average rate of wages and profit in every different employment of labour and stock, regulated by principles to be explained hereafter, as also an ordinary or average rate of rent. These may be called the natural rates at the time when and the place where they prevail; and the natural price of a commodity is what is sufficient to pay for the rent of the land, the wages of the labour, and the profit of the stock necessary for bringing the commodity to market. The market price may rise above or fall below the amount so fixed, being determined by the proportion between the quantity brought to market and the demand of those who are willing to pay the natural price. Towards the natural price as a centre the market-price, regulated by competition, constantly gravitates. Some commodities, however, are subject to a monopoly of production, whether from the peculiarities of a locality or from legal privilege: their price is always the highest that can be got; the natural price of other commodities is the lowest which can be taken for any length of time together. The three component parts or factors of price vary with the circumstances of the society. The rate of wages is determined by a "dispute" or struggle of opposite interests between the employer and the workman. A minimum rate is fixed by the condition that they must be at least sufficient to enable a man and his wife to maintain themselves and, in general, bring up a family. The excess above this will depend on the circumstances of the country, and the consequent demand for labour—wages being high when national wealth is increasing, low when it is declining. The same circumstances determine the variation of profits, but in an opposite direction; the increase of stock, which raises wages, tending to lower profit through the mutual competition of capitalists. "The whole of the advantages and disadvantages of the different employments of labour and stock must, in the same neighbourhood, be either perfectly equal or continually tending to equality"; if one had greatly the advantage over the others, people would crowd into it, and the level would soon be restored. Yet pecuniary wages and profits are very different in different employments—either from certain circumstances affecting the employments, which recommend or disparage them in men's notions, or from national policy, "which nowhere leaves things at perfect liberty." Here follows Smith's admirable exposition of the causes which produce the inequalities in wages and profits just referred to, a passage affording ample evidence of his habits of nice observation of the less obvious traits in human nature, and also of the operation both of these and of social institutions on economic facts. The rent of land comes next to be considered, as the last of the three elements of price. Rent is a monopoly price, equal, not to what the landlord could afford to take, but to what the farmer can afford to give. "Such parts only of the produce of land can commonly be brought to market, of which the ordinary price is sufficient to replace the stock which must be employed in bringing them thither, together with the ordinary profits. If the ordinary price is more than this, the surplus part will naturally go to the rent of the land. If it is not more, though the commodity may be brought to market, it can afford no rent to the landlord. Whether the price is or is not more depends on the demand." "Rent, therefore, enters into the price of commodities in a different way from wages and profits. High or low wages and profit are the causes of high or low price; high or low rent is the effect of it."

Rent, wages and profits, as they are the elements of price, are also the constituents of income; and the three great orders of every civilized society, from whose revenues that of every other order is ultimately derived, are the landlords, the labourers and the capital-

ists. The relation of the interests of these three classes to those of society at large is different. The interest of the landlord always coincides with the general interest: whatever promotes or obstructs the one has the same effect on the other. So also does that of the labourer: when the wealth of the nation is progressive, his wages are high; they are low when it is stationary or retrogressive. "The interest of the third order has not the same connexion with the general interest of the society as that of the other two; . . . it is always in some respects different from and opposite to that of the public."

The subject of the second book is "the nature, accumulation and improvement of stock." A man's whole stock consists of two portions—that which is reserved for his immediate consumption, and that which is employed so as to yield a revenue to its owner. This latter, which is his "capital," is divisible into the two classes of "fixed" and "circulating." The first is such as yields a profit without passing into other hands. The second consists of such goods, raised, manufactured or purchased, as are sold for a profit and replaced by other goods; this sort of capital is therefore constantly going from and returning to the hands of its owner. The whole capital of a society falls under the same two heads. Its fixed capital consists chiefly of (1) machines, (2) buildings which are the means of procuring a revenue, (3) agricultural improvements and (4) the acquired and useful abilities of all members of the society (since sometimes known as "personal capital"). Its circulating capital is also composed of four parts—(1) money, (2) provisions in the hands of the dealers, (3) materials and (4) completed work in the hands of the manufacturer or merchant. Next comes the distinction of the gross national revenue from the net—the first being the whole produce of the land and labour of a country, the second what remains after deducting the expense of maintaining the fixed capital of the country and that part of its circulating capital which consists of money. Money, "the great wheel of circulation," is altogether different from the goods which are circulated by means of it; it is a costly instrument by means of which all that each individual receives is distributed to him; and the expenditure required, first to provide it, and afterwards to maintain it, is a deduction from the net revenue of the society. In development of this consideration, Smith goes on to explain the gain to the community arising from the substitution of paper money for that composed of the precious metals; and here occurs the remarkable illustration in which the use of gold and silver money is compared to a highway on the ground, that of paper money to a wagon way through the air. In proceeding to consider the accumulation of capital, he is led to the distinction between productive and unproductive labour—the former being that which is fixed or realized in a particular object or vendible article, the latter that which is not so realized. The former is exemplified in the labour of the manufacturing workman, the latter in that of the menial servant. A broad line of demarcation is thus drawn between the labour which results in commodities or increased value of commodities, and that which does no more than render services: the former is productive, the latter unproductive. "Productive" is by no means equivalent to "useful": the labours of the magistrate, the soldier, the churchman, lawyer and physician, are, in Smith's sense, unproductive. Productive labourers alone are employed out of capital; unproductive labourers, as well as those who do not labour at all, are all maintained by revenue. In advancing industrial communities, the portion of annual produce set apart as capital, bears an increasing proportion to that which is immediately destined to constitute a revenue, either as rent or as profit. Parsimony is the source of the increase of capital; by augmenting the fund devoted to the maintenance of productive hands, it puts in motion an additional quantity of industry, which adds to the value of the annual produce. What is annually saved is as regularly consumed as what is spent, but by a different set of persons, by productive labourers instead of idlers or unproductive labourers; and the former reproduce with a profit the value of their consumption. The prodigal, encroaching on his capital, diminishes, as far as in him lies, the amount of productive labour, and so the wealth of the country; nor is this result affected by his expenditure being on home-made, as distinct from foreign commodities. Every prodigal, therefore, is a public enemy; every frugal man a public benefactor. The only mode of increasing the annual produce of the land and labour is to increase either the number of productive labourers or the productive powers of those labourers. Either process will in general require additional capital, the former to maintain the new labourers, the latter to provide improved machinery or to enable the employer to introduce a more complete division of labour. In what are commonly called loans of money, it is not really the money, but the money's worth, that the borrower wants; and the lender really assigns to him the right to a certain portion of the annual produce of the land and labour of the country. As the general capital of a country increases, so also does the particular portion of it from which the possessors wish to derive a revenue without being at the trouble of employing it themselves, and, as the quantity of stock thus available for loans is augmented, the interest diminishes, not merely "from the general causes which make the market price of things commonly diminish as their quantity increases," but because, with the increase of capital, "it becomes gradually more and more difficult to find within the country a

profitable method of employing any new capital"—whence arises a competition between different capitals, and a lowering of profits, which must diminish the price which can be paid for the use of capital, or in other words the rate of interest. It was formerly wrongly supposed, and even Locke and Montesquieu did not escape this error, that the fall in the value of the precious metals consequent on the discovery of the American mines was the real cause of the general lowering of the rate of interest in Europe. But this view, already refuted by Hume, is easily seen to be erroneous. "In some countries the interest of money has been prohibited by law. But, as something can everywhere be made by the use of money, something ought everywhere to be paid for the use of it," and will in fact be paid for it; and the prohibition will only heighten the evil of usury by increasing the risk to the lender. The legal rate should be a very little above the lowest market rate; sober people will then be preferred as borrowers to prodigals and projectors, who at a higher legal rate would have an advantage over them, being alone willing to offer that higher rate.

As to the different employments of capital, the quantity of productive labour put in motion by an equal amount varies extremely according as that amount is employed—(1) in the improvement of lands, mines or fisheries, (2) in manufactures, (3) in wholesale or (4) retail trade. In agriculture "Nature labours along with man," and not only the capital of the farmer is reproduced with his profits, but also the rent of the landlord. It is therefore the employment of a given capital which is most advantageous to society. Next in order come manufactures; then wholesale trade—first the home trade, secondly the foreign trade of consumption, last the carrying trade. All these employments of capital, however, are not only advantageous, but necessary, and will introduce themselves in the due degree if left to individual enterprise.

These first two books contain Smith's general economic scheme; and we have stated it as fully as was consistent with the brevity here necessary, because from this formulation of doctrine the English classical school set out, and round it the discussions of more modern times in different countries have in a great measure revolved.

The critical philosophers of the 18th century were often destitute of the historical spirit, which was no part of the endowment needed for their principal social office. But some of the most eminent of them, especially in Scotland, showed a marked capacity and predilection for historical studies. Smith was among the latter; Karl Knies and others justly remark on the masterly sketches of this kind which occur in the *Wealth of Nations*. The longest and most elaborate of these occupies the third book; it is an account of the course followed by the nations of modern Europe in the successive development of the several forms of industry. It affords a curious example of the effect of doctrinal prepossessions in obscuring the results of historical inquiry. Whilst he correctly describes the European movement of industry, and explains it as arising out of adequate social causes, he yet, in accordance with the absolute principles which tainted his philosophy, protests against it as involving an entire inversion of the "natural order of things." First agriculture, then manufactures, lastly foreign commerce; any other order than this he considers "unnatural and retrograde."

The fourth book is principally devoted to the elaborate and exhaustive polemic against the mercantile system which finally drove it from the field of science, and has exercised a powerful influence on economic legislation. When protection is now advocated, it is commonly on different grounds from those which were in current use before the time of Smith. He believed that to look for the restoration of freedom of foreign trade in Great Britain would have been "as absurd as to expect that an Oceana or Utopia should be established in it." His teaching on the subject is not altogether unqualified; but, on the whole, with respect to exchanges of every kind, where economic motives alone enter, his voice is in favour of freedom. He has regard, however, to political as well as economic interests, and on the ground that "defence is of much more importance than opulence" pronounces the Navigation Act to have been "perhaps the wisest of all the commercial regulations of England." Whilst objecting to the prevention of the export of wool, he proposes a tax on that export as somewhat less injurious to the interest of growers than the prohibition, whilst it would "afford a sufficient advantage" to the domestic over the foreign manufacturer. This is, perhaps, his most marked deviation from the rigour of principle; it was doubtless a concession to popular opinion with a view to an attainable practical improvement. The wisdom of retaliation in order to procure the repeal of high duties or prohibitions imposed by foreign governments depends, he says, altogether on the likelihood of its success in effecting the object aimed at, but he does not conceal his contempt for the practice of such expedients. The restoration of freedom in any manufacture, when it has grown to considerable dimensions by means of high duties, should, he thinks, from motives of humanity, be brought about only by degrees and with circumspection—though the amount of evil which would be caused by the immediate abolition of the duties is, in his opinion, commonly exaggerated. The case in which J. S. Mill justified protection—that, namely, in which an industry well adapted to a country is kept down by the acquired ascendancy of foreign producers—is referred to by Smith; but he is opposed to the admission of this exception for reasons which do not appear to be conclusive. He is perhaps scarcely consistent in ap-

proving the concession of temporary monopolies to joint-stock companies undertaking risky enterprises "of which the public is afterwards to reap the benefit."¹

He is less absolute in his doctrine of governmental non-interference when he comes to consider in his fifth book the "expenses of the sovereign or the commonwealth." He recognizes as coming within the functions of the state the erection and maintenance of those public institutions and public works which, though advantageous to the society, could not repay, and therefore must not be thrown upon, individuals or small groups of individuals. He remarks in a just historical spirit that the performance of these functions requires very different degrees of expense in the different periods of society. Besides the institutions and works intended for public defence and the administration of justice, and those required for facilitating the commerce of the society, he considers those necessary for promoting the instruction of the people. He thinks the public at large may with propriety not only facilitate and encourage, but even impose upon almost the whole body of the people, the acquisition in youth of the most essential elements of education. He suggests as the mode of enforcing this obligation the requirement of submission to a test examination "before any one could obtain the freedom in any corporation, or be allowed to set up a trade in any village or town corporate." Similarly, he is of opinion that some probation, even in the higher and more difficult sciences, might be enforced as a condition of exercising any liberal profession, or becoming a candidate for any honourable office. The expense of the institutions for religious instruction as well as for general education, he holds, may without injustice be defrayed out of the funds of the whole society, though he would apparently prefer that it should be met by the voluntary contributions of those who think they have occasion for such education or instruction.

To sum up, it may be said that the *Wealth of Nations* certainly operated powerfully through the harmony of its critical side with the tendencies of the half-century which followed its publication to the assertion of personal freedom and "natural rights." It discredited the economic policy of the past, and promoted the overthrow of institutions which had come down from earlier times, but were unsuited to modern society. As a theoretic treatment of social economy, and therefore as a guide to social reconstruction and practice in the future, it is provisional, not definitive. But when the study of its subject comes to be systematized on the basis of a general social philosophy more complete and durable than Smith's, no contributions to that final construction will be found so valuable as his.

Buckle has the idea that the two principal works of Smith, the *Theory of Moral Sentiments* and the *Wealth of Nations*, are mutually complementary parts of one great scheme, in which human nature is intended to be dealt with as a whole—the former exhibiting the operation of the benevolent feelings, the latter of what, by a singular nomenclature, inadmissible since Butler wrote, he calls "the passion of selfishness." In each division the motive contemplated is regarded as acting singly, without any interference of the opposite principle. This appears to be an artificial and misleading notion. Neither in the plan of Smith's university course nor in the well-known passage at the end of his *Moral Sentiments* is there any indication of his having conceived such a bipartite scheme. The object of the *Wealth of Nations* is surely in no sense psychological, as is that of the *Moral Sentiments*. The purpose of the work is to exhibit social phenomena, not to demonstrate their source in the mental constitution of the individual.

The following may be referred to for biographical details: Dugald Stewart, *Biographical Memoir of Adam Smith*, originally read (1793) before the Royal Society of Edinburgh, and afterwards prefixed to Smith's *Essays on Philosophical Subjects*; J. A. Farrer, *Adam Smith* (1881); R. B. Haldane, *Life of Smith* (1887), and the very full and excellent *Life of Adam Smith* by John Rae (1895). Additional particulars are given in Brougham's *Men of Letters and Science*, Burton's *Life of Hume* and Alexander Carlyle's *Autobiography*; and some characteristic anecdotes of him will be found in *Memoirs of the Life and Works of Sir John Sinclair* (1837). For comments on his *Theory of Moral Sentiments*, see, besides Stewart, as cited above, Dr T. Brown's *Philosophy of the Human Mind*, lects. 80 and 81; Sir J. Mackintosh's *Dissertation on the Progress of Ethical Philosophy*; and the art. ETHICS in the present work. On the *Wealth of Nations*, see the prefaces to McCulloch's, Rogers's, Shield Nicholson's and Cannan's editions of that work; Rogers's *Historical Cleanings* (1869); the art. "Smith" in Coquelin and Guillaumin's *Dictionnaire de l'économie politique*; Bagehot's *Economic Studies* (1880); and Cossa's *Guide to the Study of Political Economy* (Eng. trans., 1880), chap. v. See also Professor Shield Nicholson's *Project of Empire* (1909), which is a critical study of the Economics of Imperialism, with special reference to the ideas of Adam Smith; and Professor W. J. Ashley's essay in *Compatriots Club Lectures* (1905) on "Political Economy and the Tariff Problem." See also Professor W. J. Ashley's *Select Chapters and Passages from the "Wealth of Nations"* (J. K. I.; X.)

¹ Professor Bastable calls attention to the interesting fact that the proposal of an export duty on wool and the justification of a temporary monopoly to joint-stock companies both appear for the first time in the edition of 1784

SMITH, ALBERT RICHARD (1816–1860), English author and public entertainer, was born at Chertsey, Surrey, on the 24th of May 1816. He studied medicine in Paris, and his first literary effort was an account of his life there, which appeared in the *Mirror*. He gradually relinquished his medical work for light literature. Though a journalist rather than a literary figure, he was one of the most popular men of his time, and a favourite humorist in the vein of humour then in vogue. He was one of the early contributors to *Punch* and was also a regular contributor to *Bentley's Miscellany*, in whose pages his first and best book, *The Adventures of Mr Ledbury*, appeared in 1842. His other books were, *Christopher Tadpole* (1848), issued in monthly parts, *Pottleton's Legacy* (1849), and a series of so-called natural histories, *The Gent*, *The Ballet Girl*, *The Idler upon Town* and *The Flirt*. Albert Smith also wrote extravaganzas and adapted some of Charles Dickens's stories for the stage. He founded and edited a monthly magazine called *The Man in the Moon*, from 1847 to 1849. In 1851 he ascended Mont Blanc, and the year after produced at the Egyptian Hall the descriptive entertainment, which he called "Mont Blanc," describing the ascent of the mountain and the Englishman abroad. This success was followed by other entertainments of the kind, among them "China." Smith married in 1850 a daughter of Robert Keeley, the comedian. He died in Fulham, London, on the 23rd of May 1860. Smith received great help from his brother, Arthur W. W. Smith (1825–1861), who had also been educated for medicine. He managed the entertainments at the Egyptian Hall from 1852 to 1860. He also planned Charles Dickens's readings in 1858, and made arrangements for a second series, but died before they were completed.

SMITH, ALEXANDER (1830–1867), Scottish poet, son of a lace-designer, was born at Kilmarnock on the 31st of December 1830. His parents being too poor to send him to college, he was placed in a linen factory to follow his father's trade of a pattern designer. His early poems appeared in the *Glasgow Citizen*, in whose editor, James Hedderwick, he found a sympathizing and appreciative friend. *A Life Drama and other Poems* (1853) was a work of promise, ran through several editions, and gained Smith the appointment of secretary to Edinburgh University in 1854. As a poet he was one of the leading representatives of what was called the "Spasmodic" School, now fallen into oblivion. Smith, P. J. Bailey and Sydney Dobell were satirized by W. E. Aytoun in 1854 in *Firmilian: a Spasmodic Tragedy*. In the same year Sydney Dobell came to Edinburgh, and an acquaintanceship at once sprang up between the two, which resulted in their collaboration in a book of *War Sonnets* (1855), inspired by the Crimean War. After publishing *City Poems* (1857) and *Edwin of Deira* (1861), a Northumbrian epic poem, Smith turned his attention to prose, and published *Dreamthorp: Essays written in the Country* (1863) and *A Summer in Skye*. His last work was an experiment in fiction, *Alfred Hagart's Household* (1866), which ran first through *Good Words*. He died on the 5th of January 1867.

A memoir of Smith by P. P. Alexander was prefixed to a volume entitled *Last Leaves*.

SMITH, ANDREW JACKSON (1815–1897), American soldier, was born in Bucks county, Pennsylvania, on the 28th of April 1815 and graduated at West Point in 1838. He was engaged on active service on the south-west frontier and in Mexico, and afterwards in Indian warfare in Washington and Oregon territories, becoming first lieutenant in 1845, captain in 1847, and major in 1861. In the latter year, on the outbreak of the Civil War, he became a colonel of volunteer cavalry in the Federal army, rising early in 1862 to the rank of brigadier-general U.S.V., and to the chief command of the cavalry in the Missouri department. Assigned afterwards to the Army of the Tennessee, he took part in the first attack on Vicksburg and the capture of Arkansas Post, and commanded a division of the XIII. corps in the final Vicksburg campaign. Later he led a division of the XVI. corps in the Red River expedition of Gen. N. P. Banks, and received the brevet of colonel for his services at the action of Pleasant Hill. In May 1864 he became lieutenant-colonel U.S.A.

and major-general U.S.V., and during the greater part of the year was employed in Missouri against the Confederate general Sterling Price. Thence he was summoned to join forces with G. H. Thomas at Nashville, then threatened by the advance of Gen. J. B. Hood. He bore a conspicuous share in the crowning victory of Nashville (*q.v.*), after which he commanded the XVI. corps in the final campaign in the South. Just before the close of the war he was breveted brigadier-general U.S.A. for his services at the action of Tupelo, Mississippi, and major-general U.S.A. for Nashville. He resigned his volunteer commission in 1866 and became colonel of the 7th U.S. Cavalry. In 1869, however, he resigned in order to become postmaster of St Louis, where he died on the 30th of January 1897.

SMITH, CHARLES EMORY (1842–1908), American journalist and political leader, was born in Mansfield, Connecticut, on the 18th of February 1842. In 1849 his family removed to Albany, New York, where he attended the public schools and the Albany Academy. He graduated at Union College in 1861, was a recruiting officer on the staff of General John F. Rathbone (1819–1901) in 1861–1862, taught in the Albany Academy in 1862–1865, and was editor of the *Albany Express* in 1865–1870; joined the staff of the *Albany Journal* in 1870, and was editor-in-chief of this paper from 1876 to 1880. In 1879–1880 he was a regent of the University of the State of New York. From 1880 until his death he was editor and part proprietor of the *Philadelphia Press*. He was active as a Republican in state and national politics; was chairman of the Committee on Resolutions of the New York State Republican Conventions from 1874 to 1880 (excepting 1877), and was president of the convention of 1879; and was a delegate to several National Republican Conventions, drafting much of the Republican platforms of 1876 and 1896. In 1890–1892 he was United States minister to Russia, and during that period had charge of distributing among the Russian famine sufferers more than \$100,000 in money, and five shiploads of food. He was postmaster-general in the cabinet of Presidents McKinley and Roosevelt from April 1898 until January 1902, and did much to develop the rural free delivery system. He died in Philadelphia on the 19th of January 1908.

SMITH, CHARLES FERGUSON (1807–1862), American soldier, graduated from West Point Academy in 1825, and a few years later became an instructor there, rising eventually to be commandant. As a battalion commander he distinguished himself at the Mexican War, at Palo Alto, Resaca, Monterey and Churubusco. He commanded the Red River expedition of 1856, and served under Albert Sidney Johnston in Utah (1857–1860). On the outbreak of the Civil War in 1861 he accepted a commission as brigadier-general of Union volunteers, and found himself under the command of Grant, who had been his pupil at West Point. This difficult situation was made easy by Smith's loyalty to his young chief, and the old soldier led his division of raw volunteers with success at Fort Donelson. His ripe experience, dignity, and unselfish character made him Grant's mainstay in the early days. He went up the Tennessee with the first expedition, but at Savannah, Tennessee, met with a serious accident. His senior brigadier led his division at the battle of Shiloh and he died on April 25, 1862. The early close of his career in high command deprived the Union army of one of its best leaders, and his absence was nowhere more felt than on the battlefield of Shiloh, where the Federals paid heavily for the inexperience of their generals. A month before his death he had been made major-general of volunteers.

SMITH, CHARLOTTE (1749–1806), English novelist and poet, eldest daughter of Nicholas Turner of Stoke House, Surrey, was born in London on the 4th of May 1749. She left school when she was twelve years old to enter society. She married in 1765 Benjamin Smith, son of a merchant who was a director of the East India Company. They lived at first with her father-in-law, who thought highly of her business abilities, and wished to keep her with him; but in 1774 Charlotte and her husband went to live in Hampshire. The elder Smith died in 1776, leaving a complicated will, and six years later Benjamin Smith was imprisoned for debt. Charlotte Smith's first publication was *Elegiac Sonnets*

and other Essays (1784), dedicated by permission to William Hayley, and printed at her own expense. For some months Mrs Smith and her family lived in a tumble-down château near Dieppe, where she produced a translation of *Manon Lescaut* (1785) and a *Romance of Real Life* (1786), borrowed from *Les Causes Célèbres*. On her return to England Mrs Smith carried out a friendly separation between herself and her husband, and thenceforward devoted herself to novel writing. Her chief works are:—*Emmeline, or the Orphan of the Castle* (1788); *Celestina* (1792); *Desmond* (1792); *The Old Manor House* (1793); *The Young Philosopher* (1798); and *Conversations introducing Poetry* (1804). She died at Tilford, near Farnham, Surrey, on the 28th of October 1806. She had twelve children, one of whom, Lionel (1778–1842), rose to the rank of lieutenant-general in the army. He became K.C.B. in 1832 and from 1833 to 1839 was governor of the Windward and Leeward Islands.

Charlotte Smith's novels were highly praised by her contemporaries and are still noticeable for their ease and grace of style. Hayley said that *Emmeline*, considering the situation of the author, was the most wonderful production he had ever seen, and not inferior to any book in that fascinating species of composition (Nichols, *Illustrations of Literature*, vii. 708). The best account of Mrs Smith is by Sir Walter Scott, and is based on material supplied by her sister, Mrs Dorset, with a detailed criticism of her work by Scott (*Misc. Prose Works*, 1841, i. 348–359). Charlotte Smith is best remembered by her charming poems for children.

SMITH, COLVIN (1795–1875), Scottish portrait-painter, was born at Brechin, Scotland, in 1795. He studied in London in the schools of the Royal Academy and worked in Nollekens's studio. He then proceeded to Italy, where he executed some fine copies from Titian; and at Antwerp he made studies from the works of Rubens. Returning to Scotland in 1827, he settled in Edinburgh, occupying the house and studio which had formerly belonged to Raeburn. Soon he attained a wide practice as a portrait-painter, and among his sitters were Lord Jeffrey, Henry Mackenzie, author of *The Man of Feeling*, and many of the most celebrated Scotsmen of the time. His portrait of Sir Walter Scott was so popular that he executed some twenty replicas of it, for seven of which he received fresh sittings. His works are distinguished by excellent draftsmanship, by directness and simplicity of treatment, and by well-marked individuality. He died in Edinburgh on the 21st of July 1875.

SMITH, EDMUND KIRBY (1824–1893), Confederate general in the American Civil War, was the son of Joseph Lee Smith (1776–1846), an American lawyer and soldier, who served with credit in the War of 1812 and rose to the rank of colonel U.S.A. His elder brother, Ephraim Kirby Smith (1807–1847), also a soldier, fell at Molino del Rey; and Joseph Lee Kirby Smith, Ephraim's son, who took the Federal side in the Civil War, was mortally wounded at the battle of Corinth, having at the age of twenty-six attained the rank of brevet-colonel U.S.A. Edmund Kirby Smith was born at St Augustine, Fla., on the 16th of May 1824, and graduated at West Point in 1845, being assigned to the infantry. In the Mexican War he was breveted first lieutenant, and captain for gallantry at Vera Cruz and Cerro Gordo and at Contreras-Churubusco. He was assistant professor of mathematics at West Point from 1849 to 1852 and was later engaged in Indian warfare on the Texas frontier. In 1861 he attained the rank of major. When Florida seceded he resigned his army commission and entered the Confederate service as a lieutenant-colonel. He was made a brigadier-general on the 17th of June 1861, and was wounded at the battle of Bull Run (*q.v.*). In command of the Confederate forces in the Cumberland Gap region Kirby Smith took part in General Bragg's invasion of Kentucky in the autumn of 1862, and inflicted upon the Federal forces a severe defeat at Richmond, Ky., on the 30th of August; and was present at the battles of Perryville and Murfreesboro (Stone River). From February 1863 to the fall of the Confederacy he was in command of the trans-Mississippi department, and was successful in making this section of the Confederacy (isolated from the rest by the fall of Vicksburg) self-supporting. He instituted a regular system of blockade-running, and met and defeated the Red River expedition under

General N. P. Banks in 1864. Kirby Smith and his troops surrendered on the 26th of May 1865, being the last armed forces of the Confederate States to do so. After the war, he was from 1866 to 1868 president of the Atlantic and Pacific Telegraph company, from 1868 to 1870 president of the Western Military Academy, from 1870 to 1875 chancellor of the university of Nashville, and from 1875 to his death professor of mathematics at the university of the South, Sewanee, Tennessee. He died at Sewanee on the 28th of March 1893.

SMITH, FRANCIS HOPKINSON (1838–), American author, artist and engineer, was born in Baltimore, Maryland, on the 23rd of October 1838, a descendant of Francis Hopkinson, one of the signers of the Declaration of Independence. He became a contractor in New York City and did much work for the Federal government, including the stone ice-breaker at Bridgeport, Connecticut, the jetties at the mouth of the Connecticut river, the foundation for the Bartholdi Statue of Liberty in New York harbour, the Race Rock Lighthouse off New London, Conn., and many life-saving stations. His vacations were spent sketching in the White Mountains, in Cuba, in Mexico, and afterwards in Venice, Constantinople and Holland. He published various volumes of travel, illustrated by himself; they include *Old Lines in New Black and White* (1885); *Well-Worn Roads* (1886); *A White Umbrella in Mexico* (1889); *Gondola Days* (1897), and *The Venice of To-Day* (1897). His novels and short stories are especially felicitous in their portrayal of the Old South. Among them are: *Col. Carter of Cartersville* (1891), which was successfully dramatized; *A Day at La Guerre's and other Days* (1892); *A Gentleman Vagabond* (1895); *Tom Grogan* (1896); *Caleb West, Master-Diver* (1898); *The Other Fellow* (1899); *The Fortunes of Oliver Horn* (1902), which has reminiscences of his artist friends; *Col. Carter's Christmas* (1904); *At Close Range* (1905); *The Tides of Barneget* (1906); *The Veiled Lady* (1907); *The Romance of an Old Fashioned Gentleman* (1907); *Peter* (1908); and *Forty Minutes Late and Other Stories* (1909).

SMITH, GEORGE (1789–1846), British publisher, founder of the firm of Smith, Elder & Co., was born in Scotland in 1789. From Elgin, where he was apprenticed to a bookseller, he migrated to London, where he found employment first with Rivingtons, and afterwards with John Murray. In 1816 Smith and another Scot, Alexander Elder, began business at 158 Fenchurch Street as booksellers and stationers; and in 1819 they became publishers also. It was here that **GEORGE SMITH (2)** (1824–1901), the most famous member of the firm, was born on the 19th of March 1824; and in the same year the business was removed to 65 Cornhill. At the age of fourteen George Smith (2) came into the business, and in 1843 he took over the control of the publishing department. On his father's death in 1846 the responsibility of the business devolved principally upon him, and under his management it increased thirteen times in twenty years. A large portion of the business was connected with foreign agencies and banking, especially with India, but this was relinquished in 1868 to his partner Henry S. King, who now separated from the firm, retaining the old premises at Cornhill, while Smith removed the publishing business, now under his sole control, to 15 Waterloo Place. For over thirty years Smith was the friend and publisher of Ruskin, and it was with him that *Jane Eyre* found a publisher. In 1855 was started the *Overland Mail*, a weekly periodical for Indian readers, and the *Homeward Mail*, containing Indian news for English readers. By Smith, Elder & Co. were issued works by Darwin, Ruskin, Thackeray, Robert and Mrs Browning, Wilkie Collins, Matthew Arnold, Miss Martineau, James Payn and Mrs Humphry Ward. In 1866 was published Trollope's *Last Chronicles of Barset*, for which £3000 was paid. In January 1860 the first of George Smith's three great undertakings was begun, the *Cornhill Magazine* being issued in that month under the editorship of Thackeray. The second venture was the founding in 1865 of the *Pall Mall Gazette* (see **NEWSPAPERS**). The third and most important was the publication of the *Dictionary of National Biography*, the first volume of which was issued in 1882; it was completed in 1901, in 66 volumes; and this

monumental work was the crowning effort of a successful career. Smith was a rich man, not only from his publishing business, but on account of his large ownership in the mineral water Apollinaris and other ventures. His second son, Alexander Murray Smith, joined the firm in 1890, and with him was associated in 1894 his brother-in-law Reginald J. Smith, who in 1899 became acting partner. George Smith himself died at Byfleet, near Weybridge, on the 6th of April 1901.

See the memoir (1901) of George Smith (2) prefixed to vol. i. of the supplement to the *Dictionary of National Biography*; reminiscences contributed to the *Cornhill Magazine* (Nov. 1900–Feb. 1901) by George Smith; an article by Sir Leslie Stephen in the same magazine (May 1901); and the special number of the *Cornhill* in January 1910, published on its 50th anniversary.

SMITH, GEORGE ["George Smith of Coalville"] (1831–1895), English philanthropist, was born near Tunstall, Staffordshire, on the 16th of February 1831. His father was a brickmaker, and when nine years old George Smith was working thirteen hours a day in the brickfields. Nevertheless he contrived to obtain some education, so that in time he improved his position, becoming manager of a brick and tile works. In 1857 he discovered, at Coalville, Leicestershire, valuable seams of clay, and on the strength of this discovery organized a large brick-making business there. He advocated legislation in the interests of brickmakers, and in particular called attention to the cruelty suffered in the brickfields by child-workers, whose claims he pressed at the Social Science congresses. In 1871 he published *The Cry of the Children*. This work awoke the interest of the (seventh) earl of Shaftesbury and of A. J. Mundella, and, in the same year, was passed an act providing for the government inspection of brick-yards, and the regulation of juvenile and female labour there. Smith's share in this act aroused great antagonism, and at the end of 1872 he was dismissed from his position at Coalville, and reduced to great poverty. Nevertheless he turned his attention to the conditions of life of the hundred thousand persons living on canals. As the result of his representations on the subject the Canal Boats Bill was introduced by Mr Sclater-Booth (afterwards Lord Basing). This bill, which came into force in 1878, provided for the education of children on canal boats, and regulated the sanitary condition of life on board. In 1884 was passed another bill strengthening the provisions of the first. From that date onwards Smith devoted his attention to improving the condition of Gipsy children which he had described in his *Gipsy Life* (1880). A Moveable Dwellings Bill embodying his views was several times introduced into parliament, but always defeated. In 1885 Smith received a grant from the royal bounty fund. He died at Crick near Rugby on the 21st of June 1895.

See *George Smith of Coalville, the Story of an Enthusiast*, by E. Hodder (1896).

SMITH, GEORGE (1840–1876), English Assyriologist, was born on the 26th of March 1840 at Chelsea, London. His father was a working man, and at fourteen the boy was apprenticed to Messrs Bradbury and Evans to learn bank-note engraving. He had already shown a keen interest in the explorations of Layard and Rawlinson, and during the next few years he devoted all his spare time to studying the cuneiform inscriptions at the British Museum. His earnestness attracted the attention of Sir Henry Rawlinson, who permitted him the use of his room at the museum and placed the many casts and squeezes of the inscriptions at his disposal. Smith was thus enabled to make his first discovery (the date of the payment of the tribute by Jehu to Shalmanezar), and Sir Henry suggested to the trustees of the Museum that he should be associated with himself in the preparation of the third volume of *Cuneiform Inscriptions of Western Asia*. Accordingly, in 1867, Smith was appointed assistant in the Assyriology department, and the earliest of his successes was the discovery of two inscriptions, one fixing the date of the total eclipse of the sun in the month Sivan in May 763 B.C., and the other the date of an invasion of Babylonia by the Elamites in 2280 B.C. In 1871 he published *Annals of Assur-bani-pal*, transliterated and translated, and communicated to the newly-founded Society of Biblical Archaeology a paper on "The Early History of Babylonia," and an account of his decipherment of the

Cypriote inscriptions. In 1872 Smith achieved world-wide fame by his translation of the Chaldaean account of the Deluge, which was read before the Society of Biblical Archaeology on the 3rd of December. In the following January Sir Edwin Arnold, the editor of the *Daily Telegraph*, arranged with Smith that he should go to Nineveh at the expense of that journal, and carry out excavations with a view to finding the missing fragments of the Deluge story. This journey resulted not only in the discovery of the missing tablets, but of fragments which recorded the succession and duration of the Babylonian dynasties. In 1874 Smith again left England for Nineveh, this time at the expense of the Museum, and continued his excavations at Kouyunjik. An account of his work is given in *Assyrian Discoveries*, published early in 1875. The rest of the year was spent in fixing together and translating the fragments relating to the Creation, the results of which work were embodied in *The Chaldaean Account of Genesis*. In March 1876 the trustees of the British Museum despatched Smith once more to excavate the rest of Assur-bani-pal's library. At Ikisji, a small village about 60 m. N.E. of Aleppo, he was prostrated by fever, and finally died at Aleppo on the 19th of August. He left a wife and children, on whose behalf a public subscription was made.

SMITH, GEORGE ADAM (1856–), Scottish divine, was born in Calcutta on the 19th of October 1856, where his father, George Smith, C.I.E., was then principal of the Doveton College. He was educated at Edinburgh in the Royal High School, the University and New College. After studying at Tübingen and Leipzig and travelling in Egypt and Syria, he entered the ministry of the Free Church of Scotland and was appointed professor of Old Testament subjects in the Free Church College at Glasgow 1892. In 1909 he was appointed principal of the University of Aberdeen.

Among his works are *The Book of Isaiah* (2 vols., 1888–1890); *The Book of the Twelve Prophets* (2 vols., 1876–1877); *Historical Geography of the Holy Land* (1894); *Jerusalem* (2 vols., 1907); *The Preaching of the Old Testament to the Age* (1893); *The Life of Henry Drummond* (1898).

SMITH, GERRIT (1797–1874), American reformer and philanthropist, was born in Utica, New York, on the 6th of March 1797. After graduating at Hamilton College in 1818, he assumed the management of the vast estate of his father, Peter Smith (1768–1837), long a partner of John Jacob Astor, and greatly increased the family fortune. About 1828 he became an active worker in the cause of temperance, and in his home village, Peterboro, he built one of the first temperance hotels in the country. He became an abolitionist in 1835, after seeing an anti-slavery meeting at Utica broken up by a mob. In 1840 he took a leading part in the organization of the Liberty party, and in 1848 and 1852 he was nominated for the presidency by the remnant of this organization that had not been absorbed by the Free Soil party. An "Industrial Congress" at Philadelphia also nominated him for the presidency in 1848, and the "Land Reformers" in 1856. In 1840 and in 1858 he was a candidate for the governorship of New York on an anti-slavery platform. In 1853 he was elected to the National House of Representatives as an independent, and issued an address declaring that all men have an equal right to the soil; that wars are brutal and unnecessary; that slavery could be sanctioned by no constitution, state or federal; that free trade is essential to human brotherhood; that women should have full political rights; that the Federal government and the states should prohibit the liquor traffic within their respective jurisdictions; and that government officers, so far as practicable, should be elected by direct vote of the people. At the end of the first session he resigned his seat. After becoming an opponent of land monopoly, he gave numerous farms of fifty acres each to indigent families, and also attempted to colonize tracts in N. New York with free negroes; but this experiment was a failure. Peterboro became a station on the "underground railroad"; and after 1850 Smith furnished money for the legal expenses of persons charged with infractions of the Fugitive Slave Law. With John Brown, to whom he gave a farm in Essex county, New York, he became very intimate, and from time to time supplied him with funds, though it seems

without knowing that any of the money would be employed in an attempt to incite a slave insurrection. Under the excitement following the raid on Harper's Ferry he became temporarily insane, and for several weeks was confined in an asylum in Utica. He favoured a vigorous prosecution of the Civil War, but at its close advocated a mild policy toward the late Confederate states, declaring that part of the guilt of slavery lay upon the North. He even became one of the securities for Jefferson Davis, thereby incurring the resentment of Northern radical leaders.

In religion as in politics Gerrit Smith was a radical. Believing that sectarianism was sinful, he separated from the Presbyterian Church in 1843, and was one of the founders of the Church at Peterboro, a non-sectarian institution open to all Christians of whatever shade of belief. His private benefactions were boundless; of his gifts he kept no record, but their value is said to have exceeded \$8,000,000. Though a man of great wealth his life was one of marked simplicity. He died on the 28th of December 1874, while on a visit to relatives in New York City.

See O. B. Frothingham, *Gerrit Smith: a Biography* (New York, 1879).

SMITH, GOLDWIN (1824–1910), British historian and publicist, was born at Reading on the 20th of August 1824. He was educated at Eton and Magdalen College, Oxford, and after an undergraduate career of exceptional brilliancy was elected to a fellowship at University College. He threw his keen intellect and trenchant style into the cause of university reform, the leading champion of which was another fellow of University College, Arthur Penrhyn Stanley. On the Royal Commission of 1850 to inquire into the reform of the university, of which Stanley was secretary, he served as assistant-secretary; and he was secretary to the commissioners appointed by the act of 1854. His position as an authority on educational reform was further recognized by a seat on the Popular Education Commission of 1858. In 1868, when the question of reform at Oxford was again growing acute, he published a brilliant pamphlet, entitled *The Reorganization of the University of Oxford*. Besides the abolition of tests, effected by the act of 1871, many of the reforms there suggested, such as the revival of the faculties, the reorganization of the professoriate, the abolition of celibacy as a condition of the tenure of fellowships, and the combination of the colleges for lecturing purposes, were incorporated in the act of 1877, or subsequently adopted by the university. He gave the counsel of perfection that "pass" examinations ought to cease; but he recognized that this change "must wait on the reorganization of the educational institutions immediately below the university, at which a passman ought to finish his career." His aspiration that colonists and Americans should be attracted to Oxford has been realized by Mr Rhodes's will. On what is perhaps the vital problem of modern education, the question of ancient *versus* modern languages, he pronounced that the latter "are indispensable accomplishments, but they do not form a high mental training"—an opinion entitled to peculiar respect as coming from a president of the Modern Language Association. The same conspicuous openness of mind appears in his judgment, delivered after he had held the regius professorship of Modern History at Oxford from 1858 to 1866, that "ancient history, besides the still unequalled excellence of the writers, is the best instrument for cultivating the historical sense." As a historian, indeed, he left no abiding work; the multiplicity of his interests prevented him from concentrating on any one subject. His chief historical writings—*The United Kingdom: a Political History* (1899), and *The United States: an Outline of Political History* (1893)—though based on thorough familiarity with their subject, make no claim to original research, but are remarkable examples of terse and brilliant narrative.

The outbreak of the American Civil War proved a turning-point in his life. Unlike most men of the ruling classes in England, he warmly championed the cause of the North, and his pamphlets, especially one entitled *Does the Bible sanction American Slavery?* (1863), played a prominent part in converting English opinion. Visiting America on a lecture tour in 1864, he received an enthusiastic welcome, and was entertained at a

public banquet in New York. In 1868 he threw up his career in England and settled in the United States, where he held the professorship of English and Constitutional History at Cornell University till 1871. In that year he removed to Toronto, where he edited the *Canadian Monthly*, and subsequently founded the *Week* and the *Bystander*. He did not, however, cease to take an active interest in English politics. He had been a strong supporter of Irish Disestablishment, but he refused to follow Gladstone in accepting Home Rule. He expressly stated that "if he ever had a political leader, his leader was John Bright, not Mr Gladstone." Speaking in 1886, he referred to his "standing by the side of John Bright against the dismemberment of the great Anglo-Saxon community of the West, as I now stand against the dismemberment of the great Anglo-Saxon community of the East." These words form the key to his views of the future of the British Empire. He always maintained that Canada, separated by great barriers, running north and south, into four zones, each having unimpeded communication with the adjoining portions of the United States, was destined by its natural configuration to enter into a commercial union with them, which would result in her breaking away from the British empire, and in the union of the Anglo-Saxons of the American continent into one great nation. These views are most fully stated in his *Canada and the Canadian Question* (1891). Though describing himself as "anti-Imperialistic to the core," he was yet deeply penetrated with a sense of the greatness of the British race. Of the British empire in India he said that "it is the noblest the world has seen. . . . Never had there been such an attempt to make conquest the servant of civilization. About keeping India there is no question. England has a real duty there." His fear was that England would become a nation of factory-workers, thinking more of their trade-union than of their country. These forebodings were intensified in his *Commonwealth or Empire?* (1902)—a warning to the United States against the assumption of imperial responsibilities. Among other causes that he powerfully attacked were liquor prohibition, female suffrage and State Socialism. All these are discussed in his *Essays on Questions of the Day* (revised edition, 1894). He also published sympathetic monographs on *Cowper* and *Jane Austen*, and attempted verse in *Bay Leaves* and *Specimens of Greek Tragedy*. In his *Guesses at the Riddle of Existence* (1897), he abandons the faith in Christianity expressed in his lecture of 1861 on Historical Progress (where he forecast the speedy reunion of Christendom on the "basis of free conviction"), and writes in a spirit "not of Agnosticism, if Agnosticism imports despair of spiritual truth, but of free and hopeful inquiry, the way for which it is necessary to clear by removing the wreck of that upon which we can found our faith no more." In his later years he expressed his views in a weekly journal, *The Farmer's Sun*, and published in 1904 *My Memory of Gladstone*, while occasional letters to the *Spectator* showed that he had lost neither his interest in English politics and social questions nor his remarkable gifts of style. He died at his residence, The Grange, Toronto, on the 7th of June 1910.

Goldwin Smith left in manuscript a book of reminiscences, which was edited by Mr Arnold Haultain, his private secretary.

SMITH, HENRY BOYNTON (1815–1877), American theologian, was born in Portland, Maine, on the 21st of November 1815. He graduated at Bowdoin College in 1834; studied theology at Andover, where his health failed, at Bangor, and, after a year (1836–1837) as librarian and tutor in Greek at Bowdoin, in Germany at Halle, where he became personally intimate with Tholuck and Ulrici, and in Berlin, under Neander and Hengstenberg. He returned to America in 1840, was a tutor for a few months (1840–1841) at Bowdoin, and in 1842, shut out from any better place by distrust of his German training and by his frank opposition to Unitarianism, he became pastor of the Congregational Church of West Amesbury (now Merrimac), Massachusetts. In 1847–1850 he was professor of moral philosophy and metaphysics at Amherst; and in 1850–1854 was Washburn professor of Church history, and in 1854–1874 Roosevelt professor of systematic theology, at Union Theological

Seminary. His health failed in 1874 and he died in New York City on the 7th of February 1877. Of the old school of the "New England Theology," Smith was one of the foremost leaders of the new school Presbyterians. His theology is most strikingly contained in the Andover address, "Relations of Faith and Philosophy," which was delivered before the Porter Rhetorical Society in 1849. He always made it clear that the ideal philosophy was Christocentric: he said that Reformed theology must "Christologize" predestination and decrees, regeneration and sanctification, the doctrine of the Church, and the whole of the Eschatology."

His son HENRY GOODWIN SMITH (b. 1860) was pastor of the Freehold (New Jersey) Presbyterian Church in 1886–1896, and from 1897 to 1903 was professor of systematic theology in Lane Theological Seminary.

From notes of his lectures, William S. Karr prepared two volumes of Dr Smith's theological writings, *Introduction to Christian Theology* (1883) and *System of Christian Theology* (1884). Dr Smith contributed articles on Calvin, Kant, Pantheism, Miracles, Reformed Churches, Schelling and Hegel to the *American Cyclopaedia*, and contributed to McClintock and Strong's *Cyclopaedia*; and was editor of the *American Theological Review* (1859 sqq.), both in its original form and after it became the *American Presbyterian and Theological Review* and, later, the *Presbyterian Quarterly and Princeton Review*.

See E. L. (Mrs H. B.) Smith, *Henry Boynton Smith, His Life and Works* (New York, 1881), and Lewis F. Stearns, *Henry Boynton Smith* (Boston, 1892), in the American Religious Leaders series.

SMITH, SIR HENRY GEORGE WAKELYN, Bart. (1787–1860), British general, son of John Smith, surgeon, of Whittlesey, Cambridgeshire, was born at that place on the 28th of June 1787. Harry Smith—for throughout life he adopted the more familiar form of his Christian name—was educated privately and entered the army in 1805. His first active service was in South America in 1806, and he subsequently served through the Peninsular War from the concentration at Salamanca in November 1808 to the battle of Toulouse on the 10th of April 1814. On the day following the storming of Badajos (the 6th of April 1812) a well-born Spanish lady, whose entire property in the city had been destroyed, presented herself at the British lines seeking protection from the licence of the soldiery for herself and her sister, a child of fourteen, by whom she was accompanied. The latter, whose name was Juana Maria de Los Dolores de Leon, had but recently emerged from a convent; but notwithstanding her years she was married to Harry Smith a few days later. She remained with him throughout the rest of the war, accompanying the baggage train, sleeping in the open on the field of battle, riding freely among the troops, and sharing all the privations of campaigning. Her beauty, courage, sound judgment and amiable character endeared her to the officers, including the duke of Wellington, who spoke of her familiarly as Juanita; and she was idolized by the soldiers. At the close of the war Harry Smith volunteered for service in the United States, where he was present at the battle of Bladensburg (the 24th of August 1814), and witnessed the burning of the capitol at Washington; which, as he said, "horrified us coming fresh from the duke's humane warfare in the south of France." Returning to Europe he was brigade-major at Waterloo; and in 1828 was ordered to the Cape of Good Hope, where he commanded a division in the Kaffir War of 1834–36. In 1835 he accomplished the feat of riding from Cape Town to Graham's Town, a distance of 600 m., in less than six days; and having restored confidence among the whites by his energetic measures, he was appointed governor of the new Province of Queen Adelaide, where he gained unbounded influence over the native tribes, whom he vigorously set himself to civilize and benefit. But though supported by Sir Benjamin D'Urban, the high commissioner, the ministry in London reversed his policy and—to quote Smith's own words—"directed the Province of Queen Adelaide to be restored to barbarism." Smith himself was removed from his command, his departure being deplored alike by the Kaffirs and the Dutch; and numbers of the latter, largely in consequence of this policy of Lord Glenelg, began the migration to the interior known as "the great trek."

Harry Smith was now appointed deputy-adjutant-general of

the forces in India, where he took part in the Gwalior campaign of 1843 (for which he received a K.C.B.) and the Sikh War of 1845–46. He was in command of a division under Sir Hugh Gough at the battles of Moodkee and Ferozeshah, where he conspicuously distinguished himself, but was insufficiently supported by the commander-in-chief. After the second of these actions Sir Harry Smith was appointed to an independent command, and on the 28th of January 1846 he inflicted a crushing defeat on the Sikhs at Aliwal on the Sutlej. At Sobraon on the 10th of February he again commanded a division under Gough. For the great victory of Aliwal he was awarded the thanks of parliament; and the speech of the duke of Wellington was perhaps the warmest encomium ever bestowed by that great commander on a meritorious officer. Sir Harry was at the same time created a baronet; and as a special distinction the words "of Aliwal" were by the patent appended to the title. In 1847 he returned to South Africa as governor of Cape Colony and high commissioner, to grapple with the difficulties he had foreseen eleven years before (see CAPE COLONY: *History*). He took command of an expedition to deal with the disaffected Boers in the Orange River Sovereignty, and fought the action of Boomplaats on the 20th of August 1848. In December 1850 war broke out with the Kaffirs; Sir Harry Smith was insufficiently supplied with troops from England; and though his conduct of the operations was warmly approved by the duke of Wellington and other military authorities, Lord Grey, in a despatch never submitted to the queen, recalled him in 1852 before the Kaffirs had been completely subdued. He protested strongly against the abandonment of the Orange River Sovereignty to the Boers, which was carried out two years after his departure, and he actively furthered the granting of responsible government to Cape Colony. His Spanish wife was his constant companion in his second as in his earlier sojourn in South Africa, where her memory is recalled by the town of Ladysmith in Natal (rendered famous by the Boer War of 1899–1902), as is that of her husband by Harrismith in the Orange Free State; while Aliwal North, founded in 1849 and named after his great Indian victory, further commemorates Sir Harry Smith. On his return to England he held a military appointment for some years, and died in London on the 12th of October 1860. Juana, Lady Smith, survived till 1872.

See *Autobiography of Sir Harry Smith*, edited by G. C. Moore Smith (1901); R. S. Rait, *Life of Viscount Gough* (1903); Wilmot and Chase, *Annals of the Cape Colony* (1869); J. Noble, *South Africa* (1877); Theal's *History of South Africa*, vol. iv. (R. J. M.)

SMITH, HENRY JOHN STEPHEN (1826–1883), English mathematician, was born in Dublin on the 2nd of November 1826, and was the fourth child of his parents. When Henry Smith was just two years old his father died, whereupon his mother left Ireland for England. After being privately educated by his mother and tutors, he entered Rugby school in 1841. Whilst under the first of these tutors, in nine months he read all Thucydides, Sophocles and Sallust, twelve books of Tacitus, the greater part of Horace, Juvenal, Persius, and several plays of Aeschylus and Euripides. He also studied the first six books of Euclid and some algebra, besides reading a considerable quantity of Hebrew and learning the *Odes* of Horace by heart. On the death of his elder brother in September 1843 Henry Smith left Rugby, and at the end of 1844 gained a scholarship at Balliol College, Oxford. He won the Ireland scholarship in 1848 and obtained a first class in both the classical and the mathematical schools in 1849. He gained the senior mathematical scholarship in 1851. He was elected fellow of Balliol in 1850 and Savilian professor of geometry in 1861, and in 1874 was appointed keeper of the university museum. He was elected F.R.S. in 1861, and was an LL.D. of Cambridge and Dublin. He served on various royal commissions, and from 1877 was the chairman of the managing body of the meteorological office. He died at Oxford on the 9th of February 1883.

After taking his degree he wavered between classics and mathematics, but finally chose the latter. After publishing a few short papers relating to theory of numbers and to geometry, he devoted himself to a thorough examination of the writings of K. F. Gauss,

P. G. Lejeune-Dirichlet, E. E. Kummer, &c., on the theory of numbers. The main results of these researches, which occupied him from 1854 to 1864, are contained in his *Report on the Theory of Numbers*, which appeared in the British Association volumes from 1859 to 1865. This report contains not only a complete account of all that had been done on this vast and intricate subject but also original contributions of his own. Some of the most important results of his discoveries were communicated to the Royal Society in two memoirs upon "Systems of Linear Indeterminate Equations and Congruences" and upon the "Orders and Genera of Ternary Quadratic Forms" (*Phil. Trans.*, 1861 and 1867). He did not, however, confine himself to the consideration of forms involving only three indeterminates, but succeeded in establishing the principles on which the extension to the general case of n indeterminates depends, and obtained the general formulae, thus effecting what is probably the greatest advance made in the subject since the publication of Gauss's *Disquisitiones arithmeticae*. A brief abstract of Smith's methods and results appeared in the *Proc. Roy. Soc.* for 1864 and 1868. In the second of these notices he gives the general formulae without demonstrations. As corollaries to the general formulae he adds the formulae relating to the representation of a number as a sum of five squares and also of seven squares. This class of representation ceases when the number of squares exceeds eight. The cases of two, four and six squares had been given by K. G. J. Jacobi and that of three squares by F. G. Eisenstein, who had also given without demonstration some of the results for five squares. Fourteen years later the Académie Française, in ignorance of Smith's work, set the demonstration and completion of Eisenstein's theorems for five squares as the subject of their "Grand Prix des Sciences Mathématiques." Smith, at the request of a member of the commission by which the prize was proposed, undertook in 1882 to write out the demonstration of his general theorems so far as was required to prove the results for the special case of five squares. A month after his death, in March 1883, the prize of 3000 francs was awarded to him. The fact that a question of which Smith had given the solution in 1867, as a corollary from general formulae governing the whole class of investigations to which it belonged, should have been set by the Académie as the subject of their great prize shows how far in advance of his contemporaries his early researches had carried him. Many of the propositions contained in his dissertation are general; but the demonstrations are not supplied for the case of seven squares. He was also the author of important papers in which he extended to complex quadratic forms many of Gauss's investigations relating to real quadratic forms. After 1864 he devoted himself chiefly to elliptic functions, and numerous papers on this subject were published by him in the *Proc. Lond. Math. Soc.* and elsewhere. At the time of his death he was engaged upon a memoir on the *Theta and Omega Functions*, which he left nearly complete. In 1868 he was awarded the Steiner prize of the Berlin Academy for a geometrical memoir, *Sur quelques problèmes cubiques et biquadratiques*. He also wrote the introduction to the collected edition of Clifford's *Mathematical Papers* (1882). The three subjects to which Smith's writings relate are theory of numbers, elliptic functions and modern geometry; but in all that he wrote an "arithmetical" mode of thought is apparent, his methods and processes being arithmetical as distinguished from algebraic. He had the most intense admiration of Gauss. He was president of the mathematical and physical section of the British Association at Bradford in 1873 and of the London Mathematical Society in 1874-1876. His *Collected Papers* were edited by J. W. L. Glaisher and published in 1894.

An article in the *Spectator* of the 17th of February 1883, by Lord Justice Bowen, gives perhaps the best idea of Smith's extraordinary personal qualities and influence. See also J. W. L. Glaisher's memoir in the *Monthly Notices of the Roy. Ast. Soc.* (vol. xlv., 1884).

SMITH, HENRY PRESERVED (1847-), American Biblical scholar, was born in Troy, Ohio, on the 23rd of October 1847. He graduated at Amherst College in 1869 and studied theology in Lane Theological Seminary in 1869-1872, in Berlin in 1872-1874 and in Leipzig in 1876-1877. He was instructor in church history in 1874-1875, and in Hebrew in 1875-1876, and was assistant-professor in 1877-1879 and professor in 1879-1893 of Hebrew and Old Testament exegesis in Lane Theological Seminary. In 1892 he was tried for heresy by the Presbytery of Cincinnati, was found guilty of teaching (in a pamphlet entitled *Biblical Scholarship and Inspiration*, 1891) that there were "errors of historic fact," suppressions of "historic truths," &c., in the books of Chronicles, and that the "inspiration of the Holy Scriptures is consistent with the unprofitableness of portions of the sacred writings,"—in other words, that inspiration does not imply inerrancy,—and he was suspended from the ministry. Dr Smith retired from the denomination, and in 1893, upon becoming a professor at Andover Theological Seminary, entered the ministry of the Congregational Church. From 1897 to 1906

he was a professor in Amherst College, and in 1907 became a professor in the Meadville (Pennsylvania) Theological School.

He published *The Bible and Islam* (1897), *Commentary on the Books of Samuel* (1899, in the "International Critical Commentary") and *Old Testament History* (1903, in the "International Theological Library"). In *Inspiration and Inerrancy* (Cincinnati, 1893), he reprinted the papers on which the heresy charge was made, and outlined the case.

SMITH, JAMES (1775-1839), and **HORACE** (1779-1849), authors of the *Rejected Addresses*, sons of a London solicitor, were born, the former on 10th February 1775 and the latter on 31st December 1779, both in London. The occasion of their happy *jeu d'esprit* was the rebuilding of Drury Lane theatre in 1812, after a fire in which it had been burnt down. The managers had offered a prize of £50 for an address to be recited at the re-opening in October. Six weeks before that date the happy thought occurred to the brothers Smith of feigning that the most popular poets of the time had been among the competitors and issuing a volume of unsuccessful addresses in parody of their various styles. They divided the task between them, James taking Wordsworth, Southey, Coleridge and Crabbe, while Byron, Moore, Scott and Bowles were assigned to Horace.¹ Seven editions were called for within three months. The *Rejected Addresses* are the most widely popular parodies ever published in England, and take classical rank in literature. The brothers fairly divided the honours: the elder brother's Wordsworth is evenly balanced by the younger's Scott, and both had a hand in Byron. A striking feature is the absence of malice; none of the poets caricatured took offence, while the imitation is so clever that both Byron and Scott are recorded to have said that they could hardly believe they had not written the addresses ascribed to them. The only other undertaking of the two brothers was *Horace in London* (1813). James Smith made another hit in writing *Country Cousins*, *A Trip to Paris*, *A Trip to America*, and other lively skits for Charles Mathews who said he was "the only man who can write clever nonsense." His social reputation as a wit stood high. He was reputed one of the best of talkers in an age when the art was studied, and it was remarked that he held his own without falling into the great error of wits—sarcasm. But in his old age the irreverent *Fraser's* put him in its gallery of living portraits as a gouty and elderly but painstaking joker. He died in London on the 24th of December 1839. After making a fortune as a stockbroker, Horace Smith followed in the wake of Scott and wrote about a score of historical novels—*Brambletye House* (1826), *Tor Hill* (1826), *Reuben Apsley* (1827), *Zillah* (1828), *The New Forest* (1829), *Walter Colyton* (1830), &c. His sketches of eccentric character are brilliant and amusing; but he was more of an essayist than a story-teller. Three volumes of *Gaieties and Gravities*, published by him in 1826, contain many witty essays both in prose and in verse, but the only single piece that has taken a permanent place is the "Address to the Mummy in Belzoni's Exhibition." In private life Horace Smith was not less popular than his brother, though less ambitious as a talker. It was of him that Shelley said: "Is it not odd that the only truly generous person I ever knew who had money enough to be generous with should be a stockbroker? He writes poetry and pastoral dramas and yet knows how to make money, and does make it, and is still generous." Horace Smith died at Tunbridge Wells on 12th July 1849.

SMITH, JOHN (1579-1631), usually distinguished as Captain John Smith, sometime president of the English colony in Virginia, was the elder son of George Smith, a well-to-do tenant-farmer on the estate of Lord Willoughby d'Eresby at Willoughby, near Alford in Lincolnshire. The life of this Virginian hero falls conveniently into five periods. The first of these, up to 1596, that of his early youth, is thus described by himself in his *Travels*: "He was born (1579) in Willoughby in Lincolnshire, and was a scholar in the two free schools of Alford and Louth.

¹ The particulars of the authorship are given in the 18th edition (1820), and in the memoir of his brother by Horace prefixed to a collection of fugitive pieces (1840). James contributed the first stanza to the imitation of Byron, but otherwise they worked independently.

His parents, dying (April 1596) when he was thirteen (or rather sixteen) years of age, left him a competent means, which he, not being capable to manage, little regarded. His mind being even then set upon brave adventures, he sold his satchel, books and all he had, intending secretly to get to sea, but that his father's death stayed him. But now the guardians of his estate more regarding it than him, he had liberty enough, though no means, to get beyond the sea. About the age of fifteen years, he was bound an apprentice to Master Thomas Sendall of [King's] Lynn, the greatest merchant of all those parts; but, because he would not presently send him to sea, he never saw his master in eight years after."

The second period, 1596-1604, is that of his adventures in Europe, Asia and Africa. He first went to Orleans in attendance on the second son of Lord Willoughby. Thence he returned to Paris, and so by Rouen to Havre, where, his money being spent, he began to learn the life of a soldier under Henry IV. of France. On the conclusion (1599) of peace with the League, he went with Captain Joseph Duxbury to Holland and served there some time, probably with the English troops in Dutch pay. By this time he had gained a wide experience in the art of war, not merely as an infantry officer, but also in those more technical studies which are now followed by the Royal Engineers. At length he sailed from Enkhuisen to Scotland, and on the voyage had a narrow escape from shipwreck upon Holy Island near Berwick. After some stay in Scotland he returned home to Willoughby, "where, within a short time being glutted with too much company, wherein he took small delight, he retired himself into a little woody pasture, a good way from any town, environed with many hundred acres of other woods. Here by a fair brook he built a pavilion of boughs, where only in his clothes he lay. His study was Machiavelli's *Art of War* and Marcus Aurelius; his exercise a good horse with his lance and ring; his food was thought to be more of venison than anything else; what [else] he wanted his man brought him. The country wondering at such a hermit, his friends persuaded one Signior Theadora Polaloga, rider to Henry, earl of Lincoln, an excellent horseman and a noble Italian gentleman, to insinuate [himself] into his woodish acquaintances, whose languages and good discourse and exercise of riding drew Smith to stay with him at Tattersall. . . . Thus—when France and the Netherlands had taught him to ride a horse and use his arms, with such rudiments of war as his tender years, in those martial schools, could attain unto, he was desirous to see more of the world, and try his fortune against the Turks, both lamenting and repenting to have seen so many Christians slaughter one another."

Next came his wanderings through France from Picardy to Marseilles. There he took ship for Italy in a vessel full of pilgrims going to Rome. These, cursing him for a heretic, and swearing they would have no fair weather so long as he was on board, threw him, like another Jonah, into the sea. He was able to get to a little uninhabited island, from which he was taken off the next morning by a Breton ship of 200 tons going to Alexandria, the captain of which, named La Roche, treated him as a friend. In this ship he visited Egypt and the Levant. On its way back the Breton ship fought a Venetian argosy of 400 tons and captured it. Reaching Antibes (Var) later on, Captain La Roche put Smith ashore with 500 sequins, who then proceeded to see Italy as he had already seen France. Passing through Tuscany he came to Rome, where he saw Pope Clement VIII. at mass, and called on Father R. Parsons. Wandering on to Naples and back to Rome, thence through Tuscany and Venice, he came to Gratz in Styria. There he received information about the Turks who were then swarming through Hungary, and, passing on to Vienna, entered the emperor's service.

In this Turkish war the years 1601 and 1602 soon passed away; many desperate adventures does he narrate (unconfirmed by contemporary records, and doubted by some modern critics), and one in particular covered him with honour. At Regal, in the presence of two armies, as the champion of the Christians, he killed three Turkish champions in succession. On 18th November 1602, at the battle of Rothenthurm, a pass in Transylvania,

where the Christians fought desperately against an overpowering force of Crim Tatars, Smith was left wounded on the field of battle. His rich dress saved him, for it showed that he would be worth a ransom. As soon as his wounds were cured he was sold for a slave and then marched to Constantinople, where he was presented to Charatza Tragabigzanda, who fell in love with him. Fearing lest her mother should sell him, she sent him to her brother Timor, pasha of Nalbrits, on the Don, in Tatarly. "To her unkind brother this kind lady wrote so much for his good usage that he half suspected as much as she intended; for she told him, he should there but sojourn to learn the language, and what it was to be a Turk, till time made her master of herself. But the Timor, her brother, diverted all this to the worst of cruelty. For, within an hour after his arrival, he caused his 'drubman' to strip him naked, and shave his head and beard so bare as his hand. A great ring of iron, with a long stalk bowed like a sickle, was riveted about his neck, and a coat [put on him] made of ulgry's hair, guarded about with a piece of an undressed skin. There were many more Christian slaves, and nearly a hundred *forsados* of Turks and Moors, and he being the last was the slave of slaves to them all." While at Nalbrits the English captain kept his eyes open, and his account of the Crim Tatars is careful and accurate. "So long he lived in this miserable estate, as he became a thresher at a grange in a great field, more than a league from the Timor's house. The pasha, as he oft used to visit his granges, visited him, and took occasion so to beat, spurn and revile him, that forgetting all reason Smith beat out the Timor's brains with his threshing bat, for they have no flails, and, seeing his estate could be no worse than it was, clothed himself in the Timor's clothes, hid his body under the straw, filled his knapsack with corn, shut the doors, mounted his horse and ran into the desert at all adventure." For eighteen or nineteen days he rode for very life until he reached a Muscovite outpost on the river Don; here his irons were taken off him, and the Lady Callamata largely supplied all his wants. Thence he passed, attracting all the sympathy of an escaped Christian slave, through Muscovy, Hungary and Austria until he reached Leipzig in December 1603. There he met his old master, Prince Sigismund, who, in memory of his gallant fight at Regal, gave him a grant of arms and 500 ducats of gold. Thence he wandered on, sightseeing, through Germany, France and Spain, until he came to Saffi, from which seaport he made an excursion to the city of Morocco and back.

While at Saffi he was blown out to sea on board Captain Merham's ship, and had to go as far as the Canaries. There Merham fought two Spanish ships at once and beat them off. Smith came home to England with him, having a thousand ducats in his purse.

The third period, 1605-1609, is that of Captain Smith's experiences in Virginia. Throwing himself into the colonizing projects which were then coming to the front, he first intended to have gone out to the colony on the Oyapok in South America; but, Captain Leigh dying, and the reinforcement miscarrying, "the rest escaped as they could." Hence Smith did not leave England on this account. But he went heartily into the Virginian project with Captain Bartholomew Gosnold and others. He states that what he got in his travels he spent in colonizing. "When I went first to these desperate designs, it cost me many a forgotten pound to hire men to go, and procrastination caused more to run away than went. I have spared neither pains nor money according to my ability, first to procure His Majesty's letters patents, and a company here, to be the means to raise a company to go with me to Virginia, which beginning here and there cost me nearly five years' [1604-1609] work, and more than five hundred pounds of my own estate, besides all the dangers, miseries and incumbrances I endured gratis." Two colonizing associations were formed—the London Company for South Virginia and the Western Company for North Virginia. Smith was one of the patentees of the Virginia charter of 1609. The colony which Sir W. Raleigh had established at Roanoke island off the American coast had perished, mainly for want of supplies from England, so that really nothing at all was known of

the Virginian coast-line when the first expedition left London on 19th December 1606; and therefore the attempt was bound to fail unless a convenient harbour should be found. The expedition consisted of three ships (the "Susan Constant," 100 tons, Captain C. Newport; the "God Speed," 40 tons, Captain B. Gosnold; and a pinnace of 20 tons, Captain J. Ratcliffe), with about 140 colonists and 40 sailors. They made first for the West Indies, reaching Dominica on 24th March 1607. At Nevis, their next stopping-place, a gallows was erected to hang Captain Smith on the false charge of conspiracy; but he escaped, and, though afterwards the lives of all the men who plotted against him were at his mercy, he spared them. Sailing northwards from the West Indies, not knowing where they were, the expedition was most fortunately, in a gale, blown into the mouth of Chesapeake Bay, discovering land on 26th April 1607. Anchoring, they found the James river, and, having explored it, fixed upon a site for their capital in the district of the chief or weroance of Paspaheh, its chief recommendation being that there were 6 fathoms of water so near to the shore that the ships could be tied to the trees. Orders had been sent out for the government of the colony in a box, which was opened on 26th April 1607. Captains B. Gosnold, E. M. Wingfield, C. Newport, J. Smith, J. Ratcliffe, J. Martin and G. Kendall were named to be the council to elect an annual president, who, with the council, should govern. Wingfield was, on 13th May, elected the first president; and the next day they landed at James Town and commenced the settlement.

All this while Smith was under restraint, for thirteen weeks in all. His enemies would have sent him home, out of a sham commiseration for him; but he challenged their charges, and so established his innocency that Wingfield was adjudged to give him £200 as damages. After this, on 20th June 1607, Smith was admitted to the council.

As in going to America in those days the great difficulty was want of water, so in those colonizing efforts the paramount danger was from want of food. "There were never Englishmen left in a foreign country in such misery as we were in this new discovered Virginia. We watched every three nights [every third night], lying on the bare cold ground, what weather soever came, and warded all the next day, which brought our men to be most feeble wretches. Our food was but a small can of barley sodden in water to five men a day. Our drink, cold water taken out of the river, which was, at a flood, very salt, at a low tide, full of slime and filth, which was the destruction of many of our men." So great was the mortality that out of 105 colonists living on the 22nd June 1607 67 died by the following 8th January. The country they had settled in was sparsely populated by many small tribes of Indians, who owned as their paramount chief, Powhatan, who then lived at Werowocomoco, a village on the Pamunkey river, about 12 m. by land from James Town. Various boat expeditions left James Town, to buy food in exchange for copper. They generally had to fight the Indians first, to coerce them to trade, but afterwards paid a fair price for what they bought.

On 10th December 1607 Captain Smith, of whom it is said "the Spaniard never more greedily desired gold than he victail," with nine men in the barge, left James Town to get more corn, and also to explore the upper waters of the Chickahominy. They got the barge up as far as Apocant. Seven men were left in it, with orders to keep in midstream. They disobeyed, went into the village, and one of them, George Cassen, was caught; the other six, barely escaping to the barge, brought it back to James Town. It so happened that Opecanchanough (the brother of Powhatan, whom he succeeded in 1618, and who carried out the great massacre of the English on Good Friday 1621) was in that neighbourhood with two or three hundred Indians on a hunting expedition. He ascertained from Cassen where Smith was, who, ignorant of all this, had, with John Robinson and Thomas Emry, gone in a canoe 20 m. farther up the river. The Indians killed Robinson and Emry while they were sleeping by the camp fire, and went after Smith, who was away getting food. They surprised him, and, though he bravely defended himself, he had at last to

surrender. He then set his wits to confound them with his superior knowledge, and succeeded. Opecanchanough led him about the country for a wonder, and finally, about 5th January 1608, brought him to Powhatan at Werowocomoco. "Having feasted him after their best barbarous manner they could, a long consultation was held; but the conclusion was two great stones were brought before Powhatan; then as many as could laid hands on Smith, dragged him to them, and thereon laid his head. And, being ready with their clubs to beat out his brains, Pocahontas, the king's dearest daughter, when no entreaty could prevail, got his head in her arms and laid her own upon his to save him from death. Whereat the emperor was contented Smith should live, to make him hatchets, and her bells, beads and copper; for they thought him as well of all occupations [handicrafts] as themselves."

The truth of this story was never doubted till 1859, when Dr Charles Deane of Cambridge, Mass., edited Wingfield's *Discourse*; in reprinting Smith's *True Relation* of 1609, Deane pointed out that it contains no reference to this hairbreadth escape. Since then many American historians and scholars have concluded that it never happened at all; and, in order to be consistent, they have tried to prove that Smith was a blustering braggadocio, which is the very last thing that could in truth be said of him. The rescue of a captive doomed to death by a woman is not such an unheard-of thing in Indian stories. If the truth of this deliverance be denied, how then did Smith come back to James Town loaded with presents, when the other three men were killed, George Cassen in particular, in a most horrible manner? And how is it, supposing Smith's account to be false, that Pocahontas afterwards frequently came to James Town, and was, next to Smith himself, the salvation of the colony? The fact is, nobody doubted the story in Smith's lifetime, and he had enemies enough.¹

Space fails to describe how splendidly Smith worked after his deliverance for the good of the colony, how he explored Chesapeake Bay and its influents, how (when all others had failed) the presidency was forced on him on 10th September 1608; how he tried to get corn from Powhatan at Werowocomoco on 12th January 1609, but he fled to Orapakes, 40 m. farther off; how with only eighteen men he cowed Opecanchanough in his own house at Pamunkey, in spite of the hundreds of Indians that were there, and made him sell corn; how well he administered the colony, making the lazy work or starve.

Meanwhile the establishment of this forlorn hope in Virginia had stirred up a general interest in England, so that the London Company were able in June 1609 to send out 9 ships with 500 colonists. Smith had now got the Indians into splendid order; but from the arrival on 11th August of the new-comers his authority came to an end. They refused to acknowledge him, and robbed and injured the Indians, who attacked them in turn. Smith did his best to smooth matters, while the rioters were plotting to shoot him in his bed. In the meantime he was away up the river. On his return, "sleeping in his boat, accidentally one fired his powder bag, which tore his flesh from his body and thighs, 9 or 10 in. square, in a most pitiful manner; but to quench the tormenting fire frying him in his clothes he leaped overboard into the deep river, where, ere they could recover him, he was nearly drowned." Thus disabled, he was sent home on 4th October 1609 and never set foot in Virginia again. Nemesis

¹ Pocahontas never visited James Town after Smith went to England in October 1609, until she was brought there a state prisoner in April 1613 by Captain S. Argall, who had obtained possession of her by treachery on the Potomac river. The colony, while treating her well, used her as a means to secure peace with the Indians. In the meantime, believing Smith to be dead, she fell in love with an English gentleman, John Rolfe, apparently at that time a widower. They were married about 1st April 1614. Subsequently she embraced Christianity. Sir T. Dale, with Rolfe and his wife, landed at Plymouth on 12th June 1616. Before she reached London, Smith petitioned Queen Anne on her behalf; and it is in this petition of June 1616 that the account of his deliverance by the Indian girl first appears. After a pleasant sojourn of about seven months, being well received both by the court and the people, Pocahontas with her husband embarked for Virginia in the *George*, Captain S. Argall (her old captor), but she died off Gravesend about February 1617.

overtook the rioters the winter after he left, which is known in Virginian story as "the starving time." Out of 490 persons in the colony in October 1609 all but 60 died by the following March.

The rest of Smith's life can only be briefly touched upon. The fourth period, 1610-1617, was chiefly spent in exploring Nusconcus, Canada and Pemaquid or North Virginia, to which, at his solicitation, Prince Charles gave the name of New England. His first object was to fish for cod and barter for furs, his next, to discover the coast-line with the view to settlement. Two attempts, in 1615 and 1617, to settle at Capawuck failed, but through no fault of his. It was in connexion with these projects that the Western Company for North Virginia gave him the title of admiral of New England. We cannot better conclude this sketch of his active operations than in his own words printed in 1631. "Having been a slave to the Turks; prisoner among the most barbarous savages; after my deliverance commonly discovering and ranging those large rivers and unknown nations with such a handful of ignorant companions that the wiser sort often gave me up for lost; always in mutinies, wants and miseries; blown up with gunpowder; a long time a prisoner among the French pirates, from whom escaping in a little boat by myself, and adrift all such a stormy winter night, when their ships were split, more than £100,000 lost which they had taken at sea, and most of them drowned upon the Isle of Rhé—not far from whence I was driven on shore, in my little boat, &c. And many a score of the worst winter months have [I] lived in the fields; yet to have lived near thirty-seven years [1593-1630] in the midst of wars, pestilence and famine, by which many a hundred thousand have died about me, and scarce five living of them that went first with me to Virginia, and yet to see the fruits of my labours thus well begin to prosper (though I have but my labour for my pains), have I not much reason, both privately and publicly to acknowledge it, and give God thanks?"

The last period, 1618-1631, of Smith's life was chiefly devoted to authorship. In 1618 he applied (in vain) to Francis Bacon to be numbered among his servants. In 1619 he offered to lead out the Pilgrim Fathers to North Virginia; but they would not have him, he being a Protestant and they Puritans. The charter of the London Virginia Company was annulled in 1624. A list of his publications will be found at the end of this article. Thus having done much, endured much and written much, while still contemplating a *History of the Sea*, Captain John Smith died on 21st June 1631, and was buried in St Sepulchre's Church, London.

Two of the sixty survivors of "the starving time," Richard Potts and William Phettiplace, thus nobly expressed in print, so early as 1612, their estimate of Smith: "What shall I say? but thus we lost him [4th October 1609] that in all his proceedings made justice his first guide and experience his second; ever hating baseness, sloth, pride and indignity more than any dangers; that never allowed more for himself than his souldiers with him; that upon no danger would send them where he would not lead them himself; that would never see us want what he either had, or could by any means get us; that would rather want than borrow or starve than not pay; that loved actions more than words, and hated falsehood and cozenage than death; whose adventures were our lives, and whose loss our deaths."

A fairly complete bibliography will be found in Professor Edward Arber's reprint of Smith's *Works* (Birmingham, 1884), 8vo. The order of their first appearance is, *A True Relation*, &c. (1608) (first attributed to a gentleman of the colony, next to Th. Watson, and finally to Captain Smith); *A Map of Virginia*, ed. by [William] Slimmonds] (Oxford, 1612); *A Description of New England* (1616); *New England's Trials* (1620); *New England's Trials*, 2nd ed. (1622); *The General History of Virginia, New England and the Summer Isles* (1624); *An Accidence for all Young Seamen* (1626); the same work recast and enlarged as *A Sea Grammar* (1627); both works continuing on sale for years, side by side; *The True Travels*, &c. (1630); *Advertisements for the Unexperienced Planters*, &c. (1631). Of some of the smaller texts limited 4to editions have been published by Dr C. Deane and J. Carter Brown. See the MacLehose edition (1907) of the *General Historie, True Travels and Sea Grammar*; A. G. Bradley's *Captain John Smith* (1905), Charles Poindexter's *Captain John Smith and his Critics* (1893), John Fiske's *Old Virginia* (1897), and for criticism of Smith's credibility L. L. Kropf in *Notes and Queries* for 1890, Alexander Brown's *Genesis of the United States* (1890) and E. D. Neill's *History of the Virginia Company of London* (1869). (E. A.)

SMITH, JOHN RAPHAEL (1752-1812), English painter and mezzotint engraver, a son of Thomas Smith of Derby, the landscape painter, was born in 1752. He was apprenticed to a linen-draper in Derby, and afterwards pursued the same business in London, adding, however, to his income by the production of miniatures. He then turned to engraving and executed his plate of the "Public Ledger," which had great popularity, and was followed by his mezzotints of "Edwin the Minstrel" (a portrait of Thomas Haden), after Wright of Derby, and "Mercury Inventing the Lyre," after Barry. He reproduced some forty of the works of Reynolds, some of these plates ranking among the masterpieces of the art of mezzotint, and he was appointed engraver to the prince of Wales. Adding to his artistic pursuits an extensive connexion as a print-dealer and publisher, he would soon have acquired wealth had it not been for his dissipated habits. He was a boon companion of George Morland, whose figure-pieces he excellently mezzotinted. He painted subject-pictures such as the "Unsuspecting Maid," "Inattention" and the "Moralist," exhibiting in the Royal Academy from 1779 to 1790. Upon the decline of his business as a printseller he made a tour through the N. and midland counties of England, producing much hasty and indifferent work, and settled in Doncaster, where he died on the 2nd of March 1812.

As a mezzotint engraver Smith occupies the very highest rank. His prints are delicate, excellent in drawing and finely expressive of colour. His small full-lengths in crayons and his portraits of Fox, Horne Tooke, Sir Francis Burdett and the group of the duke of Devonshire and family support his claims as a successful draughtsman and painter. He had a very thorough knowledge of the principles and history of art, and was a brilliant conversationalist.

SMITH, JOSEPH, JR. (1805-1844), the founder, in April 1830, of the Church of Jesus Christ of Latter-Day Saints, was born in Sharon, Vermont, on the 23rd of December 1805. He was killed by a mob in a jail at Carthage, Illinois, on the 27th of June 1844. (See MORMONS.)

SMITH, MORGAN LEWIS (1822-1874), American general, was born in Oswego county, New York, on the 8th of March 1822. In 1843 he settled in Indiana, and later had some military experience in the United States army. At the outbreak of the Civil War he raised the 8th Missouri regiment, of which he was elected colonel in 1861. He commanded a brigade at the capture of Fort Donelson, and did good service at Shiloh. In July 1862 he was made a brigadier-general U.S.V., and served under Sherman in the river expedition against Vicksburg. At the battle of Chickasaw Bayou he received a severe wound, from which he recovered only in time to join the Army of the Tennessee before Chattanooga. He led his division in the battles of the Chattanooga campaign, as also, in the following year, in the Atlanta campaign. At the battle of Atlanta he commanded Logan's corps. Afterwards he was placed in charge of Vicksburg. General Sherman said of M. L. Smith, "He was one of the bravest men in action I ever knew." He died at Jersey City on the 29th of December 1874.

His brother, GILES ALEXANDER SMITH (1829-1876), also a distinguished soldier of the Federal army, was born in Jefferson county, N.Y., on the 29th of September 1829. At the beginning of the Civil War he joined the Missouri volunteers, in which he became a captain. He took part in the capture of Fort Donelson, the battle of Shiloh and the operations against Corinth, becoming, later in 1862, colonel of a regiment which he led at Chickasaw Bayou. After the final campaign against Vicksburg he was promoted brigadier-general of volunteers. He was wounded at the battle of Chattanooga. He took part in the Atlanta campaign, the "March to the Sea" and the Carolinas campaign, rising to the rank of major-general of volunteers. After the war he declined the offer of a colonelcy in the regular army, and was subsequently engaged in politics, retiring from public life in 1872. He died at Bloomington, Ill., on the 8th of November 1876.

SMITH, RICHARD BAIRD (1818-1861), British engineer officer, son of a surgeon in the royal navy, was born on the 31st of December 1818. He was educated at Lasswade and Addiscombe, and joined the Madras Engineers in 1838. Being transferred to the Bengal Engineers, he served through the second

Sikh war, and was present at the battles of Badiwal, Aliwal and Sobraon. He was then for some years employed on canal work, and when the Mutiny broke out was in charge of Roorkee. He promptly concentrated the Europeans in the workshops, and though the native sappers deserted, his forethought prevented any loss of life. When Delhi was invested he was appointed chief engineer in charge of the siege works. He reached Delhi on the 2nd of July, and immediately advised General Barnard to assault the city. Barnard died while the advice was still under consideration, and his successor, General Reed, could not be induced to follow it; and when Reed in turn was succeeded by Archdale Wilson, the besiegers were so weakened by losses that the moment for a successful attack had passed. Baird Smith, however, prevented Wilson from relaxing his hold on Delhi until the arrival of John Nicholson with reinforcements from the Punjab, and of the siege train from Phillour. Nicholson then joined Baird Smith in compelling Wilson to make the assault, which proved successful, on the 14th of September. Baird Smith was ably assisted by Captain Alexander Taylor, but Nicholson was unjust to Baird Smith in assigning to Taylor the chief credit for the siege operations. After the capture of Delhi he returned to Roorkee and to civil employment, and for a time the value of his military services was insufficiently recognized. After the Mutiny he was made A.D.C. to Queen Victoria, became secretary to the government of India in the public works department, and gained well-deserved credit in the famine of 1861. But the onerous character of this work, following a wound and illness at Delhi, broke down his constitution, and he died at sea on the 13th of December 1861. He married a daughter of De Quincey, who long survived him.

See Colonel H. M. Vibart, *Richard Baird Smith* (1897).

SMITH, ROBERT (1689–1768), English mathematician, was born in 1689, probably at Lea near Gainsborough. After attending Leicester grammar school he entered Trinity College, Cambridge, in 1708, and becoming minor fellow in 1714, major fellow in 1715 and senior fellow in 1739, was chosen master in 1742, in succession to Richard Bentley. From 1716 to 1760 he was Plumian professor of astronomy, and he died in the master's lodge at Trinity on the 2nd of February 1768. Besides editing two works by his cousin, Roger Cotes, who was his predecessor in the Plumian chair, he published *A Compleat System of Opticks* in 1738, which gained him the sobriquet of "Old Focus," and *Harmonics, or the Philosophy of Musical Sounds* in 1749. He was the founder of the Smith's prizes at Cambridge, having by his will left £3500 South Sea stock to the university, a portion of the interest from which was to be divided yearly between the two junior B.A.'s who had made the greatest progress in mathematics and natural philosophy.

SMITH, SYDNEY (1771–1845), English writer and divine, son of Robert Smith, was born at Woodford, Essex, on the 3rd of June 1771. His father, a man of restless ingenuity and activity, "very clever, odd by nature, but still more odd by design," who bought, altered, spoiled and sold about nineteen different estates in England, had talent and eccentricity enough to be the father of such a wit as Sydney Smith on the strictest principles of heredity; but Sydney himself attributed not a little of his constitutional gaiety to an infusion of French blood, his maternal grandfather being a French Protestant refugee of the name of Olier. Sydney was the second of a family of four brothers and one sister, all remarkable for their talents. While two of the brothers, Robert Percy, known as "Bobus," afterwards advocate-general of Bengal, and Cecil, were sent to Eton, Sydney was sent with the youngest to Winchester, where he rose to be captain of the school, and with his brother so distinguished himself that their schoolfellows signed a round-robin "refusing to try for the college prizes if the Smiths were allowed to contend for them any more, as they always gained them." At some time during his Oxford career he spent six months in France, being duly enrolled for safety's sake in the local Jacobin club. In 1789 he had become a scholar of New College, Oxford; he received a fellowship after two years' residence, took his degree in 1792 and proceeded M.A. in 1796. It was his wish then to read

for the bar, but his father would add nothing to his fellowship, and he was reluctantly compelled to take holy orders. He was ordained priest at Oxford in 1796, and became a curate in the small village of Nether Avon, near Amesbury, in the midst of Salisbury Plain. The place was uncongenial enough, but Sydney Smith did much for the inhabitants, providing the means for the rudiments of education, and thus making better things possible. The squire of the parish, Michael Hicks-Beach, invited the new curate to dine, was astonished and charmed to find such a man in such a place, and engaged him after a time as tutor to his eldest son. It was arranged that they should proceed to the university of Weimar, but, before reaching their destination Germany was disturbed by war, and "in stress of politics" said Smith, "we put into Edinburgh." This was in 1798. While his pupil attended lectures, Smith was not idle. He studied moral philosophy under Dugald Stewart, and devoted much time to medicine and chemistry. He also preached in the Episcopal chapel, where his practical brilliant discourses attracted many hearers.

In 1800 he published his first book, *Six Sermons, preached in Charlotte Street Chapel, Edinburgh*, and in the same year, married, against the wishes of her friends, Catharine Amelia Pybus. They settled at No. 46 George Street, Edinburgh, where, as everywhere else, Smith made numerous friends, among them the future Edinburgh Reviewers. It was towards the end of his five years' residence in Edinburgh, in the eighth or ninth storey or flat in a house in Buccleuch Place, the elevated residence of the then Mr Jeffrey, that Sydney Smith proposed the setting up of a review as an organ for the young malcontents with things as they were. "I was appointed editor," he says in the preface to the collection of his contributions, "and remained long enough in Edinburgh to edit the first number (October 1802) of the *Edinburgh Review*. The motto I proposed for the Review was 'Tenui musam meditamur avena.'—'We cultivate literature on a little oatmeal.' But this was too near the truth to be admitted, and so we took our present grave motto¹ from Publius Syrus, of whom, none of us, I am sure, had ever read a single line." He continued to write for the Review for the next quarter of a century, and his brilliant articles were a main element in its success.

He left Edinburgh for good in 1803, when the education of his pupils was completed, and settled in London, where he rapidly became known as a preacher, a lecturer and a social lion. His success as a preacher, although so marked that there was often not standing-room in Berkeley Chapel, Mayfair, where he was morning preacher, was not gained by any sacrifice of dignity. He was also "alternate evening preacher" at the Foundling Hospital, and preached at the Berkeley Chapel and the Fitzroy Chapel, now St Saviour's Church, Fitzroy Square. He lectured on moral philosophy at the Royal Institution for three seasons, from 1804 to 1806: and treated his subject with such vigour, freshness and liveliness of illustration that the London world crowded to Albemarle Street to hear him. He followed in the main Dugald Stewart, whose lectures he had attended in Edinburgh; but there is more originality as well as good sense in his lectures, especially on such topics as imagination and wit and humour, than in many more pretentious systems of philosophy. He himself had no high idea of these entertaining performances, and threw them in the fire when they had served their purpose—providing the money for furnishing his house. But his wife rescued the charred MSS. and published them in 1850 as *Elementary Sketches of Moral Philosophy*.

With the brilliant reputation that Sydney Smith had acquired in the course of a few seasons in London, he would probably have obtained some good preferment had he been on the powerful side in politics. Sydney Smith's elder brother "Bobus" had married Caroline Vernon, aunt of the 3rd Lord Holland, and he was always a welcome visitor at Holland House. His Whig friends came into office for a short time in 1806, and presented him with the living of Foston-le-Clay in Yorkshire. He shrank from this banishment for a time, and discharged his parish duties through a curate; but Spencer Perceval's Residence Act was

¹*Judex damnatur cum nocens absolvitur.*

passed in 1808, and after trying in vain to negotiate an exchange, he quitted London in 1809, and moved his household to Yorkshire. The Ministry of "All the Talents" was driven out of office in 1807 in favour of a "no popery" party, and in that year appeared the first instalment of Sydney Smith's most famous production, *Peter Plymley's Letters*, on the subject of Catholic emancipation, ridiculing the opposition of the country clergy. It was published as *A Letter on the Subject of the Catholics to my brother Abraham who lives in the Country*, by Peter Plymley. Nine other letters followed before the end of 1808, when they appeared in collected form. Peter Plymley's identity was a secret, but rumours got abroad of the real authorship. Lord Holland wrote to him expressing his own opinion and Grenville's, that there had been nothing like it since the days of Swift (*Memoir*, i. 151). He also pointed out that Swift had lost a bishopric for his wittiest performance. The special and temporary nature of the topics advanced in these pamphlets has not prevented them from taking a permanent place in literature, secured for them by the vigorous, picturesque style, the generous eloquence and clearness of exposition which Sydney Smith could always command. In his country parish of Foston, with no educated neighbour within 7 m., Sydney Smith accommodated himself cheerfully to his new circumstances, and won the hearts of his parishioners as quickly as he had conquered a wider world. There had been no resident clergyman in his parish for 150 years; he had a farm of 300 acres to keep in order; a rectory had to be built. All these things were attended to beside his contributions to the *Edinburgh Review*. "If the chances of life ever enable me to emerge," he nevertheless writes to Lady Holland, "I will show you I have not been wholly occupied by small and sordid pursuits." He continued to serve the cause of toleration by ardent speeches in favour of Catholic emancipation; his eloquence being specially directed against those who maintained that a Roman Catholic could not be believed on his oath. "I defy Dr Duigenan,"¹ he pleaded, addressing a meeting of clergy in 1823, "in the full vigour of his incapacity, in the strongest access of that Protestant epilepsy with which he was so often convulsed, to have added a single security to the security of that oath." At this time appeared one of his most vigorous and effective polemics, *A Letter to the Electors upon the Catholic Question* (1826).

Sydney Smith, after twenty years' service in Yorkshire, obtained preferment at last from a Tory minister, Lord Lyndhurst, who presented him with a prebend in Bristol cathedral in 1828, and afterwards enabled him to exchange Foston for the living of Combe Florey, near Taunton, which he held conjointly with the living of Halberton attached to his prebend. From this time he discontinued writing for the *Edinburgh Review* on the ground that it was more becoming in a dignitary of the church to put his name to what he wrote. It was expected that when the Whigs came into power Sydney Smith would be made a bishop. There was nothing in his writings, as in the case of Swift, to stand in the way. He had been most sedulous as a parochial clergyman. Doctoring his parishioners, he said, was his only rural amusement. His religion was wholly of a practical nature, and his fellow-clergy had reasons for their suspicion of his very limited theology, which excluded mysticism of any sort. "The Gospel," he said, "has no enthusiasm." His scorn for enthusiasts and dread of religious emotion found vent in middle life in his strictures on missionary enterprise, and bitter attacks on Methodism, and later in many scoffs at the followers of Pusey. Still, though he was not without warm friends at headquarters, the opposition was too strong for them. One of the first things that Lord Grey said on entering Downing Street was, "Now I shall be able to do something for Sydney Smith"; but he was not able to do more than appoint him in 1831 to a residentiary canonry at St Paul's in exchange for the prebendal stall he held at Bristol. He was as eager a champion of parliamentary reform as he had been of Catholic emancipation, and one of his best fighting speeches was delivered at Taunton in October 1831 when he made his well-known comparison of the House of Lords, who

¹ Patrick Duigenan, M.P. for the city of Armagh, a Protestant agitator.

had just thrown out the Reform Bill, with Mrs Partington of Sidmouth, setting out with mop and pattens to stem the Atlantic in a storm. Some surprise must be felt now that Sydney Smith's reputation as a humorist and wit should have caused any hesitation about elevating him to an episcopal dignity, and perhaps he was right in thinking that the real obstacle lay in his being known as "a high-spirited, honest, uncompromising man, whom all the bench of bishops could not turn upon vital questions." With characteristic philosophy, when he saw that the promotion was doubtful, he made his position certain by resolving not to be a bishop and definitely forbidding his friends to intercede for him.

On the death of his brother Courtenay he inherited £50,000, which put him out of the reach of poverty. His eldest daughter, Saba (1802-1866), married Sir Henry Holland. His eldest son, Douglas, died in 1829 at the outset of what had promised to be a brilliant career. This grief his father never forgot, but nothing could quite destroy the cheerfulness of his later life. He retained his high spirits, his wit, practical energy and powers of argumentative ridicule to the last. His *Three Letters to Archdeacon Singleton* on the Ecclesiastical Commission (1837-38-39) and his *Petition and Letters* on the repudiation of debts by the state of Pennsylvania (1843), are as bright and trenchant as his best contributions to the *Edinburgh Review*. He died at his house in Green Street, London, on the 22nd of February 1845 and was buried at Kensal Green.

Sydney Smith's other publications include: *Sermons* (2 vols., 1809); *The Ballot* (1839); *Works* (3 vols., 1839), including the *Peter Plymley* and the *Singleton Letters* and many articles from the *Edinburgh Review*; *A Fragment on the Irish Roman Catholic Church* (1845); *Sermons at St Paul's* . . . (1846) and some other pamphlets and sermons. Lady Holland says (*Memoir*, i. 190) that her father left an unpublished MS., compiled from documentary evidence, to exhibit the history of English misrule in Ireland, but had hesitated to publish it. This was suppressed by his widow in deference to the opinion of Lord Macaulay.

See *A Memoir of the Reverend Sydney Smith by his daughter, Lady Holland, with a Selection from his Letters* edited by Mrs [Sarah] Austin (2 vols., 1855); also *A Sketch of the Life and Times of . . . Sydney Smith* (1884) by Stuart J. Reid; a chapter on "Sydney Smith" in Lord Houghton's *Monographs Social and Personal* (1873); A. Chevrillon, *Sydney Smith et la renaissance des idées libérales en Angleterre au XIX^e siècle* (1894); and especially the monograph, with a full description of his writings, by G. W. E. Russell in *Sydney Smith* (English Men of Letters series, 1905). There are numerous references to Smith in contemporary correspondence and journals.

SMITH, SIR THOMAS (1513-1577), English scholar and diplomatist, was born at Saffron Walden in Essex on the 23rd of December 1513. He became a fellow of Queens' College, Cambridge, in 1530, and in 1533 was appointed a public reader or professor. He lectured in the schools on natural philosophy, and on Greek in his own rooms. In 1540 Smith went abroad, and, after studying in France and Italy and taking a degree of law at Padua, returned to Cambridge in 1542. He now took the lead in the reform of the pronunciation of Greek, his views after considerable controversy being universally adopted. He and his friend Sir John Cheke were the great classical scholars of the time in England. In January 1543/4 he was appointed first regius professor of civil law. He was vice-chancellor of the university the same year, and became chancellor to the bishop of Ely, by whom he was ordained priest in 1546. In 1547 he became provost of Eton and dean of Carlisle. He early adopted Protestant views, a fact which brought him into prominence when Edward VI. came to the throne. During Somerset's protectorate he entered public life and was made a secretary of state, being sent on an important diplomatic mission to Brussels. In 1548 he was knighted. On the accession of Mary he was deprived of all his offices, but in the succeeding reign was prominently employed in public affairs. He became a member of parliament, and was sent in 1562 as ambassador to France, where he remained till 1566; and in 1572 he again went to France in the same capacity for a short time. He remained one of Elizabeth's most trusted Protestant counsellors, being appointed in 1572 chancellor of the order of the Garter and a secretary of state. He died on the 12th of August 1577. In 1661 the grandson of his

brother George was created a baronet, and from him the title has descended to the Smith family of the present day.

His best-known work, entitled *De Republica Anglorum: the Manner of Government or Politic of the Realm of England*, was published posthumously in 1583, and passed through many editions. His epistle to Gardiner, *De recta et emendata linguæ Græcæ pronunciatione*, was printed at Paris in 1568; the same volume includes his dialogue *De recta et emendata linguæ Anglicanæ scriptiōne*. A number of his letters from France are in the foreign state papers.

See A. F. Pollard's article in the *Dict. Nat. Biog.* A life by Strype was published in 1698 (Oxford edition, 1820).

SMITH, THOMAS SOUTHWOOD (1788–1861), English physician and sanitary reformer, was born at Martock, Somersetshire, on the 21st of December 1788. While a medical student in Edinburgh he took charge of a Unitarian congregation. In 1816 he took his M.D. degree, and began to practice at Yeovil, Somerset, also becoming minister at a chapel in that town, but removed in 1820 to London, devoting himself principally to medicine. In 1824 he was appointed physician to the London Fever Hospital, and in 1830 published *A Treatise on Fever*, which was at once accepted as a standard authority on the subject. In this book he established the direct connexion between the impoverishment of the poor and epidemic fever. He was frequently consulted in fever epidemics and on sanitary matters by public authorities, and his reports on quarantine (1845), cholera (1850), yellow fever (1852), and on the results of sanitary improvement (1854) were of international importance. He died at Florence on the 10th of December 1861.

SMITH, WILLIAM (fl. 1596), English sonneteer. He published in 1596 a sonnet sequence entitled *Chloris, or the Complaint of the passionate despised Shepheard*. He was a disciple of Spenser, to whom the two first sonnets and the last are addressed. He signed his name W. Smith, and has sometimes been confused with the playwright Wentworth Smith, who collaborated with John Day, William Haughton and others (1601–1603).

SMITH, WILLIAM (c. 1730–1819), English actor, the son of a city tea merchant, was educated at Eton and went up to Cambridge, but his wild pranks soon ended his college career and brought him back to London. His first stage appearance was in 1753 at Covent Garden, where he remained for twenty years, playing important parts. In 1774 he was at Drury Lane under Garrick's management. His forte was gay comedy, and he was the original, indeed unrivalled, Charles Surface. It was in this part that he made his farewell appearance in 1788. He died on the 13th of September 1819. His sporting tastes and social connexions—he married the sister of a peer—led to his being called "Gentleman Smith," a sobriquet his manners seem to have justified. He is to be distinguished from an older English actor, William Smith (d. 1696), the friend of Betterton.

SMITH, WILLIAM (1769–1839), English geologist, appropriately termed "the Father of English geology," and known among his acquaintances as "Strata Smith," was born at Churchill in Oxfordshire on the 23rd of March 1769. Deprived of his father, an ingenious mechanic, before he was eight years old, he depended upon his father's eldest brother, a farmer at Over Norton, who was but little pleased with his nephew's love of collecting "pundibs" (*Terebratulæ*) and "pound-stones" (the large Echinoid *Clypeus*, then frequently employed as a pound weight by dairymen), and with his propensity for carving sundials on soft brown "oven-stone" of his neighbourhood. The uncle was, however, better satisfied when the boy, after studying the rudiments of geometry and surveying, began to take interest in the draining of land; and there is no doubt that William Smith profited in after life by the practical experience he gained with his relative. At the age of eighteen he became assistant to Edward Webb, surveyor, of Stow-on-the-Wold, and traversed the Oolitic lands of Oxfordshire and Gloucestershire, the Lias clays and red marls of Warwickshire and other districts, studying their varieties of strata and soils. In 1791 his observations at Stowey and High Littleton in Somersetshire first impressed him with the regularity of the strata. In 1793 he executed the surveys and levellings for the line of the Somerset Coal Canal, in the course of which he con-

firmed a previous supposition, that the strata lying above the coal were not horizontal, but inclined in one direction—to the E.—so as to terminate successively at the surface.

On being appointed engineer to the canal in 1794 he was deputed to make a tour of observation with regard to inland navigation. During this tour, which occupied nearly two months, he journeyed to York and Newcastle and returned through Shropshire and Wales to Bath; he carefully examined the geological structure of the country, and corroborated his generalization of a settled order of succession in the strata. After residing for two or three years at High Littleton he removed in 1795 to Bath, and three years later purchased a small estate at Tucking Mill, Midford, about 3 m. distant from the city, where he engaged in the last duties he performed as resident engineer to the Coal Canal (1798–1799). His numerous journeys had satisfied him of the practicability of making a map to show the ranges of the different strata across England, and in 1794 he coloured his first geological map—that of the vicinity of Bath.

At this time he made acquaintance with the Rev. Benjamin Richardson (d. 1832), from 1796 rector of Farleigh Hungerford, who possessed a good collection of local fossils, but knew nothing of the laws of stratification. He had a sound knowledge of natural history, and he greatly aided Smith in learning the names and true nature of the fossils, while Smith arranged his specimens in the order of the strata. By this new friend Smith was introduced to the Rev. Joseph Townsend (1738–1816), rector of Pewsey, and on a notable occasion in 1799 Smith dictated his first table of British Strata, written by Richardson and now in the possession of the Geological Society of London. It was headed *Order of the Strata, and their imbedded Organic Remains, in the neighbourhood of Bath; examined and proved prior to 1799*. In 1813 Townsend published, with due acknowledgment, much information on the English strata communicated by William Smith, in a work entitled *The Character of Moses established for veracity as an historian, recording events from the Creation to the Deluge*. Meanwhile Smith was completing and arranging the data for his large *Geological Map of England and Wales, with part of Scotland*, which appeared in 1815, in fifteen sheets, engraved on a scale of 5 m. to 1 in. The map was reduced to smaller form in 1819; and from this date to 1822 twenty-one separate county geological maps and several sheets of sections were published in successive years, the whole constituting a *Geological Atlas of England and Wales*. Smith's collection of fossils was purchased in 1816–1818 by the British Museum. In 1817 a portion of the descriptive catalogue was published under the title of a *Stratigraphical System of Organized Fossils*. Prior to this, in 1816, he commenced the publication of *Strata Identified by Organized Fossils*, with figures printed on paper to correspond in some degree with the natural hue of the strata. In this work (of which only four parts were published, 1816–1819) is exemplified the great principle he established of the identification of strata by their included organic remains. In January 1831 the Geological Society of London conferred on Smith the first Wollaston medal; on which occasion Sedgwick in an eloquent address referred to Smith as "the Father of English Geology"; and the government conferred upon him a life-pension of £100 per annum. The degree of LL.D. he received from Dublin, at the meeting of the British Association in that city in 1835. In 1838 he was appointed one of the commissioners to select building-stone for the new Houses of Parliament. The last years of his life were spent at Hackness (of which he made a good geological map), near Scarborough, and in the latter town. His usually robust health failed in 1839, and on 28th August of that year he died at Northampton. He was buried at St Peter's church, and a bust by Chantrey was placed in the nave. In 1891 the earl of Ducie erected a monument to his memory at his native place, Churchill.

His *Memoirs*, edited by his nephew, John Phillips, appeared in 1844.

SMITH, SIR WILLIAM (1813–1893), English lexicographer, was born at Enfield in 1813 of Nonconformist parents. He was originally destined for a theological career, but instead was articulated to a solicitor. In his spare time, he taught himself

classics, and when he entered University College he carried off both the Greek and Latin prizes. He was entered at Gray's Inn in 1830, but gave up his legal studies for a post at University College school, and began to write on classical subjects. He next turned his attention to lexicography. His first attempt was the *Dictionary of Greek and Roman Antiquities*, which appeared in 1842. The greater part of this was written by himself. In 1849 followed the *Dictionary of Greek and Roman Biography*, and the *Greek and Roman Geography* in 1857. In this work some of the leading scholars of the day were associated with him. In 1850 he published the first of the school dictionaries; and in 1853 he began the Principia series, which marked a distinct step in the school teaching of Greek and Latin. Then came the *Students' Manuals of History and Literature*, in which the Greek history was the editor's own work. In carrying out this task Smith was most ably seconded by John Murray, the publisher, who, when the original publishers of the dictionaries got into difficulties, volunteered to take a share in the undertaking. The most important, perhaps, of the books edited by William Smith were those that dealt with ecclesiastical subjects. These were the *Dictionary of the Bible* (1860–1865); the *Dictionary of Christian Antiquities* (1875–1880), undertaken in collaboration with Archdeacon Cheetham; and the *Dictionary of Christian Biography* (1877–1887), jointly with Dr Henry Wace. The *Atlas*, on which Sir George Grove collaborated, appeared in 1875. From 1853 to 1869 Smith was classical examiner to the University of London, and on his retirement he became a member of the Senate. He sat on the Committee to inquire into questions of copyright, and was for several years registrar of the Royal Literary Fund. He edited Gibbon, with Guizot's and Milman's notes, in 1854–1855. In 1867 he became editor of the *Quarterly Review*, which he directed with marked success until his death on the 7th of October 1893, his remarkable memory and accuracy, as well as his tact and courtesy, specially fitting him for such a post. He was D.C.L. of Oxford and Dublin, and the honour of knighthood was conferred on him the year before his death.

SMITH, WILLIAM FARRAR (1824–1903), American general, was born at St Albans, Vermont, on the 17th of February 1824, and graduated from West Point in 1845, being assigned to the engineer branch of the army. He was twice assistant professor of mathematics at West Point (1846–1848 and 1855–1856). During the first campaign of the Civil War he was employed on the staff, in August 1861 became brigadier-general of volunteers, and was breveted lieutenant-colonel U.S.A. for his gallantry at the action of White Oak Swamp. In July 1862 he received promotion to the rank of major-general U.S.V. Smith led his division with conspicuous valour at Antietam, and was again breveted in the regular army. On the assignment of General Franklin to a superior command Smith was placed at the head of the VI. corps of the Army of the Potomac, which he led at the disastrous battle of Fredericksburg (*q.v.*). The recriminations which followed led to the famous general order in which several of the senior officers of the army were dismissed and suspended by General Burnside. Smith was one of these, but it is to his credit that he did not leave the army, and as a brigadier-general he commanded troops in Pennsylvania during the critical days of the Gettysburg campaign. Later in 1863 he was assigned to duty as chief engineer of the Army of the Cumberland. As such he conducted the engineer operations which reopened the "cracker-line" from Chattanooga (*q.v.*) to the base of supplies. Of this action the House Committee on military affairs reported in 1865 that "as a subordinate, General W. F. Smith had saved the Army of the Cumberland from capture, and afterwards directed it to victory." Smith was now again nominated for the rank of major-general U.S.V., and Grant, who was much impressed with Smith's work, insisted strongly that the nomination should be confirmed, which was accordingly done by the Senate in March 1864. Grant, according to his own statement, "was not long in finding out that the objections to Smith's promotion were well grounded," but he never stated the grounds of his complaint, and Smith, in the "Battles and Leaders" series, maintained that they were purely of a personal character. For

the Virginian campaign of 1864 Smith was specially assigned by Grant to command the XVIII. corps, Army of the James, and he took part in the battle of Cold Harbor and the first operations against Petersburg, after which, while absent on leave, he was suddenly deprived of his command by Grant. He resigned from the volunteers in 1865, and from the U.S. army in 1867. From 1864 to 1873 he was president of the International Telegraph Company, and in 1875–1881 served on the board of police commissioners of New York, becoming president of this in 1877. After 1881 he was engaged in civil engineering work. He died at Philadelphia on the 28th of February 1903.

SMITH, WILLIAM HENRY (1808–1872), English author, was born at Hammersmith, London, in 1808. He was educated at Radley School, and in 1821 was sent to Glasgow University. In 1823 he entered a lawyer's office, in which he remained for five years. He was called to the bar, but had no practice. He contributed to the *Literary Gazette* and to the *Athenaeum*, under the name of "Wool-gatherer," attracting some attention by the delicacy and finish of his style. *Ernesto*, a philosophical romance, appeared in 1835, two poems, *Guidone* and *Solitude*, in 1836, and in 1839 he formed a connexion with *Blackwood's Magazine*, for which he acted as philosophical critic for thirty years. In 1846 a visit to Italy led to the writing of a tale entitled *Mildred*, which was too purely reflective to be successful. In 1851 he declined the chair of moral philosophy at Edinburgh, being unwilling to abandon his quiet, studious life in the Lake District. There he completed his philosophic romance *Thorndale* (1857), which was considered at the time to be a work of real intellectual value. A similar production, *Gravenhurst*, appeared in 1862; a second edition contained a memoir of the author by his wife. Smith died at Brighton on 28th March 1872. He also wrote two plays, one of which, *Athelwold*, was produced by Macready in 1843. It was published with his other tragedy, *Sir William Crichton*, in 1846.

SMITH, WILLIAM HENRY (1825–1891), English man of business and statesman, was born in London on the 24th of June 1825. His father was the founder of the great distributing firm of W. H. Smith & Son, in the Strand, and at an early age he became a partner and devoted himself to the business. He betrayed no political aspirations until 1865, when he came forward as a Conservative to contest Westminster against John Stuart Mill and the Hon. Mr Grosvenor. Defeated on that occasion, he triumphed in 1868, winning a victory when his party was in general vanquished on all sides. The prestige thus obtained combined with wealth and his business abilities to recommend him to Disraeli, who in 1874 made him secretary to the Treasury. In 1877 he gained cabinet rank as first lord of the Admiralty; in 1885 he was successively secretary for War and chief secretary for Ireland; in 1886 he was again at the War Office; and when late in that year Lord Randolph Churchill's resignation necessitated a reconstruction of the ministry, Mr Smith found himself first lord of the Treasury and leader of the House of Commons. He was no orator, and made no pretence to genius, but his success in these high offices was complete, and was admittedly due, not merely to business ability, but to the universal respect which was gained by his patience, good temper, zeal for the public service, and thorough kindness of heart. He died at Walmer Castle (which he occupied as Warden of the Cinque Ports) on the 6th of October 1891. In recognition of his services a peerage in her own right was conferred on his widow, with the title of Viscountess Hambleden. Lady Hambleden (b. 1828) had been a Miss Danvers, and before marrying Mr Smith had been the wife of Mr B. A. Leach, by whom she had a family. Her eldest son by the second marriage, the Hon. W. F. D. Smith (b. 1868), rowed in the Oxford boat, and on his father's death became head of the business; in 1891 he was elected Conservative M.P. for the Strand (London), and was re-elected in 1892, 1895, 1900 and 1906. He married in 1894 Lady Esther Gore, daughter of the earl of Arran.

SMITH, WILLIAM ROBERTSON (1846–1894), Scottish philologist, physicist, archaeologist, Biblical critic, and editor, from 1881, of the 9th edition of this Encyclopaedia, was born on the

8th of November 1846 at Keig in Aberdeenshire, where his father was Free Church minister. He was educated at home and at Aberdeen University, where he attained the highest academic distinctions, winning among other things the Ferguson mathematical scholarship, which is open to all graduates of Scottish universities under three years' standing. In 1866 he entered the Free Church College at Edinburgh as a student of theology. During two summer sessions he studied philosophy and theology at Bonn and Göttingen, making friends in all branches of learning. From 1868 to 1870 he acted as assistant to the professor of natural philosophy in Edinburgh University. During this period he was not only most successful as a teacher, but produced much original work—especially in the experimental and mathematical treatment of electricity—which is still regarded as standard. In 1870 he was appointed and ordained to the office of professor of Oriental languages and Old Testament exegesis at the Free Church College, Aberdeen, and here he began that series of theological investigations which, characterized as they were by learned research and the use of the most scientific methods, were destined to make his name famous. He was the pupil and personal friend of many leaders of the higher criticism in Germany, and from the first he advocated views which, though now widely accepted, were then regarded with apprehension. The articles on Biblical subjects which he contributed to the 9th edition of the *Encyclopaedia Britannica* distressed and alarmed the authorities of the Free Church. In 1876 a committee of the General Assembly of that Church reported on them so adversely that Smith demanded a formal trial, in the course of which he defended himself with consummate ability and eloquence. The indictment dropped, but a vote of want of confidence was passed, and in 1881 Smith was removed from his chair. During this long struggle he was sustained by the conviction that he was fighting for freedom, and at the end of the trial he was probably the most popular, if not the most powerful, man in Scotland. Marks of sympathy were showered on him from all sides.

In 1875 he was appointed one of the Old Testament revisers; in 1880–1882 he delivered by invitation, to very large audiences in Edinburgh and Glasgow, two courses of lectures on the criticism of the Old Testament, which he afterwards published (*The Old Testament in the Jewish Church*, first edition 1881, second edition 1892, and *The Prophets of Israel*, 1882, which also passed through two editions); and soon after his dismissal from his chair he joined Professor Baynes in the editorship of the *Encyclopaedia Britannica*, and after Professor Baynes's death remained in supreme editorial control till the work was completed. His versatility, firmness combined with tact, width of view, and painstaking struggle for accuracy were largely responsible for the maintenance of its high standard. But he did not let his other duties interfere with his Semitic studies. He visited Arabia, Egypt, Syria, Palestine, Tunis and southern Spain, and had an intimate knowledge of, and personal acquaintance with, not only the literature, but the life of the East. His early friendship with J. F. McLennan, that most original student of primitive marriage, had a great influence on Smith's studies, and his attention was always strongly attracted to the comparative study of primitive customs and their meaning. His chief contributions to this branch of learning were his article SACRIFICE in the *Encyclopaedia Britannica*, his *Kinship and Marriage in Early Arabia* (Cambridge, 1885), and above all his *Lectures on the Religion of the Semites* (1st edition 1889, 2nd edition 1894). His originality and grasp of mind enabled him to seize the essential among masses of details, and he had in a marked degree the power of carrying a subject farther than his predecessors.

In 1883 Robertson Smith was appointed Lord Almoner's Professor of Arabic at Cambridge, which henceforth became his home. He occupied rooms in Trinity College till 1885, when he was elected to a professorial fellowship at Christ's College. In 1886 he became university librarian, and in 1889 Adams Professor of Arabic. In 1888–1891 he delivered, as Burnett lecturer, three courses of lectures at Aberdeen on the primitive religion of the Semites. Early in 1890 grave symptoms of constitutional disease manifested themselves, and the last years of his life were

full of suffering, which he bore with the utmost courage and patience. He never ceased to work, and when near his end was actively engaged in planning the *Encyclopaedia Biblica*, which he had hoped to edit. He died at Cambridge on the 31st of March 1894, and was buried at Keig. Small and slight in person and never robust in health, Robertson Smith was yet a man of ceaseless and fiery energy; of an intellect extraordinarily alert and quick, and as sagacious in practical matters as it was keen and piercing in speculation; of an erudition astonishing both in its range and in its readiness; of a temper susceptible of the highest enthusiasm for worthy ends, and able to inspire others with its own ardour; endowed with the warmest affections, and with the kindest and most generous disposition, but impatient of stupidity and ready to blaze out at whatever savoured of wrong and injustice. The sweetness and purity of his nature combined with his brilliant conversational powers to render him the most delightful of friends and companions.

See also James Bryce, *Studies in Contemporary Biography* (1903).
(A. E. S.)

SMITH, SIR WILLIAM SIDNEY (1764–1840), English admiral, was the second son of Captain John Smith of the Guards, and was born at Westminster on the 21st of July 1764. He entered the navy, according to his own account, "at the beginning of the American War," being only about eleven years of age. For his bravery under Rodney in the action near Cape St Vincent in January 1780, he was on the 25th of September appointed lieutenant of the "Alcide," 74. After serving in the actions against the French fought by Graves off Chesapeake in 1781 and by Rodney at the Leeward Islands in 1782, he was on the 6th of May of the latter year promoted to be commander of the "Fury" sloop, and on the 18th of October advanced to the rank of captain. His ship having been paid off in the beginning of 1784, he spent two years in France and afterwards visited Spain. From 1790 to 1792 he advised the king of Sweden in the war with Russia, receiving for his services the honour of knighthood. After his return to England he was sent on a mission to Constantinople, and having joined Lord Hood at Toulon from Smyrna in December 1793, he, though only on half pay, was actively employed in the attempt to burn the enemy's ships and arsenal. In the following years he was engaged in the Channel hunting French privateers; but, having with the boats of his squadron boarded in Havre-de-Grâce harbour a lugger which was driven by the tide above the French forts, he was on the 19th of April 1796 compelled to surrender and sent a prisoner to Paris. By means of forged orders for his removal to another prison he made his escape from the Temple, and, crossing the Channel in a small skiff picked up at Havre, arrived in London on the 8th of May 1798. In October he was appointed to the command of the "Tigre," 80, and was sent to the Mediterranean. By a very curious decision of the government he was joined in commission with his brother Spencer Smith, minister at Constantinople. Learning of Bonaparte's approach to St Jean d'Acre, he hastened to its relief, and on the 16th of March 1799 captured the enemy's flotilla, after which he successfully defended the town, compelling Napoleon on the 20th of May to raise the siege and retreat in disorder, leaving all his artillery behind. For this brilliant exploit he received the special thanks of the Houses of Parliament and was awarded an annuity of £1000. On the 24th of January 1800 he took upon himself to make the convention of El Arish, by which the French were to have been allowed to evacuate Egypt. His action was disallowed by his superiors, who insisted that the French must surrender. Subsequently he co-operated with Abercromby, under whom he commanded the naval brigade at the battle of Aboukir, where he was wounded. On his return to England he was in 1802 elected M.P. for the city of Rochester. In March 1803 he was commissioned to watch the preparations of the French for an invasion of England. Having on the 9th of November 1805 been promoted to be rear-admiral of the blue, he was in the following January despatched on secret service for the protection of Sicily and Naples. His conduct was as usual brilliant, but, also as usual, his vanity and self-assertion led him into quarrels with the military officers. He relieved Gaeta and captured Capri, but

on the 25th of January 1807 received orders to proceed to Malta, whence he joined Sir John Duckworth, who was sent to act against the Turks. On the 7th of February, with the rear division of the squadron, he destroyed the Turkish fleet and spiked the batteries off Abydos. In November following he was sent to blockade the Tagus, and was mainly instrumental in embarking the Portuguese prince regent and royal family for Rio de Janeiro, after which he was sent as commander-in-chief to the coast of S. America in February 1808. At Rio he was entangled in another quarrel with the British minister, Lord Strangford, and was summarily recalled in 1809. On the 31st of July 1810 he was made vice-admiral of the blue, and on the 18th of July 1812 was despatched as second in command under Sir Edward Pellew (afterwards Viscount Exmouth) to the Mediterranean, but the expedition was uneventful. His term of active service practically closed in 1814. He was made K.C.B. in 1815 and in 1821 admiral. The later years of his life were spent at Paris, where he died on the 26th of May 1840. His restless self-assertion brought him into collision with many of his contemporaries, including Nelson and Sir John Moore. Colonel Bunbury's *Narrative of some Passages in the Great War with France* contains a most amusing account of his theatrical vanity. But though by nature a boaster he was both daring and ingenious.

See Barrow, *Life of Admiral Sir W. S. Smith* (2 vols., 1848).

SMITH, a worker in metals. The O. Eng. *smid*, Du. *smid*, Ger. *Schmied*, &c., are from an obsolete Teut. verb *smeithan*, to forge. The root is seen in Gr. *σμίλη*, a graver's tool. It is apparently not connected with "smooth," where an original *m* has been lost. There is no foundation for the old etymological guess which identifies "smith" with "to smite," as the one who smites or beats iron. When used without such qualification as appears in "goldsmith," "silversmith," &c., the term means a worker in iron, especially as indicating a "blacksmith," one who forges iron, as opposed to "whitesmith," the finisher and polisher of iron, or "tinsmith," a worker in tin. The word has originated one of the commonest of English surnames, sometimes taking various archaic forms (Smyth, Smythe, Smigth, &c.; also German Schmidt).

SMITH COLLEGE, an American institution for the higher education of women, at Northampton, Massachusetts. It was founded by the will of Sophia Smith (1796-1870) of Hatfield, who gave money to Smith Academy in Northampton and to Andover Theological Seminary, and who left about \$365,000 "for the establishment and maintenance of an institution for the higher education of young women, with the design to furnish them means and facilities for education equal to those which are afforded in our colleges for young men"; she chose Northampton as the site of the college and selected the trustees. The college was chartered in 1871 and was opened in 1875.

On the college campus in the central part of Northampton are: College Hall, with administrative offices, an assembly hall, and lecture rooms; Seelye Hall, with department offices and recitation rooms; a library, completed in 1910 and containing 30,000 volumes in that year; an auditorium, with a large organ and a seating capacity of 2500; the Lilly Hall of Science; Chemistry Hall; an astronomical observatory; Music Hall; the Hillyer Art Gallery, with an endowment of \$50,000 for the increase of its collections; the Students' Building for the social life of the students; the Lyman Plant House and the Botanic Garden; the Alumnae Gymnasium; the Allen Recreation Field; sixteen (in 1910) dwelling-houses for the students on the plan of private homes, not dormitories; an infirmary; and Sunnyside, a home for convalescents. Entrance requirements differ little from those of the College Entrance Examination Board. All undergraduate courses are largely elective and lead to the degree of Bachelor of Arts. Graduate courses lead to the degrees of Master of Arts and Doctor of Philosophy, the latter degree being rarely conferred and "only in recognition of high scholarly attainment and of ability to carry on original research." In 1909-1910 there were 104 teachers and 1635 students (of whom 8 were graduate students), and the college had an endowment of about \$1,300,000. The annual tuition charge was \$100 until 1909, when it became \$150. There are six fellowships, of \$500 each, which are granted for graduate research; and there are many undergraduate scholarships, and loans are made to needy students by the Smith Students' Aid Society (1897). The College contributes to the American Classical Schools at Athens and Rome, to the Zoological Station at Naples, and to the Marine Biological Laboratory at Woods Hole, Massachusetts. The

first president of the college from 1873 to September 1910 was Lawrenus Clark Seelye (b. 1837), a graduate of Union College and of Andover Theological Seminary.

SMITH'S FALLS, a town and outport of Lanark county, Ontario, Canada, on the Rideau river and canal, and the Canadian Pacific railway, 28 m. N.W. of Brockville. Pop. (1901) 5155. It contains saw, shingle, woollen and planing mills, and large agricultural implement works, and has regular steamer connexion with Kingston and Ottawa by the Rideau river and canal.

SMITHSON, HENRIETTA CONSTANCE (1800-1854), Irish actress, was the daughter of a theatrical manager. She made her first stage appearance in 1815 at the Crow Street theatre, Dublin, as Albina Mandeville in Reynolds's *Will*. Three years later she made her first London appearance at Drury Lane as Letitia Hardy. She had no particular success in England; but in Paris, in 1828 and 1832, whither she first went with Macready, she aroused immense enthusiasm as Desdemona, Virginia, Juliet and Jane Shore. She had a host of admirers, among them Hector Berlioz (*q.v.*), whom she married in 1833. They separated in 1840. At the time of her marriage her popularity was already over and she was deeply in debt. A benefit was given her, but she had the mortification of seeing a rival applauded when she herself was coldly received. She retired from the stage, and died on the 3rd of March 1854.

SMITHSON, JAMES (1765-1829), British chemist and mineralogist and founder of the Smithsonian Institution at Washington, a natural son of Hugh Smithson, 1st duke of Northumberland, by Mrs Elizabeth Keate Macie, a granddaughter of Sir George Hungerford of Studley, was born in France in 1765. He was educated at Pembroke College, Oxford, where he graduated in 1786, and was known in early life as James Lewis (or Louis) Macie. He took the name of James Smithson about the year 1800. His attention was given to chemistry and mineralogy, and he published analyses of calamines and other papers in the *Annals of Philosophy* and *Phil. Trans.* The mineral name "smithsonite" was originally given in his honour by Beudant to zinc carbonate, but having also been applied to the silicate, the name is now rarely used. In 1784 he accompanied Faujas St Fond in his journey to the Western Isles, and in the English translation of the *Travels in England, Scotland and the Hebrides* (1799) Smithson is spoken of as "M. de Mecies of London." He was elected F.R.S. in 1787. He died at Genoa on the 27th of June 1829. By his will he bequeathed upwards of £100,000 to the United States of America to found the Smithsonian Institution. The institution (see below) was founded by act of Congress on the 10th of August 1846.

See "James Smithson and his Bequest" (with portraits), by W. J. Rhees, and "The Scientific Writings of James Smithson," edited by W. J. Rhees, *Smithsonian Misc. Coll.*, vol. xxi. (1879-1880).

SMITHSONIAN INSTITUTION, an American institution of learning in Washington, D.C., founded by the bequest of James Smithson (*q.v.*), who seems to have known of Joel Barlow's plan for a national institution of learning in the city of Washington in accordance with George Washington's recommendation in his farewell address of 1796. His estate was left to a nephew, Henry James Hungerford, with the stipulation that should Hungerford die without issue the whole estate should go "to the United States of America to found at Washington, under the name of the Smithsonian Institution, an establishment for the increase and diffusion of knowledge among men." Hungerford died without issue in 1835. There was much opposition in America to the acceptance of Smithson's bequest, especially by John C. Calhoun and others who held that Congress had no power under the Constitution to accept such a gift, but the gift was accepted, largely through the efforts of John Quincy Adams; and Richard Rush, sent to England as agent for the United States, quickly obtained a verdict for the American claim to the estate. In September 1838 £104,960 in gold sovereigns was delivered from the clipper "Mediator" to the Philadelphia mint, where it was recoined into American money, \$508,318.46; in 1867, after the death of Hungerford's mother, a residuary legacy of \$26,210 was received and the fund then

amounted to \$650,000. An act of the 7th of July 1838 (repealed in 1841) directed the investment of the money in state bonds, and \$500,000 was invested in Arkansas bonds which proved worthless, but Congress, considering that it was a trustee of the fund, made an appropriation to cover the loss. By other gifts, notably that of \$216,000 from Thomas George Hodgkins (d. 1892) of Setauket, Long Island, New York, the fund was increased: in 1910 it amounted to \$944,918, drawing interest at 6%.

There were many different suggestions as to how the fund should be used. The character of the National Institute (called National Institution before 1843), which was organized in 1840 "to promote science and the useful arts and to establish a national museum of history," had a great influence in shaping the act (approved on the 10th of August 1846) establishing the Smithsonian Institution and providing for an "establishment" by this name composed of the president, vice-president, secretaries of state, treasury, war and navy, the postmaster-general, the attorney-general,¹ the chief-justice of the supreme court and the commissioner of the patent office of the United States, the mayor of the city of Washington (amended in 1871 to read: governor of the District of Columbia), and such other persons as they may elect honorary members.² The same act provided for the government of the Institution by a Board of Regents composed of the vice-president of the United States, the mayor of the city of Washington (amended in 1871 as above), three members of the Senate (appointed by its president), three members of the House of Representatives³ (appointed by its speaker), two members of the National Institute of the City of Washington (chosen by joint resolution of the Senate and House of Representatives), and four others, inhabitants of four different states; the Board chose from its members a chancellor (in practice the vice-president of the United States until 1850 and since then the chief-justice). The act provided for the delivery to the Board of Regents and the maintenance in the buildings, which were to be erected according to the act, of "all objects of art and of foreign and curious research, and all objects of natural history," &c., belonging to the United States, including the collections of Smithson; and it enacted that any applicant for copyright should deliver one copy of the work to be copyrighted to the librarian of the Smithsonian Institution and another to the Librarian of Congress.⁴ Thanks to the efforts of J. Q. Adams, provision was made for the use of the income of the fund only and the principal was permanently invested.

The Regents met on the 7th of September 1846. Those appointed were: George Evans, Sidney Breese and Isaac S. Pennybacker, senators; Robert Dale Owen, William J. Hough and Henry W. Hilliard, members of the House of Representatives; Rufus Choate, Gideon Hawley, Richard Rush and William C. Preston, by joint resolution, from four different states; and Alexander Dallas Bache and General Joseph G. Totten, from the National Institute. They elected (Dec. 1846) as first secretary and director of the Institution, Joseph Henry, then professor of natural philosophy in the College of New Jersey (Princeton University), who presented in his first annual report (Dec. 1847) a "program of organization."⁵ The first paragraph contained the following:—"To Increase Knowledge: It is proposed (1) to stimulate men of talent to make original researches, by offering suitable rewards for memoirs containing new truths; and (2) to appropriate annually a portion of the income for particular researches, under the direction of

¹ The Secretary of the Interior was added in 1877 and the Secretary of Agriculture in 1894.

² No honorary members have been chosen since 1873, and an amendment of 1894 omits the provision for their election.

³ In January 1847 James D. Westcott objected to the constitutionality of the act because by it members of Congress were appointed (contrary to section 6, part ii. of the Constitution) to civil offices under the authority of the United States created during their term of office in Congress.

⁴ In 1865 the actual granting of copyright was transferred from the Smithsonian Institution to the Library of Congress.

⁵ Reprinted in *Smithsonian Institution Miscellaneous Collections*, vol. xxi. pp. 399-406.

suitable persons. *To Diffuse Knowledge:* It is proposed (1) to publish a series of periodical reports on the progress of different branches of knowledge; and (2) to publish occasionally separate treatises on subjects of general interest."

Henry was executive head (secretary) of the Institution from 1846 until his death in 1878 and its organization is due largely to him. He opposed the scheme for the gradual formation of a general library under the charge of the Institution, and in 1855 committed the Board of Regents to a repeal of the previous practice of spending one-half of the annual income on the museum and library, and this action was approved by an investigating congressional committee.⁶ Partly because of the prominence given to meteorological research when Henry was at the Albany Academy, and partly through the influence of James Pollard Espy (1785-1860), in 1846 a plan was presented for the unification and systematization of weather observation under the Institution, and in December 1847 an appropriation was made for such meteorological research; in 1849 telegraphic transmission of meteorological intelligence collected by the Institution was begun; in 1850 a standard "Smithsonian barometer" (Arnold Guyot's improvement of Ernst's improved Fortin "cistern barometer") was first distributed; weather maps were successfully made in 1856; and in 1870 the meteorological work of the Institution was incorporated as the Weather Bureau, independent of the Institution. After 1854 Henry's annual reports contained a "general appendix" with reports of lectures, such as were held under the auspices of the Institution until 1865, summaries of correspondence, special papers, &c. Before 1870 meteorology bulked largely in these reports; after that year there was more North American archaeology and ethnology.

Spencer F. Baird, Henry's successor, incorporated in the general appendix annual reports on the progress of the sciences, and he perfected Henry's system of "international exchanges," under which the Institution, through agents in the principal cities of Europe, exchanges its own publications, those of other departments of the United States government, and those of learned societies for foreign publications. Baird had been at the head of the United States National Museum, a branch of the Institution, before he became secretary of the Institution, and it was particularly developed during his administration. It was built up around the collections of the United States Patent Office, which were turned over to it in 1858, and those of the National Institute, transferred to the Smithsonian Institution in 1861, when the Institute was dissolved. A part of the collection (including Smithson's collection) was destroyed by fire in 1865. The small art collection which remained was exhibited in the Corcoran Gallery until 1896. A new building for the Museum was erected in 1881. Mrs Harriet Lane Johnston (1833-1903) left her art collection to a national gallery of art, when such a gallery should be established, and in 1906 the Supreme Court of the District of Columbia decreed that the art collection of the National Museum was a "National Gallery" and turned this collection over to the National Museum, whose art collections have been called since that time the National Gallery of Art and have been enlarged by the gift from Charles L. Freer of Detroit of more than 2300 pieces (since 1904), including the work of American artists (especially Whistler, Tryon and T. W. Dewing) and of Japanese and Chinese masters, and by the gift of about 90 American paintings from W. T. Evans of New York City. The museum gained much valuable archaeological and ethnological material from the exploring parties sent out under J. W. Powell, excellent ichthyological specimens through Baird's position as United States Fish Commissioner, and general collections from the exhibits made at the Centennial Exhibition of 1876 by the United States government; and it has a good herbarium. The Bureau of American Ethnology was established as a branch of the Institution in 1879, when the various organizations doing survey work in the West united as the United States Geological Survey and anthropological and ethnological research was transferred to the Smithsonian Institution. The director of the Bureau of Ethnology in 1879-1902 was J. W. Powell; he was succeeded by William H. Holmes.

Secretary Baird planned an astrophysical observatory and in 1887 appointed as assistant secretary of the Institution, to take charge of the observatory, Samuel P. Langley (*q.v.*), who succeeded as secretary⁷ upon Baird's death in the same year. In 1890 a small observatory was built in the Smithsonian Park; in 1891 an appropriation was made for astrophysical work and \$5000 was contributed by the executors of Dr J. H. Kidder (1842-1889). Langley's principal research in the observatory was on the nature of the infra-red portion of the spectrum. His name is also closely connected with his paper entitled *Experiments in Aerodynamics* (1891), and with the experiments and mathematical studies carried on under the Institution which proved that a machine other than a balloon could be made which would produce enough mechanical power to support itself and fly. Under the terms of the Hodgkins bequest prizes were

⁶ Congress was long jealous of the power of the Board of Regents; and in Congress there was for many years open opposition notably on the part of Andrew Johnson, to the very existence of the Institution.

⁷ In January 1907, after Langley's death, Charles Doolittle Walcott (b. 1850), a geologist, director of the U.S. Geological Survey in 1894-1907, became secretary of the Institution.

offered in 1893 for research and investigation of atmospheric air in connexion with the welfare of mankind; in 1895 an award of \$10,000 was made to Lord Rayleigh and Sir William Ramsay for their discovery of argon; and a medal was awarded to Sir James Dewar in 1899 and one to Sir J. J. Thomson in 1901. During Langley's administration the American Historical Association was incorporated in 1889 as a branch of the Institution, to whose secretary it makes its annual reports; and the National Society of the Daughters of the American Revolution was similarly incorporated in 1896. By acts of Congress of the 2nd of March 1889 and the 30th of April 1890 the National Zoological Park was established under the Institution; and in a park of 266 acres in the valley of Rock Creek a small collection was installed. In Langley's Annual Reports the summaries of the advance of science were omitted in 1889 and thereafter special papers of interest to professional students were published in their place. The Smithsonian Park occupies a square equivalent to nine city blocks, almost exactly the same size as the Capitol grounds. The oldest building, that of the Institution proper, was erected in 1847-1855; it is Seneca brown stone in a mingled Gothic and Romanesque style, designed by James Renwick, and occupies the S.W. corner of the grounds. E. of it is the building of the United States National Museum (330 ft. sq.), erected in 1881; and on the N. side of the park is the new building of the National Museum (1903). On the grounds is a bronze statue of Joseph Henry by W. W. Story.

The Institution publishes: *Annual Reports* (1846 seq.), in which the *Reports* of the National Museum were included until 1884—since then they appeared as "part ii." of that *Report*; *The Smithsonian Contributions to Knowledge* (quarto, 1848 sqq.); *The Smithsonian Miscellaneous Collections* (octavos, 1862 sqq.); *Proceedings of the United States National Museum* (1878 sqq.); *Bulletin of the United States National Museum* (1875 sqq.), containing larger monographs than those printed in the *Proceedings*; and occasional *Special Bulletins*; *Annual Reports of the Bureau of American Ethnology* (1880 sqq.); *Bulletin* (1877 sqq.), including *The Handbook of American Indians North of Mexico* (1907), part i. being *Bulletin* 30; and *Contributions to North American Ethnology* (1877 sqq.); *Annals of the Astrophysical Observatory* (1900 sqq.); and *Annual Reports of the American Historical Association* (1890 sqq.).

AUTHORITIES.—See Wm. J. Rhees, *A List of Publications of the Smithsonian Institution, 1846-1903* (Washington, 1903), being No. 1376 of the Smithsonian Miscellaneous Collections; also *The Smithsonian Institution, 1846-1890: The History of its First Half-Century* (Washington, 1897), edited by George Brown Goode, assistant secretary of the Institution; Wm. J. Rhees, *Smithson and His Bequest* (*ibid.* 1880), and *The Smithsonian Institution, 1846-1899* (*ibid.* 1901); and Richard Rathbun, *The National Gallery of Art* (*ibid.* 1909), being *Bulletin* 70 of the U.S. National Museum.

SMOHALLA, or SHMOQUALA (*i.e.* "preacher"), chief of the Wanapum tribe of North American Indians and founder of the religious sect called Dreamers, was born about 1820. On one occasion after a tribal fray he was left for dead, but recovered and journeyed through California, Mexico, Arizona and Nevada to his old home on the upper Columbia, Washington, where he announced that he had been in the spirit world and had returned with a new revelation. This consisted in a return to primitive Indian customs, and a priesthood and ritual based on the Roman Catholic type. Besides Sunday services the Dreamers hold a service for the commemoration of the dead in early spring, and thanksgivings for salmon and for berries in April and in October respectively. Smohalla had frequent trances and his influence extended over most of the tribes of eastern Washington, and Oregon and western Idaho. The sect gave some trouble in 1870 by refusing to come under reservation restrictions. A church was established at Priest's Rapids on the upper Columbia, and one at Union Gap on the Yakima reservation.

See James Mooney, "The Ghost-dance religion," in *14th Ann. Rep. Bureau of Ethnology* (Washington, 1896).

SMOKE (from O. Eng. *smōcan*, to smoke, reek, cf. Dutch *smook*, Ger. *Schmauch*, probably allied to Gr. *σμίχην*), the vapour or volatile matter which escapes from a burning substance during combustion, especially the visible vapour produced by the burning of coal, wood, peat or vegetable substances generally. In this article the various legislative and other measures recommended or adopted for the abating of the nuisance caused by the excessive production of smoke are dealt with. For smoking of tobacco see **TOBACCO** and **PIPE**, and for opium-smoking **OPIMUM**.

Smoke Abatement.—The nuisance created by coal smoke seems to have been recognized in London since 1306, when a citizen was tried, condemned and executed for burning "sea cole" in the city of London; but it is only in more modern times that the question has been regarded as one of real practical

importance. In 1785 the first smoke-abating invention was patented by James Watt, and in 1800 a mechanical stoker was patented by Robertson. In 1815 Cutler patented the first would-be smokeless grate for domestic purposes; and his principle of feeding underneath was afterwards adopted by Dr Neil Arnott. In 1819 a parliamentary select committee was appointed "to inquire how far persons using steam-engines and furnaces could erect them in a manner less prejudicial to public health and comfort." In 1843 another select committee recommended the introduction of a bill prohibiting the production of smoke from furnaces and steam-engines. In 1845 yet another select committee reported that such an act could not in the existing state of affairs be made to apply to dwelling-houses. The Acts of 1845 and 1847 followed as the results of these inquiries; and since then there has been much legislation brought to bear on factories and railways.

The Public Health Act 1875 contains the statutory law as to the emission of smoke and applies throughout the country, except to London and a few large provincial towns such as Manchester, Liverpool, Sheffield, Leeds, Bradford and Nottingham, where smoke nuisances are controlled by special local acts. The law applying to the Metropolis is identical with that which governs the country at large, and is contained in the Public Health (London) Act 1891.

Section 91, sub-section 7, of the Public Health Act 1875 enacts: "Any fireplace or furnace which does not, as far as practicable, consume the smoke arising from the combustible used therein, and which is used for working engines by steam, or in any mill, factory, dyehouse, brewery, bakehouse or gaswork, or in any manufacturing or trade process whatsoever"; and sub-sec. 8, "any chimney (not being the chimney of a private dwelling-house) sending forth black smoke in such quantity as to be a nuisance, shall be deemed to be a nuisance liable to be dealt with summarily in manner provided by this act."

A further clause provides that for the purposes of sub-sec. 7 the offence is not merely the emission of smoke, but the use of a fireplace or furnace "which does not as far as practicable consume the smoke," and this enables a technical defence to be raised which in practice has been found to destroy the efficacy of sub-sec. 7. Under sub-sec. 8 the mere fact of sending forth black smoke in such quantity as to be a nuisance is an offence, unless it be emitted from the chimney of a private dwelling-house. This sub-section is therefore always resorted to by sanitary authorities who initiate prosecutions for smoke nuisances. It has been decided that where black smoke issued from a chimney several times a day for varying periods the magistrate was justified in finding that the smoke issued in "such quantity as to be a nuisance," although it was not shown that any particular person, or property, was injuriously affected thereby (*South London Electric Supply Corporation v. Perrin* (1901) 2 K.B. 186). It has also been held that smoke need not be injurious to health in order to be a nuisance (*Gaskell v. Bayley*, 30 L.T.N.S. 316). It therefore follows that the issue of black smoke from ordinary factory chimneys is *per se* a nuisance. From a practical point of view, however, it is often found difficult to identify exactly the colour of the smoke, the appearance of which varies in accordance with the position of the observer, and the light behind or in front of the smoke. To aid inspectors various smoke charts and instruments have been devised, none of which is wholly satisfactory. The best chart is the Ringlemann smoke scale, made by ruling black lines at right angles on a white background. It has six shades, numbered 0-5, obtained by graduating the thickness of the lines.

The difficulty of accurately defining the colour of smoke has led to a movement, initiated by the London County Council, for securing the deletion of the word "black" from the Public Health Act, so as to leave to magistrates the duty of deciding a question of fact—whether the smoke complained of constituted a nuisance. The Nottingham Improvement Act 1874 (sec. 74) contains the most efficacious provisions in regard to smoke nuisances which are to be met with in England. It enables steps to be taken in cases where the engines or furnaces are not suitable, and if they are properly constructed, but negligently used, it enables the fireman or other responsible employee to be fined.

Although steam-engines and factories consume individually much more coal than dwelling-houses, they alone are not responsible for the smoke nuisance, for there is little doubt that domestic fires are mainly responsible for the smoky condition of the atmosphere of our towns, for they continue to evolve smoke undeterred by legislation. In 1881, however, a movement was begun by the National Health Society and the Kyrle Society, which resulted in a smoke abatement exhibition being held at

South Kensington. At the close of the exhibition a national smoke abatement institution, with offices in London, was formed.

In the United Kingdom the subject takes an important place in the programme of the Royal Sanitary Institute, whilst the Coal Smoke Abatement Society is devoted to improving the prevailing conditions, especially in the Metropolis, and has organized a number of exhibitions and conferences on the subject. Several smoke abatement committees exist in the provinces.

A knowledge of the nature of coal and of its combustion is essential for an understanding of the smoke problem. For the purposes of this article coals may be classified as smoke-producing or bituminous, and smokeless, the former including all those varieties most commonly used as fuel. The elementary constituents of such coals are carbon (generally about 80%), hydrogen, nitrogen, oxygen and sulphur, and they also contain a varying quantity of earthy impurity or ash. The process which occurs in a coal fire consists of two distinct operations. The first, which requires a comparatively low temperature and is independent of the presence of air, is one of destructive distillation, similar to that which occurs in the retorts of gasworks. It results in the decomposition of the coal, and the formation of the following substances:—(1) hydrogen, marsh-gas, carbon monoxide, ethylene, benzene, other hydrocarbons of the paraffin and benzenoid series, water—all of which are either gaseous at the temperature at which they are formed or capable of being converted into gas at somewhat higher temperatures, and all of which are combustible except the water; (2) ammonia and other nitrogenous compounds and certain compounds of sulphur, which are also volatile and combustible; (3) coke, which consists of carbon (and ash) and is non-volatile but combustible. It is these products of distillation, not the coal itself, that burn, in the strict sense of the word; and this second process requires the presence of air and also a much higher temperature than the first. If the combustion is perfect, the only products are (1) water-vapour, (2) carbon dioxide, (3) nitrogen and (4) sulphur dioxide, the first of which contains all the hydrogen originally present in the coal, the second all the carbon, the fourth all the sulphur, while the nitrogen is liberated as such together with the very much larger volumes of nitrogen derived from the air which has supplied the necessary oxygen. These products are discharged through the chimney.

Two things are necessary for ensuring such complete combustion, viz. an adequate, but not too large, supply of air, properly administered, and the maintenance of the requisite temperature. In practice, however, these conditions are never perfectly fulfilled, and consequently the combustion of coal is always more or less imperfect and gives rise to a complex mixture of vapours. This mixture contains not only the combustion products already mentioned, but also the following unburnt or partly burnt distillation products:—(5) hydrogen, (6) hydrocarbons, (7) carbon monoxide, (8) unburnt carbon in a very finely divided state, and also considerable volumes of unused air.

Usually the name "smoke" is applied to this vaporous mixture discharged from a chimney only when it contains a sufficient amount of finely divided carbon to render it dark-coloured and distinctly visible. The quantity, however, of this particular ingredient is apt to be overrated. It always bears an extremely small proportion to the vast volumes of water-vapour, carbon dioxide and nitrogen with which it is mixed; it probably never amounts, even in the worst cases, to 3% of the weight of the coal from which it is formed; and its importance, reckoned in terms of so much fuel wasted, is certainly not greater than that of the unburnt hydrogen and hydrocarbons. It is perhaps best to use the name "smoke" for all the products of imperfect combustion (5 to 8) which are avoidable, as contrasted with the necessary and unavoidable ingredients (1 to 4). The problem of smoke abatement is thus seen to resolve itself into the problem of the production of perfect combustion.

The solution of this problem would lead to an important saving in fuel. It has been calculated that at least twice as much coal is used in boiler fires and six times as much in domestic fires as is theoretically required for the production of the effects obtained. A considerable portion of this loss is certainly unavoidable; nevertheless, much of this enormous waste could be prevented by improved methods of combustion. Another advantage is the gain in cleanliness and public convenience; not only would there be an end to sooty chimneys, but the atmosphere of towns would no longer be polluted by unburnt carbon, whose total quantity is enormous, though the amount contained in any given puff of smoke is very small. The "London" or "pea-soup" fog would be avoided, not because

fogs would become any less frequent than now in London and other large cities, but because they would lose their distinctive grimy opacity.

An investigation of London fogs was made in 1901-1903 by the Meteorological Council with the assistance of the London County Council, from which it appeared that 20% of fogs were entirely due to smoke, and that in every case the density and duration of fogs was enormously added to by smoke.

It is often stated that these fogs are caused by the smoke that blackens them; but this is an error. The combustion of coal is certainly responsible for their existence, but it is the sulphur of the coal (oxidized ultimately to sulphuric acid), and not the carbon, that is the active agent. So long as coal is burnt at all this manufacture of sulphuric acid and of fogs must continue; it is not to be got rid of by improved methods of combustion, though the character of the fogs may be materially improved. The evil effects of town air on plant life and human lungs, also often attributed to preventible smoke, are in like manner due to this non-preventible sulphuric acid. Sixteen million tons of coal are annually used in London for heating purposes, and it has been shown by Dr Rideal that, as the sulphur content of this coal ranges from 1 to 2%, there is diffused in the air of the metropolis from half a million to a million tons of sulphuric acid every year. The extent to which smoke and fog affect life and injure property is, perhaps, a matter of opinion. It has, however, been proved that the death-rate enormously expands in foggy weather, and the Hon. Rollo Russell has made a careful calculation showing the extra cost which the smoke nuisance annually imposes upon London. The figure at which he has arrived is £5,470,000, including damage to buildings, fabrics and works of art.

The amount of coal consumed each year in the country was calculated by the Royal Commission on coal supplies to amount to 160,000,000 tons, of which 36,000,000 or 19.2% are consumed for domestic purposes, and 53,000,000 tons are used in ordinary factories. Thirteen million tons are taken by railways, 15,000,000 by gasworks and 28,000,000 tons by the iron and steel industries.

The methods that have been suggested for the abolition of smoke may be divided into two great classes, viz. those that seek to attain this end by improving the appliances for the burning of bituminous coal, and those that propose to abolish its use and substitute for it some other kind of fuel. The proposals of the first class may be divided into those applicable to domestic purposes and those applicable to boiler fires and other large-scale operations. Those of the second class may be divided according to the nature of the fuel which they suggest. The innumerable inventions of the first class depend for their success (so far as they are successful) on the attention bestowed on the scientific requisites for complete combustion, viz. a sufficient but not too great supply of air, the thorough admixture of this air with the products of the destructive distillation of the coal, and the maintenance of a high temperature within the fire. In the old and crude methods the facts which most militate against the attainment of these desiderata are—(1) that large masses of fresh fuel are thrown on at the top, which cool down the fire where the highest temperature is required; (2) that the products of the distillation of this fresh fuel, heated from below, do not get properly mixed with air till they have been drawn up the chimney; (3) that unduly large volumes of cold air are continually being sucked up through the fire, cooling it and carrying its heat away from where it is wanted, and yet without remedying the second evil. In the improved methods regularity of supply of both fuel and air is sought so as to maintain a steady evolution of distillation products, a steady temperature, and a steady and complete combustion. In many cases it is sought to warm fresh air before it enters the room by a regenerative system, the heat being taken from the escaping gases which would otherwise carry it up the chimney; and in some cases the air which feeds the fire is heated in the same way.

Tests applied at the South Kensington Exhibition of 1882 and in recent years by the Coal Smoke Abatement Society acting in conjunction with the Office of Works, for domestic grates and stoves, have included a chemical examination of the chimney gases, observations of the "smoke-shade" as indicating the proportion of unburnt carbon, and a record of the amount of coal burnt, of the rise of temperature produced, of the radiation, and of the amount of heat lost by being carried away through the chimney. Domestic grates and stoves are divided into six classes:—(1) open grates having ordinary bottom grids and upward draught; (2) open grates having solid floors (adapted for "slow combustion") and upward draught; (3) open grates fed from below, supplied with fresh fuel beneath the incandescent fuel; (4) open grates fed from the back or from the sides or from hoppers; (5) open grates having downward or backward or lateral draught; (6) close stoves. Each of these classes is subdivided according as the apparatus is "air-heating" or "non-air-heating," i.e. according as an attempt is or is not made to save heat on the regenerative principle. The following conclusions, among others, have been arrived at:—(a) the air-heating principle has not been applied with success except in class 5; (b) close stoves (class 6) are superior to open grates (total average of classes 1-5) in respect of freedom from smoke and of general heating effect, but

they are greatly inferior in radiating power; (c) the "slow-combustion" principle gives a high radiation factor, with a lower consumption of fuel, but is otherwise not successful; (d) the class of air-heating grates with downward, backward, or lateral draughts and with a large surface of fire-brick for radiating heat is, on the whole, most efficient (see HEATING).

In boiler fires, both for locomotives and for fixed appliances, the desiderata are essentially the same as in the case of domestic fires; the principles involved are consequently also the same, though the appliances are necessarily different. These improvements may be all classed under one or other of two heads, according as the mode of supplying the fuel or the mode of supplying the air is the subject of the improvement. These two kinds of improvement may of course be combined.

In the old forms of furnace fresh fuel, as it is wanted, is supplied by hand labour, the furnace doors being opened and large quantities of coal thrown in. One result of this is the inrush of great volumes of cold air, which, aided by the equally cold fuel, lowers the general temperature of the furnace. Mechanical stokers meet this difficulty by supplying the coal regularly in small quantities at a time. They may be divided into "coking" stokers, which deliver the coal at the front and gradually push it backward; "sprinkling" stokers, which scatter it generally over the surface of the grate; and "underfeed" stokers, which raise it from below so that the products of its distillation pass through the already incandescent fuel. The mechanism by which these results are attained is often of a complex nature.

It is generally recognized that air cannot be efficiently supplied to the furnace if admitted only in front, and accordingly many plans have been devised for supplying it also at the back and sides. In some cases currents of air are induced by steam-jets; but this plan has not always proved successful. The inventions on the regenerative principle are more generally satisfactory. In them the air, before entering the furnace, is made to circulate through chambers heated externally by the products of combustion, and, having thus acquired a high temperature and absorbed heat that would otherwise have been lost, is admitted through openings at the bridge. Many of these appliances are almost absolutely smokeless, and they are much in use, as they have been shown to effect great economy in coal consumption.

It must not be forgotten, however, that with the use of trained stokers a high degree of boiler efficiency is reached by hand-firing alone. Indeed, it has been proved by actual tests that, when pitted against untrained men, skilled stokers have raised the thermal efficiency of their plant by over 16%, without creating smoke nuisances. In Germany stokers are trained under careful state supervision, and similar work has been started at the Borough Polytechnic Institute by the London County Council.

The advocates of the total or partial disuse of smoke-producing coals are variously in favour of anthracite, coke, electric power, liquid fuel or gas.

In some factories, such as malting works, anthracite and other coals containing a high percentage of carbon may be and have long been advantageously used as fuel. They yield a much smaller percentage of distillation products than ordinary coals, and produce no smoke or almost none. But they are difficult to ignite, and in small fires difficult to keep burning without forced draught; they give very little flame, and are comparatively expensive, so that they are under considerable disadvantage as compared with the usual kinds of coal. Many grates and stoves have been devised for burning anthracite for domestic heating, and some of them are successful and economical; but, in view of the national prejudice in favour of a bright and open fire, it is not likely that anthracite will ever replace bituminous coal to any great extent in the British Isles, where the great coal-fields undoubtedly are the natural sources of fuel.

This remark, however, does not apply to the use of coke and of gas, which are themselves made from coal. Coke is produced in large quantities, both for its own sake and as a by-product in the manufacture of gas for lighting purposes, and is largely used in various kinds of furnaces. It gives no smoke; but it resembles anthracite also in being but ill adapted for use in open grates on account of the difficulty of ignition and the absence of flame.

One of the most notable features of the smoke abatement movement in recent years has been the manufacture of smokeless fuels capable of being readily and satisfactorily burnt in ordinary household grates. The use of such fuels is growing and will, in conjunction with the enormous expansion in the use of gas-cookers and heating appliances, do much to eliminate smoke nuisances from private houses. Over 750,000 gas-cookers are in use in the metropolis alone, and their aggregate effect in preventing the emission of smoke from kitchen chimneys must be very great.

Liquid fuel or natural petroleum, which has come into exceptional prominence during recent years as a heating agent, owes its success to its relatively smokeless combustion and high efficiency. The same applies to gaseous fuel, which includes in addition to ordinary coal gas other mixtures of gases which

burn with a high heating value and with no deleterious vapours or smoke (see FUEL: *Liquid and Gaseous*). Electricity is now also being largely utilized in factories for power purposes, and is thus bearing its share in solving the problem of smoke abatement.

See *Official Report of the Smoke Abatement Committee* (London, 1882); W. C. Popplewell, *The Prevention of Smoke* (1901); W. Nicholson, *Smoke Abatement* (1905); also the publications of the London Coal Smoke Abatement Society; Booth and Kershaw, *Smoke Prevention and Fuel Economy* (1904); *Reports of the Laws in certain Foreign Countries in regard to Emission of Smoke from Chimneys* (Foreign Office Return), Cd. 2347 (1905); *London Fog Inquiry* (1901-1902) (Reports to and by the Meteorological Council).

(O. M.; L. W. CH.)

SMOLENSK, a government of middle Russia, belonging partly to Great Russia and partly to White Russia, bounded by the governments of Moscow and Kaluga on the E., Orel and Chernigov on the S., Mogilev and Vitvsk on the W., and Pskov and Tver on the N. It covers an area of 21,632 sq. m. in the W. of the great central plateau, its N. districts extending towards the hilly region of the Valdai. The rivers being deeply cut in the plateau, the surface is also hilly in the W. districts (Smolensk, Dorogobuzh), whence it slopes away gently towards vast plains on the E. and S. Carboniferous limestones, containing a few deposits of coal (in Yukhnov) and quarried for building purposes, occupy the E. of Smolensk; chalk appears in the S. extremity; while tertiary sands, marls and ferruginous clays cover all the W. The whole is overlain with a thick sheet of boulder clay, with irregular extensions to the N.; post-tertiary sands are spread over wide surfaces; and peat-bogs fill the marshy depressions. The soil, mostly clay, is generally unfertile, and stony and sandy in several districts. The rivers Vazuza and Gzhat, both flowing into the Volga, and the Moskva and the Ugra, tributaries of the Oka, are channels for floating timber. The two tributaries of the Dvina—the Kasplya and the Mezha—are of much more importance, as they and their affluents carry considerable numbers of boats to Riga. The Dnieper takes its origin in Smolensk and drains it for more than 300 m.; but neither this river nor its tributaries (Vop, Vyazma, Sozh and Desna), whose upper courses belong to Smolensk, are navigable; timber only is floated down some of them. Many small lakes and extensive marshes occur in the N.W. More than one-third of the area is under forests. The climate is like that of middle Russia generally, although the moderating influence of the damp climate of W. Europe is felt to some extent. The average yearly temperature at the city of Smolensk is 45.5° Fahr. (January, 13.5°; July, 67.2°).

The estimated population in 1906 was 1,762,400. It is chiefly composed of White Russians (55%) in the W., and Great Russians (43%) in the E. Most of the inhabitants (98%) belong to the Orthodox Greek Church; the rest are Nonconformists. The government is divided into twelve districts, the chief towns of which are Smolensk, Byelyi, Dorogobuzh, Dukhovshina, Elnya, Gzhatsk, Krasnyi, Poryechie, Roslavl, Sychevka, Vyazma and Yukhnov.

Notwithstanding the unproductive soil and the frequent failures of crops (especially in the N.W.), the chief occupation is agriculture. Out of the total area 38½% is held by the village communities, 52% by private persons and 2½% by the crown; 7% is uncultivable. Nearly 30% of the surface is arable land, and over 20% is under meadows. The principal crops are rye, wheat, oats, barley, buckwheat and potatoes. Grain has to be imported. Improved agricultural implements are beginning to be manufactured within the government, and to be used by the landlords, and partly also by the peasants. Flax and hemp are important crops, and some tobacco is grown. The live stock of the peasantry suffer from a want of meadow and pasture land, which is chiefly in private ownership. The peasantry are mostly very poor, in consequence not only of the French invasion in 1812, the effects of which are still felt, but also of insufficient allotments and want of meadows. In the way of mining phosphorite only is extracted. The most important industries are cotton, oil and paper mills, distilleries and breweries. The timber trade and boat-building are important sources of income, but more than one-half of the male population of west Smolensk leave their homes every year in search of work, principally as navvies throughout Russia. A lively traffic is carried on on the rivers, principally the Kasplya, the Obzha and the Ugra, corn, hemp, hempseed, linseed and especially timber being shipped. A considerable quantity of corn is imported into the W. districts.

Smolensk is crossed by two important railways, from Moscow to Warsaw and from Riga to Saratov; a branch line connects Vyazma with Kaluga. (P. A. K.; J. T. BE.)

SMOLENSK, a town of Russia, capital of the government of the same name, on both banks of the Dnieper, at the junction of the railways from Moscow to Warsaw and from Riga to Orel, 252 m. by rail W.S.W. of Moscow. Pop. (1900) 57,405. The town, with the ruins of its old kreml, or citadel, is built on high crags on the left bank of the Dnieper. Its walls, built during the reign of Boris Godunov (1598-1605), are rapidly falling into decay. But the city has much improved of late years. It has monuments in commemoration of the war of 1812 and of the Russian musical composer, M. I. Glinka (1885). It has three public libraries, an historical and archaeological museum, a people's palace, and several scientific societies. The cathedral was erected in 1676-1772, on the site of a more primitive building (dating from 1101), which was blown up in 1611 by the defenders of the city during a siege by the Poles. The picture of the Virgin brought to Russia in 1046, and attributed to St Luke, which is kept in this cathedral, is much venerated throughout central Russia. Two other churches, built in the 13th century, have been spoiled by recent additions. Smolensk is neither a commercial nor a manufacturing centre.

Smolensk is one of the oldest towns of Russia, and is mentioned in Nestor's *Chronicle* as the chief town of the Slav tribe of the Krivichis, situated on the great commercial route "from the Varyaghs to the Greeks." It maintained a lively traffic with Constantinople down to the 11th century, when the principality of Smolensk included Vitebsk, Moscow, Kaluga and parts of the present government of Pskov. The princes of Kiev were often recognized as military chiefs by the *vyeche* (council) of Smolensk, who mostly preferred Mstislav and his descendants and Rostislav, son of Mstislav, became the ancestor of a series of nearly independent princes of Smolensk. From the 14th century these fell under the influence of the Lithuanian rulers, and in 1408 Smolensk was annexed to Lithuania. In 1449 the Moscow princes renounced their claims upon Smolensk; nevertheless this important city, with nearly 100,000 inhabitants, was a constant source of contention between Moscow and Lithuania. In 1514 it fell under Russian dominion; but during the disturbances of 1611 it was taken by Sigismund III. of Poland, and it remained under Polish rule until 1654, when the Russians retook it. In 1686 it was definitely annexed to Russia. In the 18th century it played an important part as a basis for the military operations of Peter the Great during his wars with Sweden. In 1812 it was well fortified; but the French, after a two days' battle, defeated the Russians here and took the city, when it suffered much.

SMOLENSKIN, PEREZ [PETER] (1842-1885), Russian Jewish novelist, was born near Mogilev (Russia) in 1842; he died at Meran (Austria) in 1885. His story is the Odyssey of an erring son of the Ghetto. He joined and left the opposite parties of the rationalists and the mystics, and followed a variety of precarious occupations. He settled in Odessa, where he familiarized himself with several European languages, and became an anti-nomian in religion, though he never left the Jewish fold. He became the rallying-point for the revolt of young Jewry against medievalism, the leader, too, in a new movement towards Jewish nationalism. His Hebrew periodical, the *Dawn* (*Ha-shahar*), exercised a powerful influence in both directions. Shortly before his death he became deeply interested in schemes for the colonization of Palestine, and was associated with Laurence Oliphant. Smolenskin was the first to dissociate Messianic ideals from theological concomitants. Smolenskin's literary fame is due to his Hebrew novels. He may be termed the Jewish Thackeray. In style and method his work resembles that of the English novelist. There is little doubt but that Smolenskin, had he written in any language but Hebrew, would be regarded as one of the great novelists of the 19th century. Of his novels only the best need be named here. *A Wanderer on the Path of Life* (*Ha-to'eh be-darkhe ha-Hayim*) is the story of an orphan, Joseph, who passes through every phase of Ghetto life; the work (1868-1870) is an autobiography, the form of which was sug-

gested by *David Copperfield*, but there is no similarity to the manner of Dickens. More perfect in execution is the *Burial of the Ass* (*Qeburath Hamor*) which appeared in 1874. A third novel, *The Inheritance* (*Ha-yerushah*), issued in 1880-1881, depicts life in Odessa and Rumania.

See N. Slouschz, *The Renaissance of Hebrew Literature*, chs. ix., x., xi. (I. A.)

SMOLLETT, TOBIAS GEORGE (1721-1771), British novelist, was born in the old grange of Dalquhurn, near Bonhill, in the vale of Leven, parish of Cardross, Dumbartonshire, and was christened on the 19th of March 1721. His father Archibald (youngest son of Sir James, the laird of Bonhill, a zealous Whig judge and promoter of the Union of 1707) had made what was deemed in the family an improvident marriage. Archibald died in 1723, and Sir James did what he could for the widow and her family during his lifetime. The elder son James was sent into the army. Tobias was sent to Dumbarton school, then in excellent repute under the grammarian John Love. When the grandfather died in 1731 there was no further provision, and after qualifying for a learned profession at Glasgow University, Tobias was apprenticed in 1736 for five years to a well-known surgeon in that city. This early "deception" conspired to make him angry, resentful and suspicious of motive; but he was neither vindictive nor ungenerous. If his tendency to satire and caricature made him enemies, his enthusiasm for Scottish history made him friends, and, in spite of peccadilloes, the "bubbly-nosed callant with a stane in his pouch," as Dr Gordon called him, seems as an apprentice to have won his master's regard. The lad's ambition would not allow him to remain in Glasgow. The example of Thomson and Mallet was contagious, and at the age of eighteen Smollett crossed the border in set form to conquer England with a tragedy, *The Regicide*, based on Buchanan's description of the death of James I.

The story of the journey is told with infinite spirit in the early chapters of *Roderick Random*. The failure of the play, his darling composition and certainly the worst thing he ever wrote, became the stock grievance of Smollett's life. For some months no one could be induced to read it, and the unrequited author would have been reduced to starvation had not a friend of the family procured him the position as surgeon's mate on H.M.S. "Cumberland." The fleet was ordered to attack Cartagena, the great stronghold of Spanish America, and the siege, which occupied most of the year 1741, proved the Walcheren expedition of the 18th century. Smollett as an eye-witness has left us a memorable picture of the miseries endured by soldiers and sailors, which historians have been content to accept as a first-hand authority in spite of the fact that it is embedded in the pages of a licentious novel. When the enterprise was abandoned the fleet returned to Jamaica. There Smollett fell in love with the daughter of a planter, Nancy Lascelles, whom he married on returning to England. Before this, having removed his name from the navy books (May 1744), he had set up as a surgeon in Downing Street; but he attracted attention more as a wit than as a leech. "Jupiter" Carlyle testifies to his brilliant accomplishments, and to the popularity he attained by his indignant verses "The Tears of Scotland," resenting Culloden. In the same year (July 1746) his name appeared upon the title-page of a political satire entitled *Advice*, followed characteristically in 1747 by *Reproof*, both of them "imitations from Juvenal" in the manner of Pope. He revenges himself in his satires on the should-have-been patrons of his play.

Disappointed alike in the drama, his profession and his wife's dowry, Smollett devoted his attention in a happy hour to fictitious adventure. Richardson had published the first part of *Pamela* in 1741, and Fielding his *Joseph Andrews* in 1742. But Smollett owed less to these models than to his studies in Cervantes, Swift, Defoe and above all Le Sage. His hero, who gives his first novel its capital name, *Roderick Random*, recounts like Gil Blas a life of varied adventure in the company of a servant, in which he enters the service of a physician and meets with old schoolfellows, thieves, notes of the bank of engraving, prison, semi-starvation and in the end an unexpected fortune. The author draws on

his adventures on the English highway and in the cockpit of a king's ship. Virtually he revealed the seaman to the reading world—divined his character, sketched his outlines, formulated his lingo, discovered his possibilities to such purpose that, as Scott says, every one who has written about the navy since seems to have copied more from Smollett than from nature. Pungent observation allied to a vigorous prose, emancipated to a rare degree from provincialism or archaism, were perhaps the first of Smollett's qualifications as a novelist. Such coherence as his novels have owes more to accidental accumulation than to constructive design. The wealth of amusing incident, the rapidly moving crowd of amusing and eccentric figures, atones for a good many defects. Smollett's peculiar coarseness and ferocity were gradually eliminated from English fiction, but from *Tom Jones* right down to *Great Expectations* his work was regularly ransacked for humour. There was no author's name on the title of the two small volumes of *Random*; Lady Mary Wortley Montagu thought a work so delightful could only be by Fielding, in whose name it was actually translated into French. But Smollett made no secret of the authorship, went to Paris to ratify his fame, and published his derelict play as "by the author of *Roderick Random*," hoping thus, as he said, to intimidate his discarded patrons. The incident well reveals the novelist's "systema nervosum maxime irritabile," of which his medical advisers spoke.

Smollett now became a central figure among the group of able doctors who hailed from north of the Tweed, such as Clephane, Macaulay, Hunter, Armstrong, Pitcairne and William Smellie, in the revision of whose system of Midwifery the novelist bore a part. He must have still designed to combine medicine with authorship, for in June 1750 he obtained the degree of M.D. from Marischal College, Aberdeen. But in the autumn of this year he already had another novel in prospect, and went over to Paris with a new acquaintance, Dr Moore (author of *Zeluco*), who soon became his intimate and was destined to become his biographer. The influence of this visit is marked in Smollett's second novel, *The Adventures of Peregrine Pickle* (4 vols., 1751). Like its predecessor, a loosely constructed string of episodes and adventures in which a still greater scope is afforded to the author for eccentric display, *Pickle* proved from the first a resounding success, both in England and France. The chief centres of attraction are the grotesque misanthrope of Bath, Cadwallader Crabtree, the burlesque scenes afforded by the physician (a caricature of Akenside) and Pallet the painter in Paris, and the so-called "garrison," with its inhabitants, Hatchway and Pipes and the inimitable Trunnion—whose death-scene fully exhibits Smollett's powers for the first time—the prototype of so many character portraits from Uncle Toby to Cap'n Cuttle. Trunnion's grotesque ride to church reappears in John Gilpin; the misanthrope, practising satire under cover of feigned deafness, reappears in the Mungo Malagrowther of Scott, who frankly admits further debts to Smollett in the preface to the *Legend of Montrose*. The "garrison" unquestionably suggested the "castle" of Tristram Shandy and the "fortress" of Mr Wemmick. Indeed it is no exaggeration to say that the tideway of subsequent fiction is strewn on every hand with the *disjecta membra* of Smollett's happy phrases and farcical inventions. *Pickle* himself is if possible a bigger ruffian than *Random*; in this respect at any rate Smollett clings to the cynical tradition of the old romances of roguery. The novel is marred to an even greater extent by interpolations and personal attacks than its predecessor; the autobiographical element is slighter and the literary quality in some respects inferior.

Smollett's third novel, *Ferdinand Count Fathom*, appeared in 1753, by which time the author, after a final trial at Bath, had definitively abandoned medicine for letters, and had settled down at Monmouth House, Chelsea, a married man, a father and a professional writer, not for patronage, but for the trade. In this capacity he was among the first to achieve a difficult independence. In *Fathom* Smollett endeavours unquestionably to organize a novel upon a plan elevated somewhat above mere agglomeration. It looks as if he had deliberately set himself to

show that he too, as well as the author of *Tom Jones*, could make a plot. The squalor and irony of the piece repel the reader, but it is Smollett's greatest feat of invention, and the descriptive power, especially in the first half, reveals the latent imaginative power of the author. Few novels have been more systematically plundered, for *Fathom* was the studio model of all the mystery and terror school of fiction commencing with Radcliffe and Lewis. With *Fathom* the first jet of Smollett's original invention was spent. The novel was not particularly remunerative, and his expenses seem always to have been profuse. He was a great frequenter of taverns, entertained largely, and every Sunday threw open his house and garden to unfortunate "brothers of the quill," whom he regaled with beef, pudding and potatoes, port, punch and "Calvert's entire butt-beer."

To sustain these expenses Smollett consented to become a literary impresario upon a hitherto unparalleled scale. His activity during the next six years was many-sided, chiefly in the direction of organizing big and saleable "standard" works for the booksellers and contracting them out to his "myrmidons." Thus we see him almost simultaneously editing *Don Quixote*, making a triumphant visit to Scotland, inaugurating a new literary periodical the *Critical* (Feb. 1756) by way of corrective to Griffith's *Monthly Review*, organizing a standard library *History of England* in quarto and octavo, with continuations, and a seven-volume compendium of *Voyages*, for which he wrote a special narrative of the siege of Cartagena, supplementary to his account in *Roderick Random*. In 1758 he projected and partly wrote a vast *Universal History*, and in January 1760 he brought out the first number of a new sixpenny magazine, the *British*, to which he contributed a serial work of fiction, the mediocre *Adventures of Sir Launcelot Greaves*. By these Herculean labours as a compiler Smollett must have amassed a considerable sum, to which the £200 received from the now forgiven "Marmozet" (Garrick) for the sixth performance of the patriotic extravaganza, *The Reprisal, or the Tars of Old England*, must have come as a welcome addition. The *Critical Review* was already responsible for plenty of thorns in the editorial cushion when in 1762 Smollett undertook the additional task of editing the *Briton*. He had already been ridiculed, insulted, fined and imprisoned in the Marshalsea (this last for an attack on Admiral Sir Charles Knowles). He was now to support the North British favourite of George III. in the press against all comers, not we may reasonably suppose without substantial reward. Yet after incurring all this unpopularity, at a time when the London mob was more inflamed against Scotsmen than it has ever been before or since, and having aroused the animosity of such former allies as Wilkes and his friend Churchill, Smollett was to find himself unceremoniously thrown over by his chief, Lord Bute, on the ground that his paper did more to invite attack than to repel it.

The *Briton* expired or was killed by the *North Briton* in February 1763, and for the moment Smollett allowed himself to be beckoned back by the booksellers to such tasks as a universal gazetteer and a translation of Voltaire in 38 volumes, and we hear of him prescribing work to his minions or receiving their homage and demanding their copy as of old. In April, however, his only daughter died at the age of fifteen, and, already over-wrought and almost broken down from sedentary strain, the tension proved too much and Smollett was never the same man again. His wife earnestly begged him to "convey her from a country where every object seemed only to nourish grief," and he followed her advice. The result was two years' sojourn abroad, mainly upon the Riviera, which Smollett, who may be termed the literary discoverer of Nice, turned to such excellent purpose in his *Travels* (2 vols., 1766), remarkable alike for their acidity and for their insight. On his arrival from Italy, where he had provided material for Sterne's portrait of the distressful "Smelfungus," Smollett seemed at first decidedly better and appeared to be getting over some of the symptoms of his pulmonic complaint. But his health was thoroughly undermined by rheumatism, and the pain arising from a neglected ulcer which had developed into a chronic sore helped to sap his strength. As soon, therefore,

as the *Travels* were out of hand Smollett resolved on a summer journey to Scotland. The society of Edinburgh, then at the apogee of its brilliance, paid due attention to the famous Dr Smollett. He was visited by Hume, Home, Robertson, Adam Smith, Blair, Carlyle, Cullen and the Monros. He went to Glasgow to see Dr Moore (where he patted the head of the future hero of Coruña), and stayed with his cousin, James Smollett, in his newly built mansion of Cameron. His mother, who hardly knew his toil-worn visage until it relaxed into his old roguish smile, died in this autumn, and he was still in a precarious state of health when he proceeded to Bath, spending the Christmas of 1766 in Gay Street, where his complaint at last took a turn for the better, and where it is possible that he may have commenced a rough draft of *Humphrey Clinker*.

In 1768 he was again in London, and with a return of his vital energy came a recrudescence of the old savagery. *The History and Adventures of an Atom* is a very clever, but abominably coarse, Rabelaisian satire upon the whole conduct of public affairs in England from the beginning of the Seven Years' War down to the date of publication. He lashes out on all sides without fear or favour. The king, Chatham, Bute and North are bespattered with filth, the acridity of which owes something to Gulliver, with aid as to local colour from the Jesuit and other accounts of Japan which had come under his ken as a compiler of travels. After its publication in 1769, without other serious consequences, Smollett's health completely relapsed, and in December (a consulate in the Mediterranean having been refused him) he left England finally, and settled first at Pisa and then near Antignano, a few miles out of Leghorn. There, during the autumn of 1770, he penned his immortal *Humphrey Clinker*, in which he reverts to his favourite form of itinerant letters, a rare example of late maturity of literary power and fecundity of humour. The sardonic humour, persistent curiosity and keen faculty of observation shown in the *Travels* are here combined with the mellow contentment of the voyager who has forgotten the small worries of transport and with the enthusiasm of the veteran who revisits the scenes of his youth. The character drawing, too, though still caustic, seems riper and more matured. Smollett's speculative and informing 18th-century mind is here content for the most part, like Goldsmith's, merely to amuse.

Smollett died at Leghorn aged fifty on the 17th of September 1771, and was buried in the old English cemetery there. Three years later the Smollett obelisk was put up at Renton (it now stands in the parish school-ground), half-way between Dumbarton and Balloch. The best portrait belongs to the Smollett family, Cameron House, Loch Lomond (engraved by Freeman, 1831). The genuineness of the others, if we except that in the Hunterian Museum, Glasgow, is doubtful. The novelist has been confused with the Dr Smollett, the contemporary of Dr William Hunter, who figures in Rowlandson's "Dissecting Room" (*Royal Coll. of Surgeons Cat.*, 1900).

Hume said that Smollett was like a coco-nut, rough outside, but full of human kindness within. He was easily ruffled by the rubs of fortune of which he had more than his fair share. Hence the adjectives corrosive and splenic so often applied to a nature essentially both generous and tender. After Fielding, Smollett counts as the greatest purveyor of comic prose-epic of contemporary life to his generation, if not to his century. Scott and Dickens regarded him as fully Fielding's equal. Hazlitt and Thackeray thought otherwise. Equally rationalist and pagan with Fielding, Smollett is more of a pedagogue and less of the instinctive scholar and wit than his predecessor. His method in its broad outlines is similar, historic and ambulant rather than philosophic or poetic, but he has more potential romance or poetry about his make-up than the mystery-hating Fielding. In the recognized requirements of prose-epic such as plot, character, scene, reflection and diction, Smollett could fairly hold his own. His prose, which carries on the robust tradition from Swift and Defoe to Johnson and Jeffrey, is more modern in tone than that of his great rival. In fictions such as *Tom Jones*, *Roderick Random* and the like, England could at length feel that it possessed compositions which might claim kinship and

comparison with Cervantes and Le Sage. Much that these writers attempted has been done again in a style better adjusted to the increasing refinement of a later age. But Smollett's great powers of observation and description, his caustic and indignant turn of speech, will long render him an invaluable witness in the century which he so well represents. Much that he did was mere hackwork, but at his best he ranks with the immortals.

The estimate formed of Smollett's work during the past generation has probably been a diminishing one, as we may infer in part from the fact that there is no standard Life and no definitive edition of the works. The chief collective editions are as follows: 6 vols., Edinburgh, 1790; 6 vols., London, 1796, with R. Anderson's Memoir; *Works*, ed. J. Moore, 1797 (re-edited J. P. Browne, 8 vols., 1872); *Works*, ed. Henley and Seacombe, Constable (12 vols., 1899-1902). To which must be added a one-volume *Miscellaneous Works*, ed. Thomas Roscoe (1841); *Selected Works* (with a careful life by David Herbert) (Edinburgh, 1870); Ballantyne's edition of the Novels with Scott's judicious memoir and criticism (2 vols., 1821); and Professor G. Saintsbury's edition of the Novels (12 vols., 1895). There are short Lives by Robert Chambers (1867), David Hannay (1887) and O. Smeaton (1897). Additional information of recent date will be found in the article on Smollett in the *Dict. Nat. Biog.*, Masson's *British Novelists* (and other books on the development of English Fiction), H. Graham's *Scottish Men of Letters in the Eighteenth Century*, *Blackwood's Mag.* for May 1900; and the present writer's introduction to Smollett's *Travels through France and Italy* (World's Classics, 1907).

SMUGGLING (O. Eng. *smeōgan*, *smūgan*, to creep, with the idea of secrecy), a breach of the revenue laws either by the importation or the exportation of prohibited goods or by the evasion of customs duties on goods liable to duty. Legislation on the subject in England has been very active from the 14th century downwards. In the reign of Edward III. the illicit [introduction of base coin from abroad led to the provision of the Statute of Treasons 1351, making it treason to import counterfeit money as the money called "Lushburgh." Such importation is still an offence, though no longer treason. After the Statute of Treasons a vast number of acts dealing with smuggling were passed, most of which will be found recited in the repealing act of 1825. In the 18th and the early years of the 19th century, smuggling (chiefly of wine, spirits, tobacco and bullion) was so generally practised in Great Britain as to become a kind of national failing. The prevalence of the offence may be judged from the report of Sir J. Cope's committee in 1732 upon the frauds on the revenue. The smuggler of the 18th century finds an apologist in Adam Smith, who writes of him as "a person who, though no doubt highly blamable for violating the laws of his country, is frequently incapable of violating those of natural justice, and would have been in every respect an excellent citizen had not the laws of his country made that a crime which nature never meant to be so." The gradual reduction of duties brought the offence in the United Kingdom into comparative insignificance, and it is now almost confined to tobacco, though the sugar duty has led to smuggling of saccharin. Most of the existing legislation on the subject of smuggling is contained in the Customs Consolidation Act 1876.

The main provisions are as follows. Vessels engaged in smuggling are liable to forfeiture and their owners and masters to a penalty not exceeding £500. Smuggled and prohibited goods are liable to forfeiture. Officers of customs have a right of search of vessels and persons. Fraudulent evasion or attempted evasion of customs duties renders the offender subject to forfeit either treble the value of the goods or £100 at the election of the commissioners of customs. Heavy penalties are incurred by resistance to officers of customs, rescue of persons or goods, assembling to run goods, signalling smuggling vessels, shooting at vessels, boats, or officers of the naval or revenue service, cutting adrift customs vessels, offering goods for sale under pretence of being smuggled, &c. Penalties may be recovered either by action or information in the superior courts or by summary proceedings. In criminal proceedings the defendant is competent and compellable to give evidence. The Merchant Shipping Act 1894 makes any seaman or apprentice, after conviction for smuggling whereby loss or damage is caused to the master or owner of a ship, liable to pay to such master or owner such a sum as is sufficient to reimburse the master or owner for such loss or damage, and the whole or a proportional part of his wages may be retained in satisfaction of this liability. Additional provisions as to smuggling are also contained in the Customs and Inland Revenue Act 1879, and the Customs and Inland Revenue Act 1881. A smuggling contract is generally illegal. But it may be valid, and the

vendor may recover the price of goods, even though he knew the buyer intended them to be smuggled, unless he actually aids in the smuggling so as to become *particeps criminis*. Contracts to defraud the revenue of a foreign state are, according to English decisions, not illegal. There is a German decision, more consonant with international morality, to the opposite effect.

The penalties for smuggling in the United States will be found mainly in tit. xxxiv. ch. 10 of the Revised Statutes. The seaman guilty of smuggling is liable to the same penalty as in England, and in addition to imprisonment for twelve months, s. 4596.

See Stephen Dowell's *History of Taxation* (2nd ed., 1888), and Luke Owen Pike's *History of Crime in England* (1873-1876); and for general accounts of smuggling see W. D. Chester, *Chronicles of the Customs Department* (1885); H. N. Shore, *Smuggling Days and Smuggling Ways* (1892); Alton and Holland, *The King's Customs* (1908); C. G. Harper, *The Smugglers: Picturesque Chapters in the Story of an Ancient Craft* (1909).

SMYBERT (or **SMIBERT**), **JOHN** (1684-1751), Scottish American artist, was born at Edinburgh in 1684, and died in Boston, Massachusetts, in 1751. He studied under Sir James Thornhill, and in 1728 accompanied Bishop Berkeley to America, with the intention of becoming professor of fine arts in the college which Berkeley was planning to found in Bermuda. The college, however, was never established, and Smybert settled in Boston, where he married in 1730. In 1731 he painted "Bishop Berkeley and His Family," now in the dining-hall, Yale University, a group of eight figures. He painted portraits of Jonathan Edwards and Judge Edmund Quincy (in the Boston Art Museum), Mrs Smybert, Peter Faneuil and Governor John Endecott (in the Massachusetts Historical Society), John Lovell (Memorial Hall, Harvard University), and probably one of Sir William Pepperrell; and examples of his works are owned by Harvard and Yale Universities, by Bowdoin College, by the Massachusetts Historical Society, and by the New England Historical and Genealogical Society. A son, NATHANIEL SMYBERT (1734-1756), was born in Boston on the 20th of January 1734, and died there on the 8th of November 1756. He was a pupil of his father, and dying at the age of twenty-two, left several important canvases, notably a portrait of Dorothy Wendell (in the Collection of Dr John L. Hale, Boston).

SMYRNA (*Ismir*), in ancient times one of the most important and now by far the greatest of the cities of Asia Minor, has preserved an unbroken continuity of record and identity of name from the first dawn of history to the present time.

1. *The Ancient City*.—It is said to have been a Lelegian city before the Greek colonists settled in Asia Minor. The name, which is said to be derived from an Amazon called Smyrna, is indubitably Anatolian, having been applied also to a quarter of Ephesus, and (under the cognate form Myrina) to a city of Aeolis, and to a tumulus in the Troad. The Aeolic settlers of Lesbos and Cyme, pushing eastwards by Larissa and Neonteichus and over the Hermus, seized the valley of Smyrna. It was the frontier city between Aeolis on the N. and Ionia on the S., and was more accessible on the S. and E. than on the N. and W. By virtue of its situation it was necessarily a commercial city, like the Ionian colonies. It is therefore not surprising that the Aeolic element grew weaker; strangers or refugees from the Ionian Colophon settled in the city, and finally Smyrna passed into the hands of the Colophonians and became the thirteenth of the Ionian states. The change had taken place before 688, when the Ionian Onomastus of Smyrna won the boxing prize at Olympia, but it was probably then a recent event. The Colophonian conquest is mentioned by Mimnermus (before 600 B.C.), who counts himself equally a Colophonian and a Smyrnaean. The Aeolic form of the name, *Σμύρνα*, was retained even in the Attic dialect, and the epithet "Aeolian Smyrna" remained long after the conquest. The situation of Smyrna on the path of commerce between Lydia and the west raised it during the 7th century to the height of power and splendour. It lay at the head of an arm of the sea, which reached far inland and admitted the Greek trading ships into the heart of Lydia. One of the great trade routes which cross Anatolia descends the Hermus valley past Sardis, and then diverging from the valley passes S. of Mt Sipylus and crosses a low pass into the little valley, about 7 m. long and 2 broad, where Smyrna lies between the mountains and

the sea. Miletus, and later Ephesus, situated at the sea end of the other great trade route across Anatolia, competed for a time successfully with Smyrna, but both cities long ago lost their harbours and Smyrna remains without a rival.

When the Mermaid kings raised the Lydian power and aggressiveness Smyrna was one of the first points of attack. Gyges (c. 687-652) was, however, defeated on the banks of the Hermus; the situation of the battlefield shows that the power of Smyrna extended far to the E., and probably included the valley of Nymph (Nif). A strong fortress, the ruins of whose ancient and massive walls are still imposing, on a hill in the pass between Smyrna and Nymph, was probably built by the Smyrnaean Ionians to command the valley of Nymph. According to Theognis (about 500 B.C.), "pride destroyed Smyrna." Mimnermus laments the degeneracy of the citizens of his day, who could no longer stem the Lydian advance. Finally, Alyattes III. (609-560) conquered the city, and Smyrna for 300 years lost its place in the list of Greek cities. It did not cease to exist, but the Greek life and political unity were destroyed, and the Smyrnaean state was organized on the village system (*ῥκεῖτο κωμηδόν*). It is mentioned in a fragment of Pindar, about 500 B.C., and in an inscription of 388 B.C. A small fortification of early style, rudely but massively built, on the lowest slope of a hill N. of Burnabat, is perhaps a fortified village of this period. Alexander the Great conceived the idea of restoring the Greek city; the two Nemeses who were worshipped at Smyrna are said to have suggested the idea to him in a dream. The scheme was, according to Strabo, carried out by Antigonos (316-301), and Lysimachus enlarged and fortified the city (301-281). The acropolis of the ancient city had been on a steep peak about 1250 ft. high, which overhangs the N.E. extremity of the gulf; its ruins still exist, probably in much the same condition as they were left by Alyattes. The later city was founded on the modern site partly on the slopes of a rounded hill called Pagus near the S.E. end of the gulf, partly on the low ground between the hill and the sea. The beauty of the city, clustering on the low ground and rising tier over tier on the hillside, is frequently praised by the ancients and is celebrated on its coins.

The "crown of Smyrna" seems to have been an epithet applied to the acropolis with its circle of buildings. Smyrna is shut in on the W. by a hill now called Deirmen Tepe, with the ruins of a temple on the summit. The walls of Lysimachus crossed the summit of this hill, and the acropolis occupied the top of Pagus. Between the two the road from Ephesus entered the city by the "Ephesian gate," near which was a gymnasium. Closer to the acropolis the outline of the stadium is still visible, and the theatre was situated on the N. slopes of Pagus. The line of the walls on the E. side is unknown; but they certainly embraced a greater area than is included by the Byzantine wall, which ascends the castle hill (Pagus) from the Basmakhanē railway station. Smyrna possessed two harbours—the outer, which was simply the open roadstead of the gulf, and the inner, which was a small basin, with a narrow entrance closed by a rope in case of need, about the place now occupied by bazaars. The inner harbour was partially filled up by Timur in 1402, but it had not entirely disappeared till the beginning of the 19th century. The modern quay has encroached considerably on the sea, and the coast-line of the Greek time was about 90 yds. farther S. The streets were broad, well paved and laid out at right angles; many were named after temples: the main street, called the Golden, ran across the city from W. to E., beginning probably from the temple of Zeus Akraios on the W. side of Pagus, and running round the lower slopes of Pagus (like a necklace on the statue, to use the favourite terms of Aristides the orator) towards Tepejik outside the city on the E., where probably the temple of Cybele, the Metroön, stood. Cybele, worshipped under the name of Meter Sipylene, from Mt Sipylus, which bounds the Smyrna valley on the N., was the tutelary goddess of the city. The plain towards the sea was too low to be properly drained and hence in rainy weather the streets were deep with mud and water.

The river Meles, which flowed by Smyrna, is famous in literature

and was worshipped in the valley. The most common and consistent tradition connects Homer with the valley of Smyrna and the banks of the Meles; his figure was one of the stock types on Smyrnaean coins, one class of which was called Homeric; the epithet "Melesigenes" was applied to him; the cave where he was wont to compose his poems was shown near the source of the river; his temple, the Homereum, stood on its banks. The steady equable flow of the Meles, alike in summer and winter, and its short course, beginning and ending near the city, are celebrated by Aristides and Himerius. The description applies admirably to the stream which rises from abundant fountains, now known as Diana's bath, E. of the city, and flows into the S.E. extremity of the gulf. The belief that the torrent, almost dry except after rains, which flows by Caravan bridge, is the ancient Meles, flatly contradicts the ancient descriptions.

In the Roman period Smyrna was the seat of a *conventus* which included S. Aeolis and great part of the Hermus valley. It vied with Ephesus and Pergamum for the title "First (city) of Asia." A Christian church existed here from a very early time, having its origin in the considerable Jewish colony. Polycarp was bishop of Smyrna and was martyred there A.D. 155. The bishops of Smyrna were originally subject to the metropolitan of Ephesus; afterwards they became independent (*αὐτοκέφαλοι*), and finally were honoured with metropolitan rank, having under them the bishops of Phocaea, Magnesia ad Sipylum, Clazomenae, Sosandrus (Nymphis?), Archangelus (Temnos?) and Petra (Menemen?).

When Constantinople became the seat of government the trade between Anatolia and the W. lost in importance, and Smyrna declined apace. A Turkish freebooter named Tsacha seized Smyrna in 1084, but it was recovered by the generals of Alexius Comnenus. The city was several times ravaged by the Turks, and had become quite ruinous when the emperor John Ducas Vatatzes about 1222 rebuilt it. But Ibn Batuta found it still in great part a ruin when the famous chieftain Aidin had conquered it about 1330 and made his son Amur governor. It became the port of the Aidin amirate. Soon afterwards the Knights of Saint John established themselves in the town, but failed to conquer the citadel. In 1402 Timur stormed the town and massacred almost all the inhabitants. The Mongol conquest was only temporary, but Smyrna was resumed by the Seljuks of Aidin and has remained till the present day in Mahommedan hands. Until the reign of Abdul Mejid it was included for administrative purposes in the *eyalet* of Jezair (the Isles) and not in that of Anadoli. The representative of the Capitan Pasha, who governed that *eyalet*, was, however, less influential in the city than the head of the Kara Osman Oglu's of Manisa (see MANISA). From the early 17th century till 1825, Smyrna was the chief provincial factory of the British Turkey Company, as well as of French, Dutch and other trading corporations. The passages with gates at each end within which most Frank shops in modern Smyrna lie, are a survival of the semi-fortified residences of the European merchants.

2. *The Modern City*, capital of the Aidin vilayet, and the most important town of Asia Minor. Pop. more than 250,000, of which fully a half is Greek. It is one of the principal ports of the Ottoman empire, and has a large trade, of which the greater part is with Great Britain. The chief items of export are figs, tobacco, valonia, carpets, raisins and silk, to the value of some three million sterling. The imports are estimated at a million more. About 7000 steamships visit the port annually. Until 1894 the two railways from Smyrna to the interior belonged to British companies; but in 1897 the Smyrna-Alashehr line passed into the hands of a French syndicate, which completed an extension to Affum Kara-hissar and virtually (though not actually) effected a junction with the Anatolian railway system. This line has branches to Burnabat and Soma. The Smyrna-Aidin line has been extended to Dineir, and powers have been obtained to continue to Isbarta and Egerdir. It has branches to Buja, Seidikeui, Tireh, Odemish, Sokia, Denizli and Ishekli.

Modern Smyrna is in all but government a predominantly Christian town (hence the Turks know it as *giaour Ismir*). There is a large European element (including about 800 British subjects), a great part of which lives in two suburban villages, Burnabat and Buja, but has business premises in the city. The European and Greek quarters rapidly increase, mainly to the N.; while the fine quays, made by a French company, are backed by a line of good buildings. The streets behind, though clean and well kept, are very narrow and tortuous. A fine new *Konak* (government offices) has been built, and another important new structure is the pier of the Aidin Railway Co. at Point. The development of this railway is the most conspicuous sign of progress.

Smyrna is a headquarters of missions of all denominations and has good schools, of which the International College is the best. There is a British consul-general, with full consular establishment, including a hospital.

See general authorities for *Asia Minor*, especially the travellers, almost all of whom describe Smyrna. Also B. F. Slaars, *Étude sur Smyrne* (1868); and W. M. Ramsay, *Letters to the Seven Churches* (1904) and article in *Hastings's Dict. of the Bible* (1902).
(W. M. RA.; D. G. H.)

SMYTH, CHARLES PIAZZI (1819-1900), British astronomer, was born at Naples on the 3rd of January 1819. He was called Piazzini after his godfather, the Italian astronomer of that name, whose acquaintance his father, Admiral Smyth, had made at Palermo when on the Mediterranean station. His father subsequently settled at Bedford and equipped there an observatory, at which Piazzini Smyth received his first lessons in astronomy. At the age of sixteen he went out as assistant to Sir Thomas Maclear at the Cape of Good Hope, where he observed Halley's comet and the great comet of 1843, and took an active part in the verification and extension of La Caille's arc of the meridian. In 1845 he was appointed astronomer royal for Scotland and professor of astronomy in the university of Edinburgh. Here he completed the reduction, and continued the series, of the observations made by his predecessor, Thomas Henderson (see *Edinburgh Observations*, vols. xi.-xv.). In 1856 he made experimental observations on the Peak of Teneriffe with a view to testing the astronomical advantages of a mountain station. The Admiralty made him a grant of £500 for the purpose, and a yacht—the "Titania"—of 140 tons and a fine 7½ in. equatorial telescope were placed at his disposal by friends. The upshot of the expedition was to verify Newton's surmise, that a "most serene and quiet air . . . may perhaps be found on the tops of the highest mountains above the grosser clouds." The scientific results were detailed in a *Report* addressed to the lords commissioners of the admiralty, 1858, in a communication to the Royal Society (*Phil. Trans.* cxlviii. 465) and in the *Edinburgh Observations*, vol. xii. A popular account of the voyage is contained in *Teneriffe, an Astronomer's Experiment*, 1858. In 1871-1872 Piazzini Smyth investigated the spectra of the aurora, and zodiacal light. He recommended the use of the "rainband" for weather prediction (*Jour. Scottish Meteor. Society*, v. 84), and discovered, in conjunction with Professor A. S. Herschel, the harmonic relation between the rays emitted by carbon monoxide. In 1877-1878 he constructed at Lisbon a map of the solar-spectrum (*Edin. Phil. Trans.* xxix. 285), for which he received the Macdougall-Brisbane prize in 1880. Further spectroscopic researches were carried out by him at Madeira in 1880 (*Madeira Spectroscopic*, 1882), and at Winchester in 1884 (*Edin. Phil. Trans.* vol. xxxii. pt. ii.). He published besides *Three Cities in Russia* (1862), *Our Inheritance in the Great Pyramid* (1864), *Life and Work at the Great Pyramid* (1867), and a volume *On the Antiquity of Intellectual Man* (1868). In 1888 he resigned his official position and retired to the neighbourhood of Ripon, where he died on the 21st of February 1900.

See *Month. Notices Roy. Astr. Society*, lxi. 189; *Observatory*, xxiii. 145, 184; R. Copeland in *Astr. Nach.* No. 3636, and *Pop. Astronomy* (1900), p. 384; *Nature*, lxii. 161 (A. S. Herschel); André and Rayet, *L'Astronomie pratique*, ii. 12.
(A. M. C.)

SMYTH (or SMITH), **JOHN** (c. 1570-1612), English non-conformist divine, commonly called the Se-baptist, was born

about 1570, and was educated at Christ's College, Cambridge, where he proceeded M.A. in 1593. He was probably vicar of Hutton Cranswicke in the E. Riding of Yorkshire from 1593 to 1600, when he was elected lecturer or preacher of the city of Lincoln, an office of which he was deprived in October 1602 for having "approved himself a factious man by personal preaching and that truly against divers men of good place." Two volumes of his Lincoln sermons, *The Bright Morning Star* (1603), an exposition of Psalm xxii., and *A Pattern of True Prayer* (1605), were dedicated to Lord Sheffield, who had acted as arbiter between the preacher and the corporation. While preparing these books he became connected with the Separatist movement in Scrooby and Gainsborough, joined the Gainsborough church, and became its pastor.¹ With Thomas Helwys, John Murton (or Morton) and others, he migrated to Amsterdam at the end of 1607 to escape religious persecution, and in that city practised as a physician, and became the leader of "the second English church" (see CONGREGATIONALISM). About this time he wrote his *Principles and Inferences concerning the Visible Church* in support of Robert Browne's theory of ecclesiastical polity, which was followed by *Parallels, Censures and Observations*, a reply to the *Christian Advertisements* of Richard Bernard (1568-1641), vicar of Worksop, a puritan who remained in the Anglican church. In 1608, too, appeared *The Differences of the Churches of the Separation*, in which he justified his non-communion with Johnson's church on the curious ground that it was no part of primitive and apostolic order to use a translation of scripture during worship, or at any rate to have it open before one while preaching (Christ having "closed the book" at Nazareth before His sermon). Under Mennonite influence he went farther, and by March 1609 when he published *The Character of the Beast*, he had become a Baptist (see BAPTISTS, sect. II.), contending against infant baptism because (1) it has neither precept nor example in the New Testament, (2) Christ commanded to make disciples by teaching them and then to baptize them. He and his company were then faced by the dilemma that their own infant baptism did not count, and Smyth solved the problem by first baptizing himself (hence the name Se-Baptist), probably by affusion, and then administering the rite to Helwys and the others. Afterwards with 41 others he decided that instead of baptizing himself he should have been baptized by the Mennonites, in spite of their heretical view of the Person of Christ, and applied for admission to their fellowship. They were somewhat suspicious of a man who had never held one position for long, and demanded a statement of doctrines, which he gave them in twenty articles written in Latin, and in *The Last Book of John Smyth, called the Retraction of his Errors*, together with a confession of faith in 100 Propositions. A friendly Mennonite allowed Smyth's church to meet in his bakery, but Smyth himself died of consumption in August 1612, more than two years before the remaining members of his band, by then reduced to 31, were admitted (January 1615) into the Mennonite communion. Helwys and Morton returned to England, and established the first English Baptist churches.

Smyth was, like the other Cambridge men of his day, especially the Separatists, the bondservant of logic, and wherever he saw "the beckoning hand of a properly constructed syllogism" he was ready to follow. Yet none of those who, in his generation, took the great step had, according to Bishop Creighton, "a finer mind or a more beautiful soul. None of them succeeded in expressing with so much reasonableness and consistency their aspirations after a spiritual system of religious belief and practice. None of them founded their opinions on so large and liberal a basis." In his last declaration he expressed his sorrow for the censures he had passed on Anglicans and Brownists alike, and wrote "All penitent and faithful Christians are brethren in the communion of the outward church, by what name soever they are known; and we salute them all with a holy kiss, being heartily grieved that we should be rent with so many sorts and schisms; and that only for matters of no moment."

See J. H. Shakespeare, *Baptist and Congregational Pioneers* (London, 1906); H. M. Dexter, *The England and Holland of the Pilgrims* (London and Boston, 1906). (A. J. G.)

¹ He was never vicar of Gainsborough, and must not be confused with the John Smyth who was imprisoned in the Marshalsea in 1592.

SMYTH, SIR WARINGTON WILKINSON (1817-1890), British geologist, was born at Naples on the 26th of August 1817, his father, Admiral W. H. Smyth (1788-1865), being at the time engaged in the Admiralty Survey of the Mediterranean. He was educated at Westminster and Bedford schools, and afterwards at Trinity College, Cambridge, where he graduated B.A. in 1839. Having gained a travelling scholarship he spent more than four years in Europe, Asia Minor, Syria and Egypt, paying great attention to mineralogy and mining, examining coalfields, metalliferous mines and salt-works, and making acquaintance with many distinguished geologists and mineralogists. On his return to England in 1844 he was appointed mining geologist on the Geological Survey, and in 1851 lecturer at the School of Mines, a post which he held until 1881 when he relinquished the chair of mineralogy but continued as professor of mining. In later years he became chief mineral inspector to the Office of Woods and Forests, and also to the Duchy of Cornwall. He was elected F.R.S. in 1858. He became president of the Geological Society of London in 1866-1868, and in 1879 he was chairman of a Royal Commission appointed to inquire into accidents in mines, the work in connexion with which continued until 1886. He contributed sundry papers to the *Memoirs of the Geological Survey*, the *Quarterly Journal of the Geological Society* and the *Transactions of the Royal Geological Society of Cornwall*. He was author also of *A Year with the Turks* (1854), and of *A Treatise on Coal and Coal-mining* (1867). He was knighted in 1887. He died in London on the 19th of June 1890, and was buried at St Erth, not far from his country home at Marazion in Cornwall.

A portrait and some reminiscences of W. W. Smyth will be found in the Memoir of Sir A. C. Ramsay (1895), by Sir A. Geikie.

SMYTH (or **SMITH**), **WILLIAM** (c. 1460-1514), bishop of Lincoln, was a Lancashire man by birth, and probably passed some of his early days at Knowsley under the roof of Margaret, countess of Richmond and Derby, the mother of Henry VII. He appears to have been a member of Lincoln College, Oxford, and in 1485, just after the battle of Bosworth, he was made keeper of the hanaper of the chancery. Two of Edward IV's daughters were entrusted to his keeping; he was a member of the royal council and he obtained the livings of Combe Martin, Devon, of Great Grimsby and of Cheshunt, Hertfordshire. In 1491 he was made dean of St Stephen's, Westminster, and two years later bishop of Coventry and Lichfield. The bishop was a member of Prince Arthur's council in the marches of Wales, and in 1501, five years after he had been translated to the bishopric of Lincoln, he became lord president of Wales. About 1507 he and Sir Richard Sutton (d. 1524) set to work to found a new college in Oxford. They rebuilt Brasenose Hall, added other existing halls to it, and having obtained a charter in 1512, called it *The King's haule and college of Brasenose*. Smyth, who was one of the executors of Henry VII.'s will, retired from public life just after this King's death, owing probably to some differences between Bishop Richard Fox and himself; he was, however, president of Wales until his death at Buckden in Huntingdonshire on the 2nd of January 1514. Although an able and scholarly man, Smyth had little sympathy with the new learning. He bestowed rich livings upon his relatives, one of whom, Matthew Smyth, was the first principal of Brasenose College. In addition to his liberal gifts to Brasenose College he gave money or land to Lincoln and to Oriel Colleges; he founded a school at Farnworth, Lancashire, and he refounded the hospital of St John at Lichfield. From 1500 to 1503 he was chancellor of Oxford University.

SNAIL. In England the word "snail" in popular language is associated with Gasteropods which inhabit land or fresh water, and which possess large conspicuous spiral shells; terrestrial Gasteropods, in which the shell is rudimentary and concealed, are distinguished as "slugs." In Scotland the word "slug" is absent from the vernacular vocabulary, both shell-bearing and shell-less inland molluscs being known as snails. Marine Gasteropods are occasionally termed "sea-snails," and the compounds "pond-snails," "river-snails," "water-snails" are in common use. The commonest land-snails are those species which

constitute the family *Helicidae*, order *Pulmonata*, sub-order *Stylommatophora*. The families *Limacidae*, *Arionidae* and *Oncidiidae* of the same sub-order, include nearly all the slugs. The *Oncidiidae* are entitled to the name "sea-slugs," as they are shell-less Pulmonates living on the seashore, though not actually in the sea. The term "water-snails" includes the whole of the remaining sub-order of the *Pulmonata*, namely, the *Basommatophora*, in which the eyes are sessile, with the exception of the *Auriculidae*. The latter are terrestrial and occur mostly near the seashore. Thus the whole of the *Pulmonata* (which breathe air, are destitute of gill-plumes and operculum and have a complicated hermaphrodite reproductive system) are either snails or slugs. But there are a considerable number of snails, both terrestrial and aquatic, which are not Pulmonates. The land-snails which have no gill-plume in the mantle-chamber and breathe air, but have the sexes separated, and possess an operculum, belong to the orders *Aspidobranchia* and *Pectinibranchia*, and constitute the families *Helicinidae*, *Proserpinidae*, *Hydrocenidae*, *Cyclophoridae*, *Cyclostomatidae* and *Aciculidae*. The fresh-water snails which are not Pulmonates are the *Paludinidae*, *Valvatidae* and *Ampullaridae*, together with *Neritina*, a genus of the *Neritidae*. These all possess a fully developed gill-plume and are typical Pectinibranchs of the sub-order *Taenioglossa*, most of the members of which are marine.

The family *Helicidae* has a world-wide distribution. In *Helix* the spire forms a more or less obtuse-angled cone; there are above 1200 species, of which 24 are British. *Helix nemoralis*, L., of which *H. hortensis* is a variety, is one of the commonest forms. *Helix pomatia*, L., is the largest species, and is known as the "edible snail"; it is commonly eaten in France and Italy, together with other species. It was formerly believed to have been introduced into Britain by the Romans, but there is no doubt that it is a native. In *Succinea* the cone of the spire is acute-angled; three species are British. In *Vitrina* the spire is very flat and the surface glassy. In *Bulimus* the spire is elongated with a pointed apex. *Pupa* is named from its resemblance to a chrysalis, the apex being rounded. The shell of *Clausilia* is sinistral and its aperture is provided with a hinged plate. The commoner European slugs of small size all belong to the genus *Limax*, in which the opening of the mantle-chamber is posterior. *L. flavus* is the cellar slug. *L. agrestis*, *L. arborum*, *L. maximus* occur in gardens and fields. The larger black slugs are species of *Arion*, of which two are British, *A. ater* and *A. hortensis*. *Testacella haliotideia* is common in Great Britain and throughout Europe.

The species of *Helix* are all herbivorous, like the Pulmonata generally; snails and slugs are well-known enemies to the gardener. The animals being hermaphrodite copulate reciprocally. The eggs of *Helix* are laid separately in the earth, each contained in a calcified shell; those of *Limax* are also separate, but the shell is gelatinous. *Helix* hibernates in a torpid condition for about four months, and during this period the aperture of the shell is closed by a calcareous membrane secreted by the foot.

The *Limnaeidae* occur in all parts of the world. *Limnaeus* contains the largest species. *L. pereger*, Müller, is ubiquitous in Great Britain and common all over Europe. All the species are usually infested with *Cercariae* and *Rediae*, the larval forms of Trematode parasites of vertebrates. *L. truncatulus* harbours the *Cercaria* of *Fasciola hepatica*, the liver-fluke, which causes rot in sheep. *Ancylus*, which occurs in rivers, has a minute limpet-like shell. *Planorbis* has the spire of the shell in one plane. *Physa* is smaller than *Limnaeus* and has the upper part of the spire much shorter. In the *Auriculidae* the aperture is denticulated. *Auricula* is confined to the East Indies and Peru. *Carychium minimum* is British.

Of the *Cyclostomidae* only one species, *Cyclastoma elegans*, Müller, is British; it hides under stones and roots. The *Helicinidae* are exotic, ranging from the West Indies to the Philippines. Of the *Aciculidae*, which are all minute, *Acicula lineata* is British.

The *Ampullaridae* are confined to the tropics. *Ampullaria* has very long tentacles and a long siphon formed by the mantle. *Valvata* is common in fresh waters throughout Britain; the gill when the animal is expanded is protruded beyond the mantle-chamber. The *Paludinidae* are common in the N. hemisphere. *Paludina* and *Bithynia* are both British genera. In *Paludina* the whorls of the spiral are very prominent; the genus is viviparous, *Bithynia* is smaller and the shell smoother.

Neritina has a very small spire, the terminal portion of the shell containing nearly the whole animal.

For the morphology and classification of snails, see GASTROPODA. A history of the British forms is given in Gwyn Jeffreys's *British Conchology* (1862), and by Forbes and Hanley in *British Mollusca*. For speicographical details, see Woodward's *Manual of the Mollusca* (1875), and Bronn's *Tierreich* (Weichtiere). For *Fasciola hepatica*, see Thomas, *Quart. Journ. Mic. Sci.* (1882).

SNAKE-BIRD (the "darter" of many authors, and the *Plotus anhinga*¹ of ornithology), the type of a small but very well-marked genus of birds, *Plotus*, belonging to the family *Phalacrocoracidae* which contains the cormorants and shags. The name commonly given to it by the English in N. America was derived from its "long slender head and neck," which, its body being submerged as it swims, "appears like a snake rising erect out of the water" (J. Bartram's MS., quoted by G. F. Ord in A. Wilson's *Am. Ornithology*, ix. 8r). Snake-birds bear a general resemblance both outwardly and in habits to Cormorants (*q.v.*), but are much more slender in form and have both neck and tail much elongated. The bill also, instead of being tipped with a maxillary hook, has its edges beset with serratures directed backwards, and is sharply pointed—in this respect, as well as in the attenuated neck, likening the Snake-birds to the Herons; but the latter do not generally transfix their prey as do the former.

The male of the American species, which ranges from Illinois to the S. of Brazil, is in full breeding-plumage a very beautiful bird, with crimson irides, the bare skin round the eyes apple-green and that of the chin orange, the head, neck and most part of the body



Indian Snake-Bird (from S. R. Tickell's Drawing in the Library of the Zoological Society).

clothed in black glossed with green; but down each side of the neck runs a row of long hair-like white feathers, tinged with pale lilac. The much elongated scapulars, and the small upper wing-coverts bear each a median white mark, which on the former is a stripe pointed at either end, and on the latter a broad ovate patch.² The larger wing-coverts are dull white, but the quill-feathers of the wings and tail are black, the last broadly tipped with brownish-red, passing into greyish-white, and forming a conspicuous band when the tail is spread in form of a fan, as it often is under water.³ The hen differs much in appearance from the cock, having the head, neck and breast of a more or less deep buff, bounded beneath by a narrow chestnut band; but otherwise her plumage is like that of her mate, only not so bright in colour. The Snake-bird frequents the larger rivers or back-waters connected with them, where it may be seen resting motionless on some neighbouring tree, generally choosing a dead branch, or on a "snag" projecting from the bottom, whence it plunges beneath the surface, in pursuit of its prey, to emerge, in the manner before related, showing little more than its slender head and neck. Its speed and skill under water are almost beyond exaggeration, and it exhibits these qualities even in captivity, taking—apparently without effort—fish after fish, however rapidly they may swim and twist, and only returning to its perch when its appetite is appeased or its supply of food exhausted. At liberty it will indulge in long flights, and those of the male at the breeding-

¹ "Anhinga," according to Marcgrav, who first described this bird (*Hist. rer. nat. Brasiliae*, p. 218), was the name it bore among the natives.

² These feathers are very characteristic of each species of the genus, and in India, says Jerdon, are among the Khasias a badge of royalty.

³ This peculiarity, first pointed out to the writer by A. D. Bartlett, who observed it in birds in the Zoological Society's possession, doubtless suggested the name of "Water-Turkey" by which in some places *Plotus anhinga* is said to be known.

season are ostentatiously performed in the presence of his mate, around whom he plays in irregular zigzag courses. The nest is almost always in trees or bushes overhanging the water's edge, and is a large structure of sticks, roots and moss, in which are laid four eggs with the white chalky shell that is so characteristic of most Steganopodous birds. Not infrequently several or even many nests are built close together, and the locality that suits the Snake-bird suits also many of the herons.¹ The African snake-bird, *P. congensis* (or *levaillanti* of some authors), inhabits the greater part of that continent N. from Natal; but, though met with on the White Nile, it is not known to have occurred in Egypt, a fact the more remarkable seeing that Canon Tristram found it breeding in considerable numbers on the Lake of Antioch, to which it is a summer visitor, and it can hardly reach its home without passing over the intervening country. The male bird is easily distinguishable from the American species by its rufous coronal patch, its buff throat and its chestnut greater wing-coverts. A third species, *P. melanogaster*, ranges from Madagascar to India, Ceylon, Borneo, Java and China. This so closely resembles the last-mentioned that the differences between them cannot be briefly expressed. The Australian region also has its snake-bird, which is by some regarded as forming a fourth species, *P. novae-hollandiae*; but others unite it to that last mentioned, which is perhaps somewhat variable, and it would seem (*P.Z.S.*, 1877, p. 349) that examples from New Guinea differ somewhat from those inhabiting Australia itself.

The anatomy of the genus *Plotus* has been dealt with more fully than that of most forms. Beside the excellent description of the American bird's alimentary canal furnished to Audubon by Macgillivray, other important points in its structure have been well set forth by A. H. Garrod and W. A. Forbes in the *Zoological Proceedings* (1876, pp. 335-345, pls. xxvi.-xxviii.; 1878, pp. 679-681; and 1882, pp. 208-212), showing among other things that there is an appreciable anatomical difference between the species of the New World and of the Old; while the osteology of *P. melanogaster* has been admirably described and illustrated by A. Milne-Edwards in A. Grandidier's great *Oiseaux de Madagascar* (pp. 691-695, pls. 284, 285). In all the species the neck affords a feature which seems to be unique. The first seven of the cervical vertebrae form a continuous curve with its concavity forward, but the eighth articulates with the seventh nearly at a right angle, and, when the bird is at rest, lies horizontally. The ninth is directed downwards almost as abruptly, and those which succeed present a gentle forward convexity. The muscles moving this curious framework are as curiously specialized, and the result of the whole piece of mechanism is to enable the bird to spear with facility its fishy prey. (A. N.)

SNAKE-FLY, the name given to neuropterous insects of the genus *Raphidia*, closely allied to the alder-flies, remarkable for the elongation of the head and prothorax to form a neck and for the presence in the female of a long ovipositor. The larva, which is active and carnivorous, is terrestrial, and lives in rotten timber.

SNAKE-ROOT. In most countries where snakes abound some root or herb is used by the natives as an antidote for the bites of venomous species, and many herbs have consequently received the name of snake-root. Botanically speaking, the name properly belongs to *Ophiorrhiza Mungos*, the Mongoose plant, a plant of the natural order Rubiaceae, used in the E. Indies for the purpose above indicated. In medicine, however, the roots of *Aristolochia Serpentaria*, *Polygala Senega* and *Cimicifuga racemosa* were understood by this name, being distinguished as the Virginian, seneca and black snake-roots. The root of *Aristolochia reticulata* is known in the United States as Red river or Texan snake-root.

The roots or rhizome of *Liatris spicata*, *Eryngium aquaticum* and *Eupatorium altissimum* have all been used in N. America for snake-bites, the first two being known as button snake-root and the last as white snake-root. The rhizome of *Asarum canadense* passes under the name of Canadian snake-root. All of these contain acrid or aromatic principles which, when a warm decoction of the drug is taken, exercise a powerfully diaphoretic or, in some cases, diuretic action, to which any benefit that may be derived from their use must be attributed.

SNAKES, an order (*Ophidia*) in the class of Reptiles. They may be characterized as very elongated reptiles without limbs (unless with tiny vestiges of posterior limbs), without eyelids and external ear openings, with the teeth anchored to the supporting bones, a bifid slender tongue which is telescoped into its basal half, and with a transverse vent. These characters apply to all snakes, although none are peculiar to them. The

¹ The curious but apparently well-attested fact of the occurrence in England, near Poole, in June 1851, of a male bird of this species (*Zoologist*, pp. 3601, 3654) has been overlooked by several writers who profess to mention all cases of a similar character.

vast majority of snakes are further characterized by having the right and left halves of the under-jaws connected by an elastic band; a median, longitudinal furrow in the skin below and behind the chin; the whole palatal apparatus is but loosely connected with the skull, nowhere articulating with it. The quadrate is indirectly articulated with the skull, first by the horizontal, movable squamosal, secondly by the columella auris. The quadrato-mandibular joint is placed in a level far behind the occiput.

More detail concerning skull, scales and teeth will be found in the diagnostic descriptions of the various families (*vide infra*); for further anatomical information the reader is referred to the article REPTILES (*Anatomy*).

The snakes are the most highly specialized branch of the *Sauria* or *Squamata*, i.e. of scaly reptiles with movable quadrate bones; with a transverse vent, near the posterior lateral corners of which open the eversible, paired copulatory organs. In the article LIZARD attention is drawn to the many characters which make it difficult, if not impossible, to give diagnoses applicable to all lizards and all snakes. Both these groups seem to have reached their climax but recently, while the tortoises, crocodiles and sphenodon are on the descending scale, mere remnants of formerly much more numerous and cosmopolitan development.

The number of recent species of snakes is about 1600. The order is practically cosmopolitan, with the exception of New Zealand and certain absolutely isolated oceanic islands, like the Hawaiian islands and the Azores. The N. limit approaches that of the permanently frozen subsoil, going into the arctic circle in Scandinavia, elsewhere sinking to about 54° N.; in the S. hemisphere the 45th parallel may indicate their limit. The number of species and individuals steadily decreases in the cooler temperate zones, whilst it reaches its maximum in the tropics. Every kind of terrain is tenanted, from dense, moist and hot forests at the level of the sea to arid deserts, high plateaus and mountains. In accordance with this general distribution snakes show a great amount of differentiation with regard to their mode of life and general organization; and from the appearance alone of a snake a safe conclusion can be drawn as to its habits.

Dr A. Günther characterizes the chief categories as follows:— (1) Burrowing snakes, which live under ground and but rarely appear on the surface. They have a cylindrical rigid body, covered with generally smooth and polished scales; a short strong tail; a short rounded or pointed head with narrow mouth; teeth few in number; small or rudimentary eyes; no abdominal scutes or only narrow ones. They feed chiefly on invertebrate animals, and none are poisonous. (2) Ground snakes rarely ascending bushes or entering water. Their body is cylindrical, flexible in every part, covered with smooth or keeled scales, and provided with broad ventral and subcaudal scutes. The non-poisonous kinds of ground snakes are the typical and least specialized snakes, and more numerous than any of the other kinds. They feed chiefly on terrestrial vertebrates. The majority are non-poisonous; but the majority of poisonous snakes must be referred to this category. (3) Tree snakes, which are able to climb bushes or trees with facility or pass even the greater part of their existence on trees. Their body is generally compressed and slender; their broad ventral scutes are often carinate on the sides. Those kinds which have a less elongate and cylindrical body possess a distinctly prehensile tail. The eye is generally large. Their coloration consists often of bright hues, and sometimes resembles that of their surroundings. They feed on animals which likewise lead an arboreal life, rarely on eggs. Poisonous as well as innocuous snakes are represented in this category. (4) Freshwater snakes, living in or frequenting fresh waters; they are excellent swimmers and divers. The nostrils are placed on the top of the snout and can be closed whilst the animal is under water. Their body is covered with small scales and the ventral scutes are mostly narrow; the tail tapering; head flat, rather short; and the eyes of small size. They feed on fish, frogs and other aquatic animals, and are innocuous and viviparous. (5) Sea snakes are

distinguished by the compressed, rudder-shaped tail. They are unable to move on land, feed on fishes, are viviparous and poisonous.

The majority of snakes are active during the day, their energy increasing with the increasing temperature; whilst some delight in the moist sweltering heat of dense tropical vegetation, others expose themselves to the fiercest rays of the midday sun. Not a few, however, lead a nocturnal life, and many of them have, accordingly, their pupil contracted into a vertical or more rarely a horizontal slit. Those which inhabit temperate latitudes hibernate. Snakes are the most stationary of all vertebrates; as long as a locality affords them food and shelter they have no inducement to change it. Their dispersal, therefore, must have been extremely slow and gradual. Although able to move

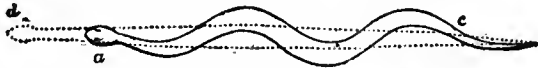

FIG. 1.—Diagram of Natural Locomotion of a Snake.

with rapidity, they do not keep in motion for any length of time. Their organs of locomotion are the ribs, the number of which is very great, nearly corresponding to that of the vertebrae of the trunk. They can adapt their motions to every variation of the ground over which they move, yet all varieties of snake locomotion are founded on the following simple process. When a part of the body has found some projection of the ground which affords it a point of support, the ribs are drawn more closely together, on alternate sides, thereby producing alternate bends of the body. The hinder portion of the body being drawn after, some part of it (*c*) finds another support on the rough ground or a projection; and, the anterior bends being stretched in a straight line, the front part of the body is propelled (from *a* to *d*) in consequence. During this peculiar locomotion the numerous broad shields of the belly are of great advantage, as by means of their free edges the snake is enabled to catch and use as points of support the slightest projections of the ground. A pair of ribs corresponds to each of these ventral shields. Snakes are not able to move over a perfectly smooth surface. The conventional representation of the progress of a snake, in which its undulating body is figured as resting by a series of lower bends on the ground whilst the alternate bends are



FIG. 2.—Diagram of Conventional Idea of a Snake's Locomotion.

raised above it, is an impossible attitude, nor do snakes ever climb trees in spiral fashion, the classical artistic mode of representation. Also the notion that snakes when attacking are able to jump off the ground is quite erroneous; when they strike an object, they dart the fore part of their body, which was retracted in several bends, forwards in a straight line. And sometimes very active snakes, like the cobra, advance simultaneously with the remainder of the body, which, however, glides in the ordinary fashion over the ground; but no snake is able to impart such an impetus to the whole of its body as to lose its contact with the ground. Some snakes can raise the anterior part of their body and even move in this attitude, but it is only about the anterior fourth or third of the total length which can be thus erected.

With very few exceptions, the integuments form imbricate scale-like folds arranged with the greatest regularity; they are small and pluriserial on the upper parts of the body and tail, large and uniserial on the abdomen, and generally biserial on the lower side of the tail. The folds can be stretched out, so that the skin is capable of a great degree of distension. The scales are sometimes rounded behind, but generally rhombic in shape and more or less elongate; they may be quite smooth or provided with a longitudinal ridge or keel in the middle line. The integuments of the head are divided into non-imbricate shields or plates, symmetrically arranged, but not corresponding in size or shape with the underlying cranial bones or having any relation to them. The form and number of the scales and scutes, and the shape and arrangement of the head-shields, are of great value in distinguishing the genera and species, and it will

therefore be useful to explain in the accompanying woodcut (fig. 3) the terms by which these parts are designated. The skin does not form eyelids; but the epidermis passes over the eye, forming a transparent disk, concave like the glass of a watch, behind which the eye moves. It is the first part which is cast off when the snake sheds its skin; this is done several times in the year, and the epidermis comes off in a single piece, being, from the mouth towards the tail, turned inside out during the process.

The tongue in snakes is narrow, almost worm-like, generally of a black colour and forked, that is, it terminates in front in two extremely fine filaments. It is often exerted with a rapid motion, sometimes with the object of feeling some object, sometimes under the influence of anger or fear.

Snakes possess teeth in the maxillaries, mandibles, palatine and pterygoid bones, sometimes also in the intermaxillary; they may be absent in one or the other of the bones mentioned.

In the innocuous snakes the teeth are simple and uniform. In structure, thin, sharp like needles, and bent backwards; their function consists merely in seizing and holding the prey. In some all the teeth are nearly of the same size; others possess in front of the jaws (Lycodonts) or behind in the maxillaries (Diacrasterians)

a tooth more or less conspicuously larger than the rest; whilst others again are distinguished by this larger posterior tooth being grooved along its outer face.

The snakes with this grooved kind of tooth have been named *Opisthoglyphi*, and also *Suspecti*, because their saliva is more or less poisonous. In the true poisonous snakes the maxillary dentition has undergone a special modification.

The so-called colubrine venomous snakes, which retain in a great measure an external resemblance to the innocuous snakes, have the maxillary bone not at all, or but little, shortened, armed in front with a fixed, erect fang, which is provided with a deep groove or canal

for the conveyance of the poison, the fluid being secreted by a special poison-gland. One or more small ordinary teeth may be placed at some distance behind this poison-fang. In the other venomous snakes (viperines and crotalines) the maxillary bone is very short, and is armed with a single very long curved fang with a canal and aperture at each end.

Although firmly anchored to the bone, the tooth, which when at rest is laid backwards, is erectile,—the bone itself being mobile and rotated round its transverse axis. One or more reserve teeth, in various stages of development, lie between the folds of the gum and are ready to take the place of the one in function whenever it is lost by accident, or shed.

The poison is secreted in modified upper labial glands, or in a pair of large glands which are the homologues of the parotid salivary glands of other animals. For a detailed account see West, *J. Linn. Soc.* xxv. (1895), p. 419; xxvi. (1898), p. 517; and xxviii. (1900). A duct leads to the furrow or canal of the tooth. The Elapinae have comparatively short fangs, while those of the vipers, especially the crotaline snakes, are much longer, sometimes nearly an inch in length. The Viperidae alone have "erectile" fangs. The mechanism is explained by the diagrams (fig. 4). The poison-bag lies on the side of the head between the eye and the mandibular joint and is held in position by strong ligaments which are attached to this joint and to the maxilla so that the act of opening the jaws and concomitant erection of the fangs automatically squeezes the poison out of the glands.

Snakes are carnivorous, and as a rule take living prey only; a few feed habitually or occasionally on eggs. Many swallow

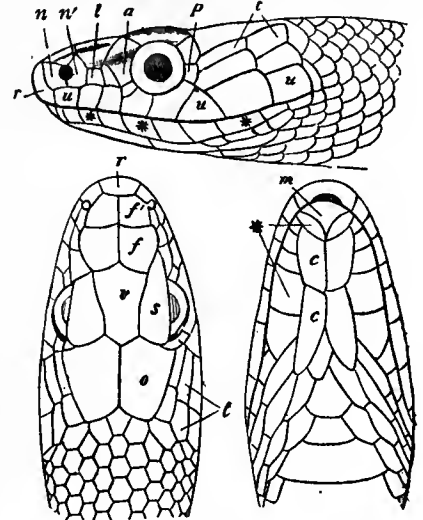

FIG. 3.—Head-shields of a Snake

(*Ptyas korros*).

- r*, Rostral.
- f*, Posterior frontal.
- f*, Anterior frontal.
- v*, Vertical.
- s*, Supraciliary or supraocular.
- o*, Occipital.
- n, n'*, Nasals.
- l*, Loreal.
- a*, Anterior ocular or orbital, or prae-orbital or anteocular.
- p*, Postocular.
- u, u*, Upper labials.
- t, t*, Temporals.
- m*, Mental.
- *, **, Lower labials.
- c, c*, Chin-shields.

is laid backwards, is erectile,—the bone itself being mobile and rotated round its transverse axis. One or more reserve teeth, in various stages of development, lie between the folds of the gum and are ready to take the place of the one in function whenever it is lost by accident, or shed.

The poison is secreted in modified upper labial glands, or in a pair of large glands which are the homologues of the parotid salivary glands of other animals. For a detailed account see West, *J. Linn. Soc.* xxv. (1895), p. 419; xxvi. (1898), p. 517; and xxviii. (1900). A duct leads to the furrow or canal of the tooth. The Elapinae have comparatively short fangs, while those of the vipers, especially the crotaline snakes, are much longer, sometimes nearly an inch in length. The Viperidae alone have "erectile" fangs. The mechanism is explained by the diagrams (fig. 4). The poison-bag lies on the side of the head between the eye and the mandibular joint and is held in position by strong ligaments which are attached to this joint and to the maxilla so that the act of opening the jaws and concomitant erection of the fangs automatically squeezes the poison out of the glands.

Snakes are carnivorous, and as a rule take living prey only; a few feed habitually or occasionally on eggs. Many swallow

their victim alive; others first kill it by smothering it between the coils of their body (constriction). The effects of a bite by a poisonous snake upon a small mammal or bird are almost instantaneous, preventing its escape; and the snake swallows its victim at its leisure, sometimes hours after it has been killed. The prey is always swallowed entire, and, as its girth generally much exceeds that of the snake, the progress of deglutition is very laborious and slow. Opening their jaws to their fullest extent, they seize the animal generally by the head, and pushing alternately the right and left sides of the jaws forward, they press the body through their elastic gullet into the stomach, its outlines being visible for some time through the distended walls of the abdomen. Digestion is quick and much accelerated by the quantity of saliva which is secreted during the progress of deglutition, and in venomous snakes probably also by the chemical action of the poison. The primary function of the poison-apparatus is to serve as the means of procuring their food, but

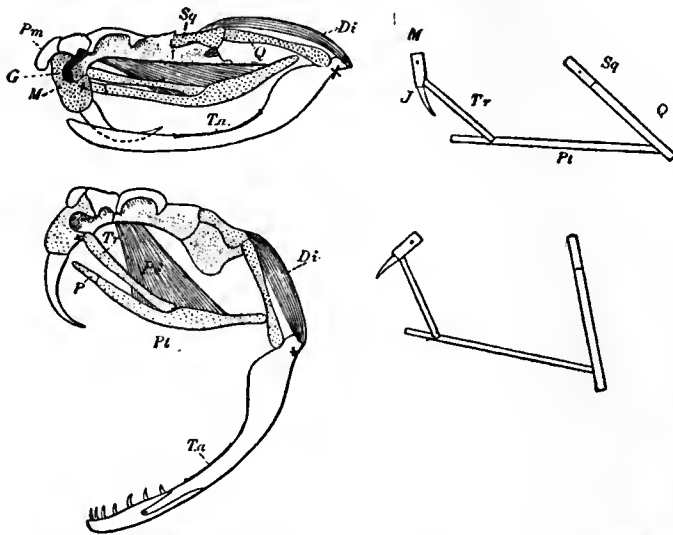

From Cambridge Natural History, vol. viii., "Amphibia and Reptiles," by permission of Macmillan & Co., Ltd.

FIG. 4.—Poison Apparatus of Rattlesnake. Upper figures: diagrams of skull with fangs at rest. Lower figures: same, with fangs protruded. G, prefrontal; M, maxilla; J, poison-fang; Tr, transpalatine; Pt, pterygoid; p, palatine; Q, quadrate; Sg, squamosal; Pm, premaxilla; Ta, articular; Pe and Di, muscles.

it also serves for defence. Only very few poisonous snakes (like *Naja elaps*) are known to resent the approach of man so much as to follow him on his retreat and to attack him. Others are much less inclined to avoid collision with man than innocuous kinds. They have thus become one of the greatest scourges to mankind, and Sir J. Fayer has demonstrated that in India alone annually some 20,000 human beings perish from snake-bites. Therefore it will not be out of place to add here a chapter on snake poison and on the best means (ineffectual though they be in numerous cases) of counteracting its deleterious effects. An excellent account of the nature and of the effect of the venom of snakes, by Charles J. Martin, is in Allbutt's *System of Medicine*. The following condensed account has been abstracted from it.

The poison is a clear, pale-yellow fluid which reacts acid, and contains about 30% of solids, but this varies according to the state of concentration. Most venoms are tasteless, but cobra poison is said to be disagreeably bitter. Dried venom keeps indefinitely, and dissolves readily in water. It keeps also in glycerine. It contains albuminous bodies in solution, and is in fact a pure solution of two or more poisonous proteids, which are the active agents, with a small quantity of an organic acid or colouring matter. The venom is destroyed by reagents which precipitate proteids in an insoluble form, or which destroy them, e.g. silver nitrate or permanganate of potash. Hypochlorites have the same effect. But carbolic acid and caustic potash destroy it only after a day or two, consequently they are not a remedy.

The venom is generally introduced into the subcutaneous tissue, whence it reaches the general circulation by absorption through the lymph and blood-vessels. When introduced directly into a vein, the

effects are instantaneous. It is absorbed by the conjunctiva, but, excepting cobra poison, not by the mouth or alimentary canal, provided there be no hollow teeth and no abrasions. The venom of the various kinds of snakes acts differently.

The Symptoms of Cobra Poison.—Burning pain, followed by sleepiness and weakness in the legs after half an hour. Then profuse salivation, paralysis of the tongue and larynx, and inability to speak. Vomiting, incapacity of movement. The patient seems to be conscious. Breathing becoming difficult. The heart's action is quickened. The pupil remains contracted and reacts to light. At length breathing ceases, with or without convulsions, and the heart slowly stops. Should the patient survive, he returns rapidly to complete health.

Rattlesnake Poison.—The painful wound is speedily discoloured and swollen. Constitutional symptoms appear as a rule in less than fifteen minutes: prostration, staggering, cold sweats, vomiting, feeble and quick pulse, dilatation of the pupil, and slight mental disturbance. In this state the patient may die in about twelve hours. If he recovers from the depression, the local symptoms begin to play a much more important part than in cobra-poisoning: great swelling and discoloration extending up the limb and trunk, rise of temperature and repeated syncope, and laboured respiration. Death may occur in this stage. The local haemorrhagic extravasation frequently suppurates, or becomes gangrenous, and from this the patient may die even weeks afterwards. Recovery is sudden, and within a few hours the patient becomes bright and intelligent.

Symptoms of Bite from the European Viper.—Local burning pain; the bitten limb soon swells and is discoloured. Great prostration, vomiting and cold, clammy perspiration follow within one to three hours. Pulse very feeble, with slight difficulty in breathing, and restlessness. In severe cases the pulse may become imperceptible, the extremities may become cold, and the patient may pass into coma. In from twelve to twenty-four hours these severe constitutional symptoms usually pass off, but in the meantime the swelling and discoloration have spread enormously. Within a few days recovery usually occurs somewhat suddenly, but death may occur from the severe depression, or from the secondary effects of suppuration.

The symptoms of the bite from the *Daboia* or *Vipera russeli* resemble the effects of rattlesnake poison, but sanious discharges from the rectum, &c., are an additional and prominent feature. The recovering patient suffers from haemorrhagic extravasations in various organs, besides from the lungs, nose, mouth and bowels. Kidney haemorrhage and albuminuria is a constant symptom. The pupil is always dilated and insensitive to light.

Bite of Australian Elapine Snakes.—Pain and local swelling. The first constitutional symptoms appear in fifteen minutes to two hours. First faintness and irresistible desire to sleep. Then alarming prostration and vomiting. Pulse extremely feeble and thread-like, and uncountable. The limbs are cold and the skin is blanched. Respiration becomes shallow with the increasing coma. Sensation is blunted. The pupil is widely dilated and insensible to light. There is sometimes passing of blood. If the patient survives the coma, recovery is complete and as a rule rapid, without secondary symptoms.

The Australian venom and that of all viperine snakes, perhaps also that of the cobra, if introduced rapidly into the circulation, occasions extensive intravascular clotting. If the venom is slowly absorbed, the blood loses its coagulability, owing to the breaking down of the red blood-corpuscles, most so with vipers, less with Australian snakes, least so with the cobra. The cobra venom is supposed to extinguish the functions of the various nerve-centres of the cerebro-spinal system, the paralysis extending from below upwards, and it has a special affinity for the respiratory centre. The toxicity or relative strength of the cobra venom has been calculated to be sixteen times that of the European viper. Snakes can poison each other, even those of the same kind.

Treatment.—Apply a ligature above, not on the top of, the situation of the bite, twist the string tightly with a stick. Then make a free incision into the wound. Sucking out is dangerous! Then bandage the limb downwards, progressing towards the wound; repeat this several times. Do not keep the ligature longer than half an hour. Then let the circulation return, and apply the ligature again. In any case do not keep the ligature on for more than an hour for fear of gangrene. Direct application into the widened wound of calcium hypochlorite, i.e. bleaching powder, is very good, or of a 1% solution of permanganate of potash, or Condy's fluid. Vigorous cauterization with nitrate of silver, driving the stick into the widened wound, is also good, and it is a remedy which one can carry in the pocket. Quick amputation of the finger is the best remedy of all if a large snake has bitten it.

Internal Remedies.—The administration of enormous doses of alcohol is to be condemned strongly. Small, stimulating doses, and repeated, are good, but stimulation can be more effectively produced by ammonia or strychnine. Hypodermic injection of strychnine, in some cases as much as one to two grains (but not into a vein!), has in some cases had good results; but injection of ammonia, instead of doing any good, has disastrous sloughing results. There is only one fairly reliable treatment, that by serum therapeutics, the injection of considerable quantities of serum of animals which have

been partially immunized by repeated doses of [that particular] snake-venom. Unfortunately this treatment will not often be available. Several mammals and birds are supposed to be immune by nature against snake-venom. Some more or less immune creatures are the mongoose, the hedgehog and the pig, the secretary-bird, the honey buzzard, the stork and probably other snake-eaters.

Snakes are oviparous; they deposit from ten to eighty eggs of an ellipsoid shape, covered with a soft leathery shell, in places where they are exposed to and hatched by moist heat. The parents pay no further attention to them, except the pythons, which incubate their eggs by coiling their body over them, and fiercely defend them. In some families, as many freshwater snakes, the sea snakes, Viperinae and Crotalinae, the eggs are retained in the oviduct until the embryo is fully developed. These snakes bring forth living young.

The classification of snakes has undergone many vicissitudes. J. Müller (*Zeitschr. f. Physiol.*, 1831, p. 265) divided them into

Ophidia macrostomata and *O. microstomata*. A. M. C. Duméril (*Catal. méthodique, Mus. d'Hist. Nat.*, Paris, 1851, p. 199) distinguished between Opoterodonta,

Aglyphodonta, Proteroglypha and Solenoglypha. H. Stannius (*Zootomie d. Amphib.*, 1856) made a further improvement by combination of the principles used by his predecessors, and he divided the Angiostomata or narrow-mouthed snakes into Tortricina, Typhlopina and Uropeltacea; the Eurystomata into Iobola or poisonous, and *Asinea* or innocuous snakes. Meanwhile J. E. Gray (*Cat. Snakes*, Brit. Mus., 1846) had distinguished only between Viperina and Colubrina. A. Günther (*Cat. Colubrine Snakes*, Brit. Mus., 1858; "Reptiles of British India," Ray Soc., 1864; article SNAKES, *Ency. Brit.*, 9th ed.) recognized at last four sub-orders:—Hopoterodontes, Colubriformes, Colubriformes venenosi, Viperiformes; the most serious drawback being the merging of the Peropoda in the non-poisonous Colubriformes. E. D. Cope (*Proc. Ac. Philad.*, 1864, p. 230) resorted to the modifications of the squamosal, ecto- and endopterygoid bones, the condition of the vestigial limbs, and the teeth:—Scoleophidia (Typhlopidae), Catodonta (Glauconiidae), Tortricina (Ilysiidae and Uropeltidae), *Asinea*, Proteroglypha and Solenoglypha. He adhered to this arrangement in his last comprehensive work (*Crocodylians, Lizards and Snakes of North America*, 1898, Smithsonian Inst., 1900), but combined the *Asinea* and Proteroglypha as Colubroidea, subdividing these into Peropoda, Aglyphodonta, Glyphodonta, Proteroglypha and Platycerca (Hydrophinae). In his last work he used, with doubtful success, the variations of the penes and the lungs as additional characters, chiefly for the grouping of the great mass of the Colubroid snakes. G. A. Boulenger (*Cat. Snakes*, Brit. Mus., 1893-1896) accepted Cope's principles, and mainly by combining the *Asinea* of Stannius and Cope with the Proteroglypha as Colubridae—wherein he was followed by Cope, as mentioned above—and separating therefrom the Peropoda or Boidae, he has produced a logically-conceived system, by far the best hitherto proposed. It is followed in the present article. Boulenger's phylogenetic system stands as follows:—

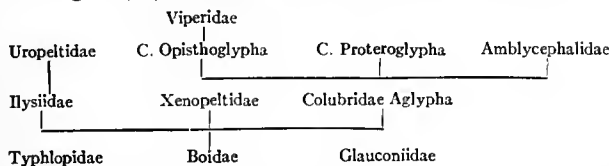

This means that the Boidae retain most primitive characters. Likewise primitive, but in various respects degraded, mainly owing to burrowing habits, are the Typhlopidae with the Ilysiidae, and Uropeltidae as a terminal branch, and on the other hand the Glauconiidae. The solitary Xenopeltis is in several ways intermediate between Boidae and Ilysiidae. The rest of the snakes are supposed to have started from some primitive, non-degenerate, therefore boa-like group, leading by loss of the vestiges of the hind-limbs and loss of the coronoid bone of the

mandible to the aglyphous or innocuous Colubridae, whence further differentiation in three new lines has taken place,—(1) the harmless Amblycephalidae as a side-issue, (2) the very poisonous proteroglyphous Elapidae, (3) the moderately or incipiently poisonous Opisthoglypha, out of some of which seem to have arisen the venomous Viperidae.

I. No ectopterygoid; pterygoid not extending to quadrate; no supratemporal or squamosal; prefrontal forming a suture with nasal; coronoid present; vestiges of pelvis present.

Maxillary vertical, loosely attached, toothed; mandible toothless; a single pair of pelvis bones: *Typhlopidae*.

Maxillary bordering the mouth, forming sutures with the premaxillary, prefrontal and frontal, toothless; lower jaw toothed; pubis and ischium present, the latter forming a symphysis: *Glauconiidae*.

11. Ectopterygoid present; upper and lower jaws toothed.

A. Coronoid present, prefrontal in contact with nasal.

1. Vestiges of hind-limbs; supratemporal present.

Squamosal large, suspending the quadrate: *Boidae*.

Squamosal small, intercalated in the cranial wall: *Ilysiidae*.

2. No vestiges of limbs; squamosal absent: *Uropeltidae*.

B. Coronoid absent; squamosal present.

1. Maxillary horizontal; pterygoid reaching quadrate or mandible.

Prefrontal in contact with nasal: *Xenopeltidae*.

Prefrontal not in contact with nasal: *Colubridae*.

2. Maxillary horizontal; pterygoid not reaching quadrate or mandible: *Amblycephalidae*.

3. Maxillary vertically erectile, perpendicularly to ectopterygoid, and reaching quadrate or mandible: *Viperidae*.

For ordinary practical purposes this synopsis is useless, most of the anatomical characters being visible only in the macerated skull. The following characterization of the families is based upon more accessible features.

Eyes vestigial or hidden; lower jaw toothless; without enlarged ventral scales: *Typhlopidae*.

Eyes vestigial; teeth restricted to the lower jaw; without enlarged ventral scales: *Glauconiidae*.

Eyes very small; head not distinct; teeth in the upper and lower jaws; ventral scales scarcely enlarged; tail extremely short, ending obtusely and covered with peculiar scales: *Uropeltidae*.

Eyes functional, free, with vestiges of the hind-limbs appearing as claw-like spurs on each side of the vent.

Ventral scales scarcely enlarged: *Ilysiidae*.

Ventral scales transversely enlarged: *Boidae*.

Eyes free; with a pair of poison-fangs in the front part of the mouth, carried by the otherwise toothless, much shortened, and vertically erectile maxillaries; ventral scales transversely enlarged: *Viperidae*.

All the remaining snakes combine the following characters: the maxillaries are typically horizontal, not separately movable, with a series of teeth. The mandible is toothed but has no coronoid bone. There are no vestiges of limbs or of their girdles. The eyes are free.

Dentary movably attached to the tip of the articular bone of the mandible. Skin beautifully iridescent: *Xenopeltidae*.

Without a mental groove; the ends of the pterygoids are free, not reaching the quadrate. Head thick and very distinct: *Amblycephalidae*.

With a median longitudinal groove between the shields of the skin: *Colubridae*.

Family I. TYPHLOPIDAE.—Burrowing snakes, mostly small, which have the body covered with smooth, shiny, uniform cycloid scales. The teeth are restricted to the small maxillary bones. The quadrates slant obliquely forward and are attached directly to the prootics, owing to the absence of squamosals. The prefrontals are in lateral contact with the nasals. The vestiges of the pelvis are reduced to a single bone on each side, and there are no traces of limbs. The eyes are hidden by shields of the skin. The mouth is very narrow, and the halves of the under-jaw are not distensible. About 100 species of these rather archaic snakes are known; in adaptation to their burrowing life and worm and insect diet, they have undergone degradation. The tail is mostly very short and sometimes ends in



FIG. 5.—*Typhlops bothriorhynchus*, from India, natural size.

a horny spine. They are widely distributed in all tropical and subtropical countries, even in such solitary places as Christmas Island, but they do not occur in New Zealand. The chief genus is *Typhlops*,

of which, for instance, *T. braminus* ranges from southern Asia, the islands of the Indian Ocean and the Malay Islands to southern Africa.

Family 2. GLAUCONIIDAE.—Burrowing like the Typhlopidae, which they much resemble externally, but the maxillaries retain their normal position and are toothless, teeth being restricted to the lower jaw, which is short, stout, and not distensible. The pelvic girdle and the hind-limbs show the least reduction found in any recent snakes, ilia, pubes and ischia being still distinguishable, the last even retaining their symphysis, and there are small vestiges of the femurs. About 30 species, mostly of the genus *Glauconia*, in south-western Asia, Africa, Madagascar, the Antilles and both Americas, *G. dulcis* ranging northwards into Texas, *G. humilis* into California.

Family 3. ILYSIIDAE.—Mostly burrowing. The scales of the long, cylindrical body are smooth and small, scarcely enlarged on the ventral side. The tail is extremely short and blunt. The head is very small and not distinct from the neck, a usual feature in burrowing snakes and lizards. The gape of the mouth is narrow. The quadrate bones are short and stand rather vertically. The squamosals form part of the cranial wall, being firmly wedged in between the quadrate, proötic and occipital bones. Vestiges of the pelvis and hind-limbs are small, but they terminate in claw-like spurs which protrude between the scales on either side of the vent, as in the Boidae. The small eyes are sometimes covered by transparent shields. About half-a-dozen species only are known in South America, Ceylon, the Malay Islands and Indo-China. They are viviparous like the Typhlopidae, upon which they feed besides worms and insects. *Ilysia s. Tortrix scydale*, one of the "coral-snakes" of tropical South America, is beautiful coral-red with black rings, grows to nearly a yard in length, and is said sometimes to be worn as a necklace by native ladies.

Family 4. UROPELTIDAE (RHINOPHIDAE).—Burrowing snakes of Ceylon and southern India, with a very short tail, which ends in a peculiar, often obliquely truncated, shield, hence the name. The eyes are very small. The scales of the body are smooth and are but little larger on the belly. The coloration is mostly beautiful, black and red. The Uropeltidae are in various respects intermediate between the two last and the next family. The quadrates are directly attached to the skull, the squamosals being absent. Teeth are carried in both jaws. There are no vestiges of hind-limbs or of the pelvis.

These tail-shielded snakes, of which about 40 species are known, are viviparous and burrow in the ground, preferring damp mountain-forests. *Uropeltis grandis*, the only species of the type-genus, is confined to Ceylon; about 18 in. in length, it is blackish above, yellow below, often with small spots on the upper and the under surface. *Rhinophis sanguineus* lives in southern India; it is black above with a bluish gloss, the belly is bright red with black spots, like the convex tail-shield.

Family 5. BOIDAE.—Typical, often very large, snakes, which have vestiges of pelvis and hind-limbs, the latter appearing as claw-like spurs on each side of the vent. The scales of the upper surface are usually small and smooth, while those of the belly form one broad series. The quadrate is carried by the horizontally-elongated squamosal, which rests loosely upon the skull. The prefrontals are in contact with the nasals. Sharp, recurved teeth are carried by the mandibles, the pterygoids, palatines, maxillaries, and in the Pythoninae by the premaxillaries also. The Boidae comprise some 60 species, which have been grouped into many fancy genera. The range of the family extends over all the tropical and subtropical countries, including islands, except New Zealand.

Sub-family 1. Pythoninae.—With a pair of supraorbital bones between the prefrontal, frontal and postfrontal bones. The premaxilla generally carries a few small teeth. The subcaudal scales are mostly in two rows. The pythons (*q.v.*) are restricted to the palaeotropical and Australian regions, with the sole exception of *Loxocemus bicolor* in southern Mexico.

Sub-family 2. Boinae.—Without supraorbital bones. The premaxilla is toothless. The subcaudal scales form mostly a single row. Widely distributed. *Boa (q.v.)* in tropical America and with two species in Madagascar. *Eunectes murinus*, the Anaconda (*q.v.*), *Charina*, e.g. *botatae*, a small sand-snake from Oregon to California. *Eryx jaculus*, also a sand-snake, from North Africa to Central Asia, and extending into Greece. *Enygrus*, ranging from New Guinea to the Fiji Islands. *Casarca dussumieri*, differing from *Boa* chiefly by the rough and strongly-keeled scales, is confined to Round Island near Mauritius. This makes the occurrence of a species of *Corallus* in Madagascar less remarkable, while all the others live in Central and South America.

Family 6. XENOPELTIDAE.—One species, *Xenopeltis unicolor*, in south-eastern Asia and Malay Islands. Boulenger rightly considers

this snake in various ways intermediate between the Ilysiidae, Boidae and Colubridae. The prefrontal bones are still in contact with the nasals as in the previous families, but the coronoid bones of the mandibles are absent as in the remaining families, and this loss also occurs in the Boine *Charina*. The most remarkable feature is the dentary bone, which is movably attached to the much-elongated articular bone (cf. *Polyodontophis* of Colubrinae), the movability being enhanced by the absence of the coronoid. The quadrate is short and thick, and is carried by the broad and short squamosal, which lies flat against the skull, reminding in this respect of *Ilysia*. The smooth, black and brown scales of the back are highly iridescent, hence the generic name of this peculiar snake, which reaches the length of one yard.

Family 7. COLUBRIDAE.—Maxillaries horizontal and forming the greater portion of the upper jaw, which is toothed like the lower jaw; coronoid of mandible absent. Pterygoids connected with the quadrates which are carried by the squamosals, and these are loosely attached to the skull. Prefrontals not in contact with the basals. Ectopterygoids present. No vestiges of limbs or pelvis. This family comprises about nine-tenths of all recent species of snakes and is cosmopolitan, New Zealand being the most notable exception. The 1300 to 1400 species contain terrestrial, arboreal and aquatic forms, many of which are highly specialized.

Boulenger, adopting Duméril's terms, has divided them into three parallel series:—

A. *Aglypha*.—All the teeth are solid, and not grooved. Harmless, non-poisonous.

B. *Opisthoglypha*.—One or more of the posterior maxillary teeth are grooved. Most of these snakes, which number about 300 species, are moderately poisonous.

C. *Proteroglypha*.—The anterior maxillary teeth are grooved or "perforated." About 200 very poisonous species, e.g. cobras, coral-snakes and sea-snakes.

The second and third series containing only about 400 species, the *Aglypha* still present the appalling number of 1000 species, and even the grouping of this mass into three sub-families does not lighten the task of arranging the chaos, since one of these sub-families contains only one, and the other but a very few species. We have therefore still 1000 species, all so closely allied that they together are but of sub-family rank. They possess few reliable characters; their modifications are not weighty, and it is almost certain that some of these characters, and even combinations thereof, have been developed independently and in different countries. Many of the so-called genera, or groups of genera, are consequently not to be used either as witnesses of blood-relationship or of geographical distribution.

Some of the usual characters employed for systematic purposes, for the making of convenient keys, are the following: The number of rows of scales across the body and in a longitudinal direction; shape and structure of scales, whether smooth or with a longitudinal keel; arrangement of the shields on the head; shape of the contracted pupil. Above all, the dentition, which exhibits almost endless modifications, in most cases is difficult to ascertain and to appreciate in its subtle distinctions. Internal, skeletal characters, useless for ordinary practical purposes, are the various apophyses on the ventral side of the vertebrae and the penial armaments fancied by Cope.

It is impossible here to mention any but the more obvious genera and groups of colubrine snakes.

Series A. AGLYPHIA.—Sub-family 1. *Acrochordinae*.—The few genera and species of these ugly-looking snakes are mostly aquatic, inhabiting rivers and estuaries of S.E. Asia; but one, *Nothopis*, lives on the Isthmus of Darien, and another, *Stoliczkaia*, is found in the Khasia Hills of N.E. India. *Acrochordus javanicus* has no enlarged ventral shields; the flat, viperish-looking head is covered with small granules, with the eyes and nostrils well on the upper surface. *Chersydrus* ranges from Madras to New Guinea; the body and tail are laterally compressed and form a ventral fold which is covered with tiny scales like the rest of the body. The main anatomical justification of this sub-family is given by the postfrontal bones, which, besides bordering the orbits posteriorly, are extended forwards so as to form the upper border of the orbits, separating the latter from the frontals.

Sub-family 2. *Colubrinae*.—The postfrontal bones are restricted to the posterior border of the orbits. The maxillary and dentary bones carry teeth on their whole length. This sub-family contains about 1000 species; few of them reach a length of more than two yards, some of the largest belonging to the Indian *Zaocys s. Coryphodon*, which grow to 10 ft. Most of them are oviparous. Some are more or less aquatic, others are absolutely arboreal, others again prefer dry, sandy or rocky localities according to their food. The sub-family is cosmopolitan, excepting the New Zealand sub-region, and finds its natural N. limit on the permanently frozen underground, where hibernation is of course impossible. Only a few out of the more than 120 genera can be mentioned here.

Coluber in Europe, Asia and North America. *C. longissimus s. flavescens s. aesculapii* was probably the species held in veneration by the ancient Romans. It grows to a length of 5 ft., climbs extremely well, feeds chiefly on mice, and becomes very tame. Its coloration varies from pale golden brown to black; the scales are

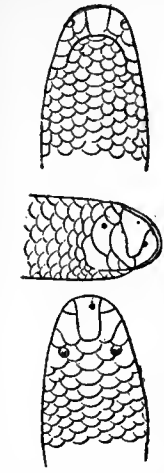

FIG. 6.—Three Views of Head of *Typhlops braminus* (India), magnified.

smooth and shiny. Its original home is Italy and S.E. Europe, whence it has spread N. into S. Germany. Its occurrence at widely distant and isolated localities was formerly supposed to be due to its introduction by the Romans. *C. corais*, from the S. states of N. America far into S. America, reaches 8 ft. in length. *C. (Pityophis) sayi*, *C. catenifer* and others in N. America.

Coronella, widely distributed excepting Australia and S. America. *C. austriaca* s. *laevis*, the "smooth snake" of Europe, in England, in Hampshire and Dorsetshire, eats chiefly lizards; owing to its coloration, which varies much, it is often mistaken for the viper. *C. getula* is one of the many N. American species. *Zamenis* of Europe, Asia, N. Africa, N. and Central America, with many species, e.g. *Z. mucosus* the Indian "rat-snake," *Z. constrictor* in the United States. Some species of the Central and S. American genus *Urotheca* bear an extraordinary resemblance in coloration to the pretty, black, red and yellow poisonous *Elaps*. *Dendrophis* of India and Australia (e.g. *D. pictus* of India), and *Leptophis* s. *Ahaetulla* (e.g. *L. liocerus*, neotropical) may be taken as examples of long and slender tree-snakes.

Tropidonotus, with near 100 species, is cosmopolitan with the exception of New Zealand. Some of the species, like the Indian *T. quincunciatus* and *T. stolatus* and the N. American *T. ordinatus*, are perhaps more abundant as regards the number of individuals than any other snake. *T. natrix*, the grass or ringed snake, is very common in Europe, including England but not Scotland or Ireland; easily recognized even at a distance by two yellow or white spots which it has behind its head. It grows rarely to a length of 4 ft.; it never bites, and feeds chiefly on frogs, toads and fishes, but mice are never taken. Its eggs, which are of the size and shape of a dove's egg, are from fifteen to thirty in number, are deposited in mould or under damp leaves, and are glued together into one mass.

Polyodontophis of Madagascar, S.E. Asia and Central America is remarkable for having the dentary bones loosely attached to the apex of the elongated articular bone. *Calamaria* of Indo-China is an example of burrowing snakes, with a short tail and small eyes; in *Typhlopophis* of the Philippines the eyes are concealed.

Sub-family 3. *Rhachiodontidae*, represented by *Dasyptellus scabra* of tropical and S. Africa. Characterized by possessing only a few teeth, on the posterior part of the maxillaries, on the palatines and

Coronelline *Nymphophidium*, the same effect is reached by two prominences at the base of the skull.

Series B. *OPISTHOGLYPHA*.—One, or a few, of the posterior maxillary teeth have a groove or furrow in front, which conducts the secretion of the enlarged upper labial glands. They are all more or less poisonous, paralyzing their prey before, or during the act of swallowing; the poison-fangs standing so far back in the mouth, these snakes cannot easily inflict wounds with them on man; moreover, the poison is not very strong and not available in large quantities. It may well be doubted whether *Opisthoglypha* form one genuine group instead of a heterogeneous assembly. They comprise about 300 species of terrestrial, arboreal and aquatic forms, and as a group they are almost cosmopolitan, including Madagascar, but excepting New Zealand.

Sub-family 1. *Dipsadomorphinae*.—Nostrils lateral; dentition well developed. Long-tailed, terrestrial and arboreal forms. The tree-snakes are mostly green above with the under parts white or yellow.

Coelopeltis, with concave, or grooved scales; *C. lacertina* s. *monspessulanus*, one of the largest European snakes in Mediterranean countries and south-western Asia.

Dipsadomorphus, *Dipsas*, *Leptognathus*, *Dryophis*, *Dendrophis* and other closely allied genera are typical, very long-bodied and long-tailed tree-snakes, chiefly tropical. The graceful form of their body, the elegance and rapidity of their movements, and the exquisite beauty of their colours have been the admiration of all who have had the good fortune to watch them in their native haunts. The majority lead an exclusively arboreal life; only a few descend to the ground in search of their food. They prey upon every kind of arboreal animal—birds, tree-frogs, tree-lizards, &c. All seem to be diurnal, and the larger kinds attain to a length of about 4 ft. The most beautiful of all snakes are perhaps certain varieties of *Chrysosopelea ornata*, a species extremely common in the Indian Archipelago and many parts of the continent of tropical Asia. One of these varieties is black, with a yellow spot in the centre of each scale; these spots are larger on the back, forming a series of tetrapetalous flowers; the head is similarly ornamented. Another variety has a red back, with pairs of black crossbars, the bands of each pair being separated by a narrow yellow space; sides brown, dotted with black;

belly dark green, the outer portion of each ventral shield being yellow, with a blackish spot.

The features by which the tree-snakes are distinguished are still more developed in the whip-snakes (*Dryophis*), whose excessively slender body has been compared to the cord of a whip. Although arboreal, like the former, they are nocturnal in their habits, having a horizontal instead of a round pupil of the eye. They are said to be of a fierce disposition, feeding chiefly on birds. In some of the species the elongate form of the head is still more exaggerated by a pointed flexible appendage of the snout (*Passerita*), which may be nearly half an inch in length, or leaf-like, as in the Madagascar *Langaha*. The Mexican *Trimorphodon* much resemble viperine snakes with the flat, triangular head, narrow neck, slit-like pupil and pugnacious disposition. A still more remarkable resemblance exists in the shape and striking, red, black and yellow coloration between *Scolecophis aemulus* of Chihuahua and the poisonous *Elaps fulvius*, the American coral-snake, but Cope has been careful to point out that these two creatures are not known to inhabit the same district.

Sub-family 2. *Elachistodontidae*.—Represented by *Elachistodon westermanni* of Bengal, with the same peculiar dentition and with sharp hypapophyses on the vertebrae of the lower neck, as described of *Dasyptellus* (see above).

Sub-family 3. *Homalopsinae*.—The nostrils of these absolutely aquatic, viviparous snakes are valvular and placed on the upper surface of the snout. The eyes are small, with vertical pupils. About two dozen ugly-looking species inhabit rivers and estuaries from Bengal to Australia. *Cerberus rhynchops*; *Hypsirhina plumbea*, *Homalopsis*; *Hipistes hydrinus* of Siam has a compressed body, and much resembles the Hydrophinae in general appearance and its partly marine life. *Herpeton* of Cambodia has a pair of long tentacles on the snout and is said to have a partly vegetable diet!

Series C. *PROTEROGLYPHA*.—The anterior maxillary teeth are deeply grooved, or so folded as to appear hollow or perforated. Behind these enlarged poison-fangs follows a series of smaller, solid

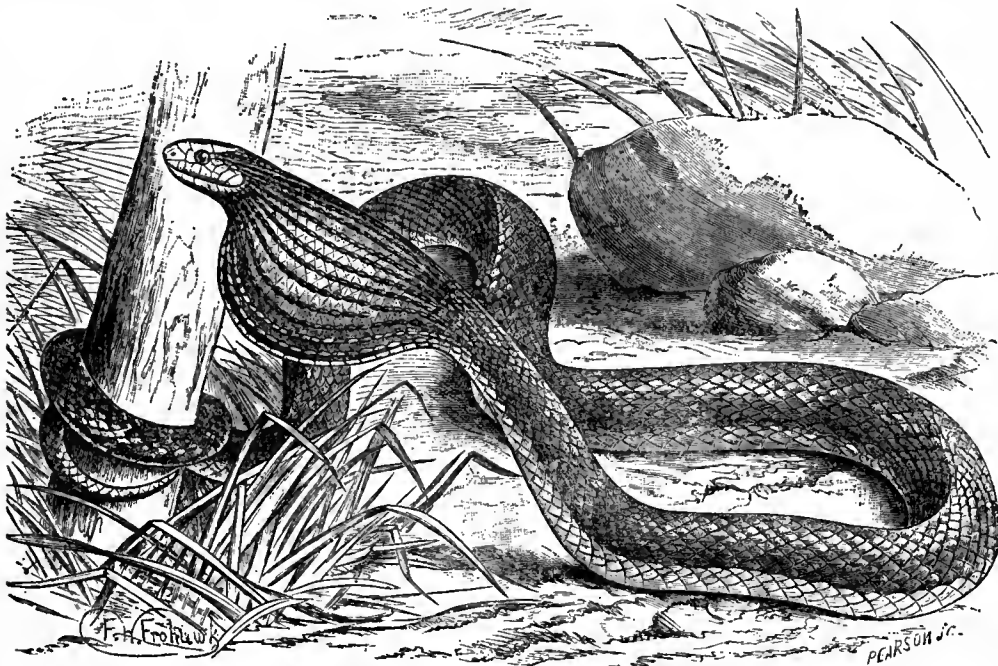

FIG. 7.—*Dasyptellus unicolor*, in the act of swallowing an egg. Nat. size.

dentaries; some of the vertebrae in the lower region of the neck have strongly developed hypapophyses (not provided with a cap of enamel, as has often been asserted), which are directed forwards and pierce the oesophagus. The principal diet of these peculiar snakes seems to consist of eggs. In Cape Colony they are known as "eyerveater," i.e. egg-eater. A snake, scarcely 20 in. in length, and with a body not thicker than a man's little finger, is able to swallow a hen's egg, a feat which seems quite impossible. As the egg passes at last through the alarmingly distended neck, the snake makes some slight contortions and the swelling collapses, the shell having been filed through by the saw-like apparatus. Whilst the contents are thus retained without loss, the crumpled shell is then vomited out. This peculiar arrangement occurs also in an Indian snake, *Elachiston*, which represents, however, a sub-family of the *Opisthoglypha*. In another, probably also egg-eating snake, the Indian

teeth, hence the term "proteroglypha," which is intended to mean that the anterior teeth are grooved. These snakes are all very poisonous, mostly viviparous and found in all tropical and sub-tropical countries, with the exception of Madagascar and New Zealand.

Sub-family 1. *Elapinae*.—Terrestrial, with a cylindrical tail, comprising about 150 species which have been grouped into numerous genera, mostly upon very slight differences. The most remarkable are the following. *Naja tripudians* and *N. haje*, the cobra (*q.v.*). The largest species is the *N. bungarus s. elaps*, the "hamadryad," "snake-eating cobra," or king-cobra of Indian countries, reaching more than 12 ft. in length, and living mainly upon other snakes. *Sepeidon haemachates*, of S. Africa, is named by the Boers "roode

E. as well as W. coast. It is of smaller size than the preceding, and causes more injury to animals, such as sheep, dogs, &c. than to man. It varies in colour, but a black mark on the head like an inverted V remains nearly always visible.

The species of *Bungarus*, four in number, are extremely common in India, Burma, and Ceylon, and are distinguished by having only one row of undivided sub-caudal shields. Three of the species have the body ornamented with black rings, but the fourth and most common (*B. coeruleus*), the "krait" of Bengal, possesses a dull and more uniform coloration. The fangs of the bungarums are shorter than those of the cobras, and cannot penetrate so deeply into the wound. Their bite is therefore less dangerous and the effect on the general system slower, so that there is more prospect of recovery by treatment. Nevertheless, the krait is probably the most destructive snake to human life in India, since it is very common and often creeps into the houses.

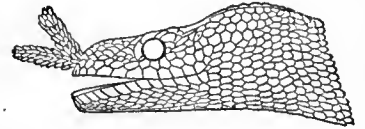

FIG. 9.—Head of *Herpeton lentaculatum*.

Doliophis intestinalis of Indo-China has enormously developed poison glands, which extend down the whole anterior third of the body, in front of the heart.

No part of the world possesses so many snakes of this sub-family as Australia, where, in fact, they replace the non-venomous colubrine snakes; many of them are extremely common and spread over a considerable area. Fortunately the majority are of small size, and their bites are not followed by more severe effects than those from the sting of a hornet. Only the following are dangerous to man and larger animals: the "death-adder," *Acanthopis antarcticus*, easily recognized by the peculiar end of the tail which is compressed and terminates in a thin horny spine; common throughout Australia to the Moluccas, scarcely one yard in length; the "black snake" (*Pseudechis porphyriacus*), likewise common throughout the Australian continent, especially in low marshy places, and upwards of 6 ft. in length; it is black, with each scale of the outer series red at the base; when irritated it raises the fore part of its body and flattens out its neck like a cobra, the females are sometimes known as "brown adders"; the "tiger snake," *Notechis scutatus* (*s. Hoplocephalus curtus*), with a similar distribution, and also common in Tasmania, from 5 to 6 ft. long, and considered the most dangerous of the tribe. Good descriptions and figures of all these snakes are given in Krefft's *Snakes of Australia* (Sydney, 1869, 4to).

Several genera of the *Elapinae* lead a more or less burrowing life; their body is of a uniform cylindrical shape, terminating in a short tail, and covered with short polished scales; their head is short, the mouth rather narrow, and the eye small. They are the tropical American *Elaps*, the Indian *Callophis*, the African *Poecilophis* and the Australian *Vermicella*. The majority are distinguished by the beautiful arrangement of their bright and highly ornamental colours; many species of *Elaps* have the pattern of the so-called coral-snakes, their body being encircled by black, red and yellow rings—a pattern

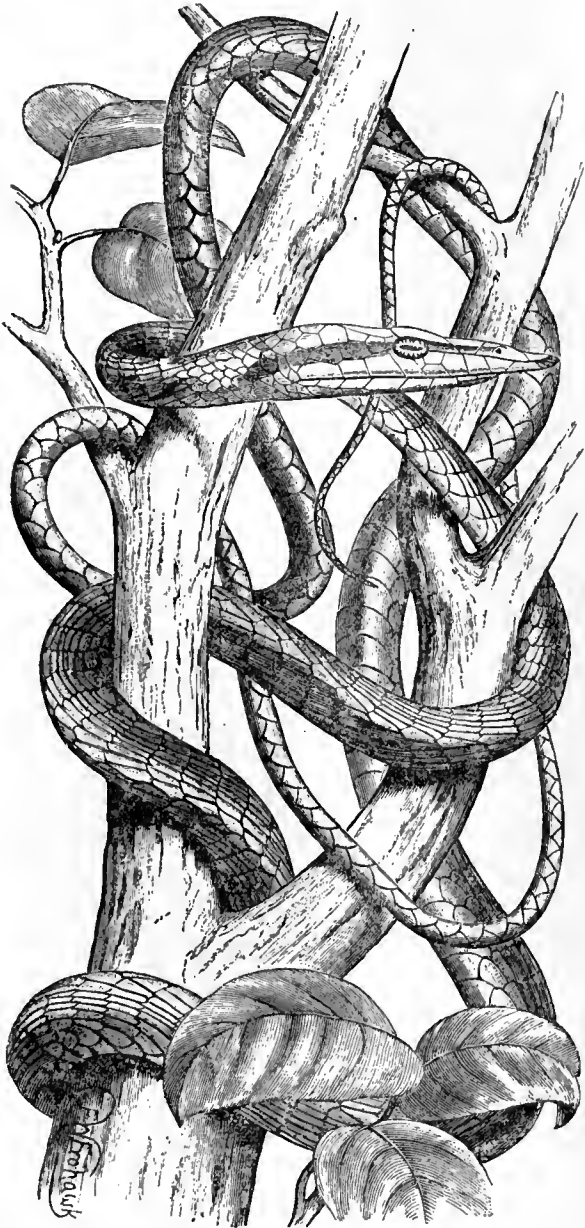

FIG. 8.—Indian Whip-Snake. *Passerita mycterizans*.

koper kapel" or "ring-hals," *i.e.* banded neck, the latter name being, however, often applied also to the cobra. It resembles in colour some varieties of the latter snake, and, like this, it has the power, though in a less degree, of expanding its hood. But its scales are keeled and its form is more robust. It is equally active and courageous, not rarely attacking persons who approach too near to its resting-place. In confinement it evinces great ferocity, opening its mouth and erecting its fangs, from which the poison is seen to flow in drops. During such periods of excitement it is even able, by the pressure of the muscles on the poison-duct, to eject the fluid to some distance; hence it shares with the cobra a third Dutch name, that of "spuw slang" (spitting snake). It grows to a length of 2 or 3 ft. Another kind is the "schapsticker" (sheep stinger), *S. rhombeatus*. It is extremely common in S. Africa, and extends far N. along the

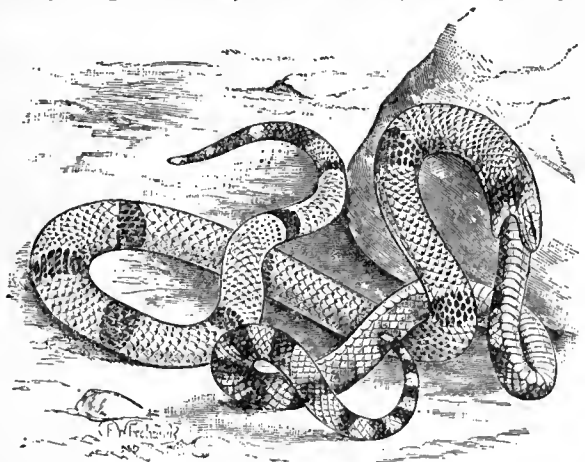

FIG. 10.—A Poisonous Snake (*Elaps fulvius*) swallowing a similarly coloured Opisthoglyphous Snake (*Homalocranium semicinctum*).

which is peculiar to snakes, venomous as well as non-venomous, of the fauna of tropical America. Although the poison of these narrow-mouthed snakes is probably as virulent as that of the preceding; man has much less to fear from them, as they bite only under great provocation. Moreover, their bite must be frequently without serious effect, owing to their narrow mouth and the small size of their poison-fangs. They are also comparatively of small size, only a few species rarely exceeding a length of 3 ft., for instance *Elaps fulvius*, which extends into the S. states of N. America.

Sub-family 2. *Hydrophinae*.—Tail laterally compressed; marine.

Of sea-snakes some fifty species are known. All are inhabitants of the tropical Indo-Pacific ocean, and most numerous in and about the Persian Gulf, in the East Indian Archipelago, and in the seas between S. Japan and N. Australia. One species which is extremely common (*Pelamis bicolor*), and which is easily recognized by the black colour of its upper and the yellowish tints of its lower parts (both colours being sharply defined), has extended its range W. to the sea round Madagascar, and E. to the Gulf of Panama. One species, however, *Distira semperi*, is confined to the landlocked freshwater Lake Taal at Luzon in the Philippines. Sea-snakes are viviparous and pass their whole life in the water; they soon die when brought on shore. The scales are very small, often very much reduced, and there are frequently no enlarged ventrals on the compressed belly, but *Platurus* has broad ventrals. Their motions in the water are almost as rapid as they are uncertain and awkward when the animals are removed out of their proper element. Their nostrils are placed quite at the top of the snout. These openings are small and provided with a valve interiorly, which is opened during respiration, and closed when the animal dives. They have very capacious lungs, extending backwards to the anus; by retaining air in these extensive lungs they are



FIG. 11.—Sea-Snake, *Pelamis bicolor*.

able to float on the surface of the water and to remain under water for a considerable length of time. Sea-snakes shed their skin frequently; but it peels off in pieces as in lizards, and not as in the freshwater snakes, in which the integuments come off entire. Several species are remarkable for the extremely slender and prolonged anterior part of the body, and very small head. The eye is small, with round pupil, which is so much contracted by the light when the snake is taken out of the water that the animal becomes blinded and is unable to hit any object it attempts to strike. The tongue is short, and the sheath in which it lies concealed opens near to the front margin of the lower jaw; scarcely more than the two terminating points are exerted from the mouth when the animal is in the water. The mouth shuts in a somewhat different way from that of other snakes: the middle of the rostral shield is produced downwards into a small lobule, which prevents the water from entering the mouth; there is generally a small notch on each side of the lobule for the passage of the two points of the tongue. The food of sea-snakes consists entirely of small fish; among them species with very strong spines. As all these animals are killed by the poison of the snake before they are swallowed, and as their muscles are perfectly relaxed, their armature is harmless to the snake, which begins to swallow its prey from the head, and depresses the spines as deglutition proceeds. Sea-snakes belong to the most poisonous species of the whole order. Accidents are rarely caused by them, because they are extremely shy and swim away on the

least alarm; but, when surprised in the submarine cavities forming their natural retreats, they will, like any other poisonous terrestrial snake, dart at the disturbing object; and, when out of the water, they attempt to bite every object near them, even turning round to wound their own bodies. They cannot endure captivity, dying in the course of two or three days, even when kept in capacious tanks. The greatest size to which some species attain, according to positive observation, is about 12 ft., and therefore far short of the statements as to the length of the so-called sea-serpents (*q.v.*). Boulenger has written an interesting account of sea-snakes in *Natural Science*, i. (1892), p. 44 seq.

Family 8. *Amblycephalidae*.—The pterygoids are widely separated from the quadrates, not reaching beyond the level of the occipital condyle. This condition can be ascertained without dissection, when the mouth is opened widely. The squamosals are reduced to pad-like vestiges. Otherwise these snakes agree with the aglyphous Colubridae. Externally they are easily distinguished by the absence of a longitudinal groove on the skin. The head is thick, very distinct from the neck and the pupil is vertical, so that these harmless snakes look rather viperish. About 30 species, with several genera, are known from the oriental and neotropical regions. *Amblycephalus*, e.g. *monticola*, with compound body, in S.E. Asia.

Family 9. *Viperidae*.—The maxillaries are very short, movably pivoting upon the prefrontals and also attached to the ectopterygoids, so that they can be erected together with the large poison fangs, which, besides reserve teeth, are the only maxillary teeth. There are also teeth on the palatines, anterior portion of the pterygoids, and on the short dentaries. The short squamosals are very loosely attached to the skull. The prefrontals are not in contact with the

nasals. The poison-fangs are "solenoglyphous," perforated, having a wide hole on the anterior side at the base, in connexion with the duct of the large, paired, poison-glands, the presence of which adds considerably to the characteristic broadness of the head. The hole leads into a canal, which opens as a semi-canal towards the end of the tooth. The supply of reserve teeth is indefinite; frequently one or two are lying ready and of equal size to the functional fangs.

All the Viperidae are very poisonous and all, except the African *Atractaspis*, are viviparous. They include terrestrial, semi-aquatic and burrowing types; none of them with any signs of degradation; on the contrary they belong to the most highly organized of snakes. The family is cosmopolitan, excepting Madagascar and the whole of the Australian region.

Sub-family 1. *Viperinae*, vipers (*q.v.*) or adders.—Without an external pit between eye and nose, and the maxillary bone is not hollowed out above. Absolutely restricted to the Old World, with 9 genera comprising about 40 species.

Sub-family 2. *Crotalinae*.—With a deep cavity or pit on either side between the eye and the nose, lodged in the hollowed-out maxillary bone. The lining of these pits is amply supplied with branches from the trigeminal nerves, but the function is still quite unknown. About 60 species of pit-vipers are recognizable. They can easily be divided into 4 genera: *Crotalus* and *Sistrurus* with a rattle at the end of the tail and restricted to America (see RATTLESNAKE); secondly, pit-vipers without a rattle: *Ancistrodon*, with large shields covering the upper surface of the head; with about 10 species, e.g. *A. halys* in the Caspian district, others in the Himalayas, Ceylon and Sunda islands. Notable American species are the following: *A. piscivorus*, the "water-viper" from Carolina and Indiana to Florida and Texas. This creature is semi-aquatic and lives chiefly on fishes; it grows to a length of about 5 ft.; the general colour is reddish to dark brown,

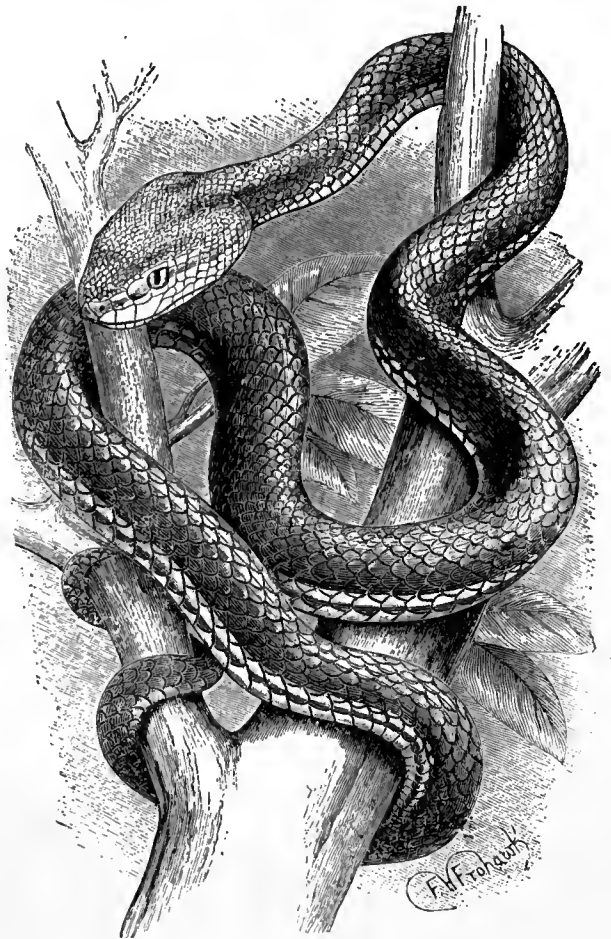

FIG. 12.—*Lachesis viridis* of India.

even blackish, with darker cross-bands or C-shaped markings; a dark, light-edged band extends from the eye to the angle of the mouth. The under parts are yellowish, more or less spotted or quite black. *A. contortrix* the "moccasin-snake" or "copper-head," so called because of its yellow to pink or pale-brown ground colour, with dark crossbars or triangular marks. The under surface is yellow to reddish, with dark specks. Full-grown specimens are about 1 yd. in length. The moccasin-snake ranges from Massachusetts and Kansas to Florida and Texas and into Mexico, preferring swampy localities or meadows with high grass, where it hunts for small mammals and birds. It is easily distinguished from other North

American pit-vipers by the possession of a loreal shield, *i.e.* a shield intercalated between the two preoculars and the posterior nasal; below the loreal lies the pit.

The moccasin and the water-viper have occasionally been mentioned under the name of *Trigonocephalus cenchris*, one of the many synonyms.

Lachesis has the upper surface of the head covered with very small shields, or with scales, and contains about 40 species, in S. and Central America, the Antilles and also in S.E. Asia. The most ill-famed is *L. s. Bothrops s. Craspedocephalus lanceolatus*, which inhabits the greater part of S. America, extending into Mexico and the Lower Antilles, notably Martinique, Guadeloupe and Santa Lucia, where it is known as the "Fer de Lance"; Mexicans call it "rabo de hueso" or bone-tail, on account of the curiously coloured and spike-like tip of the tail. It is a very quick and highly irascible beast and even known to turn on its pursuer. It grows to a length of 6 ft., lives in swamps, plantations, forests, on the plains and on the hills, and is very prolific, producing dozens of young, which at birth are 10 in. long and as vicious as their parents.

L. s. Trimeresurus gramineus s. viridis s. erythurus is one of the Asiatic species, ranging over the whole of India to Hong-kong, Timor and even to the Andaman and Nicobar Islands. It is arboreal, bright green above; the end of the prehensile tail is usually bright red. (H. F. G.)

SNAPDRAGON, or **ANTIRRHINUM** (Gr. *ἄνθος*, *ῥῖνος*, snout, from the shape of the flower), a plant of the natural order Scrophulariaceae (*g.v.*), native to central and south Europe, occurring as an alien on old walls in Britain. It is an old-fashioned garden perennial of easy cultivation. *Antirrhinum majus*, sown in heat, and forwarded until the general time for planting out, becomes a summer annual, and may be so treated; but under a slower and more hardy regime it may be sown in boxes in August, and pricked off into other boxes and wintered in a frame. So treated, and planted out in well-prepared beds of good friable garden soil, it will become very showy and effective. The "Tom Thumb" or dwarf strain, obtainable in self and mixed colours, is a very valuable plant for bedding. The named sorts are propagated by cuttings, and wintered in a frame. Some of the double-flowered sorts are interesting. There are forms with white, yellow, rose, crimson, magenta, and variously mottled and striped flowers, some of them of great beauty, but the named sorts are too fugitive to make it desirable to record a list.

SNEEK, a town in the province of Friesland, Holland, to the west of Sneek lake, 14 m. by rail S.S.W. of Leeuwarden, with which it is also connected by canal. Steam tramways connect it S.E. with Heerenveen and N.W. with Bolsward and Harlingen. Pop. (1900) 12,075. Sneek is one of the great butter and cheese markets of the province. One of the former city gates (1615) remains, and there are a town hall, communal buildings (1863), court-house, weigh-house, synagogue and churches of various denominations, in one of which is the tomb of the naval hero of the 16th century, Lange, or Groote Pier (Long or Great Peter). The horse-fair of Sneek is widely attended, and there is a considerable activity in trade and shipping.

SNEEZING (O. Eng. *fnēosung*, from *fnēosan*, to sneeze, cf. Dutch *fniezen*, allied to the obsolete *neeze*, and ultimately to be referred to root seen in Gr. *πνέειν*, to breathe; the initial *s* is due to association with numerous words, such as snort, snuff, snore, &c.), a violent expiration of air from the nose and mouth; it is an involuntary reflex respiratory act; caused by irritation of the nerve-endings of the mucous membrane of the nose or by stimulation of the optic nerve by a bright light. The irritation may be due to the swelling of the nasal mucous membrane, which occurs in catching cold, sneezing being often a premonitory or accompanying symptom, or to foreign bodies in the nose, as by inhalation of snuff or other "errhines" or "sternutatories." A venerable and widespread belief survives in the custom of saying "God bless you" when a person sneezes. The Hindus say "live," to which the answer "with you" is given (E. B. Tylor, *Primitive Culture*, i. 101). A sneeze was considered a sign or omen from the gods by the Greeks and Romans; it was one of the many common everyday occurrences which if coming at an important moment could be interpreted as presaging the future. There are many allusions to it in classical literature, *e.g.* Homer, *Od.* xvii. 561, Plutarch, *Themist.* 13, Xenophon, *Anab.* iii. 2 and Catullus, *Carm.* 45. There are references to it

in Rabbinical literature, and it has been found in Otaheite, Florida and the Tonga Islands.

SNELL, HANNAH (1723-1792), the "female soldier," was born at Worcester on the 23rd of April 1723, being the daughter of a hosier. In order to seek her husband, who had ill-treated and abandoned her, in 1745 she donned man's attire and enlisted as a soldier in Guise's regiment of foot, but soon deserted, and shipped on board the sloop "Swallow" under her brother-in-law's name of James Gray. The "Swallow" sailed in Boscawen's fleet to the East Indies, and took part in the siege of Araapong. Hannah served in the assault on Pondicherry and was wounded, but she succeeded in extracting the bullet without calling in a surgeon. When recovered she served before the mast on the "Tartar" and the "Eltham," but when paid off she resumed woman's costume. Her adventures were published as *The Female Soldier, or the Surprising Adventures of Hannah Snell* (1750), and she afterwards gave exhibitions in military uniform in London. She died insane in Bethlehem Hospital on the 8th of February 1792.

SNELL, JOHN (1629-1679), founder of the Snell exhibitions at Oxford, was born in 1629 in Ayrshire, Scotland, the son of a blacksmith. He joined the royalists during the civil war, and fought in several battles, including Worcester. Thereafter he took refuge in Cheshire, where he met Sir Orlando Bridgeman, whose clerk he became, being raised to the offices of court-crier and seal-bearer as his patron was promoted to those of judge and Lord Keeper. Later he was secretary to the Duke of Monmouth and had the management of his Scottish estates. He died at Oxford on the 6th of August 1679, leaving a bequest for sending students from Glasgow University to an Oxford college or hall. The Court of Chancery decided in 1693 that Balliol should receive the beneficiaries.

SNELL, WILLEBRORD (1591-1626), commonly known as **SNELLIUS**, Dutch astronomer and mathematician, was born at Leiden in 1591. In 1613 he succeeded his father Rudolph Snell (1546-1613) as professor of mathematics in the university of Leiden. In 1615 he planned and carried into practice a new method of finding the dimensions of the earth, by determining the distance of one point on its surface from the parallel of another, by means of a triangulation. His work *Eratosthenes Batavus*, published in 1617, describes the method and gives as the result of his operations between Alkmaar and Bergen-op-Zoom a degree of the meridian equal to 55,100 toises = 117,449 yds. (A later recalculation gave 57,033 toises = 121,569 yds., after the application of some corrections to the measures indicated by himself.) Snell also distinguished himself as a mathematician, and discovered the law of refraction, in 1621 (see **LIGHT**). He died at Leiden on the 30th of October 1626.

In addition to the *Eratosthenes Batavus* he published *Cyclometria sine de circuli dimensione* (1621), and *Tiphys Batavus s. Histiodromice, de navium cursibus et re navali* (1624). He also edited *Coeli et siderum in eo errantium observationes Hassiacae* (1618), containing the astronomical observations of Landgrave William IV. of Hesse. A trigonometry (*Doctrina triangulorum*), by him was published a year after his death.

SNIPE (O. Eng. *Snite*, Icel. *Snípa*, Dutch *Snip*, Ger. *Schnepfe*), one of the commonest Limicoline birds, in high repute no less for the table than for the sport it affords. It is the *Scolopax gallinago* of Linnaeus, but by later writers it has been separated from that genus, the type of which is the Woodcock (*g.v.*), and has been named *Gallinago caelestis*. Though considerable numbers are still bred in the British Islands, notwithstanding the diminished area suitable for them, most of those that fall to the gun are undoubtedly of foreign origin, arriving from Scandinavia towards the close of summer or later, and many will outstay the winter if the weather be not too severe, while the home-bred birds emigrate in autumn to return the following spring. Of later years British markets have been chiefly supplied from abroad, mostly from Holland.

The variegated plumage of the Snipe is subject to no considerable variation, especially in the extent of dark markings on the belly, flanks, and axillaries, while examples are occasionally seen in which no trace of white, and hardly any of buff or grey,

is visible, the place of these tints being taken by several shades of chocolate-brown. Such examples were long considered to form a distinct species, the *S. sabinii*, but its invalidity is now admitted. Other examples in which buff or rust-colour predominates have also been deemed distinct, and to those has been applied the epithet *russata*. Again, a slight deviation from the ordinary formation of the tail, whose rectrices normally number 14, and present a rounded termination, has led to the belief in a species, *S. brehmi*, now wholly discredited. But, setting aside two European species, there are at least a score, belonging to various parts of the world. Thus N. America produces *G. wilsoni*, so like the English Snipe as not to be easily distinguished except by the possession of 16 rectrices, and Australia has *G. australis*, a larger and somewhat differently coloured bird with 18 rectrices. India, while affording a winter resort to the common species, which besides Europe extends its breeding range over the whole of N. Asia, has also at this season the Pin-tailed Snipe, *E. stenura*, in which the number of rectrices is still greater, varying from 20 to 28, it is said, though 22 seems to be the usual number. This curious variability, deserving more attention than it has yet received, only occurs in the outer feathers of the series, which are narrow in form and extremely stiff, there being always 10 in the middle of ordinary breadth.

Those who only know the Snipe as it shows itself in the shooting-season, when without warning it rises from the boggy ground uttering a sharp note that sounds like *scap, scap*, and, after a few rapid twists, darts away, if it be not brought down by the gun, to disappear in the distance after a desultory flight, have no conception of the bird's behaviour at breeding-time. Then, though flushed quite as suddenly, it will fly round the intruder, at times almost hovering over his head. But, if he have patience, he will see it mount aloft and there execute a series of aerial evolutions of an astounding kind. After wildly circling about, and reaching a height at which it appears a mere speck, where it winnows a random zigzag course, it abruptly shoots downwards and aslant, and then as abruptly stops to regain its former elevation, and this process it repeats many times. A few seconds after each of these headlong descents a mysterious sound strikes his ear—compared by some to drumming, and by others to the bleating of a sheep or goat,¹ which sound evidently comes from the bird as it shoots downwards, and then only. It is now generally accepted that these sounds are produced by the vibration of the webs of the outer tail-feathers, the webs of which are modified. A similar sound may be made by affixing those feathers to the end of a rod and drawing them rapidly downwards in the same position as they occupy in the bird's tail while it is performing the feat.² The air will also ring with loud notes that have been syllabled *tinker, tinker, tinker*, while other notes in a different key, something like *djepp, djepp, djepp* rapidly uttered, may be heard as if in response. The nest is always on the ground, and is a rather deep hollow wrought in a tuft of herbage and lined with dry grass-leaves. The eggs are four in number, of a dark olive colour, blotched and spotted with rich brown. The young when freshly hatched are beautifully clothed in down of a dark maroon, variegated with black, white and buff.

The Double or Solitary Snipe of English sportsmen, *S. major*, a larger species, also inhabits N. Europe, and may be readily recognized by the white bars in its wings and by its 16 or occasionally 18 rectrices. It has also a very different behaviour. When flushed it rises without alarm-cry, and flies heavily. In the breeding season much of its love-performance is exhibited on the ground, and the sounds to which it gives rise are of another character; but the exact way in which its "drumming" is effected has not been ascertained. Its gesticulations at this time have been well described by Professor Collett in a communication

¹ Hence in many languages the Snipe is known by names signifying "Flying Goat," "Heaven's Ram," as in Scotland by "Heather-bleater."

² Cf. Meves, *Oefvers. K. Vet.-Akad. Förh.* (1856), pp. 275-277 (transl. *Naumannia*, 1858, pp. 116, 117), and *Proc. Zool. Society* (1858), p. 202, with Wolley's remarks thereon, *Zool. Garten* (1876), pp. 204-208; P. H. Bahr (*Proc. Zool. Soc. of London*, 1907, p. 12) has given a full account of the subject, with diagrams of the modified feathers.

to H. E. Dresser's *Birds of Europe* (vii. 635-637). It visits Great Britain every year at the close of summer, but in very small numbers, and is almost always seen singly—not uncommonly in places where no one could expect to find a Snipe.

The third species of which any details can here be given is the Jack-³ or Half-Snipe, *S. gallinula*, the smallest and most beautifully coloured of the group. Without being as numerous as the common or full Snipe, it is of frequent occurrence in Great Britain from September to April (and occasionally both earlier and later); but it breeds only, so far as is known, in N. Scandinavia and Russia; and the first trustworthy information on that subject was obtained by J. Wolley in June 1853, when he found several of its nests near Muonioniska in Lapland.⁴ Instead of rising wildly as do most of its allies, it generally lies so close as to let itself be almost trodden upon, and then takes wing silently, to alight at a short distance and to return to the same place on the morrow. In the breeding-season, however, it is as noisy and conspicuous as its larger brethren while executing its aerial evolutions.

As a group the Snipes are in several respects highly specialized. We may mention the sensitiveness of the bill, which, though to some extent noticeable in many Sandpipers (*q.v.*), is in Snipes carried to an extreme by a number of filaments, belonging to the fifth pair of nerves, which run almost to the tip and open immediately under the soft cuticle in a series of cells that give this portion of the surface of the premaxillaries, when exposed, a honeycomb-like appearance. Thus the bill becomes a most delicate organ of sensation, and by its means the bird, while probing for food, is at once able to distinguish the nature of the objects it encounters, though these are wholly out of sight. So far as is known the sternum of all the Snipes, except the Jack-Snipe, departs from the normal Limicoline formation, a fact which tends to justify the removal of that species to a separate genus, *Limnocyptes*.⁵ (A. N.)

SNIP SNAP SNOREM, an old game at cards, sometimes called *Earl of Coventry*. There are several methods of playing, but in the commonest a full whist pack is used and any number of players may take part. The pack is dealt, one card at a time, and the eldest hand places upon the table any card he likes. Each player in his turn then tries to match the card played just before his, making use of a prescribed formula if successful. Thus, if a king is played, the second player lays down another king (if he can) calling out "Snip!" The next player lays down the third king, saying "Snap!" and the next the fourth king with the word "Snorem." A player not being able to pair the card played may not discard, and the holder of "Snorem" has the privilege of beginning the next round. The player who gets rid of all his cards first wins a counter from his companions for each card still held by them.

SNOILSKY, CARL JOHAN GUSTAF, COUNT (1841-1903), Swedish poet, was born at Stockholm on the 8th of September 1841. He was educated at the Clara School, and in 1860 became a student at Upsala. He was trained for diplomacy, which he quitted for work at the Swedish Foreign Office. As early as 1861, under the pseudonym of "Sven Tröst," he began to print poems, and he soon became the centre of the brilliant literary society of the capital. In 1862 he published a collection of lyrics called *Orchideer* ("Orchids"). During 1864 and 1865 he was in Madrid and Paris on diplomatic missions. It was in 1869, when he first collected his *Dikter* under his own name, that Snoilsky took rank among the most eminent contemporary poets. His

³ Though this word is clearly not intended as a nickname, such as is the prefix which custom has applied to the Daw, Pie, Redbreast, Titmouse or Wren, one can only guess at its origin or meaning. It may be, as in Jackass, an indication of sex, for it is a popular belief that the Jack-Snipe is the male of the common species; or, again, it may refer to the comparatively small size of the bird, as the "jack" in the game of bowls is the smallest of the balls used, and as fishermen call the smaller Pikes Jacks.

⁴ His account was published by Hewitson in May 1855 (*Eggs Br. Birds*, 3rd ed., ii. pp. 356-358).

⁵ The so-called Painted Snipes, forming the genus *Rhynchaea*, demand a few words. Four species have been described, natives respectively of S. America, Africa, India with China, and Australia. In all of these it appears that the female is larger and more brilliantly coloured than the male, and in the Australian species she is further distinguished by what in most birds is emphatically a masculine property, though its use is here unknown—namely, a complex trachea, while the male has that organ simple. He is also believed to undertake the duty of incubation.

Sonnetter in 1871 increased his reputation. Then, for some years, Snoilsky abandoned poetry, and devoted himself to the work of the Foreign Office and to the study of numismatics. In 1876, however, he published a translation of the ballads of Goethe. Snoilsky had in 1876 been appointed keeper of the records, and had succeeded Bishop Genberg as one of the eighteen of the Swedish Academy. But in 1879 he resigned all his posts, and left Sweden abruptly for Florence with the Baroness Ruuth-Piper, whom he married in 1880. Count Snoilsky sent home in 1881 a volume of *Nya Dikter* (New Poems). Two other volumes of *Dikter* appeared in 1883 and 1887, and 1897; *Sazonarola*, a poem, in 1883, and *Hvita frum* ("The White Lady") in 1885. In 1886 he collected his poems dealing with national subjects as *Svenska bilder* (2nd ed., 1895), which ranks as a Swedish classic. In 1891 he returned to Stockholm, and was appointed principal librarian of the Royal Library. He died at Stockholm on the 19th of May 1903. His literary influence in Sweden was very great; he always sang of joy and liberty and beauty, and in his lyrics, more than in most modern verse, the ecstasy of youth finds expression. He is remarkable, also, for the extreme delicacy and melodiousness of his verse-forms.

His *Samtade dikter* were collected (Stockholm, 5 vols.) in 1903-1904.

SNORRI STURLASON (1179-1241), the celebrated Icelandic historian, the youngest son of a chief in the Vestfirðir (western firds), was brought up by a powerful chief, Jon Loptsson, in Odda, who seems first to have awakened in him an interest for history and poetry. His career begins with his marriage, which made him a wealthy man; in 1206 he settled at Reykjaholt, where he constructed magnificent buildings and a bath of hewn stones, preserved to the present day, to which water was conducted from a neighbouring hot spring. He early made himself known as a poet, especially by glorifying the exploits of the contemporary Norse kings and earls; at the same time he was a learned lawyer, and from 1215 became the *lögsögumaðr*, or president of the legislative assembly and supreme court of Iceland. The prominent features of his character seem to have been cunning, ambition and avarice, combined with want of courage and aversion from effort. By royal invitation he went in 1218 to Norway, where he remained a long time with the young king Haakon and his tutor Earl Skuli. When, owing to disputes between Icelandic and Norwegian merchants, Skuli thought of a military expedition to Iceland, Snorri promised to make the inhabitants submit to Haakon of their own free will. Snorri himself became the *lendrmaðr*, vassal or baron, of the king of Norway, and held his lands as a fief under him. On his return home Snorri sent his son to the king as a hostage, and made peace between Norway and Iceland, but his power and influence were used more for his own enrichment and aggrandizement—he was *lögsögumaðr* again from 1222 to 1232—than for the advantage of the king. Haakon, therefore, stirred up strife between Snorri's kinsman Sturla and Snorri, who had to fly from Reykjaholt in 1236; and in 1237 he left the country and went back to Norway. Here he joined the party of Skuli, who was meditating a revolt. Learning that his cousin Sturla in Iceland had fallen in battle against Gissur, Snorri's son-in-law, Snorri, although expressly forbidden by his liege lord, returned to Iceland in 1239 and once more took possession of his property. Meanwhile Haakon, who had vanquished Skuli in 1240, sent orders to Gissur to punish Snorri for his disobedience either by capturing him and sending him back to Norway or by putting him to death. Gissur took the latter course, attacked Snorri at his residence, Reykjaholt, and slew him on the 22nd of September 1241.

Snorri is the author of the great prose *Edda* (see *EDDA*), and of the *Heimskringla* or *Sagas of the Norwegian Kings*, a connected series of biographies of the kings of Norway down to Sverri in 1177. The later work opens with the *Ynglinga Saga*, a brief history of the pretended immigration into Sweden of the Aesir, of their successors in that country, the kings of Upsala, and of the oldest Norwegian kings, their descendants. Next come the biographies of the succeeding Norwegian kings, the most detailed being those of the two missionary kings Olaf Trygvason and St Olaf. Snorri's sources were partly succinct histories of the realm, as the chronological sketch of Ari;

partly more voluminous early collections of traditions, as the *Noregs Konungatal* (*Fagrskinna*) and the *Jarlasaga*; partly legendary biographies of the two Olafs; and, in addition to these, studies and collections which he himself made during his journeys in Norway. His critical principles are explained in the preface, where he dwells on the necessity of starting as much as possible from trustworthy contemporary sources, or at least from those nearest to antiquity—the touchstone by which verbal traditions can be tested being contemporary poems. He inclines to rationalism, rejecting the marvelous and recasting legends containing it in a more historical spirit; but he makes an exception in the accounts of the introduction of Christianity into Norway and of the national saint St Olaf. Snorri strives everywhere to impart life and vigour to his narrative, and he gives the dialogues in the individual character of each person. Especially in this last he shows a tendency to epigram and often uses humorous and pathetic expressions. Besides his principal work, he elaborated in a separate form its better and larger part, the *History of St Olaf* (the great *Olaf's Saga*). In the preface to this he gives a brief extract of the earlier history, and, as an appendix, a short account of St Olaf's miracles after his death; here, too, he employs critical art, as appears from a comparison with his source, the Latin legend. See further ICELAND, *Literature*, and *EDDA*.

SNOW (in O. Eng. *snāw*; a common Indo-European word; cf. in Teutonic languages, Ger. *Schnee*, Du. *sneeuw*; in Slavonic *snieg*, Lith. *snėgas*; Gr. *νίφα*, Lat. *nix*, *nivis*, whence the Romanic forms, Ital. *neve*, Fr. *neige*, &c.; Ir. and Gael. *sneachd*; the original sense of the root may be to moisten, cf. Skt. *sucha*, moisture), that form of precipitation of water-vapour condensed from the atmosphere which reaches the ground in a frozen and crystalline condition. Snow thus occurs when the processes of condensation and fall take place at a temperature below 32° F. The crystals, which vary greatly in form, belong to the hexagonal system. They are formed upon a nucleus, in the same way as a raindrop, and sometimes reach the ground singly, but more commonly in small coherent masses or flakes. If in its passage from the upper atmosphere snow passes through a temperature above 32° F. it reaches the ground as sleet or rain (according to the degree of heat encountered), and thus after a fall of rain over lowlands, the higher parts of mountains in the vicinity may be seen to have received the fall as snow.

See further CLIMATE and METEOROLOGY; and for the transformation of snow into ice under pressure, see GLACIER.

SNOWDON (*Wyddfa*, view-place, *Eryri*, eagle-place), the highest elevation in N. Wales. It is formed chiefly of slates, grits and porphyries of the Cambrian and Silurian systems. It consists of five "ribs" converging at the summit, 3560 ft. above sea-level. Between these lie such depressions as Cwm Glas (blue or green vale) to the N., and Cwm y llan (clearing, town or church vale) to the S. Snowdon is demarcated from the surrounding hills by passes famous for their scenery, such as that of Llanberis (*q.v.*) to the N.E. and Aberglaslyn to the S. These two passes are joined by Nant Gwynnant (stream, or valley, of the white or happy valley, or stream), skirting the S.E. flanks of the Snowdon *massif*. Nant Colwyn runs N.W. to Carnarvon. A rack-and-pinion railway (opened in 1897) ascends from Llanberis to the summit of the mountain (4½ m.). Snowdonia, as the locality is sometimes called, contains several lakes, e.g. Peris and Padarn at Llanberis; Glaslyn and Llydaw between Cribgoch (red crest) and Lliwedd; Cwellyn and others W. of the hill itself; and Gwynnant and Dinas (Y Ddinas) in Nantgwynnant.

SNOWDROP, *Galanthus nivalis*, the best known representative of a small genus of the order Amaryllidaceae, all the species of which have bulbs, linear leaves and erect flower-stalks, destitute of leaves but bearing at the top a solitary pendulous bell-shaped flower. The white perianth is six-parted, the outer three segments being larger and more convex than the inner series. The six anthers open by pores or short slits. The ovary is three-celled, ripening into a three-celled capsule. The snowdrop is a doubtful native of Great Britain, but is largely cultivated for market in Lincolnshire. There are numerous varieties, differing in the size of the flower and the period of flowering. Other distinct species of snowdrop are the Crimean snowdrop, *G. plicatus*, with broad leaves folded like a fan, and *G. Elwesii*, a native of the Levant, with large flowers, the three inner segments of which have a much larger and more conspicuous green blotch than the commoner kinds. All the species thrive in almost

any soil or position, and when once planted should be left to themselves.

SNOW-LEOPARD, or OUNCE (*Felis uncia*), a large member of the cat family, from the high mountain regions of Central Asia. It resembles the leopard in general conformation, but has longer fur, grey in colour, marked with large dark rosettes. The dimensions of the head and body are about 4 ft. 4 in., tail 3 ft., and the height 2 ft. This animal lives among rocks, and preys upon wild sheep and goats, and probably large rodents or birds. It carries off sheep, goats and dogs from villages, and even kills ponies, but, it is said, has never been known to attack man (Blanford). Examples shown in the Zoological Gardens of London have been fairly tame and playful.

SNOW-LINE. In the higher latitudes, and in the most elevated parts of the surface of the earth, the atmosphere may be normally so cold that precipitation is chiefly in the form of snow, which lies in great part unmelted. The snow-line is the imaginary line, whether in latitude or in altitude, above which these conditions exist. In the extreme polar regions they exist at sea-level, but below lat. 78° the snow-line begins to rise, since at the lower elevations the snow melts in summer. In N. Scandinavia the line is found at about 3000 ft. above the sea, in the Alps at about 8500 ft., and on high mountains in the tropics at about 18,000 to 19,000 ft. These figures, however, can only be approximate, as many considerations render it impossible to employ the term "snow-line" as more than a convenient generalization.

SNOW-SHOES, a form of footgear devised for travelling over snow. Nearly every American Indian tribe has its own particular shape of shoe, the simplest and most primitive being those of the far north. The Eskimos possess two styles, one being triangular in shape and about 18 in. in length, and the other almost circular. Southward the shoe becomes gradually narrower and longer, the largest being the hunting snow-shoe of the Crees, which is nearly 6 ft. long and turned up at the toe. Of snow-shoes worn by people of European race that used by lumbermen is about 3½ ft. long and broad in proportion, while the tracker's shoe is over 5 ft. long and very narrow. This form has been copied by the Canadian snow-shoe clubs, who wear a shoe about 3½ ft. long and 15 to 18 in. broad, slightly turned up at the toe and terminating in a kind of tail behind. This is made very light for racing purposes, but much stouter for touring or hunting.

Snow-shoes are made of a single strip of some tough wood, usually hickory, curved round and fastened together at the ends and supported in the middle by a light cross-bar, the space within the frame thus made being filled with a close webbing of dressed caribou or neat's-hide strips, leaving a small opening just behind the cross-bar for the toe of the moccasined foot. They are fastened to the moccasin by leather thongs, sometimes by buckles. The method of walking is to lift the shoes slightly and slide the overlapping inner edges over each other, thus avoiding the unnatural and fatiguing "straddle-gait" that would otherwise be necessary. Immoderate snow-shoeing leads to serious lameness of the feet and ankles which the Canadian *voyageurs* call *mal de raquette*. Snow-shoe racing is very common in the Canadian snow-shoe clubs, and one of the events is a hurdle-race over hurdles 3 ft. 6 in. high. Owing to the thick forests of America the snow-shoe has been found to be more suitable for use than the Norwegian *ski*, which is, however, much used in the less-wooded districts.

SNUFF (from "to snuff," *i.e.* to inhale, to draw in through the nose; cf. Dutch *snuf*, scent, Ger. *Schnupfen*, a cold, catarrh, and Eng. "snuffle," "sniff," &c.), the name of a powdered preparation of tobacco used for inhalation (for the manufacture see TOBACCO). The practice of inhaling snuff became common in England in the 17th century, and throughout the 18th century it was universal. At first each quantity inhaled was fresh grated (Fr. *rapée*), whence the coarser kinds were later known as "rappee." This entailed the snuff-taker carrying with him a grater with a small spoon at one end and a box to hold the grated snuff at the other. Early 18th-century graters made of ivory and other material are in existence. Later the box and the grater were separated. The art and craft of the miniature

painter, the enameller, jeweller and gold- and silver-smith was bestowed upon the box. The humbler snuff-takers were content with boxes of silver, brass or other metal, horn, tortoise-shell or wood. The mull (*g.v.*), a silver-mounted ram's head, is a large table snuff-box. Though "snuff-taking" ceased to be fashionable at the beginning of the 19th century, the gold and jewelled snuff-box has continued to be a typical gift of sovereigns to those whom they delight to honour.

This word "snuff" must be distinguished from that meaning the charred inch of a candle or lamp, which is a variant of "snip" or "snop," to cut off, trim, cf. Dan. *snubbe*. Constant trimming or snuffing of candles was a necessity until obviated by the modern methods of candle manufacture, and the snuffers consisted of a pair of scissors with a closed box forming a receptacle for the charred wick cut off; the snuffers usually had three small feet which allowed them to stand on a tray. Made of silver, silver-gilt or other metal, "snuffers" were formerly a decorative article of plate in the equipment of a household. There is a beautiful example of silver snuffers with enamel decorations in the British Museum. These belonged to Cardinal Bainbridge and date from the reign of Henry VIII.

SNYDERS, FRANZ (1579-1657), Flemish painter of animals and still life, was born and died at Antwerp. In 1593 he was studying under Pieter Breughel the younger, and afterwards received instruction from Hendrick van Balen, the first master of Van Dyck. He devoted himself to painting flowers, fruit and subjects of still life, but afterwards turned to animal-painting, and executed with the greatest skill and spirit hunting pieces and combats of wild animals. His composition is rich and varied, his drawing correct and vigorous, his touch bold and thoroughly expressive of the different textures of furs and skins. His excellence in this department excited the admiration of Rubens, who frequently employed him to paint animals, fruit and still life in his own pictures, and he assisted Jordaens in a similar manner. In the lion and boar hunts which bear the name of Snyder's the hand of Rubens sometimes appears. He was appointed principal painter to the archduke Albert, governor of the Low Countries, for whom he executed some of his finest works. One of these, a "Stag-Hunt," was presented to Philip III., who commissioned the artist to paint several subjects of the chase, which are still preserved in Spain.

SOANE, SIR JOHN (1753-1837), English architect and art collector, was born near Reading of a humble family whose name of Swan he afterwards altered to Soan or Soane. His talent as a boy attracted the attention of George Dance, junior, the architect, who with other friends helped him on. He won the Royal Academy's silver (1772) and gold (1776) medals, and a travelling studentship, and went to Italy to study (1777-1780). Returning to England he got into practice as an architect, and in 1784 married a rich wife. He became architect to the Bank of England, which he practically rebuilt in its present form, and did other important public work. He became an A.R.A. in 1795, and R.A. in 1802, and professor of architecture to the Royal Academy in 1806. In 1831 he was knighted. In his house in Lincoln's Inn Fields he brought together a valuable antiquarian museum (now the Soane Museum), which in 1835 he presented to the nation with an endowment; and there he died in 1837. (See MUSEUMS.)

SOAP, a chemical compound or mixture of chemical compounds resulting from the interaction of fatty oils and fats with alkalis. In a scientific definition the compounds of fatty acids with basic metallic oxides, lime, magnesia, lead oxide, &c., should also be included under soap; but, as these compounds are insoluble in water, while the very essence of a soap in its industrial relations is solubility, it is better to speak of the insoluble compounds as "plasters," limiting the name "soap" as the compounds of fatty acids with soda and potash. Soap both as a medicinal and as a cleansing agent was known to Pliny (*H.N.* xxviii. 51), who speaks of two kinds—hard and soft—as used by the Germans. He mentions it as originally a Gallic invention for giving a bright hue to the hair ("rutilandis capillis"). There is reason to believe that soap came to the Romans from Germany, and that the detergents in use in earlier times and mentioned as soap

in the Old Testament (Jer. ii. 22; Mal. iii. 2, &c.) refer to the ashes of plants and other such purifying agents (comp. vol. x. p. 697).

Soap appears to have been first made from goat's tallow and beech ash; in the 13th century the manufacture was established at Marseilles from olive oil, and in England during the next century. The processes and extent of the manufacture were revolutionized at about the beginning of the 19th century by Chevreul's classical investigations on the fats and oils, and by Leblanc's process for the manufacture of caustic soda from common salt.

Previous to Chevreul's researches on the fats (1811-1823) it was believed that soap consisted simply of a binary compound of fat and alkali. Claude J. Geoffroy in 1741 pointed out that the fat or oil recovered from a soap solution by neutralization with a mineral acid differs from the original fatty substance by dissolving readily in alcohol, which is not the case with ordinary fats and oils. The significance of this observation was overlooked; and equally unheeded was a not less important discovery by Scheele in 1783. In preparing lead plaster by boiling olive oil with oxide of lead and a little water—a process palpably analogous to that of the soap-boiler—he obtained a sweet substance which, called by himself "Ölsüss" ("principium dulce oleorum"), is now known as "glycerin." These discoveries of Geoffroy and Scheele formed the basis of Chevreul's researches by which he established the constitution of oils and the true nature of soap. In the article OILS it is pointed out that all fatty oils and fats are mixtures of glycerides, that is, of bodies related to the alcohol glycerin $C_3H_5(OH)_3$, and some fatty acid such as palmitic acid $(C_{16}H_{31}O_2)H$. Under suitable conditions $C_3H_5(OH)_3 + 3(C_{16}H_{31}O_2)H$ give $C_5H_8(C_{16}H_{31}O_2)_3 + 3H_2O$
Glycerin. Palmitic Acid. Palmitin. Water.

The corresponding decomposition of a glyceride into an acid and glycerin takes place when the glyceride is distilled in superheated steam, or by boiling in water mixed with a suitable proportion of caustic potash or soda. But in this case the fatty acid unites with the alkali into its potash or soda salt, forming a soap—

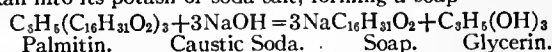

Of the natural fats or glycerides contained in oils the most important in addition to palmitin are stearin and olein, and these it may be sufficient to regard as the principal fatty bodies concerned in soap-making.

The general characters of a soap are a certain greasiness to the touch, ready solubility in water, with formation of viscid solutions which on agitation yield a tenacious froth or "lather," an indisposition to crystallize, readiness to amalgamate with small proportions of hot water into homogeneous slimes, which on cooling set into jellies or more or less consistent pastes. Soaps give an alkaline reaction and have a decided acid taste; in a pure condition—a state never reached in practice—they have neither smell nor colour. Almost without exception potash soaps, even if made from the solid fatty acids, are "soft," and soda soaps, although made with fluid olein, are "hard"; but there are considerable variations according to the prevailing fatty acid in the compound. Almost all soda soaps are precipitated from their watery solutions by the addition of a sufficiency of common salt. Potash soap with the same reagent undergoes double decomposition—a proportion being changed into a soda soap with the formation of potassium chloride. Ammonia soaps have also been made, but with little commercial success; in 1906 H. Jackson patented the preparation of ammonium oleate directly in the washing water, and it is claimed that for cleansing articles it is only necessary to immerse them in the water containing the preparation and then rinse.

Soap when dissolved in a large amount of water suffers hydrolysis, with formation of a precipitate of acid salt and a solution containing free alkali. The reaction, however, is very complicated. Chevreul found that a neutral salt soap hydrolysed to an acid salt, free alkali, and a small amount of fatty acid. Rotondi in 1885, however, regarded a neutral soap as hydrolysing to a basic salt, soluble in both hot and cold water, and an acid salt, insoluble in cold and sparingly soluble in hot. Chevreul's views were confirmed in 1894 by Krafft and Stern. The extent to which a soap is hydrolysed depends upon the acid and on the concentration of the solution; it is also affected by the presence of metallic salts, e.g. of calcium and magnesium. As to the detergent action of a soap, Berzelius held that it was due to the free alkali liberated with water; but it is difficult to see why a solution which has just thrown off most of its fatty acids should be disposed to take up even a glyceride, and, moreover, on this theory, weak cold solutions, in which the hydrolysis is considerable, should be the best cleansers, whilst experience points to the use of hot concentrated solutions. It is more likely that the cleansing power of soap is due to the inherent property of its solution to emulsify fats. This view is supported by Hillyer (*Jour. Amer. Chem. Soc.*, 1903, p. 524), who concluded that the cleansing power depended upon several factors, viz. the emulsifying power, the

property of penetrating oily fabrics, and lubricating impurities so that they can be readily washed away.

Resin soaps are compounds of soda or potash with the complex acids (chiefly abietic) of which coniferous resins consist. Their formation is not due to a true process of saponification; but they occupy an important place in compound soaps.

Manufacture.—Numerous varieties of soaps are made; the purposes to which they are applied are varied; the materials employed embrace a considerable range of oils, fats and other bodies; and the processes adopted undergo many modifications. As regards processes of manufacture soaps may be made by the direct combination of fatty acids, separated from oils, with alkaline solutions. In the manufacture of stearin for candles, &c., the fatty matter is decomposed, and the liquid olein, separated from the solid fatty acids, is employed as an ingredient in soap-making. A soap so made is not the result of saponification but of a simple combination, as is the case also with resin soaps. All other soaps result from the combination of fatty oils and fat with potash or soda solutions under conditions which favour saponification. The soap solution which results from the combination forms soap-size and is a mixture of soap with water, the excess alkali, and the glycerin liberated from the oil. In such condition ordinary soft soaps and certain kinds of hard soap are brought to the market. In curd soaps, however, which form the basis of most household soap, the uncombined alkali and the glycerin are separated by "salting out," and the soap in this condition contains about 30% of water. Soap may be framed and finished in this state, but almost invariably it receives a further treatment called "refining" or "fitting," in which by remelting with water, with or without the subsequent addition of other agents to harden the finished product, the soap may be made to contain from 60 to 70% of water and kept present a firm hard texture.

Almost any fatty substance can be employed in soap-making; but the choice is naturally restricted by the price of the fat and also the quality of the soap desired. The most important of the animal fats are those of the ox and hog, and of the vegetable oils cotton-seed and coco-nut; it is also to be remembered that resin, although not a fat, is also important in soap-making. Ox and sheep tallow, with the addition of resin, are the primary materials for making the hard yellow or primrose soaps; these tallows are often adulterated. The cheaper mottled and brown soaps have for their basis bone fat, obtained by treating bones with superheated steam or other methods. Lard yields lard oil, which is mainly applied in making hard toilet soaps. Curd soap and London grey mottled are prepared from kitchen or ship fat, whilst fuller's fat is employed in the manufacture of soft soaps. Of the vegetable oils, in addition to cotton-seed and coco-nut, olive oil is the basis of soaps for calico printers and silk dyers; castor oil yields transparent soaps (under suitable treatment), whilst crude palm oil, with bone fat, is employed for making brown soap, and after bleaching it yields ordinary pale or mottled. The alkalis are used almost exclusively in the condition of caustic lyes—solutions of their respective hydrates in water. Caustic soda is now obtained direct from the soda manufacturer, and one operation, causticizing the soda, is thus spared the soap-boiler. Potash lyes also may be bought direct, but in some cases they are sharpened or causticized by the soap-boiler himself from the carbonate.

The processes of soap manufacture may be classified (a) according to the temperatures employed into (1) cold processes and (2) boiling processes, or (b) according to the nature of the starting material—acid or oil and fat—and the relative amount of alkali, into (1) direct saturation of the fatty acid with alkali, (2) treating the fat with a definite amount of alkali with no removal of unused lye, (3) treating the fat with an indefinite amount of alkali, also with no separation of unused lye, (4) treating the fat with an indefinite amount of alkali with separation of waste lye. In the second classification (2) is typical of the "cold" process, whilst (1), (3), (4) are effected by the "boiling" process.

The cold process, which is only applicable to the manufacture of soaps from readily saponifiable oils, such as those of the coco-nut oil group and also from castor oil, is but little used. In it the oils at 35° C. are stirred with concentrated alkali in an iron or wooden tub, whereupon saponification ensues with a development of some heat; the mixture being well agitated. After a few hours the mixture becomes solid, and finally transparent; at this point the perfume is added, and the product framed and crutched (see under *Marine Soap*). By blending the coco-nut oil with other less saponifiable substances such as tallow, lard, cotton-seed oil, &c., and effecting the mixing and saponification at a slightly higher temperature, soaps are obtained which resemble milled toilet soaps. Soaps made by this process contain the glycerin originally present in the oil, but, in view

of their liability to contain free alkali and unsaponified oil, the process has been largely given up.

The process of soap-boiling is carried out in large iron boilers called "soap pans" or "coppers," some of which have capacity for a charge of 30 tons or more. The pan proper is surmounted by a great cone or hopper called a curb, to provide for the foaming up of the boiling mass and to prevent loss from overflowing. Formerly the pans were heated by open firing from below; but now the almost universal practice is to boil by steam injected from perforated pipes coiled within the pan, such injection favouring the uniform heating of the mass and causing an agitation favourable to the ultimate mixture and saponification of the materials. Direct firing is used for the second boiling of the soap mixture; but for this superheated steam may with advantage be substituted, either applied by a steam-jacket round the pan or by a closed coil of pipe within it. In large pans a mechanical stirring apparatus is provided, which in some cases, as in Morfit's steam "twirl," is formed of the steam-heating tubes geared to rotate. Autoclaves, in which the materials are boiled under pressure, are also employed for certain soaps.

The process of manufacturing soaps by boiling fatty acids with caustic alkalis or sodium carbonate came into practice with the development of the manufacture of candles by saponifying fats, for it provided a means whereby the oleic acid, which is valueless for candle making, could be worked up. The combination is effected in open vats heated by a steam coil and provided with a stirring appliance; if soda ash be used it is necessary to guard against boiling over. (See under *Curd Soap*.)

Curd Soap.—This variety is manufactured by boiling the fat with alkali and removing the unused lye, which is afterwards worked up for glycerin. The oil mixture used differs in the several manufacturing countries, and the commercial name of the product is correspondingly varied. In Germany tallow is the principal fat; in France olive oil occupies the chief place and the product is known as Marseilles or Castile soap; and in England tallow and palm oil are largely used. But in all countries a mixture of several oils enters into the composition of curd soaps and the proportions used have no fixity. For each ton of soap to be made from 12 to 16 cwt. of oil is required. The soap pan is charged with the tallow or other fat, and open steam is turned on. So soon as the tallow is melted a quantity of weak lye is added, and the agitation of the injected steam causes the fat and lye to become intimately mixed and produces a milky emulsion. As the lye becomes absorbed, a condition indicated by the taste of the goods, additional quantities of lye of increasing strength are added. After some time the contents of the pan begin to clear and become in the end very transparent. Lye still continues to be poured in till a sample tastes distinctly alkaline—a test which indicates that the whole of the fatty acids have been taken up by and combined with the alkali. Then without further addition of alkali the boiling is continued for a few minutes, when the soap is ready for salting out or "graining." Either common salt or strong brine in measured quantity is added to the charge, and the soap being insoluble in such salt solution, a separation of constituents takes place: the soap collects on the surface in an open granular condition, and the spent lye sinks to the bottom after it has been left for a short time to settle. Suppose that a pure soap without resin is to be made—a product little seen in the market—the spent lye is run off, steam is again turned on, pure water or very weak lye run in, and the contents boiled up till the whole is thin, close and clear. The soap is from this again grained off or salted out, and the underlye so thrown down carries with it coloured impurities which may have been in the materials or which arise from contact with the boiler. Such washing process may have to be repeated several times when impure materials have been used. The spent lye of the washing being drained off, the soap is now "boiled for strength." Steam is turned on, and the mass being brought to a clear condition with weak lye or water, strong lye is added and the boiling continued with close steam till the lye attains such a state of concentration that the soap is no longer soluble in it, and it will separate from the caustic lye as from a common salt solution. The contents of the pan are once more allowed to cool and settle, and the soap as now formed constitutes a pure curd soap, carrying with it some proportion of uncombined alkali, but containing the minimum amount of water. It may be skimmed off the underlye and placed direct in the frames for solidification; but that is a practice scarcely at all followed, the addition of resin soap in the pan and the subsequent "crutching in" of silicate of soda and adulterant mixings being features common to the manufacture. The lye from the strengthening boil contains much alkali and is used in connexion with other boilings.

Mottled Soap.—A curd soap prepared from kitchen fat or bone grease always carries with it into the cooling frame a considerable amount of coloured impurity, such as iron sulphate, &c. When it is permitted to cool rapidly the colouring matter remains uniformly disseminated throughout the mass; but when means are taken to cause the soap to cool and solidify slowly a segregation takes place: the stearate and palmitate form a semi-crystalline solid, while the oleate, solidifying more slowly, comes by itself into translucent veins, in which the greater part of the coloured matter is drawn. In this way curd, mottled or marbled soap is formed, and such mottled

appearance was formerly highly valued as an indication of freedom from excess of water or other adulteration, because in fitted soaps the impurities are either washed out or fall to the bottom of the mass in cooling. Now, however, the mottled soaps, blue and grey, are produced by working colouring matter, ultramarine for blue, and manganese dioxide for grey, into the soap in the frame, and mottling is very far from being a certificate of excellence of quality.

Yellow Soap consists of a mixture of any hard fatty soap with a variable proportion—up to 40% or more—of resin soap. That substance by itself has a tenacious glaucous consistence, and its intermixture in excess renders the resulting compound soft and greasy. The ordinary method of adding resin consists in stirring it in small fragments into the fatty soap in the stage of clear-boiling; but a better result is obtained by separately preparing a fatty soap and the resin soap, and combining the two in the pan after the underlye has been salted out and removed from the fatty soap. The compound then receives its strengthening boil, after which it is fitted by boiling with added water or weak lye, continuing the boil till by examination of a sample the proper consistency has been reached. On settling the product forms three layers: the uppermost is a thin crust of soap which is worked up again in the pan; the second is the desired soap; next there is a dark-coloured weak soap termed *negre*, which, because it contains some soap and alkali is saved for future use; underneath these is a solution of alkaline salts with a little free alkali.

Treatment of Settled Soap.—The upper layer having been removed, the desired soap is ladled out or ran off to a crutch, which is an iron pan provided with hand or mechanical stirring appliances. It is here stirred till it becomes ropy, and the perfume, colour or any other substance desired in the soap is added. The soap is now ready for framing. The frames into which hard soaps are ladled for cooling and solidification consist of rectangular boxes made of iron plates and bound and clamped together in a way that allows the sides to be removed when required; wooden frames are used in the case of mottled soaps. The solidification is a very gradual process, depending, of course, for its completion on the size of the block; but before cutting into bars it is essential that the whole should be set and hardened through and through, else the cut bars would not hold together. Many ingenious devices for forming bars have been produced; but generally a strong frame is used, across which steel wires are stretched at distances equal to the size of the bars to be made, the blocks being first cut into slabs and then into bars.

Marine Soap.—These soaps are so named because they are not insoluble in a strong solution of salt; hence they form a lather and can be used for washing with sea-water. Being thus soluble in salt water it cannot, of course, be salted out like common soaps; but if a very concentrated salt solution is used precipitation is effected, and a curd soap is separated so hard and refractory as to be practically useless. Coco-nut soap (see above) is typical of this class. Its property of absorbing large proportions of water, up to 80%, and yet present the appearance of a hard solid body, makes the material a basis for the hydrated soaps, smooth and marbled, in which water, sulphate of soda, and other alkaline solutions, soluble silicates, fuller's earth, starch, &c. play an important and bulky part. Coco-nut soap also forms a principal ingredient in compound soaps meant to imitate curd and yellow soaps. Two principal methods of preparing such compound soaps are employed. In the first way the ordinary oil and the coco nut oil are mixed and saponified together as described above. According to the second plan, the ordinary oil is treated as for the preparation of a curd soap, and to this the coco-nut soap separately saponified is added in the pan and both are boiled together till they form a homogeneous soap.

Silicate Soaps.—A further means of enabling a soap to contain large proportions of water and yet present a firm consistence is found in the use of silicate of soda. The silicate in the form of a concentrated solution is crutched or stirred into the soap in a mechanical mixing machine after the completion of the saponification, and it appears to enter into a distinct chemical combination with the soap. While silicate soaps bear heavy watering, the soluble silicate itself is a powerful detergent, and it possesses certain advantages when used with hard waters.

Soft Soap.—Soft soaps are made with potash lyes, although in practice a small quantity of soda is also used to give the soap some consistence. There is no separation of underlyes in potash soap, consequently the product contains the whole constituents of the oils used, as the operation of salting out is quite impracticable owing to the double decomposition which results from the action of salt, producing thereby a hard principally soda soap with formation of potassium chloride. Owing to this circumstance it is impossible to "fit" or in any way purify soft soap, and all impurities which go into the pan of necessity enter into the finished product. The making of soft soap, although thus a much less complex process than hard soap making, is one that demands much skill and experience for its success. From the conditions of the manufacture care must be taken to regulate the amount and strength of the alkali in proportion to the oil used, and the degree of concentration to which the boiling ought to be continued has to be determined with close observation.

Toilet Soaps, &c.—Soaps used in personal ablution in no way differ from the soaps previously alluded to, and may consist of any of the varieties. It is of consequence that they should, as far as possible, be free from excess of alkali and all other salts and foreign

ingredients which may have an injurious effect on the skin. The manufacturer of toilet soap generally takes care to present his wares in convenient form and of agreeable appearance and smell; the more weighty duty of having them free from uncombined alkali is in many cases entirely overlooked. Transparent soaps are prepared by dissolving ordinary soap in strong alcohol and distilling off the greater portion of the alcohol till the residue comes to the condition of a thick transparent jelly. This, when cast into forms and allowed to harden and dry slowly, comes out as transparent soap. A class of transparent soap may also be made by the cold process, with the use of coco-nut oil, castor oil and sugar. It generally contains a large amount of uncombined alkali, and that, with its unpleasant odour of coco-nut oil, makes it a most undesirable soap for personal use. Toilet soaps of common quality are perfumed by simple melting and stirring into the mass some cheap odorous body that is not affected by alkalis under the influence of heat. The finer soaps are perfumed by the cold method; the soap is shaved down to thin slices, and the essential oil kneaded into and mixed with it by special machinery, after which it is formed into cakes by pressure in suitable moulds. The greater quantity of high-class toilet soaps are now made by a milling process. A high class soap, which after framing contains about 30% of water, is brought down to a water content of 11-14% by drying in chambers through which warm air is circulated. The soap is now milled in the form of ribbons with the perfume and colouring matter, and the resulting strips are welded into bars by forcing through a heated nozzle. The bars are then cut or moulded into tablets, according to the practice of the manufacturer.

Glycerin soap ordinarily consists of about equal parts of pure hard soap and glycerin (the latter valuable for its emollient properties). The soap is melted by heat, the glycerin is stirred in, and the mixture strained and poured into forms, in which it hardens but slowly into a transparent mass. With excess of glycerin a fluid soap is formed, soap being soluble in that body, and such fluid soap has only feeble lathering properties. Soap containing small proportions of glycerin, on the other hand, forms a very tenacious lather, and when soap bubbles of an enduring character are desired glycerin is added to the solution. Soaps are also prepared in which large proportions of fine sharp sand, or of powdered pumice, are incorporated, and these substances, by their abrading action, powerfully assist the detergent influence of the soap on hands much begrimed by manufacturing operations.¹

Medicated soaps, first investigated scientifically by Unna of Hamburg in 1886, contain certain substances which exercise a specific influence on the skin. A few medicated soaps are prepared for internal use, among which are croton soap and jalap soap, both gentler cathartics than the uncompounded medicinal principles. Medicated soaps for external use are only employed in cases of skin ailments, as prophylactic washes and as disinfectant soaps. Among the principal varieties are those which contain carbolic acid and other ingredients of coal tar, salicylic acid, petroleum, borax, camphor, iodine, mercurial salts, sulphur and tannin. Arsenical soap is very much employed by taxidermists for the preservation of the skins of birds and mammals.

Miscellaneous Soaps.—The so-called "floating soaps" are soaps made lighter than water either by inserting cork or a metallic plate so as to form an air space within the tablet. The more usual method is to take milling soap, neutralize it with sodium bicarbonate or a mixture of fatty acids, and, after perfuming, it is aerated by mixing the hot soap with air in a specially designed crutcher. Shaving soaps, which must obviously be free from alkali or any substance which irritates the skin, are characterized by readily forming a permanent lather. This property is usually obtained by mixing soft and hard soaps, or, more rarely, by adding gum tragacanth to a hard soap. In the textile trades the wool scourer employs a neutral olive-oil soap, or, on account of its cheapness, a neutral curd or curd mottled brand; the cotton cleanser, on the other hand, uses an alkaline soap, but for cleaning printed cottons a neutral olive-oil curd soap is used, for, in this case, free alkali and resin are objectionable; olive-oil soap, free from caustic alkali, but often with sodium carbonate, is also used in cleansing silk fibres, although hard soaps free from resin are frequently employed for their cheapness. Soaps of smaller moment are the pearl ash soaps used for removing tarry stains; ox-gall soaps for cleaning carpets; magnesia, rouge and chalk soaps for cleaning plate, &c.

Soap Analysis.—The most important points in soap analysis are (1) determination of the fatty matter, (2) of the total alkali, (3) of the substances insoluble in water, (4) of the water. The first is carried out by saponifying the soap with acid in the heat when the fatty acids come to the surface. If it fails to form a hard cake on cooling, a known weight of wax may be added and the product re-heated. The cake on weighing gives the free acid. The total alkali is determined by incinerating a weighed sample in a platinum dish, dissolving the residue in water, filtering and titrating the filtrate with standard acid. The residue on the filter paper gives (3) the substances insoluble in water. The water in a soap is rarely directly determined; when it is, the soap, in the form of shavings, is heated to 105° C. until the weight is constant, the loss giving the amount of

¹ "Soap powders" and "soap extracts" are powdered mixtures of soaps, soda ash or ordinary sodium carbonate.

water. With genuine soaps, however, it suffices to calculate the fatty acids as anhydrides and add to this the amount of alkalis, and estimate the water by difference. The complete analysis involves an examination of the fatty matter, of the various forms in which the alkalis are present—free and combined glycerin, &c.

Commerce.—Marseilles has long been recognized as the most important centre of the soap trade, a position that city originally achieved through its ready command of the supplies of olive oil. The city is still very favourably situated for obtaining supplies of oils both local and foreign, including sesame, ground nut, castor oil, &c. In England, during the reign of Charles I., a monopoly of soap-making was farmed to a corporation of soap-boilers in London—a proceeding which led to serious complications. From 1712 to 1853 an excise duty ranging from 1d. to 3d. was levied on soap made in the United Kingdom, and that heavy impost (equal when 3d. to more than cost) greatly impeded the development of the industry. In 1793, when the excise duty was 2½d. on hard and 1½d. on soft soap, the revenue yielded was a little over £400,000; in 1815 it was almost £750,000; in 1835, when the duty was levied at 1½d. and 1d. respectively (and when a drawback was allowed for soap used in manufactures), the revenue was almost £1,000,000; and in 1852, the last year in which the duty was levied, it amounted to £1,126,046, with a drawback on exportation amounting to £271,000.

Medicine.—Two preparations of hard soap (sodium oleate), made by acting on olive oil with caustic soda, are used in medicine: (1) *Emplastrum saponis*, made with lead plaster; (2) *Pilula saponis composita*, which contains one in five parts of opium. Soft or green soap (potassium oleate), made by acting on olive oil with caustic potash, is also used; its preparation (*Linamentum saponis*) is known as opodeldoc. Curd soap is also used, and is chiefly a stearate of sodium. The chief use of hard soap is in enemas, and as a suppository in children suffering from constipation; it also forms the basis of many pills; given in warm water it forms a ready emetic in cases of poisoning. Soft soap is used by dermatologists in the treatment of chronic eczema, and opodeldoc is a domestic remedy for stiffness and sprains. Medicated soaps are made by adding the drug to either hard soap or curd soap in the desired proportions. Useful combinations are: borax 10%, carbolic acid 5%, ichthyol 5%, sublimed sulphur 10%, thymol 2½%, &c.

See L. Lamborn, *Modern Soaps, Candles and Glycerin* (1906); W. H. Simmons and H. A. Appleton, *The Handbook of Soap Manufacture* (1908); also J. Lewkowitsch, *Oils, Fats and Waxes*.

SOAP-BARK, the inner bark of *Quillaja saponaria*, a large tree which grows in Chile. Reduced to powder, it is employed as a substitute for soap, since it forms a lather with water, owing to the presence of a glucoside saponin, sometimes distinguished as *Quillai saponin*. The same, or a closely similar substance, is found in soapwort (*Saponaria officinalis*), in senega root (*Polygala senega*) and in sarsaparilla; it appears to be chemically related to digitonin, which occurs in digitalis. The saponins (with few exceptions), have the general formula (C_nH_{2n-3}O₁₀), and by the action of dilute acids they are hydrolysed into sugars and saponin, which are usually inert pharmacologically. An alternative name for them, and especially for those which are pharmacologically active, is *sapotoxins*; on this nomenclature the hydrolytic products are termed saponins. Applied as a snuff to the mucous membrane of the nose, saponin (either in soap-bark or in senega root) promotes a violent sneezing. Solutions injected under the skin are violent local irritants and general depressants.

SOBAT, a river of N.E. Africa, the most southerly of the great eastern affluents of the Nile. It is formed by the junction of various streams which rise in the S.W. of the Abyssinian highlands and N.W. of Lake Rudolf. The length of the Sobat, reckoning from the source of the Baro, the chief upper stream, to the confluence with the Nile is about 460 m. The Baro rises in about 36° 10' E., 7° 50' N. at an altitude of some 7000 ft. It has a general W. direction with a slight N. tendency. It is joined by numerous other streams which also rise on the Abyssinian plateau. These mountain torrents descend the escarpment of the plateau between great walls of rock, the Baro dropping 3000 ft. in 45 m. It then flows through a narrow gorge at an altitude of about 2000 ft., the mountains on either side towering 3000 to 4000 ft. above the river bed. Just east of 35' E. the Birbir, descending from the plateau, joins the Baro and brings with it a large volume of water. Some 40 m. lower down the hills are left behind, the rocks and rapids in the bed of the Baro cease, and the river flows W. across a vast plain with many windings and several divergent channels. From Gambela, a town on its N. bank 20 m. below the Birbir junction, the river is

navigable by steamers during flood time (June-December) to the point of confluence with the White Nile. From the N. the Baro is joined by two considerable rivers which also rise in the rampart of hills that separates Abyssinia from the Sudan, but its chief tributaries are from the S. In about 33° 20' E., 8° 30' N., it is joined by the Pibor. This river issues from the swamp region east of Bor on the Bahr-el-Jebel stretch of the Nile and flows N.E. and N. It is joined from the E. and S. by various streams having their sources on the W. slopes of the Kaffa plateau. Of these the chief are the Gelo—which breaks through a gap in the mountains in a series of magnificent cascades—and the Akobo. The Akobo rises in about 6° 30' N., 35° 30' E., and after leaving the mountains flows N.W. through flat swampy tracts. The whole region of the lower Pibor and Baro is one of swamps, caused by the rivers overflowing their banks in the rainy season. At its junction with the Baro the Pibor is over 100 yds. wide, with a depth of 8 ft. and a speed of 2.3 ft. per second.

Below the confluence of the Pibor and Baro the united stream, now known as the Sobat, takes a decided N.W. trend, passing for some distance through a region of swamps. Just beyond the swamps and some 40 m. below the confluence, is the fortified post of Nasser. From this point the ground on either side of the river gradually rises, though on the S. it is liable to inundation during flood time. From Nasser to the junction of the Sobat with the Nile the river has a course of about 180 m. As it approaches the Nile the Sobat flows in a well-defined channel cut in the alluvial plains through which it passes. The banks become steep, the slope rapid and the current strong. Several *khors* join it from N. and S., some being simply spill channels. These channels or "loops" are a characteristic feature of the river. The Sobat enters the Nile almost at right angles in 9° 22' N., 31° 31' E. It is 400 ft. wide at its mouth and has a depth of 18 to 20 ft. at low water and of 30 ft. when in flood. The colour of the water when in moderate flood is that of milk, and it is from this circumstance that the Nile gets its name of Bahr-el-Abiad, *i.e.* White River. In full flood the colour of the Sobat is a pale brick red. The amount of alluvium brought down is considerable. For the part played by the Sobat in the annual rise of the Nile see NILE.

The Sobat was ascended for some distance in 1841 by the Egyptian expedition despatched in the previous year to explore the upper Nile. The post of Nasser (see above) was founded in 1874 by General C. G. Gordon when governor of the equatorial provinces of Egypt, and it was visited in 1876 by Dr W. Junker, the German explorer. The exploration of the river system above Nasser was carried out in the last decade of the 19th century by the Italian explorer V. Bottego, by Colonel (then Captain) Marchand, of the French army, who, on his way from Fashoda to France, navigated the Baro up to the foot of the mountains; and by Captain M. S. Wellby, Majors H. H. Austin and R. G. T. Bright, of the British army, and others. By the agreement of the 15th of May 1902 between Great Britain and Abyssinia the lower courses of the Pibor and Baro rivers to their point of confluence form the frontier between the Anglo-Egyptian Sudan and Abyssinia.

See NILE, SUDAN and ABYSSINIA. (W. E. G.; F. R. C.)

SOBRAON, a decisive battle in the first Sikh War (see SIKH WARS). It was fought on the 16th of February 1846, between the British (15,000) under Sir Hugh Gough and the Sikhs (20,000) under Tej Singh and Lal Singh. The Sikhs had fortified themselves in a bend on the left bank of the Sutlej, with the river in their rear. The battle began with a two hours' artillery duel, in which the Sikh guns were the more powerful, and the British heavy guns expended their ammunition. Then the infantry advanced with the bayonet, and after a fierce struggle took the Sikh entrenchments. The Sikh losses were estimated at from 5000 to 8000. This battle ended the first Sikh War.

SOBRIQUET, a nickname or a fancy name, usually a familiar name given by others as distinct from a "pseudonym" assumed as a disguise. Two early variants are found, *sobriquet* and *soubriquet*; the latter form is still often used, though it is not

the correct modern French spelling. The first form suggests a derivation from *sot*, foolish, and *briquet*, a French adaptation of Ital. *brichetto*, diminutive of *bricco*, ass, knave, possibly connected with *briccone*, rogue, which is supposed to be a derivative of Ger. *brechen*, to break; but Skeat considers this spelling to be due to popular etymology, and the real origin is to be sought in the form *soubriquet*. Littré gives an early 14th century *soubriquet* as meaning a "chuck under the chin," and this would be derived from *soubs*, mod. *sous* (Lat. *sub*), under, and *briquet* or *bruchel*, the brisket, or lower part of the throat.

SOCAGE, a free tenement held in fee simple by services of an economic kind, such as the payment of rent or the performance of some agricultural work, was termed in medieval English law a socage tenement. In a borough a similar holding was called a burgage tenement. Medieval law books derived the term from *socus*, ploughshare, and took it to denote primarily agricultural work. This is clearly a misconception. The term is derived from O. Eng. *soc*, which means primarily suit, but can also signify jurisdiction and a franchise district. Historically two principal periods may be distinguished in the evolution of the tenure. At the close of the Anglo-Saxon epoch we find a group of freemen differentiated from the ordinary ceorls because of their greater independence and better personal standing. They are classified as *sokemen* in opposition to the *villani* in Domesday Book, and are chiefly to be found in the Danelaw and in East Anglia. There can hardly be a doubt that previously most of the Saxon ceorls in other parts of England enjoyed a similar condition. In consequence of the Norman Conquest and of the formation of the common law the tenure was developed into the lowest form of freehold. Legal protection in the public courts for the tenure and services deemed certain, appear as its characteristic feature in contrast to villainage. Certainty and legal protection were so essential that even villain holdings were treated as *villain socage* when legal protection was obtainable for it, as was actually the case with the peasants on Ancient demesne who could sue their lords by the little writ of right and the *Monstraverunt*. The Old English origins of the tenure are still apparent even at this time in the shape of some of its incidents, especially in the absence of feudal wardship and marriage. Minors inheriting socage come under the guardianship not of the lord but of the nearest male relative not entitled to succession. An heiress in socage was free to contract marriage without the interference of the lord. Customs of succession were also peculiar in many cases of socage tenure, and the feudal rule of primogeniture was not generally enforced. Commutation, the enfranchisement of copyholds, and the abolition of military tenures in the reign of Charles II. led to a gradual absorption of socage in the general class of freehold tenures.

See Pollock and Maitland, *History of English Law*, i. 271 ff.; F. W. Maitland, *Domesday Book and Beyond*, 66 ff.; P. Vinogradoff, *Villainage in England*, 113 ff., 196 ff.; *English Society in the 11th Century*, 431 ff. (P. VI.)

SOCIAL CONTRACT, in political philosophy, a term applied to the theory of the origin of society associated chiefly with the names of Hobbes, Locke and Rousseau, though it can be traced back to the Greek Sophists. According to Hobbes (*Leviathan*), men lived originally in a state of nature in which there were no recognized criteria of right and wrong, no distinction of *meum* and *tuum*. Each person took for himself all that he could; man's life was "solitary, poor, nasty, brutish and short." The state of nature was therefore a state of war, which was ended by men agreeing to give their liberty into the hands of a sovereign, who thenceforward was absolute. Locke (*Treatise on Government*) differed from Hobbes in so far as he described the pre-social state as one of freedom, and held that private property must have been recognized, though there was no security. Rousseau (*Contrat social*) held that in the pre-social state man was unwarlike and even timid. Laws resulted from the combination of men who agreed for mutual protection to surrender individual freedom of action. Government must therefore rest on the consent of the governed, the *volonté générale*. Though it is quite obvious that the theory of a social contract (or compact,

as it is also called) contains a considerable element of truth—that loose associations for mutual protection preceded any elaborate idea or structure of law, and that government cannot be based exclusively on force—yet it is open to the equally obvious objection that the very idea of contract belongs to a more advanced stage in human development than the hypothesis itself demands. Thus the doctrine, yielding as a definite theory of the origin of society to the evidence of history and anthropology, becomes interesting primarily as revolt against medieval and theocratic theories of the state.

SOCIALISM, a term loosely formed from the Latin adjective *socialis* (*socius*, a comrade), and first used of certain doctrines of Robert Owen (*q.v.*). "Socialist" occurs in a discussion between Robert Owen and the Rev. J. H. Roebuck at Manchester (publ. Heywood, Manchester, 1837), pp. 27, 133. From the context it seems a nickname. But the title "Owenist" was disliked by many supporters (see *Co-operative Magazine*, 1826, p. 28) and "Co-operator" was acquiring a different sense. The new term was used in 1838 in France (by Pierre Leroux), and figures in 1840 in Reybaud's *Socialistes modernes*.

Definition.—Socialism is that policy or theory which aims at securing by the action of the central democratic authority a better distribution, and in due subordination thereunto a better production, of wealth than now prevails.

This definition may not entirely cover the ancient and medieval theories to which the name has been given by modern writers (see also ANARCHISM, COMMUNISM, CO-OPERATION). It hardly covers the schemes of Robert Owen himself. But just as chemistry is not alchemy, or astronomy astrology, modern socialism is not to be identified with Utopian fancies, and need not be so defined as to embrace them. For a like reason it need not be so defined as to include every tenet of leading socialistic writers. We must disentangle their socialism from what is superadded to it and not involved in the socialistic idea.

The word began in the days of Owen; but, as there were utilitarians before Mill made the name current, so there were socialists before Owen. Socialism, as a policy, begins with the beginnings of politics. As a theory, it begins whenever the state is perceived to have a distinct office from other factors in the order of society, and that office is so magnified that the whole or main charge of the economic resources of the people is assigned to the state, whether for production or for distribution. There was anarchism among the Cyrenaics and Cynics. Phaleas of Chalcedon was a communist. There is state socialism in the *Republic* of Plato, and much remains in the *Laws*. It is true that in those days society and state are not clearly distinguished. When Aristotle tells us that "man is by nature a political animal" (*Politics*, i. 1), the adjective is ambiguous. But the individual and the state are not confused; they are even, by the Cynics, too far separated.

State and individual were also well apart in Rome, under the Roman system of legal rights—public, private, real, and personal. There were socialistic measures in Rome, *panis et circenses*; and there were agrarian, to say nothing of usury laws. But trade and industry were not usually regarded as worthy subjects for the state and the statesman to touch at all. There are instances of municipal socialism in Italy and the provinces under the Roman Empire (S. Dill, *Roman Society from Nero to Marcus Aurelius*, 1905, pp. 218, 220, 222). In the middle ages feudalism was more akin to paternal government than to individualism; but it was, politically, too undemocratic to approach a true socialism. On its decadence something like a *de facto* municipal socialism made its appearance. The guilds of the great cities, *imperium in imperio*, regulated production and incidentally distribution. They did not prevent the existence of millionaires like the Fuggers, but they brought even these rich men under their rules. The equality was greater than the liberty, though neither was complete, to modern notions.

With the breaking up of the guilds came what is commonly called individualism. Thenceforward over against the controlling government of the monarch or the commonwealth was to stand the commercial competition of free individuals. It is one

of our modern problems to determine whether this individualism is doomed or not. It has never existed pure and unmixed. Between the time of the guilds and the time of the trade unions lies the time, say in England in the 16th and 17th centuries, when there were enterprising trade and busy industry, with enough of power surviving in the old organizations to prevent absolute anarchy. As invention followed invention in the 18th century, industry changed its form and became great instead of small. That is to say, it tended to become more and more an affair of large capital and large workshops, and, instead of the industrial individualism of small masters and independent "manufacturers," who were still "hand"-workers, there was appearing the industrial collectivism of the factory system, where manufacture was nothing without its machinery, its colossal division of labour and its strict technical discipline and drill. There was a short period in England when employers were allowed to draw advantage from the change without any hindrance from the state. But in no greater time than one generation the regulation of factories began, the period of anarchy ended, and the commercial competition of free individuals began to be surrounded with safeguards, more or less effective.

Modern socialism, as defined above, is (a) opposed to the policy of *laissez-faire*, which aims at the least possible interference with industrial competition between private persons or groups of persons, and (b) suspicious of a policy of mere regulation, which aims at close surveillance and control of the proceedings of industrial competitors, but would avoid direct initiative in production and direct attempts to level the inequalities of wealth. The leading idea of the socialist is to convert into general benefit what is now the gain of a few. He shares this idea with the anarchist, the positivist, the co-operator and other reformers; but, unlike them, to secure his end he would employ the compulsory powers of the sovereign state, or the powers of the municipality delegated by the sovereign. In the former case we have state socialism, in the latter municipal. Where there is direction or diversion of industry by the public force mainly for the benefit of a few, this is hardly socialism. It employs the same machinery, the public force; and it secures a revenue which may possibly be used for the general benefit, as in the case of protective duties. But in such cases the general benefit is only a possible incident. So far (for example) as protection succeeds in keeping out the foreign competitors, the main result is the assured gain or prevented loss of a few among the citizens. Socialism by intention and definition would secure benefits not for a few, a minority, or even a majority, but for all citizens. Communism has the same end in view; and socialism and communism (*q.v.*) are often confused in popular thought. But the communist need not be a socialist; he may be an anarchist, an opponent of all government; while the socialist need not be a communist. The socialists of the 20th century rarely, if ever, demand that all wealth be held *in common*, but only that the land, and the large workshops, and the materials and means of production on a large scale shall be owned *by the state*, or its delegate the municipality. The despotism of guilds would not now be tolerated. The strictest public regulation of trade and industry will probably continue to be that of the state, rather than of the municipality, for local rules can be evaded by migration, the state's only by emigration. But the smaller bodies are likely to display more adventurous initiative; and it is significant that they appear in the imagination nearer to the individual than the state even of a small people can ever appear to its own citizens. Yet it is not the smallest unit, the parish, that has shown most activity in England, but the county, a unit arithmetically nearer to the state than to the individual.

It might be plausibly argued that the movement of modern events has been rather towards a kind of anarchism (*q.v.*) than a kind of socialism, if it were not for the element of compulsion (quite contrary to anarchism). Even the English poor law, universally called socialistic, is administered locally and the degree of socialism varies with the parishes. When the state's regulation went further and further in a succession of Irish Land Acts (1870, 1881, 1903), it assumed a socialistic character; the

face of agricultural industry was transformed for the benefit of the majority, if hardly of the whole, by the action of the state. But the result has been a state-aided individualism. The attempt to transform all industries by protection has not been made by the English state in these days. It remains broadly true that, since the English state became more democratic (Reform Acts of 1832, 1867, 1884), its socialism has become more and more of the municipal character. The end in view having more to do with economics than with politics, it mattered little theoretically whether the power exercised was that of the central authority acting directly or the delegated power in the hands of the smaller public bodies.

This has been the course of events in England with little conscious theory or principle on the part of the people or even of its leaders. It is certainly a partial fulfilment of the aspirations of those whose theory or principle is socialism. The most important form of modern socialism, which may be called for convenience "social democratic" socialism, is founded on economic theory more or less clearly understood; it is therefore often described as economic or scientific socialism. Many men have become socialists less from logic than from sympathy with suffering. But modern socialism without disowning sentiment knows the need of facts and sound reasoning better than its predecessors, whom it calls Utopian. While among civilized peoples the suffering has on the whole grown less, the influence of socialism has grown greater; and this is largely owing to the efforts made by the best socialists to reason faithfully and collect facts honestly. The remarkable extension of socialism in Germany may be traced in great part to the special circumstances which have made social democracy the chief effective organizer of working men in that country. But modern socialism is not a purely German product. To scientific socialism England, France and Germany have all made contribution.

Its theoretical basis came, in two curiously different ways, from practical England. The idea that the underpaid labour of the poor is the main source of the wealth of the rich is to be found not only in Godwin and Owen but in the minor English land-reformers and revolutionary writers of the 18th and early 19th centuries, such as T. Spence, W. Ogilvie, T. Hodgskin, S. Read, W. Thompson. The positions of Ricardo that value is due to labour and that profits vary inversely as wages were taken by Marx (without Ricardo's modifications) as established doctrines of orthodox political economy. It was declared to be a scientific truth that under modern industrial conditions the "exploitation" of the labourer is inevitable. In the theory of rent the exploitation of the tenant by the landlord was already admitted by most economists. It was for the socialists to show that the salvation both of tenant and labourer lay in the hands of the central authority, acting as the socialists would have it act.

France had been prepared for socialism by St Simon and Fourier. The revolutions of 1830 and 1848, though on the whole unsuccessful in directly organizing labour, made socialistic ideas circulate widely in Europe. Men began to conceive of a political revolution which should be also a social revolution, or of a social and industrial revolution which should be also political. We may say broadly that the socialism of 1910 was either inspired by the ideas of that time or is coloured by them. Modern scientific socialism was thus about fifty years old towards the end of the first decade of the 20th century. It would have little claim to be scientific if it had undergone no change in that time; but the change was not greater than the change in orthodox economic doctrine, which indeed it had followed.

Its adherents may be classified (1) according to theory and (2) according to policy, though, as scientific socialism is really both theory and policy, being a political claim founded on an economic argument, the distinction is sometimes a matter of emphasis.

There are theorists who find the exploitation of the tenant by the landlord to be the main evil whether it involves the degradation of the labourer or not. As some theologians confine their criticism to the Old Testament, so Henry George and Professor A. Loria, shunning the name of socialist, would not

directly attack the system of modern large capitals but the appropriation of land. The social-democrat attacks both. He either takes Marx as guide, or, allowing Marx to be vulnerable, he stands on received economic doctrines with the addition of a political theory. He may himself rest content with the nationalizing of the means of production or he may tend towards communism.

In policy there is a difference between those scientific socialists who admit of no compromise with the existing order and the other scientific socialists who are willing to work with the existing order. The strictest sect would keep quite aloof from ordinary politics. The first step towards compromise is to allow the formation of a socialistic party in the legislature, bearing a protest against all other existing parties. This is the rule on the continent of Europe. The next step is to allow members of the party to be also members of other existing political parties; this is common in England and her colonies. The political history of scientific socialism is to a large extent the history of its attempts to avoid, to effect and to utilize the compromise.

There is, of course, a large body of socialists outside any organization. Partly from the teachings of socialists and partly from literary descriptions of the aims and reasons of socialism, there are multitudes who think socialistically without defining their own position with the exactness of the scientific socialist. It is often these amateurs who fall readily into Utopias and who confound the boundaries between socialism and communism. This is done for example by such writers as H. G. Wells and Upton Sinclair. The temptation is evident. The borderland between large production and small may be sometimes debatable; and, as soon as the socialistic nationalizing of large production is extended to small, the way is open to the Utopias of communism. Communism is an idea far more utopian than socialism. Like the idea of a kingdom of heaven or a millennium, it springs often from a spiritual enthusiasm that feels sure of its end and, at first at least, reckons little of the means.

The enthusiasm may spring from a real conversion of the sort described in the *Republic* of Plato (vii. 516). Even scientific socialism, depending theoretically on close adherence to economic principles, depends practically on this conversion. It is as with Christianity, which depends on its theology but also on its change of heart; till we have refuted both we have not refuted Christianity. So a change of heart, which is also a change of view, is to socialism, as a religion, what economic and political theory is to it as a creed. All that is best in anarchism shares this spiritual feature with socialism. It is of a higher type than the human sympathy which went with utopian socialism; it includes that sympathy and more. It requires a mental somersault of the kind taken by Hegel's metaphysician and (analogically) by Dante at the earth's centre. The observer begins to see the world of men all over again, throwing from him all the prejudice of his class and abstracting from all classes. This abstraction may be less hard for those who belong to a class that has little, than for those of a class that has much, as religious conversion is held to be easier for the poor. But it is not really easy for any. The observer tries to conceive what is at bottom the difference between rich and poor. Casuists can show that the line is a vanishing one, and that there are large groups of cases where the distinction is unsubstantial. Such borderlands are still the sporting ground of economists and philosophers and biologists. We could hardly contend, however, that no distinctions are true which break down at the border. It seems unsafe to say there is no war of classes, because at their nearest extremities the classes pass into each other. At the utmost we might infer that the best way to bring the war to an end was to crowd the nearest extremities. At present, taking the contrast not at its least or greatest but at its mean, we find it no fancy. The features that make the lower as distinguished from the higher are of different quality and kind, not merely of amount. They are described perhaps most fully by Tolstoy in *Que faire?*, but they are brought to the ken of every one of the rich who can overhear the daily talk of the poor,

enter into their daily cares and put himself in their place. If he makes the somersault and is "converted," all the little and great privileges of the rich seem now to have as many presumptions against them as were before in their favour. Why should he have so much comfort and they so little? why should he be secure when they live from hand to mouth? why should art and science and refinement be thrown in his own way and be hardly within their reach at all? Such and similar ponderings are not far from a revolt against inequality, whether the revolt takes the shape of anarchism or of socialism. It carries us beyond the paternal socialism of Carlyle and Ruskin or even of the author of *Sybil*, relying as Disraeli did on the "proud control" of the old English state, which was occasionally and spasmodically constructive as well as controlling, but was always actuated by a feeling like that of a chief to his clansmen. The exponents of paternal socialism have no clear consciousness of the change in the state itself. They think they can still use the old tools. They see that the people have changed, but they do not see that if the past cannot be revived for a people neither can it be revived for a state. The idea of lordship (as distinguished from leadership) is becoming intolerable; and this restiveness may contain a safeguard against one of the worst risks of socialism, bureaucracy. Before the governing bureaucracy had destroyed all originality and eccentricity, the sovereign people would have discovered for itself that "tyranny is a poor provider."

Great Britain.—In England a certain academic interest in socialism was created by Mill's discussions on the subject in his *Political Economy* (1848) and a more practical interest by the appearance of the Christian Socialists. "The red fool-fury of the Seine" caused prejudice even against such harmless enthusiasts. The People's Charter (in the 'thirties) had no socialistic element in it. Socialism first showed signs of becoming a popular movement in England after the lecturing tour of Henry George (1881-1882) in advocacy of the nationalizing of the land. About that very time (1880) the Democratic (afterwards in 1883 the Social Democratic) Federation was formed by advocates of the whole socialistic programme. A secession took place in 1884 when William Morris, H. M. Hyndman and Belfort Bax founded the Socialist League. William Morris parted company with the league in 1890, and seems to have become more anarchist than socialist. Edward Bellamy's *Looking Backward* (1887) made some impression among intellectual people in England; but Robert Blatchford's *Merrie England* (1894) made much more way amongst the multitude, followed up as it was by his newspaper the *Clarion*. There were still few signs of a strong party. The first members of the Fabian Society (1888) were by definition opportunists, and though the *Fabian Essays* (1889) were socialistic they were the declarations of men willing to use the ordinary political machinery and accept reforms in the present that might point to a socialistic solution in the very far distance. Most of the Fabians became hard-working radicals of the old type, with general approval. England does not love even the appearance of a revolution. Nevertheless a change has come over the spirit of English politics in the direction desired by socialists, though hardly through any efforts of theirs. The change was predicted by Herbert Spencer in 1860 (*Westm. Rev.* April) some years before household suffrage (1867). In *The Man versus the State* (1885) he demonstrates that liberal legislation which once meant the removal of obstacles now meant the coercion of the individual. Though a large part of the coercive measures enumerated by Spencer are rather regulation than socialism, undoubtedly there is here and there a socialistic provision. Thomas Hill Green's dictum, "It is the business of the State to maintain the conditions without which a free exercise of the human faculties is impossible" (*Liberal Legislation and Freedom of Contract*, 1881), did not in appearance go much further than Herbert Spencer's that "it is a vital requirement for society and for the individual to recognize and enforce the conditions to a normal social life" (*The Man versus the State*, p. 102); but the former saw clearly that the policy of the future must go beyond mere regulation. Too much importance has been attached to a saying of Sir William Harcourt in 1888,

"We are all Socialists now." He meant no more than that we are all social reformers who will use the aid of the state without scruple if it seems necessary. He did not mean that the English people had adopted a general principle of socialism. Except in the case of free trade, it is hard to discover a general principle in English politics. The English people judge each case on the merits, and as if no general principle ever affected the merits. Regulation and not initiative is the prevailing feature of the action of government even now. The railways are still in private hands. The state railways, canals and forests of India, though John Morley (afterwards Viscount Morley) "made a present of them to the Socialists" (House of Commons, 20th July 1906), are the public works of a modern benevolent despotism, and do not go very far beyond those of its ancient prototype. They are the works not of the Indian but of an alien democracy. Contrariwise, in England itself, possessed of a fair measure of self-government, crown lands, government dockyards, army, fleet, post office were in existence when there was no thought of state socialism; they are not modern innovations but time-honoured institutions.

The same is true of a great part of municipal socialism. It existed in the middle of the 19th century, and no local community would have been deterred from having its own water-supply or gas works by any fear of socialism. The fear is still less deterrent now; and we have seen electric lighting, tramways, parks, markets, ferries, light railways, baths and wash-houses, house property, river steamers, libraries, docks, oyster beds, held by towns like Glasgow, Birmingham, Manchester, Liverpool, Leeds, Bradford, Huddersfield, Colchester. Sometimes the management is economical, sometimes wasteful; but in all cases the undertakings have been supported by a majority who care little for general theory and everything for local interests. The "unity of administration" successfully advocated by Edwin Chadwick in the later Victorian period, and requiring "competition for the field but not in the field," is not inconsistent with municipal socialism. This last has been provided with new machinery by the establishment of county and district councils (1888), parish councils (1894) and even the perhaps-otherwise-intended metropolitan borough councils (1899). Till 1907, when the progressive party in the London County Council were heavily defeated, that council was certainly moving in the path of municipal socialism. But, in its achievements as distinguished from its claims, it had not overtaken, still less surpassed, Birmingham or Glasgow. Municipal socialism in Britain finds many critics; it has the drawbacks of all democratic self-government. It is sometimes wasteful; but it is seldom corrupt; and there is no general desire for a return to a less adventurous policy. In the country districts democracy is still imperfectly conscious of its own power. There are acts on the statute book that would well equip a parochial socialism; but socialists seem to be able to do little more than accelerate slightly what seems to be the inevitably slow pace of political reform in England. Whether the extension of the franchise to women will quicken the rate of reform is uncertain.

With every allowance, the change in English politics has been real, and it has been due in a great measure to the growth of organization among working men. The old trade unionism passed out of its dark ages by the aid of legislation (in 1871), which was for thirty years (till the Taff Vale decision in 1901, the older view being restored by the Trades Disputes Act 1906) considered to give to the trade unions the advantages of a corporation without the drawbacks. At the same time, through a better law of small partnerships (Industrial and Provident Societies Acts 1852, 1862, 1876), the co-operative societies were making rapid progress. Compulsory education (1870) increased the intelligence of the labouring classes and therewith their power to use their opportunities. Labour legislation, removing truck, making inspection and regulation of factories more stringent (see the consolidating Act of 1878 and the Factory and Workshop Act 1901) and providing compensation for accidents (1906), was forwarded by both political parties. This was not socialism but regulation. The old unionists were

radicals of the old type. Not so the unionists who came first into prominence with the Dock Strike in London in 1889. The way had been prepared by demonstrations of the unemployed in 1887 and 1888. When unionism embraced unskilled labourers, and at the same time pressed on the federation of all trades societies and their joint action, when, too, in the trade union congresses the intervention of the state was repeatedly claimed as essential to the success not only of an eight hours' day but of such socialistic measures as nationalization of the land, it was manifest that there was a new leaven working. The larger the numbers included in the trades societies the more their organization was bound to depart from that of the mass meeting, and to become indirect instead of direct self-government, government by representatives, and more and more by specially trained representatives. This was a tendency towards bureaucracy, or government by officials, not the highest type of popular government. A better preparation for democratic government has been given by the co-operative societies. If it be true that under a coming socialism the working class must dominate, then every phase of organization must be welcomed which widens their experience of self-government, more especially in the handling of industrial and commercial affairs. This last kind of education has been well given by co-operation, though chiefly through capital and hired labour on the old pattern of the ordinary employers. Co-partnership societies, best exemplified in the midland districts of England, are more democratic; but their numbers are few. The claims of the workman are somewhat in advance of his education. On the other hand it seems impossible in England to secure moderate concessions without extravagant claims.

Germany.—In Germany it was long an axiom that socialists must leave ordinary politics and political machinery severely alone as an evil thing. The short and futile struggle for constitutional liberty in 1848-1849 had driven most of those who were "thinking socialistically" into abandonment of political reform and into plans of fundamental change amounting to revolution. Karl Marlo (1810-1865) and K. J. Rodbertus (*q.v.*) contented themselves with laborious and profound studies not intended to bear immediate fruit in practice. Marx and Lassalle were not so pacific. The former was from the first (see his Manifesto of 1847) inclined to give socialism an international character, taking also no pains to distinguish it from communism. Lassalle desired it for his own nation first. Both of them were in a sense Hegelians. From Hegel they had learned that the world of men, like the world of things, was in constant process of development; but unlike Hegel they regarded human evolution as purely materialistic, effected always by a struggle between classes in society for the outward means of well-being. Feudalism, itself the result of such a struggle, had given place to the rule of the middle classes. The struggle to-day is between the middle classes and the working classes. At present those who do not possess capital are obliged to work for such wages as will keep them alive, and the gains from inventions and economics are secured by the employers and capitalists. The labourer works at his cost price, which is "the socially necessary wages of subsistence" (the bare necessities of a civilized life); but he produces much more than his cost, and the surplus due to his "unpaid labour" goes to the employer and capitalist. This is what Lassalle called the "brazen law of wages," founded on Ricardo's supposed doctrine that (a) the value of an article that is not a monopoly is determined by its cost in labour, and (b) the wages of labour tend to be simply the necessities of life. The tendency of the labouring population to increase beyond the means of steady employment is a frequent benefit to the capitalists in the periodic expansions of investment and enterprise, arising in response to new inventions and discoveries. Large business in modern economy swallows up small. Not only the independent artisans and workers in domestic industries, but the small capitalists and employers who cannot afford to introduce the economies and sell at the low prices of their large rivals are disappearing. But the growth of the proletariat, together with the concentration of business into fewer hands and larger companies, will cause the

downfall of the present system of industry. The proletariat will realize its own strength; and the means and materials of production will be concentrated finally into the hands of the commonwealth for the good of all. This revolution, like that which overturned feudalism, is simply the next stage of an evolution happening without human will, fatally and necessarily, by virtue of the conditions under which wealth is produced and shared in our times.

Such was in substance the view of all the German socialists of the last half of the 19th century. Even Rodbertus had advanced a claim of right on behalf of working men to the full produce of their labour, but thought the times not ripe for socialism. The others made no such reservations. Lassalle planned a centralized organization of workmen led by a dictator, and called on the government of Prussia to establish from the public funds co-operative associations such as his opponent Schulze-Delitzsch had hoped to plant by self help. His socialism was rather national than universal. Marx looked beyond his own nation. He founded the International Union of Working Men in 1864, the year of Lassalle's tragic death. Before the common danger of police prosecutions and persecution the followers of Lassalle and Marx were united at the congress of Gotha in 1875. The name social democrats had crept into use about 1869 when the followers of Marx founded at a congress in Eisenach the social democratic working men's party. The party began to be a power at the congress of Gotha. It is a power now, but its doctrines and policy have undergone some change.

The last quarter of the 19th century witnessed (1) the repressive laws of 1878, (2) their repeal in 1890, (3) the three Insurance Laws and (4) a quickened progress of German industry and wealth during thirty years of peace and consolidation.

Bismarck's government, alarmed by attempts on the life of the emperor and by the increased number of votes given to socialistic candidates for the reichstag, procured the passing of the Exceptional Powers Act (*Ausnahme Gesetz*) in 1878. The legislation at this time resembled the Six Acts of 1819 in England. Combined action and open utterance in Germany became almost impossible; and for organs of the press the social democrats had recourse to Zürich. Liebknecht and Bebel could still raise their voices for them in parliament, for Bismarck failed in his attempt to deprive members of their immunities (March 1879). But the agitation as a whole was driven underground; and it speaks well for the patience and self-control of the people that no widespread excesses followed. The declaration of the Social Democratic congress at Wyden, Switzerland, in 1880, that their aims should be furthered "by every means" instead of the old phrase "by every lawful means," was a natural rejoinder to the law that deprived them of the lawful means; and it seems to have had no evil consequences. In 1881 repression was so far relaxed that trade unions were allowed to recover legal standing. In 1890 the reichstag refused to renew the law of 1878 for a fifth period; and finally in 1899 it repealed the law forbidding the amalgamation of workmen's unions, and specially aimed at the new socialistic unions, the natural allies of the social democrats. The vexatious prosecutions and condemnations for *Majestätsbeleidigung* (*lese majesté*) following 1890 did the cause more good than harm. The socialistic voters increased from 437,438 in 1878 to 1,800,000 in 1894 and 2,120,000 in 1898, while the elected members increased from 12 in 1877 to 46 in 1894 and 56 in 1898. By 1903 the voters had increased to three millions and in the elections of February 1907 they were 3,240,000. The socialists, however, in 1907 found themselves represented by 43 members as against 79 in 1903. The reduced representation was due to a combination of the other parties against them, the matters at issue not being industrial policy, but colonial government and naval expenditure. The increase in the number of voters remains a proof that the power of the party in Germany has rather increased than diminished. In 1908 they gained seven seats in the Prussian Diet, where they had hitherto been unrepresented. Yet "remedial measures" had been passed which were intended to make socialism unnecessary. Bismarck, who admired Lassalle and had no scruples about the intervention of the state, had

planned a series of measures for the insurance of workmen against sickness, accidents and old age, measures duly carried out in 1883, 1884 and 1891, respectively. The socialists not unreasonably regarded the government as their convert. They could point to two other "unwilling witnesses," the Christian Socialists and the "Socialists of the Chair."

In the Protestant parts of Germany the socialists as a rule were social democrats, in the Catholic as a rule they were Christian Socialists. As early as 1863 and 1864 Dr Döllinger and Bishop Ketteler, followed by Canon Moufang, had represented socialistic sentiment and doctrine. Ketteler, who had been under the influence of Lassalle, had hopes that the church would make productive associations her special care. Moufang would have depended more on the state than on the church. All were awake to the evils of the workmen's position as described by the social democrats, and they were anxious that the Catholic church should not leave the cure of the evils to be effected without her assistance. Ketteler died in 1877; and the pope's encyclical of the 28th of December 1878 bore no trace of his influence, mixing up as it did socialists, nihilists and communists in one common condemnation. The encyclical *De conditione opificum* of 1891 might show that the views of the Christian Socialists had penetrated to headquarters; but the encyclical on Christian Democracy of 1901 (January) betrays no sympathy with them. The Protestant church in Germany has been hampered by fear of offending the government; but it contains a vigorous if tiny body of Christian Socialists. Rudolf Todt, a country pastor, was their prophet. His book on *Radical German Socialism and Christian Society* (1878) led Dr Stöcker, the court chaplain, to found an association for "Social Reform on Christian Principles." This was denounced rather unfairly by politicians of all ranks as an organized hypocrisy. Its influence was shortlived, and its successor, the "Social Monarchical Union" (1890), shared the unpopularity of Stöcker, its founder. Even the Socialists of the Chair, middle class Protestants as they were, would have nothing to say to it, but preferred to go a way of their own.

From the year 1858 there had existed a league of economists and statesmen called the "economic congress" (*Volkswirtschaftlicher Kongress*), a kind of English Cobden Club, though it aimed chiefly at free trade among all sections of the German people in particular. After the Empire its work seemed finished; and a new society was formed, the "Union for a Policy of Social Reform" (*Verein für Socialpolitik*). Professors G. Schmoller, W. Roscher, B. Hildebrand, A. Wagner, L. J. Brentano, the statistician E. Engel and others met at Halle in June 1872, and a meeting of their supporters followed at Eisenach in October of that year. These *Katheders-Socialisten* or Socialists of the Chair (academic socialists) agreed with the social democrats in recognizing the existence of a "social question," the problem how to make the labourers' condition better. To the old-fashioned economist this was no problem for the legislature; competition solved its own problems. But, while the social democrats looked for social revolution, the academic socialists were content to work for social reform, to be furthered by the state. The state was, to them, "a great moral institution for the education of the race." They were a company of moderate state socialists, relying on the state and the state as it then was. They did much gratuitous service to the government in the preliminary investigations preceding the great insurance laws.

The German people were made a little more inclined to state socialism than before by the efficiency displayed by the bureaucracy in the wars of 1866 and 1870. If the Insurance Laws are found to work well, this inclination may be confirmed, and the idea of a revolution may fall into the background. The attitude of the social democratic party became less uncompromising than in earlier days. Since they regained their liberty in 1890, their leaders have kept them well in hand. Their principal journal *Vorwärts* was conducted with great ability. Their agitation became as peaceful as that of trade unionists or co-operators in England. They ceased to denounce the churches. They tried to gain sympathy, quite fairly, by taking up the cause of any distressed workers, or even ill-used natives in colonies, and urging

redress from the state. The present state had become to them almost unconsciously their own state, a means of removing evils and not a mere evil to be removed. The anarchists had been disowned as early as 1880. The extreme socialists who demanded return to the old tactics were cast out at Erfurt in 1891, and became "Independent Socialists."

The controversy between friends and critics of socialism still rages in learned circles, producing a prodigious quantity of literature year by year; but the old strictures of Treitschke and Schäffle seem now to have lost a little of their point. Though the programme adopted at Gotha in 1875 was not entirely or even seriously altered, the parts of it due to Lassalle fell into the background. For many years Marx and not Lassalle was the great authority of the party. Marx died in 1883, but remained an oracle till 1894, when (just before his own death in 1895) Engels published the last volume of his friend's book on capital. The volume was expected to solve certain logical difficulties in the system. Instead of this, it caused a feeling of disappointment, even among true believers. Many, like Bebel and Kautsky, kept up the old adoration of Marx; but many, like Eduard Bernstein, rightly felt that to give up Marx is not to give up socialism, any more than to give up Genesis is to give up theology. Bernstein openly proposed in congress that the old doctrines and policy of the party, involving as they do the despair of reform and insistence on the need of revolution, should be dropped. He had not carried his point in 1908, but his influence seemed to be increasing. The death of Liebknecht (August 1900) removed from the ranks of the social democrats one of their most heroic figures, but also one of the strongest opponents of such a change of front. Yet Liebknecht himself had made concessions. It was impossible for a man of his shrewdness to close his eyes to what the state had done for the German workman. It was impossible, too, to ignore the progress that Germany had made in wealth and industry since the creation of the Empire in 1871. Germany has been fast becoming a manufacturing country; and, though the growth of large manufacturing towns in the Rhine valley and elsewhere has multiplied socialists, it has added to the income of the German workman. He is further from poverty and distress; and his socialism means an endeavour after a larger life, not, as formerly, a mere struggle against starvation. It is likely, therefore, to have less and less of mere blindness and violence in it.

The German socialists were chiefly interested in securing such an extension of the franchise in Prussia as would make their representation in the Prussian parliament correspond as near to the number of their adherents as in the Reichstag itself. They had only gained seven seats in the former in June 1908, though they had perhaps half a million of adherents in Prussia. They seemed for good or for evil to be taking the place of the old radical party. The position in Austria was somewhat different. The first general elections held under a really democratic suffrage (May 1907) resulted in the return of eighty social democrats and sixty Christian socialists to the Reichsrath, as compared with eleven and twenty-six in the unreformed parliament. They were opposed (as anti-clerical and clerical) on many questions, but they made it certain that economic and industrial policy affecting the whole nation would rival and perhaps out-rival the questions of racial supremacy and *haute politique* that absorbed the attention of the old Reichsrath.

France.—In France the socialists have found it harder to work in the parliamentary harness. Marx had said long ago that for the success of socialism besides English help there must be "the crowing of the Gallic cock." French enthusiasm for social revolution is feeble in the country districts but very strongly pronounced in the large towns. The *Communards* of 1871 might be called municipal socialists of a sort, but their light went out in that *année terrible*. Something like a movement towards organized socialism began in 1880 on the return of some prominent members of the old commune from exile. A congress was held at Havre under the leadership of J. Guesde and J. A. Ferroul; it adopted a "Collectivist" programme, *Collectivisme* meaning state socialism. A minority under J. F. E. Brousse and J. F. A.

Joffrin broke away (in 1881) from the main body and stood out for municipal socialism, decentralization and, later (1887), self-governing workshops aided by public money. Co-operative workshops are already subsidized in France from the public funds, and favoured by preferences in public works and other privileges, without striking results. The *Broussistes* are also called *Possibilistes*, as content with such socialism as is immediately practicable. They supported, for example, agrarian reform on the present basis of private property (Marseilles, 1892). After several unsuccessful negotiations, the amalgamation of the Collectivists, Possibilists and *Blanquistes* (extreme revolutionaries) was accomplished in 1899. But the body had not the cohesion of the German party. Though the socialists in the Chamber acted more or less loyally together, they were not closely controlled by the organization outside. In consequence (like Mr John Burns in England in 1905-1906) those who accepted office usually came under a cloud. This happened to M. Millerand when he became minister of commerce in the Waldeck Rousseau government of 1899, and in a less degree to M. Jaurès when he became vice-president of the Chamber. M. Millerand was, indeed, expelled from the party, and at the socialist congress of Amsterdam (August 1904) a strongly worded resolution condemned any participation by socialists in *bourgeois* (middle-class) government. The vote was not unanimous, and the resolution itself was attributed to the German Bebel. An attempt was made in Paris (April 1905) to bind the various parties of French socialists more closely together by forming a new "Socialist party, the French Section of the International Labour Union." It laid down stringent rules for the guidance of socialist deputies. In comparison with the steady united action of the Germans, the proceedings of the French socialists, perhaps from their greater political liberty, seems a wayward guerilla warfare. The French state is not on principle averse from intervention. It has been always more ready than in England to interfere with competitive trade and to take the initiative on itself. It controls the Bank of France, owns most of the railways, and directs secondary as well as primary education. After the disputes at Carmaux (in 1892) it proposed to take over the mines. There is no general poor law; but old-age pensions have been voted, and workmen's compensation is as old as 1888. State socialism might have gone farther if French bureaucracy had not proved less efficient than German.

Though there are socialistic French professors there can hardly be said to be a body of academic socialists in France. The strongest economic writing is still that of the orthodox economists, P. E. Levasseur, P. P. Leroy-Beaulieu, Yves Guyot. Even Professor Charles Gide, though reformer, is not socialist. Of the two party periodicals *La Revue socialiste* is moderate, *Le Mouvement socialiste* hardly so. The latter is in many ways more akin to anarchism than state socialism. Socialism has its allies in the sporadic Christian socialism of the Churches, both Catholic and Protestant, and in the solidarists who would transform the existing system of employment without abolishing private property. The school of Le Play, though devoted to social reform, can hardly be called an ally of socialism.

Netherlands.—Socialism has found a kindlier soil in Belgium and Holland, and these countries have been the favourite meeting-place in recent years of congresses of all denominations of socialists. In Belgium the Flemish social democratic party led by de Paepé united in 1879 with the Brabantine or Walloon. They organized trade unions. They helped the liberals in 1893 to procure the extension of the suffrage. In 1907 they had thirty representatives in parliament. The flourishing co-operative societies, *Vooruit* (Forwards) in Ghent and *Maison du peuple* of the Brussels bakers, were the work of their members. Its success in co-operation is almost the distinctive feature of Belgian socialism. Socialists helped to procure the adoption by Belgium of a system of old-age pensions for the poor in 1900, and of the cheap trains which do so much for the workmen in town and country. In Holland, which is not a crowded manufacturing country but even now largely agricultural and pastoral, the socialists are less formidable, if that be the right word. They

came into line with the German socialists in 1889. Social reform proceeds with or without their aid. There has been a factory act since 1889 and an act for workmen's insurance against accidents since 1900. Municipal socialism has made progress. The great railway strike of 1903 aroused public interest in the condition of the workman, but the legislation that followed was rather regulative than socialistic.

Switzerland.—Switzerland, for generations a refuge to exiles, shows them hospitality without sharing their views. There is little legislation of a socialistic nature; socialists are to be found here and there, especially in the German cantons.

Scandinavia.—Scandinavia stands less apart from European movements than formerly, but industrial legislation is rather regulative than socialistic. Hjalmar Branting, one of the most prominent socialists, was in 1908 a member of the Swedish parliament. The trade unions of Denmark are largely socialistic, but Denmark is no nearer complete conversion than England.

Italy, Spain.—Socialism might be thought to find a better soil in Italy and Spain. Italy has been described as "all proletarian." But a great depth of poverty fits a people rather for the anarchism of violence than for socialism. The social democrats have made way, notwithstanding, and in 1895 returned fifteen members to parliament. Milan is still the capital of the movement. Laveye had the idea that revolution was hopeless in Italy because Rome was uninhabitable every summer. But social democracy in Germany, its own country, is not bound up with Berlin. Italy as a whole must make progress in social and political development before it can receive the new ideas and still more before it can grow beyond them. The burden of taxes leads to revolts of sheer despair, followed by repression which has extended to socialistic clubs (*fasci dei lavoratori*) and even workmen's unions. State socialism in the form of state railways has not been very efficient. Factory legislation is behind that of other civilized countries, and is of very recent origin (1902). Old-age pensions were introduced in 1898, and accidents insurance on the German model in the same year. Municipal socialism, finding some trammels removed, had in the first decade of the 20th century begun to show itself in the large towns. In Spain there is a Socialist Federation; there are socialist newspapers; and there seems to be no doubt that the cause has gained ground, even as against anarchism. It may perhaps yet be a power in the legislature. It is mainly in Russia that anarchism has the field to itself.

Russia.—In spite of the hopes excited by the Duma, reformers in Russia have been strongly tempted to be anarchists, even of a violent type. Democracy had special difficulties in reaching legislative power. Partly for this reason, "social democracy" has had a subordinate place. The Russian socialists have, some of them, rebelled against the view once essential to socialistic orthodoxy: that Russia must pass through the stage of "capitalism" before reaching the stage of "collectivism." Marx himself (in 1877) conceded that the progress might be direct from the system of village communities to the ideal of social democracy. Capitalism is already extending itself, and the consistency of the theory need not have been broken. Even so, in the absence of democratic government, the prospects of socialism are doubtful. In Finland there were in 1908 eighty socialist members in a parliament of two hundred. The party might console itself by the thought that over the whole Russian empire many more were socialists than could declare themselves so.

Australia.—In contrast to nearly all the countries of "Old Europe," the self-governing colonies of Greater Britain stand out as nothing if not democratic. Nowhere is democracy sturdier than in Australia, the separate states of which have since 1900 been federated as one commonwealth. But while it has a protective tariff and makes no pretence of a *laissez-faire* policy, the central government is less socialistic than the separate confederated states. The progress even of these has been, as in England, rather in municipal than in state socialism. It is true that crown lands, mines and railways figure more largely. But to find state socialism in its vigour we must pass to New Zealand.

New Zealand.—Removed 1200 m. from Australia, its nearest civilized neighbour, secured by English naval power and "compassed by the inviolate sea," New Zealand is better suited for the experiment of a closed socialistic state than perhaps any other country in the known world. It began its new career in 1880-1890, too late for perfect success but not too late to secure a large measure of public ownership of what elsewhere becomes private property. It owns not only the railways but two-thirds of the whole land, letting it on long leases. It sets a limit to large estates. It levies a progressive income tax and land tax. It has a labour department, strict factory acts and a law of compulsory arbitration in labour disputes (1895). There are old-age pensions (1898), government insurance of life (1871) and against fire (1905). Women have the suffrage, and partly in consequence the restriction of the liquor traffic is severe. There is a protective tariff, and oriental labour is excluded. The success of the experiment is not yet beyond doubt; compulsory arbitration, for example, did not work with perfect smoothness, and was amended in 1908. But there has been no disaster. The decline of the birth-rate has been greater than in Britain. It is fair to add that the experiment is probably on too small a scale to show what might happen in larger countries. New Zealand has only 100,000 sq. m. of territory and about one million of inhabitants, mainly rural and of picked quality. The conditions of combined isolation and security are not easily obtained elsewhere. The action of the state has been in the great majority of instances rather regulative than constructive.

Canada.—This last feature is still more marked on the great North American continent. The Dominion of Canada, from its foundation by confederation in 1867, has given its land away too freely. The Dominion, indeed, has only had the land of new territories to dispose of; the original states are the owners of their own unsettled lands. The Dominion government owns the Intercolonial railway but contents itself with subsidies to the rest, over which it has a very imperfect control (by its Railway Commission). It levies royalties on Yukon gold, carries out public works, especially affecting the means of transport between province and province; and in theory whatever functions are not specially reserved to the provinces fall to the Dominion government. The provincial governments, however, show the greater activity. Ontario owns mines and railroads, Nova Scotia coal and iron fields. "The operation of public utilities" by the municipalities is encouraged. Over Canada with the rise of large towns there has been an advance of municipal socialism, not only in the largest, like Toronto, but in the newer and smaller, such as Port Arthur on Lake Superior, where half the local expenditure is paid by public works. Municipal socialism is still in advance of state socialism. Yet the Dominion has a democratic franchise, paid members, a labour department and free education. The democratic basis is not lacking; but the nature of the country is not such as to make it likely that Canada will lead the way in socialistic experiments. The protective tariff, by developing groups of manufacturing industries before their time, introduced into Canada some of the troublesome features of urban civilization in older countries. Accordingly trade unions became better organized. Trusts (like that of the grocers, 1908) began to show themselves. But socialistic propaganda was mainly confined to the mining districts, especially in the far west.

United States.—The great American republic would seem a better field for socialistic experiment, having more men, more states and ample political liberty. But state socialism, in the strict sense of the action of the central supreme authority, is limited by the Federal constitution, and any functions unassigned to the central authority by the constitution fall to the separate states. The separate states have rarely gone farther in a socialistic direction than England itself. In the way of restriction and regulation they have often done more (see Bryce, *Amer. Commonwealth*, part. v., chap. 95). From 1876 the separate states have had an admitted right to control undertakings having the nature of monopolies. The railways are in private hands;

and it was not until 1887 by the Interstate and Commerce Act (followed in 1888 by the Railway and Canals Act) that the Federal power secured control over the means of transport running beyond one state into another. In the same way the Anti-Trust Law of 1890 gave control over the great combinations for "forestalling and engrossing" the supply of articles of necessity or wide use. Socialists have regarded trusts as the stepping-stones to state socialism; but the American people would seem to prefer to see government controlling the trusts rather than itself displacing them.

Trade unionism has made better progress under the Federation of Labor than in the more ambitious Knights of Labor (1878). Like their English counterparts, the societies in the United States include numbers of socialists, and perhaps even more followers of Henry George in advocacy of the nationalization of the land and the "single tax." The death of Henry George (1897) has not ended his influence. On the other hand the socialists without compromise have had a "Socialistic Labor Party" since 1877. Bellamy's socialistic Utopia, *Looking Backward* (1888), caused nearly as great a sensation as Henry George's *Progress and Poverty* (1879). It led to the movement called "Nationalism," the scope of which was the nationalizing of the means of production generally. Of a less literary sort was the influence of "Populism" and the People's party (formed in 1889). Mixed up with the politics of W. J. Bryan in 1896, it lost a little of its uncompromising socialistic flavour.

General Criticisms.—If the ideal of state socialism be viewed in an equally critical spirit, many of the objections brought by the moderate anarchists are seen to have their weight. A strong central government to which all power was given over all the chief industries in the country would, they say, be contrary to liberty. Our leaders would be too likely to become again our masters. Supervision would become irksome. Great powers would be a temptation to abuse of power. A democracy with a strong central government would need to leave much to its chosen guardians, and to retain the same men in the position of guardians till they fully learned the difficult business of their office; but this in the end means either what we have now, a government by elected leaders, who, once elected, consult our wishes only on rare occasions,—or a government by permanent officials, which means liberty to go on in the old ways but great fear and jealousy of new ways, in fact, order without progress, no liberty of change.

This criticism becomes rather stronger than weaker if we press the doctrine of the supremacy of the working-classes, a doctrine that figures largely with some socialists. We are told that having been nothing, the working-classes will be everything; having so long been the ruled, they will be the rulers; they have produced for all the rest, the product will now be theirs instead of another's. This doctrine is not essential to socialism; it is indeed hardly consistent therewith. It would not be fair to press it, for no men know better than the scientific socialists that under modern conditions it is in most cases quite impossible to say what is the product of one man's labour. Articles are not made at one stretch by one individual. The contributions of the various hands and minds concerned from first to last in the production of a pocket-knife or a pair of trousers would travel over our stage like Banquo's ghostly descendants in a line that seemed to have no ending. What the socialists demand, when they are not declaiming to uncritical sympathizers, is not that a man should have what he makes but that what is made by great capitals or on great estates should be so distributed that it is not engrossed by individuals, but satisfies the wants of as many as possible. There is no superior enlightenment in the ordinary unskilled or even skilled manual labourer to fit him above others for supreme power. According to socialists and anarchists and indeed all of us who are not incurable optimists, the hungry generations have trodden the working man down too much to make him instantly or even speedily fit to do the work of government himself. He is of like passions with ourselves. He will be perfectly qualified in process of time to share in such responsible work. But at present he needs training.

The anarchists for their part do not desire the concentration of industry and the rule of it from the centre by anybody, working man or not—and they think the social democrats quite wrong in believing the concentration inevitable. They point to the fact that at the present moment there is a partial revival of domestic industries, assisted by gas and electricity. These are the small industries of people with small means; they make a less imposing figure before the public than the great trusts, such as the Steel Trust, and the Shipping Trust. The sums involved are so immense that it might seem impossible for competitors to cope with the trusts; therefore, it is thought, the trusts will soon rule alone, and, lest they should rule ill, the state should take their place. A great combination approaches monopoly, and a far-reaching, wide-stretching monopoly (say of the carrying trade) might mean a public danger. Should we listen to our friends the socialists and avert the danger by making the state the monopolist?

There seems no proof of the necessity of this extreme step. Where there is political danger the old-fashioned method of regulation and control by the state seems quite equal to the occasion. As yet the trusts are on their trial and their success is not certain, still less their abuse of the success when it comes. Their monopoly is not an absolute monopoly; and they have a wholesome consciousness of the possibility of competitors. A government trust would have none such. In some instances there would be the further difficulty that to prevent political friction it would need to be a trust of several nations—an idea difficult to realize on such a scale and in such matters.

The English mind does not turn readily to state trusts; but it finds no difficulty in municipal and local trusts. Private local monopolies, like those of the water companies in London, were as troublesome to the locality as any universal monopoly of the article could be; and the remedy which even London must find for the troubles will be the municipal trust. There are few instances in England of successful appropriation by the state of a business formerly competitive; railways are still only regulated. But there are so many examples of successful appropriation by the local authorities that the future absorption by them or the central authority of habitually unruly companies which have contrived in any way to abuse their monopoly may be deemed almost certain. The great demand of the scientific socialists is thus likely in England at least to break up into smaller separate demands that will obtain their answer separately by patient political action.

Socialism is making progress, but not to any great extent state socialism. New Zealand itself, where it has perhaps done most and best, is not a proof to the contrary, the province of Ontario in Canada having twice the area and population. Rather is it true that the state is more decidedly regulative. The ultimate result, to judge by the old countries, may be that each nation will include a community of groups more or less socialistic in organization, but will not itself be a socialistic state. The socialistic experiment is more likely to be tried by provinces than by states, by districts than by provinces, by towns than by districts. They all get their compulsory powers, as delegated to them, from the central authority; but the central authority itself has shown little power of originative action, and it lacks the minute knowledge of the people on the spot. The one or two great industries and businesses (railways, post office, telegraphs, forests, census, coinage, in some countries) that have formed the chief public works that are everybody's business and nobody's business, will probably remain a state concern; but the limits to the state's activity *except in regulation* soon arrive. On the other hand, there is no visible assignable limit to municipal or local socialism, as long as the state's parliament leaves it a free course. If the localities choose to make social experiments there seems no rule of general policy to prevent them, if we put aside experiences of financial failure or of the tendency to corruption. The great fear conjured up by the vision of socialism has been the fear of a new despotism. The despotisms of some hundreds of local bodies are likely to checkmate one another, or at least always likely by their varieties of pattern

to provide a means of escape for individuals unhappy under the rule of any one of them.

Anarchism, when at all rational, resolves the state into its component municipalities and small groups. The question which carries us beyond anarchism is how such groups can last and be secure without a central state. They could only be so on the assumption of a change in human nature of which their is no sign. It seems not improbable that in the far future the strong central government will be so democratic and at the same time so wise with the wisdom of a great representative council that all that is sound in the contentions and aspirations of anarchists and socialists will be secured by it. Before such a future arrives, we can best prepare for it by seeing to it whether in a new country or an old that our representative system represents us *at our best*. Our small councils and our great councils will not of themselves become cleaner for having larger powers. If they are not clean they are a public danger. If they are clean, the coming socialism, whatever be its precise complexion, need have no terrors. It too will represent the people at their best.

BIBLIOGRAPHY.—For the writings of Owen, Marx, &c., see under their names. For the general history see John Rae's *Contemporary Socialism*. For German socialism more particularly W. H. Dawson's *German Socialism and Ferdinand Lassalle*. See also *Karl Marx and the Close of his System*, by Böhm Bawerk (translated by Mrs J. M. Macdonald, 1898), *Der Verein für Socialpolitik und seine Wirksamkeit auf dem Gebiete der gewerblichen Arbeiterfrage*, by Dr E. Conrad (1906). For English recent developments, J. Ramsay Macdonald's *Socialism and Society*, and S. Ball's *Progress of Socialism in England*; also articles in *The Times* (London) during January 1909. For Australia and New Zealand, W. P. Reeves's *State Experiments in Australia and New Zealand* (1902). For the United States J. G. Brooks's *Social Unrest* (1903). For municipal socialism see Major Darwin's *Municipal Trade* (1903), and Dr F. C. Howe's *Municipal Ownership in Great Britain* (Bulletin of U.S. Bureau of Labor); also *Municipal and Private Operation of Public Utilities* (Report of National Civic Federation, New York, 1907) and *Municipal Corporations (Reproductive Undertakings)* (Return to House of Commons, 1902), 141 pages of statistics. On the nationalizing of railways see debate in House of Commons 11th February 1908; also the article *RAILWAYS: Economics*. For Italy, Bolton King's "Recent Social Legislation in Italy," *Economic Journal* (1903); and for France, J. L. Jaurès' *Histoire du socialisme*, and Ch. Gide's "Economic Literature in France," *Economic Journal* (1907). (J. B.)

SOCIAL SETTLEMENTS, associations of men and women of the educated classes who take up residence in the poorer quarters of great cities for the purpose of bringing culture, knowledge, harmless recreation, and especially personal influence to bear upon the poor in order to better and brighten their lives. Practically, the watchword of such settlements is personal service. To Arnold Toynbee (*q.v.*) may be given the credit of leading the way in this direction, and the Hall which Canon Barnett established (in 1885) to his memory in the east end of London was the first material embodiment of the movement. Since then many settlements of the same or similar nature have sprung up in Great Britain and America, some too on the continent of Europe and some in India and Japan. The sympathies of young men at the universities have been enlisted towards the movement, and an Oxford house, a Cambridge house, and other university missions have been founded in London. There are also many in connexion with various religious bodies. The practical spirit is shown in the formation of gilds, camps and institutes. Lads and girls, and even children, are gathered together; efforts being made to organize for them not only educational and religious opportunities, but harmless recreation, while the dwellers in the settlements share in the games and identify themselves most sympathetically with all the recreations. Many of the residents take also a considerable share in the work of local administration. Women's settlements probably are more general in the United States than in Great Britain; but in both countries they carry out a great variety of useful work, providing medical mission dispensaries, district nurses, workrooms for needle-women, hospitals for women and children, &c.

See W. Reason, *University and Social Settlements* (1898); S. Coit, *Neighbourhood Guilds* (1892); G. Montgomery, *Bibliography of College, Social, University and Church Settlements* (Boston, 1900).

SOCIETIES, LEARNED. Under ACADEMIES will be found a general account of the principal bodies of which that word forms part of the titles, usually denoting some kind of state support or patronage. But that account excludes a number of important scientific, archaeological, and literary societies, chiefly founded and carried on by private collective effort. Most of the institutions hereinafter mentioned are still flourishing. Fine art societies are not included.

In their modern form learned and literary societies have their origin in the Italian academies of the Renaissance: private scientific societies arose chiefly during the 19th century, being due to the necessity of increased organization of knowledge and the desire among scholars for a common ground to meet, compare results, and collect facts for future generalization. These bodies rapidly tend to increase in number and to become more and more specialized, and it has been necessary to systematize and co-ordinate their scattered work. Many efforts have been made from time to time to tabulate and analyse the literature published in their proceedings, as, for instance, in the *Repertorium* of Reuss (1801-1821) and the *Catalogue of Scientific Papers* of the Royal Society (1867-1902) for physics and natural science, with its subject indexes and the indexes of Walther (1845) and Koner (1852-1856) for German historical societies. A more recent example may be found in G. L. Gomme's *Index of Archaeological Papers* (1907). A further development of the work done by societies was made in 1822, when, chiefly owing to Humboldt, the *Gesellschaft deutscher Naturforscher und Ärzte* first met at Leipzig. This inauguration of the system of national congresses was followed in 1831 by the *British Association for the Advancement of Science*, which has served as the model for similar societies in France, America, Italy, Australia and South Africa. The merit of introducing the idea of migratory congresses into France is due to the distinguished archaeologist, M. Arcisse de Caumont (1802-1873), who established the *Association Normande*, which from 1845 held a reunion in one or other of the towns of the province for the discussion of matters relating to history, archaeology, science and agriculture, with local exhibitions. From the same initiation came the *Congrès Archéologique de France* (1834), which was organized by the *Société Française pour la Conservation des Monuments Historiques*, the *Congrès Scientifique*, which held its first meeting at Caen in 1833 (directed by the *Institut des Provinces*), and the *Congrès des Sociétés Savantes des Départements*, which for many years after 1850 held its annual sittings at Paris. The idea received the sanction of the French government in 1861, when a *Congrès des Sociétés Savantes* was first convoked at the Sorbonne by the minister of public instruction, who had in 1846 produced an *Annuaire des Sociétés Savantes*. In Italy Charles Bonaparte, prince of Canino, started an association with like objects, which held its first meeting at Pisa in 1839. Russia has had an itinerant gathering of naturalists since 1867. International meetings are a natural growth from national congresses. Two remarkable examples of these cosmopolitan societies are the *Congrès International d'Archéologie et d'Anthropologie Préhistoriques*, founded at Spezzia in 1865, and the *Congrès International des Orientalistes* (1873).

I. SCIENCE GENERALLY

UNITED KINGDOM.—First in antiquity and dignity among English societies comes the ROYAL SOCIETY (*q.v.*) of London, which dates from 1660. In 1683 William Molyneux, the author of *The Case of Ireland Stated*, exerted himself to form a society in Dublin after the pattern of that of London. In consequence of his efforts and labours the *Dublin Philosophical Society* was established in January 1684, with Sir William Petty as first president. The members subsequently acquired a botanic garden, a laboratory and a museum, and placed themselves in communication with the Royal Society of London. Their meetings after 1686 were few and irregular, and came to an end at the commencement of hostilities between James II. and William III. The society was reorganized in 1693 at Trinity College, Dublin, where meetings took place during several years. On 25th June 1731, chiefly owing to the exertions of Dr S. M. Madden, the *Dublin Society for Improving Husbandry, Manufactures, and other Useful Arts* came into existence. In January 1737 they commenced to publish the *Dublin Society's Weekly Observations*, and in 1746 the society was placed on the civil establishment, with an allowance of £500 a year from the government. A charter of incorporation was granted in 1750, and seven years later the

Royal Dublin Society for the first time owned a house of its own, and in the following year began the drawing school, which subsequently did so much for Irish art. Between 1761 and 1767 government grants to the amount of £42,000 for promoting national agriculture and manufactures were distributed by the society, which claims to be the oldest scientific body in the United Kingdom after the Royal Society of London. It has published *Transactions* (1799, &c.); and its *Proceedings* (1764-1775; 1848, &c.) and *Journal* (1856-1876, &c.) are still issued. The *Dublin Univ. Phil. Soc.* issues *Proceedings*. For the *Royal Irish Academy*, see ACADEMIES.

The *Royal Physical Society of Edinburgh* was instituted in 1771, and incorporated in 1788; it is exclusively devoted to natural history and the physical sciences. With it have been merged many other societies, such as the *Chirurgo-Medical* in 1796, the *American Physical* in 1796, the *Hibernian Medical* in 1799, the *Chemical* in 1803, the *Natural History* in 1812 (which brought in Brougham and Mackintosh) and the *Didactic* in 1813. It issues *Transactions* and *Proceedings* (1858, &c.). From the *Philosophical Society of Edinburgh* (1731) was developed the *Royal Society of Edinburgh*, whose charter is dated 29th March 1783. It was to comprise a physical and a literary class; among the members of the latter were Robertson, Hume, Burke and Reid, and among those of the former Hutton, Black, Playfair, Dugald Stewart and Watt. The literary division has been much less productive than the other. A second charter was obtained in 1811. The society has published *Transactions* (4to, 1788, &c.) and *Proceedings* (8vo, 1832, &c.). The *Royal Scottish Soc. of Arts* (1821) publishes *Transactions*.

The *Linnean Society* for the promotion of zoology and botany was founded in 1788 by Dr (afterwards Sir) J. E. Smith, in order to supplement the work of the Royal Society, and obtained a royal charter in 1802. The herbarium and collections of Linnaeus, with the founder's additions, were purchased after his death. It removed from Sir Joseph Banks's old house in Soho Square to Burlington House (London) in 1857, and assumed the apartments it now occupies in 1873. It has published *Proceedings* (1849, &c.). The *Journal* (8vo, 1856, &c.) and the *Transactions* (4to, 1791, &c.) are divided into zoological and botanical sections. The *Society for the Encouragement of Arts, Commerce, and Manufactures* took its origin in 1753 from an academy established in the Strand by the landscape painter William Shipley. Attention was paid to the application of science to practical purposes, a subject passed over by the Royal Society. Exhibitions of pictures by native artists were held, and the first exhibitions of the Royal Academy took place in its rooms. A fresh start in a new career was made by the *Society of Arts* (since 1909 known as the *Royal Society of Arts*) in 1847, when it obtained a charter and the presidency of the Prince Consort. The International Exhibition of 1851 sprang from the smaller exhibitions previously held in its rooms. The East Indian section dates from 1869, the foreign and colonial and the chemical sections from 1874. Its organs have been *Transactions* (1783-1849) and the *Journal* (1853, &c.). Sir Joseph Banks, Count Rumford and other fellows of the Royal Society started the *Royal Institution* in 1799, when a site was purchased in Albemarle Street for "an establishment in London for diffusing the knowledge of useful mechanical improvements," to "teach the application of science to the useful purposes of life." The institution was incorporated in the following year. One of the most important epochs in the history of chemistry must be dated from the establishment of the laboratory where Davy and Faraday pursued their investigations. Belonging to the institution are foundations for professorships in natural philosophy, chemistry and physiology. Courses of lectures on special subjects are given as well as discourses (once a week) of a more general and literary character. Its *Journal* has been issued since 1802. The *London Institution* was established on a similar basis in 1805 and incorporated in 1807. The building in Finsbury Circus was erected in 1819. The *British Association for the Advancement of Science* was instituted at York on 27th September 1831, an imitation of the itinerant scientific parliament held in Germany since 1822 (already referred to), and arose from a proposal by Sir D. Brewster. A meeting is held annually at some place in the British empire chosen at a previous meeting. The object of the association is to promote science, to direct general attention to scientific matters, and to facilitate intercourse between scientific workers. Abstracts of the proceedings and reports of committees are published in the annual *Report* (1833, &c.). The *Historical Society of Science* (1841) printed a couple of volumes; and the *Ray Society* (1844), instituted for the printing of original and scarce old works in zoology and botany, still flourishes. The *Royal Colonial Institute* was founded in 1868 and incorporated in 1882. It provides a place of meeting for gentlemen connected with the colonies and British India, undertakes investigations into subjects relating to the British empire, has established a museum and library, and gives lectures in its new building in Northumberland Avenue (London). It has published *Proceedings* since 1870. The *Victoria Institute*, or *Philosophical Society of Great Britain*, was founded in 1865 to form a connecting bond between men of science and others engaged in investigating important questions of philosophy and science, more especially those bearing upon the truths revealed in Holy Scripture. Its organ is the *Journal* (1867, &c.). The *Royal Asiatic Society* and the *East India Association* (1866) publish *Journals*. The *African Society* meets at the Imperial Institute and publishes a

Journal. The *Selborne Soc.* (1885) promotes nature study and issues a *Mag.* The foundation in 1821 of the *Society for the Encouragement of the Useful Arts in Scotland*, now usually known as the *Royal Scottish Society of Arts*, for the promotion of the useful arts and such branches of science as bear upon them, was due to Sir D. Brewster, Sir J. Mackintosh and others; it was incorporated in 1841, and has published *Transactions* since that year.

The leading provincial societies of Great Britain of a general character are as follows:—*Aberdeen, Nat. Hist. Soc.* (1863), *Trans.*; *Phil. Soc.* (1840). *Alloa, Soc. of Nat. Hist. and Arch.* (1863), *Proc.* (1865, &c.). *Banff, Banffshire Field Club and Sc. Soc.* (1880), *Proc.* *Bath, Nat. Hist. and Antiq. Field Club* (1866), *Proc.* (1867, &c.); *Roy. Lit. and Sc. Inst.* (1825), *Proc.*; *Bath Lit. and Phil. Assn.* *Bedford, Bedfordshire Nat. Hist. Soc.* (1875), *Trans.* *Belfast, Nat. Hist. and Phil. Soc.* (1821), *Proc.* (1852, &c.), museum; *Naturalists' Field Club* (1863), *Proc.* (1875, &c.). *Berwickshire Naturalists' Club* (1831), *Proc.* (1834, &c.). *Birkenhead, Lit. and Sc. Soc.* (1857). *Birmingham, Nat. Hist. and Phil. Soc.* (1858), *Trans.*; *Birmingham and Midland Institute Sc. Soc.* (1870), *Trans.* of archaeological section (1871, &c.); *Phil. Soc.* (1876) has a fund for promotion of original research, *Proc.*; *Midland Union of Nat. Hist. Societies* (1877), *Midland Naturalist*. *Bolton, Lit. and Phil. Soc.* (1871). *Bradford, Phil. Soc.* (1865); *Bradford Scientific Assn.* (1875), *Journal*. *Brighton, Brighton and Hove Nat. Hist. and Phil. Soc.* (1855), *Proc.* *Bristol, Naturalists' Soc.* (1862), *Proc.* (1866, &c.). *Burnley, Lit. and Sc. Club* (1873), *Trans.* *Burton-on-Trent, Nat. Hist. and Arch. Soc.* (1876), *Trans.* *Cambridge, Phil. Soc.* (1819; incorporated 1832), for the promotion of philosophy and natural science, owns museum and library, *Proc.* (1843, &c.), *Trans.* (1821, &c.). *Cardiff, Naturalists' Soc.* (1867), *Trans.* *Chester, Soc. of Nat. Sc., Lit. and Arts* (1871). *Cork, Royal Inst.* (1807), library; *Cuvierian and Arch. Soc.* (1836). *Cornwall Royal Inst.*, at Truro (1818), devoted to natural philosophy, natural history, and antiquities, *Journal* (1864, &c.); *Royal Cornwall Polytechnic Soc.*, at Falmouth (1833; founded by the daughters of R. W. Fox and others), for the encouragement of science and the fine and industrial arts, *Trans.* (1835, &c.). *Cumberland Assoc. for the Advancement of Lit. and Sc.* (1876), provided a means of union for the local societies of Cumberland and Westmoreland, *Trans.* *Derbyshire Arch. and Nat. Hist. Soc.* (1878), *Journal*. *Derry Nat. Hist. and Phil. Soc.* (1870). *Devonshire Assoc. for the Advancement of Sc.* (1862). *Dorset Nat. Hist. and Antiq. Field Club* (1875), *Proc.* *Dumfriesshire and Galloway Sc., Nat. Hist. and Antiq. Soc.* (1876), *Trans.* *Dundee, Naturalists' Soc.* (1873). *Eastbourne, Nat. Hist. Soc.* (1867), *Proc.* (1869, &c.). *East of Scotland Union of Naturalists' Societies* (1884), *Trans.* *Ebbw Vale, Lit. and Sc. Inst.* (1850). *Elgin, Elgin and Morayshire Lit. and Sc. Assoc.* (1836). *Essex Field Club* (1880), museums at Stratford and Chingford. *Exeter, Naturalists' Club and Arch. Assoc.* (1862). *Glasgow, Roy. Phil. Soc.* (1802), *Proc.* (1844, &c.); *Nat. Hist. Soc.* (1851), *Proc.* (1868, &c.); *Soc. of Field Naturalists* (1872), *Trans.* (1872, &c.); *Andersonian Naturalists' Soc.* *Gloucester, Lit. and Sc. Assoc.* (1838). *Greenock, Phil. Soc.* (1861). *Halifax, Phil. and Lit. Soc.* (1830), museum and library. *Hereford, Woolhope Naturalists' Field Club, Hereford Pomona and Trans.* (1866, &c.). *Hertfordshire Nat. Hist. Soc. and Field Club*, formed in 1879 from the *Watford Nat. Hist. Soc.* (1875), *Trans.* *High Wycombe, Nat. Hist. Soc.* (1865), *Magazine* (1866, &c.). *Hull, Lit. and Phil. Soc.* (1822), *Trans.* (1824, &c.). *Inverness, Sc. Soc. and Field Club* (1875). *Isle of Wight Phil. and Sc. Soc.* (1850). *Kent (East) Nat. Hist. Soc.* at Canterbury (1858), *Trans.* *Leeds, Phil. and Lit. Soc.* (1820); *Naturalists' Club* (1870), *Trans.* *Leicester, Lit. and Phil. Soc.* (1835), *Trans.* *Lewes, Lewes and East Sussex Nat. Hist. Soc.* (1864). *Liverpool, Lit. and Phil. Soc.* (1812; united with *Nat. Hist. Soc.* in 1844), *Proc.* (1845, &c.); *Philomathic Soc.* (1825), *Trans.*; *Polytechnic Soc.* (1838), *Journal* (1838, &c.); *Naturalists' Field Club* (1860). *Manchester, Lit. and Phil. Soc.* (1781), two sections, one physical and mathematical, the other for microscopy and natural history—the original statements respecting the atomic theory were given by Dalton in the *Memoirs* (1789, &c.), also *Proc.*; *Field Naturalists' and Arch. Soc.* (1860), *Proc.*; *Scientific Students' Assoc.* (1861). *Montrose, Nat. Hist. and Antiq. Soc.* (1836), museum. *Newbury, District Field Club* (1870), *Trans.* (1871, &c.). *Newcastle-on-Tyne, Lit. and Phil. Soc.* (1793), library; *Northumberland, Durham and Newcastle Nat. Hist. Soc.* (1829), a museum (opened in 1884), *Trans.* *Norfolk, Norfolk and Norwich Naturalists' Soc.* (1869), *Trans.* (1870, &c.). *Nottingham, Lit. and Phil. Soc.* (1864); *Naturalists' Soc.* (1852), *Trans.* *Orkney Antiq. and Nat. Hist. Soc.* (1837), museum. *Oxford, Ashmolean Nat. Hist. Soc.* (1828), *Proc.* *Paisley, Phil. Institution* (1808), free library and museum; Mr Coats presented his observatory in 1882. *Penzance, Nat. Hist. and Antiq. Soc.* (1839), museum, *Proc.* (1845, &c.). *Perth, Lit. and Antiq. Soc.* (1784); *Pertshire Soc. of Nat. Sc.* (1867), *Proc.* (1869, &c.), the *Scottish Naturalist* (1870, &c.). *Peterhead, Buchan Field Club* (1887), *Trans.* *Plymouth, Plymouth Inst. and Devon and Cornwall Nat. Hist. Soc.* (1812), museum, art gallery and library. *Preston Sc. Soc.*, affiliated with *British Assn.* *Richmond, Richmond and North Riding Naturalists' Field Club* (1863), *Trans.* *Ripon, Naturalists' Club and Sc. Assoc.* (1882). *Rochdale Lit. and Sc. Soc.*, *Trans.* *Scarborough, Phil. and Arch. Soc.* (1831), museum and library. *Severn Valley Naturalists' Field Club*, at Bridgenorth (1863). *Sheffield, Lit. and Phil. Soc.* (1822); *Museums Assoc.* (1889), *Proc. and Journ.* *Shelland*

Lit. and Sc. Soc. at Lerwick (1861). *Shropshire and North Wales Nat. Hist. and Antiq. Soc.* (1835), at Shrewsbury. *Somersetshire Arch. and Nat. Hist. Soc.*, at Taunton (1849), *Proc.* (1851, &c.). *Southampton, Hartley Institution* (founded under bequest of H. R. Hartley in 1859, incorporated 1862), for the promotion of scientific, antiquarian and Oriental studies and the fine arts, owns a museum and library. *Staffordshire (North) Field Club and Arch. Soc.* (founded as a natural history society in 1865; enlarged 1877), meets at Stone, *Trans.* *Stirling, Nat. Hist. and Arch. Soc.* (1878), *Trans.* *Stockport, Soc. of Naturalists* (1884), *Trans.* *Suffolk Inst. of Arch. and Nat. Hist.*, at Bury St Edmunds (1848), *Proc.* (1848, &c.), *The East Anglian* (1859, &c.). *Swansea, Royal Institution of South Wales* (founded 1835; incorporated 1883), with a museum and library, promotes natural history and applied science, literature and fine arts, local history and antiquities. *Tamworth, Nat. Hist., Geolog. and Antiq. Soc.* (1871). *Teign Naturalists' Field Club* (1858). *Torquay, Nat. Hist. Soc.* (1844), museum and library. *Tweedside and Kelso Physical and Antiq. Soc.* (1834). *Warrington, Lit. and Phil. Soc.* (founded in 1870 upon the *Micr. Soc.*). *Warwickshire Nat. Hist. and Arch. Soc.* (1836); *Warwickshire Field Club* (1854). *Whitby, Lit. and Phil. Soc.* (1822). *Whitehaven Sc. Assn., Journal.* *Wiltshire Arch. and Nat. Hist. Soc.*, at Devizes (1853), *Wiltshire Magazine* (1853, &c.). *Windsor, Windsor and Eton Sc. Soc., Trans.* *Witney, Nat. Hist. and Lit. Soc.* (1858). *Yorkshire Phil. Soc.* (1822), the museum in the grounds of St Mary's Abbey, York, contains a remarkable collection of Roman remains; *Naturalists' Union* of the natural history and scientific societies of the county (founded in 1861 as the *West Riding Consolidated Naturalists' Soc.*, reorganized in 1876), publishes the *Naturalist* (1876, &c.), *Trans.*

AUSTRALIA and NEW ZEALAND: *Adelaide, Phil. Soc., Trans.* (1865, &c.); *South Australian Inst.* (1836), library; *Roy. Soc. of S. Australia* (1853), *Trans., Reports.* *Auckland, Auckland Inst.* *Brisbane, Queensland Phil. Soc.* (1860), now the *Roy. Soc. of Queensland* (1884), *Proc.* *Christchurch, Phil. Inst.* *Hobart Town, Roy. Soc. of Tasmania, Papers and Proc.* (1843, &c.). *Melbourne, Roy. Soc. of Victoria, Trans. and Proc.* (1854, &c.); *Nat. Hist. Soc.*; *Zool. and Acclim. Soc., Proc.* (1872, &c.). *Sydney, Roy. Soc. of N.S. Wales* (1821), *Proc.* (1867, &c.); *Linnean Soc. of N.S. Wales* (1874), *Proc.* (1875, &c.); *Phil. Soc., Trans.* (1862, &c.); *Australasian Assoc. for Advancement of Sc., Reports of Annual Meetings* (held at different place each year) (1888, &c.). *Wellington, New Zealand Inst., Trans. and Proc.* (1868, &c.).

CANADA: *Halifax, Nova Scotia Inst. of Sc., Proc. and Trans.* (1862, &c.). *Montreal, Nat. Hist. Soc. of Montreal* (1827), *Canadian Rec. of Sc.* *Ottawa, Roy. Soc. of Canada, Trans.* (3 ser.) (1882, &c.); *Lit. and Sc. Soc.* (1870), *Trans.* (1897, &c.). *St John, Nat. Hist. Soc. of N. Bruns.* (1862), *Bulletins* (26 vols.). *Toronto, Canadian Inst.* (1849), *Trans. and Proc.* (1852, &c.); *Roy. Canadian Acad. of Arts* (1880). *Winnipeg, Hist. and Sc. Soc.*

SOUTH AFRICA: *Cape Town, South Afr. Phil. Soc., Trans.* (1878, &c.).

WEST INDIES: *Kingston, Roy. Soc. of Arts of Jamaica, Trans.* (1854, &c.); *Port of Spain, Sc. Assoc. of Trinidad, Proc.* (1866, &c.).

INDIA, &c.: *Calcutta, Asiatic Soc. of Bengal* (1784), *Journal* (1832, &c.; 1865, &c.), *Bibl. Indica* (1848, &c.), *Mem.* (1905, &c.). *Singapore, Roy. Asiatic Soc. (Straus Br.), Journal* (1880, &c.). *Shanghai, Roy. Asiatic Soc. (N. China Br.), Journal* (1857, &c.). *Cairo, Inst. Egyptien* (1859). *Mauritius, Roy. Soc. of Arts and Sc., Proc.* (1846, &c.) and *Trans.* (1848, &c.).

UNITED STATES.—The Smithsonian Institution (*q.v.*), the most important scientific body in America, is dealt with in a separate article. The first scientific society in the United States originated from a *Proposal for Promoting Useful Knowledge among the British Plantations*, issued by Dr Franklin in 1743. In the following year the *American Philosophical Society* was founded at Philadelphia, with Thomas Hopkinson as president and Franklin as secretary. With it was united on 2nd January 1769 another Philadelphia society, *The Junto* (1758), the records of which have been preserved. The *American Philosophical Society* is still in vigorous life, and is an exclusively scientific body and the oldest organized society in the United States for the pursuit of philosophical investigation in its broadest sense. It publishes *Transactions* (4to, 1771, &c.) and *Proceedings* (8vo, 1838, &c.). Second in point of date comes the *American Academy of Arts and Sciences* of Boston, incorporated in 1780 with the object of furthering the study of the antiquities and natural history of the country. Its *Memoirs* (4to, 1785, &c.) and *Proceedings* (8vo, 1846, &c.) are still published. The *Connecticut Academy of Arts and Sciences* was incorporated at New Haven in 1799. At first only devoted to matters connected with the state of Connecticut, it now embraces the whole field of the sciences and useful arts. It has issued *Memoirs* (1810–1816), and now publishes *Transactions* (1866, &c.). One of the leading societies in the United States, the *Academy of Natural Sciences* of Philadelphia, founded in 1812 and incorporated in 1817, possesses an excellent library; the natural history museum is especially rich in conchology. It issues a *Journal* (1817, &c.) and *Proceedings* (1843, &c.). The *American Entomological Society* is merged with it. The *Franklin Institute* of the same city, incorporated in 1825, possesses a library, gives lectures and issues a *Journal* (1826, &c.). The *Boston Society of Natural History* was founded upon the *Linnean Society* (1814) in 1830 and incorporated

in 1831. It possesses a library and a cabinet of specimens. It has published the *Boston Journal of Natural History* (8vo, 1837-1863), *Memoirs* (4to, 1866, &c.) and *Proceedings* (1841, &c.). The *Lyceum of Natural History*, New York, was incorporated in 1818 and has published *Annals* from 1823 (1824, &c.) and *Proceedings* (1870, &c.). In 1875 the name was changed to *New York Academy of Sciences*. A number of American naturalists and geologists, having held meetings in various cities between 1840 and 1847, resolved themselves at their Boston congress in the latter year into the *American Association for the Advancement of Science*, which was incorporated in 1874. Its object is "by periodical and migratory meetings to promote intercourse between American scientists." It has published *Proceedings* (1849, &c.). The *National Academy of Sciences* was incorporated at Washington in 1863 with a view to making the knowledge of specialists available for the service of government. There are two classes of members, those in mathematics and physics and those in natural history. It has issued *Annals* (Cambridge, 1865, &c.) and *Reports*, as well as *Memoirs* (1866, &c.). The *Academies of Sciences* at San Francisco (1853), St Louis (1856, incorporated 1857), and Chicago (1857, incorporated 1865) deserve special mention.

Among the remaining societies of a general scientific character are—*Albany Inst.* (1829), *Trans.* (1830-1893), *Proc.* (1873-1882). Ann Arbor, *Mich. Ac. of Sc.* (1894). Baltimore, *Maryland Acad. of Sc.*, *Trans.* (1901). Boston, *Col. Soc. of Mass.* (1892), *Trans.* *Brooklyn Inst. of Arts and Sc.* Buffalo, *Soc. of Nat. Sc.* (1861), *Bull.* *Cincinnati*, *Soc. of Nat. Hist.* (1870), *Journal* (1878, &c.); *Cin. Museum Assoc.* (1881). Cleveland, *Acad. of Nat. Sc.* (1852), *Annals and Proc.*; *The Cleveland Society* [Archaeol. Inst. of America] (1895). Columbus, *Ohio State Acad. of Sc.* (1891), *Publ.* Des Moines, *Iowa Inst. of Sc. and Arts*, *Trans.* Hartford, *Soc. of Sc.* (1896); formerly *Hartford Soc. of Nat. Sc.* (1885), *Bull.* (1902, &c.). Indianapolis, *Indiana Acad. of Sc.* (1885), *Proc.* (1891, &c.). Ithaca, *Amer. Phil. Assoc.* (1902). Lincoln, *Nebraska Acad. of Sc.* (1891), *Publ.* Los Angeles, *South California Acad. of Sc.* (1891), *Bull.* Madison, *Wisconsin Acad. of Sc. Arts and Letters*, *Trans.* (1870, &c.). Milwaukee, *Wisconsin Nat. Hist. Soc.* (1857), *Bull.* Minneapolis, *Minnesota Acad. of Sc.*, *Bull.* (1873, &c.). Minneapolis, *Acad. of Fine Arts* (1883), *Bull.* (1905). New Orleans, *Athenæe Louisianais* (1876), *Comptes Rendus*. New York, *Amer. Inst. of the City of New York* (1829), *Journal* (1834), *Trans.* (1841, &c.); *Amer. Inst. for Sc. Research* (1904), *Proc.* and *Journal*. Portland (Maine), *Soc. of Nat. Hist.* (1850), *Proc.* (1862, &c.). Poughkeepsie, *Vassar, Brothers' Inst.* (1874), *Proc.* (1874, &c., 1876, &c.). Rochester, *Acad. of Nat. Sc.* (1881) *Trans.* Salem (Mass.), *Essex County Nat. Hist. Soc.* (1833; now merged in the *Essex Institute*) published the *American Naturalist* (1867-1868), afterwards issued by the *Peabody Acad. of Science*, as well as *Proc.* (1856, &c.) and *Bulletin* (1869, &c.). San Francisco, *Tech. Soc. of the Pacific Coast* (1884), *Trans.* in *Journal of the Assoc. of Engineering Societies*. Santa Barbara, *Society of Natural History* (1876), *Bull.* (1887). Sioux City, *Acad. of Sc. and Letters* (1887), *Proc.* (1903, &c.). Topeka, *Kansas Acad. of Science* (1868), *Trans.* Washington, *Phil. Soc. of Washington* (1871), *Bull.* (1874, &c.). Wilkes-Barré, *Wyoming Hist. and Geol. Soc.* (1858), *Proc. and Coll.*

FRANCE.—The *Institut de France* (see ACADEMIES), which includes five separate academies, stands at the head of all French societies. The *Société Philotechnique*, founded in 1795 and recognized as of public usefulness by a decree of 11th May 1861, had for its object the encouragement and study of literature, science and the fine arts; literary organ was an *Annuaire* (1840, &c.). The *Société d'Encouragement pour l'Industrie Nationale* was founded in 1801 for the amelioration of all branches of French industry, and was recognized by the state in 1824; *Bulletin*. The *Académie Nationale, Agricole, Manufacturière, Commerciale* was founded by the duc de Montmorency in 1830, and offers prizes and medals, and brings out a *Bulletin* (1830, &c.). The *Association Française pour l'Avancement des Sciences* (1872), founded on the model of the British Association, holds migratory meetings and publishes *Comptes rendus*. With it has been amalgamated the *Association Scientifique de France*, founded by Le Verrier in 1864.

The departmental societies are very numerous and active. The chief are the following: Abbeville, *Soc. d'Émulation* (1797), *Mém.* (1833, &c.). Agen, *Soc. d'Agr., Sc. et Arts* (1784), *Recueil* (1800, &c.). Aix, *Acad. des Sc., &c.* (1829), based on *Soc. des Amis de la Sc.* (1765), *Mém.* (1819, &c.). Alais, *Soc. Sc. et Litt.* (1868), *Bull.* (1868, &c.). Amiens, *Acad.*, based on *Soc. Litt.* (1750), *Mém.* (1835, &c.); *Soc. Linnéenne* (1838), *Mém.* (1866, &c.). Angers, *Soc. Acad. de Maine-et-Loire* (1857), *Mém.* (1857, &c.); *Soc. d'Agr., &c.* (1799), *Mém.* (1831, &c.); *Soc. Linn. de M.-et-L.* (1852), *Annales* (1853, &c.). Angoulême, *Soc. d'Agr., &c.*, de la Charente (1803), *Annales* (1819, &c.). Annecy, *Soc. Florimontane* (1851), *Annales* (1851, &c.) and *Rev. Savoisienne* (1851). Apt, *Soc. Litt., Sc. et Art.* (1863), *Annales* (1865, &c.). Arras, *Acad.* (1737), *Mém.* (1818, &c.) and other publications. Autun, *Soc. Éduenne* (1836), *Mém.* (1872, &c.) and other publications. Auxerre, *Soc. des Sc.* (1847), *Bull.* (1847, &c.). Avignon, *Acad. de Vaucluse* (formerly the *Lycée d'Agr., &c.*, 1801), *Mém.* (1804), *Documents and Cartulaires*. Bar-le-Duc, *Soc. des Lettres, &c.* (1870), *Mém.* (1871, &c.). Bayeux, *Soc. des Sc., Arts et B.-Lett.* (1841),

Mém. (1842, &c.). Beauvais, *Soc. Acad.* (1847), *Mém.* (1847, &c.), *Comptes Rendus* (1882, &c.). Belfort, *Soc. d'Émulation* (1872), *Bull.* (1872). Besançon, *Acad. des Sc., &c.* (1752; suppressed in 1793; re-established 1805), *Proc. verb.* (1754, &c.), *Mém.* (1838, &c.); *Soc. d'Émulation* (1840), *Mém.* (1841, &c.). Béziers, *Soc. Arch., Sc., &c.* (1834), *Bull.* (1836, &c.). Blois, *Soc. des Sc. et Lettres de Loir-et-Cher* (1832), *Mém.* (1833, &c.). Bordeaux, *Acad.* (1712; suppressed 1793; re-established 1816), *Actes* (1839, &c.); *Soc. Linn.* (1818), *Bull.* (1826-1829) and *Actes* (1830, &c.); *Soc. des Sc.* (1850), *Mém.* (1855, &c.). Boulogne, *Soc. Acad.* (1864), *Mém.* (1864, &c.). Bourg, *Soc. d'Émulation* (1755), *Journal* (1817-1868) and *Annales* (1868, &c.). Bourges, *Soc. Hist., &c., du Cher* (1849), *Mém.* (1857, &c.). Brive la Gaillarde, *Soc. Sc., Hist. et Archéol.* (1878), *Bull.* (1879, &c.). Caen, *Acad.* (1652), *Rec.* (1731-1816), *Mém.* (1825); *Soc. Linn.* (1823), *Mém.* (1824, &c.), and *Bull.* (1855, &c.); *Assoc. Normande* (1831), *Annuaire* (1835, &c.). Cahors, *Soc. des Études Litt., Sc. et Artistiques* (1872), *Bull.* (1873, &c.). Cambrai, *Soc. d'Émulation* (1804), *Mém.* (1808, &c.). Cannes, *Soc. des Sc.* (1868), *Mém.* (1869, &c.). Carcassonne, *Soc. d'Études, &c.* (1889), *Bull.* (1890, &c.). Chambéry, *Acad.* (1819), *Mém.* (1825, &c.). Châteaudun, *Soc. Dunoise* (1864), *Bull.* (1864, &c.). Cherbourg, *Soc. Acad.* (1755), *Mém.* (1833, &c.); *Soc. Nat.* (1851), *Mém.* (1852, &c.). Clermont-Ferrand, *Acad.* (1747), *Annales* (1828, &c.) and *Bull.* (1881, &c.). Dijon, *Acad.* (1725; suppressed 1793; re-established 1800), *Mém.* (1769, &c.). Douai, *Soc. d'Agr., &c., du Nord* (1799), *Mém.* (1826, &c.). Draguignan, *Soc. d'Études Sc.* (1855), *Bull.* (1856, &c.). Dunkirk, *Soc. Dunkerquoise* (1851), *Mém.* (1853, &c.). Épinal, *Soc. d'Émulation* (1825), *Journal* (1825-1827), *Sciences* (1828-1830), *Annales* (1828, &c.), *Évreux, Soc. Libre d'Agr., &c.* (1798), *Recueil*. Gap, *Soc. d'Études* (1881), *Bull.* (1882, &c.). Grenoble, *Acad. Delphinale* (1789), based on *Soc. Litt.* (1772), *Bull.* (1836, &c.). Havre, *Soc. d'Études Diverses* (1833), *Recueil* (1834, &c.). Laon, *Soc. Acad.* (1850), *Bull.* (1852, &c.). La Roche, *Soc. d'Émulation* (1854), *Annuaire* (1855, &c.). La Rochelle, *Acad.* (1732; suppressed 1791; reconstituted in 1803 as *Lycée Rochelais* and in 1853 under its former name), *Annales* (1854, &c.). Le Havre, *Soc. des Sc. et Arts* (1868), *Bull.* (1868, &c.). Le Mans, *Soc. d'Agr., &c., de la Sarthe* (founded in 1761; reorganized on several occasions, and finally in 1839), *Bull.* (1833, &c.). Le Puy, *Soc. d'Agr., Sc., &c.* (1819), *Annales* (1826, &c.) and *Bull.* (1836, &c.). Lille, *Soc. des Sc., &c.* (founded 1802 as *Soc. d'Amateurs*), *Mém.* (1802, &c.); *Soc. d'Études*, *Bull.* (1809). Limoges, *Soc. d'Agr., Sc., &c., de la Haute-Vienne* (1759), *Bull.* (1822, &c.). Lons-le-Saunier, *Soc. d'Émulation* (1817), *Mém.* (1818, &c.). Lyons, *Acad.* (1724), *Mém.* (1854, &c.); *Soc. d'Agr., Hist. Nat., &c.* (1761), *Comptes rend.* (1806, &c.) and *Mém.* (1838, &c.); *Soc. Linn.* (1822), *Annales* (1836, &c.). Mâcon, *Acad.* (1805), *Comptes rend.* (1806-1847) and *Annales* (1851, &c.). Marseilles, *Acad.* (1726; in 1766 called *Soc. des Sciences*; suppressed in 1793; reorganized in 1799, and finally in 1802), *Recueil* (1727-1786) and *Mém.* (1803, &c.). Meaux, *Soc. Libre d'Agr., Sc., &c.* (1798; reorganized in 1820), *Publ.* (1833, &c.). Mende, *Soc. d'Agr., &c., de la Lozère* (1819), *Mém.* (1827, &c.) and *Bull.* (1850, &c.). Montauban, *Acad.* (1730), *Recueil* (1742-1750) and 1869, &c.). Montbéliard, *Soc. d'Ém.* (1850), *Mém.* (1852, &c.). Montpellier, *Acad.* (founded in 1706 as *Soc. Royale*; suppressed in 1793; finally reorganized in 1846), *Mém.* (1847, &c.); *Soc. d'Horticult., &c., de l'Hérault* (1860), *Annales* (1860, &c.). Moulins, *Soc. d'Ém.* (1846), *Bull.* (1846, &c.). Nancy, *Acad. de Stanislas* (1750), *Mém.* (1754, &c.); *Soc. des Sc.* (1873), founded on *Soc. des Sc. Nat. de Strasbourg* (1828), *Mém.* (1830, &c.) and *Bull.* (1866, &c.); *Soc. d'Archéol., &c.* (1848), *Mém.* (1849, &c.), *Journal* (1852, &c.). Nantes, *Soc. Acad. de la Loire-Inf.* (1848), founded in 1798 as *Institut Départemental*, *Annales* (1830, &c.). Nevers, *Soc. Nivernaise* (1851), *Bull.* (1851, &c.). Nice, *Soc. des Lettres, &c.* (1861), *Annales* (1865, &c.). Nîmes, *Acad.* (1682), *Mém.* (1305); *Soc. d'Étude des Sc. Nat.* (1871), *Bull.* (1873, &c.). Niort, *Soc. de Statist. Sc., &c., des Deux-Sèvres* (1836), *Mém.* (1836, &c.) and *Bull.* (1852, &c.). Orleans, *Acad. de Sainte-Croix* (1863), *Lect. et Mém.* (1865, &c.); *Soc. d'Agr., Sc., &c.* (1809), *Bull.* (1810-1813), *Ann.* (1818-1837), and *Mém.* (1837, &c.). Pau, *Soc. des Sc., Lettres, &c.* (1841), *Bull.* (1841, &c.). Périgueux, *Soc. d'Agr., Sc., &c., de la Dordogne* (1820), *Annales* (1840, &c.). Perpignan, *Soc. Agr., &c. et Litt.* (1833), *Bull.* (1834, &c.). Poitiers, *Soc. d'Agr., Belles-Lettres, &c.* (1789), *Bull.* (1818, &c.). Privas, *Soc. des Sc. Nat. et Hist.* (1861), *Bull.* (1861, &c.). Reims, *Acad. Nat.* (1841), *Séances* (1844, &c.). Rochefort, *Soc. de Géog. Lettres, Sc. et Arts* (1878), *Bull.* (1879, &c.). Rodez, *Soc. des Lettres, Sc., &c., de l'Aveyron* (1836), *Mém.* (1838, &c.) and *Procès-Verb.* (1864, &c.). Rouen, *Acad.* (1744), *Précis Analyt.* (1744, &c.); *Soc. Libre d'Émulation, &c.* (1790), *Bull.* (1797, &c.); *Soc. des Amis des Sc. Nat.* (1864), *Bull.* (1865, &c.). Saint-Brieuc, *Soc. d'Ém., Bull. et Mém.* (1861, &c.). Saint-Dié, *Soc. Philomatique* (1875), *Bull.* (1876, &c.). Saint-Étienne, *Soc. d'Agr., &c., de la Loire* (1822), *Annales* (1857). Saint-Lo, *Soc. d'Agr., &c.* (1833), *Mém., &c.* (1837, &c.). Saint-Quentin, *Soc. Acad.* (1825), *Mém.* (1830, &c.). Semur, *Soc. des Sc. Hist. et Nat.* (1842), *Bull.* (1864, &c.). Soissons, *Soc. Arch., Hist. et Sc.* (1846), *Mém.* (1847, &c.). Tarbes, *Soc. Acad. des Hautes-Pyrénées* (1853), *Bull.* (1854, &c.). Toulon, *Soc. Acad. du Var* (1811), *Mém.* (1832, &c.). Toulouse, *Acad.* (founded in 1640; known to 1704 as *Soc. des Lanternistes* and by other names to 1807, when present title was acquired), *Hist. et Mém.* (1782-1790) and *Mém.* (1827, &c.); *Soc. d'Hist. Nat.* (1866), *Bull.* (1867, &c.); *Soc. des Sc.*, (1872), *Bull.* (1872, &c.). Tours, *Soc.*

- d'Agr., &c., d'Indre-et-Loire* (founded in 1761 as *Soc. Roy. d'Agr.*), *Recueil* (1763 and 1803-1810) and *Annales* (1821, &c.). Troyes, *Soc. Acad.*, based on *Soc. Acad. de l'Aube* (1798), *Mém.* (1801, &c.). Valenciennes, *Soc. d'Agr., Sc. et Arts* (1831), *Mém.* (1833, &c.; 1865, &c.) and *Revue Agricole* (1849, &c.). Vannes, *Soc. Poly-mathique du Morbihan* (1826), *Proc.-verb.* (1827, &c.) and *Bull.* (1857, &c.). Vendôme, *Soc. Arch., Sc. et Litt.* (1862), *Bull.* (1862, &c.). Verdun, *Soc. Philomath.* (1822), *Mém.* (1840). Versailles, *Soc. d'Agr. et des Arts* (1798), *Mém.* (1799-1864) and *Bull.* (1866, &c.); *Soc. des Sc. Nat. et Méd.* (1832), *Mém.* (1835, &c.); *Soc. des Sc. morales, &c.* (1798), *Mém.* (1847-1897), *Revue* (1899, &c.). Vesoul, *Soc. d'Agr., &c., de la Haute-Saône* (1801; reorganized in 1819 and 1832), *Recueil Agronom.* (1836, &c.), *Mém.* (1859, &c.), and *Bull.* (1869, &c.). Vitry-le-François, *Soc. des Sc. et Arts* (1861), *Bull.* (1867, &c.). Constantine (Algeria), *Soc. Archéol.* (1852), *Annuaire et Recueil* (1853, &c.).
- GERMANY AND AUSTRIA-HUNGARY.—Agram, *Jugo-slavenska Akademija or South Slav. Acad.* (1866), various publications; *Croatian Nat. Hist. Soc.* (1885). Altenburg, *Naturforsch. Ges. d. Osterlandes* (1817), *Mittheil.* Augsburg, *Naturforsch. Ver.* (1846), *Ber.* (1848, &c.). Bamberg, *Naturforsch. Ges.* (1834), *Ber.* (1852, &c.). Berlin, *Ges. naturf. Freunde* (1773), *Sitzungsber.* (1860, &c.); *Deutsch-asiatische Ges.* (1902), *Zeitschrift.* Blankenburg, *Naturwiss. Ver. des Harzes* (1831), *Ber.* (1841, &c.). Bonn, *Naturh.-Verein* (1843), *Verhandl.* (1844, &c.); *Görres Ges.* (1876), *Hist. Jahrbüch.* (1879, &c.); *Niederrhein. Ges.* (1818, reorganized, 1839). Bremen, *Naturwiss. Ver.* (1864), *Abhandl.* (1868, &c.). Breslau, *Schles. Ges. f. vaterl. Kultur* (1803), *Jahresber.* (1804, &c.). Bromberg, *Deutsche Ges. f. Kunst u. Wiss.* (1902) with 7 sections, *Jahresber.* (1902, &c.). Brünn, *K. k. Mähr.-Schles. Ges., Mittheil.* (1821, &c.). Budapest, *K. Magyar Természettudományi Társulat or Roy. Hung. Soc. of Nat. Sciences* (1841), many publications, monthly proceedings of zoological, chemical and botanical sections. Cassel, *Ver. f. Naturkund., Jahresber.* (1837, &c.). Colmar, *Soc. d'Hist. Nat.* (1859), *Bull.* (1860, &c.). Cracow, *Towarzystwo Naukowe*, afterwards *Akademia Umiejetnosci or Acad. of Science* (1815), with several sections each publishing proceedings; the Acad. issues a *Bulletin* (1873, &c.). Danzig, *Naturforsch. Ges., Versuche* (1745-1757) and *Schriften* (1820, &c.); *Bot.-zoolog. Ver.* (1878). Donaueschingen, *Ver. f. Gesch. u. Naturgesch.* (1801), *Schriften.* Dresden, *Naturwiss. Ges. Isis* (1833), *Sitzungsber.* (1861, &c.); *Ges. f. Natur-u. Heilkunde* (1818), *Jahresber.* (1848, &c.); *Ges. f. Botanik u. Zoologie, Nunquam Otiosus* (1870, &c.). Dürkheim, *Pollichio, Naturwiss. Ver., Jahresber.* (1843, &c.). Elberfeld, *Naturwiss. Ver., Jahresber.* (1851, &c.). Emden, *Naturforsch. Ges.* (1814), *Jahresber.* (1837, &c.). Erfurt, *Kgl. Pr. Akad. gemeinnütz. Wiss., Acta* (1757, &c.), *Abhandl.* (1860, &c.). Frankfurt, *Seckenbergische naturforsch. Ges.* (1817), *Museum* (1834-1845) and *Abhandl.* (1854, &c.). Freiburg (in Baden), *Naturforsch. Ges.* (1821), *Ber.* (1858, &c.). Fulda, *Ver. f. Naturkunde* (1865), *Ber.* (1870, &c.). Giessen, *Oberhess. Ges. f. Natur- und Heilkunde* (1833), *Ber.* (1847, &c.). Görlitz, *Oberlausitzer Ges. d. Wiss.* (1779), *Magazin* (1822); *Naturforsch. Ges.* (1811), *Abhandl.* (1827, &c.). Gorz, *Soc. Imp. Reale, Mem.* Göttingen, *K. Ges. d. Wissensch.* (1751, 1893), *Gött. gelehrte Anzeigen, Abhandl.* (1845, &c.) and *Nachr.* (1845, &c.). Gratz, *Naturwiss. Ver. Mittheil.* (1863, &c.). Greifswald, *Naturwiss. Ver. von Neu-Vorpommern, Mittheil.* (1869, &c.). Halle, *Naturf. Ges.* (1779), *Abhandl.* (1853, &c.); *Naturwiss. Ver.* (1848), *Zeitschrift* (1853, &c.). Hamburg, *Naturwiss. Ver.* (1837), *Abhandl.* (1846, &c.). Hanau, *Wetterauische Ges.* (1808), *Jahresber.* (1852, &c.). Heidelberg, *Naturhist.-med. Ver., Verhandl.* (1857, &c.); *Akad. der Wiss. Stiftung H. Lantz* (1909). Hermannstadt, *Siebenbürgisch. med. Ver. f. Naturwiss., Verhandl.* (1849, &c.). Innsbruck, *Ferdinandeam, Beiträge* (1825-1834) and *Neue Zeitschrift* (1835, &c.). Jena, *K. Leopold.-Carol. Akad. Athenaeum* (1875, &c.); *K. Leopold.-Carol. D. Akad. d. Naturf., Leopoldina* (1859, &c.); *Med.-naturwiss. Ges. Jen., Zeitsch.* (1864, &c.). Karlsruhe, *Naturwiss. Ver.* (1863), *Verhandl.* (1864, &c.). Klausenburg, *Siebenbürg. Museum, Annalen.* Leipzig, *Ges. Deut. Naturforscher u. Ärzte* (1822), *Tageblatt* (1836, &c.), *Verhandl.*; *K. Sächs. Ges. d. Wiss.* (1846), *Ber.* (1846, &c.) and *Abhandl.* (1850, &c.); *Deutsche morgenländ. Ges.* (1845), *Zeitschrift* (1847, &c.), *Abhandl.* (1857, &c.). Lemberg, *Ges. v. Galizien, Ber. Lüneburg, Naturwiss. Ver., Jahresber.* (1852, &c.). Magdeburg, *Naturwiss. Ver., Abhandl.* (1869, &c.). Mainz, *Rhein. naturforsch. Ges.* (1834). Mannheim, *Ver. f. Naturk., Jahresber.* (1834, &c.). Marburg, *Ges. z. Beförderung der gesammten Naturwiss.*, founded in 1816 as *Kurhessische Akademie, Schriften* (1823, &c.) and *Sitzungsber.* (1866, &c.). Meissen, *Ver. f. Erdk., Isis* (1845). Metz, *Acad.*, based on *Soc. des Lettres, &c.* (1819), *Mém.* (1828, &c.); *Soc. d'Hist. Nat., Mém.* (1843) and *Bull.* (1844, &c.). Munich, *Münchener Orient. Ges.* (1901), *Beiträge.* Nuremberg, *Naturhist. Ges.* (1801), *Abhandl.* (1852, &c.), *Mittheilungen;* *Naturhist. Ges.* (1801), *Mittheil.* and *Abhandl.* Posen, *Deutsche Ges. f. Kunst. u. Wiss.* (1901). Prague, *K. Böhm. Ges.* (1770, 1784) consists of two classes, receives a state subsidy, *Abhandl.* (1785, &c.) and *Sitzungsber.* (1859, &c.); *Naturhist. Ver. Lotos, Lotos* (1851, &c.); *Ges. zur Förderung deutscher Wiss., Kunst. u. Lit. in Böhmen* (1891), state subsidy and many private bequests, *Mittheil.* and other publications. Pressburg, *Ver. f. Naturk., Verhandl.* (1856, &c.). Ratisbon, *Zoolog.-mineralog. Ver.* (1846, since 1883 called *Naturwiss. Ver.*), *Abhandl.* (1849, &c.). Reichenbach (Voigtland, Saxony), *Ver. f. Naturk.* (1859), *Mittheil.* Rostock, *Verein f. Freunde der Naturgeschichte* (1847), *Archiv.* Roveredo, *J.R. Acad.*
- (1750), *Atti* (1826, &c.). Strassburg, *Soc. des Sc. Agr. et Arts* (1802), *Mém.* (1811, &c.) and *Bull.* (1843, &c.); *Wissenschaftl. Ges.* (1906), *Schriften* (1906, &c.). Stuttgart, *Ver. f. vaterl. Naturk.* (1845), *Jahresber.* (1850, &c.). Thorn, *Copernicus Ver.* (1854). Trieste, *Soc. Adriatica, Boll.* Ulm, *Ver. f. Mathem. u. Naturwiss.* (1865), *Verhandl.* Vienna, *K. k. Zoolog.-bot. Ges., Verhandl.* (1851, &c.); *Verein z. Verb. Naturwiss. Kenntnisse, Schriften* (1862, &c.). Wiesbaden, *Nassauischer Ver. f. Naturk.* (1829), *Jahrbücher* (1844, &c.). Zweibrücken, *Naturhist. Ver.* (1863), *Jahresber.* (1864, &c.).
- SWITZERLAND.—Basel, *Naturforsch. Ges.* (1817), *Ber.* (1835, &c.) and *Verhandl.* (1835, &c.). Bern, *Soc. Helvétique des Sciences Nat.* (1815), *Actes* (1816, &c.), *Comptes rendus* (1879), *Mémoires* (1829, &c.). Chur, *Naturforsch. Ges., Jahresber.* (1856, &c.). Geneva, *Soc. de Phys. et d'Hist. Nat., Mém.* (1821, &c.); *Société des Arts* (Athénée), founded by H. B. de Saussure in 1776; *Institut National genevois* (1853), *Mém. and Bull.* Lausanne, *Soc. Vaudoise des Sc. Nat., Bull.* (1842, &c.). Neuchâtel, *Soc. des Sc. Nat., Mém.* (1835, &c.) and *Bull.* (1844, &c.). St Gall, *Naturwiss. Ges., Ber.* (1860, &c.). Solothurn, *Naturhist. Kantonal-Ges., Jahresber.* (1825, &c.). Zurich, *Naturforsch. Ges.* (1746), *Abhandl.* (1761-1856), *Mittheil.* (1846, &c.), and *Vierteljahrsschr.* (1856, &c.); *Allg. Schweizer Ges. f. d. Naturwiss., Verhandl., Anzeiger, and Denkschr.* (1829, &c.).
- ITALY.—Congresso degli Scienziati Italiani, *Atti* (1844-1845); *Riunione degli Sc. Ital., Atti* (1839-1847; 1873, &c.). Bologna, *Accad. delle Sc. dell' Ist. di Bologna* (1714), *Rendic.* (1833, &c.), and *Mem.* (1850, &c.). Brescia, *Accad., afterwards Ateneo, Comment.* (1808, &c.). Catania, *Accad. Gioenia di Sc. Nat., Atti* (1825, &c.). Florence, *R. Museo di Fis. e Stor. Nat., Annali* (1808, &c.); *Soc. Asiatica Italiana* (1886), *Giornale.* Lucca, *R. Accad. Lucchese* (1584), *Atti* (1821, &c.). Messina, *R. Accad. Peloritana.* Milan, *Accad. Fis. Med. Statist., Diario ed Atti* (1846, &c.); *R. Ist. Lombardo, Mem.* (1819, &c.), *Giornale* (1840, &c.), *Atti* (1860, &c.), and *Rendic.* (1864, &c.); *Soc. Ital. delle Sc. Nat., Atti* (1860, &c.) and *Mem.* (1865, &c.). Modena, *R. Accad. di Sc., &c., Mem.* (1833, &c.); *Soc. Ital. delle Sc., Mem.* (1782, &c.). Naples, *R. Ist. d'Incoragg. alle Sc. Nat.* (1806), *Atti* (1811, &c.); *Soc. Reale di Napoli* (1808), consists of three sectional academies. Padua, *R. Accad. di Sc., Lett., ed Arti* (1779), *Saggi* (1786, &c.) and *Revista* (1851, &c.). Palermo, *R. Accad. di Scienze* (1722). Rome, *Soc. Ital. per il progresso delle Scienze* (1907). Venice, *R. Ist. Veneto di Sc.* (1838), *Atti* (1841, &c.) and *Mem.* (1843, &c.); *Ateneo Veneto*, two sections, literature and science. Verona, *Accad. d'Agricoltura, Scienze, Lettere, Arti e Commercio* (1768), *Atti and Memorie.*
- BELGIUM.—Brussels, *Soc. Roy. des Sc. Nat. et Méd.* (1822), *Journ. de Méd.* (1842-1895) and *Annales* (1892, &c.); *Soc. Roy. Linn.* (1835), *Bull.* (1872, &c.); *Soc. scientifique de Bruxelles* (1875), *Revue* (1877, &c.), *Annales* (1877, &c.). Ghent, *K. Vlaamische Acad.* (1886). Liège, *Soc. Roy. des Sc.* (1835), *Mém.* (1843, &c.). Mons, *Soc. Prov. des Sc., &c., du Hainaut* (1833), *Mém.* (1839, &c.).
- HOLLAND.—Amsterdam, *K. Nederlandsch Instituut, Proc.-verb.* (1808, &c.), *Verhandel.* (1812, &c.), *Tijdschrift* (1847); *Genootschap ter Beford. der Natuur-, &c., Kunde, Maanblad* (1807, &c.) and *Werken* (1870, &c.); *Hollandische Maatschappij, Werken* (1810, &c.); *Maatschappij ter Befordering van het Natuurkundig onderzoek der Nederl. Kolonien* (1890), branches in Batavia and Paramaribo, *Notulen, Bulletins, &c.* Arnheim, *Natuurkundig Genootschap, Tijdschrift* (1844, &c.). Bois-le-Duc, *Provinc. Genootschap, Handelings* (1837, &c.). Groningen, *Natuurk. Genootschap, Versl.* (1862, &c.). Haarlem, *Hollandische Maatschappij der Wetensch.* (1752), *Verhandel.* (1754, &c.). The Hague, *K. Zoolog.-Botanisch Genootschap, Versl.* (1864, &c.). Luxembourg, *Soc. des Sc. Nat., Publ.* (1853, &c.). Middelburg, *Zeeuwisch Genootschap der Wetensch., Verhandl.* (1769, &c.) and *Archief* (1856, &c.). Utrecht, *Provinc. Genootschap van Kunsten en Wetensch.* (1773), *Verhandel.* (1781, &c.) and *Aanteekeningen* (1845, &c.) promotes the study of medicine, natural history, law and literature. Batavia, *Bataviaasch Genootschap van Kunsten en Wetensch.* (1778), *Verhandel.* (1781, &c.), *Tijdschrift* (1853, &c.), and *Notulen* (1862, &c.); *Natuurk. Vereeniging in Nederl. Indië* (1850), *Tijdschrift* (1851-1865) and *Verhandel.* (1856, &c.).
- DENMARK.—Copenhagen, *K. Danske Videnskabernes Selskab*, based on *Kjöbenhavnske Selskab* (1743-1813), *Skrifter* (1781, &c.) and *Afhandlingar* (1824, &c.); *Naturhist. Forening, Meddelelser* (1849, &c.). Reykjavik, *Islenzka Náttúrufræðisfélag* (1889), *annual reports.*
- SWEDEN.—Gottenburg, *K. Vetenskaps och Vitterhets Samhälle, Handlingar* (1778, &c.). Stockholm, *K. Svenska Vetenskaps Akademi, Handlingar* (1740, &c.) and *Arbättelser* (1820, &c.). Upsala, *K. Vetenskaps Societeten* (1710), *Acta* (1720, &c.).
- NORWAY.—Christiania, *Physiographiske Forening, Mag. for Naturvidensk.* (1832, &c.); *Videnskabs-Selskabet* (1857), *Forhandl.* (1859, &c.), *Skrifter* (1894, &c.). Thronhjelm, *K. Norske Vidensk.-Selskab, Skrifter* (1817, &c.).
- SPAIN.—Barcelona, *R. Acad. de Buenas Letras*, the oldest Spanish society, *Mem. and Boletín;* *R. Acad. de Ciencias y Artes* (1763). Madrid, *R. Acad. de Cien. Exactas, Fis., y Nat.* (1847), *Mem.* (1850, &c.); *Soc. Españ. de Hist. Nat., Anales* (1872, &c.). San Fernando, *R. Acad., Mem.*
- PORTUGAL.—Coimbra, *Instituto de Coimbra* (1852). Lisbon, *Soc. Portuguesa de Sciencias Naturais* (1907), *Bulletin* (1907, &c.).
- RUSSIA.—Siedz Russkikh Yestestvoispytatelye (*Meeting of Russ. Naturalists*), first meeting at St Petersburg 1867-1868, *Trudy or*

Trans. (4to, 1868, &c.). Dorpat, *Naturforsch. Ges.* (1853), *Sitzungsber.* (1853, &c.) *Archiv* (1854, &c.) and *Trudy* (1884, &c.); *Gelehrte Estnische Ges.*, *Verhandl.* (1840, &c.), *Schriften* (1863-1869) and *Sitzungsber.* (1861, &c.). Ekaterinburg, *Soc. of Naturalists* (1870), *Zapiski.* Helsingfors, *Societas pro Fauna et Flora Fennica* (1821), *Acta* (1875, &c.); *Finska Vetenskaps-Soc.* (1838), three sections. Kaminietz, *Naturforsch. Ges. Kazan, Soc. of Naturalists at University, Protokoly* (1870, &c.) and *Trudy* (1872, &c.). Kharkoff, *Soc. of Scientists at Univ.*, *Trudy* (1870, &c.) and *Protokoly* (1870, &c.). Kieff, *Soc. of Naturalists, Zapiski.* Lemberg, *Polish Soc. for the Advancement of Science* (1901). Moscow, *Imp. Soc. of the Friends of Nat. Hist., Anthropol.*, &c. (1863), *Izvestiya or Bull.* (1865, &c.); *Soc. Imp. des Naturalistes* (1805), *Mém.* (4to, 1806) and *Bull.* (8vo, 1829, &c.). Odessa, *Soc. of Naturalists of New Russia, Zapiski* (1872, &c.) and *Protokoly* (1874, &c.). Riga, *Naturforsch.-Ver.* (1845), *Corr.-Blatt* (1846, &c.) and *Arbeiten* (1865, &c.). St Petersburg, *Imp. Soc. of Naturalists* (1868), *Trudy* (1870, &c.). Saratov, *Soc. of Naturalists* (1895), *Trudy* (1899, &c.). Warsaw, *Soc. of Friends of Sc., Roczniki* (1802-1828); *Warsaw Naturalists' Soc.* (1889).

RUMANIA.—Bucharest, *Acad. Română* (1866), *Annalile* (1867, &c.); *Soc. de Științe* (1891); *Soc. Politehnică* (1881). Jassy, *Soc. Științifică și Literară* (1889).

GREECE.—Athens, *Φιλολογικὸς σύλλογος Παρνασσός* (1865), *Παρνασσός* and other publications; *Ἡ ἐν Ἀθήναις Ἐπιστημονικὴ Ἐταιρεία* (1888), since 1899 styled *Σωματὶ Ἀκαδημία*.

CENTRAL AND SOUTH AMERICA.—Bogotá, *Soc. de Naturalistas Colombianos, Contribuciones* (1860, &c.). Buenos Aires, *Soc. Científica Argentina* (1872), *Anales* (1876, &c.). Caracas, *Soc. de Ciencias, Boletín* (1868, &c.). Cordova, *Acad. Nacion., Bol.* (1874, &c.). Guatemala, *Inst. Nac.; Academia* (1888); *Ateneo* (1903), 7 sections. Havana, *Acad. de Cien.* (1861), *Anales* (1864, &c.). La Paz (Bolivia), *Academia Aymara* (1901). Mexico, *Soc. Mex. de Hist. Nat.* (1868), *La Naturaleza* (1869, &c.); *Academia Mejicana* (1875), *Memorias* (1876-1896); *Acad. Mex. de Ciencias* (1894), *Anales.* Rio de Janeiro, *Palestra Cient., Archivos* (1858, &c.). Santiago, *Soc. de Hist. Nat.*

JAPAN.—Tokyo, *Asiatic Soc. of Japan* (1872), *Trans.* (1874, &c.); *Deutsche Ges. f. Natur- u. Völkerkunde Ostasiens* (1873), *Mitteil.* (1873, &c.).

II. MATHEMATICS

Many of the general scientific societies (see class i.) have mathematical and other special sections. Among defunct English societies may be mentioned the *Mathematical Society*, which used to meet in Spitalfields (1717-1845) and possessed a library, and the *Cambridge Analytical Society*, which published *Memoirs* (4to, 1813). The *London Mathematical Society* 1865, incorporated 1894, *Proc.* (1865, &c.), the *Mathematical Assn.* (1871), *Gazette*, and the *Edinburgh Mathematical Society* (1883), *Proc.* (1883, &c.), are still flourishing.

UNITED STATES: *American Mathem. Soc.* (reorganized 1894), meets at Columbia University, *Bull.* and *Trans.* FRANCE: Paris, *Soc. Mathém. de France* (1872), *Bull.* (1873, &c.). GERMANY and AUSTRIA-HUNGARY: Berlin, *Mathem. Ver. der Univ.* (1861), *Ber.* (1876, &c.); *Berliner Mathem. Ges.* (1901), *Sitzungsber.* Budapest, *Mathematikai és Phys. Társulat* (1891). Cassel, *Geometer-Ver.* (1878). Dresden, *Ver. praktisch. Geometer* (1854), *Jahresber.* (1861, &c.). Essen, *Feldmesser-Ver.* (1869). Göttingen, *Mathemat. Ver.* (1868). Hamburg, *Mathemat. Ges.* (1690), *Mitteil.* Königsberg, *Geometer-Ver.* (1872). Leipzig, *Deutsche Mathem. Vereinigung* (1891), founded at Halle, *Jahresb.* Strassburg, *Geometer-Ver.* (1881). Stuttgart, *Deutscher Geometer-Ver., Zeitschrift* (1872, &c.). HOLLAND: Amsterdam, *Genootschap der Mathemat. Wetensch. Kunstoeffeningen* (1782-1788), *Mengelwerken* (1793-1816), and *Archief* (1856, &c.). SPAIN: Valladolid, *R. Acad. de Matematicas* (1803, &c.), now dissolved. RUSSIA: Kazan, *Phys. and Math. Soc.* (1880). Moscow, *Mathemat. Soc.* (1867). JAPAN: *Mathemat. Soc. of Tokyo, Journal* (1878, &c.).

III. ASTRONOMY

The first *International Astronomical Congress* met at Heidelberg in 1863, and the first international conference for photographing the heavens at Paris in 1887. The *Royal Astronomical Society* was founded in 1820 under the title of *Astronomical Society of London*, and was incorporated on the 7th of March 1831. It occupies rooms in Burlington House, and has published *Memoirs* (1882, &c.) and *Monthly Notices* (1831, &c.). There are also the *British Astronom. Soc.* in London, and societies at Bristol (1869), *Reports*; Leeds (1859), Manchester and Liverpool (1881); Toronto, *Roy. Astr. Soc. of Canada* (1890), *Trans.* (1890), *Proc.* (1902), *Journal* (1907, &c.); Madison, *Astronomical and Astrophysical Soc. of America* (1899); San Francisco, *Astr. Soc. of the Pacific* (1889), *Publ.*; Paris, *Soc. Astr.* (1887), *Bull.*; Berlin, *Kgl. Astr. Recheninstitut* (1897); Leipzig, *Astronomische Ges.* (1863), *Publ.* (1865, &c.) and *Vierteljahrsschrift* (1866, &c.); Turin, *Soc. Astr. Ital.* (1906), *Revista*; Brussels, *Soc. Belge d'Astr., de Météorol. et de Physique du Globe* (1893), *Bull. mens.*; Antwerp, *Soc. d'Astr.* (1905), *Gazette*; St Petersburg, *Russ. Astr. Soc.* (1890), *Investija* (1896, &c.); and Mexico, *Soc. Astr.* (1902), *Boletín* (1902, &c.).

IV. PHYSICS

The first *International Electrical Congress* was held at Paris in 1881. The *Physical Society of London* was founded in 1874 and registered

under the Companies Act; it publishes *Proceedings* (1874, &c.). The *London Electrical Society* (1836) did useful work in its *Transactions* (1837-1840, vol. i.) and *Proceedings* (1841-1843). Sir W. Siemens was one of the originators of the *Institution of Electrical Engineers* (founded in 1871 and registered in 1883). It owns the Ronalds library of electricity and magnetism and publishes a *Journal*. In London there are also the *Faraday Soc.* (1903), *Trans. and Proc.*, and the *Optical Soc.*

UNITED STATES: Philadelphia, *Amer. Electrochem. Soc., Trans.* (1902). New York, *Nat. Elec. Light Assn.* (1885), *Proc.* (1885); *Amer. Phys. Soc.* (1899), *Bull.* (1899) included since 1903 in the *Physical Review*; *Am. Inst. of Electr. Eng.* (1884), *Trans. and Proc.* FRANCE: Cambrai, *Soc. Magnétique, Archives* (1845). Paris, *Soc. Franç. de Phys.* (recognized as of public utility on the 15th of January 1881), *Bull.*; *Soc. Int. des Electriciens* (1883), *Bull.* GERMANY: Berlin, *Physikalische Ges.* (1843), *Fortschritte der Physik* (1847, &c.); *Elektrotechnisch. Ver.* (1879), *Ztschr.* (1880, &c.). Breslau, *Physikalischer Ver.* Frankfurt, *Physikalischer Ver.* (1824), *Jahresber.* (1841, &c.), and *Wetterkarten* daily. Königsberg, *Phys.-ökon. Ges.* (1790), *Schr.* (1859, &c.). ITALY: Naples, *R. Accad. delle Sc. Fis. e Matem., Rendic.* (1856, &c.) and *Atti* (1863). Rome, *Soc. degli Spettroscopisti Ital.*; *Soc. Ital. di Fisica* (1897), *Il nuovo cemento.* HOLLAND: Rotterdam, *Bataafsche. Genootschap van Proefondervindelijke wijsbegeerte, Verhandl.* (1774, &c.). RUSSIA: St Petersburg, *Russ. Physico-Chemical Soc., Journal* (1869, &c.).

V. CHEMISTRY

Pharmaceutical societies are placed in class xiii. (Medicine, &c.). The *Chemical Society of London* for the promotion of chemistry and the sciences immediately connected with it was instituted on the 23rd of February 1841; a charter of incorporation was obtained in 1848. It publishes *Memoirs* (1843, &c.), and *Quarterly Journal* (1849, &c.). Chemistry and its connexion with the arts, and agricultural and technical matters, form the subjects of the *Institute of Chemistry*, founded on the 2nd of September 1877 and incorporated in 1885. It publishes *Proc.* The *Society of Chemical Industry* (1881) was incorporated in 1907, and publishes a *Journal*. The *Society of Public Analysis* publishes the *Analyst* (1876, &c.). The oldest of the numerous photographic societies is the *Royal Photographic Society of Great Britain* (1853), which issues a *Journal*. The *Royal College of Chemistry* was founded in July 1845, and had a brief career; it published *Reports* (1849). The *Cavendish Society* was instituted in 1846 for the publication and translation of works and papers on chemistry. It came to an end in 1872 after having issued 30 vols.

UNITED STATES: New York, *American Chemical Soc.* (1876), *Proc.* (1876), *Journ.* (1879) and *Abstracts* (1907). Washington, *Chem. Soc.* (1884), *Bull.* now the *Journal of the Amer. Chem. Soc.* FRANCE: Paris, *Soc. Chimique* (1857), *Bull.* (1861, &c.). GERMANY: Berlin, *Deutsche Chemische Ges.* (1867), *Ber.* (1868, &c.); *Deutsche Bunsen-Ges.* (1894), *Ztschr. für Elektrochemie; Verein Chem. Reichsanstalt.* Frankfurt, *Chem. Ges.* Jena, *Chem.-Laborat.* Leipzig, *Ver. Deutscher Chem.* (1888), based on the *Ver. Analyt. Chemiker, Ztschr.* (1900, &c.). Würzburg, *Chemische Ges.* (1872). BOHEMIA: Prague, *Spolek Chemiku Ceskych or Soc. of Bohemian Chemists, Zpravy or Trans.* (1872, &c.). BELGIUM: Brussels, *Soc. Chim. de Belgique*, formerly *Assoc. Belge des Chimistes* (1887), *Bull.*

VI. GEOLOGY, MINERALOGY AND PALAEOLOGY

The first *International Congress of Geology* took place at Bologna in 1878. The *Geological Society of London*, founded in 1807 and incorporated in 1826, is the largest and most important in Great Britain; it has published *Proceedings* (1834-1846), *Transactions* (1811, &c.), and a *Quarterly Journal* (1845, &c.). The *Geologists' Association* was instituted in 1858, and issues *Proceedings* (1859, &c.). The *Mineralogical Society* (1876) has united with it the *Crystallographic Society*; it issues the *Mineralogical Magazine* (1876, &c.). The *Palaeontographical Society* was founded in 1847 for the delineation and description of British fossils; it issues *Publications* (4to, 1847, &c.). The *Royal Geological Society of Cornwall* (1814) devotes special attention to the mining interests of the county, and publishes *Transactions* (1818, &c.). It holds its meetings at Penzance. The *Geological Society of Edinburgh* (1834) issues *Transactions* (1870, &c.). The *Royal Geological Society of Ireland* (1832) principally studied the geology of the country. It published a *Journal* (1837, &c.). There are also the *Geological Associations of Leeds* (1874) and *Liverpool* (1880), *Trans.*, and the *Societies of Liverpool* (1859), *Proc.*, and *Manchester* (1838), *Trans.*

SOUTH AFRICA: Johannesburg, *Geol. Soc. of S. A.* (1895), *Trans.* (1895, &c.). UNITED STATES: Louisville, Ky., *Ohio Falls Geolog. Soc.* San Francisco, *California State Geolog. Soc.* (1876). New York, *Geol. Soc. of Amer.* (1888), *Bull.* Washington, *Geol. Soc. of Washington* (1893). FRANCE: Lille, *Soc. Géol. du Nord* (1870), *Annales* (1874, &c.). Havre, *Soc. Géol. de Normandie, Bull.* (1873, &c.). Paris, *Soc. Géol. de France* (1830, recognized 1832), awards the *Prix Viquesnel* (£40) every three years, *Bull.* (1830, &c.) and *Mém.* (1833, &c.). *Soc. Franç. de Minéralogie* (1878, recognized 1886), formerly *Soc. Minéral. de France, Bull.* (1879, &c.). Saint-Étienne, *Soc. d'Ind. Minérale* (1855), *Bull.* (1855, &c.). GERMANY and AUSTRIA-HUNGARY: Berlin, *Deutsche Geol. Ges.* (1848), *Ztschr.* (1849, &c.), *Monatsberichte* (1903, &c.); Budapest, *Magyarhoni Földtani Társulat*

1850) or *Hungarian Geol. Soc.* (1850), *Földtani Közlöny*. Brünn, *Wernerscher Geol. Ver., Jahresber.* Darmstadt, *Mittelrheinischer Geol. Ver.* (1851), *Mittheil.* (1855, &c.). Dresden, *Geirgs-Ver.* (1855). SWITZERLAND: *Schweizerische Geol. Ges.* (1882), section of *Allg. Schw. Ges.* Zürich, *Schweiz. Paläontol. Ges.* (1874), *Abhandl.* (1875, &c.). ITALY: Rome, *Soc. Sismol. Ital.* (1895), *Boll.*; *Soc. Geol. Ital.*, founded at the second *International Geological Congress*. BELGIUM: Antwerp, *Soc. Paléontol.* (1857), *Bull.* Brussels, *Soc. Belge de Géol., de Paléont. et d'Hydrog.* (1887), *Bull., Mém. and Proc.-verb.* Charleroi, *Soc. Paléontol.* (1863), *Documents et Rapports* (1866, &c.). Liège, *Soc. Géol. de Belgique, Annales* (1874, &c.). SWEDEN: Stockholm, *Geologiska Förening* (1871), *Förhändlingar* (1872, &c.). RUSSIA: St Petersburg, *Imp. Russian Mineralog. Soc.* (1816), *Trans.*, pub. in Russian, German and French (1830, &c.). ARGENTINE REPUBLIC: Buenos Aires, *Soc. Paleontol.* MEXICO: Mexico, *Soc. Geol. Mexicana* (1904), *Bol.*

VII. METEOROLOGY

The *International Meteorological Congress* first met at Brussels in 1853. The *Royal Meteorological Society* (1850) of London was incorporated in 1866; its organ is *Quarterly Journal* (1873, &c.). To this must be added the *British Rainfall Society*; the *Scottish Meteorological Society* holds its meetings at Edinburgh and issues a *Journal* (1866, &c.). Port Louis (Mauritius), *Meteorolog. Soc., Trans.* (1853, &c.). Paris, *Soc. Météorolog. de France* (1852), *Annuaire* (1853, &c.) and *Nowvelles Météorolog.* (1868, &c.). Berlin, *Deutsche Meteor. Ges.* (1883), *Ztschr.* Hamburg, *Deutsche Meteorolog. Ges.* (1883), *Ztschr.* Magdeburg, *Ver. f. landwirtsch. Wetterkunde* (1881). Meissen, *Gesellschaft, Isis.* Vienna, *Österreich. Ges. f. Meteorol., Zeitschrift* (1866, &c.). Modena, *Soc. Meteorolog. Intl.* Gothenburg, *Kungl. Vetenskaps- och Vitterhets-samhället* (1778), *Handligr.*

VIII. MICROSCOPY

The *Royal Microscopical Society* (1839, incorporated 1866), with *Transactions* (1842-1868) and *Journal* (1869, &c.); the *Quekett Microscopical Club* (1865), with a *Journal* (1868, &c.); and the *Postal Microscopical Society* (1873), also with a *Journal*, are located in London. There are suburban societies at Ealing (1877), Hackney (1877), Highbury (1878), South London (1871), and Sydenham (1871). In the provinces may be mentioned those at Bath (1859), Birmingham (1880), Bolton (1877), Bradford (1882), Bristol (1843), Carlisle, Chichester (*Trans.*), Croydon (1870, *Trans.*), Dublin (1840), East Kent (1858), Edinburgh, Liverpool (1868, *Trans.*), Manchester (1880), and Sheffield (1877). In the United States the *State Microscop. Soc. of Illinois* publishes the *Lens* (1872, &c.); Buffalo, *Amer. Soc. of Microscopists*; New York, *Microscop. Soc.*; Urbana, *Amer. Micros. Soc.* (1878), *Proc.* (1879), *Trans.* (1895, &c.). Brussels, *Soc. Belge de Microscop.* (1875), *Proc.-verb.* (1875, &c.) and *Annales* (1876, &c.). Berlin, *Ges. f. Mikroskop.* (1877), *Ztschr.* (1878, &c.). Hanover, *Ges. f. Mikroskop.* (1879), *Jahresber.*

IX. BOTANY AND HORTICULTURE

Linnaean societies, which usually deal with both zoology and botany, are placed in the general class (No. i.). The *Congrès International d'Horticulture* first met at Brussels in 1864, and the *Congrès International de Botanique* at Amsterdam in 1865. The *Royal Botanic Society of London* (incorporated 1839) has gardens in the inner circle of Regent's Park, and issues a *Quarterly Record* (1880, &c.). The *Royal Horticultural Society* (established in 1804, incorporated in 1809) has gardens at Chiswick, and publishes a *Journal* (1846, &c.). The chief provincial societies are—Aberdeen, *North of Scoll. Hort. Assoc.* (1879), *Trans.* Arbroath, *Hortic. Assoc.* (1880). Birmingham, *Bot. and Hort. Soc.* (1829), gardens. Dublin, *Roy. Hort. Soc.* (1830). Liverpool, *Bot. Soc.* (1906). Edinburgh, *Bot. Soc.* (1836), *Proc.* (1837, &c.) and *Trans.* (1844, &c.); *Royal Scottish Arboric. Soc.* (1854), *Trans.*; *Cryptogamic Soc. of Scoll.* (1875). CANADA: Kingston, *Bot. Soc. of Canada* (1860), *Annals* (1861, &c.).

UNITED STATES: Baltimore, *Bot. Soc. Amer.* (1804). Boston, *Hortic. Soc.* (1829). New York, *Torrey Botanical Club* (1858, reorganized 1867), *Bull.* (1870, &c.). San Francisco, *State Hort. Soc.* Washington, *Bot. Soc. of Wash.* (1901). FRANCE: Beauvais, *Soc. d'Hortic. et de Bot.* (1864), *Bull.* (1864, &c.). Bordeaux, *Soc. d'Hortic. Chartres, Soc. d'Hortic. et de Viticulture.* Chauny, *Soc. de Pomologie, Dijon, Soc. d'Hortic.* Fontenay-le-Comte, *Soc. d'Hortic.* Lisieux, *Soc. d'Hortic. et de Bot.* (1866), *Bull.* (1866, &c.). Lyons, *Soc. d'Hortic. Pratique* (1844), *Bull.* (1844, &c.) *Soc. Bot.* (1872), *Annales* (1872, &c.); *Soc. Pöyologique* (1872), *Bull.* (1872, &c.). Moulins, *Soc. d'Hortic.* Nîmes, *Soc. d'Hortic.* Niort, *Soc. d'Hortic.* Orleans, *Soc. d'Hortic.* (1839), *Bull.* (1841, &c.). Paris, *Soc. Nat. d'Hortic.*, (1827; declared of public utility 1852), *Journal*; *Soc. Bot. de France, Bull.* (1854), *Mém.* (1905, &c.). Rouen, *Soc. Centr. d'Hortic.* Saint Germain-en-Laye, *Soc. d'Hortic.* Senlis, *Soc. d'Hortic.* Troyes, *Soc. d'Hortic.* Versailles, *Soc. d'Hortic.* GERMANY and AUSTRIA-HUNGARY: Berlin, *Bot. Ver.* (1859), *Verhandl.* (1859, &c.); *Deutsche Bot. Ges.* (1882), *Berichte* (1883, &c.); *Horticul. Ges.* Blankenburg, *Bot. Ver. Bonn, Bot. Ver.* (1818), *Jahresber.* (1837, &c.). Danzig, *Westpr. Bot.-zool. Ver.* (1878), *Jahresber.* Dresden,

"*Flora*": *Ges. für Bot. u. Gartenbau* (1826), *Sitzungsber.* Erfurt, *Gartenbau Ver.* Frankfurt, *Gartenbau Ges.* Freiburg, *Bot. Ver. Görlitz, Gartenbau Ver.* Gotha, *Thüringer Gartenbau Ver.* Klagenfurt, *Kärntnerische Gartenbau Ges.* Landshut, *Bot. Ver.* (1864). Meiningen, *Ver. f. Pomologie u. Gartenbau.* Munich, *Bayerische Botanische Ges., Mittheil.* (1890). Ratisbon, *K. Bayerische Bot. Ges.* (1790), *Flora* (1818, &c.) and *Repertorium* (1864, &c.). Reutlingen, *Pomolog. Inst.* Sondershausen, *Bot. Ver.* Stuttgart, *Gartenbau Ges., Flora.* Vienna, *K. k. Gartenbau Ges.; Botan. Ver., Verhandl.* (1851, &c.). Weimar, *Ver. f. Blumistik.* Würzburg, *Bot. Inst., Arbeiten* (1871, &c.). ITALY: Milan, *Soc. Critlog. Ital., Atti* (1878, &c.). BELGIUM: Antwerp, *Soc. Roy. d'Hortic. et d'Agr.; Soc. Phytologique, Annales* (1864, &c.). Bruges, *Soc. d'Hortic. et de la Bot.* Brussels, *Soc. Roy. de Bot. with State Botanical Garden* (1862), *Bull.* (1862, &c.); *Soc. Roy. de Flore; Soc. Centr. d'Arboric., Annales.* Liège, *Soc. Roy. d'Hortic.* HOLLAND: Ghent, *Kruidekundig Genootschap Dodonaea* (1887), *Tijdschr.* Leiden, *Nederl. Bot. Vereen.* Luxembourg, *Soc. de Bot., Recueil* (1874, &c.). Nimeguen, *Nederl. Bot. Vereen, Archief* (1871, &c.). DENMARK: Copenhagen, *Bot. Forening, Tidsskrift* (1866, &c.).

X. ZOOLOGY

Societies dealing with natural history in general, or zoology and botany together, come under class i. The first *International Ornithological Congress* was held at St Petersburg. The *Zoological Society of London* (1826, incorporated 1829) is famous for its collection of animals at Regent's Park. It publishes *Proceedings* (8vo, 1830, &c.) and *Transactions* (4to, 1835, &c.). In London also are the *British Ornithologists' Union* (1859); *Entomological Society of London* (1833), *Trans.* (1834, &c.); *National Fish Culture Association* (1883); *Malacolog. Soc.* (1893). The *Concholog. Soc.* (1876) meets at Manchester, which also has an *Entomolog. Soc.* (1902). The *Marine Biological Association of Great Britain* (1884), for the study of marine food fishes and shell-fish, has a laboratory at Plymouth. The *Royal Zoological Society of Ireland* (1831) has gardens in the Phoenix Park. There is the *British Beekeepers' Association* (1874). AUSTRALIA and NEW ZEALAND: Auckland, *Acclimatisation Soc.* Brisbane, *Acclimat. Soc.* Christchurch, *Acclimat. Soc.* Melbourne, *Zoolog. and Acclimat. Soc. of Victoria, Report* (1861, &c.); *Australasian Ornith. Union* (1896), *The Emu.* Sydney, *Acclimat. Soc. of N.S. Wales, Report* (1862, &c.); *Entomolog. Soc. of N.S.W., Trans.* (1863, &c.). Wellington, *Westland Nat. and Acclimat. Soc.* AFRICA: Cape Town, *Zoolog. Soc.* Port Louis (Mauritius), *Soc. d'Acclimat.* CANADA: Toronto, *Entomolog. Soc.; Beekeepers' Assoc.*

UNITED STATES: Cambridge, *Nuttall Ornitholog. Club, Bull.* (1876) and *Memoirs* (1886); and *Entomolog. Club, Psyche* (1874, &c.); *Amer. Soc. Zoologists* (1890). Cincinnati, *Soc. of Nat. Hist.* (1870), *Journs.* (1879). Illinois, *Central Beekeepers' Association.* New York, *Entom. Soc.* (1892), *Journal*; *N. Y. Zoolog. Soc.* (1895), *Rep. Guide Book.* Pasadena, *Cooper Ornith. Club* (1893) founded at San Jose, *Pacific Arifauna* (1900, &c.), *The Condor* (1899, &c.). Philadelphia, *Zoolog. Soc.* (1859), *Report* (1874, &c.); and *Amer. Entomolog. Soc.* (1859), *Proc.* (1861-1866), *Trans.* (1867, &c.). Washington, *Amer. Ornith. Union* (1883), *The Auk* (1884, &c.); *Biolog. Soc.* (1901); and *Entomolog. Soc.* (1884), *Proc.* FRANCE: Alais, *Soc. Séricicole, Bull.* (1876, &c.). Amiens, *Soc. d'Apiculture, Bull.* (1875, &c.). Clermont, *Soc. Centr. d'Apicult., Bull.* (1875, &c.). Lille, *Inst. Zoolog. à Wimereux, Travaux* (1877, &c.). Paris, *Soc. Nat. d'Acclimat.* (1854), *Bull. Mensuel* (1854, &c.) and *Chron. Bimens.* (1875, &c.); *Soc. Zoolog. de France, Bull.* (1876, &c.); *Soc. Entomolog. de France, Annales* (1832); and *Soc. de Biologie* (1848), *Comptes Rendus* (1849, &c.). GERMANY and AUSTRIA-HUNGARY: *Wander-versammlung Deutscher Bienezüchter, Verhandl.* (1856, &c.). Bendorf, *Akklimat.-Ver.* Berlin, *Akklimat.-Ver.* (1856), *Zeitschr.* (1858, &c.); *Central-Inst. f. Akklimat., Mittheil.* (1859, &c.); *Deutsche Zoolog. Ges.; Deutsche Ornithol. Ges.* (1850), *Journal* (1853, &c.); *Deutsche Fischerei Ver., Publikat.* (1871, &c.); *Berliner Entomolog. Ges.* (1856), *Entomolog. Zeitschr.* (1857, &c.); *D. Entomol. Ges.* (1881), *Ztschr.; Ver. zum Beförd. des Seidenbaues, Jahresber.* (1869, &c.); *Physiolog. Ges.* (1875), *Verhandl.* (1877, &c.). Breslau, *Physiolog. Inst., Studien* (1861, &c.); *Ver. f. Schles. Insektenkunde, Zeitschr.* (1847, &c.). Brunswick, *Deutsche Ornitholog. Ges.* Carlsruhe, *Badischer Ver. f. Geflügelzucht, Monatsblatt* (1872, &c.). Frankenberg, *Bienenwirthschaftl. Haupt-Ver., Sächs. Bienenfreund* (1865, &c.). Frankfurt, *Zoolog. Ges., Der Zoolog. Garten* (1860, &c.); *Deutsche Malakozoolog. Ges.* (1868), *Jahrbücher* (1874-1887) and *Nochrichtsblatt* (1869, &c.). Halberstadt, *Deutsche Ornitholog. Ges. Halle, Ornitholog. Central-Ver.* Hamburg, *Zoolog. Ges., Ber.* (1862, &c.). Hanover, *Bienenwirthschaftl. Central-Ver., Centralblatt* (1865, &c.). Leipzig, *Sächs. Seidenbau Ver., Zeitschr.* (1868, &c.). Munich, *Entomolog. Ver.* (1876); *Fischerei Ver., Mittheil.* (1876, &c.). Nördlingen, *Ver. Deutscher Bienenwirth, B.-Zeitung* (1845, &c.). Ratisbon, *Zoolog.-mineralog. Ver.* (see class i.). Stettin, *Ornitholog. Ver.* (1873), *Jahresber.* (1873, &c.); *Entomolog. Ver.* (1837), *Ent. Zeitung* (1840, &c.). Trieste, *Zoolog. Inst. u. Zoolog. Station* (1875), *Arbeiten* (1878, &c.). Troppau, *Schles. Bienenzucht-Ver.* (1873). Vienna, *Entomolog. Ver.; Embryolog. Inst., Mittheil.* (1871, &c.); *Ornitholog. Ver.* Würzburg, *Zoolog.-zootomisches Inst.* (1872), *Arbeiten* (1874, &c.). SWITZERLAND: Bern, *Schweiz. Entomolog. Ges.* (1858), *Mitteil.* (1862, &c.). Geneva, *Assoc. Zoolog. du Léman; Soc. Ornitholog. Suisse*

(1865), *Bull.* (1866, &c.). Zürich, *Internat. Entomologenverein* (1886), *Societas Entomologica* (1886, &c.). ITALY: Casale, *Soc. Bacologica*, *Boll.* (1866, &c.). Florence, *Soc. Allantina Ital.*, *La Sericoltura* (1865, &c.); *Soc. Entomolog. Ital.*, *Boll.* (1869, &c.). Naples, *Zoolog. Station, Mittheil.* (1878). Palermo, *Soc. di Acclimaz.*, *Atti* (1861, &c.). Pisa, *Soc. Malacolog. Ital.*, *Boll.* (1875, &c.). Rome, *Soc. di Piscicol. Ital.* (1872). BELGIUM: Antwerp, *Soc. Roy. de Zoologie* (1843) with *Jardin Zool.* and *Mus. Brussels*, *Soc. Roy. de Zoologie et Malacologique de Belge* (1863), *Annales* (1870, &c.); *Soc. Entomolog. de Belgique* (1856), *Annales and Bull.* (1857, &c.). HOLLAND: Amsterdam, *K. Zoolog. Genootschap "Natura Artis Magistra"* (1838), *Bijdragen* (1848), *Jaarboekje* (1852, &c.) and *Tijdschr.* (1863, &c.), zoolog. garden and museum. The Hague, *Nederl. Entomolog. Vereen.*, *Tijdschr.* (1857, &c.). Rotterdam, *Nederl. Dierkundige Vereen.*, *Tijdschr.* (1874, &c.). NORWAY: Bergen, *Selskabet for Norges Fiskerier*, Christiania, *Det Biol. Selskab.* (1894), *Aaresber*. SWEDEN: Stockholm, *Entomolog. Förening* (1879), *Ent. Tidkrift* (1880, &c.). RUSSIA: Moscow, *Acclimat. Soc.* St Petersburg, *Russian Entomolog. Soc.* (1859), *Ilorae societatis entom. ross.* ARGENTINE REPUBLIC: Buenos Aires, *Soc. Zoolog. Argentina*, *Period. Zoolog.* (1875, &c.); *Soc. Entomolog. Argent.*

XI. ANTHROPOLOGY

The *Congrès International d'Anthropologie et d'Archéologie Pré-historiques* held its first meeting at Neuchâtel in 1866; it issues *Comptes rendus* (1866, &c.). The *Royal Anthropological Institute of Great Britain and Ireland* was founded in 1871 upon the *Ethnological Society* (1843), which published a *Journal* (1848-1856) and *Transactions* (1859-1869), and the *Anthropological Society* (1863), which issued *Memoirs* (1863-1869) and the *Anthropological Review* (1864-1870). The *Institute* brings out a *Journal* (1871, &c.).

Sydney, *Roy. Anthropolog. Soc.* (1896). Bombay, *The Gatha Soc.* (1903), occasional pamphlets.

UNITED STATES: Cleveland, *Amer. Inst. Anthrop.* (1890), *Journal*. New York, *Amer. Ethnol. Soc.* (1842), *Trans.* (1845-1853) and *Bull.* (1860-1861); formerly *Anthropolog. Inst.*, *Journ.* (1871). Washington, *Anthropolog. Soc.* (1879), *Trans.* (1882, &c.); *Amer. Anthropol. Assoc.* (1902), *Amer. Anthropologist*. Havana (Cuba), *Soc. Antrop.* FRANCE: Grenoble, *Soc. dauphinoise d'Ethn. et d'Anthrop.* (1894), *Bull.* (1894, &c.). Lyons, *Soc. d'Anthrop.* (1881), *Bull.* (1881, &c.). Paris, *Soc. d'Anthropologie* (1859; recognized 1864), *Bull.* and *Mém.* (1860, &c.); *Soc. d'Ethnogr.*, *Annuaire* (1862, &c.), and *Revue* (1869, &c.); *Soc. des Traditions Populaires* (1886) *Revue* (1886, &c.). GERMANY and AUSTRIA-HUNGARY: Berlin, *Ges. f. Anthropologie, &c.* (1869), *Ztschr.* (1870, &c.) and *Verhandl.* (1871, &c.); *Deutsche Ges. für Anthropol., Ethn. &c.* (1870), *Archiv* (1866, &c.). Brunswick, *Deutsche Ges. f. Anthropologie, Archiv* (1870, &c.) and *Corr-Blatt* (1874, &c.). Budapest, *Magyar Néprajzi Társaság* (1889), *Ethnographia* (1889, &c.). Cologne, *Ver. zur Förderung der Stadt-Rautenstrauch-Joest Museums für Völkerkunde* (1904), *Jahresber.* (1904, &c.). Görlitz, *Ges. für Anthropol. &c.* (1888), *Jahreshefte*. Göttingen, *Anthropolog. Ver.*, *Mittheil.* (1874, &c.). Kiel, *Anthrop. Ver.* (1877), *Mitteil.* (1888, &c.). Leipzig, *Ver. f. Anthropolog., Ber.* (1871, &c.), afterwards joined to the *Ver. der Erdk.* Munich, *Ges. f. Anthropolog. &c.* (1870), *Beitr.* (1876, &c.). Stuttgart, *Anthropolog. Ges.* (1871), *Fundber.* (1893, &c.). Vienna, *Anthropolog. Ges.* (1870), *Mittheil.* (1870, &c.). ITALY: Florence, *Soc. Ital. di Antropologia* (1868), *Archivio* (1871, &c.). BELGIUM: Brussels, *Soc. d'Anthrop.*, *Bull.* (1882, &c.). SWEDEN: Stockholm, *Svenska Sällskapet för Antrop.* (1873), *Tidkrift* (1873, &c.). SPAIN: Madrid, *Soc. Antropolog. Esp.*, *Revista* (1875, &c.). RUSSIA: St Petersburg, *Russian Anthropol. Soc.* (1888), *Protokoly-zasedanij* (1901, &c.).

XII. SOCIOLOGY (Economic Science, Statistics, Law, Education)

The international societies are the *Association Internationale pour le Progrès des Sciences Sociales* and the *Congrès International de Statistique*, which first met at Brussels in 1853. Both have issued *Comptes rendus*. The *Congrès International de Bienfaisance* may be traced to a suggestion at the *Congrès Pénitentiaire* held at Frankfurt in 1847. The first meeting took place at Brussels in 1856. The *Inst. Internat. de Sociologie* (1893) has its headquarters at Paris. The *National Association for the Promotion of Social Science* (1857) had united with it in 1864 the *Society for Promoting the Amendment of the Law*. It held a yearly migratory meeting, and published *Transactions* (1858, &c.) and *Social Science* (1866, &c.). The *Sociological Soc.*, the *Eugenics Education Soc.* and the *Roy. Economic Soc.* are established in London. The *Royal Statistical Society* (1834), incorporated 1887, publishes a *Journal* (1839, &c.); *Cobden Club* (1866), for the diffusion of the political and economical principles with which Cobden's name is associated, has issued a variety of publications; *Institute of Actuaries* (incorp. 1884); *Institute of Chartered Accountants* (1880); *Institute of Bankers* (1879); the *Society of Incorporated Accountants and Auditors* (1885), and the *Chartered Institute of Secretaries*, also meet in London. There are also the *Manchester Statistical Society* (1833), with *Transactions*; the *Faculty of Actuaries in Scotland* and the *Scottish Society of Economists* (1897), both meeting at Edinburgh; and the *Statistical and Social Inquiry Society of Ireland* (1847), with a *Journal*, at Dublin. After the INNS OF COURT (q.v.), the most important of

British legal societies is the *Law Society* (1827, incorporated 1832, reincorp. 1845); it began courses of lectures for students in 1833, and was appointed registrar of solicitors ten years later, and obtained supplementary charters in 1845 and 1878. This society has a fine building, with library and examination hall in Chancery Lane, London. There are over 70 provincial societies, most of them being associated with the parent body. The *Verulam Society* (1846) published a few books and came to an end. The *Selden Society*, established in 1887 for the promotion of the study of the history of law, prints ancient records. The headquarters of the *Association for the Reform and Codification of the Law of Nations* are in London, but conferences are held in various continental towns. The *Chartered Institute of Patent Agents* (founded 1882, incorporated 1891) issues *Transactions*. The *Juridical Society of Edinburgh* (1773) published five editions of a *Complete System of Conveyancing*. The *Ascham Society* was founded in 1879 for the improvement of educational methods; and the *Society for the Development of the Science of Education* (1875) issued *Transactions*.

UNITED STATES: Baltimore, *Amer. Pol. Sc. Assoc.* (1903), *Proc.* Boston, *Amer. Soc. Sc. Assoc.*; *Amer. Statist. Assoc.* (1839), *Collections* (1847, &c.). Cambridge, *Amer. Econ. Assoc.* (1886). New York, *Am. Inst. of Social Service, Social Service* (1899, &c.); *Actuarial Soc. of Amer.* (1899); Philadelphia, *Amer. Acad. Pol. and Social Sc.* (1899), *Annals*; *American Bar Assoc., Reports*; *Assn. of Amer. Law Schools* (1901). Washington, *Amer. Soc. of Int. Law* (1906), *Journal*; *Nat. Educ. Assoc.* (1857), *Proc.* FRANCE: Grenoble, *Soc. de Statist.* (1838), *Bull.* (1838, &c.). Marseilles, *Soc. de Statist.* (1827), *Répertoire* (1837, &c.); *Soc. Sc. industr.* (1871), *Bull.* (1872, &c.). Paris, *Soc. Int. des Études Pratiques d'Econ.* (1856, recognized 1869); *Soc. Fran. de Statist. Univ.* (1829), *Journal* issued jointly with *Acad. Nat.* since 1849; *Soc. de Statist. de Paris* (1860, recognized 1869), *Journ.* (1860, &c.); *Soc. de Législation Comparée* (1869, recognized 1873), *Bull.*, *Annuaire de Lég. Franç.*, and *Ann. de Lég. Étr.*; *Soc. pour l'Instr. Élément* (1815, recognized 1831), *Bull.*; *Soc. de Linguistique* (1864), *Mém.* (1868, &c.); *Soc. de l'Enseignement Supérieure* (1878), *Rev.* (1881, &c.); *Soc. d'Econ. Sociale* (1856), *Les Ouvriers des deux mondes* (1857, &c.), *La Réforme sociale* (1881, &c.); *Soc. d'Econ. Pol.* (1842), *Annales* (1846-1847), *Bull.* (1888, &c.); *Soc. de l'École des Chartes* (1839), *Mém.* St Maixent, *Soc. de Statist. des Deux-Sèvres*. Toulouse, *Acad. de Légis.* (1851), *Rec.* (1851, &c.). GERMANY and AUSTRIA-HUNGARY: Debreczen, *Magyar Kir. Gazdasági Akad.* (1868). Berlin, *Volkslehrer. Ges.* (1860), *Volkslehrer. Zeitfragen* (1879, &c.); *Ver. f. deutsche Volkswirths.* (1876), *Ztschr.* (1880, &c.); *Ver. f. Förderung d. Handelsfreiheit* (1878), *Mittheil.* (1879, &c.); *Ver. f. d. Statist.*; *Jurist. Ges.* (1859), *Jahresber.* (1863, &c.). Dresden, *Statistischer Ver.* (1831), *Mittheil.* Frankfurt, *Statistische Ges.*; *Juristische Ges.* (1866), *Rundschau* (1867, &c.); *Akad. für Sozial- u. Handlungswissenschaften* (1901). Freiburg, *Badische Heimat* (1893), *Volkshunde*. Halle, *Kantgesellschaft* (1904), *Kantstudien*. Laibach, *Jurist. Ges.* Leipzig, *Ver. f. wiss. Pädagogik, Jahrbuch* and *Mittheil.* ITALY: Tortona, *Soc. di Storia Economica, Boll.* BELGIUM: Brussels, *Ligue de l'Enseignement* (1864), *Bull.*; *Soc. Centr. des Instituteurs Belges* (1860), *Le Progrès*; *Inst. Solway de Sociologie* (1901). HOLLAND: Amsterdam, *Ver. voor de Statist. in Nederland, Jaarboekje* (1849, &c.) and *Jaarcijfers* (1882, &c.). SPAIN: Madrid, *Junta Estadist.*, *R. Acad. de Jurisprudencia y Legis.* (1763, 1826); *R. Acad. de Ciencias Mor. y Pol.* (1857). RUSSIA: Moscow, *Juridical Soc.* St Petersburg, *Pedagogical Soc.* EGYPT: Cairo, *Bureau Central de Statist.* HAVANA (Cuba), *Soc. Econ. de Amigos del Pais* (1792), *Memorias*. JAPAN: Tokio, *Statist. Soc.*

XIII. MEDICINE AND SURGERY

The first meeting of the *Congrès Médical International* was held at Paris in 1867; a *Bulletin* has been issued annually since 1868, and the first Surgical Congress was held in Paris in 1885. The first *Congrès Périodique Internat. d'Ophthalmologie* took place at Brussels in 1857. The Royal Colleges of Physicians and of Surgeons of London, Edinburgh and Dublin do not come within our scope. The *Medical Society of London* (1773) is the oldest in the metropolis; it has issued *Memoirs* (1787-1805), *Transactions* (1810, &c.), and *Proceedings* (1872, &c.). The *Royal Society of Medicine* was formed, by Royal charter, in 1907 by the amalgamation of the following societies: *Roy. Med. and Chir. Soc.* (1805), *Pathological Soc.* (1846), *Epidemiological Soc.* (1850), *Odontol. Soc. of Gt. Britain* (1856), *Obstetrical Soc.* (1858), *Clinical Soc.* (1867), *Dermatological Soc. of London* (1882), *British Gynaecological Soc.* (1884), *Neurolog. Soc.* (1886), *British Laryngol. Rhinol. and Otolological Assoc.* (1888), *Laryngol. Soc.* (1893), *Soc. of Anaesthetists* (1893), *Dermatol. Soc. of Gt. Brit. and Ireland* (1894), *Otolological Soc.* (1899), *Soc. for Study of Diseases in Children* (1900), *British Electro-therapeutic Soc.* (1901) and the *Therapeutical Soc.* (1902). Most of these societies have separate *Transactions* or *Proceedings*. Other London societies (past and present) include the *Abernethian Society* (1795), which issues *Proceedings*; *British Dental Association* (1880), with a *Journal* (1880, &c.); *British Homoeopathic Association* (1859), with *Annals* (1860, &c.); *British Medical Association* (1832), which has more than forty home and colonial branches, and publishes *British Medical Journal* (1857, &c.); *Hahnemann Publishing Society* (1852), *Materia Medica* (1852, &c.); *Harveian Society* (1831); *Hunterian Society* (1819), *Trans.*; *Lister Institute* (incorp. 1891); *Medico-Legal Soc. of London, Trans.*;

Medico-Psycholog. Assn. of Gr. Britain and Ireland (1841, incorp. 1895); *New Sydenham Society* (1858), which published *Biennial Retrospect* (1867, &c.), and translations and reprints of books and papers of value, succeeded the old *Sydenham Society* (1844-1858), which issued 40 vols.; *Ophthalmological Society* (1880), *Trans.*; *Pharmaceutical Society* (1841), with museum, *Pharmaceutical Journal* (1842, &c.); *Physiological Association* (1876), *Journ. of Physiology* (1878, &c.); *Röntgen Soc., Journal*; *Royal Institute of Public Health* (1886, incorp. 1892), *Journ. Royal Sanitary Institute* (1876, incorp. 1888), the council of which appoints examiners, directs Parkes Museum, founded in 1876 in memory of Dr E. A. Parkes; *Society of Medical Officers of Health* (1856), *Trans. and Public Health*; *Soc. of Public Analysts, Analyst*. The provincial societies are very numerous and include: Bradford, *Med. Chir. Soc.* (1863); Bristol, *Med. Chir. Soc.*; Cardiff, *Med. Soc.* (1870); Liverpool, *Sch. of Tropical Med.* (1898, incorp. 1905), *Memoirs*; Manchester, *Med. Soc.* (1848); Newcastle-upon-Tyne, *North. and Durham Med. Soc.* (1848). Dublin, *Roy. Acad. of Med. in Ireland* (1882), *Trans.* (1883, &c.); *Pharmac. Soc. of Ireland* (1875). Edinburgh, *Roy. Med. Soc.* (1737; charter 1778); *Harveian Soc.* (1752); *Medico-Chirurg. Soc.* (1821), *Trans.* (1824, &c.); and *Obstetrical Soc.* (1840). Aberdeen, *Med. Chir. Soc.* (1789). Glasgow, *Medico-Chirurg. Soc.* (1866), based upon *Med. Soc.* and *Med.-Chirurg. Soc.* (both 1814), joined by *Path. Soc.* in 1907.

AUSTRALIA: Melbourne, *Med. Soc. of Victoria, Austr. Med. Journ.* (1856, &c.). CANADA: Montreal, *Union Méd. du Canada, Revue* (1872, &c.); *Canada Med. Assoc., Trans.* (1877, &c.). INDIA: Bombay, *Med. and Physical Soc., Trans.* (1838, &c.). Calcutta, *Med. Soc., Trans.* (1883, &c.).

UNITED STATES: *Amer. Pub. Health Assoc., Reports* (1873, &c.); *Amer. Dental Assoc., Trans.* (1860, &c.); and *Amer. Inst. of Homoeop., Trans.* (1878, &c.). The headquarters of the *American Medical Association* (1847) are at Chicago; it publishes a *Journal*. The *American Surgical Association* (1880) unites at Washington every third year with the *Congress of American Physicians and Surgeons*. The State medical associations include those of Alabama, *Trans.* (1869, &c.); Georgia, *Trans.* (1873, &c.); Maine, *Trans.* (1853, &c.); Missouri, *Trans.* (1851, &c.); and South Carolina, *Trans.* The State medical societies include those of Arkansas, *Trans.* (1877, &c.); California, *Trans.* (1870, &c.); Illinois, *Trans.* (1851, &c.); Kansas, *Trans.* (1867, &c.); Michigan, *Trans.* (1869, &c.); Minnesota, *Trans.* (1874, &c.); Nebraska, *Trans.* (1869, &c.); New Jersey, *Trans.* (1859, &c.); Pennsylvania, *Trans.* (1851, &c.); Rhode Island, *Trans.* (1877, &c.); Texas, *Trans.* (1874); and Wisconsin, *Trans.* (1880, &c.). To these have to be added the following town associations. Albany, *Med. Soc., Journal* (1807, &c.). Baltimore, *Med. and Chirurg. Faculty of Maryland, Trans.* (1856, &c.). Boston, *Amer. Gynaecolog. Soc., Trans.* (1876, &c.); *Mass. Medico-Legal Soc., Trans.* (1878, &c.). Denver, *Acad. of Med.* (1903). New York, *Acad. of Med., Trans.* (1847, &c.) and *Bull.* (1860, &c.); *Med. Soc., Trans.* (1815, &c.); *Medico-Chirurg. Soc., Trans.* (1878, &c.); *Amer. Surg. Assoc., Trans.* (1883, &c.); *Medico-Legal Soc., Sanitarian* (1873, &c.); *Amer. Ophthalmolog. Soc., Trans.* (1865, &c.); *Path. Soc.* (1844), *Trans.* (1875-1879), *Proc.* (1888, &c.). Philadelphia, *Med. Soc., Trans.* (1850, &c.); *Obstet. Soc., Trans.* (1869, &c.); *Amer. Pharm. Assoc., Proc.*; *Patholog. Soc.* (1857), *Trans.* (1897, &c.); *Coll. of Physicians* (1877); *Amer. Soc. of Tropical Med.* (1903). Richmond, *Med. Soc., Trans.* (1871, &c.).

FRANCE: Besançon, *Soc. de Méd.* (1845), *Bull.* (1845, &c.). Bordeaux, *Soc. de Méd.* (1798), *Journ.* (1829, &c.); *Soc. de Pharm.* (1834), *Bull.* (1860, &c.); *Soc. de Méd. et de Chirurg.*; *Soc. d'Anat. et de Physiol.* (1879), *Bull.* (1880). Caen, *Soc. de Méd.* (1799; known by its present name since 1875), *Journal* (1829), *Mém.* (1869). Chambéry, *Soc. de Méd.* (1848), *Comptes rend.* (1848, &c.) and *Bull.* (1859, &c.). Grenoble, *Soc. de Méd.* Havre, *Soc. de Pharm.* (1858), *Mém.* Lille, *Soc. de Méd.* (1843), *Bull.* (1845, &c.). Lyons, *Soc. Nat. de Méd.* (1789), *Le Lyon méd.* (1869, &c.). Marseilles, *Soc. de Méd.* (1800), *Comptes rend.* (1826-1853) and *Le Mars. méd.* (1869, &c.); *Soc. Méd.-Chirurg.* (1872). Paris, *Soc. de Méd. Pratique* (1808), *Bull.*; *Acad. Nat. de Méd.* (1820); *Soc. Nat. de Chirurg.* (1843, reorganized 1859), *Mém.* (1847, &c.) and *Bull.* (1851, &c.); *Soc. Anat.* (1803), *Bull.* (1826, &c.); *Soc. Clinique, Bull.* (1877, &c.); *Soc. Méd. des Hôpitaux, Bull.* (1849, &c.); *Soc. Méd. Légale*; *Soc. de Pharm.* (1803), *Journ.* (1815, &c.); *Soc. de Thérapeutique*; *Soc. Fran. de Hygiène*; *Soc. Centr. de Méd. Vétérinaire* (1844), *Bull.*; *Assoc. Int. de l'Inst. Marey* (1898) (for examining physiological methods and apparatus), *Bull., Travaux.* Rouen, *Soc. de Méd.* (1821), *Union Méd.* (1861, &c.); *Soc. Libre des Pharmaciens* (1802), *Bull.* Toulouse, *Soc. de Méd.* (1801), *Bull.* and *Revue* (1867, &c.). Tours, *Soc. Méd.* (1801). GERMANY and AUSTRIA-HUNGARY: *Deutscher Ärztevereinsbund* (1872), *Verhandl.*; *Central Ver. d. Zahnärzte* (1859), *Mittheil.*; *D. Veterinärarath* (1874); *D. Apotheker-Ver.* (1820), *Archiv* (1822, &c.). Berlin, *Ver. f. Heilkunde* (1832), *Magazin* (1835, &c.); *Ges. f. Geburtshilfe u. Gynaekologie* (1876), *Ztschr.* (1877, &c.); *Ges. f. Heilkunde* (1855); *Berl. Med. Ges.* (1860), *Verhandl.* (1865, &c.); *Physiolog. Ges.* (1875), *Verhandl.* (1877, &c.); *D. Ver. f. Med. Statistik* (1868); *Ver. Homöop. Ärzte* (1871), *Ztschr.* (1882, &c.); *D. Ges. f. Chirurgie* (1872), *Verhandl.* Bonn, *Verband der Ärztl. Vereine* (1865). Breslau, *Ver. f. Physiolog. Heilkunde* (1848), *Ztschr.* (1850, &c.); *Verband d. Schles. Ärzte-Ver.* (1878). Cologne, *Rhein.*

Med.-Chirurg. Ver. (1848), *Organ* (1852, &c.). Darmstadt, *Ärztl. Kreisver.* (1844). Dresden, *Ges. f. Natur-u. Heil-Kunde* (1818), *Jahresber.* (1848, &c.). Erlangen, *Physik.-Med. Soc.* (1808), *Sitzungsber.* (1870, &c.). Frankfurt, *Ärztl. Ver.* (1845), *Jahresber.* (1857, &c.). Hamburg, *Ärztl. Ver.* (1816); *Deutsche Ges. für Gesch. der Medizin* (1901), *Mittheil.* Hanover, *Ver. Analyt. Chemiker* (1878). Heidelberg, *Ophthal. Ges.* (1857). Jena, *Med.-naturwissenschaftliche Ges.* (1854), *Zeitschr.* (1874, &c.). Königsberg, *Ver. f. wiss. Heilkunde* (1851). Leipzig, *Med. Ges.* (1829); *Ges. f. Geburtshilfe* (1854), *Mittheil.*; *Homöop. Central-Ver.* (1829); Magdeburg, *D. Chirurgen-Ver.* (1844), *Ztschr.* (1847, &c.). Munich, *Ärztl. Ver.* (1833), *Int.-Blatt* (1854, &c.). Strasburg, *Soc. de Méd.* (1842), *Mém.* (1850, &c.); *Soc. Vétérin.* (1864); *Medizinisch-Naturwissenschaftlicher Ver.* (1873). Stuttgart, *Württemberg. Ärztl. Ver.* (1831), *Corr.-Blatt* (1832, &c.); *Hahnemannia* (1868), *Mittheil.* (1873, &c.); *Apotheker-Ver.* (1822), *Pharm. Wochenblatt* (1861, &c.). Vienna, *K. k. Ges. der Ärzte, Ztschr.* (1844, &c.); *Ges. für innere Medizin u. Kinderheilkunde, Med. Wochenschrift.* Weimar, *Med.-naturwiss. Ver.* (1863). WÜRZBURG, *Physikal.-med. Ges.* (1849), *Verhandl.* (1850, &c.). SWITZERLAND: Geneva, *Soc. Méd.* Zürich, *Soc. de Méd.*; *Schweiz. Apotheker-Ver.* ITALY: Bologna, *Soc. Med.-chirurg.* Genoa, *Accad. Med.-chirurg.* Milan, *Soc. Ital. d' Igiene.* Modena, *Soc. Med.-chirurg.* Naples, *Real Accad. Med.-chirurg.* Palermo, *R. Accad. delle Sc. Med.* (1649), *Atti* (1889, &c.). Rome, *R. Istii. Fisico-patologico.* Turin, *Accad. Real Med.-chirurg.* BELGIUM: Antwerp, *Soc. de Méd.* (1839), *Annales.* Brussels, *Acad. Roy. de Méd.* (1841), *Bull.* (1841, &c.) and *Mém.* (1843, &c.); *Soc. Roy. de Pharm.* (1845), *Bull.*; *Soc. d'Anat. Patholog.* (1846), *Annales*; *Soc. Belge de Méd. Homöop.*; *Soc. Roy. des Sc. Méd. et Nat.* (1822), *Journal* (1842, &c.), *Annales* (1892, &c.), *Bulletin* (1843, &c.); *Inst. Solway de Physiol.* (1894), with electro-physiological, chemical, embryological and other laboratories, and lecture hall. Ghent, *Soc. de Méd.* (1834), *Annales.* Liège, *Soc. Méd.-chirurg.* HOLLAND: Amsterdam, *Genootschap ter Beoordering der Genees-en Heel-Kunde, Verhandl.* (1841, &c.); *Nederl. Maatschappij ter Beoord. der Pharmacie.* Batavia (Java), *Geneeskundige Vereeniging.* DENMARK: Copenhagen, *K. Med. Selskab*; *Veterinær Selskab.* NORWAY: Christiania, *Med. Selskab, Magazin* (1840, &c.). SWEDEN: Stockholm, *Farmaceutiska Inst.*; *Svenska Läkaresällskapet* (1808), *Handl.* (1813, &c.). Upsala, *Läkareförenig, Förhandl.* (1865, &c.). SPAIN: Madrid, *R. Acad. Med.* (1732). PORTUGAL: Lisbon, *Soc. de Sc. Med.* (1835), *Jornal* (1835, &c.); *Soc. Pharm. Lusitana.* RUSSIA: Dorpat, *Pharm. Soc.* Helsingfors, *Finska Läkaresällskapet* (1835), *Handl.* (1841). Moscow, *Phys.-med. Soc.* Riga, *Soc. of Practical Physicians.* St Petersburg, *Soc. of Practical Physicians*; *Imp. Pharm. Soc.* Vilna, *Imp. Med. Soc.* (1805), *Protokolj.* Warsaw, *Med.-Chirurg. Soc.* Tomsk (Siberia), *Soc. of Naturalists and Physicians* (1889), *Protocol.* RUMANIA: Jassy, *Soc. of Naturalists and Physicians* (1830), *Buletinul.* GREECE: Athens, *Soc. Méd.* TURKEY: Constantinople, *Soc. Imp. de Méd.*; *Soc. de Pharm.* CENTRAL and SOUTH AMERICA: Buenos Aires, *Asoc. Med.* Caracas, *Escuela Med.* Guadaluajara (Mexico), *Soc. Med.* Merida (Mexico), *Soc. Med.* Mexico, *Acad. de Med.*; *Soc. Med.* Monte Video, *Soc. de Med.* Rio de Janeiro, *Instituto Oswaldo Cruz*, formerly *Instituto de Manguinhos* (for the promotion of experimental pathology); *Soc. Med. e Cirurgia.* Santiago, *Soc. Med.* JAPAN: Tokyo, *Soc. for Adv. of Med. Sc., Trans.* (1885, &c.).

XIV. ENGINEERING AND ARCHITECTURE

The principal English society dealing with mechanical science is the *Institution of Civil Engineers* (established in 1818, incorporated in 1828), which publishes *Transactions* (4to, 1836-1842) and *Minutes of Proceedings* (8vo, 1837, &c.). George Stephenson was the first president of the *Institution of Mechanical Engineers*, which was founded at Birmingham in 1847, removed to London in 1877, and registered under the Companies Act in 1878. It holds migratory meetings and publishes *Proceedings*. The *Society of Engineers* (1854), with *Transactions* (1861, &c.); the *Civil and Mechanical Engineers' Society* (1859); the *Iron and Steel Institute* (1869, incorp. 1899), with *Journal* and *Mem.*; the *Surveyors' Institution* (1868, incorporated in 1881), which publishes *Transactions* and holds professional examinations; the *Aeronautical Society of Great Britain* (1866), the *Institution of Electrical Engineers* (1871, incorp. 1883), *Journal*; the *Institution of Mining Engineers* has associated with it many branch institutions in the provinces, *Journal*; the *Institute of Gas Engineers* (1863); the *Illuminating Engineers' Soc.* (1909); the *Institute of Metals*; and the *Instn. of Mining and Metallurgy*, meet in London. There are institutions in the provinces at Bradford, Bristol, Cardiff (1857, incorp. in 1881), Chesterfield (1871), Dublin (1835, incorp. in 1857), Glasgow (1857, with *Transactions*), Liverpool (1875), Middlesbrough (1864), Newcastle-upon-Tyne (1852, incorp. in 1876, with *Transactions*), Nottingham (1871), Dudley (1866), and Belfast (1892).

The leading architectural society is the *Royal Institute of British Architects*, founded in 1834, incorporated in 1837, and granted new charters in 1887 and 1908. It appoints examining professional boards and publishes *Transactions* (1836; 1879, &c.) and *Proceedings* (1879, &c.). There are also the associations of Birmingham (1873), Edinburgh (1850), Exeter (1843), Glasgow (1868), Leeds (1876), Leicestershire (1855), Liverpool (1848), Manchester (1875), Newcastle-upon-Tyne, and the societies of Manchester (1865) and Oxford (1837).

The *Architectural Association of London* publishes a *Sketch Book* (1870, &c.). The *Architectural Publishing Society* (1848) has published *Essays* (1848-1852), and since 1852 has been bringing out a *Dictionary of Architecture*. There is also a *Society of Architects* (1884, incorp. 1893). The *Roy. Inst. of Architects of Ireland* meets in Dublin and publishes a *Journal*.

UNITED STATES: New York, *Inst. of Mining Engineers. Amer. Soc. of Civ. Eng. Trans.; Amer. Soc. of Mech. Eng., Trans.; Amer. Inst. of Min. Eng.; Amer. Inst. of Architects* (1857); Washington, *Society of Naval Eng.* FRANCE: Lyons, *Soc. Acad. d'Arch.* (1830), *Annales* (1867, &c.). Paris, *Soc. des Ingénieurs Civils, Annuaire* (1848, &c.); *Soc. Cent. des Architectes, Bull.* (1851, &c.) and *Annales* (1875, &c.); it has held a congress since 1875. Saint-Étienne, *Soc. de l'Industrie Min.* (1855), *Bull.* GERMANY and AUSTRIA-HUNGARY: Berlin, *Ver. Deutscher Ingenieure, Ztschr.* (1857) and *Wochenschrift* (1877, &c.); *Ver. f. Eisenbahnkunde; Akad. des Bauwesens; Architekten-Ver., Ztschr.* Breslau, *Ver. f. Ges. der Bild. Künste* (1862). Constance, *Münsterbau Ver.* (1881). Dresden, *Sächs. Ingen.-u. Architekten-Ver., Protok.* Hanover, *Arch.-u. Ingen. Ver., Ztschr.* Klagenfurt, *Berg- und Hütten-Männischer Ver.* Leoben, *K. k. Berg-Akad.* Munich, *Bayr. Arch.- u. Ingen.-Ver., Ztschr.* Prague, *Arch.- und Ingen.-Ver.* Vienna, *Österr. Ingen.- u. Arch. Ver., Ztschr.; Ges. f. Bild. Künste.* SWITZERLAND: Lausanne, *Soc. Vaudoise des Ingén. et des Arch.* Zürich, *Ver. Schweiz. Ingen. u. Arch. Italy:* Turin, *Soc. degli Ingeneri, Atti* (1868-1870). BELGIUM: Brussels, *Assoc. des Ingén. Liège, Assoc. des Ingén.* (1847), *Annuaire* (1851, &c.). HOLLAND: Amsterdam, *Maatschappij ter Bevordering der Bouwkunst, Bouwkundige Bijdragen* (1843, &c.). The Hague, *Kon. Inst. van Ingen., Verslag* (1848, &c.), *Verhandel.* (1848, &c.) and *Tijdschr.* (1870, &c.). SPAIN and PORTUGAL: Lisbon, *Assoc. dos Engenheiros Civ. Port.; Soc. dos Architectos e Archeologos.* Madrid, *Soc. Central de Arquitectos.*

XV. NAVAL AND MILITARY SCIENCE

The *Royal United Service Institution*, first known as the *Naval and Military Library and Museum* (1831), took the name of the *United Service Institution* in 1839, and was incorporated in 1860; its professional museum is housed in the banqueting hall at Whitehall; it publishes a *Journal* (1857, &c.). The *Institution of Naval Architects* (1860) publishes *Transactions* (4to, 1860, &c.). The *Royal Artillery Institution* (1838), which issues *Minutes of Proceedings* (1858, &c.), is at Woolwich, and the *Royal Engineers' Institute* (1875), which issues *Royal Engineers' Professional Papers*, at Chatham. The *Navy Records Soc.* (1893) publishes works connected with the history of the British Navy. CANADA: Toronto, *Military Inst.* INDIA: Simla, *United Service Institution.*

UNITED STATES: New York, *Military Service Inst.* (1877), *Journal* (1879, &c.); *Soc. of Naval Architects and Marine Eng., Proc.* Annapolis, *U.S. Naval Institute* (1873), *Proc.* FRANCE: Paris, *Réunion des Officiers, now Cercle Militaire, Bull.* (1871, &c.). GERMANY and AUSTRIA-HUNGARY: Munich, *Militär. Ges.* (1868), *Jahrbuch.* (1871, &c.). Vienna, *K. k. Milit.-Geogr. Inst., Arbeiten* (1871, &c.). HOLLAND: Utrecht, *Vereen. tot Verspreiding van Kennis aangaande s'Lands Verdediging, Jaarsverslag* (1872, &c.) and *Werken.* NORWAY: Christiania, *Militære Samfund, Nordsk Milit. Tidsskrift* (1848, &c.). DENMARK: Copenhagen, *Krigsvidenskabelige Selskab, Milit. Tidsskrift* (1872, &c.).

XVI. AGRICULTURE AND TRADES

The *Royal Agricultural Society of England* began as the *English Agricultural Society* in 1838 and was incorporated in 1840. It holds annually one migratory meeting in some part of England or Wales and meetings in London, where are its headquarters; it publishes a *Journal* (1840, &c.). Among provincial agricultural societies and associations may be mentioned—Aberdeen, *Roy. Northern Agr. Soc.* (1843). Arbroath, *Angus Agr. Assoc.* Banbury (1834). Basingstoke, *Roy. Counties Agr. Soc.* (1859). Bath, *Bath and West of Engl. Soc. and Southern Counties Assoc.* (founded in 1777, enlarged in 1852, and reorganized in 1866), *Letters and Papers* (1780-1816) and *Journal* (1852, &c.). Belfast, *Chemico-Agr. Soc. of Ulster* (1845), *Proc.; N.E. Agr. Assoc. of Ireland.* Birkenhead, *Wirral and Birkenhead Agr. Soc.* (1842). Brecknock (1855). Carlisle (1833). Chelmsford, *Essex Agr. Soc.* (1858). Chertsey (1833). Doncaster (1872). Dublin, *Roy. Agr. Soc. of Ireland* (1841). Edinburgh, *Highland and Agr. Soc. of Scotland* (1784, incorporated in 1787), *Trans.* (1799, &c.). Halifax (1839, enlarged in 1858). Ipswich, *Suffolk Agr. Assoc.* (1831). Otley, *Wharfedale Agr. Soc.* Paisley, *Renfrewshire Agr. Soc.* (1802). Warwick, *Worcester* (1838). AFRICA: Cape Town, *Agr. Soc.* AUSTRALIA: Sydney, *Agr. Soc. of N. S. Wales.* BRITISH GUIANA: Georgetown, *Roy. Agr. and Commercial Soc.* CANADA: Montreal, *Soc. d'Agr.* INDIA: Calcutta, *Agr. and Hort. Soc., Journ.* (1842, &c.).

UNITED STATES: There were agricultural societies formed at Philadelphia and in South Carolina in 1785. The *New York Soc. for the Promotion of Agriculture, Arts and Manufactures* (1791), the *Massachusetts Soc. for Prom. Agriculture* (1792), and *Columbian Agr. Soc.* (1809), issued publications. Albany, *State Agr. Soc.* (1832), *The Cultivator and Journal.* Atlanta, *State Agr. Soc.* Boston, *Inst. of Technology.* Hoboken, *Stevens Inst. of Technol.* Madison, *State Agr. Soc., Trans.* (1852, &c.). Sacramento, *Soc. of Agr. and Hort. San*

Francisco, *Agr. and Hort. Soc.* Troy, *Rensselaer Polytechnic Inst.* (1824). Worcester, *Polytechnic Institute* (1865), *Journ.* (1807, &c.).

FRANCE: Algiers, *Soc. d'Agr.* (1840), *Bull.* Agen, *Soc. d'Agr.* (1776), *Rec.* (1800, &c.). Amiens, *Soc. Industrielle* (1861), *Bull.* Angers, *Soc. d'Agr.* (1799), formerly *Acad. d'Angers, Proc.-verb.* (1846-1854), *Mém.* (1831, &c.), *Documents* (1896, &c.). Bordeaux, *Soc. d'Agr.* Boulogne, *Soc. d'Agr.* Caen, *Assoc. Normande pour l'Agr., l'Industrie, &c.* (1831), *Annuaire* (1835, &c.); *Soc. d'Agr. et de Commerce* (1762), *Mém.* (1853-1858) and *Bull.* (1827, &c.). Châlons-sur-Marne, *Soc. d'Agr., &c.* (1750), *Comptes rendus* (1807-1855), *Mém.* (1855, &c.). Douai, *Soc. d'Agr., &c.* (1799), *Souv.* (1861-1885), *Mém.* (1826, &c.). Elbeuf, *Soc. Industr.* (1858), *Bull.* Grenoble, *Soc. d'Agr. et d'Hortic.* (1835), *Sud-Est* (1855, &c.). Le Mans, *Soc. du Matériel Agr.* (1857), *Bull.* Lyons, *Soc. des Sc. Industr.* (1862), *Annales.* Montpellier, *Soc. d'Agr.* (1799), *Bull.* (1808, &c.). Nancy, *Soc. Centr. d'Agr.* Paris, *Soc. Nat. d'Agr. de France* (1761; reconstructed in 1878 with a view of advising Government on agricultural matters), *Mém.* and *Bull.* Perpignan, *Soc. Agr. Scientifique et Litt.* (1833), *Bull.* (1834, &c.). Reims, *Soc. Industr.* (1833), *Bull.* (1858, &c.). Rouen, *Soc. Industr.* (1872), *Bull.; Soc. Libre d'Emulation, Commerce et Industrie* (1790), *Bull.* (1797). Saint-Jean-d'Angély, *Soc. d'Agr.* (1819), *Bull.* (1833, &c.). St Quentin, *Soc. Industr.* (1868), *Bull.* Toulouse, *Soc. d'Agr. Vesoul, Soc. d'Encouragement d'Agr.* (1883), *Bull.* GERMANY and AUSTRIA-HUNGARY: The migratory *Congress Deutscher Volkswirthe* first met at Gotha in 1858. Agram, *Kroatisch-Slav. Landwirths. Ges., Blätter.* Augsburg, *Landwirths. Ver., Landw. Blätter.* Berlin, *Vereinigt. Berliner Kaufleute u. Industr.; Bonn, Landwirthsch. Central-Ver.* Bremen, *Landwirths. Ver.* Breslau, *Landwirths. Central-Ver.; Schles. Central Gewerbe-Ver.* Budapest, *Ungar. Ackerbau Ges. Mittheil.; Industrielle Ges.* Cassel, *Landwirths. Central-Ver., Mittheil.* Cracow, *Ackerbau Ges., Annalen.* Danzig, *Volkswirths. Ges.* (1850). Darmstadt, *Landwirths. Ver., Ztschr.* Dresden, *K. Ökonomie Ges.; K. Sächs. Polytechnicum.* Fürth, *Gewerbe-Ver.* Gratz, *K. k. Steiermarkische Landwirths. Ges.* Greifswald, *Baltischer Central-Ver.* Halle, *Landwirths. Central-Ver.* Hanover, *Gewerbe-Ver.* Innsbruck, *K. k. Landwirths. Ges., Wochenschr.; Kämt. Industrie- u. Gewerbe-Ver.* Jena, *Landwirths. Inst.* Kassa, *Magyar Kir. Gazdasági Akad.* or Academy for Agriculture. Klausenburg, *Magyar Kir. Gazdasági Akad.* (1869). Königsberg, *Ostpreuss. Landwirths. Central-Ver.* Leipzig, *Landwirths. Kreis-Ver.; Polytechn. Ges.* Linz, *K. k. Landwirths. Ges.* Lübeck, *Landwirths. Ver., Mittheil.* Mühlhausen, *Soc. Industr., Bull.* Munich, *Landwirths. Kreis-Ver.; Polytechn. Ver.* Nuremberg, *Polytechn. Ver.* Prague, *Böhmischer Gewerbe-Ver.; Industrie Ges., Mittheil. and Annalen.* Ratisbon, *Landwirths. Kreis-Ver., Bauernfreund.* Stuttgart, *K. Württemb. Central-Stelle, Wochenblatt.* Trieste, *Ackerbau Ges.* Tübingen, *Landwirths. Ver.* Vienna, *K. k. Reichs Landwirths. Ges., Ztschr.* Wiesbaden, *Gewerbe-Ver.* SWITZERLAND: Bern, *Ökonom. Ges.* Lausanne, *Soc. d'Agr. de la Suisse Romande.* Zürich, *Ver. f. Landwirths. u. Gartenbau.* ITALY: Bologna, *Soc. Agraria, Annali.* Cagliari, *Soc. Agr. ed Econom.* Florence, *Soc. Econom. ed Agr., Rendiconti.* Milan, *Soc. Agr. di Lombardia; Soc. Gen. degli Agricolt. Ital.; Soc. d'Incoragg. di Arti e Mestieri, Discorsi.* Perugia, *Soc. Econom. ed Agr., Atti.* Turin, *Accad. Reale di Agricolt.; Assoc. Agr. Ital., Esercitazioni.* Verona, *Accad. d'Agricoltura.* BELGIUM: *Soc. Centr. d'Agricult.* (1854), *Bull.* Ghent, *Soc. Roy. d'Agr. et de Bot.* Liège, *Soc. d'Agr., Journ.* (1850, &c.). Verviers, *Soc. Industr. et Commerc.* (1863), *Bull.* HOLLAND: Amsterdam, *Aardrijkskundig Genootschap; Vereeniging voor Volksvijf.* DENMARK: Copenhagen, *K. Landhuusholdnings Selskab; Det Statist. Tabelværk.* NORWAY: Christiania, *Polytekniske Forening.* SWEDEN: K. Landbruks Akademien. SPAIN and PORTUGAL: Barcelona, *Soc. Econom., Actas.* Lisbon, *Inst. Real de Agric.; Soc. Promotora de Industr.* Madrid, *Soc. Econom. Matriense, Anales.* Oporto, *Acad. Polytechn.* RUSSIA: Dorpat, *K. Lwländische Ökonom. Ges., Jahrbuch.* Kazan, *Imp. Econom. Soc.* Moscow, *Imp. Soc. of Agriculturists.* Odessa, *Imp. Agronom. Soc. of S. Russia.* Riga, *Technical Soc.* St Petersburg, *Imp. Econom. Soc., Trans.* Tiflis, *Technical Soc.* RUMANIA: Bucharest, *Soc. Politehnică* (1881), *Buletinul.* SOUTH AMERICA: Rio de Janeiro, *Soc. de Agr.*

XVII. LITERATURE, HISTORY AND ARCHAEOLOGY

The *Congrès International des Orientalistes* first met at Paris in 1873. The *Congrès Bibliographique International* held its first meeting in 1878, and the *Congrès des Américanistes* its first meeting in 1875. The first *Internat. Conference of Librarians* took place in London in 1877. Congresses of Archivists, Librarians and Bibliographers were held at Brussels in 1910. The *Royal Society of Literature* (1823, incorporated in 1825) with *Transactions* (4to, 1829-1839; 8vo, 1843, &c.), and the *Royal Asiatic Society* (1823), with *Journal* (1834, &c.), have their headquarters in London, as well as the following literary societies, all of which issue publications: *Aristotelian* (1879), *Ballad* (1868), *Chaucer* (1868), *Dante* (1881), *Early English Text* (1864), *East India Association* (1866), *Hellenic Studies* (1879), *Incorp. Soc. of Authors* (1884), *Institute of Journalists, Irish Lit., Japan* (1892), *Library Association* (1877), *Library Assistants* (1895), *Malone* (1906), *Oriental Translation Fund* (1828), *Pali Text* (1882), *Philological* (1842), *Roxburghe Club* (1812), *Shorthand, Viking Club* (1892), *Wyclif* (1882). The *Lancashire and Cheshire Historic Society* (1848), at Liverpool, the *Manchester Literary Club*, with

Transactions and Papers (1874, &c.), and the *Manx Society* (1858), at Douglas, may also be mentioned. In Glasgow are the *Ballad Club* (1876), and the *Scottish Soc. of Lit. and Art* (1886), and in Dublin the *Nat. Lit. Soc. of Ireland* (1892).

The oldest and most important society in England dealing with history and archaeology is the *Society of Antiquaries of London*, which enthusiasts trace to an association founded by Archbishop Parker in 1572. The meetings were not publicly recommenced until 1707; the present body was incorporated in 1751; it publishes *Vetera Monumenta* (fol., 1747, &c.), *Archæologia* (4to, 1770, &c.), and *Proceedings* (8vo, 1849, &c.). The *Royal Archaeological Institute* (1843), issuing the *Archæological Journal* (1845, &c.); the *British Archaeological Association* (1843), with *Journal* (1846, &c.); the *Royal Numismatic Society* (1836), issuing the *Numismatic Chronicle* (1838, &c.); and the *Royal Historical Society* (1868), publishing *Transactions*, and the works of the *Camden Society* (1838), belong to London, as well as the following societies, all of which issue publications: *Bibliographical* (1892), *British School at Athens*, *British School at Rome*, *British Record* (1888, incorp. 1893, incl. *Index Soc.* 1878), *Canterbury and York Catholic Record* (1904), *Egypt Expl. Fund* (1883), *Genealog. and Biogr.*, *Cymmrodorion* (1751-1773, revived in 1820), *Dilettanti* (1734), *Folk Lore* (1879), *Harleian* (1869), *Huguenot* (1885), *London and Middlesex Archæol.* (1855), *London Topogr. Soc.*, *Middlesex County Records* (1884), *Palæographical*, *Palestine Expl. Fund*, *Parish Registers*, *Pipe Roll* (1883), *Soc. Bibl. Archæol.* (1870), *Soc. for Prot. Anc. Buildings* (1877). Outside London are the *Roy. Soc. of Antiquaries of Ireland* founded in 1849 as the *Kilkenny Arch. Soc.*, changed to *Roy. Hist. and Arch. Assn.* in 1869 and to present title in 1890; the *Society of Antiquaries of Scotland* (1780), at Edinburgh, and the *Irish Archaeological and Celtic Society*, at Dublin. Among others are—Aberdeen, *New Spalding Club* (1886); *Bedfordshire Archaeological and Architect. Soc.* (1844); *Bristol, Bristol and Gloucester Arch. Soc.* (1876); *Cambrian Arch. Assoc.* (1846); *Cambridge Antiq. Soc.* (1840); *Carlisle, Cumb. and Westm. Antiq. and Arch. Soc.* (1866); *Devises, Wiltshire Arch. and Nat. H. Soc.* (1853); *Durham, Surtees Soc.* (1834); *Colchester, Essex Arch. Soc.* (1852); *Edinburgh, Bibliogr. Soc.* (1890), *Scottish Hist.* (1886); *Exeter, Diocesan Arch. Soc.* (1841); *Glasgow Arch. Soc.* (1856); *Kent Arch. Soc.* (1857); *Lanc. and Cheshire Antiq. Soc.* (1883). *Leeds Thoresby Soc.* (1889); *Manchester, Chetham Soc.* (1843); *Newcastle-on-Tyne Soc. of Antiq.* (1813); *Norwich, Norfolk and Norwich Arch. Soc.* (1846); *Oxford, Architect. and Hist. Soc.* (1839), and *Hist. Soc.* (1884); *Parbeck Soc.*; *Reading, Berkshire Arch. and Architectural Soc.* (1871); *Surrey Arch. Soc.*; *Sussex Arch. Soc.* (1846); *Welshpool, Powys Land Club* (1867); and *Yorkshire Arch. Soc.* (1863).

CANADA: *Halifax, Nova Scotia Hist. Soc.* (1878), *Coll. Montreal, Soc. Hist.*, *Mém.* (1859, &c.); *Numism. and Antiq. Soc.* (1872), *Journ.* (1872, &c.). *Quebec, Lit. and Hist. Soc.* (1824), *Trans.* (1837, &c.). *Toronto, Ontario Hist. Soc.* (1888, 1898), *Rep.*; *Lit. and Hist. Soc.* CHINA: *Hong-Kong, Roy. Asiatic Soc.* *Shanghai, Roy. Asiatic Soc.*, *Journ.* (1858, &c.). INDIA: *Bombay, Roy. Asiatic Soc.* (Branch) (1804), *Journal* (1844, &c.). *Calcutta, Asiatic Society of Bengal, Journ.* (1832, &c.) and *Proc.* (1865, &c.); *Indian Research Soc.* (1907), *Trans. Colombo, Roy. Asiatic Soc.*, *Journ.* (1844, &c.). *Madras, Lit. Soc.* (1818), *Journal* (1827, &c.). *Singapore, Roy. Asiatic Soc.*

UNITED STATES: The central antiquarian body in the United States is established at Washington—the *Archæological Institute of Amer.* (1879), which publishes *Amer. Journ. Arch.* (1897, &c.), and has affiliated with it 28 societies, including the *Boston Society* (1879), *Cincinnati Soc.* (1905), *Iowa Soc.* (1902), *Wisconsin Soc.* (1889), *New York Soc.* (1884), *San Francisco* (1906), *North West Soc.* (Seattle) (1906). *Albany, Institute and Hist. and Art Soc.*, *Trans.* (1792-1819, 1830-1893), *Proc.* (1865-1882). *Baltimore, Maryland Hist. Soc.* (1844). *Boston, Mass. Hist. Soc.* (1791), *Collections* (1792, &c.) and *Proc.* (1859, &c.); *New Engl. Hist.-Gen. Soc.* (1845), *Genealog. Register* (1847); *Amer. Oriental Soc.* (1843), *Journ.* (1849, &c.); *Amer. Library Assoc.* (1876), *Liby. Journal*; *Soc. Bibl. Lit. and Exegesis* (1880), *Journal* (1882, &c.); *Bostonian Soc.* (1881), *Proc.* (1882, &c.). *Brookline Hist. Soc.* (1891). *Buffalo, Hist. Soc.* (1862). *Cambridge, Hist. Soc.* (1905), *Proc.* (1906, &c.); *Dante Soc.* (1881). *Chicago, Hist. Soc.* (1856). *Cincinnati, Hist. and Phil. Soc. of Ohio* (1831), *Publtns.* (1906). *Concord, Hist. Soc.*, *Coll.* (1824, &c.). *Frankfort, Kentucky State Hist. Soc.* (1836), *Reg. Hartford, Amer. Philolog. Soc.* (1869); *Hist. Soc.* (1825), *Coll.* (1860, &c.). *Lincoln, Nebraska State Hist. Soc.* (1867), *Trans.* (1885-1893), *Proc.* (1894, &c.). *Madison, Hist. Soc.*, *Coll.* (1849, &c.). *Minneapolis, Hist. Soc.*, *Coll.* (1869, &c.). *Montpelier, Hist. Soc. of Vermont, Coll.* (1869, &c.). *New Haven, Amer. Orient. Soc.* (1842), *Journal* (1849, &c.). *New Orleans, Louisiana Hist. Soc.* (1867), *Publtns.* (1895, &c.). *New York, Hist. Soc.* (1804), *Publtns.* (1868, &c.); *Geneal. and Biogr. Soc.* (1869), *Record* (1870); *Bibliogr. Soc.* (1904), *Proc.* (1906, &c.), *Bull.* (1907, &c.); *Amer. Numis. Soc.*, *Proc.* (1882). *Philadelphia, Hist. Soc.* (1824), *Mem.* (1826, &c.); *Numism. and Arch. Soc.* (1858), *Proc.* (1867, &c.); *Shakspeare Soc.* (1852). *Portland, Maine Hist. Soc.*, *Coll.* (1831, &c.). *Providence, Hist. Soc.* (1822), *Coll.* (1827, &c.). *Richmond, Virg. Hist. and Phil.* (1831), *Publ.* (1874, &c.). *St. Louis, Missouri Hist. Soc.* (1866), *St. Paul, Minnesota Hist. Soc.* (1849), *Coll.* *Savannah, Georgia Hist. Soc.* (1839), *Proc.* *Topeka, Hist. Soc.* (1875), *Trans.* (1881, &c.). *Washington, Arch. Soc.* (1902); *Columbia*

Hist. Soc. (1894), *Rec.*; *Amer. Hist. Assn.* (1884), *Amer. Hist. Rev.* (1895, &c.). *Worcester, Amer. Antiq. Soc.* (1812), *Proc. and Arch. Amer.* (1820, &c.).

FRANCE: The *Congrès Archéologique de la France* first met in 1834. *Algiers, Soc. Hist.* (1856), *Revue* (1856, &c.). *Amiens, Soc. des Antiq.* (1836), *Mém.* (1838, &c.) and *Bull.* *Angoulême, Soc. Arch. et Hist.* (1844), *Bull.* *Bordeaux, Soc. Archéol.* (1873); *Soc. des Arch. Hist.* (1858), *Archives Hist.* (1858, &c.). *Bourges, Soc. Hist. et Litt.* (1849), *Bull. et Mém.* (1852, &c.). *Caen, Soc. des Antiq. de Normandie* (1823), *Mém.* (1824, &c.) and *Bull.* (1860, &c.); *Soc. Fran. d'Arch.* (1834), *Comptes rend.* (1834, &c.) and *Bull. Mens.* (1835, &c.). *Chalon-sur-Saône, Soc. d'Hist. et d'Arch.* (1844), *Mém.* (1844, &c.). *Chambéry, Soc. Savoisiennne d'Hist. et d'Arch.* (1855), *Mém.* (1856, &c.). *Constantine, Soc. Arch.* (1852), *Recueil.* *Dijon, Comm. des Antiquités* (1831), *Mém.* (1882, &c.). *Lille, Comm. hist. du Nord* (1839), *Bull.* (1843, &c.). *Limoges, Soc. Hist. et Arch.* (1845), *Bull.*; *Soc. des Archives hist.* (1886), *Archives* (1887, &c.). *Lyons, Soc. Hist., Litt. et Arch.* (1807), *Mém.* (1860, &c.). *Montpellier, Soc. Arch.* (1833), *Mém.* (1835, &c.). *Nancy, Soc. d'Arch. de Lorraine* (1845), *Mém.* (1850, &c.) and *Journ.* (1852, &c.). *Nantes, Soc. Arch.* (1845), *Bull.* (1859, &c.). *Orleans, Soc. Arch. et Hist.* (1848), *Mém.* (1851, &c.) and *Bull.* *Paris, Soc. Nat. des Antiq. de Fr.* (1813) (based on the *Académie Celtique*, 1804), *Mém.* (1805, &c.) and *Bull.* (1817, &c.); *Soc. de l'Hist. de France* (1833), *Annuaire* (1837) and nearly 400 vols. besides; *Soc. de l'École Nat. des Chartes* (1839), *Documents* (1873, &c.); *Soc. Asiatique* (1822), *Journal Asiat.* (1822, &c.), &c.; *Soc. d'Arch. et de Numism.* (1865); *Soc. de l'Hist. du Prot. Fran.* (1866); *Soc. de Linguistique*; *Soc. Bibliogr.* (1868), *Polybiblion.*; *Soc. Philol.* (1867), *Actes* (1869, &c.); *Soc. des Études Hist.* (1833), *Revue* (1834, &c.); *Soc. d'Hist. Moderne* (1901), *Bull.*; *Soc. d'Hist. Contemp.* (1890); *Soc. de l'Hist. de la Révolution Fran.* (1888); *Soc. d'Hist. Diplomatique* (1886); *Soc. des Bibliophiles Fran.* (1820); *Soc. des Anciens Textes Fran.* (1875), *Bull.* *Poitiers, Soc. des Antiq.* (1834), *Mém.* *Rouen, Soc. de l'Hist. de Norm.* (1869), *Bull.* (1870, &c.) and 75 vols. besides; *Comm. des Antiquités* (1818), *Bull.* (1867, &c.). *Saint-Omer, Soc. des Antiq.* (1831), *Mém.* (1833, &c.). *Toulouse, Soc. Arch.* (1831), *Mém.* (1831-1868), *Bull.* (1869, &c.); *Acad. des Jeux floraux* (1323, reorganized 1773), *Rec.* (1696, &c.). *Tours, Soc. Arch.* (1840), *Mém.* (1842, &c.). GERMANY and AUSTRIA-HUNGARY: *Gesam. Ver. d. D. Gesch. u. Alt. Vereine* (1852). *Agram, Ges. f. Süd-Slav. Alterth.* *Aix-la-Chapelle, Geschichtsver.* (1879), *Ztschr.* (1879, &c.). *Altenburg, Gesch. u. Alterthums Ges.* (1838), *Mittheil.* (1841, &c.). *Augsburg, Hist. Ver.* (1820, reorganized in 1834), *Jahresber.* (1835, &c.). *Baden, Alterthums-Ver.* (1844), *Schriften.* *Bamberg, Hist. Ver.* (1830), *Ber.* (1834, &c.). *Berlin, Ver. f. Gesch. d. Mark Brandenburg.* (1836), *Forschungen* (1841, &c.); *Ver. f. d. Gesch. Berlins* (1865), *Schriften*; *Hist. Ges.* (1871), *Mittheil.* (1873, &c.); *Archäolog. Ges.* (1842), *Sitzungsber.*, *Archäol. Zeitung*; *Numism. Ges.* (1843), *Jahresber.* (1845, &c.), *Herold* (1869); *Phil. Ges.* (1843), *Der Gedanke* (1861, &c.); *Ges. f. D. Philologie* (1877), *Jahresber.* (1879, &c.); *D. Bibliogr. Ges.* (1902), *Ztschr.* (1903, &c.); *Ver. D. Bibliothekare* (1900), *Jahrbuch* (1902); *D. Orient-Ges.* (1898), *Mittheil.* *Bonn, Ver. f. Alterth.* (1841), *Jahresber.*; *Soc. Philologa* (1854). *Brandenburg, Hist. Ver.* (1868), *Jahresber.* (1870, &c.). *Braunsberg, Hist. Ver.* (1856). *Breslau, Ver. f. Gesch. u. Alt. Schl.* (1846), *Ztschr.* (1856, &c.), *Scriptores rerum Silesicarum* (1847, &c.); *Breslauer Dichterschule* (1860). *Budapest, Hungarian Hist. Soc.* (1867), *Századok.* *Cassel, Ver. f. Hess. Gesch.* (1834), *Ztschr.* (1837, &c.). *Cologne, Hist. Ver.* (1854), *Annalen* (1855, &c.); *Ges. für rheinische Geschichtskunde* (1881). *Cracow, Hist. Soc.* *Danzig, Westpreuss. Geschichtsver.* (1879), *Ztschr.*, *Mitteil.*, *Akten.* *Darmstadt, Hist. Ver.* (1834), *Archiv* (1835, &c.). *Dresden, K. Sächs. Alt. Ver.* (1825), *Jahresber.* (1835, &c.) and *Mittheil.* (1835, &c.). *Frankfort, Ges. f. Deutschlands all. Geschichtskunde* (1819; since 1875 under guidance of *Central-Dir. d. Mon. Germ.*, *Mon. Germ.* (1826, &c.); *Ges. f. Gesch. u. Kunst in Germ.* (1837), *Mittheil.* (1858, &c.); *Freies D. Hochstift in Goethe's Vaterhaus* (1859); *Ver. für Gesch. u. All.* (1857), *Archiv. Halle, Thür.-Sächs. Ver.* (1819), *Mittheil.* (1822, &c.); *D. Morgenl. Ges.* (1844), *Ztschr.* (1847, &c.) and *Abhandl.* (1859, &c.). *Hanover, Hist. Ver.* (1835), *Ztschr.* *Kiel, Ges. f. Gesch. Schl.-Holst.* (1833, reorganized in 1873), *Archiv* (1833, &c.) and *Ztschr.* (1870, &c.). *Königsberg, Altertums-Ges. Prussia* (1844), *Sitzungsber.* *Leipzig, D. Ges. z. Erforschung vaterl. Spr. u. Alterth.* (1697, reorganized in 1824), *Jahresber.* (1825, &c.) and *Mittheil.* (1845, &c.); *Fürstlich Jablonowski's Ges.* (1768), *Acta* (1772, &c.); *Börsenver. d. D. Buchhändler* (1825), *Börsenblatt* (1834, &c.); *Hist. Theolog. Ges.* (1814). *Lübeck, Hansischer Ges. Ver.* (1870). *Munich, Hist. Ver.* (1837), *Archiv* (1839, &c.); *Alterthums-Ver.* (1864). *Nuremberg, Pegnesischer Blumenorden* (1644), had united with it in 1874 the *Lit. Ver.* (1839), *Prague, Ver. f. Gesch.* *Ratisbon, Hist. Ver.* (1830), *Verhandl.* (1832, &c.). *Rostock, Ver. für. Alt.* (1883), *Beiträge* (1890, &c.). *Schwerin, Ver. f. Meckl. Gesch. u. Alterthumsk.* (1835), *Jahrbuch* (1835, &c.) and other publications. *Strassburg, Soc. pour la conservation des Monuments Historiques d'Alsace* (1855), *Bull.* (1855, also since 1889 with German title *Mitteilungen*). *Stuttgart, Lit. Ver.* (1839), *Bibliothek* (1843, &c.); *Württemberg. Alterth. Ver.* (1843), *Jahreshefte* (1844) and many records, handbooks, &c. *Tübingen, Lit. Ver.* (1839), *Bibliothek* (1842, &c.). *Vienna, K. k. Orient. Akad.*; *K. k. Heraldische Ges.* "Adler" (1870), *Jahrbücher* (1874, &c.); *Ver. für Österr. Volkskunde* (1894), *Ztschr.* *Weimar, D. Shakspeare Ges.* (1864), *Jahrbuch*

(1865, &c.); *Goethe Ges.* (1885), *Schriften* (1885, &c.); *Ges. der Bibliophilen* (1899). Wiesbaden, *Ver. f. Nass. Alterth.* (1821), *Annalen* (1830, &c.). Würzburg, *Hist. Ver.* (1831), *Archiv* (1833). SWITZERLAND: Basle, *Hist. u. Antiq. Ges.* (1836). Berne, *Allgemeine Geschichtsforschende Ges.* (1840). Freiberg, *Soc. d'Hist.* Geneva, *Soc. d'Hist. et d'Arch.* (1838). Lausanne, *Soc. d'Hist.*; *Soc. Vaudoise d'Hist. et d'Arch.* (1902), *Revue*. St Gall, *Hist. Ver.* (1859), *Mitteil.* (1862, &c.). Zürich, *Soc. d'Hist.*; *Antiq. Ges.*, *Denkmäler*. ITALY: Bologna, *Reg. Deputazione di Storia Patria*. Catania, *Soc. di Storia Patria* (1903). Ferrara, *Deput. Ferrarese di Storia Patria* (1884). Florence, *Società Colombaria* (1823); *Soc. Daniesca Italiana* (1888); *R. Deputazione Tosc. di Storia Patria* (1862). Genoa, *Soc. di Storia Patria* (1857). Milan, *Soc. Numis. Ital.*; *Soc. Storia Lombarda*. Naples, *Soc. Nap. di Storia Patria* (1875). Palermo, *Soc. Sic. di Storia Patria* (1873), *Doc.* Parma, *R. Deputazione di Storia Patria*. Rome, *Accad. Rom. di Arch.*; *Soc. Rom. di Storia Patria* (1877), *Archivio* (1877, &c.); *Ist. di Corr. Arch.*; *Brit. and Amer. Arch. Soc.*; *Soc. Filol. Rom.* (1901); *Istituto Stor. Ital.* (1883), *Fonti* (1887, &c.); *K. Deutsch. Archäolog. Inst.*, *Arch. Ztg.* (1843-1885) and *Jahrb.* Turin, *Real Deputaz. di Stor. Patr.* (1833). Venice, *R. Dep. Ven. di Storia Patria*. Verona, *Soc. Lett.* (1808). BELGIUM: Antwerp, *Acad. d'Archéol.* (1842), *Bull.* (1865, &c.). Bruges, *Soc. pour l'Hist. et les Antiq. de la Flandre* (1839), *Publ. Brussels, Soc. de l'Hist. de Belgique* (1858), *Publ.*; *Soc. Roy. de Numism.* (1841), *Revue*; *Soc. des Bibliophiles* (1865); *Soc. d'Archéol.* (1887), *Annuaire, Annales; Inst. Int. de Bibliogr.* (1895), *Répertoire*. Ghent, *Soc. Roy. des Beaux-Arts et de la Litt.* (1808), *Annales* (1844, &c.); *Willems Fond* (1851); *Maatschappij de Vlaamsche Bibliophilen* (1839); *Soc. d'Hist. et d'Archéol.* (founded 1893 as *Cercle Hist. et Archéol.*), *Bull.* Liège, *Inst. Archéol.* (1850), *Bull.* (1852, &c.). Louvain, *Soc. Litt.* (1839), *Mém. and Publ.* Mons, *Cercle Archéol.* (1856), *Annales* (1857, &c.). Namur, *Soc. Archéol. et Musée de Namur* (1845), *Annales*. Tournai, *Soc. Hist. et Litt.* (1846), *Bull.* (1849, &c.). Verviers, *Soc. Arch. Ypres, Soc. Hist.* (1861). HOLLAND: Leiden, *Acad. Lugduno-Batava; Maatschappij der Nederlandsche Letterkunde* (1766) *Tijdschrift*. Luxembourg, *Inst. Archéol.* (1846, reorganized in 1862), *Annales* (1849, &c.). Utrecht, *Hist. Genootschap* (1845). DENMARK: Copenhagen, *Island. Litt. Selskab*; *K. Danske Selskab* (1745), *Magazin*; *K. Nordisk Oldskrift Selskab*, *Aarbøger* (1866, &c.), *Fortidsminder* (1890, &c.). Reykjavik (Iceland), *Formleifarfelag; Hid islenzka Bókmenntafelag* (1816), *Skirnir*. NORWAY: Christiania, *Norske Hist. Forening* (1869); *Norske Oldskrift Selskab*; *Foreningen til Norske Fortidsminder maerkers Bevaring* (1844). SWEDEN: Stockholm, *K. Witterhets Hist. och Antiq. Akad.*; *Svenska Akad.*; *Sv. Forsk. sällskapet* (1843) *Proc.*; *K. Samfundet för utgivande af handskrifster rörande Skandinavien hist.* (1815-1817), *Handl.* (1816, &c.). SPAIN: Barcelona, *R. Acad. de Buenas Letras*. Madrid, *R. Acad. de Cienc. Mor. y Pol.*; *R. Acad. Esp. Arq.*; *R. Acad. de la Hist.* (1738). RUSSIA: Helsingfors, *Finska Litt. Sällskapet* (1831), *Ztschr.* (1841); *Finnish Archaeol. Soc.* (1870), *Tidskrift* (1874, &c.); *Hist. Soc.* (1875), *Arkisto* (1876, &c.). Kazan, *Soc. of Arch. Hist. and Ethnogr.* (1877), *Izvestija* (1878). Mitau, *Courland Soc. of Lit. and Art.* Moscow, *Imp. Russ. Soc. of Hist. and Antiq.*; *Archaeolog. Soc.* (1864). Narva, *Archaeolog. Soc. Odessa, Hist. and Antiq. Soc.* (1839), *Zapiski* (1844, &c.). Riga, *Lett. Lit. Ges.*; *Hist. and Antiq. Soc.* (1834), *Mitteil.* (1873, &c.). St Petersburg, *Russ. Hist. Soc.* (1866), *Sbornik* (1867, &c.); *Imp. Soc. for Study of Ancient Lit.* (1877); *Imp. Russ. Archeol. Soc.* (1846); *Russ. Bibliogr. Soc.* (1899); *Soc. for Orient. Studies*, with numerous branches; *Neophilol. Soc.* (1885). GREECE: Athens, *Soc. Archéol.*; *Amer. School Class. Studies* (1882); *École Franç. d'Athènes* (1846); *British School at Athens* (1886); *Ἀρχαιολογικὴ Ἐραupeia* (*Arch. Soc.*) (1837), *Ἐφημερίς*. TURKEY: Constantinople, *Soc. for Adv. of Turkish Lit.*; *Greek Lit. Soc.*; *Hellenic Philolog. Soc.* BULGARIA: Sofia, *Bulg. Lit. Soc.* (1869), now the *Bulgarian Acad.* (1910), *Period.* (1870, &c.). SOUTH AMERICA: Rio de Janeiro, *Inst. hist. e geogr.* (1838). JAPAN: Yokohama, *Asiatic Soc. of Japan, Trans.* (1874, &c.).

XVIII. GEOGRAPHY

The *Congrès International pour les Progrès des Sciences Géographiques* first met in 1871. The *Royal Geographical Society of London*, founded in 1830, had joined to it in the following year the *African Association* (1788), the successor of the *Saturday Club*; the *Palestine Association* (1805) became merged with it in 1834. It publishes *Journal* (1832, &c.) and *Proceedings* (1857, &c.). The *Hakluyt Society* (1846) has printed more than 136 vols. of rare voyages and travels. The *Alpine Club* (1858), whose publications are *Peaks, Passes and Glaciers* (1859-1862) and *Journal* (1863, &c.), meets in London. The *Royal Scottish Geographical Society* (1884) has its centre at Edinburgh, and issues the *Scottish Geographical Magazine*. Liverpool, Tyneside and Manchester have also *Geographical Societies*. AUSTRALIA: Adelaide, *R. Geogr. Soc. of Australasia* (1885), *Proc.* Brisbane, *R. Geogr. Soc. of Australasia* (1885). Melbourne, *Roy. Geogr. Soc. of Australasia* (1883). Sydney, *Geogr. Inst.* CANADA: Quebec, *R. Geogr. Soc.* INDIA: Bombay, *Geogr. Soc.*, *Trans.* (1836, &c.). EGYPT: Cairo, *Soc. Khédiviale de Géogr.* (1875), *Bull.* (1876, &c.).

UNITED STATES: Baltimore, *Geogr. Soc.* (1902). Chicago, *Geogr. Soc.* (1894). Hamilton, *Assoc. of Amer. Geogr.* (1904). New York, *Amer. Geogr. Soc.* (1852), *Bull.* (1852-1857), *Journ.*, later *Bull.* (1859,

&c.), and *Proc.* (1862-1865). Philadelphia, *Geogr. Soc.* (1891). San Francisco, *Geogr. Soc.* (1891), *Bull.* Washington, *Nat. Geogr. Soc.* (1852), *Magazine* (1888). FRANCE: Algiers, *Soc. Géogr.* (1896), *Bull.* Bordeaux, *Soc. de Géogr. Commerciale* (1874), *Bull.* Dijon, *Soc. Bourg. de Géogr. et d'Hist.* (1881), *Mém.* (1884, &c.). Lyons, *Soc. de Géogr.* (1873), *Bull.* Marseilles, *Soc. de Géogr.* (1876), *Bull.* Montpellier, *Soc. Languedocienne de Géogr.* (1878), *Bull.* Nancy, *Soc. de Géogr.* (1878), *Bull.* Paris, *Soc. de Géogr.* (1821; 1827), *Bull.* Toulouse, *Soc. de Géogr.* (1882), *Bull.* GERMANY and AUSTRIA-HUNGARY: D. *Alpen-Ver.* (1869), *Ztschr. u. Jahrb.* (1869, &c.). Berlin, *Ges. f. Erdkunde* (1828), *Ztschr.* (1853, &c.), and *Verhandl.* (1873, &c.); *Ges. zur Erforschung Äquat. Afrikas* (1873), *Corr.-Blatt; Afrik. Ges.* (1878), *Mitteil.*; *D. Geographentag* (1881), *Verhandl.* Bremen, *Geograph. Ges.* (1876), *Geogr. Blätter*. Budapest, *Hung.-Geogr. Soc.* (1872). Carlsruhe, *Badische Geogr. Ges.* (1880), *Verhandl.* Cassel, *Ver. f. Erdk.* (1882). Darmstadt, *Ver. f. Erdk.* (1845), *Notizblatt* (1854, &c.). Dresden, *Ver. f. Erdk.* (1863), *Jahresber.* (1805-1901), *Mitteil.* (1905, &c.). Frankfurt, *Ver. f. Geogr. u. Statist.* (1836), *Jahresber.* Giessen, *Ges. für Erd. u. Völkerkunde* (1896). Halle, *Ver. f. Erdk.* (1873). Hamburg, *Geogr. Ges.* (1873), *Jahresber.* Hanover, *Geogr. Ges.* (1878), *Jahresber.* Jena, *Geogr. Ges.* (1880), *Mitteil.* Leipzig, *Ver. f. Erdk.* (1861). Järesber. Lübeck, *Geogr. Ges.* (1882). Munich, *Geogr. Ges.* (1869), *Jahresber.* Vienna, *K. k. Geogr. Ges.*, *Mitt.* (1857, &c.); *Ver. der Geogr. Weimar, Geogr. Inst.* SWITZERLAND: Berne, *Inst. Geogr.*; *Geogr. Ges.* (1873), *Jahresber.* (1879, &c.); *Schweiz. Alpen-Club*. Geneva, *Soc. de Géogr.*, *Mém.* (1860, &c.). Zürich, *Karten-Ver.* ITALY: Rome, *Soc. Geogr. Ital.*, *Bull.* (1868, &c.). Turin, *Circolo Geogr. Ital.* (1868). BELGIUM: Antwerp, *Soc. Belge de Géogr.* (1870), *Bull.*; *Soc. Roy. de Géogr.* (1876), *Bull.* Brussels, *Soc. Belge de Géogr.* (1876). HOLLAND: Amsterdam, *K. Nederl. Aardrijkskundig Genoot.* (1873), *Tijdschrift* (1874, &c.); *Landkundige Genootschap*. DENMARK: Copenhagen, *Geogr. Selskab*. NORWAY: Christiania, *Det norske geogr. Selskab* (1889). SPAIN and PORTUGAL: Lisbon, *Soc. de Geogr.*, *Bol.* (1875, &c.). Madrid, *Soc. Geogr.*, *Bol.* (1876, &c.). RUSSIA: Helsingfors, *Geogr. Soc.* (1888), *Tidskrift; Sällskapet för Finlands geografi* (1888). Irkutsk, *Geogr. Soc.*, *Bull.* (1871, &c.). St Petersburg, *Imp. Russ. Geogr. Soc.*, *Mém.* (1845, &c.), and *Bull.* (1865, &c.). Tiflis, *Geogr. Soc.*, *Mém.* (1852, &c.). RUMANIA: Bucharest, *Societatea Geografica Româna* (1875), *Bull.* EGYPT: Cairo, *Soc. Khédiviale de Géogr.*, *Bull.* (1876, &c.). JAPAN: Tokyo, *Geogr. Soc.* CENTRAL and SOUTH AMERICA: Buenos Aires, *Inst. Geogr. Argent.* La Paz, *Soc. Geogr.* (1889), *Bol.* Lima, *Soc. Geogr.* (1888), *Bol.* Mexico, *Soc. de Geogr. y Estad.*, *Bol.* (1833, &c.). Rio de Janeiro, *Soc. de Geogr.*

BIBLIOGRAPHY.—The *Catal. of Printed Books in the British Museum* (1841), folio, s.v. "Academies," contains a list of all the publications of societies at that time in the museum. This has been rearranged and greatly enlarged as *Academies* (1885-1886), 5 parts folio, with *Suppl.* (1900-1903). *Smithsonian Instn. International Exchange List* (1908); B. Quaritch, *List of Learned Societies* (Odd Vols.) (1886). S. H. Scudder, *Cat. of Scientific Serials* (1633-1876); *Camb. (U.S.)* (1879), 8vo. For general indexes see J. D. Reuss, *Reperitorium* (1801-1821), 16 vols., *Roy. Soc. Cat. of Sc. Papers* (1867-1902); *Societatum Litterae, Verzeichniss* (1887-1900, 14 vols.). For list of indexes to transactions, &c., see A. Stein, *Manuel de Bibliographie générale* (1897), p. 642, &c. *Minerva* (Strassb. Trübner), from 1891 on, is most useful for all the chief existing societies in the world. British societies are now well represented in the *Year Book of the Scientific and Learned Societies of Great Brit. and Ireland* (1884, &c.). See also Hume's *Learned Societies and Printing Clubs of the U.K.* (1853, 8vo); E. Mailly, *Inst. Sc. de la Grande-Bret.* (1861-1867, 6 pts.); H. G. Bohn, *App. to Bibliographer's Manual* (1864), 8vo; *Engl. Catal. of Books* (1864-1909); C. S. Terry, *Cat. of Publications of Scottish Historical Societies and Clubs*, 1909; "Sc. Societies and Field Clubs," in *Nature*, v., viii. For American Societies see R. R. Bowker, *Pubns. of Societies* (New York, 1899); *Handbk. of Learned Societies, Carnegie Inst. of Washington* (1908); A. P. C. Griffin, *Bibl. of Amer. Historical Societies* (1905); A. Crowell, *Am. Book Clubs* (New York, 1897). For France, see U. Robert, *Bibl. des. Soc. sav. de la France*, pt. i. (1878); F. Bouillier, *L'Institut et les acad. de province* (1879, 8vo); Lasteyrie, Lefèvre-Pontalis et A. Vidier, *Bibliogr. des travaux hist. et arch. publ. par les soc. sav. de la France* (1888-1904, 4 vols. 4to). J. Deniker, *Bibliogr. des travaux scientifiques publ. par les soc. savantes de la France* (1895, &c.); H. Delany, *Les Soc. savantes de la France* (1902); E. Lefèvre-Pontalis, *Bibl. des soc. savantes de la France* (1887); *Annuaire des Soc. savantes de la France et de l'étranger* (1846); A. d'Hericourt, *Annuaire* (1863-1866); continued in *Revue de soc. savantes*. For Germany and Austria-Hungary, see H. A. Stöhr, *Allg. Deutsches Vereinshandbuch* (1873, &c., 8vo); J. Müller, *Die wiss. Vereine u. Ges. Deutschlands im 19^{ten} Jahrh.* (1883-1888); J. Winckler, *Die period. Presse Österreichs* (1875, 8vo); and P. A. F. Walther for German historical societies (1845). See also "Les Congrès scientifiques," by Comte de Marsy, in *Compte rendu du Congrès Bibliogr.* (1879). For Belgium, see *Introd. à la Bibl. de la Belgique* (1875). For Italy, see *Statistica della stampa periodica, 1880-1895; Elenco bibl. delle accademie ec. corrisp. con la R. Accad. dei Lincei Roma*, 1908. For Russia, consult C. Woldemar, *Gesch. d. russ. Gelehrten- und Schulanstalten* (St Petersburg, 1865, 8vo), and Kawall, *Die neuen russ. Naturforschergesellschaften* (Riga, 1872-1874). (H. R. T.)

SOCIETY ISLANDS (French *Archipel de la Société*), an archipelago of the Pacific Ocean, in the eastern part of Polynesia, between 16° and 18° S., 148° and 155° W., with a total land area of 637 sq. m., belonging to France. (For map, see PACIFIC OCEAN.) The principal island is Tahiti (*q.v.*). Part of the archipelago was discovered by Pedro Fernandez Quiros in 1607. In 1767 Samuel Wallis re-discovered it, and named it King George's Island. In 1768 Louis de Bougainville visited Tahiti, claimed it as French, and named it La Nouvelle Cythère. On the 12th of April 1769 the British expedition to observe the transit of Venus, under the naval command of James Cook, arrived at Tahiti. On this first voyage (he subsequently re-visited the islands twice) he named the Leeward group of islands Society in honour of the Royal Society, at the instigation of which the expedition had been sent; Tahiti and the adjacent islands he called Georgian, but the first name was subsequently adopted for the whole group. In 1772 and 1774 the islands were visited by a Spanish government expedition, and some attempt was made at colonization. In 1788 Lieutenant Bligh of the "Bounty" spent some time at Tahiti, to which island the historical interest now passes.

The archipelago is divided into two groups—the Leeward (*Iles sous le Vent*) and the Windward Islands (*Iles du Vent*)—by a clear channel of 60 m. in breadth. The Leeward Islands are Tubai or Motuiti, a small uninhabited lagoon island, the most northern of the group; Marua or Maupiti—"Double Mountain," the most western; Bola-Bola or Bora-Bora; Huaheine; Raiatea or Ulitea (Spanish Princessa), the largest island of this cluster, and Tahaa, which approach each other very closely, and are encircled by one reef. To the west lie the small groups of coral islets—Mopiha (Lord Howe), Ura (Scilly) and Bellingshausen (discovered by Otto von Kotzebue, 1824). To the Windward Islands belong Tapamannu or Majaiti (Wallis's Sir Charles Saunders's Island and Spanish Pelada); Moorea or Eimeo (Wallis's Duke of York Island and Spanish San Domingo); Tahiti—Cook's Otaheite (probably Quiros's Sagittaria; Wallis's King George's Island, Bougainville's Nouvelle Cythère and Spanish Isla d'Amat); Tetuaroa—"The Distant Sea" (? Quiros's Fugitiva; Bougainville's Umaitia and Spanish Tres Hermanos); and Maitea (? Quiros's La Dezana, Wallis's Osnaburg Island, Bougainville's Boudoir and Pic de la Boudouse and Spanish Cristoval), the most eastern and southern of the archipelago. Tetuaroa and Tubai, besides the three western Leeward Isles, are coral atolls. The length of the Tetuaroa reef ring is about six miles; it bears twelve palm-covered islets, of which several are inhabited, and has one narrow boat-passage leading into the lagoon. With the exception just named, the islands, which agree very closely in geological structure, are mountainous, and present, perhaps, the most wonderful example of volcanic rocks to be found on the globe. They are formed of trachyte, dolerite and basalt. There are raised coral beds high up the mountains, and lava occurs in a variety of forms, even in solid flows; but all active volcanic agency has so long ceased that the craters have been almost entirely obliterated by denudation. Hot springs are unknown, and earthquakes are slight and rare. Nevertheless, under some of these flows remains of plants and insects of species now living in the islands have been found—a proof that the formation as well as the denudation of the country is, geologically speaking, recent. In profile the islands are rugged and elevated (7349 ft. in Tahiti, Moorea 4045 ft., Raiatea 3389, Bola-Bola 2165). A mountain, usually with very steep peaks, forms the centre, if not the whole island; on all sides steep ridges descend to the sea, or, as is often the case, to a considerable belt of flat land. These mountains, excepting some stony crags and cliffs, are clothed with dense forest, the soil being exceptionally fertile. All voyagers agree that for varied beauty of form and colour the Society Islands are unsurpassed in the Pacific. Innumerable rills gather in lovely streams, and, after heavy rains, torrents precipitate themselves in grand cascades from the mountain cliffs—a feature so striking as to have attracted the attention of all voyagers, from Wallis downwards. Round most of the islands there is a luxuriant coral growth; but, as the reefs lie at no great distance, and follow the line of the coast, the inter-island channels are comparatively safe. Maitea, which rises from the sea as an exceedingly abrupt cone, and Tapamannu, appear to be the only islands without almost completely encircling barrier-reefs. The coasts are fairly indented, and, protected by these reefs, which often support a chain of green islets, afford many good harbours and safe anchorages. In this respect the Society Islands have the advantage of many Polynesian islands.

The populations of the chief islands are: Tahiti 10,300, Moorea 1600, Raiatea and Tahaa 2300, Huaheine 1300, Bola-Bola 800; and that of the whole archipelago is about 18,500.

SOCINUS, the latinized form of the Italian Sozini, Sozzini or Soccini, a name born by two Italian theologians.

I. LELIO FRANCESCO MARIA SOZINI (1525–1562) was born at

Siena on the 20th of January 1525. His family descended from Sozzo, a banker at Percena, whose second son, Mino Sozzi, settled as a notary at Siena in 1304. Mino Sozzi's grandson, Sozzino (d. 1403), was ancestor of a line of patrician jurists and canonists, Mariano Sozzini senior (1397–1467) being the first and the most famous, and traditionally regarded as the first freethinker in the family. Lelio (who spells his surname Sozini, latinizing it Sozinus) was the sixth son of Mariano Sozzini junior (1482–1556) by his wife Camilla Salvetti, and was educated as a jurist under his father's eye at Bologna. He told Melanchthon that his desire to reach the *fontes juris* led him to Biblical research, and hence to rejection of "the idolatry of Rome." He gained some knowledge of Hebrew and Arabic (to Bibliander he gave a manuscript of the Korān) as well as Greek, but was never a laborious student. His father supplied him with means, and on coming of age he repaired to Venice, the headquarters of the evangelical movement in Italy. A tradition, first published by Sand in 1678, amplified by subsequent writers, makes him a leading spirit in alleged theological conferences at Vicenza, about 1546; the whole account (abounding in anachronisms, including the story of Sozini's flight) must be rejected as fabulous. At this period the standpoint of Sozini was that of evangelical reform; he exhibits a singular union of enthusiastic piety with subtle theological speculation. At Chiavenna in 1547 he came under the influence of Camillo of Sicily, a gentle mystic, surnamed Renato, whose teaching at many points resembled that of the early Quakers. Pursuing his religious travels, his family name and his personal charm ensured him a welcome in Switzerland, France, England and Holland. Returning to Switzerland at the close of 1548, with commendatory letters to the Swiss churches from Nicolas Meyer, envoy from Wittenberg to Italy, we find him (1549–1550) at Geneva, Basel (with Sebastian Münster) and Zürich (lodging with Pellican). He is next at Wittenberg (July 1550 to June 1551), first as Melanchthon's guest, then with Johann Forster for improvement of his Hebrew. From Wittenberg he returned to Zürich (end of 1551), after visiting Prague, Vienna and Cracow. Political events drew him back to Italy in June 1552; two visits to Siena (where freedom of speech was for the moment possible, owing to the shaking off of the Spanish yoke) brought him into fruitful contact with his young nephew Fausto. He was at Padua (not Geneva, as is often said) at the date of Servetus's execution (Oct. 27, 1553). Thence he made his way to Basel (January 1554), Geneva (April) and Zürich (May), where he took up his abode.

Calvin, like Melanchthon, received Sozini with open arms. Melanchthon (though a phrase in one of his letters has been strangely misconstrued) never regarded him with theological suspicion. To Calvin's keen glance Sozini's over-speculative tendency and the genuineness of his religious nature were equally apparent. A passage often quoted (apart from the context) in one of Calvin's letters (January 1, 1552) has been viewed as a rapture of amicable intercourse; but, while more than once uneasy apprehensions arose in Calvin's mind, there was no breach of correspondence or of kindness. Of all the Reformers, Bullinger was Sozini's closest intimate, his warmest and wisest friend. Sozini's theological difficulties turned on the resurrection of the body, predestination, the ground of salvation (on these points he corresponded with Calvin), the doctrinal basis of the original gospel (his queries to Bullinger), the nature of repentance (to Rudolph Gualther), the sacraments (to Johann Wolff). It was the fate of Servetus that directed his mind to the problem of the Trinity. At Geneva (April 1554) he made incautious remarks on the common doctrine, emphasized in a subsequent letter to Martinengo, the Italian pastor. Bullinger, at the instance of correspondents (including Calvin), questioned Sozini as to his faith, and received from him an explicitly orthodox confession (reduced to writing on the 15th of July 1555) with a frank reservation of the right of further inquiry. A month before this Sozini had been sent with Martino Muralto to Basel, to secure Ochino as pastor of the Italian church at Zürich; and it is clear that in their subsequent intercourse the minds

of Sozini and Ochino (a thinker of the same type as Camillo, with finer dialectic skill) acted powerfully on each other in the radical discussion of theological problems. In 1556 by the death of his father (who left him nothing by will), Sozini was involved in pecuniary anxieties. With influential introductions (one from Calvin) he visited in 1558 the courts of Vienna and Cracow to obtain support for an appeal to the reigning duke at Florence for the realization of his own and the family estates. Curiously enough Melanchthon's letter introducing Sozini to Maximilian II. invokes as an historic parallel the hospitable reception rendered by the emperor Constans to Athanasius, when he fled from Egypt to Trèves. Well received out of Italy, Sozini could do nothing at home, and apparently did not proceed beyond Venice. The Inquisition had its eye on the family; his brother Cornelio was imprisoned at Rome; his brothers Celso and Camillo and his nephew Fausto were "reputati Luterani," and Camillo had fled from Siena. In August 1559 Sozini returned to Zürich, where his brief career was closed by his death on the 14th of May 1562, at his lodging in the house of Hans Wyss, silk-weaver. No authentic portrait of him exists; alleged likenesses on medals, &c., are spurious. The news of his uncle's death reached Fausto at Lyons through Antonio Maria Besozzo. Repairing to Zürich Fausto got his uncle's few papers, comprising very little connected writing but a good many notes. Fausto has so often been treated as a plagiarist from Lelio that it may be well to state that his indebtedness, somewhat over-estimated by himself, was twofold: (1) He derived from Lelio in conversation (1552-1553) the germ of his theory of salvation; (2) Lelio's paraphrase (1561) of ἀρχὴ in John i. 1 as "the beginning of the gospel" gave Fausto an exegetical hint for the construction of his Christology. Apart from these suggestions, Fausto owed nothing to Lelio, save a curiously far-fetched interpretation of John viii. 58 and the stimulus of his pure character and shining qualities. The two men were of contrasted types. Lelio, impulsive and inquisitive, was in quest of the spiritual ground of religious truths; the drier mind of Fausto sought in external authority a basis for the ethical teaching of Christianity.

Sozini's extant writings are: (1) *De sacramentis dissertatio* (1560), four parts, and (2) *De resurrectione* (a fragment); these were first printed in *F. et L. Socini, item E. Soneri tractatus* (Amsterdam, 1654). To these may be added his *Confession* (1555), printed in Hottinger, *Hist. eccles. N.T.* ix. 16, 5 (1667); and about twenty-four letters, not collected, but may be found dispersed, and more or less correctly given in Ilgen, in Trechsel, in the *Corpus reformatorum* edition of Calvin's works, and in E. Burnat, *L. Socin* (1894); the handwriting of the originals is exceedingly crabbed. Sand adds a *Rhapsodia in Esaiam prophetam*, of which nothing is known. Beza suspected that Sozini had a hand in the *De haereticis, an sint persequendi* (1553); and to him has also been assigned the *Contra libellum Calvinii* (1554); both are the work of Castellio, and there is no ground for attributing any part of them to Sozini. Beza also assigned to him (in 1567) an anonymous *Explicatio* (1562) of the poem of St John's Gospel, which was the work of Fausto; this error, adopted by Zanchi, has been a chief source of the misconception which treats Lelio as a heresiarch. In Franc. Guinio's *Defensio cath. doct. de S. Trin.* (1590-1591) is an anonymous enumeration of motives for professing the doctrine of the Trinity, by some ascribed to Lelio; by others, with somewhat more probability, to Fausto.

For the life of L. Sozini the best guide is Trechsel, *Die prot. antitrin. vor F. Socin*, vol. ii. (1844); but there are valuable materials in Ilgen, *Vita L. Socini* (1814), and especially *Symbolae ad vitam et doctrinam L. Soc., &c.* (1826). R. Wallace, *Antitrin. biog.* (1850), gives the ordinary Unitarian view, relying on Bock, Da Porta and Lubieniecki. See also *Theological Review* (July 1879), and Bonet-Maury's *Early Sources of Eng. Unit. Christ.* (trans. E. P. Hall, 1884). Use has been made above of unprinted sources.

II. FAUSTO PAOLO SOZZINI (1539-1604) was born at Siena on the 5th of December 1539, the only son of Alessandro Sozzini, "princeps subtilitatum," by Agnese, daughter of Borghese Petrucci, a descendant of Pandolfo Petrucci, the Cromwell of Siena. Unlike his uncle Lelio, Fausto spells his surname Sozzini, latinizing it Socinus. His father died in 1541, in his thirty-second year. Fausto had no regular education, being brought up at home with his sister Fillide, and spent his youth in desultory reading at Scopeto, the family country-seat. To the able women of his family he owed the strong moral impress

which marked him through life; his early intellectual stimulus came from his uncle Celso, a nominal Catholic, but an *esprit fort*, founder of the short-lived *Accademia dei Siziensi* (1554), of which younger Fausto was a member. In 1556 his grandfather's will, leaving him one-fourth of the family estates, made him independent. Next year he entered the *Accademia degli intronati*, the centre of intellectual life in Siena, taking the academic name "Il Frastagliato," his badge *Un mare turbato da venti*, his motto *Turbant sed extollunt*. About this time Panzirolo (*De claris legg. interpp.*, first published 1637) describes him as a young man of fine talent, with promise of a legal career; but he despised the law, preferring to write sonnets. In 1558-1559 the suspicion of Lutheranism fell on him in common with his uncles Celso and Camillo. Coming of age (1561) he went to Lyons, probably engaging in mercantile business; he revisited Italy after his uncle Lelio's death; we find him in 1562 on the roll of the Italian church at Geneva; there is no trace of any relations with Calvin; to Lyons he returned next year. The evangelical position was not radical enough for him. In his *Explicatio* (1562) of the poem to St John's Gospel he already attributes to our Lord an official, not an essential, deity; a letter of 1563 rejects the natural immortality of man (a position subsequently developed in his disputation with Pucci). Towards the end of 1563 he returned to Italy, conforming to the Catholic Church, and for twelve years, as his unpublished letters show, was in the service of Isabella de Medici, daughter of the grand-duke Cosimo of Tuscany (not, as Przykowski says, in the service of the grand-duke). This portion of his life he regarded as wasted; till 1567 he gave some attention to legal duties, and at the instance of "a great personage" wrote (1570) his treatise *De auctoritate s. scripturae*. In 1571 he was in Rome, probably with his patroness. He left Italy at the end of 1575, and after Isabella's death (strangled by her husband in 1576) he declined the overtures of her brother Francesco, now grand-duke, who pressed him to return. Francesco was doubtless aware of the motive which led Sozzini to quit Italy; there is every reason to believe Przykowski's statement that the grand-duke agreed to secure to him the income of his property so long as he published nothing in his own name. Sozzini now fixed himself at Basel, gave himself to close study of the Bible, began translating the Psalms into Italian verse, and, in spite of increasing deafness, became a centre of theological debates. His discussion with Jacques Couet on the doctrine of salvation issued in a treatise *De Jesu Christo servatore* (finished July 12, 1578), the circulation of which in manuscript commended him to the notice of Giorgio Blandrata (*q.v.*), court physician in Poland and Transylvania, and ecclesiastical wire puller in the interests of heterodoxy.

Transylvania had for a short time (1559-1571) enjoyed full religious liberty under an anti-Trinitarian prince, John Sigismund. The existing ruler, Christopher Báthori, favoured the Jesuits; it was now Blandrata's object to limit the "Judaic" tendencies of the eloquent anti-Trinitarian bishop, Francis Dávid (1510-1579), with whom he had previously co-operated. A charge of the gravest sort against Blandrata's morals had destroyed his influence with Dávid. Hence he called in Sozzini to reason with Dávid, who had renounced the worship of Christ. In Sozzini's scheme of doctrine, terms in themselves orthodox were employed in a heretical sense. Thus Christ was God, though in nature purely human, namely as *un Dio subalterno, al quale in un dato tempo il Dio supremo cedette il governo del mondo* (Cantù). In matter of worship Sozzini distinguished between *adoratio Christi*, the homage of the heart, imperative on all Christians, and *invocatio Christi*, the direct address of prayer, which was simply permissive (Blandrata would have made it imperative); though in Sozzini's view, prayer, to whomsoever addressed, was received by Christ as mediator, for transmission to the father. In November 1578 Sozzini reached Kolozsvár (Klausenburg) from Poland, and did his best, during a visit of four months and a half under Dávid's roof, to argue him into this modified doctrine of invocation. The upshot was that Dávid from the pulpit exerted all his powers in denouncing all cultus of Christ. His civil trial followed, on a charge of innovation. Sozzini

hurried back to Poland before it began. He cannot be accused of complicity with what he calls the rage of Blandrata; he was no party to Dávid's incarceration at Déva, where the old man miserably perished in less than three months. He was willing that Dávid should be prohibited from preaching pending the decision of a general synod; and his references to the case show that (as in the later instances of Jacobo Paleology, Christian Franken and Martin Seidel) theological aversions, though they never made him uncivil, froze up his native kindness and blinded his perceptions of character. Blandrata ultimately conformed to the Catholic Church; hence Sozzini's laudatory dedication to him (1584) of his *De Jesu Christi natura*, in reply to the Calvinist Andrew Wolan, though printed in his works, was not used. The remainder (1579-1604) of Sozzini's life was spent in Poland. Excluded at first by his views on baptism (which he regarded as applicable only to Gentile converts) from the Minor or anti-Trinitarian Church (largely anabaptist), he acquired by degrees a predominant influence in its synods. He converted the Arians from their avowal of our Lord's pre-existence, and from their rejection of the *invocatio Christi*; he repressed the semi-Judaizers whom he failed to convince. Through correspondence with friends he directed also the policy of the anti-Trinitarian Church of Transylvania. Forced to leave Cracow in 1583, he found a home with a Polish noble, Christopher Morsztyn, whose daughter Elizabeth he married (1586). She died in the following year, a few months after the birth of a daughter, Agnese (1587-1654), afterwards the wife of Stanislas Wiszowaty, and the progenitress of numerous descendants. In 1587 the grand-duke Francesco died; to this event Sozzini's biographers attribute the loss of his Italian property, but his unpublished letters show that he was on good terms with the new grand-duke, Ferdinando. Family disputes had arisen respecting the interpretation of his grandfather's will; in October 1590 the holy office at Siena disinherited him, allowing him a pension, apparently never paid. Failure of supplies from Italy dissolved the compact under which his writings were to remain anonymous, and he began to publish in his own name. The consequence was that in 1598 a mob expelled him from Cracow, wrecking his house, and grossly ill-using his person. Friends gave him a ready welcome at Luslawice, 30 miles east from Cracow; and here, having long been troubled with colic and the stone, he died on the 4th of March 1604. A limestone block with illegible inscriptions marks his grave.¹ His engraved portrait is prefixed to his works (the original is not extant); an oil-painting, formerly at Siena, cannot be considered authentic.

Sozzini's works, edited by his grandson Andrew Wiszowaty and the learned printer F. Kuyper, are contained in two closely printed folios (Amsterdam, 1668). They rank as the first two volumes of the *Bibliotheca fratrum polonorum*, though the works of Crell and Schlichting were the first of the series to be printed. They include all Sozzini's extant theological writings, except his essay on predestination (in which he denies that God foresees the actions of free agents) prefixed to Castellio's *Dialogi IV.* (1578, reprinted 1613) and his revision of a school manual *Instrumentum doctrinarum aristotelicum* (1586). His pseudonyms, easily interpreted, were Felix Turpio Urbevitanus, Prosper Dysidaeus, Gratianus Prosper and Gratianus Turpio Gerapolensis (=Senensis). Some of his early verse is in Ferentilli's *Scielta di stanze di diversi autori toscani* (1579, 1594); other specimens are given in Cantù and in the *Athenaeum* (Aug. 11, 1877); more are preserved at Siena. Sozzini considered that his ablest work was his *Contra atheos*, which perished in the riot at Cracow (1598). Later he began, but left incomplete, more than one work designed to exhibit his system as a whole. His reputation as a thinker must rest upon (1) his *De auctoritate s. scripturae* (1570) and (2) his *De Jesu Christo servatore* (1578). The former was first published (Seville, 1588) by Lopez, a Jesuit, who claimed it as his own, but prefixed a preface maintaining (contrary to a fundamental position of Sozzini) that man by nature has a knowledge of God. A French version (1592) was approved by the ministers of Basel; the English translation by Edward Coombe (1731) was undertaken in consequence of the commendation in a charge (1728) by Bishop Smalbrooke, who observes that Grotius had borrowed from it in his *De veritate Christ. rel.* In small

compass it anticipates the historical argument of the "credibility" writers; in trying it by modern tests, it should be remembered that Sozzini, regarding it (1581) as not adequately meeting the cardinal difficulties attending the proof of the Christian religion, began to reconstruct its positions in his *Lectiones sacrae* (unfinished). His treatise on the Saviour renders a real service to theology, placing orthodoxy and heresy in new relations of fundamental antagonism, and narrowing the conflict to the main personal benefit of religion. Of the person of Christ in this treatise he says nothing; its one topic is the work of Christ, which in his view operates upon man alone; the theological sagacity of Sozzini may be measured by the persistency with which this idea tends to recur. Though his name has been attached to a school of opinion, he disclaimed the rôle of a heresiarch, and declined to give his unreserved adhesion to any one sect. His confidence in the conclusions of his own mind has earned him the repute of a dogmatist; but it was his constant aim to reduce and simplify the fundamentals of Christianity. Not without some ground does the memorial tablet at Siena (inscription by Brighi, 1879) characterize him as vindicator of human reason against the supernatural. Of his non-theological doctrines the most important is his assertion of the unlawfulness, not only of war, but of the taking of human life in any circumstances. Hence the comparative mildness of his proposals for dealing with religious and anti-religious offenders, though it cannot be said that he had grasped the complete theory of toleration. Hence, too, his contention that magisterial office is unlawful for a Christian.

AUTHORITIES.—For the biography of Sozzini the best materials are his letters; a collection is in his works; others are given by Cantù; more are preserved at Siena and Florence; his correspondence is open and frank, never sparing his weak points. The earliest life (prefixed to his works) is by S. Przykowski (1636); in English, by J. Bidle (1653). This is the foundation of the article by Bayle, the *Memoirs* by J. Toulmin (1777), and the article by R. Wallace (*Anti-trin. Biog.*, 1850). Cantù's sketch in *Gli Eretici d'Italia* (1866) gives a genealogy of the Sozzini (needing revision). The best defence of Sozzini in his relations with Dávid is by James Yates (*Christ. Pioneer*, Feb. 1834); a less favourable view is taken by Dávid's Hungarian biographer, Elek Jakab (*Dávid F. Emléke*, 1879). Of his system—best known through the *Racovian Catechism* (1605, planned by Sozzini and carried out by others, principally Valentine Schmalz); in English, by T. Rees (1818)—there is a special study by O. Fock, *Der Socinianismus* (1847). See also *The Sozzini and their School*, by A. Gordon (*Theol. Rev.*, 1879; cf. *Christian Life*, Aug. 25, 1883). Use has been made above of unpublished papers in the archives of Florence, with others in the archives, communal library and collection of Padre Toti at Siena. (A. Go.*)

SOCIOLOGY, a science which in the most inclusive sense may be defined as that of human society, in the same manner that Biology may be taken to imply the science of life. The word *Sociologie* was first used by Comte in 1839 as an equivalent of the expression, social physics, previously in use, and was introduced, he said, to describe by a single term that part of natural philosophy which relates to the positive study of the fundamental laws of social phenomena. The word is a hybrid, compounded from both Latin and Greek terms. It is now generally accepted in international usage; none of the terms, such as politics, political science, social economy, social philosophy and social science which have been suggested instead of it having succeeded in taking its place.

There has been in the past a certain hesitation, especially in England, to admit sociology as the title of a particular science in itself until it was made clear what the subject matter was considered to cover. In certain quarters sociology is still often incorrectly spoken of as if it implied the practical equivalent of the science of politics. Henry Sidgwick, for instance, considered the word as usually employed in this sense, and while he himself recognized that sociology must have a wider scope than politics, he thought that in practice "the difference between the two subjects is not indeed great" (*Elements of Politics*). This view of sociology, which at one time widely prevailed, dates from an earlier period of knowledge. The difference between sociology and the science of politics is wide and is due to fundamental causes, a true perception of which is essential to the proper study of the science of society. It is a feature of organisms that as we rise in the scale of life the meaning of the present life of the organism is to an increasing degree subordinate to the larger meaning of its life as a whole. Similarly, as the advance from primitive society to society of a more organic type takes place, a marked feature of the change is the development of the principles through which the increasing subordination of the

¹ No trace is discoverable on the stone of the alleged epitaph:—
"Tota ruit Babylon; destruxit tecta Lutherus,
Calvinus muros, sed fundamenta Socinus."

present interests of society to the future interests of society is accomplished. It is, however, characteristic of the last-mentioned principles that their operation extends beyond the political consciousness of the state or nation, and that this distinction becomes more and more marked in the higher societies. The scope and meaning of sociology as a science is, therefore, quite different from the scope and meaning of the science of politics. In other quarters, again, the word sociology is often incorrectly used as no more than a covering term for subjects which are fully treated in various subdivisions of social science. Thus when the science of society is distinguished from the special social sciences which fall within its general purview, it may be considered, says Lester F. Ward, that "we may range the next most general departments as so many genera, each with its appropriate species—that is, the classification of the sciences may be made strictly synoptical. When this is done it will be possible for philosophers, like good systematists, to avoid making their ordinal characters include any properly generic ones, or their generic characters include any that are only specific. Thus understood, sociology is freed from the unnecessary embarrassment of having hanging about it in more or less disorder a burden of complicated details, in a great variety of attitudes which make it next to impossible to secure due attention to the fundamental principles of so vast a science. These details are classified and assigned each to its proper place (genus or species), and the field is cleared for the calm contemplation of the central problem of determining the facts, the law and the principles of human association" (*Outlines of Sociology*). This definition, good as it is in some respects, does not make clear to the mind the essential fact of the science, namely, that the principles of sociology involve more than the generalized total of the principles of the subordinate sciences which it is said to include. In Herbert Spencer's writings we see the subject in a period of transition. Spencer placed his *Principles of Sociology* between his *Principles of Psychology* and *Principles of Ethics*. This fact brings out the unsettled state of the subject in his time, while it also serves to exhibit the dominance of the ideas of an earlier stage. For psychology, which Spencer thus places before sociology, cannot nowadays be fully, or even in any real sense scientifically, discussed apart from sociological principles, once it is accepted that in the evolution of the human mind the principles of the social process are always the ultimate controlling factor.

Sociology, therefore, as a true science in itself, must be regarded as a science occupied quite independently with the principles which underlie human society considered as in a condition of development. In this sense the conclusions of sociology cannot be fully stated in relation to the phenomena dealt with in any of the divisions of social science, and they must be taken as implying more than the sum total of the results obtained in all of them. The sociologist must always keep clearly before him that the claims of sociology in the present conditions of knowledge go considerably beyond those involved in any of the foregoing positions. As it is the meaning of the social process which in the last resort controls everything, even the evolution of the human mind and all its contents, so none of the sciences of human action, such as ethics, politics, economics or psychology can have any standing as a real science except it obtains its credentials through sociology by making its approach through the sociological method. It is in sociology, in short, that we obtain the ruling principles to which the laws and principles of all the social sciences stand in controlled and subordinate relationship.

The fathers of the science of society may be said to be the Greek philosophers, and in particular Plato and Aristotle. The *Sociology* *Laws* and the *Republic* of the former and the *Ethics among the* and *Politics* of the latter have, down to modern times, and notwithstanding the great difference in the standpoint of the world and the change in social and political conditions, exercised a considerable influence on the development of the theory of society. To the Greeks the science of society presented itself briefly as the science of the best method of attaining the most perfect life within the consciousness of

the associated life of the State. "In this ideal of the State," says Bluntschli, "are combined and mingled all the efforts of the Greeks in religion and in law, in morals and social life, in art and science, in the acquisition and management of wealth, in trade and industry. The individual requires the State to give him a legal existence: apart from the State he has neither safety nor freedom. The barbarian is a natural enemy, and conquered enemies become slaves. . . . The Hellenic State, like the ancient State in general . . . was all in all. The citizen was nothing except as a member of the State. His whole existence depended on and was subject to the State. . . . The State knew neither moral nor legal limits to its power" (*Theory of the State*).

It was within the limits of this conception that most of the Greek theories of society were constructed. The fundamental conception of the Roman writers was not essentially different, although the opportunism of the Roman State, when it became a universal power embracing the social and religious systems of many peoples, in some degree modified it; so that with the growth of *jus gentium* outside the *jus civile*, the later writers of the empire brought into view an aspect of the State in which law began to be to some extent distinguished from State morality. With the spread of Christianity in Western Europe there commenced a stage in which the social structure, and with it the theory of society, underwent profound modifications. These changes are still in progress, and the period over which they extend has produced a great and increasing number of writers on the science of society. The conceptions of each period have been intimately related to the character of the influences controlling development at the time. The writers up to the 14th century are nearly all absorbed in the great controversy between the spiritual and temporal power which was defining itself during this stage in Western history. In the period of the Renaissance and the Reformation the modern development of the theory of society may be said to begin. Machiavelli is the first great name in this period. Bodin with other writers up to the time of Montesquieu carry the development forward in France. The Dutch writer Grotius, although chiefly recognized at the time as an authority on international law, had much influence in bringing into view principles which mark more directly the transition to the modern period, his *De jure belli et pacis*, issued in 1625, being in many respects an important contribution to the theory of society. Hobbes and Locke are the principal representatives of the influential school of writers on the principles of society which the period of the political and religious upheaval of the 17th century produced in England. The ideas of Locke, in particular, exercised a considerable influence on the subsequent development of the theory of the State in Western thought. From the 17th century forward it may be said, strictly speaking, that all the leading contributions to the general body of Western philosophy have been contributions to the development of the science of society. At the time of Locke, and to a large extent in Locke's writings, there may be distinguished three distinct tendencies in the prevailing theory of society. Each of these has since become more definite, and has progressed along a particular line of development. There is first the empirical tendency, which is to be followed through the philosophy of Hume down to the present day, in what may be called—to borrow an idea from Huxley—the physiological method in the modern study of the science of society. A second tendency—which developed through the critical philosophy of Kant, the idealism of Hegel, and the historical methods of Savigny in the field of jurisprudence and of the school of Schmoller in the domain of economics—finds its current expression in the more characteristically German conception of the organic nature of the modern State. A third tendency—which is to be followed through the writings of Rousseau, Diderot, d'Alembert and the literature of the French Revolution—found its most influential form of expression in the 19th century in the theories of the English Utilitarians, from Bentham to John Stuart Mill. In this development it is a theory of the utilitarian State which is principally in view. In

its latest phase it has progressed to the expression which it has reached in the theories of Marxian Socialism, in which the corresponding conception of the ascendancy of the economic factor in history may now be said to be the characteristic feature. All of these developments, the meaning of which has now been absorbed into the larger evolutionary conception to be described later, must be considered to have contributed towards the foundation of modern sociology. The definition of the relations to each other of the positions they have severally brought into view is the first important work of the new science.

At the period between 1830 and 1842, when Comte published the *Philosophie positive*, the conditions were not ready for a science of society. The Darwinian doctrine of evolution by natural selection had not yet been enunciated, and knowledge of social phenomena was limited and very imperfect. As an instance of the character of the change that has since been in progress, it may be mentioned that one of Comte's main positions—that, indeed, to which most of the characteristic conceptions of his system of philosophy were related—was that “the anatomical and physiological study of individual man” should precede the theory of the human mind and of human society. Here the position is the one already referred to which has prevailed in the study of the social sciences down into recent times. It was supposed that the governing principles of society were to be discovered by the introspective study of the individual mind, rather than that the clue to the governing principles of the individual mind was only to be discovered by the study of the social process. It must now be considered that no really fundamental or far-reaching principle of human development can be formulated as the result of Comte's position. For with the application of the doctrine of evolution to society a position is becoming defined which is almost the reverse of it, namely, that the development of the individual, and to a large extent of the human mind itself, must be regarded as the correlative of the social process in evolution. The study of the principles of the process of social evolution would therefore in this sense have to come before the complete study of the individual, and even to precede the construction of a system of psychology scientific in the highest sense. Comte, apart from his want of mastery of the historical method in dealing with sociological development, possessed, on the whole, little insight into the meaning of the characteristic problem in which the human mind is involved in its social evolution, and to the definition of which not only the processes of Western history, but the positions successively developed in Western thought, must all be considered as contributing. His great merit was the perception of the importance of the biological method in the science of society, the comprehension of the fact that there can be no science of society if its divisions are studied apart from each other; and finally, and although it led at the time to the formulation of no important principle of human development, the intuition that sociology was not simply a theory of the State, but the science of what he called the associated life of humanity.

It has to be observed that, preceding the application of the doctrine of evolution to society, most of the contributions to social science have a certain aspect in which they resemble each other. While in current theories **The Ruling Principle of** society tends to be presented as evolving, consciously or unconsciously, under stress of natural selection, **Early Sociological Conceptions:** towards social efficiency, the earlier contributions **influence of** were merely theories of the meaning and object **Greek Conception of the State.** of society as a medium for the better realization of human desires. In this presentation of the subject the influence of the Greek conception of the State upon modern sociology may be traced down to the present day. At the beginning of the modern period it reappears in Machiavelli (*Titus Livius*, i., iii., and *The Prince*). It is represented in modified form in Hobbes (*Leviathan*), and in Locke (*Two Treatises of Government*), each of whom conceived man as desiring to leave the state of nature and as consciously founding civilized society, “in order that he might obtain

the benefits of government” in the associated State. It is continued in Rousseau and the writers of the French Revolution, who similarly imagined the individual voluntarily leaving an earlier state of freedom to put “his person and his power under the direction of the general will” (*Social Contract*). It is characteristic of Jeremy Bentham (e.g. *Principles of Morals and Legislation*, i.) and of J. S. Mill (e.g. *Utilitarianism and Political Economy*, iv., vi.). Finally, it survives in Herbert Spencer, who in like manner sees man originating society and submitting to political subordination in the associated State “through experience of the increased satisfaction derived under it” (*Data of Ethics*). It continues at the present day to be characteristic of many European and some American writers on sociology, who have been influenced both by Spencer and the Latin theory of the State, and who therefore, conceiving sociology not so much as a science of social evolution as a theory of association, proceed to consider the progress of human association as the development of a process “of catering to human desire for satisfactions of varying degrees of complexity.” All these ideas of society bear the same stamp. They conceive the science of society as reached through the science of the individual, the associated State being regarded only as a medium through which he obtains increased satisfactions. In none of them is there a clear conception of an organic science of society with laws and principles of its own controlling all the meaning of the individual.

With the application of the doctrine of evolution the older idea in which society is always conceived as the State and as existing to give increased “satisfaction” is replaced **The Doctrine of Evolution.** by a new and much more extended conception. In the evolutionary view, the development of human society is regarded as the product of a process of stress, in which progress results from natural selection along the line not of least effort in realizing human desire, but of the highest social efficiency in the struggle for existence of the materials of which society is composed. In the intensity of this process society, evolving towards higher efficiency, tends to become increasingly organic, the distinctive feature being the growing subordination of the individual to the organic social process. All the tendencies of development—political, economic, ethical and psychological—and the contents of the human mind itself, have therefore to be regarded as having ultimate relations to the governing principles of the process as a whole. The science of social evolution has, in short, to be considered, according to this view, as the science of the causes and principles subordinating the individual to a process developing by inherent necessity towards social efficiency, and therefore as ultimately over-ruling all desires and interests in the individual towards the highest social potentiality of the materials of which society is composed. The conflict between the old and the new conceptions may be distinguished to an increasing degree as the scope of modern sociology has gradually become defined; and the opposing ideas of each may be observed to be sometimes represented and blended, in varying degrees of complexity, in one and the same writer.

It was natural that one of the first ideas to be held by theorists, as soon as sociology began to make progress to the position of a real science, was that society must be considered to be organic, and that the term “social organism” **First Conceptions of Society as an Organism.** should be brought into use. An increasing number of writers have been concerned with this aspect of the subject, but it has to be noted as a fact of much interest that all the first ideas of society as an organism move within the narrow circle of the old conception of the State just described. The “social organism” in this first stage of theory is almost universally confused with the State. The interests of the social organism are therefore confused with the interest of the individuals which men saw around them in the State. The science of society was accordingly regarded as no more than the science of realizing most effectively here and now the desires of those comprising the existing State. Sidgwick, for instance, considered the science of politics and the science of sociology as practically coincident,

and his *Elements of Politics*, extraordinary to relate, contains only a few words in which it is recognized that the welfare of the community may be interpreted to mean the welfare not only of living human beings, but of those who are to come hereafter; while there is no attempt to apply the fact to any law or principle of human development. Bentham's utilitarian philosophy, like that of the two Mills, was based almost entirely on the idea of the State conceived as the social organism. Writers like Herbert Spencer (*Sociology*) and Schäffle, who was for a time minister of commerce for Austria (*Bau und Leben des socialen Körpers*), instituted lengthy comparisons between the social organism considered as the State and the living individual organism. These efforts reached their most characteristic expression in the work of the sociologists who have followed G. Simmel in lengthy and ingenious attempts at classifying associations, considering them "as organizations for catering to human desire." In all these efforts the conception of the State as the social organism is vigorously represented, although it is particularly characteristic of the work of sociologists in countries where the influence of Roman law is still strong, and where, consequently, the Latin conception of the State tends to influence all theories of society as soon as the attempt is made to place them on a scientific basis. The sterilizing effect for long produced on sociology by this first restricted conception of the social organism has been most marked. It is often exemplified in ingenious attempts made, dealing with the principles of sociology, to construct long categories of human associations, based on quite superficial distinctions. None of the comparisons of this kind that have been made have contributed in any marked degree to the elucidation of the principles of modern society. Paul Leroy-Beaulieu's criticism of Schäffle's efforts at comparisons—*anatomical, physiological, biological and psychological*—between the individual organism and the State as a social organism applies to most of the attempts of this period to institute biological comparisons between the life of the social organism and that of organisms in general, "the mind sinks overwhelmed under the weight of all these analogies, these endless divisions and subdivisions to which they give rise. . . . The result is not in proportion to the effort" (*L'État moderne et ses fonctions*).

In tracing the direction of this conflict between the newer and older tendencies in modern sociology, it is in Herbert Spencer's writings that the student will find presented in the clearest definition the characteristic difficulty with which the old view has tended to be confronted, as the attempt has continued to be made to enunciate the principles of human development from the standpoint that society is to be considered as a "social organism," but while as yet there is no clear idea of a social organism with its own laws and its own consciousness quite distinct from, and extending far beyond those governing the interests of the individuals at present comprising the State.

With the application of the doctrine of evolution to society considered as an organism, a position has been brought into view of great interest. It is evident in considering the application of natural selection to human society that there is a fact, encountered at the outset, which is so fundamental that it must be held to control all the phenomena of social evolution. It is nowadays a commonplace of knowledge, that the potential efficiency of an organism must always be taken to be greater than the sum total of the potential efficiency of all its members acting as individuals. This arises in the first instance from the fact, to be observed on all hands in life, of the effects of organization, of division of labour, and of specialization of work. But in an organism of indefinitely extended existence like human society, it arises in a special sense from the operation of principles giving society prolonged stability. By these principles individual interests are subordinated over long periods of time to the larger interests of organic society in which the individuals for the time being cannot participate; and it is from this cause that civilization of the highest type obtains its characteristic potency and efficiency in the struggle for existence with lower types.

There follows from this fact, obvious enough once it is mentioned, an important inference. This is that in the evolution of society natural selection will, in its characteristic results, reach the individual not directly, but through society. That is to say, in social evolution, the interests of the individual, *qua* individual, cease to be a matter of first importance. It is by development in the individual of the qualities which will contribute most to the efficiency of society, that natural selection will in the long run produce its distinctive results in the human individual. It is, in short, about this function of socialization, involving the increasing subordination of the individual, that the continued evolution of society by natural selection must be held to centre. Societies in which the individuals resist the process quickly reach the limits of their progress, and have to give way in the struggle for existence before others more organic in which the process of subordination continues to be developed. In the end it is the social organizations in which the interests of the individual are most effectively included in and rendered subservient to the interests of society considered in its most organic aspect that, from their higher efficiency, are naturally selected. In other words, it is the principles subordinating the individual to the efficiency of society in those higher organic aspects that project far beyond the life-interests of its existing units which must ultimately control all principles whatever of human association.

Spencer, in an elaborate comparison which he made (*Essays*, vol. i., and *Principles of Sociology*) between the social organism and the individual organism brought into view a position which in its relation to this capital fact of human evolution exhibits in the clearest manner how completely all the early evolutionists, still under the influence of old conceptions, failed at first to grasp the significance of the characteristic problems of the social organism. Spencer's comparison originally appeared in an article published in the *Westminster Review* for January 1860 entitled "The Social Organism." This article is in many respects one of the most noteworthy documents in the literature of the last half of the 19th century. In comparing the social with the individual organism Spencer proceeded, after noting the various aspects in which a close analogy between the two can be established, to make, as regards society, an important distinction by which the nature of the difficulty in which he is involved is immediately made apparent. While in an individual organism, he pointed out, it is necessary that the lives of all the parts should be merged in the life of the whole, because the whole has a corporate consciousness capable of happiness or misery, it is not so with society. For in society, he added, the "living units do not and cannot lose individual consciousness, since the community as a whole has no corporate consciousness." Spencer proceeded, therefore, to emphasize the conclusion that "this is an everlasting reason why the welfare of citizens cannot rightly be sacrificed to some supposed benefit of the State; but why, on the other hand, the State is to be maintained solely for the benefit of citizens." The extraordinary conclusion is indeed reached by Spencer that "the corporate life in society must be subservient to the lives of the parts, instead of the lives of the parts being subservient to the corporate life." It will be here clearly in evidence that the "social organism" which Spencer had in view was the State. But it will be noticed at the same time how altogether remarkable was the position into which he was carried. Spencer, like most thinking minds of his time, had the clearest vision, constantly displayed in his writings, of the scientific importance of that development in history which has gradually projected the conception of the individual's rights outside all theories of obligation to the State. He wrote at a time when the attention of the Western mind in all progressive movements in Western politics had been for generations fixed on that development in which the liberties of the individual as against the State had been won. This development had involved nearly all Western countries in a titanic struggle against the institutions of an earlier form of society resting on force organized in the State. Spencer, therefore, like almost every advanced

writer of his period, had constantly before him the characteristic fact of his age, namely, that the meaning of the individual had come to be in some way accepted as transcending all theories of the State and all theories of his obligations to the State. The position was, therefore, very remarkable. Spencer has been for long accepted by the general mind as the modern writer who more than any other has brought into use the term "social organism," and who has applied the doctrine of evolution to the theory of its life. Yet here we see him involved in the apparent self-stultification of describing the social organism to us as that impossible thing, an organism "whose corporate life must be subservient to the lives of the parts instead of the lives of the parts being subservient to the corporate life." It was obvious that some profound confusion existed. The science of society was evidently destined to carry us much farther than this. If natural selection was to be taken as operating on society, and therefore as tending to produce the highest efficiency out of the materials that comprise it, it *must* be effecting the subordination of the interests of the units to the higher corporate efficiency of society. But one of only two conclusions could therefore result from Spencer's position. If we were to regard the "social organism" as an organism in which the corporate life must be subservient to the lives of the parts, instead of the lives of the parts being subservient to the corporate life, it would be necessary to hold that the individual had succeeded in arresting the characteristic effects of natural selection on society. But for the evolutionist, whose great triumph it had been to reveal to us the principles of natural selection in universal operation throughout life elsewhere, to have to regard them as suspended in human society would be an absurd anti-climax. Such being scarcely conceivable as a final position, it remained only to infer that natural selection must still be subordinating individual interests to some larger social meaning in the evolutionary process. But in this case, society must be subject to principles which reach farther than those Spencer conceived: it must be organic in some different and wider sense than he imagined, and the analogy of the "social organism" as confined within the consciousness of ascendant interests in the political State must be considered to be a false one.

We had, in short, reached a capital position in the history of sociology from which an entirely new horizon was about to become visible. The principles of society organic in a wider sense than had hitherto been conceived were about to be brought into the discussion. All the phenomena of the creeds and ethical systems of humanity, of the great systems of religion and philosophy, with the problems of which the human mind had struggled over immense stretches of time as the subordinating process had unfolded itself in history, were about to be brought into sociology. And not now as if these represented some detached and functionless development with which the science of society was not directly concerned, but as themselves the central feature of the evolutionary process in human society. The stage in the history of sociology characterized by the confusion of the principles governing the social organism with those governing the State, the stage which had lasted from the time of the Greeks to Spencer, and which had witnessed towards its close Sidgwick's statement that the science of sociology was in effect coincident with the science of politics, was thus bound to be definitely terminated by the application to the science of society of the doctrine of evolution. Yet Spencer, despite his popular association with the doctrine of evolution, is thus not to be reckoned as the first of the philosophers of this new stage. His place is really with the last great names of the preceding period. For his conception of society was that of Bentham, Mill and Sidgwick. His *Principles of Sociology* as a contribution to modern evolutionary science is necessarily rendered to a large extent futile by the sterilizing conception of a social organism "in which the corporate life must be subservient to the lives of the parts." It is indeed in the reversal of this conception that the whole significance of the application of the doctrine of evolution to the science of society consists. Henceforward we shall have to regard the social process in

evolution as a process with its own interests, its own psychology, its own consciousness and its own laws, all quite distinct from the political consciousness of the modern State, though indirectly controlling and governing the consciousness of the State so thoroughly that there can be no true science of the latter without a science of the former.

The new situation created in sociology as the doctrine of evolution began to be applied to the science had features of great interest. The advance had been made to a central position along two entirely distinct lines. The *First Darwinians* army of workers was, in consequence, divided into *two* *in Sociology*. two more or less isolated camps, each largely in ignorance of the relation of its own work to that in the other section. It is often said as a reproach to sociology in the period through which we are passing that it attracts the kind of recruits who are not best equipped for its work, while it repels the kind of mind of philosophical training and wide outlook which it ought to enlist in its service and for which it has most urgent need, the loss to sociology both in credit and efficiency being immense. This is the result of a peculiar situation. Those who are best qualified to understand the nature and scope of the problems with which sociology has to deal cannot fail to have the conviction strongly developed in them that the Darwinian principles of evolution which reveal to us what may be described as the dynamics of the universal life process have very important relations to the dynamics of the social process. The situation which has arisen in sociology, however, is a very curious one, although it is one easy to understand when the causes are explained. When the endeavour is made to follow Darwin and the early Darwinians through the facts and researches which led to the formulation of the law of natural selection it may be observed how their preoccupation was almost exclusively with the details of the struggle for existence not in societies, but as it was waged between individuals. This was so as a matter of course, from the character of the facts which wild nature supplied, reinforced as they were, by observations on domestic animals and the practices of breeders.

Darwin made no systematic study of society; and outside human society the struggle through which natural selection has operated has been mainly between individuals. It is, of course, sometimes remarked that the social life exists among animals and that the laws of the social life and of the herd are to be observed there, but as a matter of fact there is nothing whatever elsewhere in life to compare with what we see taking place in human society, namely, the gradual integration—still under all the stress of natural selection expressing its effects in the person of the individual—of an organic social process resting ultimately on mind. The laws of this process are necessarily quite different from the laws of the other and simpler process in operation lower down in life. If we regard the classes from which sociology as a science should be able to draw its most efficient recruits we see that at the present day they fall mainly into two camps. There are in the one camp the exponents of biological principles, often trained in one or more of the departments of biological science, who are attempting the application to human society of the principles with which they have become familiar elsewhere in life. There are in the second camp the exponents of various aspects of social philosophy. When the exponent of Darwinian principles advances to the study of society he is naturally strong in the conviction that he has in his hands a most potent instrument of knowledge which ought to carry him far in the organization of the social sciences and towards the unification of the leading principles underlying the facts with which they deal. But what we soon begin to see is that his training has been, and that his preoccupation still continues to be, with the facts and principles of the struggle for existence between individuals as displayed elsewhere in life. He does not easily realize, if he has not been trained in social philosophy, how infinitely more complex all the problems of natural selection have become in the social integration resting on mind which is taking place in human affairs; or how the social efficiency with which he has become now concerned is something quite distinct from the individual

efficiency with which he has been concerned elsewhere. He does not readily comprehend how the institutions which he sees being evolved in history have, in their effects on the individual, laws quite different from those which he applies in the breeding of animals; or how the dualism which has been opened in the human mind, as natural selection acts first of all on the individual in his own struggle with his fellows, and then, and to a ruling degree, acts on his as a member of organic society in the evolution of social efficiency, has in the religious and ethical systems of the race a phenomenology of its own, stupendous in extent and absolutely characteristic of the social process, which remains a closed book to him and the study of which he is often apt to consider for his purposes as entirely meaningless. All this became rapidly visible in the first approach of the early Darwinians to the science of society.

Darwin, as stated, had attempted no comprehensive or systematic study of society. But in a few chapters of the *Descent of Man* he had discussed the qualities of the human mind, including the social and moral feelings, from the point of view of the doctrine of natural selection enunciated in the *Origin of Species*. The standpoint he took up was, as might be expected, practically that of Mill and Spencer and other writers of the period on social subjects, from whom he quoted freely. But the note of bewilderment was remarkable. The conclusion remarked upon as implied in Spencer's theory of the social organism, but which Spencer himself hesitated to draw, namely, that natural selection was to be regarded as suspended in human society, Darwin practically formulated. Thus at times Darwin appeared to think that natural selection could effect but comparatively little in advanced society. "With highly civilized nations," he says, "continued progress depends to a subordinate degree on natural selection." While Darwin noted the obvious usefulness of the social and moral qualities in many cases, he felt constrained at the same time to remark upon their influence in arresting, as appeared to him, the action of natural selection in civilization. "We civilized men," he continues, "do our utmost to check the process of elimination (of the weak in body and mind); we build asylums for the imbeciles, the maimed and the sick; we institute poor laws; and our medical men exert their utmost skill to save the life of every one to the last moment." There is here in evidence no attempt to connect the phenomena thus brought into view with some wider principle of the evolutionary process which evidently must control them. There is no perception visible in Darwin's mind of these facts as constituting the phenomenology of a larger principle of natural selection; or of the higher organic efficiency in the struggle for existence of societies in which the sense of responsibility to life thus displayed has made most progress; or of the immense significance in social evolution as distinct from individual evolution of that deepening of the social consciousness of which this developing spiritual sense of responsibility to our fellow creatures is one of the outward marks characteristic of advanced societies.

In the year 1889 Alfred Russel Wallace in a statement of his conception of the doctrine of evolution in his book, *Darwinism*, brought more clearly into view the fundamental difficulty of the early Darwinians in applying the doctrine of natural selection to society. In the last chapter of the book Mr Wallace maintained that there were in "man's intellectual and moral nature . . . certain definite portions . . . which could not have been developed by variation and natural selection alone." Certain faculties, amongst which he classed the mathematical, artistic and metaphysical, the latter covering qualities with which he considered priests and philosophers to be concerned, were, he asserted, "altogether removed from utility in the struggle for life," and were, therefore, he thought, "wholly unexplained by the theory of natural selection." In this elementary conception which still survives in popular literature, the same confusion between individual efficiency and social efficiency has to be remarked upon. And there is in evidence the same failure to perceive that it is just these intellectual and

moral qualities which are the absolutely characteristic products of natural selection in advanced society, in that they contribute to the highest organic social efficiency. Wallace in the result proposed to consider man, in respect of these higher portions of his mind, as under the influence of some cause or causes wholly distinct from those which had shaped the development of life in its other characteristics. The weakness of this position was immediately apparent. To remove man as regards qualities so directly associated with his social evolution from the influence of the law of natural selection was felt to be a step backwards. The effect produced on the minds of the younger school of evolutionists was deep. It operated, indeed, not to convince them that Wallace was right, but to make them feel that his conception of natural selection operating in human society was still in some respect profoundly and radically incomplete.

A few years later, Huxley, though approaching the matter from a different direction, displayed a like bewilderment in attempting to apply the doctrine of evolution to the phenomena of organic society. With his mind fixed on the details of the individual struggle for existence among animals, Huxley reached in the Romanes lecture, delivered at Oxford in 1893, a position little different from that in which Wallace found himself. In this lecture Huxley actually proceeded to place the ethical process in human society in opposition to the cosmic process, to which latter alone he considered the struggle for existence and the principle of natural selection belonged. "Social progress," he went on to say, "means a checking of the cosmic process at every step and the substitution for it of another which may be called the ethical process; the end of which is not the survival of those who may happen to be the fittest, in respect of the whole of the conditions which obtain, but of those who are ethically the best." Thus the remarkable spectacle already witnessed in Spencer, Darwin and Wallace of the evolutionist attempting to apply his doctrines to human society, but having to regard his own central principle of natural selection as having been suspended therein, is repeated in Huxley. The futility of contemplating the ethical process as something distinct from the cosmic process was at once apparent. For the first lesson of evolution as applied to society must be that they are one and the same. So far indeed from ethical process checking the cosmic process, it must be regarded as the last and highest form of the cosmic process. The sense of subordination and sacrifice which forms the central principle of all the creeds of humanity, so far from being, as Wallace imagined, "altogether removed from utility" is, indeed, the highest form of social efficiency through which natural selection is producing its most far-reaching effects in the evolution of the most advanced and organic types of civilization.

A similar tendency continued to be in evidence in other directions. In an effort made a few years later to found a society for the study of sociology in Great Britain a very characteristic feature of the first papers contributed was the attempt to apply elementary biological generalizations regarding natural selection to a highly complex organism like human society, the writers having in most cases made no previous extensive or special study of the social process in history. The confusion between what constitutes individual efficiency in the individual and that higher social efficiency in the individual which everywhere controls and overrules individual efficiency was very marked. An early paper contributed in 1904 was by Mr (afterwards Sir) Francis Galton, one of the last and greatest of the early Darwinians. Galton had made many original contributions to the doctrine of evolution, and had been occupied previously with researches into individual efficiency as displayed among families, his *Hereditary Genius* being a notable book of this type. The object of his paper was to explain the scope and aim of a new science, "eugenics," which he defined as the science which deals with all the influences that improve the inborn qualities of the race and develop them to the utmost advantage. Galton found no difficulty whatever in setting up his sociological standards for the best specimens of the race. Even the animals in the Zoological Gardens, he

said, might be supposed to know the best specimens of their class. In society the list of best qualities would include health, energy, ability, manliness and the special aptitudes required by various professions and occupations. Everything in "the scientific breeding of the human race" was to be much as in the breeding of animals; for Galton proposed to leach morals out of the question as involving too many hopeless difficulties. This was the basis of the scheme of qualities from which he proposed to proceed to the improved breeding of society. The proposal furnishes one of the most striking and characteristic examples which have appeared of the deep-seated confusion prevailing in the minds of the early Darwinians between social efficiency and individual efficiency. Even from the few minor examples of society among the lower animals the true sociological criticism of such standards in eugenics might easily be supplied. For at the point at which the social insects, for instance, began their social integration all their standards were in the qualities which gave success in the struggle for existence between individuals. Had they, therefore, understood eugenics only in this light and in Galton's sense, they would have condemned at the first the beginnings of the peculiar social efficiency of the queen bee which now makes her devote her life entirely to egg-laying; still more would they have condemned the habits of the drones, through long persistence in which they have become degenerate as individuals; and in particular they would have condemned the habits of the workers which have led to their present undeveloped bodies and abortive individualistic instincts. But all these things have contributed in the highest degree to the social efficiency of the social insects and have made the type a winning one in evolution. The social integration of the social insects has been comparatively simple and did not, like that of human society, rest ultimately on mind, yet even in this elementary example it was evident what ruin and disaster would result from miscalled scientific breeding of the race if undertaken within the limits of such restricted conceptions of social efficiency. Galton's preoccupation, as in the case of most biological and medical schemes of improvement in the past, was with those individualistic qualities which contribute to the individual's success in the struggle for existence with his fellows. But it has been continuously obvious in history that individuals of the very highest social efficiency, the great organic minds of the race who, often quite unsuccessful in their lives as judged by individualistic standards, and who, often quite unperceived and unappreciated by their contemporaries, have been the authors of ideas, or moral conceptions or works of such organic importance that they have carried the race from one social horizon into another, have been just those individuals who would have entirely failed to pass the kind of prize-animal standards which Galton proposed to set up.

Galton's essay may be said to close that first epoch in the application of biological conceptions to sociology which opened with Spencer's essay in 1860. With the extending conception of the organic interests of society during the intervening period the idea of social efficiency had altered profoundly. For instance, a supposed standard of efficiency, which like Malthusianism represented to Mill at the opening of the period the last conclusion of science, had become towards the close scarcely more than a standard of "race suicide." It was not surprising that in these circumstances the representatives of those sciences which rested on a knowledge of the social process in history and philosophy continued to look coldly on the attempt of the first Darwinians to apply Darwinian principles to sociology. True, the development in their own sciences had been almost equally sterile, for they had themselves as yet no reasoned conception of the enormous importance of the Darwinian principle of evolution to these sciences in its capacity to reveal to them the dynamics of the social process. But they had watched the development of institutions in history; they had studied the growth of social types and the integration of great systems of belief; and they had struggled with the capital problems of the human mind in psychology and philosophy as the process had

continued. The two armies of workers continued to be organized into isolated camps, each with the most restricted conception of the nature and importance of the work done by the other and of its bearing upon their own conclusions. One of the most remarkable results of such a situation—a result plainly visible in the valuable collection of essays edited by Professor Seward which was issued from the Cambridge University Press in commemoration of the centenary of Darwin's birth—is the extremely limited number of minds in our time of sufficient scope of view to be able to cover the relation of the work of both sets of these workers to sociology.

It remains now to consider the relation to the position in modern sociology of the extended conception that society must be considered to be organic in some wider sense than the first Darwinians thus imagined it and also in some wider sense than that in which Sidgwick imagined it when he said that sociology was in effect coincident with the science of politics. The present writer has laid it down elsewhere (*The Two Principal Laws of Sociology*: Bologna) that there is a fundamental principle of sociology which has to be grasped and applied before there can be any real science of sociology. This principle may be briefly stated as follows:—

The social process is primarily evolving in the individual not the qualities which contribute to his own efficiency in conflict with his fellows, but the qualities which contribute to society's efficiency in the conflict through which it is gradually rising towards a more organic type.

This is the first law of evolutionary sociology. It is this principle which controls the integration which is taking place under all forms in human society—in ethical systems, in all political and economic institutions, and in the creeds and beliefs of humanity—in the long, slow, almost invisible struggle in which under a multitude of phases natural selection is discriminating between the standards of nations and types of civilization.

Dealing first with political and economic institutions; the position reached in Spencer's sociology may be said to represent the science of society in a state of transition. It represents it, that is to say, in a stage at which the Greek theory of society has become influenced by the doctrine of evolution applied to modern conceptions, but while as yet no synthesis has been achieved between the conflicting and even mutually exclusive ideas which are involved. The Greek theory of society is represented in Spencer in his practical identification of "the social organism" with the State. The modern idea, however, which carries Spencer far beyond the principles of Greek society—as these principles were summarized, for instance, in the passage already quoted from Bluntschli—is clearly in evidence. It may be observed to be expressed in the recognition of a principle resident in modern society which in some manner projects the individual's rights outside and beyond the whole theory and meaning of the State. In other words, in society as Spencer conceives it, "the welfare of citizens cannot rightly be sacrificed to some supposed benefit of the State"; whereas, according to the Greek theory and the theory of Roman law, the citizen's whole existence depended on and was subject to the State. "The State knew neither moral nor legal limits to its power." If, however, it be considered that modern society has made progress beyond the Greek, and if it be accepted that the theory of evolution involves the conclusion that society progresses towards increased efficiency in a more organic type, there follows from the foregoing an important inference. This is that it now becomes the task of modern sociology, as a true science, to show that the principle in modern civilization which distinguishes it from society of the Greek period—namely, that principle which Spencer rightly recognized, despite the contradictions in which he became involved, as rendering the life of the individual no longer subservient to the corporate life of the State—is itself a principle identified not with individualism but with the increasing subordination of the individual to a more organic type of society. It must, in short, remain for the evolutionist, working by the

The Close of the First Stage of Darwinian Theory.

Further Extension to Sociology of the Evolutionary Conception.

historical method scientifically applied, to present the intervening process in history—including the whole modern movement towards liberty and enfranchisement, and towards equality of conditions, of rights and of economic opportunities—not as a process of the increasing emancipation of the individual from the claims of society, but as a process of progress towards a more organic stage of social subordination than has prevailed in the world before.

When society is considered as an organism developing under the influence of natural selection along the line of the causes which contribute to its highest potential efficiency, and therefore tending to have the mean centre of its organic processes projected farther and farther into the future, it is evident that it must be the principles and ideas which most effectively subordinate over long periods of time the interests and the capacities of the individuals of which it is composed to the efficiency of the whole which will play the leading part in social evolution. In primitive society, the first rudiments of social organization undoubtedly arose, not so much from conscious regard to *The Basis* expediency or "increased satisfactions" as from *of Modern* fitness in the struggle for existence. "The first *Sociology* organized societies must have been developed, like any other advantage, under the sternest conditions of natural selection. In the flux and change of life the members of those groups of men which in favourable conditions first showed any tendency to social organization became possessed of a great advantage over their fellows, and these societies grew up simply because they possessed elements of strength which led to the disappearance before them of other groups of men with which they came into competition. Such societies continued to flourish, until they in their turn had to give way before other associations of men of higher social efficiency" (*Social Evolution*, ii.). In the social process at this stage all the customs, habits, institutions, and beliefs contributing to produce a higher organic efficiency of society would be naturally selected, developed and perpetuated. It is in connexion with this fact that the clue must be sought to the evolution of those institutions and beliefs of early society which have been treated of at length in researches like those of McLennan, Tylor, Lubbock, Waitz, Letourneau, Quatrefages, Frazer, and others of equal importance. For a long period in the first stages the highest potentiality of the social organization would be closely associated with military efficiency. For in the evolution of the social organism, as has been said, while the mean centre of the processes involving its organic identity would tend to be projected into the future, it would at the same time always be necessary to maintain efficiency in current environment in competition with rival types of lower future potentiality. Amongst primitive peoples, where a great chief, law-giver and military leader appeared, the efficiency of organized society resting on military efficiency would, as a matter of course, make itself felt in the struggle for existence. Yet as such societies would often be resolved into their component elements on the death of the leader, the overruling importance—on the next stage of the advance towards a more organic type—of ideas which would permanently subordinate the materials of society to the efficiency of the whole would make itself felt. Social systems of the type in which authority was perpetuated by ancestor-worship—in which all the members were therefore held to be joined in an exclusive religious citizenship founded on blood relationship to the deities who were worshipped, and in which all outsiders were accordingly treated as natural enemies, whom it would be a kind of sacrilege to admit to the rights of the State—would contain the elements of the highest military potentiality. The universal mark which ancestor-worship has left on human institutions in a certain stage of social development is doubtless closely associated with this fact. The new and the older tendencies in sociology are here also in contrast; for whereas Herbert Spencer has been content to explain ancestor-worship as arising from an introspective and comparatively trivial process of thought assumed to have taken place in the mind of early man in relation to a supposed belief in ghosts (*Principles of Sociology*, 68-207), the newer tendency is to

consider science as concerned with it in its relation to the characteristic principles through which the efficiency of the social organization expressed itself in its surroundings. The social, political and religious institutions disclosed in the study of the earliest civilizations within the purview of history must be considered to be all intimately related to the ruling principles of this military stage. The wide reach and significance of the causes governing the process of social evolution throughout the whole of this period may be gathered from treatises like Seebohm's *Structure of Greek Tribal Society*, Maine's *Ancient Law*, *History of Institutions*, and *Early Law and Custom*, Fowler's *City-State of the Greeks and Romans*, and in a special sense from the comparative study of Roman law, first of all as it is presented in the period of the Twelve Tables, then as the *jus civile* begins to be influenced by the *jus gentium*, and lastly as its principles are contrasted with those of English common law in the modern period. In most of the philosophical writings of the Greeks, and in particular in the *Ethics* and *Politics* of Aristotle, and in many of the *Dialogues* of Plato, the spirit of the principles upon which society was constructed in this stage may be perceived as soon as progress has been made with comparative studies in other directions.

A very pregnant saying of T. H. Green was that during the whole development of man the command, "Thou shalt love thy neighbour as thyself" has never varied. What *Extension of the Sense of Human Responsibility.* has varied is only the answer to the question—Who is my neighbour? If in the light of this profoundly true reflection we watch the progress of society from primitive conditions to the higher stages, it may be observed to possess marked features. Where all human institutions, as in the ancient civilizations, rested ultimately on force; where outsiders were regarded as natural enemies, and conquered enemies became slaves; where, as throughout all this phase of social evolution, a rule of religion was a rule of law identified with the principles of the State (Maine, *Ancient Law*); where the State itself was absolute as against the individual, knowing "neither moral nor legal limits to its power"; and where all the moral, intellectual and industrial life of the community rested on a basis of slavery—the full limits of the organic principle of social efficiency would in time be reached. The conditions would be inherent in which all social institutions would tend to become closed absolutisms organized round the conception of men's desires in the present. And the highest outward expression in which the tendencies in ethics, in politics, and in religion must necessarily culminate would be the military State, bounded in its energies only by the resistance of others, necessarily acknowledging no complete end short of absolute dominion, and therefore staying its course before no ideal short of universal conquest. This was the condition in the ancient State. It happened thus that the outward policy of the ancient State to other peoples became, by a fundamental principle of its life, a policy of military conquest and subjugation, the only limiting principle being the successful resistance of the others. The epoch of history moved by inherent forces towards the final emergence of one supreme military State, in an era of general conquest, and culminated in the example of universal dominion which we had in the Roman world before the rise of the civilization of our era.

The influence upon the development of civilization of the wider conception of duty and responsibility to one's fellow men which was introduced into the world with the spread of *its Influence on Social Efficiency.* Christianity can hardly be over-estimated. The extended conception of the answer to the question—Who is my neighbour? which has resulted from the characteristic doctrines of the Christian religion—a conception transcending all the claims of the family, group, state, nation, people or race, and even all the interests comprised in any existing order of society—has been the most powerful evolutionary force which has ever acted on society. It has tended gradually to break up the absolutisms inherited from an older civilization and to bring into being an entirely new type of social efficiency.

As society under this influence continued to be impelled to develop towards a still more organic type, the greatly higher potentiality of a state of social order which, while preserving the ideal of the highly organized state and the current efficiency of society in competition with lower types, was influenced by conceptions that dissolved all those closed absolutisms, and released human energies into a free conflict of forces by projecting the principles of human responsibility outside the State, became apparent. In many of the religions of the East such conceptions have been inherent, Christianity itself being a characteristically Eastern religion. But no Eastern people has been able to provide for them the permanent defensive military *milieu* in history in which alone their potentiality could be realized. The significance of modern Japan in evolution consists largely in the answer she is able to give to the question as to whether she will be able to provide in the future such a *milieu* for such a conception among an Eastern people.

The significance of the culmination of the military epoch in the ancient classic civilizations of the Western world, which preceded the opening of the era in which we are living, and of the fact that the peoples of the same descent who were destined to carry on the civilization of the existing era represent the supreme military stock by natural selection, not only of the entire world, but of the evolutionary process itself in human history, will therefore be evident.

With the spread, accordingly, amongst peoples of this origin, and in such a defensive military *milieu* in history, of a new conviction of responsibility to principles extending beyond the consciousness of the political State, there began a further and more organic stage of the evolutionary process in society. The gradual dissolution in the era in which we are living of all the closed absolutisms within the State, in which human action and ideas had hitherto been confined, is apparently the characteristic phenomenon of this stage. Progress is towards such a free and tolerant, but intense and efficient, conflict of forces as was not possible in the world before. It is, it would appear, in this light that we must regard the slow dissolution of the basis of ideas upon which slavery rested; the disintegration of the conceptions which supported the absolute position of the occupying classes in the State; the undermining of the ideas by which opinion was supported by the civil power of the State in the religious struggles of the middle ages; the growth of the conception that no power or opinion in the State can be considered as the representative of absolute truth; the consequent development of party government amongst the advanced peoples, with the acknowledgment of the right of every department of inquiry to carry results up to that utmost limit at which they are controlled only by the results obtained in other departments of activity with equal freedom; the growth of the conception, otherwise absurd, of the native equality of men; the resulting claim, otherwise similarly indefensible, of men to equal voting power irrespective of status or possessions in the State which has been behind the movement towards political enfranchisement; and, finally, the development of that conviction which is behind the existing challenge to all absolute tendencies in economic conditions in the modern world—namely, that the distribution of wealth in a well-ordered State should aim at realizing political justice. There are all the features of an integrating process in modern history. They must be considered as all related to a controlling principle inherent in the Christian religion which has rendered the evolutionary process in society more organic than in any past stage—namely, the projection of the sense of human responsibility outside the limits of all the creeds and interests which had in previous stages embodied it in the State (Kidd, *Prin. West. Civil.*). The meaning, in short, which differentiates our civilization from that of the ancient civilizations of Greece and Rome is that modern Western civilization represents in an ever-increasing degree the

enfranchisement of the future in the evolutionary process. So great has become the prestige of our civilization through the operation of this principle in it that its methods and results are being eagerly borrowed by other peoples. It is thereby so materially influencing the standards of conduct and culture throughout the world that the developments which other nations are undergoing have in a real sense tended to become scarcely more than incidents in the expansion of Western civilization.

We live in the presence of colossal national armaments, and in a world, therefore, in which we are continually met with the taunt that force is still everywhere omnipotent. It may be perceived, however, that beneath all outward appearances a vast change has been taking place. In the ancient civilizations the tendency to conquest was an inherent principle in life of the military State. It is no longer an inherent principle in the modern State. The right of conquest is indeed still acknowledged in the international law of civilized States; but it may be observed to be a right becoming more and more impracticable among the more advanced peoples. Reflection, moreover, reveals the fact that the right of conquest is tending to become impracticable and impossible, not, as is often supposed, because of the huge armaments of resistance with which it might be opposed, but because the sense of social responsibility has been so deepened in our civilization that it is almost impossible that one nation should attempt to conquer and subdue another after the manner of the ancient world. It would be regarded as so great an outrage that it would undoubtedly prove to be one of the maddest and one of the most unprofitable adventures in which a civilized State could engage. Militarism, it may be distinguished, is becoming mainly defensive amongst the more advanced nations. Like the civil power within the State, it is tending to represent rather the organized means of resistance to the methods of force should these methods be invoked by others temporarily or permanently under the influence of less evolved standards of conduct.

In thus regarding the social process in Western history, the projected efficiency of which now, after many centuries of development, begins to realize itself to an increasing degree in determining competition with other types of society throughout the world, it may be observed that the result by which a synthesis of the older and later views may be attained is already in sight. It was pointed out that if the principle which Spencer rightly recognized in modern society as rendering the life of the individual no longer subservient to the corporate life of the State was to be accepted as a principle of progress distinguishing modern civilization from that of the Greek period, it would be necessary for the sociologist to exhibit it not as indicating the larger independence of the individual, but as a principle identified with the increasing subordination of the individual to a more organic type of society. Here, therefore, this result is in process of accomplishment. The intervening process in history—including the whole modern movement towards liberty and enfranchisement, towards equality of conditions, towards equality of political rights and towards equality of economic opportunities—is presented as a process of development towards a more advanced and organic stage of social subordination than has ever prevailed in the world before (*Prin. West. Civil.* xi.). In this light, also, it may be observed how the claim of sociology to be the most advanced of all the theoretical sciences is justified. For if the historical process in the civilization of the era in which we are living is thus to be regarded as a process implying the increasing subordination of the individual to a more organic type of society, then the study of sociology as embracing the principles of the process must evidently involve the perception and comparison of the meaning of the fundamental positions disclosed in the history of political progress, of the problems with which the human mind has successively struggled in the phases of religious development, and, lastly, of the positions with which the intellect has been confronted as the stages of the subordinating process have

Modern Militarism is therefore becoming a Defensive, not an Offensive Principle.

Individualism is only a Process of more Organic Social Subordination.

gradually come to define themselves in history. The positions outlined in the developments already referred to which have come down through Hume and Huxley, through Kant and Hegel, through Grotius and Savigny, through Roscher and Schmoller, through the expression which English utilitarianism has reached in Herbert Spencer as influenced by the English theory of the rights of the individual on the one hand, and in Marxian Socialism as influenced by the Latin conception of the omnipotence of the State on the other, have thus all their place, meaning and scientific relations in the modern study of sociology. It must be considered that the theory of organic evolution by natural selection and the historical method will continue in an increasing degree to influence the science of society.

The sociological law that "the social process is primarily evolving in the individual not the qualities which contribute to his own efficiency in conflict with his fellows, but those qualities which contribute to society's efficiency in the conflict through which it is gradually rising towards a more organic type," carries us into the innermost recesses of the human mind and controls the science of psychology. For it is thus not the human mind which is consciously constructing the social process in evolution; it is the social process which is constructing the human mind in evolution. This is the ultimate fact which raises sociology to its true position as the master science. Nor is there any materialism in such a conception. It is in keeping with the highest spiritual ideal of man that the only conception of Truth or the Absolute which the human mind can hold at present is that which is being evolved in it in relation to its own environment which is in the social process.

AUTHORITIES.—It has been one of the results of the conditions affecting sociology in the past, that many of the principal contributions to the science of society are not usually included in lists of sociological references. The following are mentioned only as indicating or suggesting others in the same classes of equal or perhaps greater importance. The dates given are usually those of the first edition of a work.

INTRODUCTORY.—Darwin, *Origin of Species* (1859); *Descent of Man*, 1871 (chapters dealing with society); Wallace, *Darwinism* (1889); Romanes, *Darwin and after Darwin* (1892); Osborn, *From the Greeks to Darwin* (1894). *Economics, Historical.*—Ashley, *Introduction to English Economic History and Theory*, part i. (1888), part ii. (1893); Schmoller, *The Mercantile System* (1884); Roscher, *Geschichte der Nationalökonomik in Deutschland* (1874); Nys, *History of Economics* (Trans. Dryhurst, 1899). *Ethics, Historical.*—Sidgwick, *History of Ethics* (1886); Mackenzie, *Manual of Ethics* (1893); Hobhouse, *Morals in Evolution* (1906). *Primitive Society.*—Lubbock, *Origin of Civilization* (1870); Tylor, *Anthropology* (1881); Quatrefages, *Human Species* (Eng. trans. 1879); Lang, *Custom and Myth* (1884); Maine, *Ancient Law* (1861); *Early History of Institutions* (1875); *Early Law and Custom* (1883); Frazer, *Golden Bough* (1890); *Early History of the Kingship* (1905).

GENERAL.—Spencer, *Synthetic Philosophy (Principles of Biology, Principles of Sociology and Principles of Ethics)*; Kidd, *Social Evolution* (1894); *Principles of Western Civilization* (1902); *Individualism and After; Two Principal Laws of Sociology*; Bologna (1908); Barth, *Die Philosophie der Geschichte als Sociologie* (1897); Ward, *Dynamic Sociology; Outline of Sociology* (1898); Flint, *Philosophy of History in Europe* (1874); *Historical Philosophy in France* (1894); Bagehot, *Physics and Politics*; Ratzel, *Die soziologische Erkenntnis* (1898); Giddings, *Principles of Sociology* (1896); Tarde, *Étude de psychologie sociale* (1898); Stuckenbergh, *Introduction to the Study of Sociology* (1898); Stephen, *The English Utilitarians* (1900); J. S. Mill, *System of Logic* (1843); *On Liberty* (1859); *Utilitarianism* (1861); Comte, *Philosophie positive* (6 vols., 1830–1842, Eng. trans., condensed by Martineau, in 2 vols.; Baldwin, *Social Psychology*; Ritchie, *Natural Rights* (1895); Bluntschli, *The Theory of the State* (Eng. trans. 1892); Wright, *Outline of Practical Sociology* (1899); Sidgwick, *Methods of Ethics* (1874); *Elements of Politics* (1901); *Philosophy, its Scope* (1902); Taylor, *The Problem of Conduct* (1901); Kant, *Critique of Pure Reason* (particularly 2nd Division), and *Prolegomena to any Future Metaphysic*; McDougall, *An Introduction to Social Psychology* (1908); Schiller, *Studies in Humanism* (1907); James, *Pragmatism* (1907); Fairbanks, *Introduction to Sociology* (1896); Pollock, *History of the Science of Politics* (1890); Maine, *Popular Government* (1885); Morley, *Rousseau* (1873); *Diderot and the Encyclopaedists* (1878); *Burke* (1879); Austin, *Theory of Jurisprudence* (1861–1863); Holland, *Elements of Jurisprudence* (parts i., iii. and iv., 1880); *Studies in International Law* (1898); Westlake, *International Law* (1894); Bentham, *Principles of Morals and Legislation* (1789), Oxf. ed., 1879; Sohm, *Institutes of Roman Law*; Sandars, *Institutes of Justinian*; Le Roy Beaulieu, *L'État*

moderne et ses fonctions; Huxley, *Evolution and Ethics* (1894); Nietzsche, *The Twilight of the Idols; Zarathustra*; Loria, *Les Bases économiques de la constitution sociale* (French trans.); Pearson, *National Life and Character* (1893); Vincent, *The Social Mind in Education* (1897); Marx, *Kapital* (1867, Eng. trans. 1887); Engels, *Socialism, Utopian and Scientific* (Eng. trans., Aveling, 1892); Kirkup, *An Inquiry into Socialism* (1907); George, *Progress and Poverty*; Mazel, *La Synergie sociale* (1896); Mallock, *Aristocracy and Evolution* (1898); Ross, *Social Control* (1901); Mackenzie, *Social Philosophy* (1895); Hobson, *The Social Problem* (1901); *Fabian Essays*; Rousseau, *Social Contract*; Hobbes, *Leviathan*; Locke, *Two Treatises of Government*; Webbs, *Industrial Democracy* (1897); *History of Trades Unionism* (1894); Booth, *Life and Labour of the People* (1891–1897); Patten, *The Theory of Prosperity* (1902); Wallas, *Human Nature in Politics* (1908); Urwick, *Luxury and Waste* (1908); Small, *The Scope of Sociology* (1902). (B. K.*)

SOCRATES, son of the statuary Sophroniscus and of the midwife Phaenarete, was born at Athens, not earlier than 471 nor later than May or June 469 B.C. As a youth he received the customary instruction in gymnastics and music; and in after years he made himself acquainted with geometry and astronomy and studied the methods and the doctrines of the leaders of Greek thought and culture. He began life as a sculptor; and in the 2nd century A.D. a group of the Graces, supposed to be his work, was still to be seen on the road to the Acropolis. But he soon abandoned art and gave himself to what may best be called education, conceiving that he had a divine commission, witnessed by oracles, dreams and signs, not indeed to teach any positive doctrine, but to convict men of ignorance mistaking itself for knowledge, and by so doing to promote their intellectual and moral improvement. He was on terms of intimacy with some of the most distinguished of his Athenian contemporaries, and, at any rate in later life, was personally known to very many of his fellow citizens. His domestic relations were, it is said, unhappy. The shrewishness of his wife Xanthippe became proverbial with the ancients, as it still is with ourselves. Aristotle, in his remarks upon genius and its degeneracy (*Rhet.* ii. 15), speaks of Socrates's sons as dull and fatuous; and in Xenophon's *Memorabilia*, one of them, Lamprocles, receives a formal rebuke for undutiful behaviour towards his mother.

Socrates served as a hoplite at Potidaea (432–429), where on one occasion he saved the life of Alcibiades, at Delium (424), and at Amphipolis (422). In these campaigns his bravery and endurance were conspicuous. But, while he thus performed the ordinary duties of a Greek citizen with credit, he neither attained nor sought political position. His "divine voice," he said, had warned him to refrain from politics, presumably because office would have entailed the sacrifice of his principles and the abandonment of his proper vocation. Yet in 406 he was a member of the senate; and on the first day of the trial of the victors of Arginusae, being president of the prytanis, he resisted—first, in conjunction with his colleagues, afterwards, when they yielded, alone—the illegal and unconstitutional proposal of Callixenus, that the fate of the eight generals should be decided by a single vote of the assembly. Not less courageous than this opposition to the "civium ardor prava jubentium" was his disregard of the "vultus instantis tyranni" two years later. During the reign of terror of 404 the Thirty, anxious to implicate in their crimes men of repute who might otherwise have opposed their plans, ordered five citizens, one of whom was Socrates, to go to Salamis and bring thence their destined victim Leon. Socrates alone disobeyed. But, though he was exceptionally obnoxious to the Thirty—as appears, not only in this incident, but also in their threat of punishment under a special ordinance forbidding "the teaching of the art of argument"—it was reserved for the reconstituted democracy to bring him to trial and to put him to death. In 399, four years after the restoration and the amnesty, he was indicted as an offender against public morality. His accusers were Meletus the poet, Anytus the tanner and Lycon the orator, all of them members of the democratic or patriot party who had returned from Phyle with Thrasybulus. The accusation ran thus: "Socrates is guilty, firstly, of denying the gods recognized by the state and introducing new divinities, and, secondly, of corrupting the young." In his unpremeditated defence, so far from seeking to conciliate his judges, Socrates

defied them. He was found guilty by 280 votes, it is supposed, against 220. Meletus having called for capital punishment, it now rested with the accused to make a counter-proposition; and there can be little doubt that, had Socrates without further remark suggested some smaller but yet substantial penalty, the proposal would have been accepted. But, to the amazement of the judges and the distress of his friends, Socrates proudly declared that for the services which he had rendered to the city he deserved, not punishment, but the reward of a public benefactor—maintenance in the Prytaneum at the cost of the state; and, although at the close of his speech he professed himself willing to pay a fine of one mina, and upon the urgent entreaties of his friends raised the amount of his offer to thirty minas, he made no attempt to disguise his indifference to the result. His attitude exasperated the judges, and the penalty of death was decreed by an increased majority. Then in a short address Socrates declared his contentment with his own conduct and with the sentence. Whether death was a dreamless sleep, or a new life in Hades, where he would have opportunities of testing the wisdom of the heroes and the sages of antiquity, in either case he esteemed it a gain to die. In the same spirit he refused to take advantage of a scheme arranged by his friend Crito for an escape from prison. Under ordinary circumstances the condemned criminal drank the cup of hemlock on the day after the trial; but in the case of Socrates the rule that during the absence of the sacred ship sent annually to Delos no one should be put to death caused an exceptional delay. For thirty days he remained in imprisonment, receiving his intimates and conversing with them in his accustomed manner. How in his last conversation he argued that the wise man will regard approaching death with a cheerful confidence Plato relates in the *Phaedo*; and, while the central argument—which rests the doctrine of the soul's immortality upon the theory of ideas—must be accounted Platonic, in all other respects the narrative, though not that of an eye-witness, has the air of accuracy and truth.

Happily, though Socrates left no writings behind him, and indeed, as will hereafter appear, was by his principles precluded from dogmatic exposition, we have in the *Ἀπομνημονεύματα* or *Memoirs* and other works of Xenophon records of Socrates's conversation, and in the dialogues of Plato refined applications of his method. Xenophon, having no philosophical views of his own to develop, and no imagination to lead him astray—being, in fact, to Socrates what Boswell was to Johnson—is an excellent witness. The *Ἀπομνημονεύματα* or *Memorabilia* are indeed confessedly apologetic, and it is easy to see that nothing is introduced which might embitter those who, hating Socrates, were ready to persecute the Socratics; but the plain, straightforward narrative of Socrates's talk, on many occasions, with many dissimilar interlocutors, carries with it in its simplicity and congruity the evidence of substantial justice and truth. Plato, though he understood his master better, is a less trustworthy authority, as he makes Socrates the mouthpiece of his own more advanced and even antagonistic doctrine. Yet to all appearance the *Apology* is a careful and exact account of Socrates's habits and principles of action; the earlier dialogues, those which are commonly called "Socratic," represent, with such changes only as are necessitated by their form, Socrates's method; and, if in the later and more important dialogues the doctrine is the doctrine of Plato, echoes of the master's teaching are still discoverable, approving themselves as such by their accord with the Xenophontean testimony. In the face of these two principal witnesses other evidence is of small importance.

Personal Characteristics.—What, then, were the personal characteristics of the man? Outwardly his presence was mean and his countenance grotesque. Short of stature, thick-necked and somewhat corpulent, with prominent eyes, with nose upturned and nostrils outspread, with large mouth and coarse lips, he seemed the embodiment of sensuality and even stupidity. Inwardly he was, as his friends knew, "so pious that he did nothing without taking counsel of the gods, so just that he never did an injury to any man, whilst he was the benefactor of his associates, so temperate that he never preferred pleasure to right, so wise that in judging of good and evil he was never at fault—in a word, the best and the happiest of men." "His self-control was absolute; his powers of endurance were unailing; he had so schooled himself to moderation that his scanty means satisfied all his wants." "To want nothing," he said himself,

"is divine; to want as little as possible is the nearest possible approach to the divine life"; and accordingly he practised temperance and self-denial to a degree which some thought ostentatious and affected. Yet the hearty enjoyment of social pleasures was another of his marked characteristics; for to abstain from innocent gratification from fear of falling into excess would have seemed to him to imply a pedantic formalism or a lack of self-control. In short, his strength of will, if by its very perfection it led to his theoretical identification of virtue and knowledge, secured him in practice against the ascetic extravagances of his associate Antisthenes.

The intellectual gifts of Socrates were hardly less remarkable than his moral virtues. Naturally observant, acute, and thoughtful, he developed these qualities by constant and systematic use. The exercise of the mental powers was, he conceived, no mere occupation of leisure hours, but rather a sacred and ever-present duty; because, moral error being intellectual error translated into act, he who would live virtuously must first rid himself of ignorance and folly. He had, it may be conjectured, but little turn for philosophical speculation; yet by the careful study of the ethical problems which met him in himself and in others he acquired a remarkable tact in dealing with questions of practical morality; and in the course of the lifelong war which he waged against vagueness of thought and laxity of speech he made himself a singularly apt and ready reasoner.

While he regarded the improvement, not only of himself but also of others, as a task divinely appointed to him, there was in his demeanour nothing exclusive or pharisaical. On the contrary, deeply conscious of his own limitations and infirmities, he felt and cherished a profound sympathy with erring humanity, and loved with a love passing the love of women fellow men who had not learnt, as he had done, to overcome human frailties and weaknesses. Nevertheless great wrongs roused in him a righteous indignation which sometimes found expression in fierce and angry rebuke. Indeed it would seem that Plato in his idealized portrait gives his hero credit not only for a deeper philosophical insight but also for a greater urbanity than facts warranted. Hence, whilst those who knew him best met his affection with a regard equal to his own, there were, as will be seen hereafter, some who never forgave his stern reproofs, and many who regarded him as an impertinent busybody.

He was a true patriot. Deeply sensible of his debt to the city in which he had been born and bred, he thought that in giving his life to the teaching of sounder views in regard to ethical and political subjects he made no more than an imperfect return; and, when in the exercise of constitutional authority that city brought him to trial and threatened him with death, it was not so much his local attachment, strong though that sentiment was, as rather his sense of duty, which forbade him to retire into exile before the trial began, to acquiesce in a sentence of banishment when the verdict had been given against him, and to accept the opportunity of escape which was offered him during his imprisonment. Yet his patriotism had none of the narrowness which was characteristic of the patriotism of his Greek contemporaries. His generous benevolence and unaffected philanthropy taught him to overstep the limits of the Athenian demus and the Hellenic race, and to regard himself as a "citizen of the world."

He was blest with an all-pervading humour, a subtle but kindly appreciation of the incongruities of human nature and conduct. In a less robust character this quality might have degenerated into sentimentality or cynicism; in Socrates, who had not a trace of either, it showed itself principally in what his contemporaries knew as his "accustomed irony." Profoundly sensible of the inconsistencies of his own thoughts and words and actions, and shrewdly suspecting that the like inconsistencies were to be found in other men, he was careful always to place himself upon the standpoint of ignorance and to invite others to join him there, in order that, proving all things, he and they might hold fast that which is good. "Intellectually the acutest man of his age," says W. H. Thompson in a brilliant

and instructive appendix to his edition of Plato's *Phaedrus*, "he represents himself in all companies as the dullest person present. Morally the purest, he affects to be the slave of passion, and borrows the language of gallantry to describe a benevolence too exalted for the comprehension of his contemporaries. He is by turns an *ἐραστής*, a *προαγωγός*, a *μαστροπός*, a *μαιευτικός*, disguising the sanctity of his true vocation by names suggestive of vile or ridiculous images. The same spirit of whimsical paradox leads him, in Xenophon's *Banquet*, to argue that his own satyr-like visage was superior in beauty to that of the handsomest man present. That this irony was to some extent calculated is more than probable; it disarmed ridicule by anticipating it; it allayed jealousy and propitiated envy; and it possibly procured him admission into gay circles from which a more solemn teacher would have been excluded. But it had for its basis a real greatness of soul, a hearty and unaffected disregard of public opinion, a perfect disinterestedness, an entire abnegation of self. He made himself a fool that others by his folly might be made wise; he humbled himself to the level of those among whom his work lay that he might raise some few among them to his own level; he was 'all things to all men, if by any means he might win some.'" It would seem that this humorous depreciation of his own great qualities, this pretence of being no better than his neighbours, led to grave misapprehension amongst his contemporaries. That it was the foundation of the slanders of the Peripatetic Aristoxenus can hardly be doubted.

Socrates was further a man of sincere and fervent piety. "No one," says Xenophon, "ever knew of his doing or saying anything profane or unholy." There was indeed in the popular mythology much which he could not accept. It was incredible, he argued, that the gods should have committed acts which would be disgraceful in the worst of men. Such stories, then, must be regarded as the inventions of lying poets. But, when he had thus purified the contemporary polytheism, he was able to reconcile it with his own steadfast belief in a Supreme Being, the intelligent and beneficent Creator of the universe, and to find in the national ritual the means of satisfying his religious aspirations. For proof of the existence of "the divine," he appealed to the providential arrangement of nature, to the universality of the belief, and to the revelations and warnings which are given to men through signs and oracles. Thinking that the soul of man partook of the divine, he maintained the doctrine of its immortality as an article of faith, but not of knowledge. While he held that, the gods alone knowing what is for man's benefit, man should pray, not for particular goods, but only for that which is good, he was regular in prayer and punctual in sacrifice. He looked to oracles and signs for guidance in those matters, and in those matters only, which could not be resolved by experience and judgment, and he further supposed himself to receive special warnings of a mantic character through what he called his "divine sign" (*δαίμονιον, δαιμόνιον σημεῖον*).

Socrates's frequent references to his "divine sign" were, says Xenophon, the origin of the charge of "introducing new divinities" brought against him by his accusers, and in early Christian times, amongst Neoplatonic philosophers and fathers of the church, gave rise to the notion that he supposed himself to be attended by a "genius" or "daemon." Similarly in our own day spiritualists have attributed to him the belief—which they justify—in "an intelligent spiritual being who accompanied him through life—in other words, a guardian spirit" (A. R. Wallace). But the very precise testimony of Xenophon and Plato shows plainly that Socrates did not regard his "customary sign" either as a divinity or as a genius. According to Xenophon, the sign was a warning, either to do or not to do, which it would be folly to neglect, not superseding ordinary prudence, but dealing with those uncertainties in respect of which other men found guidance in oracles and tokens; Socrates believed in it profoundly, and never disobeyed it. According to Plato, the sign was a "voice" which warned Socrates to refrain from some act which he contemplated; he heard it frequently and on the most trifling occasions; the phenomenon dated from his early years, and was, so far as he knew, peculiar to himself. These statements have been variously interpreted. Thus it has been maintained that, in laying claim to supernatural revelations, Socrates (1) committed a pious fraud, (2) indulged his "accustomed irony," (3) recognized the voice of conscience, (4) indicated a general

belief in a divine mission, (5) described "the inward voice of his individual tact, which in consequence partly of his experience and penetration, partly of his knowledge of himself and exact appreciation of what was in harmony with his individuality, had attained to an unusual accuracy," (6) was mad ("*était fou*"), being subject not only to hallucinations of sense but also to aberrations of reason. Xenophon's testimony that Socrates was plainly sincere in his belief excludes the first and second of these theories; the character of the warnings given, which are always concerned, not with the moral worth of actions, but with their uncertain results, warrants the rejection of the third and the fourth; the fifth, while it sufficiently accounts for the matter of the warning, leaves unexplained its manner, the vocal utterance; the sixth, while it plausibly explains the manner of the warning, goes beyond the facts when it attributes to it irrationality of matter. It remains for us, then, modifying the fifth hypothesis, that of Diderot, Zeller and others, and the sixth, that of Lélut and Littré, and combining the two, to suppose that Socrates was subject, not indeed to delusions of mind, but to hallucinations of the sense of hearing, so that the rational suggestions of his own brain, exceptionally valuable in consequence of the accuracy and delicacy of his highly cultivated tact, seemed to him to be projected without him, and to be returned to him through the outward ear. It appears that, though in some of the best known instances—for example, those of Cowper and Sidney Walker—hallucinations of the sense of hearing, otherwise closely resembling Socrates's "divine sign," have been accompanied by partial derangement of reason, cases are not wanting in which "the thoughts transformed into external sensorial impressions" are perfectly rational.

The eccentricity of Socrates's life was not less remarkable than the oddity of his appearance and the irony of his conversation. His whole time was spent in public—in the market-place, the streets, the gymnasium. Thinking *Mode of Life.* with Dr Johnson that "a great city is the school for studying life," he had no liking for the country, and seldom passed the gates. "Fields and trees," Plato makes him say, "will not teach me anything; the life of the streets will." He talked to all comers—to the craftsman and the artist as willingly as to the poet or the politician—questioning them about their affairs, about the processes of their several occupations, about their notions of morality, in a word, about familiar matters in which they might be expected to take an interest. The ostensible purpose of these interrogatories was to test, and thus either refute or explain, the famous oracle which had pronounced him the wisest of men. Conscious of his own ignorance, he had at first imagined that the god was mistaken. When, however, experience showed that those who esteemed themselves wise were unable to give an account of their knowledge, he had to admit that, as the oracle had said, he was wiser than others, in so far as, whilst they, being ignorant, supposed themselves to know, he, being ignorant, was aware of his ignorance. Such, according to the *Apology*, was Socrates's account of his procedure and its results. But it is easy to see that the statement is coloured by the accustomed irony. When in the same speech Socrates tells his judges that he would never from fear of death or from any other motive disobey the command of the god, and that, if they put him to death, the loss would be, not his, but theirs, since they would not readily find any one to take his place, it becomes plain that he conceived himself to hold a commission to educate, and was consciously seeking the intellectual and moral improvement of his countrymen. His end could not be achieved without the sacrifice of self. His meat and drink were of the poorest; summer and winter his coat was the same; he was shoeless and shirtless. "A slave whose master made him live as you live," says a sophist in the *Memorabilia*, "would run away." But by the surrender of the luxuries and the comforts of life Socrates secured for himself the independence which was necessary that he might go about his appointed business, and therewith he was content.

His message was to all, but it was variously received. Those who heard him perforce and occasionally were apt to regard his teaching either with indifference or with irritation, *Contemporary Judgments.*—with indifference, if, as might be, they failed to see in the elenchus anything more than elaborate trifling; with irritation, if, as was probable, they perceived that, in spite of his assumed ignorance, Socrates was well aware of the result to which their enforced answers tended. Amongst

those who deliberately sought and sedulously cultivated his acquaintance there were some who attached themselves to him as they might have attached themselves to any ordinary sophist, conceiving that by temporary contact with so acute a reasoner they would best prepare themselves for the logomachies of the law courts, the assembly and the senate. Again, there were others who saw in Socrates at once master, counsellor and friend, and hoped by associating with him "to become good men and true, capable of doing their duty by house and household, by relations and friends, by city and fellow-citizens" (Xenophon). Finally, there was a little knot of intimates who, having something of Socrates's enthusiasm, entered more deeply than the rest into his principles, and, when he died, transmitted them to the next generation. Yet even those who belonged to this inner circle were united, not by any common doctrine, but by a common admiration for their master's intellect and character.

For, the paradoxes of Socrates's personality and the eccentricity of his behaviour, if they offended the many, fascinated the few.

Plato's Panegyric. "It is not easy for a man in my condition," says the intoxicated Alcibiades in Plato's *Symposium*, "to describe the singularity of Socrates's character.

But I will try to tell his praises in similitudes. He is like the piping Silenes in the statuaries' shops, which, when you open them, are found to contain images of gods. Or, again, he is like the satyr Marsyas, not only in outward appearance—that, Socrates, you will yourself allow—but in other ways also. Like him, you are given to frolic—I can produce evidence to that; and above all, like him, you are a wonderful musician. Only there is this difference—what he does with the help of his instrument you do with mere words; for whatsoever man, woman or child hears you, or even a feeble report of what you have said, is struck with awe and possessed with admiration. As for myself, were I not afraid that you would think me more drunk than I am, I would tell you on oath how his words have moved me—ay, and how they move me still. When I listen to him my heart beats with a more than Corybantic excitement; he has only to speak and my tears flow. Orators, such as Pericles, never moved me in this way—never roused my soul to the thought of my servile condition; but this Marsyas makes me think that life is not worth living so long as I am what I am. Even now, if I were to listen, I could not resist. So there is nothing for me but to stop my ears against this siren's song and fly for my life, that I may not grow old sitting at his feet. No one would think that I had any shame in me; but I am ashamed in the presence of Socrates."

The Accusation and its Causes.—The life led by Socrates was not likely to win for him either the affection or the esteem of the vulgar. Those who did not know him personally, seeing him with the eyes of the comic poets, conceived him as a "visionary" (*μετεωρολόγος*) and a "bore" (*ἄδολεσχος*). Those who had faced him in argument, even if they had not smarted under his rebukes, had at any rate winced under his interrogatory, and regarded him in consequence with feelings of dislike and fear. But the eccentricity of his genius and the ill will borne towards him by individuals are not of themselves sufficient to account for the tragedy of 399. It thus becomes necessary to study the circumstances of the trial, and to investigate the motives which led the accusers to seek his death and the people of Athens to acquiesce in it.

Socrates was accused (1) of denying the gods recognized by the state and introducing instead of them strange divinities (*δαιμόνια*), and (2) of corrupting the young. The first of these charges rested upon the notorious fact that he supposed himself to be guided by a divine visitant or sign (*δαιμόνιον*). The second, Xenophon tells us, was supported by a series of particular allegations: (a) that he taught his associates to despise the institutions of the state, and especially election by lot; (b) that he had numbered amongst his associates Critias and Alcibiades, the most dangerous of the representatives of the oligarchical and democratical parties respectively; (c) that he taught the young to disobey parents and guardians and to prefer his own authority to theirs; (d) that he was in the habit of

quoting mischievous passages of Homer and Hesiod to the prejudice of morality and democracy.

It is plain that the defence was not calculated to conciliate a hostile jury. Nevertheless, it is at first sight difficult to understand how an adverse verdict became possible. If Socrates rejected portions of the conventional mythology, he accepted the established faith and performed its offices with exemplary regularity. If he talked of a *δαιμόνιον*, the *δαιμόνιον* was no new divinity, but a mantic sign divinely accorded to him, presumably by the gods of the state. If he questioned the propriety of certain of the institutions of Athens, he was prepared to yield an unhesitating obedience to all. He had never countenanced the misdeeds of Critias and Alcibiades, and indeed, by a sharp censure, had earned the undying hatred of one of them. Duty to parents he inculcated as he inculcated other virtues; and, if he made the son wiser than the father, surely that was not a fault. The citation of a few lines from the poets ought not to weigh against the clear evidence of his large-hearted patriotism; and it might be suspected that the accuser had strangely misrepresented his application of the familiar words.

To the modern reader Xenophon's reply, of which the foregoing is in effect a summary, will probably seem sufficient, and more than sufficient. But it must not be forgotten that Athenians of the old school approached the subject from an entirely different point of view. Socrates was in all things an innovator—in religion, inasmuch as he sought to eliminate from the theology of his contemporaries "those lies which poets tell"; in politics, inasmuch as he distrusted several institutions dear to Athenian democracy; in education, inasmuch as he waged war against authority, and in a certain sense made each man the measure of his own actions. It is because Socrates was an innovator that we, who see in him the founder of philosophical inquiry, regard him as a great man; it was because Socrates was an innovator that old-fashioned Athenians, who saw in the new-fangled culture the origin of all their recent distresses and disasters, regarded him as a great criminal. It is, then, after all in no wise strange that a majority was found first to pronounce him guilty, and afterwards, when he refused to make any submission and professed himself indifferent to any mitigation of the penalty, to pass upon him the sentence of death. That the verdict and the sentence were not in any way illegal is generally acknowledged.

But, though the popular distrust of eccentricity, the irritation of individuals and groups of individuals, the attitude of Socrates himself, and the prevalent dislike of the intellectual movement which he represented, go far to account for the result of the trial, they do not explain the occasion of the attack. Socrates's oddity and brusquerie were no new things; yet in the past, though they had made him unpopular, they had not brought him into the courts. His sturdy resistance to the demos in 406 and to the Thirty in 404 had passed, if not unnoticed, at all events unpunished. His political heresies and general unorthodoxy had not caused him to be excluded from the amnesty of 403. Why was it, then, that in 399, when Socrates's idiosyncrasies were more than ever familiar, and when the constitution had been restored, the toleration hitherto extended to him was withdrawn? What were the special circumstances which induced three members of the patriot party, two of them leading politicians, to unite their efforts against one who apparently was so little formidable?

For an answer to this question it is necessary to look to the history of Athenian politics. Besides the oligarchical party, properly so called, which in 411 was represented by the Four Hundred and in 404 by the Thirty, and the democratical party, which returned to power in 410 and in 403, there was at Athens during the last years of the Peloponnesian War a party of "moderate oligarchs," antagonistic to both. It was to secure the co-operation of the moderate party that the Four Hundred in 411 promised to constitute the Five Thousand, and that the Thirty in 404 actually constituted

Strength of the Defence.

Its Weakness.

Occasion of the Attack.

Political Reasons for it.

the Three Thousand. It was in the hope of realizing the aspirations of the moderate party that Theramenes, its most prominent representative, allied himself, first with the Four Hundred, afterwards with the Thirty. In 411 the policy of Theramenes (*q.v.*) was temporarily successful, the Five Thousand superseding the Four Hundred. In 404 the Thirty outwitted him; for, though they acted upon his advice so far as to constitute the Three Thousand, they were careful to keep all real power in their own hands. But on both occasions the "polity"—for such, in the Aristotelian sense of the term, the constitution of 411-410 was, and the constitution of 404-403 professed to be—was insecurely based, so that it was not long before the "unmixed democracy" was restored. The programme of the "moderates"—which included (1) the limitation of the franchise, by the exclusion of those who were unable to provide themselves with the panoply of a hoplite and thus to render to the city substantial service, (2) the abolition of payment for the performance of political functions, and, as it would seem, (3) the disuse of the lot in the election of magistrates—found especial favour with the intellectual class. Thus Alcibiades was amongst its promoters, and Thucydides commends the constitution established after the fall of the Four Hundred as the best which in his time Athens had enjoyed. Now it is expressly stated that Socrates disliked election by lot; it is certain that, regarding paid educational service as a species of prostitution, he would account paid political service not a whit less odious; and the stress laid by the accuser upon the Homeric quotation (*Iliad* ii. 188-202)—which ends with the lines *δαμόνι, ἀτρέμας ἦσό, καὶ ἄλλων μῦθον ἄκουε οἷ σέο φέρτεροί εἰσι· σὺ δ' ἀπτόλεμος καὶ ἀνακίς, οὐτε ποτ' ἐν πολέμῳ ἐναρίθμιος οὐτ' ἐνὶ βουλῇ*—becomes intelligible if we may suppose that Socrates, like Theramenes, wished to restrict the franchise to those who were rich enough to serve as hoplites at their own expense. Thus, as might have been anticipated, Socrates was a "moderate," and the treatment which he received from both the extreme parties suggests—even if with Grote we reject the story told by Diodorus (xiv. 5), how, when Theramenes was dragged from the altar, Socrates attempted a rescue—that his sympathy with the moderate party was pronounced and notorious. Even in the moment of democratic triumph the "moderates" made themselves heard, Phormisus proposing that those alone should exercise the franchise who possessed land in Attica; and it is reasonable to suppose that their position was stronger in 399 than in 403. These considerations seem to indicate an easy explanation of the indictment of Socrates by the democratic politicians. It was a blow struck at the "moderates," Socrates being singled out for attack because, though not a professional politician, he was the very type of the malcontent party, and had done much, probably more than any man living, to make and to foster views which, if not in the strict sense of the term oligarchical, were confessedly hostile to the "unmixed democracy." His eccentricity and heterodoxy, as well as the personal animosities which he had provoked, doubtless contributed, as his accusers had foreseen, to bring about the conviction; but, in the judgment of the present writer, it was the fear of what may be called "philosophical radicalism" which prompted the action of Meletus, Anytus and Lycon. The result did not disappoint their expectations. The friends of Socrates abandoned the struggle and retired into exile; and, when they returned to Athens, the most prominent of them, Plato, was careful to confine himself to theory, and to announce in emphatic terms his withdrawal from the practical politics of his native city.

Method and Doctrine.—Socrates was not a "philosopher," nor yet a "teacher," but rather an "educator," having for his function "to rouse, persuade and rebuke" (Plato, *Apology*, 30 E). Hence, in examining his life's work it is proper to ask, not What was his philosophy? but What was his theory, and what was his practice, of education? It is true that he was brought to his theory of education by the study of previous philosophies, and that his practice led to the Platonic revival; but to attribute to him philosophy, except in that loose sense in which philosophy is ascribed to one who, denying the existence of such a thing, can give an account of his disbelief, is misleading and even erroneous.

Socrates's theory of education had for its basis a profound and consistent scepticism; that is to say, he not only rejected the conflicting theories of the physicists—of whom "some *Scepticism.* conceived existence as a unity, others as a plurality; some affirmed perpetual motion, others perpetual rest; some declared becoming and perishing to be universal, others altogether denied such things"—but also condemned, as a futile attempt to transcend the limitations of human intelligence, their *φιλοσοφία*, their "pursuit of knowledge for its own sake." Unconsciously, or more probably consciously, Socrates rested his scepticism upon the Protagorean doctrine that man is the measure of his own sensations and feelings; whence he inferred, not only that knowledge such as the philosophers had sought, certain knowledge of nature and its laws, was unattainable, but also that neither he nor any other person had authority to overbear the opinions of another, or power to convey instruction to one who had it not. Accordingly, whereas Protagoras and others, abandoning physical speculation and coming forward as teachers of culture, claimed for themselves in this new field power to instruct and authority to dogmatize, Socrates, unable to reconcile himself to this inconsistency, proceeded with the investigation of principles until he found a resting-place, a *ποῦ στῶ*, in the distinction between good and evil. While all opinions were equally true, of those opinions which were capable of being translated into act some, he conceived, were as working hypotheses more serviceable than others. It was here that the function of such a one as himself began. Though he had neither the right nor the power to force his opinions upon another, he might by a systematic interrogatory lead another to substitute a better opinion for a worse, just as a physician by appropriate remedies may enable his patient to substitute a healthy sense of taste for a morbid one. To administer such an interrogatory and thus to be the physician of souls was, Socrates thought, his divinely appointed duty; and, when he described himself as a "talker" or "converser," he not only negatively distinguished himself from those who, whether philosophers or sophists, called themselves "teachers" (*διδασκαλοὶ*), but also positively indicated the method of question and answer (*διαλεκτική*) which he consistently preferred and habitually practised.

That it was in this way that Socrates was brought to regard "dialectic," "question and answer," as the only admissible method of education is, in the opinion of the present writer, no matter of mere conjecture. In the review of theories of knowledge which has come down to us in Plato's *Theaetetus* mention is made (172 B) of certain "incomplete Protagoreans," who held that, while all opinions are equally true, one opinion is better than another, and that the "wise man" is one who by his arguments causes good opinions to take the place of bad ones, thus reforming the soul of the individual or the laws of a state by a process similar to that of the physician or the farmer (166 D seq.); and these "incomplete Protagoreans" are identified with Socrates and the Socratics by their insistence (167 D) upon the characteristically Socratic distinction between disputation and dialectic, as well as by other familiar traits of Socratic converse. In fact, this passage becomes intelligible and significant if it is supposed to refer to the historical Socrates; and by teaching us to regard him as an "incomplete Protagorean" it supplies the link which connects his philosophical scepticism with his dialectical theory of education. It is no doubt possible that Socrates was unaware of the closeness of his relationship to Protagoras; but the fact, once stated, hardly admits of question.

In the application of the "dialectical" or "maieutic" method two processes are distinguishable—the destructive process, by which the worse opinion was eradicated, and the constructive *Its two Processes.* process, by which the better opinion was induced. In general it was not mere "ignorance" with which Socrates had to contend, but "ignorance mistaking itself for knowledge" or "false conceit of wisdom"—a more stubborn and a more formidable foe, who, safe so long as he remained in his intrenchments, must be drawn from them, circumvented, and surprised. Accordingly, taking his departure from some apparently remote principle or proposition to which the respondent yielded a ready assent, Socrates would draw from it an unexpected but undeniable consequence which was plainly inconsistent with the opinion impugned. In this way he brought his interlocutor to pass judgment upon himself, and reduced him to a state of "doubt" or "perplexity" (*ἀροπία*). "Before I ever met you," says Meno in the dialogue which Plato called by his name (79 E), "I was told that you spent your time in doubting and leading others to doubt; and it is a fact that your witcheries and spells have brought me to that condition; you are like the torpedo: as it benumbs any one who approaches and touches it, so do you. For myself, my soul and my tongue are benumbed, so that I have no answer to give you." Even if, as often happened, the respondent, baffled and disgusted by the *ἄεργος* or destructive process, at this point withdrew from the inquiry, he had, in Socrates's judgment, gained something; for, whereas formerly, being ignorant, he had supposed himself to have knowledge, now, being ignorant, he was in some sort conscious of his ignorance, and accordingly would be for the future more circumspect in action. If, however, having been thus convinced of ignorance,

the respondent did not shrink from a new effort, Socrates was ready to aid him by further questions of a suggestive sort. Consistent thinking with a view to consistent action being the end of the inquiry, Socrates would direct the respondent's attention to instances analogous to that in hand, and so lead him to frame for himself a generalization from which the passions and the prejudices of the moment were, as far as might be, excluded. In this constructive process, though the element of surprise was no longer necessary, the interrogative form was studiously preserved, because it secured at each step the conscious and responsible assent of the learner.

Of the two processes of the dialectical method, the *ελεγχος* or destructive process attracted the more attention, both in consequence of its novelty and because many of those who willingly or unwillingly submitted to it stopped short at the stage of "perplexity." But to Socrates and his intimates the constructive process was the proper and necessary sequel. It is true that in the dialogues of Plato the destructive process is not always, or even often, followed by construction, and that in the *Memorabilia* of Xenophon construction is not always, or even often, preceded by the destructive process. There is, however, in this nothing surprising. On the one hand, Xenophon, having for his principal purpose the defence of his master against vulgar calumny, seeks to show by effective examples the excellence of his positive teaching, and accordingly is not careful to distinguish, still less to emphasize, the negative procedure. On the other hand, Plato, his aim being not so much to preserve Socrates's positive teaching as rather by written words to stimulate the reader to self-scrutiny, just as the spoken words of the master had stimulated the hearer, is compelled by the very nature of his task to keep the constructive element in the background, and, where Socrates would have drawn an unmistakable conclusion, to confine himself to enigmatical hints. For example, when we compare Xenophon's *Memorabilia*, iv. 6, 2-4, with Plato's *Euthyphro*, we note that, while in the former the interlocutor is led by a few suggestive questions to define "piety" as "the knowledge of those laws which are concerned with the gods," in the latter, though on a further scrutiny it appears that "piety" is "that part of justice which is concerned with the service of the gods," the conversation is ostensibly inconclusive. In short, Xenophon, a mere reporter of Socrates's conversations, gives the results, but troubles himself little about the steps which led to them; Plato, who in early manhood was an educator of the Socratic type, withholds the results that he may secure the advantages of the elenctic stimulus.

What, then, were the positive conclusions to which Socrates carried his hearers? and how were those positive conclusions obtained? Turning to Xenophon for an answer to these questions, we note (1) that the recorded conversations are concerned with practical action, political, moral, or artistic; (2) that in general there is a process from the known to the unknown through a generalization, expressed or implied; (3) that the generalizations are sometimes rules of conduct, justified by examination of known instances, sometimes definitions similarly established. Thus, in *Memorabilia*, iv. 1, 3, Socrates argues from the known instances of horses and dogs that the best natures stand most in need of training, and then applies the generalization to the instance under discussion, that of men; and in iv. 6, 13-14, he leads his interlocutor to a definition of "the good citizen," and then uses it to decide between two citizens for whom respectively superiority is claimed. Now in the former of these cases the process—which Aristotle would describe as "example" (*παράδειγμα*), and a modern might regard as "induction" of an uncritical sort—sufficiently explains itself. The conclusion is a provisional assurance that in the particular matter in hand a certain course of action is, or is not, to be adopted. But it is necessary to say a word of explanation about the latter case, in which, the generalization being a definition, that is to say, a declaration that to a given term the interlocutor attaches in general a specified meaning, the conclusion is a provisional assurance that the interlocutor may, or may not, without falling into inconsistency, apply the term in question to a certain person or act. Moral error, Socrates conceived, is largely due to the misapplication of general terms, which, once affixed to a person or to an act, possibly in a moment of passion or prejudice, too often stand in the way of sober and careful reflection. It was in order to exclude error of this sort that Socrates insisted upon *τὸ ἀριεῖσθαι καθόλου* with *ἐπακτικοὶ λόγοι* for its basis. By requiring a definition and the reference to it of the act or person in question, he sought to secure in the individual at any rate consistency of thought, and, in so far, consistency of action. Accordingly he spent his life in seeking and helping others to seek "the what" (*τὸ τί*), or the definition, of the various words by which the moral quality of actions is described, valuing the results thus obtained not as contributions to knowledge, but as means to right action in the multifarious relations of life.

While, however, Socrates sought neither knowledge, which in the strict sense of the word he held to be unattainable, nor yet, except as a means to right action, true opinion, the results of observation accumulated until they formed, not perhaps a system of ethics, but at any rate a body of ethical doctrine. Himself blessed with a will so powerful

that it moved almost without friction, he fell into the error of ignoring its operations, and was thus led to regard knowledge as the sole condition of well-doing. Where there is knowledge—that is to say, practical wisdom (*φρόνησις*), the only knowledge which he recognized—right action, he conceived, follows of itself; for no one knowingly prefers what is evil; and, if there are cases in which men seem to act against knowledge, the inference to be drawn is, not that knowledge and wrongdoing are compatible, but that in the cases in question the supposed knowledge was after all ignorance. Virtue, then, is knowledge, knowledge at once of end and of means, irresistibly realizing itself in act. Whence it follows that the several virtues which are commonly distinguished are essentially one. "Piety," "justice," "courage" and "temperance" are the names which "wisdom" bears in different spheres of action: to be pious is to know what is due to the gods; to be just is to know what is due to men; to be courageous is to know what is to be feared and what is not; to be temperate is to know how to use what is good and avoid what is evil. Further, inasmuch as virtue is knowledge, it can be acquired by education and training, though it is certain that one soul has by nature a greater aptitude than another for such acquisition.

But, if virtue is knowledge, what has this knowledge for its object? To this question Socrates replies, Its object is the Good. What, then, is the Good? It is the useful, the advantageous. Utility, the immediate utility of the individual, thus becomes the measure of conduct and the foundation of all moral rule and legal enactment. Accordingly, each precept of which Socrates delivers himself is recommended on the ground that obedience to it will promote the pleasure, the comfort, the advancement, the well-being of the individual; and Prodicus's apologue of the Choice of Heracles, with its commonplace offers of worldly reward, is accepted as an adequate statement of the motives of virtuous action. Of the graver difficulties of ethical theory Socrates has no conception, having, as it would seem, so perfectly absorbed, the lessons of what Plato calls "political virtue" that morality has become with him a second nature, and the scrutiny of its credentials from an external standpoint has ceased to be possible. His theory is indeed so little systematic that, whereas, as has been seen, virtue or wisdom has the Good for its object, he sometimes identifies the Good, with virtue or wisdom, thus falling into the error which Plato (*Republic* vi. 505 C), perhaps with distinct reference to Socrates, ascribes to certain "cultivated thinkers." In short, the ethical theory of Socrates, like the rest of his teaching, is by confession unscientific; it is the statement of the convictions of a remarkable nature, which statement emerges in the course of an appeal to the individual to study consistency in the interpretation of traditional rules of conduct. For a critical examination of the ethical teaching which is here described in outline, see ETHICS.

The Socratics.

It has been seen that, so far from having any system, physical or metaphysical, to enunciate, Socrates rejected "the pursuit of knowledge for its own sake" as a delusion and a snare,—a delusion, inasmuch as knowledge, properly so called, is unattainable, and a snare, in so far as the pursuit of it draws us away from the study of conduct. He has therefore no claim to be regarded as the founder of a philosophical school. But he had made some tentative contributions to a theory of morality; he had shown both in his life and in his death that his principles stood the test of practical application; he had invented a method having for its end the rectification of opinion; and, above all, he had asserted "the autonomy of the individual intellect." Accordingly, not one school but several schools sprang up amongst his associates, those of them who had a turn for speculation taking severally from his teaching so much as their pre-existing tendencies and convictions allowed them to assimilate. Thus Aristippus of Cyrene interpreted hedonistically the theoretical morality; Antisthenes the Cynic copied and caricatured the austere example; Euclides of Megara practised and perverted the elenctic method; Plato the Academic, accepting the whole of the Socratic teaching, first developed it harmoniously in the sceptical spirit of its author, and afterwards, conceiving that he had found in Socrates's agnosticism the germ of a philosophy, proceeded to construct a system which should embrace at once ontology, physics, and ethics. From the four schools thus established sprang subsequently four other schools,—the Epicureans being the natural successors of the Cyrenaics, the Stoics of the Cynics, the Sceptics of the Megarians, and the Peripatetics of the Academy. In this way the teaching of Socrates made itself felt throughout the whole of the post-Socratic philosophy. Of the influence which he exercised upon Aristippus, Antisthenes and Euclides, the "incomplete Socratics," as they are commonly called, as well as upon the "complete Socratic," Plato, something must now be said.

The "incomplete Socratics" were, like Socrates, sceptics; but, whereas Aristippus, who seems to have been in contact with Protagoreanism before he made acquaintance with Socrates, came to scepticism, as Protagoras had done, from the standpoint of the pluralists, Antisthenes, like his former master Gorgias, and Euclides, in whom the ancients

Maleptic in Plato and Xenophon.

Induction and Definition.

Theory of the Good.

Socratic Schools.

Incomplete Socratics.

Virtue is Knowledge.

rightly saw a successor of Zeno, came to scepticism from the standpoint of Eleatic henism. In other words, Aristippus was sceptical because, taking into account the subjective element in sensation, he found himself compelled to regard what are called "things" as successions of feelings, which feelings are themselves absolutely distinct from one another; while Antisthenes and Euclides were sceptical because, like Zeno, they did not understand how the same thing could at the same moment bear various and inconsistent epithets, and consequently conceived all predication which was not identical to be illegitimate. Thus Aristippus recognized only feelings, denying things; Antisthenes recognized things, denying attributions; and it is probable that in this matter Euclides was at one with him. For, though since Schleiermacher many historians, unnecessarily identifying the *εἰδῶν φῶλοι* of Plato's *Sophist* with the Megarians, have ascribed to Euclides a theory of "ideas," and on the strength of this single passage thus conjecturally interpreted have added a new chapter to the history of Megarianism, it is difficult, if not impossible, to see how, if the founder of the school had broken loose from the trammels of the Zenonian paradox, his successors, and amongst them Stilpo, should have reconciled themselves, as they certainly did, to the Cynic denial of predication.

While the "incomplete Socratics" made no attempt to overpass the limits which Socrates had imposed upon himself, within those limits they occupied each his department. Aristippus, a citizen of the world, drawn to Athens by the fame of Socrates, and retained there by the sincere affection which he conceived for him, interpreted the ethical doctrine of Socrates in accordance with his own theory of pleasure, which in its turn came under the refining influence of Socrates's theory of *φρόνησις*. Contrariwise, Antisthenes, a rugged but not ungenerous nature, a hater of pleasure, troubled himself little about ethical theory and gave his life to the imitation of his master's asceticism. Virtue, he held, depended upon "works," not upon arguments or lessons; all that was necessary to it was the strength of a Socrates (Diog. Laërt. vi. 11). Yet here too the Socratic theory of *φρόνησις* had a qualifying effect; so that Cyrenaic hedonism and Cynic asceticism sometimes exhibit unexpected approximations. The teaching of Euclides, though the Good is still supposed to be the highest object of knowledge, can hardly be said to have an ethical element; and in consequence of this deficiency the dialectic of Socrates degenerated in Megarian hands, first into a series of exercises in fallacies, secondly into a vulgar and futile eristic. In fact, the partial Socraticisms of the incomplete Socratics necessarily suffered, even within their own narrow limits, by the dismemberment which the system had undergone. Apparently the maieutic theory of education was not valued by any of the three; and, however this may be, they deviated from Socratic tradition so far as to establish schools, and, as it would seem, to take fees like the professional educators called Sophists.

Of the relations in which the metaphysics of Plato stood to the Socratic search for definitions there are of necessity almost as many theories as there are interpretations of the Platonic system. Hence in this place the writer must content himself with a summary statement of his own views. Initiated into philosophical speculation by the Heraclitean Cratylus, Plato began his intellectual life as an absolute sceptic, the followers of Heraclitus having towards the end of the 5th century pushed to its conclusion the unconscious scepticism of their master. There would have been then nothing to provoke surprise, if, leaving speculation, Plato had given himself to politics. In 407, however, he became acquainted with Socrates, who gave to his thoughts a new direction. Plato now found an occupation for his intellectual energies, as Socrates had done, in the scrutiny of his beliefs and the systematization of his principles of action. But it was not until the catastrophe of 399 that Plato gave himself to his life's work. An exile, cut off from political ambitions, he came forward as the author of dialogues which aimed at producing upon readers the same effect which the voice of the master had produced upon hearers. For a time he was content thus to follow in the steps of Socrates, and of this period we have records in those dialogues which are commonly designated Socratic. But Plato had too decided a bent for metaphysics to linger long over propaedeutic studies. Craving knowledge—not merely provisional and subjective knowledge of ethical concepts, such as that which had satisfied Socrates, but knowledge of the causes and laws of the universe, such as that which the physicists had sought—he asked himself what was necessary that the "right opinion" which Socrates had obtained by abstraction from particular instances might be converted into "knowledge" properly so called. In this way Plato was led to assume for every Socratic universal a corresponding unity, eternal, immutable, suprasensual, to be the cause of those particulars which are called by the common name. On this assumption the Socratic definition or statement of the "what" of the universal, being obtained by the inspection of particulars, in some sort represented the unity, form, or "idea" from which they derived their characteristics, and in so far was valuable; but, inasmuch as the inspection of the particulars was partial and imperfect, the Socratic definition was only a partial and imperfect representation of the eternal, immutable, suprasensual, idea. How, then, was the imperfect representation of the idea to be converted into a perfect representation? To this question Plato's answer was vague and tentative. By constant

revision of the provisional definitions which imperfectly represented the ideas he hoped to bring them into such shapes that they should culminate in the definition of the supreme principle, the Good, from which the ideas themselves derive their being. If in this way we could pass from uncertified general notions, reflections of ideas, to the Good, so as to be able to say, not only that the Good causes the ideas to be what they are, but also that the Good causes the ideas to be what we conceive them, we might infer, he thought, that our definitions, hitherto provisional, are adequate representations of real existences. But the Platonism of this period had another ingredient. It has been seen that the Eleatic Zeno had rested his denial of plurality upon certain supposed difficulties of predication, and that they continued to perplex Antisthenes as well as perhaps Euclides and others of Plato's contemporaries. These difficulties must be disposed of, if the new philosophy was to hold its ground; and accordingly, to the fundamental assertion of the existence of eternal immutable ideas, the objects of knowledge, Plato added two subordinate propositions, namely, (1) "the idea is immanent in the particular," and (2) "there is an idea wherever a plurality of particulars is called by the same name." Of these propositions the one was intended to explain the attribution of various and even inconsistent epithets to the same particular at the same time, whilst the other was necessary to make this explanation available in the case of common terms other than the Socratic universals. Such was the Platonism of the *Republic* and the *Phaedo*, a provisional ontology, with a scheme of scientific research, which, as Plato honestly confessed, was no more than an unrealized aspiration. It was the non-Socratic element which made the weakness of this, the earlier, theory of ideas. Plato soon saw that the hypothesis of the idea's immanence in particulars entailed the sacrifice of its unity, whilst as a theory of predication that hypothesis was insufficient, because applicable to particulars only, not to the ideas themselves. But with clearer views about relations and negations the paradox of Zeno ceased to perplex; and with the consequent withdrawal of the two supplementary articles the development of the fundamental assumption of ideas, eternal, immutable, suprasensual, might be attempted afresh. In the more definite theory which Plato now propounded the idea was no longer a Socratic universal perfected and hypostatized, but rather the perfect type of a natural kind, to which type its imperfect members were related by imitation, whilst this relation was metaphysically explained by means of a "thoroughgoing idealism" (R. D. Archer-Hind). Thus, whereas in the earlier theory of ideas the ethical universals of Socrates had been held to have a first claim to hypostatization in the world of ideas, they are now peremptorily excluded, whilst the idealism which reconciles plurality and unity gives an entirely new significance to so much of the Socratic element as is still retained.

The growth of the metaphysical system necessarily influenced Plato's ethical doctrines; but here his final position is less remote from that of Socrates. Content in the purely Socratic period to elaborate and to record ethical definitions such as Socrates himself might have propounded, Plato, as soon as the theory of ideas offered itself to his imagination, looked to it for the foundation of ethics as of all other sciences. Though in the earlier ages both of the individual and of the state a sound utilitarian morality of the Socratic sort was useful, nay valuable, the morality of the future should, he thought, rest upon the knowledge of the Good. Such is the teaching of the *Republic*. But with the revision of the metaphysical system came a complete change in the view which Plato took of ethics and its prospects. Whilst in the previous period it had ranked as the first of sciences, it was now no longer a science; because, though Good absolute still occupied the first place, Good relative and all its various forms—justice, temperance, courage, wisdom—not being ideas, were incapable of being "known." Hence it is that the ethical teaching of the later dialogues bears an intelligible, though perhaps unexpected, resemblance to the simple practical teaching of the unphilosophical Socrates.

Yet throughout these revolutions of doctrine Plato was ever true to the Socratic theory of education. His manner indeed changed; for, whereas in the earlier dialogues the characteristics of the master are studiously and skillfully preserved, in the later dialogues Socrates first becomes metaphysical, then ceases to be protagonist, and at last disappears from the scene. But in the later dialogues, as in the earlier, Plato's aim is the aim which Socrates in his conversation never lost sight of, namely, the dialectical improvement of the learner.

BIBLIOGRAPHY.—Of the histories of Greek philosophy the most convenient for the study of Socrates's life and work is Zeller's *Philosophie d. Griechen*. The part in question has been translated into English under the title of *Socrates and the Socratic Schools* (London, 1877). For a list of special treatises, see Ueberweg in his *Grundriss d. Geschichte d. Philosophie*. The following sources of information may be specially mentioned: F. Schleiermacher, "Ueber d. Werth d. Sokrates als Philosophen," in *Abh. d. berliner Akad. d. Wissensch.* (1815) and *Werke*, iii. 2, 287–308, translated into English by C. Thirlwall in the *Philological Museum* (Cambridge, 1833), ii. 538–555; L. F. Lélut, *Du Démon de Socrate* (Paris, 1836, 1856), reviewed by E. Littré in *Médecine et médecins* (Paris, 1872); G. Grote, *History of Greece*, ch. lxxviii., and *Plato and the Other Companions*

of *Sokrates* (London, 1865); C. F. Hermann, *De Socratis accusatoribus* (Göttingen, 1854); W. H. Thompson, *The Phaedrus of Plato* (London, 1868), Appendix I.; Joel, *Der echte und der Xenophontische Sokrates* (1901). For the view taken in the present article with regard to the δαίμωνιον, see the writer's paper "On the δαίμωνιον of Socrates," in the *Journal of Philology*, v.; and cf. Chr. Meiners, *Vermischte philosophische Schriften* (Leipzig, 1776)—"in moments of 'Schwärmerei' Socrates took for the voice of an attendant genius what was in reality an instantaneous presentiment in regard to the issue of a contemplated act." For a fuller statement of the writer's view of Plato's relations to Socrates, see a paper on Plato's *Republic*, vi. 509 D seq., in the *Journal of Philology*, vol. x., and a series of papers on "Plato's Later Theory of Ideas," in vols. x., xi., xiii., xiv., xv., xxv. of the same periodical.

See also SOPHISTS and ETHICS.

(H. JA.)

SOCRATES, the name of a famous 5th-century church historian. In the course of the last twenty-five years (425-450) of the reign of Theodosius II. (the first thoroughly Byzantine emperor) at least six church histories were written in Greek within the limits of the Eastern Empire—those, namely, of Philostorgius the Arian, of Philip of Side, of Socrates, of Sozomen, of Theodoret and of Hesychius. Of these the first, no longer extant except in fragments, seems to have been the most important. Those of Philip and of Hesychius (the former an untrustworthy and dreary performance mentioned by Socrates [vii. 26, 27]) have also perished. The remaining three are now our main sources for church history from Constantine to Theodosius II. None of them has ventured upon a fresh treatment of the period dealt with by Eusebius; all three begin their narratives about the point where his closes. In the West the *Church History* of that author had already been continued by Rufinus and his *Chronicle* by Jerome, and the work of Rufinus was certainly known to the Byzantines. Nor did these write independently of each other, for Sozomen (*q.v.*) certainly had before him the work of Socrates, and Theodoret (*q.v.*) knew both of them. The three histories together became known in the West from the 6th century through the selection which Cassiodorus caused to be made from them, and it is to this selection (if we leave Rufinus and Jerome out of account) that the middle ages were mainly indebted for all they knew of the Arian controversies, and of the period generally between the Councils of Nice and Ephesus.

The *Ἐκκλησιαστικὴ ἱστορία* of Socrates, still extant in seven books, embracing the period from 306 to 439, was written in 439, or within a few years thereafter. He was born and brought up at Constantinople. The date of his birth is uncertain, but it cannot have been far from 380. Of the facts of his life we know practically nothing, except that he was not a cleric but a "scholasticus" or advocate. Of the occasion, plan and object of his work he has himself informed us in the prologues to his first, second, fifth and sixth books. It is dedicated to one Theodorus, who had urged him to write such a history. He had no thorough preparation for the task, and for the period down to the death of Constantius (361) was practically dependent on Rufinus. After his work was finished he became a student of Athanasius' writings and came to see how untrustworthy his guide had been. He accordingly rewrote his first two books (see *H. E.* ii. 1) certainly before 450 and probably before 444 (see Geppert p. 8), and it is only this revision that has reached us. The chief sources from which he drew were: (1) the *Church History*, the *Life of Constantine* and certain theological works of Eusebius; (2) the *Church History* of Rufinus; (3) certain works of Athanasius; (4) the no longer extant *Συναγωγή τῶν συνοδικῶν* of the Macedonian and semi-Arian Sabinus—a collection of acts of councils with commentaries, brought down to the reign of Theodosius I. (this was a main source); (5) the *Constantinopolitan Chronicle*; (6) possibly a collection of imperial biographies; (7) lists of bishops; (8) collections of letters by members of the Arian and orthodox parties. He also used writings of Gregory Thaumaturgus, Archelaus, Acacius, Didymus, George of Laodicea, Gregory Nazianzen, Timothy of Berytus (see Lietzmann, *Apollinaris von Laodicea*, p. 44), Nestorius, Eusebius Scholasticus, Philip of Side, Evagrius, Palladius, Eutropius, the emperor Julian and orations of Libanius and Themistius; and he was apparently acquainted with some of the works of Origen and with

Pamphilus' *Apologia pro Origene*. (On his sources see Jeep, and especially Geppert.) Jeep alleges (pp. 149 sqq.), but without adequate proof, that he made use of Philostorgius. As regards profane history his materials were exceedingly defective. Thus, for example, he confesses that his reason for not giving an account of the wars of Constantine is his inability to ascertain anything certain about them (*v. praef.*). His reckonings by Olympiads are generally wrong, the error arising chiefly from carelessness. He is greatly indebted to oral tradition and to the testimony of eye-witnesses, especially of members of the Novatian community in Constantinople; some things also he has set down from personal knowledge. The contents of the closing books are for the most part derived from oral tradition, from the narratives of friends and countrymen, from what was still generally known and current in the capital about past events, and from the ephemeral literature of the day.

The theological position of Socrates, so far as he can be said to have had one, is at once disclosed in his unlimited admiration for Origen. All the enemies of the great Alexandrian he regards merely as empty and vain obscurantists; for the orthodoxy of his hero he appeals to Athanasius. Closely connected with his high regard for Origen are his appreciation of science generally and the moderation of his judgment on all dogmatic questions. According to him, *Ἑλληνικὴ παιδεία* is quite indispensable within the Church; many Greek philosophers were not far from the knowledge of God, as is proved by their triumphant arguments against atheists and gainsayers of divine providence. The apostles did not set themselves against the study of Greek literature and science; Paul had even made a thorough study of them himself. The Scriptures, it is true, contain all that appertains to faith and life, but give no clue to the art of confuting gainsayers. Greek science, therefore, must not be banished from the Church, and the tendency within the Church so to deal with it is wrong. This point of view was the common one of the majority of educated Christians at that period, and is not to be regarded as exceptionally liberal. The same holds true of the position of Socrates in regard to dogmatic questions. On the one hand, indeed, orthodoxy and heresy are symbolized to his mind by the wheat and the tares respectively; he clings to the naive opinion of Catholicism, that contemporary orthodoxy has prevailed within the Church from the first; he recognizes the true faith only in the mystery of the Trinity; he judges heretics who have been already condemned as interlopers, as impudent innovators, actuated by bad and self-seeking motives; he apologizes for having so much as treated of Arianism at all in his history of the Church; he believes in the inspiration of the ecclesiastical councils as much as in that of the Scriptures themselves. But, on the other hand, he takes absolutely no interest in dogmatic subtleties and clerical disputes; he regards them as the source of great evils, and expresses his craving for peace: "one ought to adore the ineffable mystery in silence." This attitude, which was that of most educated Byzantine laymen, has in particular cases made it possible for him to arrive at very free judgments. Even granting that some feeble remains of antique reserve may have contributed to this, and even although some of it is certainly to be set down to his disposition and temperament, still it was his religious passivity that here determined the character of Socrates and made him a typical example of the later Byzantine Christianity. If Socrates had lived about the year 325, he certainly would not have ranked himself on the side of Athanasius, but would have joined the party of mediation. But—the *δομοσίως* has been laid down, and must be recognized as correctly expressing the mystery; only one ought to rest satisfied with that word and with the repudiation of Arianism. Anything more, every new distinction, is mischievous. The controversy in its details is a *νυκρομαχία* to him, full of misunderstandings. Sometimes he gives prominence, and correctly, to the fact that the disputants partially failed to understand one another, because they had separate interests at heart—those on the one side desiring above everything to guard against polytheism, those on the other being most afraid of Sabellianism. He did not fail, however, to recognize also that the controversies frequently had their root in mere emulation, slander and sophistry. Not unfrequently he passes very sharp judgments on whole groups of bishops. In the preface to his fifth book he excuses his trenching on the region of political history on the ground of his desire to spare his readers the disgust which perusal of the endless disputes of the bishops could not fail to excite, and in that to his sixth book he prides himself on never having flattered even the orthodox bishops. This attitude of his has given him a certain measure of impartiality. Constantius, and even Julian—not Valens, it is true—are estimated very fairly. The Arian Goths who died for their religion are recognized as genuine martyrs. His characterizations of Cyril and Nestorius, and his narrative and criticism of the beginnings of the Christological controversy, are models of candour and historical conscientiousness. In frequent instances, moreover, he acknowledges his own incompetency to give an opinion

and hands the question over to the clergy. For the clergy as a whole, in spite of his criticism of individuals, he has the very highest respect, as also for the monks, without himself making any inordinate religious professions. In a special excursus of considerable length he has paid a tribute of the highest order to monachism, and in his characterization of Theodosius II. also (where he has made use of the brightest colours) he does not fail to point out that in piety the emperor could almost compete with the monks. But, apart from these two chapters (iv. 23, vii. 22), it is but seldom that one could learn from the pages of Socrates that there was such a thing as monasticism in those days. To his mind the convent is not far removed from the church, and as a layman he is not at all inclined to accept the principles of monachism as applying to himself or to square his views of history in accordance with them. He has even gone so far as formally to express his sympathy with Paphnutius, the champion of the right of bishops to marry.

As a source for the period within which he wrote, the work of Socrates is of the greatest value, but as "history" it disappoints even the most modest expectations. Eusebius, after all, had some conception of what is meant by "church history," but Socrates has none. "As long as there is peace there is no material for a history of the church"; but, on the other hand, neither do heresies by rights come into the story. What, then, is left for it? A collection of anecdotes and a series of episodes. In point of fact this is the view actually taken by Socrates. His utter want of care and consistency appears most clearly in his vacillation as to the relations between ecclesiastical and political history. At one time he brings in politics, at another he excuses himself from doing so. He has not failed to observe that Church and State act and react upon each other; but he has no notion how the relation ought to be conceived. Nevertheless, his whole narrative follows the thread of political—that is to say, of imperial—history. This indeed is characteristic of his Byzantine Christian point of view; church history becomes metamorphosed into a history of the emperors and of the state, because a special church history is at bottom impossible. But even so one hardly hears anything about state or court except great enterprises and anecdotes. Political insight is wholly wanting to Socrates; all the orthodox emperors blaze forth in a uniform light of dazzling splendour; even the miserable Arcadius is praised, and Theodosius II. figures as a saint whose exemplary piety turned the capital into a church. If in addition to all this we bear in mind that in his later books the historian's horizon is confined to the city and patriarchate of Constantinople, that he was exceedingly ill informed on all that related to Rome and the West, that in order to fill out his pages he has introduced narratives of the most unimportant description, that in not a few instances he has evinced his credulity (although when compared with the majority of his contemporaries he is still entitled to be called critical), it becomes sufficiently clear that his *History*, viewed as a whole and as a literary production, can at best take only a secondary place. One great excellence, however, cannot be denied him, his honest and sincere desire to be impartial. He tried also, as far as he could, to distinguish between the certain, the probable, the doubtful and the untrue. He made no pretence to be a searcher of hearts and frequently declines to analyse motives. He has made frank confession of his nescience, and in certain passages his critical judgment and sober sense and circumspection are quite striking. He writes a plain and unadorned style and shuns superfluous words. Occasionally even there are touches of humour and of trenchant satire—always the sign of an honest writer. In short, his learning and knowledge can be trusted little, but his goodwill and straightforwardness a great deal. Considering the circumstances under which he wrote, it can only be matter for congratulation that such a man should have become our informant and that his work has been preserved to us.

Finally, it looks as if Socrates was either himself originally a Novatianist who had afterwards joined the Catholic Church, or stood, through his ancestors or by education, in most intimate relations with the Novatianist Church. In his *History* he betrays great sympathy with that body, has gone with exactness into its history in Constantinople and Phrygia, and is indebted for much of the material of his work to Novatianist tradition and to his intercourse with prominent members of the sect. Both directly and indirectly he has declared that Novatianists and Catholics are brothers, that as such they ought to seek the closest relations with one another, and that the former ought to enjoy all the privileges of the latter. His efforts, however, had only this result, that he himself afterwards fell under suspicion of Novatianism.

EDITIONS AND LITERATURE.—Socrates' *History* has been edited by Stephanus (Paris, 1544; Geneva, 1612), Valesius (Paris, 1659 sqq.), Reading (Cambridge, 1720), Hussey (Oxford, 1853, reissued by Bright, 1878). It is also to be found in volume lxvii. of Migne's *Patrologia*, and there is an Oxford school edition (1844) after Reading. The latest English translation, revised by Zenos, is published in the Nicene and post Nicene Fathers, 2nd series, vol. ii. There are *Testimonia veterum* in Valesius and more fully in Hussey; and Nolte's paper in *Tübing. Quartalschr.* (1859, p. 518 seq.), contains emendations in Hussey's text, and notes towards the history of the text and editions; see also Overbeck, in *Theol. lit. Ztg.* (1879), no. 20.

Special studies have been made by Baronius, Miraeus, Labbé,

Valesius, Halloix, Scaliger, Ceillier, Cave, Dupin, Pagé, Ittig, Tillemont, Walch, Gibbon, Schroeckh, Lardner. See also Voss, *De histor. graecis*; Fabricius-Harless, *Biblioth. gr.*, vol. vii.; Rössler, *Bibliothek d. Kirchenväter*; Holzhausen, *De fontibus quibus Socr., Socz., ac Theod. in scribenda historia sacra usi sunt* (Göttingen, 1825); Stäudlin, *Gesch. u. Lit. d. K.-G.* (Hanover, 1827); Baur, *Epochen* (1852); Harnack, "Socrates u. Sozomen" in Herzog-Hauck's *Realencykl.*, 2nd ed.; Loeschke, "Sokrates," *ibid.*, 3rd. ed. Detached details are given also in works upon Constantine (Manso), Julian (Mücke, Rode, Neumann, Rendall), Damasus (Rade), Arianism (Gwatkin's *Studies of Arianism*, which gives a severe but trust-worthy criticism of Rufinus and discusses the manner in which Socrates was related to him), the emperors after Julian (De Broglie, Richter, Clinton, the *Weltgeschichte* of Ranke, the *Gesch. d. oströmischen Reiches unter den Kaisern Arcadius u. Theod. II.* (1885) of Gildenpenning, and the *Kaiser Theodosius d. Gr.*, Halle (1878) of Gildenpenning and Iffland, the last-named work discussing the relation of Socrates to Sozomen), the barbarian migrations (Wietersheim, Dahn), the Goths (Waitz, Bessel, Kauffmann and Scott's *Ulfilas*, 1885). Lastly, reference may be made to Sarrazin, *De Theodoro Lectore, Theophanis fonte praecipuo* (1881, treats of the relation between Socrates and Sozomen, and of the completeness of the former's work); Jeep, *Quellenuntersuch. z. d. griech. Kirchenhistorikern* (1884); Geppert, *Die Quellen des Kirchenhistorikers Socrates Scholasticus* (1898). (A. HA.; A. C. McG.)

SODALITE, a group of rock-forming minerals comprising the following isomorphous species:—

Sodalite	. . .	Na ₄ (AlCl)Al ₂ (SiO ₄) ₃
Häüynite	. . .	(Na ₂ , Ca) ₂ (NaSO ₄ Al)Al ₂ (SiO ₄) ₃
Noselite	. . .	Na ₄ (NaSO ₄ Al)Al ₂ (SiO ₄) ₃
Lazurite	. . .	Na ₄ (NaS ₃ Al)Al ₂ (SiO ₄) ₃

They are thus sodium (or calcium) aluminium silicates, with chloride, sulphate or sulphide. In their orthosilicate formulae, as above written, and in their cubic crystalline form they present a certain resemblance to the members of the garnet group. Crystals usually have the form of the rhombic dodecahedron, and are often twinned with interpenetration on an octahedral plane. They are white, or often blue in colour, and have a vitreous lustre. The hardness is 5½, and the specific gravity 2.2-2.4. These minerals are characteristic constituents of igneous rocks rich in soda, and they also occur in metamorphic limestones.

The species sodalite (so named because it contains soda) occurs as well-formed, colourless crystals in the ejected limestone blocks of Monte Somma, Vesuvius, and in the sodalite-syenite of Julianehaab in south Greenland. Massive blue material is common in the elaeolite-syenites of southern Norway, Gyergyó-Ditró in Transylvania, Miyask in the Urals, Litchfield in Maine, Dungannon in Ontario, Ice river in Kootenay county, British Columbia, &c.; at the three last-named localities it is found as large masses of a bright sky-blue colour and suitable for cutting as an ornamental stone. Recently, large masses with a pink colour, which quickly fades on exposure to light, have been met with in elaeolite-pegmatite at Kishangarh in Rajputana. Häüynite, or häüyne (named after R. J. Häüy), occurs as bright blue crystals and grains in the lavas (phonolite, tephrite, &c.) of Vesuvius, Rome, the Eifel, &c. Noselite, or nosean, is found as greyish crystals in the sanidine bombs of the Eifel. Lazurite is an important constituent, together with some häüynite and sodalite, of lapis-lazuli (*q.v.*). (L. J. S.)

SODEN, a town and spa of Germany, in the Prussian province of Hesse-Nassau, pleasantly situated in the valley of the Sulzbach under the southern slope of the Taunus range, 10 m. from Frankfort-on-Main and 4 m. N. from Höchst by rail. Pop. (1905), 1917. The chief interest of the place centres in its brine springs which are largely impregnated with carbonic acid gas and oxide of iron, and are efficacious in chronic catarrh of the respiratory organs, in liver and stomach disorders and women's diseases. The waters are used both internally and externally, and are largely exported. Soden lozenges (*Sodener Pastillen*), condensed from the waters, are also in great repute. Soden has a large and well-appointed Kurhaus, an Evangelical and a Roman Catholic church, and a hospital for indigent patients.

See Haupt, *Soden am Taunus* (Würzburg, 1902); and Köhler, *Der Kurort Soden am Taunus und seine Umgebungen* (Frankfort, 1873).

SODEN, HERMANN, FREIHERR VON (1852—), German biblical scholar, was born in Cincinnati on the 16th of August 1852, and was educated at the university of Tübingen. He was minister of Dresden-Striesen in 1881 and in 1887 became minister of the Jerusalem Church in Berlin. In 1889 he became *privatdozent* in the university of Berlin, and four years later was

appointed extraordinary professor of divinity. His earlier works include *Philippbrief* (1890); "Untersuchungen über neuest. Schriften" in the *Protest. Jahrb. theolog. Studien und Schriftkommentar* (1895-1897); *Und was tut d. evangel. Kirche?* (3rd. ed. 1890); *Reisebriefe aus Palästina* (2nd ed. 1901); *Palästina und seine Gesch.* (2nd ed. 1904); *Die wichtigsten Fragen im Leben Jesu* (1904); *Urchristliche Literaturgesch.* (1904). His most important book is *Die Schriften des neuen Testaments, in ihrer ältesten erreichbaren Textgestalt hergestellt auf Grund ihrer Textgeschichte* (Berlin, Bd. I., 1902-1910); certainly the most important work on the text of the New Testament which had been published since Westcott and Hort's *New Testament in the Original Greek* (see BIBLE: *New Testament*).

Von Soden introduces, besides a new notation of MSS. (see Bible, N.T. MSS. and versions), a new theory of textual history. He thinks that in the 4th century there were in existence three recensions of the text, which he distinguishes as *K*, *H* and *I*, with the following characteristics and attestations.

K corresponds roughly to Westcott and Hort's Syrian Antiochian text; it was probably made by Lucian in the 4th century. This was in the end the most popular form of text, and is found in a more or less degenerate state in all late MSS. The purest representatives are $\delta 1$ (Ω), $\epsilon 75$ (V), 92, (461), 94, 1027 (S), 1126 (476 = scrivener's *k*) $\epsilon 179$ (661). Later recensions of *K* are called *K*² and *K*³, and there are also others of less importance which represent the combination of *K* with other texts.

H represents Westcott and Hort's Neutral and Alexandrian texts between which von Soden does not distinguish.

It is found in eleven MSS. in varying degrees of purity: $\delta 1$ (B), $\delta 2$ (κ), $\delta 3$ (C), $\delta 6$ (Ψ), $\delta 48$ (33), $\epsilon 26$ (Z), $\epsilon 56$ (L), $\epsilon 76$ (Δ) $\epsilon 1026$ (892), $\delta 371$ (1241) and $\epsilon 376$ (579). Between these MSS. there is no very intimate connexion except between $\delta 1$ and $\delta 2$ (B and κ) which represent a common original (δ^{1-2}). δ^{1-2} is the best representative of *H*, but it has been contaminated by the Egyptian versions, and sometimes by the *K* and *I* texts and by Origen, though not to any great extent.

The other *H* MSS. are none of them equal in value to the two great uncial. They have all been influenced by *K*, *I*, and by the text of parallel passages, to a greater extent than δ^{1-2} , or than either of the two witnesses to δ^{1-2} , but some of them have less Egyptian corruption.

The origin of the *H* text must be regarded as unquestionably Egyptian, in view of the fact that it was used by all the Egyptian Church writers after the end of the 3rd century, and von Soden adopts the well-known hypothesis, first made popular by Bousset, that it represents the recension of Hesychius.

I does not quite correspond to anything in Westcott and Hort's system, but has points of contact with their "Western" text. It is found in a series of subgroups of MSS. known as *H*^r, *J*, *I*^a, and others of less importance (about eleven subgroups are suggested). Of these *H*^r is a family containing Cod. *I* and its allies ($\delta 254$, $\epsilon 346$, $\delta 457$, $\delta 467$, &c.), $\epsilon 288$ (22) and some allied MSS. $\epsilon 203$ (872), $\epsilon 183$ and $\epsilon 1131$; *J* is the well-known Ferrar group; and *I*^a contains $\delta 5$ (D), $\epsilon 93$ (565), $\epsilon 133$ (700), $\epsilon 168$ (28), $\epsilon 050$ and some others. It is necessary to note that von Soden is able to place D in this group because he regards it as owing many of its most remarkable readings to contamination with the Latin version. *I* is, according to von Soden, a Palestinian recension connected with Eusebius, Pamphilus and Origen.

After establishing the text of *I*, *H* and *K*, von Soden reconstructs an hypothetical text, *I-H-K*, which he believes to have been their ancestor. He then tries to show that this text was known to all the writers of the 3rd and 2nd centuries, but has naturally to account for the fact that the quotations of these writers and the text of the early versions often diverge from it. The explanation that he offers is that the Diatessaron of Tatian was widely used and corrupted all extant texts, so that the Old Syriac, the Old Latin, the quotations of Irenaeus, Clement, Tertullian and others may be regarded as various combinations of the Tatianic text and *I-H-K*. Finally, he tries to show that the Tatianic text is itself in the main merely a corrupt form of *I-H-K* altered in order to suit the necessities of Tatian's plan.

For criticism of this important theory up to 1909 see Nestle's *Einführung in das griechische neue Testament*, pp. 274-278 (3rd ed., Göttingen, 1909), and K. Lake's *Professor H. von Soden's Treatment of the Text of the Gospels*, Edinburgh, 1908. (K. L.)

SÖDERHAMN, a seaport of Sweden, in the district (*län*) of Gefleborg, on an inlet of the Gulf of Bothnia, near the mouth of the Ljasne River, 183 m. N. by W. of Stockholm by rail. Pop. (1900), 11,258. This is one of the principal centres of the timber export trade, having saw-mills, planing-mills and wood-pulp works. There are also ironworks and breweries. Vessels drawing 15 ft. have access to Branthäll, where they generally load. The harbour is at the suburb of Stugsund. It is usually

ice-bound for some four months in winter. The town was given municipal privileges by Gustavus Adolphus in 1620, but is modern in appearance, having been rebuilt after fires in 1860 and 1865.

SODERINI, PIERO (1450-1513), Florentine statesman, was elected gonfalonier for life in 1502 by the Florentines, who wished to give greater stability to their republican institutions, which had been restored after the expulsion of Piero de' Medici and the martyrdom of Savonarola. His rule proved moderate and wise, although he had not the qualities of a great statesman. He introduced a system of national militia in the place of foreign mercenaries, and during his government the long war with Pisa was brought to a close with the capture of that city by the Florentines in 1509. Grateful to France, who had assisted him, he always took the French side in Italian politics. But in 1512 the Medici with the help of a Spanish army returned to Florence, deposed Soderini and drove him into exile. He took refuge at Ragusa in Dalmatia, where he remained until the election of Pope Leo X., who summoned him to Rome and conferred many favours on him. Soderini lived in Rome, working for the good of Florence, to which he was never allowed to return, until his death.

See Razzi, *Vita di Pier Soderini* (Padua, 1737), also the articles FLORENCE and MEDICI.

SÖDERTELGE, a town of Sweden, in the district (*län*) of Stockholm, 23 m. W.S.W. of Stockholm by rail. Pop. (1900), 8,207. It is beautifully situated on a bay of Lake Mälär, which is here connected with the Baltic by the Södertelge canal, $1\frac{1}{4}$ m. in length, with a minimum depth of 10 ft. This is on the route followed by the Göta Canal steamers between Stockholm and Gothenburg: it was opened in 1819, though a canal was begun here in the first half of the 15th century at the instigation of the patriot Engelbrecht. The town contains an ancient church, believed to date from c. 1100. Here and in the neighbourhood are the residences of many of the business class of Stockholm; and the town is in favour as a summer resort, having mineral springs and baths. There are engineering shops producing railway stock and motors, jute spinning and weaving mills, and match and joinery works.

SODIUM [symbol Na, from Lat. *natrium*; atomic weight 23.00 (O=16)], a chemical element belonging to the group of alkali metals. It is abundantly and widely diffused in nature, but always in combination. Sodium chloride, or common salt (*q.v.*), is exceedingly common, being the chief salt present in sea-water, besides occurring in extensive stratified deposits. Sodium carbonates are also widely dispersed in nature, forming constituents of many mineral waters, and occurring as principal saline components in natron or trona lakes, as efflorescences in Lower Egypt, Persia and China, and as urao in Mexico, Colombia and Venezuela. The solid crusts found at the bottom of the salt lakes of the Araxes plain in Armenia contain about 16% of carbonate and 80 of sulphate. In Colombia there occurs a double salt, $\text{Na}_2\text{CO}_3 \cdot \text{CaCO}_3 \cdot 5\text{H}_2\text{O}$, known as gay-lussite. In Wyoming, California and Nevada enormous deposits of carbonates, mixed in some cases with sulphate and with chloride, occur. About Szegedin in Hungary and all over the vast puszta (steppes) between the Theiss and the Danube, and from the Theiss up to and beyond Debreczin, the soil contains sodium carbonate, which frequently assumes the form of crude alkaline crusts, called "szekso," and of small saline ponds. A purified specimen of such Debreczin soda was found to contain as much as 90% of real carbonate, NaCO_3 , and 4 of common salt. Natural sulphate occurs in an anhydrous condition as thenardite, Na_2SO_4 , at Tarapaca, Chile, and in the rock-salt deposits at Espartinas near Aranjuez, Spain. Hydrated sulphates occur at several localities in the province of Madrid and in other provinces of Spain, and at Mühligen in Aargau, and copious deposits of glauberite, the double sulphate of sodium and calcium, are met with in the salt-mines of Villarrubia in Spain, at Stassfurt, and in the province of Tarapaca, Chile, &c. A native nitrate of soda is obtained in great abundance in the district of Atacama and the province of Tarapaca,

and is imported into Europe in enormous quantities as cubic nitre for the preparation of saltpetre. Cryolite, a fluoride of aluminium and sodium, is extensively mined in Greenland and elsewhere for industrial purposes. These form the principal natural sources of sodium compounds—the chloride as rock salt and in sea-water being of such predominating importance as quite to outweigh all the others. But it is questionable whether, taken altogether, the mass of sodium they represent is as much as that disseminated throughout the rocky crust in the form of soda felspar (*i.e.* as silicate of soda) and in other soda-containing rocks. From this source all soils contain small proportions of sodium in soluble forms, hence the ashes of plants, although they preferably imbibe potassium salts, contain traces and sometimes notable quantities of sodium salts. Sodium salts also form essential ingredients in all animal juices.

Although many sodium compounds have been known from very remote times, the element was not isolated until 1807, when Sir H. Davy obtained it by electrolysis of caustic soda. This method was followed by that proposed by Gay-Lussac and Thénard, who decomposed molten caustic soda with red-hot iron; and this in turn was succeeded by Brunner's process of igniting sodium carbonate with charcoal. Deville made many improvements, but the method remained wasteful and uneconomical, and in 1872 the metal cost 4s. a pound. In 1886, however, Castner replaced the carbonate by caustic soda, and materially cheapened the cost of production; but this method was discarded for an electrolytic one, patented by Castner in 1890. Electrolytic processes had, in fact, been considered since 1851, when Charles Watt patented his method for the production of sodium and potassium from fused chlorides. Among the difficulties here to be contended with are the destructive action of fused chlorides and of the reduced alkali metals upon most non-metallic substances available for the containing vessel and its partition, and also of the anode chlorine upon metals; also the low fusing-point (95° C. for sodium, and 62° C. for potassium) and the low specific gravity of the metals, so that the separated metal floats as a fused layer upon the top of the melted salt. Again, pure sodium chloride melts at about 775° C., while sodium boils at 877° C., so that the margin of safety is but small if loss by vaporization is to be prevented. Borchers endeavoured to contend against the first difficulty by employing an iron cathode vessel and a chamotte (fire-clay) anode chamber united by a specially constructed water-cooled joint. The other difficulty is to some extent met by using mixed chlorides (*e.g.* sodium, potassium and strontium chlorides for sodium extraction), as these melt at a lower temperature than the pure chloride. In Castner's process (as employed at Oldbury and Niagara Falls and in Germany) fused caustic soda is electrolysed. The apparatus described in the patent specification is an iron cylinder heated by gas rings below, with a narrower cylinder beneath, through which passes upwards a stout iron cathode rod cemented in place by caustic soda solidified in the narrower vessel. Iron anodes are suspended around the cathode, and between the two is a cylinder of iron gauze at the bottom with a sheet-iron continuation above, the latter being provided with a movable cover. During electrolysis, oxygen is evolved at the anode and escapes from the outer vessel, while the sodium deposited in globules on the cathode floats upwards into the iron cylinder, within which it accumulates, and from which it may be removed at intervals by means of a perforated iron ladle, the fused salt, but not the metal, being able to pass freely through the perforations. The sodium is then cast into moulds. Sodium hydroxide has certain advantages compared with chloride, although it is more costly; its fusing-point is only 320° C., and no anode chlorine is produced, so that both containing vessel and anode may be of iron, and no porous partition is necessary.

Metallic sodium possesses a silvery lustre, but on exposure to moist air the surface is rapidly dulled by a layer of the hydroxide. It may be obtained crystallized in the quadratic system by melting in a sealed tube containing hydrogen, allowed to cool partially, and then pouring off the still liquid portion by inverting the tube. The specific gravity is 0.9735 at 13.5°

(Baumhauer). At ordinary temperatures the metal has the consistency of wax and can be readily cut; on cooling it hardens. On heating it melts at 95.6° (Bunsen) to a liquid resembling mercury, and boils at 877.5° (Ruff and Johannsen, *Ber.*, 1905, 38, p. 3601), yielding a vapour, colourless in thin layers but a peculiar purple, with a greenish fluorescence, when viewed through thick layers. (For the optics of sodium vapour see R. W. Wood, *Physical Optics*.) According to A. Matthiessen, sodium ranks fourth to silver, copper and gold as a conductor of electricity and heat, and according to Bunsen it is the most electropositive metal with the exception of caesium, rubidium and potassium.

The metal is very reactive chemically. Exposed to moist air it rapidly oxidizes to the hydroxide; and it burns on heating in air with a yellow flame, yielding the monoxide and dioxide. A fragment thrown on the surface of water rapidly disengages hydrogen, which gas, however, does not inflame, as happens with potassium; but inflammation occurs if hot water be used, or if the metal be dropped on moist filter paper. Sodium also combines directly, sometimes very energetically, with most non-metallic elements. It also combines with dry ammonia at $300-400^{\circ}$ to form sodamide, NaNH_2 , a white waxy mass when pure, which melts at 155° . Heated in a current of carbon dioxide sodamide yields caustic soda and cyanamide, and with nitrous oxide it gives sodium azoimide; it deflagrates with lead or silver nitrate and explodes with potassium chlorate. Sodamide was introduced by Claisen (*Ber.*, 1905, 38, p. 693) as a condensing agent in organic chemistry, and has since been applied in many directions. Sodium is largely employed in the manufacture of cyanides and in reduction processes leading to the isolation of such elements as magnesium, silicon, boron, aluminium (formerly), &c.; it also finds application in organic chemistry. With potassium it forms a liquid alloy resembling mercury, which has been employed in high temperature thermometers (see THERMOMETRY).

Compounds.

In its chemical combinations sodium is usually monovalent; its salts are generally soluble in water, the least soluble being the metantimonate.

Sodium hydride, NaH , is a crystalline substance obtained directly from sodium and hydrogen at about 400° . It burns when heated in dry air, and ignites in moist air; it is decomposed by water, giving caustic soda and hydrogen. Dry carbon dioxide is decomposed by it, free carbon being produced; moist carbon dioxide, on the other hand, gives sodium formate.

Several oxides are known. A suboxide, Na_2O , appears to be formed as a grey mass when a clean surface of the metal is exposed to air, or when pure air is passed through the metal just above its melting point (De Forcrand, *Compt. rend.*, 1898, 127, pp. 364, 514). The monoxide, Na_2O , is obtained by heating the metal above 180° in a limited amount of slightly moist oxygen (Holt and Sims, *Journ. Chem. Soc.*, 1894, i. 442); it may also be prepared by heating the nitrate or nitrite with metallic sodium, free nitrogen being eliminated (German patent, 142467, 1902). It forms a grey mass, which melts at a red heat and violently combines with water to give the hydroxide. The hydroxide or caustic soda, NaOH , is usually manufactured from the carbonate or by electrolysis of salt solution (see ALKALI MANUFACTURE). When anhydrous it is a colourless opaque solid which melts at 310° , and decomposes at about 1100° . It is very soluble in water, yielding a strongly alkaline solution; it also dissolves in alcohol. It absorbs moisture and carbon dioxide from the atmosphere. Several hydrates are known: $2\text{NaOH}\cdot 7\text{H}_2\text{O}$ is obtained as large monoclinic crystals by cooling a solution of specific gravity 1.365 to -8° ; Pickering (*Journ. Chem. Soc.*, 1893, 65, p. 890) obtained $\text{NaOH}\cdot \text{H}_2\text{O}$ from hot concentrated solutions and $\text{NaOH}\cdot 2\text{H}_2\text{O}$ from a solution of the hydroxide in 96.8% alcohol. (See also De Forcrand, *Compt. rend.*, 1901, 133, p. 223.)

Sodium dioxide, Na_2O_2 , is formed when the metal is heated in an excess of air or oxygen. In practice the metal is placed on aluminium trays traversing an iron tube heated to 300° , through which a current of air, freed from moisture and carbon dioxide, is passed; the process is made continuous, and the product contains about 93% Na_2O_2 . When pure, sodium dioxide has a faint yellowish tinge, but on exposure it whitens (W. R. Bousfield and T. M. Lowry, *Phil. Trans.*, 1905, A. 204, p. 253). When dissolved in water it yields some NaOH and H_2O_2 ; on crystallizing a cold solution $\text{Na}_2\text{O}_2\cdot 8\text{H}_2\text{O}$ separates as large tabular hexagonal crystals, which on drying over sulphuric acid give $\text{Na}_2\text{O}_2\cdot 2\text{H}_2\text{O}$; the former is also obtained by precipitating a mixture of caustic soda and hydrogen peroxide solutions with alcohol. Acids yield a sodium salt and free oxygen or hydrogen peroxide; with carbon dioxide it gives sodium carbonate

and free oxygen; carbon monoxide gives the carbonate; whilst nitrous and nitric oxides give the nitrate. A solution in hydrochloric acid, consisting of the chloride and hydrogen peroxide, is used for bleaching straw under the name of soda-bleach; with calcium or magnesium chlorides this solution gives a solid product which, when dissolved in water, is used for the same purpose (Castner, *Journ. Soc. Chem. Ind.*, 1893, p. 603). Sodium dioxide is chiefly employed as an oxidizing agent, being used in mineral analysis and in various organic preparations; it readily burns paper, wood, &c., but does not evolve oxygen unless heated to a high temperature. Sodyl hydroxide, NaHO_2 , exists in two forms: one, $\text{Na}\cdot\text{O}\cdot\text{OH}$, obtained from hydrogen peroxide and sodium ethylate; the other, $\text{O}\cdot\text{Na}\cdot\text{OH}$, from absolute alcohol and sodium peroxide at 0° . They are strong oxidizing agents and yield alkaline solutions which readily evolve oxygen on heating. Sodium trioxide, Na_2O_3 , is said to be formed from an excess of oxygen and a solution of sodammonium in liquid ammonia. Water decomposes it, giving oxygen and the dioxide.

Generally speaking, sodium salts closely resemble the corresponding potassium salts, and their methods of preparation are usually the same. For sodium salts not mentioned below reference should be made to articles wherein the *acid* is treated, unless otherwise indicated.

Sodium combines directly with the halogens to form salts which are soluble in water and crystallize in the cubic system. The fluoride, NaF , is sparingly soluble in water (1 part in 25). For the chloride see SALT. The bromide and iodide crystallize from hot solutions in anhydrous cubes; from solutions at ordinary temperatures in monoclinic prisms with $2\text{H}_2\text{O}$; and at low temperatures with $5\text{H}_2\text{O}$. According to M. Loeb (*Journ. Amer. Chem. Soc.*, 1905, 27, p. 1019) the iodide differs from the other haloid salts in separating from solution in alcohols with "alcohol of crystallization." Sodium sulphide, Na_2S , obtained by saturating a caustic soda solution with sulphuretted hydrogen and adding an equivalent of alkali, is employed in the manufacture of soluble soda glass. Sodium sulphite, Na_2SO_3 , which is employed as an antichlor, is prepared (with $7\text{H}_2\text{O}$) by saturating a solution of sodium carbonate with sulphur dioxide, adding another equivalent of carbonate and crystallizing. The anhydrous salt may be prepared by heating a saturated solution of the hydrated salt. H. Hartley and W. H. Barrett (*Journ. Chem. Soc.*, 1909, 95, p. 1184) failed to obtain a decahydrate which had been previously described. The acid sulphite, NaHSO_3 , obtained by saturating a cold solution of the carbonate with sulphur dioxide and precipitating by alcohol, is employed for sterilizing beer casks. Sodium sulphate, Na_2SO_4 , known in the hydrated condition (with $10\text{H}_2\text{O}$) as Glauber's salt, is manufactured in large quantities for conversion into the carbonate or soda (see ALKALI MANUFACTURE). It has long been doubted whether sodium yielded an alum; this was settled by N. I. Surgunoff in 1909 (*Abst. Journ. Chem. Soc.* ii. 1001), who obtained cubic crystals from a supersaturated solution of sodium and aluminium sulphates below 20° , higher temperatures giving monoclinic crystals. The acid sulphate, NaHSO_4 , also known as bisulphate of soda, is obtained as large asymmetric prisms by crystallizing a solution of equivalent quantities of the normal sulphate and sulphuric acid above 50° . The acid salts $\text{Na}_2\text{H}(\text{SO}_4)_2$ and $\text{Na}_3\text{H}(\text{SO}_4)_3$ are obtained from the normal sulphate and sulphuric acid (J. D'Ans, *Ber.*, 1906, 39, p. 1534).

The manufacture of sodium carbonate, commonly called soda, is treated under ALKALI MANUFACTURE. The anhydrous salt is a colourless powder or porous mass, having an alkaline taste and reaction. It melts at 1008° . On solution in water, heat is evolved and hydrates formed. Common washing soda or soda-crystals is the decahydrate, $\text{Na}_2\text{CO}_3\cdot 10\text{H}_2\text{O}$, which appears as large clear monoclinic crystals. On exposure, it loses water and gives the monohydrate, $\text{Na}_2\text{CO}_3\cdot\text{H}_2\text{O}$, a white powder sold as "crystal carbonate"; this substance, which is also formed on heating the decahydrate to 34° , crystallizes in the rhombic system. Both these hydrates occur in the mineral kingdom, the former as natron and the latter as thermonatrite. The heptahydrate, $\text{Na}_2\text{CO}_3\cdot 7\text{H}_2\text{O}$, is obtained by crystallizing a warm saturated solution in a vacuum; it appears to be dimorphous. The acid carbonate or bicarbonate of soda, NaHCO_3 , is produced in the ammonia-soda process for alkali manufacture. Another acid carbonate, $\text{Na}_2\text{CO}_3\cdot 2\text{NaHCO}_3\cdot 3\text{H}_2\text{O}$, is the mineral trona or urao. We may here notice the "percarbonates" obtained by Wolfenstein and Peltner (*Ber.*, 1908, 41, pp. 275, 280) on acting with gaseous or solid carbon dioxide on Na_2O_2 , Na_2O_3 and NaHO_2 at low temperatures; the same authors obtained a perborate by adding sodium metaborate solution to a 50% solution of sodium peroxide previously saturated with carbon dioxide. For sodium nitrite see NITROGEN; for sodium nitrate see SALTPETRE; for the cyanide see PRUSSIC ACID; and for the borate see BORAX.

Of the sodium silicates the most important is the mixture known as soluble soda glass formed by calcining a mixture of white sand, soda-ash and charcoal, or by dissolving silica in hot caustic soda under pressure. It is a colourless transparent glass mass, which dissolves in boiling water to form a thick liquid. It is employed in certain printing processes, as a cement for artificial stone and for mending glass, porcelain, &c., and also for making the so-called silicated soaps (see SOAP).

Sodium is most distinctly recognized by the yellow coloration which volatile salts impart to a Bunsen flame, or, better, by its emission spectrum which has a line (double), the Fraunhofer D, line, in the yellow (the wave-lengths are 5896 and 5890). The atomic weight was determined by Stas to be 22.87 ($\text{H}=1$); T. W. Richards and R. C. Wells (*Journ. Amer. Chem. Soc.*, 1905, 27, p. 459) obtained the value 23.006 ($\text{O}=16$).

Medicine.

Pharmacology.—The metal sodium is not used in medicine, but many of its salts are employed. Besides *liquor sodii ethylatis* the following salts and preparations are used in the British Pharmacopoeia. (1) *Sodii carbonis*, known as washing soda; this carbonate on heating yields *sodii carbonis exsiccatius* and *sodii bicarbonas*; from the latter is made *trochiscus sodii bicarbonatis*. (2) *Sodii phosphas*. From sodium phosphate are made *sodii phosphas effervescens* and *sodii hypophosphis* (see PHOSPHORUS). (3) *Sodii sulphas* (Glauber's salt), with its sub-preparation *sodii sulphas effervescens*. (4) *Soda tartarata* (Rochelle salt), a tartrate of sodium and potassium, from which is made *pulvis sodae tartaratae effervescens*, known as Seidlitz powder. (5) *Sodii citro-tartaras effervescens*, a mixture of sugar, sodium bicarbonate, citric and tartaric acids. (6) *Sodii chloridum*, common salt. (7) *Sodii sulphis*.

For *sodii bromidum*, *iodidum* and *salicylatum* see BROMINE, IODINE and SALICYLIC ACID respectively. For *sodii arsenas* and *cacodylate* see ARSENIC. *Sapo durus* (hard soap) is a compound of sodium with olive oil, and *sapo animalis* (curd soap) is chiefly sodium stearate.

Toxicology.—Poisoning by caustic soda is rare, but occasionally it takes place by swallowing soap lees (sodium carbonate), which may contain some impurities of caustic soda. The symptoms and treatment are the same as described under POTASSIUM. The salts of sodium resemble potassium in their action on the alimentary tract, but they are much more slowly absorbed, and much less diffusible; therefore considerable amounts may reach the small intestine and there act as saline purgatives. They are slowly absorbed into the blood, and are a natural constituent of the blood plasma, which derives them from the food. Sodium is excreted by all the mucous surfaces and by the liver and kidneys. On the latter they act as diuretics, but less powerfully than potassium, increasing the flow of water and the output of urea and rendering the urine less acid. They are said to diminish the secretion of the bronchial mucous membrane.

Therapeutics: External Use.—The liquor sodii ethylatis is a powerful caustic and is used to destroy small naevi and warts. A lotion of sodium bicarbonate is useful to allay itching. Solutions of sodium sulphite are used as mild antiparasitics. **Internal use.**—Sodium chloride is occasionally used in warm water as an emetic, and injections of it into the rectum as a treatment for thread worms. A 0.9% solution forms what is termed normal saline solution, which is frequently injected into the tissues in cases of collapse, haemorrhage and diarrhoea. It forms a valuable treatment in diabetic coma and eclampsia, acting by diluting the toxins in the blood. From this has developed the intramuscular injection of diluted sea-water in the treatment of gastro-enteritis, anaemia and various skin affections. Sodium chloride is an important constituent of the waters of Homburg, Wiesbaden, Nauheim and Kissingen. Sodium bicarbonate is one of our most useful gastric sedatives and antacids, relieving pain in hyperchloridia. It is the constituent of most stomachic mixtures. Effervescent soda water is a mild gastric sedative. Sodium phosphate and sulphate are cholagogue purgatives and are used in the treatment of gallstones. The sulphate is the chief constituent of Marienbad and Carlsbad waters. Large doses of these salts are used to remove fluid in dropsy. Soda tartarate is purgative and diuretic, as is the citro-tartarate. These purgative sodium salts are most useful in the treatment of chronic constipation, and of the constipation associated with gout and hepatic dyspepsia. They should be dissolved in warm water and taken in the morning, fasting. In visceral gout and chronic catarrhal conditions of the stomach a course of alkaline waters is distinctly beneficial. Sodium salts have not the depressant effect so marked in those of potassium.

SODOM AND GOMORRAH, in biblical geography, two of five cities (the others named Admah, Zeboiim and Bela or Zoar) which were together known as the "cities of the *Kikkar*" (circle), somewhere in the neighbourhood of the Dead Sea. They occupied a fertile region, chosen by Lot for his dwelling (Gen. xiii. 10-12). They were attacked by the four great Eastern kings and spoiled, but restored by the intervention of Abram and his men coming to the aid of Lot (Gen. xiv.). They were proverbial for wickedness, for which they were destroyed by a rain of "fire and brimstone" (Gen. xix.). The site of the cities, the historicity of the events narrated of them and the nature of the catastrophe that destroyed them, are matters of hot dispute. Modern names, more or less similar to the ancient appellations, have been noted in different parts of the Dead

Sea area; but no certain identification can be based on these similarities. The most striking coincidence is *Jebel Usdum*, by some equated with confidence to *Sodom*. The names are radically identical; but the hill is merely a salt-ridge 600 ft. high and 7 m. long, and cannot possibly represent an ancient city. The most that can be said is that the names have lingered in the Jordan valley in a vague tradition—very likely helped by, if not entirely due to, literary accounts of the catastrophe—just as has the name of Lot himself in the Arab name of the Dead Sea. The catastrophe has been explained as a volcanic eruption, or an explosive outburst of gas and oil stored and accumulating at high pressure. The latter, to which parallels in geologically similar regions in America are not unknown, is the most probable natural explanation that can be offered. (R. A. S. M.)

SODOMA, IL (1477-1549), the name given to the Italian painter Giovanni Antonio Bazzi (who until recent years was erroneously named Razzi). He is said to have borne also the name of "Sodona" as a family name, and likewise the name Tizzioni; Sodona is signed upon some of his pictures. While "Bazzi" was corrupted into "Razzi," "Sodona" may have been corrupted into "Sodoma"; Vasari, however, accounted for the name differently, as a nickname from his personal character. This version appears to have been inspired by Bazzi's pupil and subsequent rival Beccafumi. In R. H. Cust's recent work on the painter another suggestion is made. Vasari tells a story that, Bazzi's horse having won a race at Florence, a cry of "Who is the owner?" went up, and Bazzi contemptuously answered "Sodoma," in order to insult the Florentines (according to Milanese); and Mr Cust offers the suggestion of the Italian friend, that the racing name was really a clipped form of *So doma*, "I am the trainer." Whatever the real origin, the name was long supposed to indicate an immoral character.

Bazzi was of the family de Bazis, and was born at Vercelli in Lombardy in 1477. His first master was Martino Spanzotto, by whom one signed picture is known; and he appears to have been in his native place a scholar of the painter Giovenone. Acquiring thus the strong colouring and other distinctive marks of the Lombard school, he was brought to Siena towards the close of the 15th century by some agents of the Spannocchi family; and, as the bulk of his professional life was passed in this Tuscan city, he counts as a member of the Siennese school, although not strictly affined to it in point of style. He does not seem to have been a steady or laborious student in Siena, apart from some attention which he bestowed upon the sculptures of Jacopo della Quercia. Along with Pinturicchio, he was one of the first to establish there the matured style of the *Cinquecento*. His earliest works of repute are seventeen frescoes in the Benedictine monastery of Monte Oliveto, on the road from Siena to Rome, illustrating the life of St Benedict, in continuation of the series which Luca Signorelli had begun in 1498; Bazzi completed the set in 1502. Hence he was invited to Rome by the celebrated Siennese merchant Agostino Chigi, and was employed by Pope Julius II. in the Camera della Segnatura in the Vatican. He executed two great compositions and various ornaments and grotesques. The latter are still extant; but the larger works did not satisfy the pope, who engaged Raphael to substitute his "Justice," "Poetry," and "Theology." In the Chigi Palace (now Farnesina) Bazzi painted some subjects from the life of Alexander the Great; "Alexander in the Tent of Darius" and the "Nuptials of the Conqueror with Roxana" (by some considered his masterpiece) are more particularly noticed. When Leo X. was made pope (1513) Bazzi presented him with a picture of the "Death of Lucretia" (or of Cleopatra, according to some accounts); Leo gave him a large sum of money in recompense and created him a cavaliere. Bazzi afterwards returned to Siena and at a later date went in quest of work to Pisa, Volterra, and Lucca. From Lucca he returned to Siena, not long before his death, which took place on the 14th of February 1549 (the older narratives say 1554). He had squandered his property and is said (rather dubiously) to have died in penury in the great hospital of Siena. Bazzi had married in youth a lady

of good position, but the spouses disagreed and separated pretty soon afterwards. A daughter of theirs married Bartolommeo Neroni, named also Riccio Sanese or Maestro Riccio, one of Bazzi's principal pupils.

It is said that Bazzi jeered at the *History of the Painters* written by Vasari, and that Vasari consequently traduced him; certainly he gives a bad account of Bazzi's morals and demeanour, and is niggardly towards the merits of his art. According to Vasari, the ordinary name by which Bazzi was known was "Il Mattaccio" (the Madcap, the Maniac)—this epithet being first bestowed upon him by the monks of Monte Oliveto. He dressed gaudily, like a mountebank; his house was a perfect Noah's ark, owing to the strange miscellany of animals which he kept there. He was a cracker of jokes and fond of music, and sang some poems composed by himself on indecorous subjects. In his art Vasari alleges that Bazzi was always negligent—his early success in Siena, where he painted many portraits, being partly due to want of competition. As he advanced in age he became too lazy to make any cartoons for his frescoes, but daubed them straight off upon the wall. Vasari admits, nevertheless, that Bazzi produced at intervals some works of very fine quality, and during his lifetime his reputation stood high.

The general verdict is that Bazzi was an able master in expression, motion and colour. His taste was something like that of Da Vinci, especially in the figures of women, which have grace, sweetness and uncommon earnestness. He is not eminent for drawing, grouping or general elegance of form. His easel pictures are rare; there are two in the National Gallery in London.

It is uncertain whether Bazzi was a pupil of Leonardo da Vinci, though Morelli (in his *Italian Pictures in German Galleries*) speaks of his having "only ripened into an artist during the two years (1498-1500) he spent at Milan with Leonardo"; and some critics see in Bazzi's "Madonna" in the Brera (if it is really by Bazzi) the direct influence of this master. Modern criticism follows Morelli in supposing that Raphael painted Bazzi's portrait in "The School of Athens"; and a drawing at Christ Church is supposed to be a portrait of Raphael by Bazzi.

His most celebrated works are in Siena. In S. Domenico, in the chapel of St Catherine of Siena, are two frescoes painted in 1526, showing Catherine in ecstasy, and fainting as she is about to receive the Eucharist from an angel—a beautiful and pathetic treatment. In the oratory of S. Bernardino, scenes from the history of the Madonna, painted by Bazzi in conjunction with Pacchia and Beccafumi (1536-1538)—the "Visitation" and the "Assumption"—are noticeable. In S. Francesco are the "Deposition from the Cross" (1513) and "Christ Scourged"; by many critics one or other of these paintings is regarded as Bazzi's masterpiece. In the choir of the cathedral at Pisa is the "Sacrifice of Abraham," and in the Uffizi Gallery of Florence as "St Sebastian."

See for further details, *Giovanni Antonio Bazzi*, by Robert H. Hobart Cust (1906), which contains a full bibliography. (W. M. R.)

SODOR AND MAN, the name of the bishopric of the Church of England which includes the Isle of Man and adjacent islets. In 1154 the diocese of Sodor was formed to include the Hebrides and other islands west of Scotland (Norse *Sudr-eyjar*, Sudreys, or southern isles, in distinction from *Nordr-eyjar*, the northern isles of Orkney and Shetland) and the Isle of Man. It was in the archdiocese of Trondhjem in Norway. (The connexion of the Isle of Man with Norway is considered *s.v.* MAN, ISLE OF.) A Norwegian diocese of Sodor had been in existence previously, but its history is obscure, and the first union of Man with it in 1098 by Magnus Barefoot is only traditional. The Norwegian connexion was broken in 1266, and in 1334 Man was detached from the Scottish islands. The cathedral of Sodor was on St Patrick's Isle at Peel (*q.v.*), and it is possible that the name Sodor being lost, its meaning was applied to the isle as the seat of the bishop. The termination "and Man" seems to have been added in the 17th century by a legal draughtsman ignorant of the proper application of the name of Sodor to the bishopric of Man. By the latter part of the 16th century the terms Sodor and Man had become interchangeable, the bishopric being spoken of as that of Sodor or Man. Till 1604 the bishops invariably signed themselves *Soderensis*; after that date and till 1684, sometimes *Soderensis* and sometimes "Sodor and Man," and after 1684 always "Sodor and Man." The see, while for some purposes in the archdiocese of York, has its own convocation. The bishop sits in the House of Lords, but has no vote.

See A. W. Moore, *History of the Isle of Man* (London, 1900).

SOEST, a town of Germany, in the Prussian province of Westphalia, situated in a fertile plain (*Soester Börde*), 33 m. E.

of Dortmund, on the main railway Cologne-Elberfeld-Berlin. Pop. (1905), 17,394. Its early importance is attested by its seven fine churches (six Protestant), of which the most striking are St Peter's, the Wiesenkirche, a gem of Gothic architecture, Maria zur Höhe—St Mary-on-the-height—with beautiful mural frescoes, founded in 1314 and restored in 1850-1852, and the Roman Catholic cathedral, founded in the 10th century by Bruno, brother of Otto the Great (the present building was erected in the 12th century). This last, with its very original façade, is one of the noblest ecclesiastical monuments of Germany. Remains of the broad wall, now partly enclosing gardens and fields, and one of the gates remain; but the thirty-six strong towers which once defended the town have disappeared and the moats have been converted into promenades. The town-hall (1701) contains valuable archives, and among the numerous educational establishments must be mentioned the gymnasium, founded in 1534, through the instrumentality of Melancthon, an evangelical teachers' seminary, an agricultural school, and a blind asylum. Iron-working, the manufacture of soap, hats, sugar, cigars, bricks and tiles, linen-weaving, tanning and brewing, together with market-gardening and farming in the neighbourhood, and trade in cattle and grain are the leading industries.

Mentioned in documents as early as the 9th century, Soest was one of the largest and most important Hanseatic towns in the middle ages, with a population estimated at from 30,000 to 60,000. It was one of the chief emporiums on the early trading route between Westphalia and Lower Saxony. Its code of municipal laws (*Schran; jus susatense*), dating from 1144 to 1165, was one of the earliest and best, and served as a model even to Lübeck. On the fall of Henry the Lion, duke of Saxony, Soest passed with the rest of Angria to Cologne. In the 15th century the strife between the townsmen and the archbishops broke out in open war, and in 1444 the strong fortifications of the town withstood a long siege by an army of 60,000 men. The women of Soest are said to have distinguished themselves in this contest (*Soester Fehde*). Papal intervention ended the strife, and Soest was permitted to remain under the protection of the dukes of Cleves. The prosperity of the town waned in more modern times: in 1763 its population was only 3800; in 1816 it was 6687.

See Vogeler, *Soest, seine Aeltertümer und Sehenswürdigkeiten* (Soest, 1890); Hausberg, *Die soester Fehde* (Trier, 1882); Sümmermann, *Die Wandmalereien in der Kirche Maria zur Höhe in Soest* (Soest, 1890); Aldenkirchen, *Die mittelalterliche Kunst in Soest* (Bonn, 1875); Ludorff und Vogeler, *Kunstdenkmäler des Kreises Soest* (Soest, 1905).

SOFA, a long couch with stuffed back, arms and seat, to hold two or more persons. The word is of Arabic origin, and is an adaptation of *suffah*, couch, from root *saffa*—to draw up in line. According to Richardson, *Dict. of Eng. Lang.* quoted by Skeat, the Arabic *suffah* was particularly a reclining place of wood or stone placed before the doors of Oriental houses. In the history of furniture the sofa was a development of the straight backed settee. It was not so much therefore a long chair or combination of chairs, as a seat or couch for reclining. The early 19th-century type had a back with a single arm at one end, the other being left open. The most favoured modern form is that known as the Chesterfield, with double arms and back, heavily padded. (See also *SETTEE*.)

SOFALA, a Portuguese seaport on the east coast of Africa, at the mouth of a river of the same name, in 20° 12' S. Pop. (1900), about 1000. The town possesses scarcely a trace of its former importance, and what trade it had was nearly all taken away by the establishment of Beira (*q.v.*) a little to the north in 1890. Sofala Harbour, once capable of holding a hundred large vessels, is silting up and is obstructed by a bar. Ruins exist of the strong fort built by the Portuguese in the 16th century. Previous to its conquest by the Portuguese in 1505 Sofala was the chief town of a wealthy Mahomedan state, Arabs having established themselves there in the 12th century or earlier. At one time it formed part of the sultanate of

Kilwa (*q.v.*). Sofala was visited by the Portuguese Jew, Pero de Covilhão, in 1489, who was attracted thither by the reports of gold-mines of which Sofala was the port. The conquest of the town followed, the first governors of the Portuguese East African possessions being entitled Captains-General of Sofala. (See *PORTUGUESE EAST AFRICA*.) Thomé Lopes, who accompanied Vasco da Gama to India in 1502 and left a narrative of the voyage (first printed in Ramusio, *Viaggi e Navigazioni*), identifies Sofala with Solomon's Ophir and states that it was the home of the Queen of Sheba. This identification of Sofala with Ophir, to which Milton alludes (*Par. Lost*, xi. 399-401) is untenable.

The small island of Chiloane, with a good harbour, 40 m. S. of Sofala, has been colonized from Sofala (the township being named Chingune) as has also the island Santa Carolina, in the Bazaruto archipelago.

See *Bull. Geogr. Soc. Mozambique* (1882) for an account of the Sofala mines; and, generally, Idrisi, *Climat*, i. § 8, O. Dapper, *Description de l'Afrique* (Amsterdam, 1686); T. Baines, *The Gold Regions of South Africa* (1877); G. McC. Theal's *Records of South Eastern Africa* (1898-1903); Sir R. Burton's notes to his edition of Camoens.

SOFFIONI (sometimes spelt *suffioni*), a name applied in Italy to certain volcanic vents which emit jets of steam, generally associated with hydrogen sulphide and carbon dioxide, sometimes also with a little ammonia and marsh-gas. The soffioni are usually arranged in groups, and are best represented in the Maremma of Tuscany, where they contain a small proportion of boric acid, for which they are utilized industrially. For such natural steam-holes, the French geologists often use the term *soufflards* in place of the Italian soffioni.

SOFFIT (from Fr. *soffite*, Ital. *soffitta*, a ceiling, formed as if from *suffictus* for *suffixus*, Lat. *suffigere*, to fix underneath), a term in architecture given to the underside of any constructional feature; as for instance that of an arch or an architrave whether supported by piers or columns; also to the underside of a flight of stairs, and in the classic entablature to the underside of the projecting cornice.

SOFIA (Bulgarian *Sredets*, the middle town, a name now little used), the capital of Bulgaria, situated almost in the centre of an upland plain, about 1700 ft. above sea-level, between the Western Balkans on the N. and Mt Vitosh on the S. Pop. (1907) 82,187. Two small tributaries of the river Isker, the Perlovetz and the Eleshnitza or Boyana, flow respectively on the east and west sides of the town. Since 1880 the city has been almost entirely renovated in the "European" style; the narrow tortuous lanes and mean houses of the Turkish epoch have almost disappeared, and a new town with straight parallel streets has been constructed in the eastern suburb. The oldest building in Sofia is the little round chapel of St George in the Jewish quarter—originally, it is said, a Roman temple; then a church, then a mosque, and now a church once more. Of the principal mosques the large Buyuk Djamia, with nine metal cupolas, has become the National Museum; the Tcherná Djamia or Black Mosque, latterly used as a prison, has been transformed into a handsome church; the Banyabashi Djamia, with its picturesque minaret, is still used by Moslem worshippers. Close to the last-named in the centre of the town, are the public baths with hot springs (temperature 117° F). In the cathedral or church of Sveti Kral (the Saint King), a modern building, are preserved the remains of the Serbian king Stefan Urosh II. A large new cathedral dedicated to St Alexander Nevski was in course of construction in 1907; the foundation stone was taken from the church of St Sophia. The palace of the prince, occupying the site of the Turkish konak was built by Prince Alexander in 1880-1882; it has been greatly enlarged by King Ferdinand. In front of the palace is the public garden or Alexander Park. The theatre, the largest in south-eastern Europe, was completed in 1906. Other important buildings are the Sobranje, or parliament house, the palace of the synod, the ministries of war and commerce, the university with the national printing press, the national library, the officers' club and several large military structures. A small

mausoleum contains the remains of Prince Alexander; there are monuments to the tsar Alexander II., to Russia, to the medical officers who fell in the war of 1877 and to the patriot Levsky. A public park has been laid out in the eastern suburbs. The city is well drained and possesses a good water supply; it is lighted by electricity and has an electric car system. It contains breweries, tanneries, sugar, tobacco, cloth, and silk factories, and exports skins, cloth, cocoons, cereals, attar of roses, dried fruit, &c. Sofia forms the centre of a railway system radiating to Constantinople (300 m.), Belgrade (206 m.) and central Europe, Varna, Ruscuk and the Danube, and Kiustendil near the Macedonian frontier. The climate is healthy; owing to the elevated situation it is somewhat cold, and is liable to sudden diurnal and seasonal changes; the temperature in January sometimes falls to 4° F. below zero and in August rises to 100°. The population, of which more than two-thirds are Bulgarians, and about one-sixth Spanish Jews, was 20,501 in 1881, 30,428 in 1888, 46,593 in 1893 and 82,187 in 1907.

History.—The colony of Serdica, founded here by the emperor Trajan, became a Roman provincial town of considerable importance in the 3rd and 4th centuries A.D., and was a favourite residence of Constantine the Great. Serdica was burnt by the Huns in A.D. 447; few traces remain of the Roman city, but more than one hundred types of its coins attest its importance. The town was taken by the Bulgarians under Krum in A.D. 809; the name Serdica was converted into Sredetz by the Slavs, who associated it with *sred*a (middle), and the Slavonic form subsequently became the Byzantine Triaditza. The name Sofia, which came into use towards the end of the 14th century is derived from the early medieval church of St Sophia, the massive ruins of which stand on an eminence to the east of the town. The church, which was converted into a mosque by the Turks, was partly destroyed by earthquakes in 1818 and 1858. The town successfully resisted the attacks of the emperor Basil II. in 987; between 1018 and 1186, under Byzantine rule, it served as a frontier fortress. During this period a number of prisoners of the Petcheneg tribe were settled in the neighbourhood, in all probability the ancestors of the Shòp tribe which now inhabits the surrounding districts. In 1382 Sofia was captured by the Turks; in 1443 it was for a brief time occupied by the Hungarians under John Hunyady. Under Turkish rule the city was for nearly four centuries the residence of the beylerbey or governor-general of the whole Balkan Peninsula except Bosnia and the Morea. During this period the population increased and became mainly Turkish; in 1553 the town possessed eleven large and one hundred small mosques. In the latter half of the 15th century Sofia, owing to its situation at the junction of several trade routes, became an important centre of Ragusan commerce. During the Turco-Russian campaign of 1829 it was the headquarters of Mustafa Pasha of Skodra, and was occupied by the Russians for a few days. On the 4th of January 1878 a Russian army again entered Sofia after the passage of the Balkans by Gourko; the bulk of the Turkish population had previously taken flight. Though less central than Philippopolis and less renowned in Bulgarian history than Trnovo, Sofia as selected as the capital of the newly-created Bulgarian state in view of its strategical position, which commands the routes to Constantinople, Belgrade, Macedonia and the Danube. (J. D. B.)

SOGDIANA (Sugdiane, O. Pers. *Sughuda*), a province of the Achaemenian Empire, the eighteenth in the list in the Behistun inscription of Darius (i. 16), corresponding to the modern districts of Samarkand and Bokhara; it lay north of Bactriana between the Oxus and the Jaxartes, and embraced the fertile valley of the Zerafshan (anc. Polytimetus). Under the Greeks Sogdiana was united in one satrapy with Bactria, and subsequently it formed part of the Bactrian Greek kingdom till the Scythians (see SCYTHIA) occupied it in the middle of the 2nd century B.C. The valley of the Zerafshan about Samarkand retained even in the middle ages the name of the Soghd of Samarkand. Arabic geographers reckon it as one of the four fairest districts in the world.

SOGNE FJORD, a great inlet of the west coast of Norway, penetrating the mainland to a distance of 136 m. It is the longest fjord in Norway, and the deepest, approaching 700 fathoms in some parts. Sognefest at its entrance is 50 m. by water from Bergen, in 61° 5' N. The general direction from the sea is easterly. For the first 50 m. the sombre flanking mountains are unbroken by any considerable branch, but from this point several deep, narrow inlets ramify, penetrating the Jostedalsbrae and Jotunfjeld to the north and the northward extension of the Hardangerfjeld to the south, walled in at their heads by snow-clad mountains and frequented by travellers on account of the magnificent scenery. The principal are Fjaerlands, Sogndals and Lyster fjords to the north, Aardals fjord to the east, Laerdals and Aurlands fjords to the south. From the last branches the Naerö fjord, with a precipitous valley of great beauty (Naerödalen) at its head, traversed by a road, from Gudvangen on the fjord, across the Stalheim Pass to Vossevangen. The other principal villages are Vadheim on the outer fjord, the terminus of the road from Nordfjord; Balholm and Fjaerland (centres for visiting the fine glaciers of Jostedal); Lekanger, Sogndal, and Laerdalsören, whence a road strikes south-east for the Valdres and Hallingdal districts.

SOHAM, a town in the Newmarket parliamentary division of Cambridgeshire, England, 5 m. S.E. of Ely by a branch of the Great Eastern railway. Pop. (1901), 4230. It lies in the midst of the flat fen country. To the west a rich tract, still known as Soham Mere, marks the place of one of the many wide and shallow sheets of water in the district now drained. The church of St Andrew is cruciform and had formerly a central tower; the existing western tower is of fine and ornate Perpendicular work. The body of the church, however, is mainly transitional Norman with additions principally Decorated, including a beautiful east window, much ancient woodwork, and other details of interest. The grammar school dates from 1687. The road from Soham to Ely was constructed as a causeway across the fens by Hervey le Breton, first bishop of Ely (1109-1131). The trade of the town is agricultural, fruit-growing and market-gardening being largely carried on in the vicinity.

SOIGNIES (or SOIGNES, the Walloon form), a busy and flourishing town of the province of Hainaut, owing its prosperity to the important blue granite quarries in the neighbourhood. It contains a fine abbey church of the 12th century and in the cemetery connected with it are many tombstones of the 13th and 14th centuries. Pop. (1904), 10,480.

The forest of Soignies extended in the middle ages over the southern part of Brabant up to the walls of Brussels, and is immortalized in Byron's *Childe Harold*. Originally it was part of the Ardenne forest, and even at the time of the French Revolution it was very extensive. The first blow towards its gradual contraction was struck when Napoleon ordered 22,000 oaks to be cut down in it to build the celebrated Boulogne flotilla for the invasion of England. King William I. of the Netherlands continued the process in the belief that he was thus adding to the prosperity of the country, and from 29,000 acres in 1820 the forest was reduced to 11,200 in 1830. A considerable portion of the forest in the neighbourhood of Waterloo was assigned in 1815 to the duke of Wellington, and to the holder of the title as long as it endured. This portion of the forest was only converted into farms in the time of the second duke. The Bois de la Cambre (456 acres) on the outskirts of Brussels was formed out of the forest, and beyond it stretches the Forêt de Soignies, still so called, to Tervueren, Groenendael, and Argenteuil close to Mont Saint Jean and Waterloo.

SOIL,¹ the term generally applied to that part of the earth's

¹ This word comes through O. Fr. *soil* from a Late Latin usage of *solea* for soil or ground, which in classic Lat. meant the sole of the foot, also a sandal. This was due to a confusion with *solum*, ground, whence Fr. *sol*. Both *solea* and *solum* are, of course, from the same root. To be distinguished from this word is "soil," to make dirty, to stain, defile. The origin is the O. Fr. *soil* or *souil*, the miry wallowing ground of a wild boar, whence the hunting phrase "to take soil," of a beast of the chase taking to water or marshy ground. The derivation is therefore from Lat. *soillus*, pertaining to

substance which is stirred or tilled by implements such as ploughs and spades. Below this is the *subsoil*. The soil through being acted upon by the air, heat, frost and other agencies usually consists of finer particles than those comprising the bulk of the subsoil. It contains more roots, and as a rule, is darker in colour than the subsoil on account of the larger proportion of decaying vegetable matter present in it: it is also looser in texture than the subsoil. The subsoil not unfrequently contains materials which are deleterious to the growth of crops, and roots descending into it may absorb and convey these poisonous substances to other parts of the plant or be themselves damaged by contact with them. On this account deeper tillage than usual, which allows of easier penetration of roots, or the carrying out of operations which bring the subsoil to the surface, must always be carefully considered.

At first sight few natural materials appear to be of less interest than the soil; yet its importance is manifest on the slightest reflection. From it, directly or indirectly, are obtained all food materials needed by man and beast. The inorganic materials within it supply some of the chief substances utilized by plants for their development and growth, and from plants animals obtain much of their sustenance.

Origin of the Soil.—It is a matter of common observation that stones of monuments, walls or buildings which are exposed to the air sooner or later become eaten away or broken up into small fragments under the influence of the weather. This disintegration is brought about chiefly by changes in temperature, and by the action of the rain, the oxygen, and the carbon dioxide of the air. During the daytime the surface of the stone may become very warm, while at night it is speedily cooled. Such alterations in temperature produce strains which frequently result in the chipping off of small fragments of the material composing the stone. Moreover the rain penetrates into the small interstices between its particles and dissolves out some of the materials which bind the whole into a solid stone, the surface then becoming a loose powdery mass which falls to the ground below or is carried away by the wind. The action of frost is also very destructive to many stones, since the water within their cracks and crannies expands on freezing and splits off small pieces from their surfaces. In the case of limestones the carbon dioxide of the air in association with rain and dew eats into them and leads to their disintegration. The oxygen of the air may also bring about chemical changes which result in the production of soluble substances removable by rain, the insoluble parts being left in a loosened state.

These "weathering" agents not only act upon stones of buildings, but upon rocks of all kinds, reducing them sooner or later into a more or less fine powder. The work has been going on for ages, and the finely comminuted particles of rocks form the main bulk of the soil which covers much of the earth's surface, the rest of the soil being composed chiefly of the remains of roots and other parts of plants.

If the whole of the soil in the British Islands were swept into the sea and the rocks beneath it laid bare the surface of the country would ultimately become covered again with soil produced from the rocks by the weathering processes just described. Moreover where there was no transport or solution of the soil thus produced it would necessarily show some similarity in composition to the rock on which it rested. The soils overlying red sandstone rocks would be reddish and of a sandy nature, while those overlying chalk would be whitish and contain considerable amounts of lime. In many parts of the country soils exhibiting such relationships, and known as *sedentary* soils, are prevalent, the transition from the soil to the rock beneath being plainly visible in sections exposed to view in railway cuttings, quarries and other excavations. The upper layer or soil proper consists of material which has been subjected swine, *sus*. "To sully," to besmirch, to cover with "mire" (O. Eng. *sol*. cf. Ger. *sühlen*) is a quite distinct word. Lastly there is a form "soil," used by agriculturists, of the feeding and fattening of cattle with green food such as vetches. This is from O. Fr. *saoler*, *saouler*, mod. *sodler*, Lat. *satullus*, full-fed (*satur*, satiated, *satiss*, enough).

to ages of weathering; the bulk of it is composed of finely comminuted particles of sand, clay and other minerals, among which are imbedded larger or smaller stones of more refractory nature. On descending into the substratum the finer material decreases and more stones are met with; farther down are seen larger fragments of unaltered rock closely packed, and this brash or rubble grades insensibly into the unbroken rock below.

In many districts the soil is manifestly unconnected in origin with the rock on which it rests, and differs from it in colour, composition and other characters. There are *transported* or drift soils, the particles of which have been brought from other areas and deposited over the rocks below. Some of the stiff boulder clays or "till" so prevalent over parts of the north of England appear to have been deposited from ice sheets during the glacial period. Perhaps the majority of drift soils, however, have been moved to their present position by the action of the water of rivers or the sea.

As fast as the rock of a cliff is weathered its fragments are washed to the ground by the rain, and carried down the slopes by small streams, ultimately finding their way into a river along which they are carried until the force of the water is insufficient to keep them in suspension, when they become deposited in the river bed or along its banks. Such river-transported material or *alluvium* is common in all river valleys. It is often of very mixed origin, being derived from the detritus of many kinds of rocks, and usually forms soil of a fertile character.

Quality of Soil.—The good or bad qualities of a soil have reference to the needs of the crops which are to be grown upon it, and it is only after a consideration of the requirements of plants that a clear conception can be formed of what characters the soil must possess for it to be a suitable medium on which healthy crops can be raised.

In the first place, soil, to be of any use, must be sufficiently loose and porous to allow the roots of plants to grow and extend freely. It may be so compact that root development is checked or stopped altogether, in which case the plant suffers. On the other hand it should not be too open in texture or the roots do not get a proper hold of the ground and are easily disturbed by wind: moreover such soils are liable to blow away, leaving the underground parts exposed to the air and drought.

The roots like all other parts of plants contain protoplasm or living material, which cannot carry on its functions unless it is supplied with an adequate amount of oxygen: hence the necessity for the continuous circulation of fresh air through the soil. If the latter is too compact or has its interstices filled with carbon dioxide gas or with water—as is the case when the ground is water-logged—the roots rapidly die of suffocation just as would an animal under the same conditions. There is another point which requires attention. Plants need very considerable amounts of water for their nutrition and growth; the water-holding capacity is, therefore, important. If the soil holds too much it becomes water-logged and its temperature falls below the point for healthy growth, at any rate of the kinds of plants usually cultivated on farms and in gardens. If it allows of too free drainage drought sets in and the plants, not getting enough water for their needs, become stunted in size. Too much water is bad, and too little is equally injurious.

In addition, the temperature of the soil largely controls the yield of crops which can be obtained from the land. Soil whose temperature remains low, whether from its northerly aspect or from its high water content or other cause, is unsatisfactory, because the germination of seeds and the general life processes of plants cannot go on satisfactorily except at certain temperatures well above freezing-point.

A good soil should be deep to allow of extensive root development and, in the case of arable soils, easy to work with implements. Even when all the conditions above mentioned in regard to texture, water-holding capacity, aeration and temperature are suitably fulfilled the soil may still be barren: plant food-material is needed. This is usually present in abundance although it may not be available to the plant under certain

circumstances, or may need to be replenished or increased by additions to the soil of manures or fertilizers (see MANURE).

Chief Constituents of the Soil.—An examination of the soil shows it to be composed of a vast number of small particles of sand, clay, chalk and humus, in which are generally imbedded larger or smaller stones. It will be useful to consider the nature of the four chief constituents just mentioned and their bearing upon the texture, water-holding capacity and other characters which were referred to in the previous section.

Sand consists of grains of quartz or flint, the individual particles of which are large enough to be seen with the unaided eye or readily felt as gritty grains when rubbed between the finger and thumb. When a little soil is shaken up with water in a tumbler the sand particles rapidly fall to the bottom and form a layer which resembles ordinary sand of the seashore or river banks. Chemically pure sand is silicon dioxide (SiO₂) or quartz, a clear transparent glass-like mineral, but as ordinarily met with, it is more or less impure and generally coloured reddish or yellowish by oxide of iron. A soil consisting of sand entirely would be very loose, would have little capacity to retain water, would be liable to become very hot in the daytime and cool at night and would be quite unsuitable for growth of plants.

The term clay is often used by chemists to denote hydrated silicate of alumina (Al₂O₃·2SiO₂·2H₂O), of which kaolin or china clay is a fairly pure form. This substance is present in practically all soils but in comparatively small amounts. Even in the soils which farmers speak of as stiff clays it is rarely present to the extent of more than 1 or 2%. The word "clay" used in the agricultural sense denotes a sticky intractable material which is found to consist of exceedingly fine particles (generally less than .005 mm. in diameter) of sand and other minerals derived from the decomposition of rocks, with a small amount of silicate of alumina. The peculiar character which clay possesses is probably due not to its chemical composition but to its physical state. When wet it becomes sticky and almost impossible to move or work with farm implements; neither air nor water can penetrate freely. In a dry state it becomes hard and bakes to a brick. It holds water well and is consequently cold, needing the application of much heat to raise its temperature. It is obvious, therefore, that soil composed entirely of clay is as useless as pure sand so far as the growth of crops upon it is concerned.

Chalk consists, when quite pure, of calcium carbonate (CaCO₃), a white solid substance useful in small amounts as a plant food-material, though in excess detrimental to growth. Alone, even when broken up into small pieces, it is unsuitable for the growth of plants.

Humus, the remaining constituent of soil, is the term used for the decaying vegetable and animal matter in the soil. A good illustration of it is peat. Its water-holding capacity is great, but it is often acid, and when dry it is light and incapable of supporting the roots of plants properly. Few of the commonly cultivated crops can live in a soil consisting mainly of humus.

From the above account it will be understood that not one of the four chief soil constituents is in itself of value for the growth of crops, yet when they are mixed, as they usually are in the soils met with in nature, one corrects the deficiencies of the other. A perfect soil would be such a blend of sand, clay, chalk and humus as would contain sufficient clay and humus to prevent drought, enough sand to render it pervious to fresh air and prevent water-logging, chalk enough to correct the tendency to acidity of the humus present, and would have within it various substances which would serve as food-materials to the crops.

Generally speaking, soils containing from 30 to 50% of clay and 50 to 60% of sand with an adequate amount of vegetable residues prove the most useful for ordinary farm and garden crops; such blends are known as "loams," those in which clay predominates being termed clay loams, and those in which the sand predominates sandy loams. "Stiff clays" contain over 50% of clay; "light sands" have less than 10%. In the mechanical analysis of the soil, after separation of the stones and fine gravel by means of sieves, the remainder of the finer earth is subjected to various processes of sifting and deposition from water with a view of determining the relative proportions of sand, silt and clay present in it. Most of the material termed "sand" in such analyses consists of particles ranging in diameter from .5 to .05 mm., and the "silt" from .05 to .005 mm., the "clay" being composed of particles less than .005 mm. in diameter. The proportional amount of these materials in a sandy soil on the Bagshot beds and a stiff Oxford clay is given below:—

	Soil on Bagshot Beds.	Soil on Oxford Clay.
Coarse sand 1--2 mm.	32 %	11 %
Fine sand .2--.04 mm.	40 "	11 "
Silt .04--.01 mm.	12 "	19 "
Fine silt .01--.004 mm.	8 "	19 "
Clay below .004 mm.	8 "	40 "

The pore-space within the soil, *i.e.* the space between the particles composing the soil, varies with the size of these particles and with the way they are arranged or packed. It is important, since upon it largely depends the movement of air and water in the land. It is generally from 30 to 50% of the total volume occupied by the soil.

Where the soil grains are quite free from each other the smaller grains tend to fill up the spaces between the larger ones; hence it might be concluded that in clays the amount of pore-space would be less than in coarser sands. This is the case in "puddled" clays, but in ordinary clay soils the excessively minute particles of which they largely consist tend to form groups of comparatively large composite grains and it is in such natural soils that the pore-space is largest.

Chemical Composition of the Soil.—It has been found by experiment that plants need for their nutritive process and their growth, certain chemical elements, namely, carbon, hydrogen, oxygen, nitrogen, sulphur, phosphorus, potassium, magnesium, calcium and iron. With the exception of the carbon and a small proportion of the oxygen and nitrogen, which may be partially derived from the air, these elements are taken from the soil by crops. The following table shows the amounts of the chief constituents removed by certain crops in lb per acre:—

Crop.	Nitro- gen.	Phos- phoric Acid.	Potash.	Lime.	Mag- nesia.
	lb	lb	lb	lb	lb
Wheat	50	21	29	9	7
Meadow hay	49	12	51	32	14
Turnips	110	33	149	74	9
Mangels	149	53	300	43	42

Plants also remove from the soil silicon, sodium, chlorine, and other elements which are, nevertheless, found to be unessential for the growth and may therefore be neglected here.

Leguminous crops take some of the nitrogen which they require from the air, but most plants obtain it from the nitrates present in the soil. The sulphur exists in the soil chiefly in the form of sulphates of magnesium, calcium and other metals; the phosphorus mainly as phosphates of calcium, magnesium and iron; the potash, soda and other bases as silicates and nitrates; calcium and magnesium carbonates are also common constituents of many soils.

In the ordinary chemical analyses of the soil determinations are made of the nitrogen and various carbonates present as well as of the amount of phosphoric acid, potash, soda, magnesia and other components soluble in strong hydrochloric acid.

Below are given examples of the analyses of a poor sandy soil and an ordinary loam:—

	Poor sandy Soil on Bagshot Beds.	Loam or Lias.
Nitrogen19 %	.17 %
Phosphoric acid18 "	.32 "
Potash19 "	.57 "
Carbonate of Lime23 "	1.22 "

Since the dry weight of the first foot of soil over an acre is about 4,000,000 lb the poor sandy soil contains within it:—

Nitrogen	7,600 lb
Phosphoric acid	7,200 "
Potash	7,600 "
Lime	9,200 "

From the figures given previously of the amount of nitrogen, potash and phosphoric acid removed by a wheat or mangel crop it would appear that this soil has enough of these ingredients in it to yield many such crops; yet experience has shown that these crops cannot be grown on such a poor sandy soil unless manures containing phosphates, potash and nitrogen are added.

Many attempts have been made to correlate the results of the analyses of a soil with its known cropping power, but there is yet much to be learnt in regard to these matters. A great proportion of the food constituents which can be extracted by strong hydrochloric acid are not in a condition to be taken up by the roots of plants; they are present, but in a "dormant" state, although by tillage and weathering processes they may in time become "available" to plants. Analyses of this character would appear to indicate the permanent productive capacity of the soil rather than its immediate power of growing a crop.

Soils containing less than .25% of potash are likely to need special application of potash fertilizers to give good results, while those containing as much as .4 or .5% do not usually respond to those manures. Where the amount of phosphoric acid (P₂O₅) is less than .05% phosphatic manures are generally found to be beneficial; with more than .1% present these fertilizers are not usually called for except perhaps in soils containing a high percentage of iron

compounds. Similarly soils with less than .1% of nitrogen are likely to be benefited by applications of nitrogenous manures. Too much stress, however, cannot be laid upon these figures, since the fertility of a soil is very greatly influenced by texture and physical constitution, perhaps more so by these factors than by chemical composition.

At present it is not possible to determine with accuracy the amount of immediately available plant food-constituents in a soil: no doubt the various species of plants differ somewhat in their power of absorbing these even from the same soil. The method introduced by Dyer of dissolving out the mineral constituents of the soil with a 1% solution of citric acid, which represents about the average acidity of the roots of most common plants, yields better results. In the case of arable soils, where the amount of phosphoric acid determined by this method falls below .01%, phosphatic manuring is essential for good crops. The writer has found that many pasture soils containing less than .025 or .03%, respond freely to applications of phosphates; probably in such cases even the weak acid is capable of dissolving out phosphates from the humus or other compounds which yield little or none to the roots of grasses and clovers. In soils where the potash available to citric acid is less than .005%, kainit and other potash fertilizers are needed.

Water in the Soil.—The importance of an adequate supply of water to growing crops cannot well be over-estimated. During the life of a plant there is a continuous stream of water passing through it which enters by the root-hairs in the soil and after passing along the stem is given off from the stomata of the leaves into the open air above ground. It has been estimated that an acre of cabbage will absorb from the land and transpire from its leaves more than ten tons of water per day when the weather is fine.

In addition to its usefulness in maintaining a turgid state of the young cells without which growth cannot proceed, water is itself a plant food-material and as absorbed from the soil contains dissolved in it all the mineral food constituents needed by plants for healthy nutrition. Without a sufficient supply plants remain stunted and the crop yield is seriously reduced, as we see in dry seasons when the rainfall is much below the average. If one condition is more necessary than another for good crops it is a suitable supply of water, for no amount of manuring or other treatment of the soil will make up for a deficient rainfall. The amount needed for the most satisfactory nutrition varies with different plants. In the case of fair average farm crops it has been shown that for the production of one ton of dry matter contained in them from 300 to 500 tons of water has been absorbed and utilized by the plants. This may be more than the rainfall, in which case irrigation or special control of the water supply may be necessary.

The water-holding capacity of a soil depends upon the amount of free space between the particles of which it is composed into which water can enter. In most cases this amounts to from 30 to 50% of the volume of the soil.

When the pore-space of the soil is filled with water it becomes water-logged and few plants can effect absorption by their roots under such conditions. The root-hairs die from want of air, and the whole plant soon suffers. Fields of wheat and other cereals rarely recover after a week's submergence, but orchards and many trees when at rest in winter withstand a flooded or water-logged condition of the soil for two or three weeks without damage. The most satisfactory growth is maintained when the amount of water present is not more than 40 to 60% of what would saturate it. Under such conditions each particle of soil is surrounded by a thin film of water and in the pore-space air can freely circulate. It is from such films that the root-hairs absorb all that plants require for their growth. The movement of water into the root-hairs is brought about by the osmotic action of certain salts in their cell-sap. Crops are, however, unable to absorb all the water present in the soil, for when the films become very thin they are held more firmly or cling with more force to the soil particles and resist the osmotic action of the root-hairs. Plants have been found to wither and die in sandy soils containing 1½% of water, and in clay soils in which there was still present 8% of water.

When a long glass tube open at both ends is filled with soil and one end is dipped in a shallow basin of water, the water is found to move upwards through the soil column just as oil will rise in an ordinary lamp wick. By this capillary action water may be transferred to the upper layers of the soil from a depth of several feet below the surface. In this manner plants whose roots descend but a little way in the ground are enabled to draw on deep supplies. Not only does water move upwards, but it is transferred by capillarity in all directions through the soil. The amount and speed of movement of water by this means, and the distance to which it may be carried, depend largely upon the fineness of the particles composing the soil and the spaces left between each. The ascent of water is most rapid through coarse sands, but the height to which it will rise is comparatively small. In clays whose particles are exceedingly minute the water travels very slowly but may ultimately reach a height of many feet above the level of the "water-table" below. While this capillary movement of water is of great importance in supplying the needs of plants it has its disadvantages, since water may be transferred to the surface of the soil, where it evapo-

rates into the air and is lost to the land or the crop growing upon it. The loss in this manner was found to be in one instance over a pound of water per day per square foot of surface, the "water-table" being about 4 or 5 ft. below.

One of the most effective means of conserving soil moisture is by "mulching," i.e. by covering the surface of the soil with some loosely compacted material such as straw, leaf-refuse or stable-manure. The space between the parts of such substances is too large to admit of capillary action; hence the water conveyed to the surface of the soil is prevented from passing upwards any further except by slow evaporation through the mulching layer. A loose layer of earth spread over the surface of the soil acts in the same way, and a similarly effective mulch may be prepared by hoeing the soil, or stirring it to a depth of one or two inches with harrows or other implements. The hoe and harrow are therefore excellent tools for use in dry weather. Rolling the land is beneficial to young crops in dry weather, since it promotes capillary action by reducing the soil spaces. It should, however, be followed by a light hoeing or harrowing.

In the semi-arid regions of the United States, Argentina and other countries where the average annual rainfall lies between 10 to 20 in., irrigation is necessary to obtain full crops every year. Good crops, however, can often be grown in such areas without irrigation if attention is paid to the proper circulation of water in the soil and means for retaining it or preventing excessive loss by evaporation. Of course care must be exercised in the selection of plants—such as sorghum, maize, wheat, and alfalfa or lucerne—which are adapted to dry conditions and a warm climate.

So far as the water-supply is concerned—and this is what ultimately determines the yield of crops—the rain which falls upon the soil should be made to enter it and percolate rapidly through its interstices. A deep porous bed in the upper layers is essential, and this should consist of fine particles which lie close to each other without any tendency to stick together and "puddle" after heavy showers. Every effort should be made to prepare a good mealy tilth by suitable ploughing, harrowing and consolidation.

In the operation of ploughing the furrow-slice is separated from the soil below, and although in humid soils this layer may be left to settle by degrees, in semi-arid regions this loosened layer becomes dry if left alone even for a few hours and valuable water evaporates into the air. To prevent this various implements, such as disk harrows and specially constructed rollers, may be used to consolidate the upper stirred portion of the soil and place it in close capillary relationship with the lower unmoved layer. If the soil is allowed to become dry and pulverized, rain is likely to run off or "puddle" the surface without penetrating it more than a very short distance. Constant hoeing or harrowing to maintain a natural soil mulch layer of 2 or 3 in. deep greatly conserves the soil water below. In certain districts where the rainfall is low a crop can only be obtained once every alternate year, the intervening season being devoted to tillage with a view of getting the rain into the soil and retaining it there for the crop in the following year.

Bacteria in the Soil.—Recent science has made much progress in the investigation of the micro-organisms of the soil. Whereas the soil used to be looked upon solely as a dead, inert material containing certain chemical substances which serve as food constituents of the crops grown upon it, it is now known to be a place of habitation for myriads of minute living organisms upon whose activity much of its fertility depends. They are responsible for many important chemical processes which make the soil constituents more available and better adapted to the nutrition of crops. One cubic centimetre of soil taken within a foot or so from the surface contains from 1½ to 2 millions of bacteria of many different kinds, as well as large numbers of fungi. In the lower depths of the soil the numbers decrease, few being met with at a depth of 5 or 6 ft.

The efficiency of many substances, such as farm-yard manure, guanos, bone-meal and all other organic materials, which are spread over or dug or ploughed into the land for the benefit of farm and garden crops, is bound up with the action of these minute living beings. Without their aid most manures would be useless for plant growth. Farm-yard manure, guanos and other fertilizers undergo decomposition in the soil and become broken down into compounds of simple chemical composition better suited for absorption by the roots of crops, the changes involved being directly due to the activity of bacteria and fungi. Much of the work carried on by these organisms is not clearly understood; there are, however, certain processes which have been extensively investigated and to these it is necessary to refer.

It has been found by experiment that the nitrogen needed by practically all farm crops except leguminous ones is best supplied in the form of a nitrate; the rapid effect of nitrate of soda when used as a top dressing to wheat or other plants is well known to farmers. It has long been known that when organic materials such as the dung and urine of animals, or even the bodies of animals and plants, are applied to the soil, the nitrogen within them becomes oxidized, and ultimately appears in the form of nitrate of lime, potash or some other base. The nitrogen in decaying roots, in the dead stems and leaves of plants, and in humus generally is sooner or later changed into a nitrate, the change being effected by bacteria. That

the action of living organisms is the cause of the production of nitrates is supported by the fact that the change does not occur when the soil is heated nor when it is treated with disinfectants which destroy or check the growth and life of bacteria. The process resulting in the formation of nitrates in the soil is spoken of as *nitrification*.

The steps in the breaking down of the highly complex nitrogenous proteid compounds contained in the humus of the soil, or applied to the latter by the farmer in the form of dung and organic refuse generally, are many and varied; most frequently the insoluble proteids are changed by various kinds of putrefactive bacteria into soluble proteids (peptones, &c.), these into simpler amido-bodies, and these again sooner or later into compounds of ammonia. The urea in urine is also rapidly converted by the uro-bacteria into ammonium carbonate. The compounds of ammonia thus formed from the complex substances by many varied kinds of micro-organisms are ultimately oxidized into nitrates. The change takes place in two stages and is effected by two special groups of nitrifying bacteria, which are present in all soils. In the first stage the ammonium compounds are oxidized to nitrites by the agency of very minute motile bacteria belonging to the genus *Nitrosomonas*. The further oxidation of the nitrite to a nitrate is effected by bacteria belonging to the genus *Nitrobacter*.

Several conditions must be fulfilled before nitrification can occur. In the first place an adequate temperature is essential; at 5° or 6° C. (41°-43° F.) the process is stopped, so that it does not go on in winter. In summer, when the temperature is about 24° C. (75° F.), nitrification proceeds at a rapid rate. The organisms do not carry on their work in soils deficient in air; hence the process is checked in water-logged soils. The presence of a base such as lime or magnesia (or their carbonates) is also essential, as well as an adequate degree of moisture: in dry soils nitrification ceases.

It is the business of the farmer and gardener to promote the activity of these organisms by good tillage, careful drainage and occasional application of lime to soils which are deficient in this substance. It is only when these conditions are attended to that decay and nitrification of dung, guano, fish-meal, sulphate of ammonia and other manures take place, and the constituents which they contain become available to the crops for whose benefit they have been applied to the land.

Nitrates are very soluble in water and are therefore liable to be washed out of the soil by heavy rain. They are, however, very readily absorbed by growing plants, so that in summer, when nitrification is most active, the nitrates produced are usually made use of by crops before loss by drainage takes place. In winter, however, and in fallows loss takes place in the subsoil water.

There is also another possible source of loss of nitrates through the activity of denitrifying bacteria. These organisms reduce nitrates to nitrites and finally to ammonia and gaseous free nitrogen which escapes into the atmosphere. Many bacteria are known which are capable of denitrification, some of them being abundant in fresh dung and upon old straw. They can, however, only carry on their work extensively under anaerobic conditions, as in water-logged soils or in those which are badly tilled, so that there is but little loss of nitrates through their agency.

An important group of soil organisms are now known which have the power of using the free nitrogen of the atmosphere for the formation of the complex nitrogenous compounds of which their bodies are largely composed. By their continued action the soil becomes enriched with nitrogenous material which eventually through the nitrification process becomes available to ordinary green crops. This power of "fixing nitrogen," as it is termed, is apparently not possessed by higher green plants. The bacterium, *Clostridium pasteurianum*, common in most soils, is able to utilize free nitrogen under anaerobic conditions, and an organism known as *Azotobacter chroococcum* and some others closely allied to it, have similar powers which they can exercise under aerobic conditions. For the carrying on of their functions they all need to be supplied with carbohydrates or other carbon compounds which they obtain ordinarily from humus and plant residues in the soil, or possibly in some instances from carbohydrates manufactured by minute green algae with which they live in close union. Certain bacteria of the nitrogen-fixing class enter into association with the roots of green plants, the best-known examples being those which are met with in the nodules upon the roots of clover, peas, beans, sainfoin and other plants belonging to the leguminous order.

That the fertility of land used for the growth of wheat is improved by growing upon it a crop of beans or clover has been long recognized by farmers. The knowledge of the cause, however, is due to modern investigations. When wheat, barley, turnips and similar plants are grown, the soil upon which they are cultivated becomes depleted of its nitrogen; yet after a crop of clover or other leguminous plants the soil is found to be richer in nitrogen than it was before the crop was grown. This is due to the nitrogenous root residues left in the land. Upon the roots of leguminous plants characteristic swollen nodules or tubercles are present. These are found to contain large numbers of a bacterium termed *Bacillus radicicola* or *Pseudomonas radicicola*. The bacteria, which are present in almost all soils, enter the root-hairs of their host plants and ultimately stimulate the

production of an excrescent nodule, in which they live. For a time after entry they multiply, obtaining the nitrogen necessary for their nutrition and growth from the free nitrogen of the air, the carbohydrate required being supplied by the pea or clover plant in whose tissues they make a home. The nodules increase in size, and analysis shows that they are exceedingly rich in nitrogen up to the time of flowering of the host plant. During this period the bacteria multiply and most of them assume a peculiar thickened or branched form, in which state they are spoken of as bacteroids. Later the nitrogen-content of the nodule decreases, most of the organisms, which are largely composed of proteid material, becoming digested and transformed into soluble nitrogenous compounds which are conducted to the developing roots and seeds. After the decay of the roots some of the unchanged bacteria are left in the soil, where they remain ready to infect a new leguminous crop.

The nitrogen-fixing nodule bacteria can be cultivated on artificial media, and many attempts have been made to utilize them for practical purposes. Pure cultures may be made and after dilution in water or other liquid can be mixed with soil to be ultimately spread over the land which is to be infected. The method of using them most frequently adopted consists in applying them to the seeds of leguminous plants before sowing, the seed being dipped for a time in a liquid containing the bacteria. In this manner organisms obtained from red clover can be grown and applied to the seed of red clover; and similar inoculation can be arranged for other species, so that an application of the bacteria most suited to the particular crop to be cultivated can be assured. In many cases it has been found that inoculation, whether of the soil or of the seed, has not made any appreciable difference to the growth of the crop, a result no doubt due to the fact that the soil had already contained within it an abundant supply of suitable organisms. But in other instances greatly increased yields have been obtained where inoculation has been practised. More or less pure cultures of the nitrogen-fixing bacteria belonging to the *Azotobacter* group have been tried and recommended for application to poor land in order to provide a cheap supply of nitrogen. The application of pure cultures of bacteria for improving the fertility of the land is still in an experimental stage. There is little doubt, however, that in the near future means will be devised to obtain the most efficient work from these minute organisms, either by special artificial cultivation and subsequent application to the soil, or by improved methods of encouraging their healthy growth and activity in the land where they already exist.

Improvement of Soils.—The fertility of a soil is dependent upon a number of factors, some of which, such as the addition of fertilizers or manures, increase the stock of available food materials in the soil (see MANURE), while others, such as application of clay or humus, chiefly influence the fertility of the land by improving its physical texture.

The chief processes for the improvement of soils which may be discussed here are: liming, claying and marling, warping, paring and burning, and green manuring. Most of these more or less directly improve the land by adding to it certain plant food constituents which are lacking, but the effect of each process is in reality very complex. In the majority of cases the good results obtained are more particularly due to the setting free of "dormant" or "latent" food constituents and to the amelioration of the texture of the soil, so that its aeration, drainage, temperature and water-holding capacity are altered for the better.

The material which chemists call calcium carbonate is met with in a comparatively pure state in chalk. It is present in variable amounts in limestones of all kinds, although its whiteness may there be masked by the presence of iron oxide

Liming.

and other coloured substances. Carbonate of lime is also a constituent to a greater or lesser extent in almost all soils. In certain sandy soils and in a few stiff clays it may amount to less than ¼%, while in others in limestone and chalk districts there may be 50 to 80% present. Pure carbonate of lime when heated loses 44% of its weight, the decrease being due to the loss of carbon dioxide gas. The resulting white product is termed calcium oxide lime, burnt lime, quicklime, cob lime, or caustic lime. This substance absorbs and combines with water very greedily, at the same time becoming very hot, and falling into a fine dry powder, calcium hydroxide or slaked lime, which when left in the open slowly combines with the carbon dioxide of the air and becomes calcium carbonate, from which we began.

When recommendations are made about liming land it is necessary to indicate more precisely than is usually done which of the three classes of material named above—chalk, quicklime or slaked lime—is intended. Generally speaking the oxide or quicklime has a more rapid and greater effect in modifying the soil than slaked lime, and this again greater than the carbonate or chalk.

Lime in whatever form it is applied has a many-sided influence in the fertility of the land. It tends to improve the tilth and the

capillarity of the soil by binding sands together somewhat and by opening up clays. If applied in too great an amount to light soils and peat land it may do much damage by rendering them too loose and open. The addition of small quantities of lime, especially in a caustic form, to stiff greasy clays makes them much more porous and pliable. A lump of clay, which if dried would become hard and intractable, crumbles into pieces when dried after adding to it $\frac{1}{2}$ % of lime. The lime causes the minute separate particles of clay to flocculate or group themselves together into larger compound grains between which air and water can percolate more freely. It is this power of creating a more crumbly tilth on stiff clays that makes lime so valuable to the farmer. Lime also assists in the decomposition of the organic matter or humus in the soil and promotes nitrification; hence it is of great value after green manuring or where the land contains much humus from the addition of bulky manures such as farm-yard dung. This tendency to destroy organic matter makes the repeated application of lime a pernicious practice, especially on land which contains little humus to begin with. The more or less dormant nitrogen and other constituents of the humus are made immediately available to the succeeding crop, but the capital of the soil is rapidly reduced, and unless the loss is replaced by the addition of more manures the land may become sterile. Although good crops may follow the application of lime, the latter is not a direct fertilizer or manure and is no substitute for such. Its best use is obtained on land in good condition, but not where the soil is poor. When used on light dry land it tends to make the land drier, since it destroys the humus which so largely assists in keeping water in the soil. Lime is a base and neutralizes the acid materials present in badly drained meadows and boggy pastures. Weeds, therefore, which need sour conditions for development are checked by liming and the better grasses and clovers are encouraged. It also sets free potash and possibly other useful plant food-constituents of the soil. Liming tends to produce earlier crops and destroys the fungus which causes finger-and-toe or club-root among turnips and cabbages.

Land which contains less than about $\frac{1}{2}$ % of lime usually needs the addition of this material. The particular form in which lime should be applied for the best results depends upon the nature of the soil. In practice the proximity to chalk pits or lime kilns, the cost of the lime and cartage, will determine which is most economical. Generally speaking light poor lands deficient in organic matter will need the less caustic form or chalk, while quicklime will be most satisfactory on the stiff clays and richer soils. On the stiff soils overlying the chalk it was formerly the custom to dig pits through the soil to the rock below. Shafts 20 or 30 ft. deep were then sunk, and the chalk taken from horizontal tunnels was brought to the surface and spread on the land at the rate of about 60 loads per acre. Chalk should be applied in autumn, so that it may be split by the action of frost during the winter. Quicklime is best applied, perhaps, in spring at the rate of one ton per acre every six or eight years, or in larger doses—4 to 8 tons—every 15 to 20 years. Small dressings applied at short intervals give the most satisfactory results. The quicklime should be placed in small heaps and covered with soil if possible until it is slacked and the lumps have fallen into powder, after which it may be spread and harrowed in. Experiments have shown that excellent effects can be obtained by applying 5 or 6 cwt. of ground quicklime.

Gas-lime is a product obtained from gasworks where quicklime is used to purify the gas from sulphur compounds and other objectionable materials. It contains a certain amount of unaltered caustic lime and slacked lime, along with sulphates and sulphides of lime, some of which have an evil odour. As some of these sulphur compounds have a poisonous effect on plants, gas-lime cannot be applied to land directly without great risk or rendering it incapable of growing crops of any sort—even weeds—for some time. It should therefore be kept a year or more in heaps in some waste corner and turned over once or twice so that the air can gain access to it and oxidize the poisonous ingredients in it.

Many soils of a light sandy or gravelly or peaty nature and liable to drought and looseness of texture can be improved by the addition of large amounts of clay of an ordinary character. Similarly soils can be improved by applying to them marl, a substance consisting of a mixture of clay with variable proportions of lime. Some of the chalk marls, which are usually of a yellowish or dirty grey colour, contain clay and 50 to 80% of carbonate of lime with a certain proportion of phosphate of lime. Such a material would not only have an influence on the texture of the land but the lime would reduce the sourness of the land and the phosphate of lime supply one of the most valuable of plant food-constituents. The beneficial effects of marls may also be partially due to the presence in them of available potash.

Typical clay-marls are tenacious, soapy clays of yellowish-red or brownish colour and generally contain less than 50% of lime. When dry they crumble into small pieces which can be readily mixed with the soil by ploughing. Many other kinds of marls are described; some are of a sandy nature, others stony or full of the remains of small shells. The amount and nature of the clay or marl to be added to the soil will depend largely upon the original composition of the latter, the lighter sands and gravel requiring more clay than those

of firmer texture. Even stiff soils deficient in lime are greatly improved in fertility by the addition of marls. In some cases as little as 40 loads per acre have been used with benefit, in others 180 loads have not been too much. The material is dug from neighbouring pits or sometimes from the fields which are to be improved, and applied in autumn and winter. When dry and in a crumbly state it is harrowed and spread and finally ploughed in and mixed with the soil.

On some of the strongest land it was formerly the practice to add to and plough into it burnt clay, with the object of making the land work more easily. The burnt clay moreover carried with it potash and other materials in a state readily available to the crops. The clay is dug from the land or from ditches or pits and placed in heaps of 60 to 100 loads each, with taggot wood, refuse coals or other fuel. Great care is necessary to prevent the heaps from becoming too hot, in which case the clay becomes baked into hard lumps of brick-like material which cannot be broken up. With careful management, however, the clay dries and bakes, becoming slowly converted into lumps which readily crumble into a fine powder, in which state it is spread over and worked into the land at the rate of 40 loads per acre.

The paring and burning of land, although formerly practised as an ordinary means of improving the texture and fertility of arable fields, can now only be looked upon as a practice to be adopted for the purpose of bringing rapidly into cultivation very foul leys or land covered with a coarse turf. The practice is confined to poorer types of land, such as heaths covered with furze and bracken or fens and clay areas smothered with rank grasses and sedges. To reduce such land to a fit state for the growth of arable crops is very difficult and slow without resort to paring and burning. The operation consists of paring off the tough sward to a depth of 1 to 2 in. just sufficient to effectually damage the roots of the plants forming the sward and then, after drying the sods and burning them, spreading the charred material and ashes over the land. The turf is taken off either with the breast plough—a paring tool pushed forward from the breast or thighs by the workman—or with specially constructed paring ploughs or shims. The depth of the sod removed should not be too thick or burning is difficult and too much humus is destroyed unnecessarily, nor should it be too thin or the roots of the herbage are not effectually destroyed.

The operation is best carried out in spring and summer. After being pared off the turf is allowed to dry for a fortnight or so and is then placed in small heaps a yard or two wide at the base, a little straw or wood being put in the middle of each heap, which is then lighted. As burning proceeds more turf is added to the outside of the heaps in such a manner as to allow little access of air. Every care should be taken to burn and char the sod thoroughly without permitting the heap to blaze. The ashes should be spread as soon as possible and covered by a shallow ploughing. The land is then usually sown with some rapidly growing green crop, such as rape, or with turnips.

Paring and burning improves the texture of clay lands, particularly if draining is carried out at the same time. It tends to destroy insects and weeds, and gets rid of acidity of the soil. No operation brings old turf into cultivation so rapidly. Moreover the beneficial effects are seen in the first crop and last for many years. Many of the mineral plant food-constituents locked up in the coarse herbage and in the upper layers of the soil are made immediately available to crops. The chief disadvantage is the loss of nitrogen which it entails, this element being given off into the air in a free gaseous state. It is best adapted for application to clays and fen lands and should not be practised on shallow light sands or gravelly soils, since the humus so necessary for the fertility of such areas is reduced too much and the soil rendered too porous and liable to suffer from drought.

Many thousands of acres of low-lying peaty and sandy land adjoining the tidal rivers which flow into the Humber have been improved by a process termed "warping." The warp consists of fine muddy sediment which is suspended in the tidal-river water and appears to be derived from material scoured from the bed of the Humber by the action of the tide and a certain amount of sediment brought down by the tributary streams which join the Humber some distance from its mouth. The field or area to be warped must lie below the level of the water in the river at high tide. It is first surrounded by an embankment, after which the water from the river is allowed to flow through a properly constructed sluice in its bank, along a drain or ditch to the land which is prepared for warping. By a system of carefully laid channels the water flows gently over the land, and deposits its warp with an even level surface. At the ebb of the tide the more or less clear water flows back again from the land into the main river with sufficient force to clean out any deposit which may have accumulated in the drain leading to the warped area, thus allowing free access of more warpladen water at the next tide. In this manner poor peats and sands may be covered with a large layer of rock soil capable of growing excellent crops.

The amount of deposit laid over the land reaches a thickness of two or three feet in one season of warping, which is usually practised

between March and October, advantage being taken of the spring tides during these months. The new warp is allowed to lie fallow during the winter after being laid out in four-yard "lands" and becomes dry enough to be sown with oats and grass and clover seeds in the following spring. The clover-grass ley is then grazed for a year or two with sheep, after which wheat and potatoes are the chief crops grown on the land.

Green manures are crops which are grown especially for the purpose of ploughing into the land in a green or actively growing state. The crop during its growth obtains a considerable amount of carbon from the carbon dioxide of the air, and builds it up into compounds which when ploughed into the land become humus. The carbon compounds of the latter are of no direct nutritive value to the succeeding crop, but the decaying vegetable tissues very greatly assist in retaining moisture in light sandy soils, and in clay soils also have a beneficial effect in rendering them more open and allowing of better drainage of superfluous water and good circulation of fresh air within them. The ploughing-in of green crops is in many respects like the addition of farm-yard manure. Their growth makes no new addition of mineral food-constituents to the land, but they bring useful substances from the subsoil nearer to the surface, and after the decay of the buried vegetation these become available to succeeding crops of wheat or other plants. Moreover, where deep-rooting plants are grown the subsoil is aerated and rendered more open and suitable for the development of future crops.

The plants most frequently used are white mustard, rape, buck-wheat, spurry, rye, and several kinds of leguminous plants, especially vetches, lupins and serradella. By far the most satisfactory crops as green manures are those of the leguminous class, since they add to the land considerable amounts of the valuable fertilizing constituent, nitrogen, which is obtained from the atmosphere. By nitrification this substance rapidly becomes available to succeeding crops. On the light, poor sands of Saxony Herr Schultz, of Lupitz, made use of serradella, yellow lupins and vetches as green manures for enriching the land in humus and nitrogen, and found the addition of potash salts and phosphates very profitable for the subsequent growth of potatoes and wheat. He estimated that by using leguminous crops in this manner for the purpose of obtaining cheap nitrogen he reduced the cost of production of wheat more than 50%.

The growing crops should be ploughed in before flowering occurs; they should not be buried deeply, since decay and nitrification take place most rapidly and satisfactorily when there is free access of air to the decaying material. When the crop is luxuriant it is necessary to put a roller over it first, to facilitate proper burial by the plough. The best time for the operation appears to be late summer and autumn. (J. PE.)

Soil and Disease.—The influence of different kinds of soil as a factor in the production of disease requires to be considered, in regard not only to the nature and number of the micro-organisms they contain, but also to the amount of moisture and air in them and their capacity for heat. The moisture in soil is derived from two sources—the rain and the ground-water. Above the level of the ground-water the soil is kept moist by capillary attraction and by evaporation of the water below, by rainfall, and by movements of the ground-water; on the other hand, the upper layers are constantly losing moisture by evaporation from the surface and through vegetation. When the ground-water rises it forces air out of the soil; when it falls again it leaves the soil moist and full of air. The nature of the soil will largely influence the amount of moisture which it will take up or retain. In regard to water, all soils have two actions—namely, permeability and absorbability. Permeability is practically identical with the speed at which percolation takes place; through clay it is slow, but increases in rapidity through marls, loams, limestones, chalks, coarse gravels and fine sands, reaching a maximum in soil saturated with moisture. The amount of moisture retained depends mainly upon the absorbability of the soil, and as it depends largely on capillary action it varies with the coarseness or fineness of the pores of the soil, being greater for soils which consist of fine particles. The results of many analyses show that the capacity of soils for moisture increases with the amount of organic substances present; decomposition appears to be most active when the moisture is about 4%, but can continue when it is as low as 2%, while it appears to be retarded by any excess over 4%. Above the level of the ground-water all soils contain air, varying in amount with the degree of looseness of the soil. Some sands contain as much as 50% of air of nearly the same composition as atmospheric air. The oxygen, however, decreases with the depth, while the carbon dioxide increases.

Among the most noteworthy workers at the problems involved in the question of the influence of soil in the production of disease we find von Foder, Pettenkofer, Levy, Fleck, von Naegeli, Schlessing, Muntz and Warrington. The study of epidemic and endemic diseases generally has brought to light an array of facts which very strongly suggest that an intimate association exists between the soil and the appearance and propagation of certain diseases; but although experiments and observations allow this view to be looked upon as well established, still the precise rôle played by the soil in an aetiological respect is by no means so well understood as to make it possible to separate the factors and dogmatize on their effects. The earliest writers upon cholera emphasized its remarkable preference for particular places; and the history of each successive epidemic implies, besides an importation of the contagion, certain local conditions which may be either general sanitary defects or peculiarities of climate and soil. The general evidence indicates that the specific bacteria of cholera discharges are capable of a much longer existence in the superficial soil layers than was formerly supposed; consequently it is specially necessary to guard against pollution of the soil, and through it against the probable contamination of both water and air. The evidence, however, is not sufficiently strong to warrant a universal conclusion, the diffusion of cholera appearing to be largely dependent upon other factors than soil states. Again, all accounts of diphtheria show a tendency on the part of the disease to recur in the same districts year after year. The questions naturally suggest themselves—Are the reappearances due to a revival of the contagion derived from previous outbreaks in the same place, or to some favouring condition which the place offers for the development of infection derived from some other quarter; and have favouring conditions any dependence upon the character and state of the soil? Greenhow in 1858 stated that diphtheria was especially prevalent on cold, wet soils, and Airy in 1881 described the localities affected as "for the most part cold, wet, clay lands." An analysis of the innumerable outbreaks in various parts of Europe indicates that the geological features of the affected districts play a less important part in the incidence of the disease than soil dampness. In this connexion it is interesting to note the behaviour of the diphtheritic contagion in soil. Experiments show that pure cultures, when mixed with garden soil constantly moistened short of saturation and kept in the dark at a temperature of 14° C., will retain their vitality for more than ten months; from moist soil kept at 26° C. they die out in about two months; from moist soil at 30° C. in seventeen days; and in dry soil at the same temperature within a week. In the laboratory absolute soil dryness is as distinctly antagonistic to the vitality of the diphtheria bacillus as soil dampness is favourable. Both statistically and experimentally we find that a damp soil favours its life and development, while prolonged submersion and drought kill it. We may consider that, in country districts, constant soil moisture is one of the chief factors; while in the case of urban outbreaks mere soil moisture is subsidiary to other more potent causes.

Again, many facts in the occurrence and diffusion of enteric fever point to an intimate connexion between its origin and certain conditions of locality. Epidemics rarely spread over any considerable tract of country, but are nearly always confined within local limits. Observations made at the most diverse parts of the globe, and the general distribution area of the disease, show that mere questions of elevation, or even configuration of the ground, have little or no influence. On the other hand, the same observations go to show that the disease is met with oftener on the more recent formations than the older, and this fact, so far as concerns the physical characters of the soil, is identical with the questions of permeability to air and water. Robertson has shown that the typhoid bacillus can grow very easily in certain soils, can persist in soils through the winter months, and when the soil is artificially fed, as may be done by a leaky drain or by access of filthy water from the surface, the micro-organism will take on a fresh growth in the warm season. The destructive power of sunlight is only exercised on those organisms actually at the surface. Cultures of the typhoid organism planted at a depth of 18 in. were found to have grown to the surface. In the winter months the deeper layers of the soil act as a shelter to the organism, which again grows towards the surface during the summer. The typhoid organism was not found to be taken off from the decomposing masses of semi-liquid filth largely contaminated with a culture of *bacillus typhosus*; but, on the other hand, it was abundantly proved that it could grow over moist surfaces of stones, &c. Certain disease-producing organisms, such as the bacillus of tetanus and malignant oedema, appear to be universally distributed in soil, while others, as the *bacillus typhosus* and *spirillum cholerae*, appear to have only a local distribution. The conditions which favour the vitality, growth and multiplication of the typhoid bacillus are the following: the soil should be pervious; it should be permeated with a sufficiency of decaying—preferably animal—organic matters; it should possess a certain amount of moisture, and be subject to a certain temperature. Depriving the organism of any of these essential conditions for its existence in the soil will secure our best weapon for defence. The optimum temperature adapted to its growth and extension is 37° C. = 98° 4 F. Sir Charles Cameron attributes the prevalence of typhoid in certain areas in

Dublin to the soil becoming saturated with faecal matter and specifically infected. The ratio of cases to population living in Dublin on loose porous gravel soil for the ten years 1881-1891 was 1 in 94, while that of those living on stiff clay soil was but 1 in 145. "This is as we should expect, since the movements of ground air are much greater in loose porous soils than in stiff clay soils." A foul gravel soil is a most dangerous one on which to build. For warmth, for dryness, for absence of fog, and for facility of walking after rain, just when the air is at its purest and its best, there is nothing equal to gravel; but when gravel has been rendered foul by infiltration with organic matters it may easily become a very hotbed of disease.

(J. L. N.)

SOISSONS, a city of northern France, in the department of Aisne, 65 m. N.E. of Paris by the railway to Laon. Pop. (1906), 11,586. Soissons, pleasantly situated amongst wooded hills, stands on the left bank of the Aisne, the suburbs of St Vaast and St Médard lying on the right bank. The cathedral of Notre-Dame was begun in the second half of the 12th century and finished about the end of the 13th. It is 328 ft. long and 87 wide, and the vaulting of the nave is 100 ft. above the pavement. The single tower dates from the middle of the 13th century and is an imitation of those of Notre-Dame of Paris, which it equals in height (216 ft.). The south transept, the oldest and most graceful portion of the whole edifice, terminates in an apse. The façade of the north transept dates from the end of the 13th century. The apse and choir retain some fine 13th-century glass. Considerable remains exist of the magnificent abbey of St Jean-des-Vignes, where Thomas Becket resided for a short time. These include the ruins of two cloisters (the larger dating from the 13th century), the refectory, and above all the imposing façade of the church (restored). Above the three portals (13th century) runs a gallery, over which again is a large window; the two unequal towers (230 and 246 ft.) of the 15th and early 16th centuries are surmounted by beautiful stone spires, which command the town. The church of St Léger, which belongs to the 13th century, was formerly attached to an abbey of the Génovéfains. Beneath are two Romanesque crypts. The royal abbey of Notre-Dame, now a barrack, was founded in 660 for monks and nuns by Leutrade, wife of Ebroïn, the celebrated mayor of the palace. The number of the nuns (216 in 858), the wealth of the library in manuscripts, the valuable relics, the high birth of the abbesses, the popularity of the pilgrimages, all contributed to the importance of this abbey, of which there exist only inconsiderable remains. The wealthiest of all the abbeys in Soissons, and one of the most important of all France during the first two dynasties, was that of St Médard, on the right bank of the Aisne, founded about 560 by Clotaire I., beside the villa of Syagrius, which had become the palace of the Frankish kings. St Médard, apostle of Vermandois, and kings Clotaire and Sigebert, were buried in the monastery, which became the residence of 400 monks and the meeting-place of several councils. It was there that Childeric III., the last Merovingian, was deposed and Pippin the Short was crowned by the papal legate, and there Louis the Pious was kept in captivity in 833. The abbots of St Médard coined money, and in Abelard's time (12th century) were lords of 220 villages, farms and manors. At the battle of Bouvines (1214) the abbot commanded 150 vassals. In 1530 St Médard was visited by a procession of 300,000 pilgrims. But the religious wars ruined the abbey, and, although it was restored by the Benedictines in 1637, it never recovered its former splendour. Of the churches and the conventual buildings of the ancient foundation there hardly remains a trace. The site is occupied by a deaf and dumb institution, the chapel of which stands over the crypt of the great abbey church, which dates from about 840. In the crypt is a stone coffin, said to have been that of Childebert II., and close at hand is an underground chamber, reputed to have been the place of captivity of Louis the Pious.

The civil buildings of the town are not of much interest. The hôtel-de-ville contains a library and a museum with collections of paintings and antiquities. The foundation of the hôtel-dieu dates back to the 13th century. The town has a large botanical garden. Soissons is the seat of a bishop and a subprefect, and has tribunals of first instance and of commerce,

a communal college and higher ecclesiastical seminary. Among the industrial establishments are iron and copper foundries, and factories for the production of boilers, agricultural implements and other iron goods, straw hats, glass and sugar. Grain, haricot beans of exceptional quality, and timber are the principal articles of trade.

Soissons is generally identified with the oppidum of Gallia Belgica, called *Noviodunum* by Caesar. Noviodunum was the capital of the Suessiones, who occupied twelve towns, and whose king, Divitiacus, one of the most powerful in Gaul, had extended his authority even beyond the sea among the Britons. In 58 B.C. Galba, king of the Suessiones, separated from the confederation of the Belgians and submitted to the Romans. At the beginning of the empire Noviodunum took the name of *Augusta Suessionum*, and afterwards that of *Suessiona*, and became the second capital of Gallia Belgica, of which Reims was the metropolis. The town was before long surrounded with a regular wall and defended by a citadel, and it became the starting-point of several military roads (to Reims, Château-Thierry, Meaux, Paris, Amiens and St Quentin). Christianity was introduced by St Crispin and St Crispinian, men of noble birth, who, however, earned their livelihood by shoemaking, and thus became patrons of that craft. After their martyrdom in 297 their work was continued by St Sinitius, the first bishop of Soissons. After the barbarians had crossed the Rhine and the Meuse Soissons became the metropolis of the Roman possessions in the north of Gaul, and on the defeat of Syagrius by Clovis the Franks seized the town. It was at Soissons that Clovis married Clotilde, and, though he afterwards settled at Paris, Soissons was the capital of his son Clotaire, and afterwards of Chilperic I., king of Neustria. It was not till the time of Chilperic's son, Clotaire II., that the kingdom of Soissons was incorporated with that of Paris. Pippin the Short was at Soissons proclaimed king by an assembly of *leudes* and bishops, and he was there crowned by the papal legate, St Boniface, before being crowned at Saint Denis by the pope himself. Louis the Pious did penance there after being deposed by the assembly at Compiègne. Under Charles the Fat (886) the Normans failed in an attempt against the town, but laid waste St Médard and the neighbourhood. In 923 Charles the Simple was defeated outside the walls by the supporters of Rudolph of Burgundy, and Hugh the Great besieged and partly burned the town in 948. Under the first Capets Soissons was held by hereditary counts (see below), frequently at war with the king or the citizens. The communal charter of the town dates from 1131. At a synod held at Soissons in 1121 the teachings of Abélard were condemned, and he was forced to retract them. In 1155, at an assembly of prelates and barons held at Soissons, Louis VII. issued a famous decree forbidding all private wars for a space of ten years; and in 1325 Charles the Fair replaced the mayor of Soissons by a royal provost dependent on the bailiwick of Vermandois, the inhabitants retaining only the right of electing four *échevins*. The town had to suffer severely during the war of the Hundred Years; in 1414, when it was held by the Burgundians, it was captured and sacked by the Armagnacs under the dauphin; and this same fate again befell it several times within twenty years. The Treaty of Arras (1435) brought it again under the royal authority. It was sacked by Charles V. in 1544 and in 1565 by the Huguenots, who laid the churches in ruins, and, supported by the prince of Condé, count of Soissons, kept possession of the town for six months. During the League Soissons eagerly joined the Catholic party. Charles, duke of Mayenne, made the town his principal residence, and died there in 1611. A European congress was held there in 1728. In 1814 Soissons was captured and recaptured by the allies and the French. In 1815, after Waterloo, it was a rallying point for the vanquished, and it was not occupied by the Russians till the 14th of August. In 1870 it capitulated to the Germans after a bombardment of three days.

COUNTS OF SOISSONS.—In the middle ages Soissons was the chief town of a countship belonging in the 10th and 11th centuries to a family which apparently sprang from the

counts of Vermandois. Renaud, count of Soissons, gave his property in 1141 to his nephew Yves de Nesle. By successive marriages the countship of Soissons passed to the houses of Hainaut, Châtillon-Blois, Coucy, Bar and Luxemburg. Marie de Luxemburg brought it, together with the counties of Marle and St Pol, to Francis of Bourbon, count of Vendôme, whom she married in 1487. His descendants, the princes of Condé, held Soissons and gave it to their cadets. Charles of Bourbon, count of Soissons (1566-1612), son of Louis, prince of Condé, whose political vacillations were due to his intrigues with Henry IV.'s sister Catherine, became grand master of France and governor of Dauphiné and Normandy. His son, Louis of Bourbon (1604-1641), took part in the plots against Marie de Medicis and Richelieu, and attempted to assassinate Richelieu. He had only one child, a natural son, known as the Chevalier de Soissons. The countship passed to the house of Savoy-Carignan by the marriage in 1625 of Marie de Bourbon-Soissons with Thomas Francis of Savoy. Eugène Maurice of Savoy, count of Soissons (1635-1673), married the beautiful and witty Olympia Mancini, a niece of Cardinal Mazarin, and obtained high military posts through his wife's influence. He defeated the Spaniards at the battle of the Dunes in 1658; took part in the campaigns at Flanders (1667), Franche-Comté (1668) and Holland (1672); and was present as ambassador extraordinary of France at the coronation of Charles II. of England. His wife led a scandalous life, and was accused of poisoning her husband and others. She was the mother of Louis Thomas Amadeus, count of Soissons, and of the famous Prince Eugène of Savoy. In 1734 the male line of the family of Savoy-Soissons became extinct, and the heiress, the princess of Saxe-Hildburghausen, ceded the countship of Soissons to the house of Orleans, in whose possession it remained until 1780.

SOKE (O. Eng. *soc*, connected ultimately with *secan*, to seek), a word which at the time of the Norman Conquest generally denoted jurisdiction, but was often used vaguely and is probably incapable of precise definition. In some cases it denoted the right to hold a court, and in others only the right to receive the fines and forfeitures of the men over whom it was granted when they had been condemned in a court of competent jurisdiction. Its primary meaning seems to have been "seeking"; thus "soka faldæ" was the duty of seeking the lords court, just as "secta ad molendinum" was the duty of seeking the lords mill. The "Leges Henrici" also speaks of pleas "in socna, id est, in quaestione sua"—pleas which are in his investigation. It is evident, however, that not long after the Norman Conquest considerable doubt prevailed about the correct meaning of the word. In some versions of the much used tract *Interpretationes uocabulorum* soke is defined "aver fraunc court," and in others as "interpellacio maioris audientiae," which is glossed somewhat ambiguously as "claim a justis et requeste." Soke is also frequently associated to "sak" or "sake" in the alliterative jingle "sake and soke," but the two words are not etymologically related. "Sake" is the Anglo-Saxon "sacu," originally meaning a matter or cause (from *sacan*, to contend), and later the right to have a court. Soke, however, is the commoner word, and appears to have had a wider range of meaning. The term "soke," unlike "sake," was sometimes used of the district over which the right of jurisdiction extended.

Mr Adolphus Ballard has recently argued that the interpretation of the word "soke" as jurisdiction should only be accepted where it stands for the fuller phrase, "sake and soke," and that soke standing by itself denoted services only. There are certainly many passages in Domesday Book which support his contention, but there are also other passages in which soke seems to be merely a short expression for "sake and soke." The difficulties about the correct interpretation of these words will probably not be solved until the normal functions and jurisdiction of the various local courts have been more fully elucidated.

"The sokemen" were a class of tenants, found chiefly in the eastern counties, occupying an intermediate position between

the free tenants and the bond tenants or villains. As a general rule they were personally free, but performed many of the agricultural services of the villains. It is generally supposed they were called sokemen because they were within the lord's soke or jurisdiction. Mr Ballard, however, holds that a sokeman was merely a man who rendered services, and that a sokeland was land from which services were rendered, and was not necessarily under the jurisdiction of a manor. The law term, socage, used of this tenure, is a barbarism, and is formed by adding the French *age* to *soc*.

See F. W. Maitland, *Domesday Book and Beyond*; J. H. Round, *Feudal England*; F. H. Baring, *Domesday Tables*; A. Ballard, *The Domesday Inquest*; J. Tait, review of the last-mentioned book in *English Historical Review* for January 1908; *Red Book of the Exchequer* (Rolls Series), iii. 1035.
(G. J. T.)

SOKOTO, an important Fula state of west central Sudan, now a province of the British protectorate of Nigeria. The sultan of Sokoto throughout the 19th century exercised an overlordship over the Hausa states extending east from the Niger to Bornu and southward to the Benue and Adamawa. These states and Sokoto itself, known variously as the Sokoto or Fula empire and Hausaland, came (c. 1900-1903) under direct British control, but the native governments are maintained. The province of Sokoto occupies the north-west corner of the British protectorate, and is bounded west and north by French territory. South and east it adjoins other parts of the British protectorate. Bordering north on the Sahara, it contains much arid land, but south-west the land is very fertile. Running through it in a south-westerly direction is the Gublin Kebbi or Sokoto river, which joins the Niger in 11½° N. 4° E. On a tributary of this river is the town of Sokoto.

The Sokoto or Fula empire was founded at the beginning of the 19th century. The country over which the Fula ruled has, however, a history going back to the middle ages. Between the Niger and the kingdom of Bornu (*q.v.*) the country was inhabited by various black tribes, of whom the Hausa occupied the plains. Under the influence of Berber and Arab tribes, who embraced Mahomedanism, the Hausa advanced in civilization, founded large cities, and developed a considerable trade, not only with the neighbouring countries, but, via the Sahara, with the Barbary states. The various kingdoms which grew up round each large town had their own rulers, but in the first half of the 16th century they all appear to have owned the sway of the Songhoi kings (see ТИМБУКТУ). On the break up of the Songhoi empire the north-eastern part of Hausaland became more or less subject to Bornu, whose sultans in the 17th century claimed to rule over Katsena and Kano. In this century arose a dynasty of the Habé, a name now believed to be identical with Hausa, who obtained power over a large area of the northern portion of the present British protectorate. The Hausa, whose conversion to Mahomedanism began in the 12th century, were still in the 18th century partly pagans, though their rulers were followers of the Prophet. These rulers built up an elaborate system of government which left a considerable share in the management of affairs to the body of the people. Dwelling among the Hausa were a number of Fula, mostly herdsmen, and these were devout Mahomedans. One of the more cultivated teachers of this race, named Othman Dan Fodio, had been tutor to the king of Gobir (a district north of **Establishment of Fula Rule**). He incurred the wrath of that king, who, angered at some act of defiance, ordered the massacre of every Fula in his dominions. The Fula flocked to Fodio's aid, and in the battle of Koto or Rugga Fakko (1804) the king of Gobir was utterly defeated. Thereupon Fodio unfurled the green banner of Mahomet and preached a *jihad* or religious war. In a few years the Fula had subdued most of the Hausa states, some, like Kano, yielding easily in order to preserve their trade, others, like Katsena, offering a stubborn resistance. Gobir and Kebbi remained unconquered, as did the pagan hill tribes. The Fula were also defeated in their attack on Bornu. In most places they continued the system of government which had grown up under the Habé, the chiefs or emirs of the various

states being, however, tributary to Dan Fodio. This sheik established himself at Sokoto, and with other titles assumed that of Sarikin Muslimin (king of the Mahommedans). As such he became the recognized spiritual head of all the Mahommedans of west central Sudan, a headship which his successors retained unimpaired, even after the loss of their temporal position to the British in 1903. On the death of Fodio (c. 1819) the empire was divided between a son and a brother, the son, famous under the name of Sultan Bello, ruling at Sokoto, the brother at Gando. All the other Fula emirs were dependent on these two sultanates. The Fula power proved, before many years had gone by, in many respects harmful to the country. This was especially the case in those districts where there was a large pagan population. Slave-raiding was practised on a scale which devastated and almost depopulated vast regions and greatly hampered the commercial activity of the large cities, of which Zaria and Kano were the most important. The purity of the ancient administration was abandoned. The courts of justice became corrupt, administrative power was abused and degenerated into a despotism controlled only by personal considerations, oppressive taxes destroyed industry and gradually desolated the country. Soon after the Fula had established themselves Europeans began to visit the country. Hugh Clapperton, an Englishman, was at Sokoto in 1823 and again in 1827, dying there on the 13th of April of that year. Heinrich Barth made a prolonged stay in various Hausa cities at dates between 1851 and 1855. To Barth is due a great deal of our knowledge of the country. In Barth's time American merchants were established on the Niger, bartering goods in exchange for slaves. This traffic was carried on through Nupe "to the great damage," says Barth, "of the commerce and the most unqualified scandal of the Arabs, who think that the English, if they would, could easily prevent it." The over-seas traffic in slaves did not continue long after the date (1851) to which Barth referred, but slave-raiding by the Fula went on unchecked up to the moment of the British occupation of the country. At Sokoto the sultanate continued in the hands of Fodio's descendants, and the reigning sultan concluded in 1885 a treaty with the Royal Niger Company (then called the National African Company) which gave to the company certain rights of sovereignty throughout his dominions.

In 1900 the rights of the company were transferred to the Crown. In the course of the years 1900, 1901, 1902, British authority was established in the states bordering on the Niger and the Benue and in Bornu. The northern states declined to fulfil the conditions of the treaties negotiated with the Niger Company or to submit to the abolition of the slave trade, and in 1902 Sokoto and Kano openly defied the British power. A campaign was undertaken against them in the opening months of 1903 in which the British troops were entirely successful. Kano was taken in February 1903, and Sokoto after some resistance made formal submission on the 22nd of March following. From that day British authority was substituted for Fula authority throughout the protectorate. The emir of Sokoto took an oath of allegiance to the British Crown and Sokoto became a British province, to which at a later period Gando was added as a sub-province—thus making of Sokoto one of the double provinces of the protectorate.

The double province thus constituted has an area of about 35,000 sq. m., with an estimated population of something over 500,000. It includes the ancient kingdoms of Zamfara on the east and Argunga or Kebbi on the west. The dominions of the emir of Sokoto have suffered some diminutions by reason of British agreements with France relating to the common frontier of the two European powers in the western Sudan. The emir felt deeply the loss of territory ceded to France in 1904 but accepted the settlement with much loyalty. Like the emir of Kano the new emir of Sokoto worked most loyally with the British administration. The province has been organized on the same principle as the other provinces of Northern Nigeria. A British resident of the first class has been placed at Sokoto and

assistant residents at other centres. British courts of justice have been established and British governors are quartered in the province. Detachments of civil police are also placed at the principal stations. The country has been assessed under the new system for taxes and is being opened as rapidly as possible for trade. After the establishment of British rule farmers and herdsmen reoccupied districts and the inhabitants of cities flocked back to the land, rebuilding villages which had been deserted for fifty years. Horse breeding and cattle raising form the chief source of wealth in the province. There is some ostrich farming. Except in the sandy areas there is extensive agriculture, including rice and cotton. Special crops are grown in the valleys by irrigation. Weaving, dyeing and tanning are the principal native industries. Fair roads are in process of construction through the province. Trade is increasing and a cash currency has been introduced.

The emir of Gando, treated on the same terms as the emirs of Kano and Sokoto, proved less loyal to his oath of allegiance and had to be deposed. Another emir was installed in his place and in the whole double province of Sokoto-Gando prosperity has been general. In 1906 a rising attributed to religious fanaticism occurred near Sokoto in which unfortunately three white officers lost their lives. The emir heartily repudiated the leader of the rising, who claimed to be a Mahdi inspired to drive the white man out of the country. A British force marched against the rebels, who were overthrown with great loss in March 1906. The leader was condemned to death in the emir's court and executed in the market place of Sokoto, and the incident was chiefly interesting for the display of loyalty to the British administration which it evoked on all sides from the native rulers. (See also NIGERIA; FULA; and HAUSA.)

See the *Travels of Dr Barth* (London 1857); Lady Lugard, *A Tropical Dependency* (London, 1905); P. L. Monteil, *De Saint Louis à Tripoli par le lac Tchad* (Paris, 1895); C. H. Robinson, *Hausaland* (London, 1896); *The Annual Reports on Northern Nigeria*, issued since 1900 by the Colonial Office, London; Sir F. D. Lugard, "Northern Nigeria," in *Geo. Journ.* vol. xxiii., and Major J. A. Burdon, "The Fulani Emirates," *ibid.* vol. xxiv. (both London, 1904). Except the last-named paper most of these authorities deal with many other subjects besides the Fula. (F. L. L.)

SOKOTRA (also spelt Socotra and formerly Socotora), an island in the Indian Ocean belonging to Great Britain. It is cut by 12° 30' N., 54° E., lies about 130 m. E.N.E. of Cape Guardafui and about 190 m. S.E. of the nearest part of the coast of Arabia and is on the direct route to India by the Suez Canal. It is 72 m. long by 22 m. broad and has an area estimated at from 2000 to 3000 sq. m. It is the largest and most easterly member of a group of islands rising from adjacent coral banks, the others being Abd el Kuri, The Brothers (Semha and Darzi), and Kal Farun.

Physical Features.—From the sea Sokotra has an imposing appearance. The centre culminates in a series of rugged pinnacles—the Haghier mountains, which rise to nearly 5000 ft. above a high (1500 ft.) abutting and undulating limestone plateau, deeply channelled by valleys. At many parts of the north coast the edges of this plateau reach the shore in precipitous cliffs, but in others low plains, dotted with bushes and date-palms, front the heights behind. The southern shore is bordered nearly its entire length by a belt of drifted sand, forming the Nuget plain. On this side of the island there are but one or two possible anchoring grounds, and these only during the north-east monsoon. On the north coast there are no harbours; but fairly safe anchorages, even in the north-east winds, are available off Hadibu or under Haulaf, a few miles distant, and at Kallansayia, at the north-west end of the island.

Geology.—The fundamental rocks of the island are gneisses, through which cut the feldspathic granites which form the Haghier *massif*. Through these, again, pierce other granites in dikes or lava flows, and overlying the whole are limestones of Cretaceous and Tertiary age, themselves cut through by later volcanic eruptions. "In the Haghier hills," to quote Professor Bonney, "we have probably a fragment of a continental area of great antiquity, and of a land surface which may have been an 'ark of refuge' to a terrestrial fauna and flora from one of the very earliest periods of this world's history."

Climate.—From October to May the weather is almost rainless except in the mountains, where there are nightly showers and heavy mists. During this season the rivers, which are roaring torrents throughout the monsoon, are almost all lost in the dry, absorbent

plains. The temperature of the coast area varies from 65° F. in the night to 85° F. in the day—in the hot season it may reach 95° F.; and on the mountains (3500 ft.), from 52° F. to 72° F. In the low grounds fever of an acute and hematuric form is very prevalent.

Flora and Fauna.—The fauna contains no indigenous mammals, a wild ass which roams the eastern plains, perhaps its oldest denizen, is probably of Nubian origin; while the domestic cattle, a peculiar, unhumped, small, shapely, Alderney-like breed, may be a race gradually developed from cattle imported at a distant period from Sind or Farther India. There are 67 species of birds known from Sokotra, of which 15 are endemic; of 22 reptiles, 3 genera and 14 species are peculiar; and of the land and fresh-water shells, to whose distribution great importance attaches, 44 species out of 47 are confined to the island. Among the other invertebrate groups there is also a large proportion of endemic species.

The flora is even more peculiar than the fauna. Aloes, dragon's-blood (*Dracaena*), myrrh, frankincense, pomegranate, and cucumber (*Dendrocycios*) trees are its most famous species. The phanerogams number 570, apportioned to 314 genera, and of these over 220 species and 98 genera are unknown elsewhere. The flora and also (though to a less degree) the fauna present not only Asian and Central African affinities, but, what is more interesting, Mascarene, South African and Antipodean-American relationships, indicating a very different distribution of land and water and necessitating other bridges of communication than now exist. The natural history of Sokotra, unravelled by the study of its geology and biology, has been summarized by Professor Balfour as follows:—

"During the Carboniferous epoch there was in the region of Sokotra a shallow sea, in which was deposited, on the top of the fundamental gneisses of this spot, . . . the sandstone of which we have such a large development in Nubia. . . . During the Permian epoch Sokotra may have been a land surface, forming part of the great mass of land which probably existed in this region at that epoch, and gave the wide area for the western migration of life which presently took place, and by which the eastern affinities in Sokotra may be explained. In early and middle Tertiary times, when the Indian peninsula was an island, and the sea which stretched into Europe washed the base of the Himalayan hills, Sokotra was in great part submerged and the great mass of limestone was deposited; but its higher peaks were still above water, and formed an island, peopled mainly by African species—the plants being the fragmentary remains of the old African flora—but with an admixture of eastern and other Asian forms. Thereafter it gradually rose, undergoing violent volcanic disturbance."

By this elevation "Madagascar would join the Seychelles, which in turn . . . would run into the larger Mascarene Islands. In this way, then, Africa would have an irregular coast-line, prolonged greatly south of the equator into the Indian Ocean, and running up with an advance upon the present line until it reached its north-west limit outside and south of Sokotra. Thence an advanced land surface of Asia would extend across the Arabian Sea into the Indian peninsula." Sokotra thus "again became part of the mainland, though it is likely for only a short period, and during this union the life of the adjacent continent covered its plains and filled its valleys. Subsequently it reverted to its insular condition, in which state it has remained." The Antipodean-American element in the Sokotran flora probably arrived via the Mascarene Islands or South Africa from a former Antarctic continent.

Inhabitants.—The inhabitants, believed to number from 10,000 to 12,000, are composed of two, if not more, elements. On the coast the people are modern Arabs mixed with negro, Indian and European blood; in the mountains live the true Sokotri, supposed to be originally immigrants from Arabia, who have been isolated here from time immemorial. Some of them are as light-skinned as Europeans, tall, robust, thin-lipped, straight-nosed, with straight black hair; others are shorter and darker in complexion, with round heads, long noses, thick lips, and scraggy limbs, indicating perhaps the commingling of more than one Semitic people. Their manner of life is simple in the extreme. Their dwellings are circular, rubble-built, flat, clay-topped houses, or caves in the limestone rocks. They speak a language allied to the Mahra of the opposite coast of Arabia. Both Mahra and Sokotri are, according to Dr H. Müller, daughter-tongues of the old Sabaeen and Minaean, standing in the same relation to the speech of the old inscriptions as Coptic does to that of the hieroglyphics. The Sokotran tongue has been, he believes, derived from the Mahra countries, but it has become so differentiated from the Mahra that the two peoples understand each other only with difficulty. Sokotri is the older of the two languages, and retains the ancient form, which in the Mahran has been modified by Arabic and other influences. Hadibu, Kallansayia and Khadup are the only places of importance in the island. Hadibu, or Tamarida (pop. about 400) the capital, is picturesquely situated on the north coast at the head of the open bay of Tamarida on a semicircular plain enclosed by spurs of the Haghier mountains. A dense grove of date palms surrounds the village.

Trade and Products.—The chief export is ghi or clarified butter, which is sent to Arabia, Bombay and Zanzibar. Millet, cotton and tobacco are grown in small quantities. The most valuable vegetable products are aloes and the dragon's-blood tree. The Sokotran aloe

is highly esteemed; in the middle ages the trade was mostly in these products and in ambergris. The people live mainly on dates and milk. They own large numbers of cattle, sheep and goats. Dates are both home-grown and imported.

History.—Sokotra has claims to be reckoned one of the most ancient incense-supplying countries. Among the "harbours of incense" exploited by various Pharaohs during some twenty-five centuries it is impossible to believe that the island could be missed by the Egyptian galleys on their way to the "Land of Punt," identified by several writers with Somaliland; nor that, though the roadsteads of the African coast were perhaps oftener frequented, and for other freights besides myrrh and frankincense, the shores of Sokotra were neglected by such ardent explorers as those, for instance, of Queen Hatshepsut of the 18th dynasty. They would have found on the island, which is probably referred to under the name "Terraces of Incense" (from its step-like contours), the precious "auta trees"—whose divine dew, for use in the service of their gods, was their special quest—in greater abundance and in a larger number of species than any other country.

To the Greeks and Romans Sokotra was known as the isle of Dioscorides; this name, and that by which the island is now known, are usually traced back to a Sanskrit form, *Dvīpa-Sak-hādhāra*, "the island abode of bliss," which again suggests an identification with the *νησοὶ εὐδαιμονες* of Agatharchides (§ 103). The *Periplus* of the Erythraean Sea speaks of the island as peopled only in one part by a mixed race of Arab, Indian and Greek traders. It was subject to the king of the Incense Country, and was a meeting-place of Arabian and Indian ships. Cosmas in the 6th century says that the people spoke Greek and were largely Christian, with a bishop sent from Persia. The Arab geographers also had a tradition of an early Greek settlement (which they ascribe to Alexander), but also of later Persian influence, followed by a settlement of Mahra tribes, who partly adopted Christianity. The Sokotri appear to have remained Nestorian Christians, with a bishop under the metropolitan of Persia, through the middle ages, though there are indications pointing to a connexion with the Jacobite church. As early as the 10th century Sokotra was a haunt of pirates; in the 13th century Abulfeda describes the inhabitants as "Nestorian Christians and pirates" but the island was rather a station of the Indian corsairs who harassed the Arab trade with the Far East. The population seems in the middle ages to have been much larger than it is now; Arabian writers estimate the fighting men at 10,000.

The Portuguese under Tristão da Cunha and Albuquerque seized Sokotra in 1507 in pursuance of the design to control all the trade routes between Europe and the East, Sokotra being supposed to command the entrance to the Red Sea. But on the capture of Goa and the building of a fortress there Albuquerque caused the fort which da Cunha had had built at Coco (Tamarida) to be dismantled (1511), and though Portuguese ships subsequently raided the island they made no other settlement on it. The Portuguese found that Sokotra was held by Arabs from Fartak, but the "natives" (a different race) were Christians, though in sad need of conversion. This pious work Portuguese priests attempted, but with scant success. However, as late as the middle of the 17th century the Carmelite P. Vincenzo found that the people still called themselves Christians, and had a strange mixture of Jewish, Christian and Pagan rites. The women were all called Maria. No trace of Christianity is now found in the island, all the inhabitants professing Islam.

A certain dependence (at least of places on the coast) on some sovereign of the Arabian coast had endured before the occupation of Tamarida by da Cunha, and on the withdrawal of the Portuguese this dependence on Arabia was resumed. In the 19th century Sokotra formed part of the dominions of the sultan of Kishin. The opening of the Suez Canal route to India led to the island being secured for Great Britain. From 1876 onward a small subsidy has been paid to the sultan of Kishin by the authorities at Aden; and in 1886 the sultan concluded

a treaty formally placing Sokotra and its dependencies under the protection of Great Britain. Sokotra is regarded as a dependency of Aden, but native rule is maintained, the local governor or viceroy of the sultan of Kishin being a member of that chief's family, and also styled sultan. Since it came under British control the island has been visited by various scientific expeditions. Professor Bayley Balfour made an investigation in 1880, expeditions were headed by Drs Riebeck and Schweinfurth in 1881, by Theodore Bent in 1897, and by Dr H. O. Forbes and Mr Ogilvie-Grant (who also visited Abd-el-Kuri) in 1898-1899. Simultaneously with the last named a further expedition, conducted by Professor D. H. Müller, under the auspices of the Imperial Academy of Sciences of Vienna, visited Sokotra, Abd-el-Kuri and some other islets of the group to investigate their geology and languages. With the Indian government the relations of the Sokotri have occasionally been strained, owing to their piratical tendencies.

ABD-EL-KURI island lies 60 m. W.S.W. of Sokotra, and 53 m. E.N.E. from Cape Guardafui, is 20 m. long by 3½ m. in width. At either end the island is hilly, the central part being a low plateau. On the north side is a sandy beach; on the south cliffs rise abruptly from the ocean. The highest part of the island is towards its eastern end, where the hills rise to 1670 ft. It is largely arid and there are no permanent streams. Its zoology resembles that of Sokotra, but the fauna includes land shells and scorpions peculiar to Abd-el-Kuri. The inhabitants, who number one to two hundred, speak Sokotri and Arabic and are chiefly engaged in diving for pearl shell on the Bacchus Bank N.E. of the island. They live chiefly on turtle (which abounds in the island), fish and molluscs. The land is nowhere cultivated.

Kal Farun is the name of two rocky islets rising nearly 300 ft. above the sea 13 m. N.N.E. of the western end of Abd-el-Kuri. Birds flock to them in great numbers; in consequence they are completely covered with guano, which gives them a snow-white appearance. The Brothers (often called by the older navigators The Sisters) lie between Abd-el-Kuri and Sokotra. Semha is 6½ m. long and 3 m. broad. It has rocky shores and rises in a table-shaped mountain to 2440 ft. As in Abd-el-Kuri ambergis is found on its shores and turtles abound. There is running water all the year. It is a fishing ground of the Sokotri. Darzi lies 9 m. E. by S. of Semha, is 3½ m. long by 1 m. broad and rises almost perpendicularly from the sea to 1500 ft. The top is flat. The coral banks which surround Sokotra and The Brothers are united and are not more than 30 fathoms below sea-level; a valley some 100 fathoms deep divides them from the bank around Abd-el-Kuri, while between Abd-el-Kuri and Cape Guardafui are depths of over 500 fathoms.

See, for the history of Sokotra, Yule, *Marco Polo* (1903 ed.) ii. 406-410, and, besides the authorities there cited, Yakut, *s.v.*; Hamdāni p. 52; Kazwini ii. 54. Consult also the *Commentaries of Afonso Dalboquerque*, W. de G. Birch's translation (London 1875-1884). For the state of the island at the beginning of the 18th century see the account of the French expedition to Yemen in 1708 (*Viaggio nell' Arabia Felice*: Venice, 1721); and, for the 19th century, J. R. Wellsted, *City of the Caliphs*, vol. ii. (London, 1840), and Mrs J. T. Bent, *Southern Arabia, Soudan and Sokotra* (London, 1900). For the topography, &c., see *Red Sea and Gulf of Aden Pilot* (5th ed. London, 1900). For special studies see I. B. Balfour, *Botany of Sokotra* (Edinburgh, 1888); G. Schweinfurth, *Das Volk von Sokotra* (Leipzig, 1883); H. O. Forbes (edited by), *The Natural History of Sokotra and Abd-el-Kuri* (Liverpool, 1903); F. Kossmat, *Geologie der Inseln Sokotra, Semha und Abd el Kuri* (Vienna, 1902); R. V. Wettstein in *Vegetationsbilder* (3rd series, 5th pt., Jena, 1906). See also J. Jackson, *Socotra, Notes bibliographiques* (Paris, 1892), a complete bibliography to the year of publication. (H. O. F.; X.)

SOLANACEAE, in botany, an order of Dicotyledons belonging to the sub-class Sympetalae (or Gamopetalae) and to the series Tubiflorae, containing 75 genera with about 1500 species, widely distributed through the tropics, but passing into the temperate zones. The chief centre of the order lies in Central and South America; 32 of the genera are endemic in this region. It is represented in Britain by three genera including 4 species: *Hyoscyamus niger* (henbane), *Solanum Dulcamara* (Bittersweet) and *S. nigrum* and *Atropa Belladonna* (Deadly Nightshade).

The plants are herbs, shrubs or small trees. *Solanum nigrum*, a common weed in waste places, is a low-growing annual herb; *S. Dulcamara* is an irregularly climbing herb perennial by means of a widely creeping rhizome; *Atropa Belladonna* is a large perennial herb. The genus *Solanum*, to which belong more than half the number of species in the order, contains plants of very various habits including besides herbs, shrubs and trees. The leaves are generally alternate, but in the flower-bearing parts of the stem are

often in pairs, an arrangement which, like the extra-axillary position of the flowers or cymes, results from a congenital union of axes. Thus in *Datura* (thorn apple) (fig. 1 A), where the branching is dichasial, the leaf which originates at any given node becomes

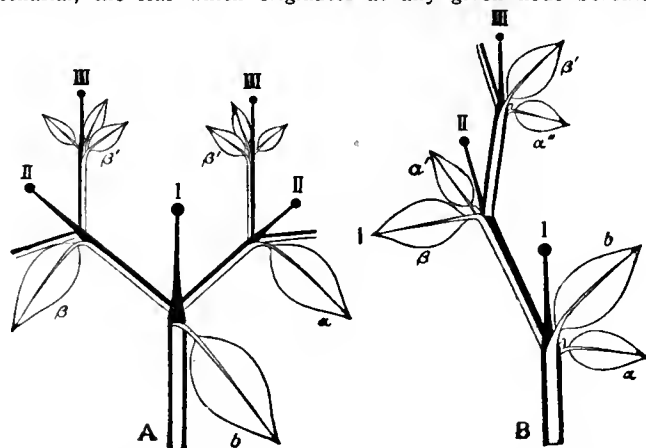

FIG. 1.—Diagrams illustrating branch development in Solanaceae, in A. *Datura Stramonium*, B. *Atropa Belladonna*.

I, II, III, Flowers on inflorescences of successive orders; b, bract of I; a, b, bracts of II; a', b', bracts of III, and so on. In A the branching is dichasial and the bracts are adnate to their axillary shoots up to the points at which the next branches arise; thus a and b appear to arise from axis II, though in reality originating on axis I. In B the branching is cincinnal, one of the two branches at each node is undeveloped and its bract a, a', a'' is smaller than the other member of the pair, b, b', which is adnate to and apparently carried up on its axillary branch.

raised upon its axillary shoot as far as the next higher node, from which it appears to spring. In *Atropa Belladonna* (fig. 1 B) one of the branches at each node is undeveloped and there is a pair of unequal leaves; the smaller subtends the branch which has not developed, the larger has been carried up from the node below.

An interesting anatomical feature is the presence in the stem of bicollateral bundles—that is, the vascular bundles have phloem on the inside as well as on the outside of the xylem.

The hermaphrodite, generally regular, flowers have the parts in fives, 5 sepals, 5 petals, 5 stamens in alternating whorls, and two carpels, which are generally placed obliquely (see fig. 2, floral diagram). The sepals persist and often become enlarged in the fruit. The



FIG. 2.—Floral diagram of *Solanum*—the arrow indicates the oblique symmetry of the flower.



FIG. 3.—Floral diagram of *Schizanthus*—the arrow indicates the oblique symmetry. Two stamens only are functional.

corolla is regular and rotate as in *Solanum* (fig. 2), or bell-shaped as in *Atropa*, or somewhat irregular as in *Hyoscyamus*; in the tribe Salpiglossideae, which forms a link with the closely allied order Scrophulariaceae, it is zygomorphic, forming, e.g. as in *Schizanthus* (fig. 3), a two-flipped flower. The stamens are inserted on the corolla tube and alternate with its lobes; in zygomorphic flowers only two or four fertile stamens are present; the bilocular anthers open by slits or pores (fig. 4). The flowers are generally conspicuous and adapted to insect pollination; honey is secreted on the disk at the base of the ovary or at the bottom of the corolla tube between the stamens. The ovary is usually bilocular, but in *Capsicum* becomes unilocular above, while in some cases an in-growth of a secondary septum makes it 4-celled as in *Datura*, or irregularly 3- to 5-celled as in *Nicandra*. The anatropous ovules are generally numerous on swollen



axile placentas, sometimes few as in *Cestrum*, a large American genus with tubular flowers, species of which are grown in Britain as greenhouse plants; the simple style bears a bilobed or sometimes capitate stigma (fig. 5). The fruit is a many-seeded berry, as in *Solanum*, or

capsule, as in *Datura*, where it splits lengthwise, and *Hyoscyamus* (fig. 6), where it opens by a transverse lid forming a pyxidium. The embryo is bent or straight and embedded in endosperm. The persistent calyx may serve to protect the fruit or aid in its distribution, as in the bladderly structure enveloping the fruit of *Physalis* or the prickly calyx of species of *Solanum*.

The order is divided into 5 tribes; the division is based on the greater or less curvature of the embryo, the number of ovary cells and the regular or zygomorphic character of the flower. The great majority of the genera belong to the tribe Solaneae, which is characterized by a 2-celled ovary. *Lycium* is a genus of trees or shrubs, often thorny, with a cylindrical or narrowly bell-shaped corolla and a juicy berry; *L. europaeum* is a straggling climber often cultivated under the name of tea-plant. For *Atropa* see NIGHTSHADE; *A. Belladonna* yields the drug atropin. For *Hyoscyamus* see HENBANE. *Physalis*, with 45 species mostly in

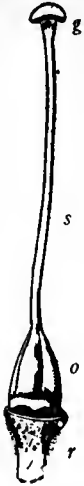

FIG. 5.—The pistil of Tobacco (*Nicotiana Tabacum*), consisting of the ovary *o*, containing ovules, the style *s*, and the capitate stigma *g*. The pistil is placed on the receptacle *r*, at the extremity of the peduncle.



FIG. 6.—Seed-vessel (*pyxidium*) of Henbane (*Hyoscyamus niger*) opening by circumscissile dehiscence.

the warmer parts of North and South America, includes *P. alkekengi*, "winter cherry," and *P. peruviana*, "Cape gooseberry." *Capsicum* (*q.v.*) is widely cultivated for its fruit, which are the so-called chillies. *Solanum* contains 900 species, among which are *S. tuberosum* (potato); *S. Lycopersicum* (tomato; *q.v.*), and the two British species already mentioned. For *Mandragora* see MANDRAKE. To the tribe Datureae, characterized by a 4-celled ovary, belongs *Datura*; *D. Stramonium* (thorn apple), sometimes found as an escape in Britain, is officinal. *Nicotiana*, to which belong the tobacco plant (*N. tabacum*) and other cultivated species, and *Petunia*, are American genera belonging to the tribe Cestreeae, in which the embryo is straight or only slightly bent, as it is also in the tribe Salpiglossideae, which is characterized by the zygomorphy of the flowers; *Salpiglossis* and *Schizanthus* are known in cultivation.

SOLAR, SOLLER (Lat. *solarium*, Fr. *galeas*, Ital. *solaiò*), in architecture, a room in some high situation, a loft or garret, also an elevated chamber in a church from which to watch the lamps burning before the altars. The Latin *solarium* was used principally of a sundial, but also of a sunny part of a house.

SOLARIO, ANTONIO (c. 1382-1455), Italian painter of the Neapolitan school, commonly called Lo Zingaro, or The Gipsy. His father is said to have been a travelling smith. To all appearance Antonio was born at Civita in the Abruzzi, although it is true that one of his pictures is signed "Antonio de Solario Venetus," which may possibly be accounted for on the ground that the signature is not genuine. Solario is said to have gone through a love-adventure similar to that of the Flemish painter, Quintin Massys. He was at first a smith, and did a job of work in the house of the prime Neapolitan painter Colantonio del Fiore; he fell in love with Colantonio's daughter, and she with him; and the father, to stave him off, said if he would come back in ten years an accomplished painter the young lady should be his. Solario studied the art, returned in nine years, and claimed and obtained his bride. The fact is that Colantonio del Fiore is one of those painters who never existed; consequently his daughter never existed, and the whole story, as relating to these particular personages, must be untrue. Whether it has any truth, in relation to some unidentified painter and his daughter, is a separate question which we cannot decide. Solario made an extensive round of study—first with Lippo Dalmasio in Bologna, and afterwards in Venice, Ferrara, Florence and Rome. On returning to Naples he rapidly took the first place in his art. His principal performance is in the court of the

monastery of S. Severino—twenty large frescoes illustrating the life of St Benedict, now greatly decayed; they present a vast variety of figures and details, with dexterous modelling and colouring. Sometimes, however, Lo Zingaro's colour is crude, and he generally shows weakness of draughtmanship in hands and feet. His tendency is that of a naturalist—the heads lifelike and individual, and the landscape backgrounds better invented and cared for than in any contemporary. In the Studj gallery of Naples are three pictures attributed to this master, the most remarkable one being a "Madonna and Child Enthroned with Saints." The heads here are reputed to be mostly portraits. Solario initiated a mode of art new in Naples; and the works painted between his time and that of Tesaurò (c. 1470) are locally termed "Zingareschi." He had many scholars, but not of pre-eminent standing—Nicola Vito, Simone Papa, Angiolillo Roccadirame, Pietro and Ippolito dal Donzello. It has often been said that Solario painted in oil, but of this there is no evidence.

SOLAR SYSTEM, in astronomy, the group of heavenly bodies, comprising the sun and the bodies which move around the sun as a centre of attraction, of which the Earth is one. These bodies may be classified as follows: first the *Sun*, ☉, distinguished as containing much the greater part of all the matter composing the system, being more than 600 times as massive as all the other bodies combined. It is this great mass which makes it the central one of the system. It is also, so far as is known, the only incandescent body of the system, and therefore the only one that shines by its own light. Secondly, *planets*. The bodies of this class consist of eight major planets moving round the sun at various distances, and of an unknown number of minor planets, much smaller than the major planets, forming a separate group. Thirdly, *satellites*, or *secondary planets* revolving around the major planets, and therefore accompanying them in their revolutions around the sun. A fourth class of bodies, the constitution of which is still in some doubt, comprises comets and meteors. These differ in that comets are visible either in a telescope or to the naked eye, and seem to be either wholly or partially of a nebulous or gaseous character, while meteors are, individually at least, invisible to us except as they become incandescent by striking the atmosphere of the earth. It is, however, an open question whether a comet is other than an accumulation of meteoric bodies (see COMET).

The major planets are separated into two groups of four each, between which the minor planets, for the most part, revolve. The arrangement of the major planets, with the numbers of their respective satellites thus far known, in the order of distance from the sun, is as follows:—

The first group in order—the smaller major planets—comprises:—

- Mercury, ☿, with no known satellite;
- Venus, ♀, with no known satellite;
- The Earth, ⊕, with one satellite, the moon;
- Mars, ♂, with two satellites.

Outside of this group lies the zone of minor planets or asteroids.

The outer group of major planets comprises:—

- Jupiter, ♃, with eight satellites;
- Saturn, ♄, with ten satellites;
- Uranus, ♅ or ♁, with four satellites;
- Neptune, ♆, with one satellite.

The distances separating the individual orbits in each group seem to approximate to a certain order of progression, expressed in Bode's law (see BODE). But there is an obvious gap between the two groups of major planets which is filled by the group of minor planets. Taking the mean distance of this group as that of a planet, the distance of the major planets closely approximates to Bode's law, except in the case of Neptune.

A remarkable feature of the solar system, which distinguishes it from all other known systems in the universe, is the symmetry of arrangement and motion of its greater bodies. All the major planets and many of the minor planets revolve in elliptic

orbits so nearly circular in form that the unaided eye would not notice the deviation from that form. But as the orbits are not centred on the sun, which is in a focus of each, the displacement of the seeming circle would be readily seen in the case of Mercury and of Mars. The same statements are true of the orbits of the satellites around their primaries. The major planets all move around the sun in the same direction, from west to east, in orbits but little inclined to each other. All the known minor planets have the same common direction, but their orbits generally have a greater eccentricity and mutual inclination. The general rule is that the satellites also move round in the same direction, and in orbits of moderate inclination. Exceptions occur in the case of the satellites of Uranus, which are nearly perpendicular to the plane of the orbit. The satellite of Neptune, and one satellite, Phoebe, of Saturn, are also quite exceptional, the direction of motion being retrograde.

For the elements of the orbits, and the general character of the several planets see PLANET. Details as to each are found under the respective names of the several planets. (S. N.)

SOLDER (derived through the French from Lat. *solidare*, to make *solidus*, firm), an alloy easily melted and used for uniting as by a metallic cement two metal surfaces, joints, edges, &c. (See BRAZING AND SOLDERING.)

SOLE (*Solea*), the most valuable of European flat-fishes.¹ For most people who look at fish merely from the culinary point of view, soles are of two kinds: true soles, with such varieties as Dover soles and Brixham soles (slips being the name applied to young specimens), and lemon soles, an inferior fish, which is no sole at all, but a sort of dab (*Glyptocephalus microcephalus*). Leaving out the latter, there are five species on the British coasts; the common sole (*Solea vulgaris*) the French sole, or sand sole lemon sole of Yarrell (*S. lascaris*), the thick-back (*S. variegata*), and the solenette or little sole (*S. lutea*). All these agree in the right side being coloured and bearing the eyes, in the elongate form, in the small eyes (separated by a space covered with scaly skin, in the small, twisted mouth, with minute teeth on the colourless side only), and with the snout projecting beyond the mouth and more or less hooked. All true soles are excellent, but the common species is the only one which, from its larger size, growing to a length of 26 in. and attaining maturity at a length of about 10 in., regularly appears on all the markets. It occurs from the south-west coast of Scandinavia, Mecklenburg and Great Britain to the Mediterranean. Most of the best fishing grounds for soles lie comparatively near land, though the spawning takes place some miles away.

Much information on the life history of the sole will be found in the monograph by J. T. Cunningham (Plymouth, 1890).

SOLEMN (Lat. *sollemnis*, *sollennis*, less correctly *solennis*, yearly, annual; from *sollus* = *totus*, whole, entire, Gr. ὅλος, and *annus*, year), properly that which occurs annually, hence at stated intervals, regular, established; the term being particularly used of religious rites or ceremonies which recur at stated intervals, hence festive, sacred, marked by religious ceremony or ritual, and so grave, impressive, serious, the most general current usage. Another branch of meaning stresses the formal, customary aspect; and hence in such phrases as "solemn act," probate in "solemn form," it means that which is done with all due forms and ceremonies.

SOLENT, THE, a strait of the English Channel, between the mainland (the coast of Hampshire, England), and the north-western coast of the Isle of Wight, forming the western entrance to Southampton Water, Spithead being the eastern. Its length, from the eastern shore of Southampton Water to the Needles rocks off the western extremity of Wight, is 15 m. The general breadth is from 2½ to 3 m., but between Stone Point on the mainland and Egypt Point on the north coast of Wight it narrows to 1¾ m.; and 3½ m. north of the Needles there springs from the mainland a great shingle bank, mostly only a few yards in breadth above water, but nearly 2 m. in length.

¹ The American sole (*Achirus fasciatus*) is a small flat-fish of inferior quality.

It reduces the breadth of the Solent to a little over ¾ m., and broadens at the end, on which stands Hurst Castle, an important fortification dating from the time of Henry VIII. Here Charles I. was imprisoned in 1648. The coast of the mainland is low but picturesque, and is broken by the shallow estuaries of the Beaulieu River and the Lym, with the small port of Lymington upon it. The coast of Wight rises more steeply. On this side the Medina estuary opens northward, and those of the Newtown and the Yar north-westward into the strait. At the mouth of Southampton Water is a projecting bar resembling but smaller than that of Hurst Castle, and like it bearing a Tudor fortress, Calshot Castle. The Solent is frequently the scene of yacht races. The configuration of the coast causes a double tide in the strait.

SOLESMES, a village of western France on the left bank of the Sarthe in the department of Sarthe, 29 m. W.S.W. of Le Mans by road. In 1010 a priory was founded at Solesmes and placed under the authority of the abbey of La Couture of Le Mans. Suppressed at the revolution, it was established as a Benedictine monastery in 1830. In 1837 it was raised to the rank of abbey and became a centre of learning; the music here was also famous. A nunnery was afterwards founded beside it, but both institutions were abandoned after the passing of the associations law in 1901. The monastery, rebuilt at the end of the 19th century, forms a lofty mass of buildings on the river bank. Its church (13th and 16th centuries) is interesting only for the possession of two masterpieces of sculpture of uncertain authorship, executed approximately between 1490 and 1550. The most striking represents the burial of Christ and is sheltered by a stone structure, the front of which is beautifully carved. An arched opening in this front reveals the central group of eight figures surrounding the tomb, that of Mary Magdalen in the foreground being remarkably lifelike and expressive. The other work similarly enclosed represents the burial of the Virgin and is the later of the two in date and in the pure Renaissance style. Sculptures representing Jesus among the Doctors and other scenes are also in the church.

SOLETO, a village of Apulia, Italy, in the province of Lecce, from which it is 11 m. S. by rail, situated 299 ft. above sea-level. Pop. (1901), 3349. The Romanesque church of S. Stefano contains Byzantine frescoes of the 14th century similar to those in the subterranean chapel of the Santi Stefani at Vaste, south of Otranto, and others showing the formation of an independent style. The fine, richly decorated campanile adjoining the former cathedral was erected in 1397.

SOLEURE (Ger. *Solothurn*), one of the cantons of north-western Switzerland. Its total area is 305.5 sq. m., of which 294 sq. m. are reckoned as "productive," 111.3 sq. m. being covered by forests and 29 sq. m. by vineyards. Save two small districts in its southern portion the whole canton is situated in the Jura range, while it is said to be the most irregular in shape of all the Swiss cantons, this being accounted for by the fact that it consists simply of the territories won at different dates by the town from which it takes its name. It includes most of the Aar valley between the towns of Bienne and Aarau, neither of which is in the canton, while in its northern portion the waters join the Birs River, and in its southern portion is the last bit of the Emme before its junction with the Aar. It comprises three isolated districts, of which one (Steinhof) on the south is an "enclave" in the canton of Bern, while the others, Hofstetten, that includes the famous pilgrimage resort of Mariastein, and Klein Lützel, are on the Alsatian frontier, and bounded by the cantons of Bern and of Basel. The highest point in the canton is the Hasenmatt (4748 ft.) which forms the culminating summit of the Weissenstein ridge, that rises just north-west of the town of Soleure, and boasts of an hotel well-known as a great centre for the air and whey cure. The canton is well supplied in its southern portion with railways, the main line from Bienne to Aarau running through it past the great junction of Olten, where the direct lines from Lucerne by the St Gotthard, from Bern, from Zürich, and from Basel all unite. Formerly the districts composing the canton were in the dioceses of Lausanne,

Basel and Constance, but since the complete reorganization of 1814 they are all in the diocese of Basel, the bishop of which has his chair in Soleure. In 1900 the population was 100,762, of whom 97,930 were German-speaking, 1912 French-speaking, and 829 Italian-speaking, while 69,461 were "Catholics" (the census does not distinguish between Romanists and Christian Catholics, who are still fairly strong here), 31,012 Protestants, and 159 Jews. The capital is Soleure, while the only other important town is Olten (6969 inhabitants). Between Soleure and Granges or Grenchen (5202 inhabitants) is the village of Selzach, where since 1893 a passion-play has been performed every summer by the inhabitants.

Till about 1850 the canton was mainly agricultural and pastoral, its pastures numbering 209, capable of supporting 4179 cows and of an estimated capital value of 2,395,215 francs. Nowadays it is distinguished for the variety of its industries, especially in and around Soleure and Olten, among them being watch-making, shoe-factories, cotton-spinning and cement factories.

The canton is divided into ten administrative districts, that comprise 132 communes. The present cantonal constitution dates from 1887, but was revised as to some important points in 1895. The *Kantonsrat*, or legislative assembly, is elected (since 1895 according to the principles of proportional representation) by all citizens over twenty years of age, in the proportion of one member to 800 inhabitants. Since 1895 the people have elected the *Regierungsrat* or executive, consisting of five members. In both cases the period of office is four years, though on the demand of 4000 citizens a popular vote must be taken as to whether the existing members shall continue to sit or not. In the canton the "obligatory referendum" and the "initiative" have obtained since 1875. By the former all laws passed by the legislative assembly, and all financial resolutions involving the expenditure of 100,000 francs, or of an annual sum of 15,000 francs; must be approved by a popular vote. By the latter 2000 citizens can compel the legislative assembly to consider any proposal for making a new law or for amending an old one. Further, the demand of the majority of the assembly or of 3000 citizens is sufficient to necessitate a popular vote as to the advisability of revising the constitution, the revised draft itself requiring a further popular vote. The two members of the federal *Ständerat* and the five members of the federal *Nationalrat* are also chosen by a popular vote.

AUTHORITIES.—J. Amiet, *Das St Ursus Pfarr-Stift d. Stadt Soleure*, 6 pts. (Soleure, 1878-1890), and *Die Gründungs-Sage der Schwesterstädte, Solothurn, Zürich, und Trier* (Soleure, 1890); G. Bloch, *Bilder aus d. Ambassadors Herrschaft in Soleure, 1554-1791*, (Biel, 1898); W. Flury, *Die industrielle Entwicklung d. Kant. S.* (Soleure, 1908); K. Meisterhans, *Älteste Geschichte d. Kant. Soleure bis 687* (Soleure, 1900); J. R. Rahn, *Die Mittelalt. Kunstdenkmäler d. Cant. Soleure* (Zürich, 1893); K. E. Schuppli, *Geschichte der Stadtverfassung von Soleure* (Basel, 1897); P. Strohmeier, *Der Kant. Soleure* (St Gall and Bern, 1836); A. Strüby, *Die Weidewirtschaft im Kant. Soleure* (Soleure, 1896); and E. Tatarinoff, *Die Betheiligung Solothurns am Schwabenkrieg, 1499* (Soleure, 1899).

(W. A. B. C.)

SOLEURE, the capital of the Swiss canton of that name, is an ancient little town, almost entirely situated on the left bank of the Aar. It was a Roman *castrum*, remains of which still exist, on the highway from Avenches to Basel, while its position at the foot of the Jura and close to the navigable portion of the Aar has always made it a meeting-point of various routes. Five railway lines now branch thence, while a sixth has been recently added, the tunnel beneath the Weissenstein to Moutier Grandval having been completed. It was strongly fortified in 1667-1727, but since 1830 these defences have been removed for reasons of practical convenience. Its chief building is the minster of SS Ursus and Victor, which dates from the 18th century, though it stands on the site of a far older edifice. Since 1828 it has been the cathedral church of the bishop of Basel, but in 1874 its chapter was suppressed. The ancient clock tower has a quaint 16th-century clock, while the older portions of the town-hall date still further back. The early

17th-century arsenal contains the finest collection of armour and old weapons in Switzerland, while the modern museum houses a splendid collection of fossils from the Jura, the specimens of Alpine rocks collected by F. J. Hugi (1796-1855), a native of Soleure, and a Madonna by the younger Holbein. The building now used as the cantonal school was formerly the residence of the French ambassadors to the Swiss confederation from 1530 to 1797. There are some fine 16th-century fountains in the little town, which in its older portions still keeps much of its medieval aspect, though in the modern suburbs and in the neighbouring villages there is a certain amount of industrial activity. The Polish patriot Kosciusko died here in 1817; his heart is preserved at Rapperswil, but his body is buried at Cracow. In 1900 the town had 10,025 inhabitants, almost all German-speaking, while there were 6098 "Catholics" (either Romanists or Christian Catholics), 3814 Protestants and 81 Jews. In 1904 there were twenty churches or chapels in the town itself. One mile north of the town is the Hermitage of St Verena, in a striking rock gorge, above which rises the Weissenstein ridge, the hotel on which (4223 ft.) is much frequented in summer for the air and where cure as well as for the glorious Alpine panorama that it commands.

A 16th-century rhyme claims for the town of Soleure the fame of being the oldest place in "Celtis" save Trier. Certainly its name, "Salodurum," is found in Roman inscriptions, and its position as commanding the approach to the Rhine from the south-west has led to its being more than once strongly fortified. Situated just on the borders of Alamannia and Burgundy, it seems to have inclined to the allegiance of the latter, and it was at Soleure that in 1038 the Burgundian nobles made their final submission to the German king, Conrad II. The medieval town grew up round the house of secular canons founded in the 10th century in honour of St Ursus and St Victor (two of the Theban legion who are said to have been martyred here in 302) by Queen Bertha, the wife of Rudolph II., king of Burgundy, and was in the diocese of Lausanne. The prior and canons had many rights over the town, but criminal jurisdiction remained with the kings of Burgundy, then passed to the Zähringen dynasty, and on its extinction in 1218 reverted to the emperor. The city thus became a free imperial city, and in 1252 shook off the jurisdiction of the canons and took them under its protection. In 1295 we find it allied with Bern, and this connexion is the key to its later history. It helped Bern in 1298 in the great fight against the nobles at Dornbühl, and again at Laupen in 1339 against the jealous Burgundian nobles. It was besieged in 1318 by Duke Leopold of Austria, but he was compelled to withdraw. In the 14th century the government of the town fell into the hands of the guilds, whose members practically filled all the public offices. Through Bern, Soleure was drawn into association with the Swiss Confederation. An attempt to surprise it in 1382, made by the Habsburgs, was foiled, and resulted in the admittance of Soleure in 1385 into the Swabian League and in its sharing in the Sempach War. Though Soleure took no part in that battle, it was included in the Sempach ordinance of 1393 and in the great treaty of 1394 by which the Habsburgs renounced their claims to all territories within the Confederation. In 1411 Soleure sought in vain to be admitted into the Confederation, a privilege only granted to her in 1481 at the diet of Stans, after she had taken part in the Aargau, Italian, Toggenburg, and Burgundian Wars. It was also in the 15th century that by purchase or conquest the town acquired the main part of the territories forming the present canton. In 1529 the majority of the "communes" went over to the reformed faith, and men were sent to fight on Zwingli's side at Kappel (1531), but in 1533 the old faith regained its sway, and in 1586 Soleure was a member of the Golden, or Borromean, League. Though the city ruled the surrounding districts, the peasants were fairly treated, and hence their revolt in 1653 was not so desperate as in other places. Soleure was the usual residence of the French ambassador from 1530 to 1797, and no doubt this helped on the formation of a "patriciate," for after 1681 no fresh citizens were admitted, and later

we find only twenty-five ruling families distributed over the eleven gilds. Serfage was abolished by Soleure in 1785. The old system of the city ruling over eleven bailiwicks came to an end in March 1798, when Soleure opened its gates to the French army, and it was one of the six "directorial" cantons under the 1803 constitution. In 1814 the old aristocratic government was set up again, but this was finally broken down in 1831, Soleure in 1832 joining the league to guarantee the maintenance of the new cantonal constitutions. Though distinctly a Roman Catholic canton, it did not join the "Sonderbund," and voted in favour of the federal constitutions of 1848 and 1874.

(W. A. B. C.)

SOLFATARA, a volcanic vent emitting vapours chiefly of sulphurous character, whence the name, from the Italian *solfo* (sulphur). The typical example is the famous Solfatara, near Puzzuoli, in the Phlegraean Fields, west of Naples. This is an old crater which has not been in active eruption since A.D. 1108, but which is continuously exhaling heated vapours, chiefly hydrogen sulphide, sulphur dioxide and steam. These issue from orifices in the crust, on the walls of which are yellow incrustations of sublimed sulphur, sometimes orange-red by association with arsenic sulphide, whilst the trachytic rocks of the volcano are bleached and corroded by the effluent vapours, with formation of such products as gypsum and alum. Sal ammoniac occurs among the sublimates. The term solfatara has been extended to all dormant volcanoes of this type; and a volcano which has ceased to emit lava or ashes but still evolves heated vapours, is said to have passed into the "solfataric stage." Examples are to be found in many volcanic districts. By French geologists the term *soufrière* is used instead of the Italian solfatara. (See VOLCANOES.)

SOLFIERINO, a village of Lombardy, Italy, in the province of Mantua, 5 m. S.W. of San Martino della Battaglia (a railway station 72 m. E. of Milan on the line to Verona), situated 410 ft. above sea-level, on the south-west edge of the hills bordering the Lake of Garda on the south. Pop. (1901), 1350. It was the scene of a battle fought on the 24th of June 1859 between the allied Franco-Sardinian army under Napoleon III. and Victor Emanuel, and the Austrian army commanded by Francis Joseph II., in which, after a severe contest, the latter retired over the Mincio (see ITALIAN WARS). The battle fought by the Sardinians on the left wing of the allied army is often called by the separate title of San Martino, from a hamlet near the Brescia-Verona railway, about which it was fought. From this battle, a certain shade of blue was designated by the name of Solferino, and was very popular for some years, though now, unlike its companion "magenta," it is forgotten.

SOLI (mod. *Mezellü*), an ancient town of Asia Minor, on the coast of Cilicia, between the rivers Lamus and Pyramus, from each of which it is about 62 m. Colonists from Argos in Greece and Lindus in Rhodes are described as the founders of the town, which is first mentioned at the time of the expedition of the younger Cyrus. In the 4th century B.C. it was so wealthy that Alexander exacted a fine of 200 talents. In the Mithradatic War, Soli was destroyed by Tigranes, but it was subsequently rebuilt by Pompey, who settled there many of the pirates whom he had captured, and called the town Pompeiopolis. Soli was the birthplace of Chrysippus the Stoic and of the poets Philemon and Aratus. The bad Greek spoken there gave rise to the term *σολοικισμός*, solecism, which has found its way into all the modern languages of Europe. The ruins, which lie on the right bank of the Mezetlü Su have been lately plundered to supply building material for Mersina, and little remains except part of the colonnade which flanked the main street leading to the harbour. The place is easily reached from Mersina by carriage in about 1½ hours. (D. G. H.)

SOLI, a Greek city on the north coast of Cyprus, lying at Soliais in the metalliferous country round Karavortasi near Lefka, on the south side of Mórphou Bay. Its kingdom was bounded by the territories of Marion, Paphos, Tamassus and Lapathus. It was believed to have been founded after the Trojan War (c. 1180) by the Attic hero Acamas; but no remains have been found in this district earlier than the Early Iron Age

(c. 1000-800). The town of "Sillu," whose king Irišu was an ally of Assur-bani-pal of Assyria in 668 B.C., is commonly supposed to represent Soli.¹ In Hellenic times Soli had little political importance, though it stood a five months' siege from the Persians soon after 500 B.C.; its copper mines, however, were famous, and have left copious slag heaps and traces of small scattered settlements. A neighbouring monastery is dedicated to "Our Lady of the Slagheaps" (*Panagia Skourgíotissa*). But the copper seems to have been exhausted in Roman times, and thereupon Soli became desert.

See W. H. Engel, *Kypros* (Berlin, 1841; classical authorities); J. L. Myres and M. Ohnefalsch-Richter, *Cyprus Museum Catalogue*, (Oxford, 1899; antiquities); G. F. Hill, *Brit. Mus. Cat. Coins of Cyprus* (London, 1904; coins). (J. L. M.)

SOLICITOR, in England, an officer of the Supreme Court of Judicature qualified to conduct legal proceedings for his clients: see also ATTORNEY. Previous to the reign of Henry III. the common law considered it indispensable that the parties to a suit should be actually present, but the privilege of appearing by attorney was conceded in certain cases by special dispensation. The passing of the statute of Merton and subsequent enactments made it competent for both parties in all judicial proceedings to appear by attorney. Previous to the passing of the Judicature Act of 1873 there was a distinction between the terms "solicitor" and "attorney." Solicitors appear to have been at first distinguished from attorneys, as not having the attorney's power to bind their principals, but latterly the distinction was between attorneys as the agents formally appointed in actions at law, and solicitors who took care of proceedings in parliament, chancery, privy council, &c. In practice, however, and in ordinary language, the terms were synonymous. Down to the 17th century the solicitor of the chancery courts was considered inferior to the attorney of the common law courts, but the rapid growth of equity jurisdiction gave the solicitor an importance in no degree inferior to his fellow practitioner at the common law. Until 1873 it was usual for attorneys to be admitted as solicitors as well, but the Judicature Act of that year enacted that all persons admitted as solicitors, attorneys or proctors of an English court shall henceforth be called solicitors of the Supreme Court. Regulations regarding the qualification of attorneys are found as far back as the 20 Edward I. (1292), and the profession has been stringently regulated by a series of statutes passed during the 19th century, notably the Solicitors Act 1843 and the Solicitors Acts 1877 and 1888.

Every person, before he can become a duly qualified solicitor, must serve an apprenticeship or clerkship to a practising solicitor for a term of years varying from three to five, he must pass all the necessary examinations, he must be duly admitted and entered on the roll of solicitors kept by the Incorporated Law Society and must take out an annual certificate to practise. The organization of the profession is in the hands of the Incorporated Law Society. Established originally in 1827, in succession to an earlier society dating back to 1739, it was incorporated in 1831. It began courses of lectures for students in 1833 and ten years later was constituted registrar of attorneys and solicitors. In 1860 it obtained the power of suing unqualified solicitors and in 1888 it was given the custody of the roll of solicitors, on the abolition of the office of the clerk of the Petty Bag. The Solicitors Act of 1888 vested in the Incorporated Law Society the power of investigating complaints as to the professional conduct of solicitors, as well as power to refuse to renew the annual certificate of a solicitor, subject to the solicitor's right of appeal. The statutory committee of the Incorporated Law Society may make application to the court to strike a solicitor off the rolls without preliminary inquiry by the committee where he has been convicted of a criminal offence, but where he is alleged to have been guilty of unprofessional conduct or a statutory offence the committee first hold a preliminary inquiry. Apart from its judicial administrative authority it has exercised powerful influence in the attitude which it has frequently taken towards proposed legislation. Membership of the society, which is not compulsory, is open to any duly qualified practising solicitor, on approval by the council. No person, however duly qualified, can be admitted as a solicitor till he has attained the age of twenty-one years. Though admitted as a solicitor and his name entered on the roll he is not at liberty to practise until he has taken out his annual certificate, the fees for which vary according as the applicant

¹ E. Schrader, *Abh. K. Preuss. Ak. Wiss.* (1879), pp. 31-36.

intends to practise in London or the provinces. Solicitors now have a right to practise in any court, *i.e.* in every division of the High Court, in every inferior court, in the ecclesiastical courts (as proctors), in the court of appeal, in the privy council and in the House of Lords. Their right of audience, however, is restricted. They may appear as advocates in most of the inferior courts, as before justices, magistrates, coroners, revising barristers and county courts. They have no right of audience, however, in the Mayor's court, London, nor in the High Court of Justice, privy council or House of Lords, where, from time immemorial, the right has pertained to the bar, but they have right of audience in chambers and certain bankruptcy matters. Since the Conveyancing Act 1881 solicitors may do all kinds of conveyancing, which formerly was considered the exclusive business of the bar. The Conveyancing Act 1881 having made great changes in the practice of conveyancing, it became necessary to place the remuneration of solicitors upon a new basis. This was done by the Solicitors Remuneration Act, passed on the same day as the Conveyancing Act. It provides for the framing of general orders, fixing the principles of remuneration with reference *inter alia* to the skill and responsibility involved, not, as was generally the case before, with reference simply to the length of the documents perused or prepared. A solicitor is not responsible for statements made by him in his professional capacity as an advocate, and all communications which pass between a solicitor and his client are privileged, so also is any information or document which he has obtained in his professional capacity on behalf of his client. The relation of solicitor and client disqualifies the former from dealing with his client on his own behalf, while it gives him a lien, on professional services, over the deeds, &c., of the client in his possession. A solicitor's remuneration is minutely arranged by statute and he has no power of recovering more from his client than his statutory charges, and he is liable to be sued for damages for negligence in his client's behalf. Certain personal privileges belong to a solicitor. He is free from serving on juries, nor need he, against his will, serve as a mayor, alderman, sheriff, overseer or churchwarden.

In Scotland solicitors in the Supreme Court are not, as in England, the only persons entitled to act as law agents. They share the privilege with writers to the signet in the Supreme Court, with agents at law and procurators in the inferior courts. They were formed into a society in 1784 and incorporated in 1796, and are usually recognized as members of the College of Justice. This difference is, however, now of little importance, as by the Law Agents Act 1873 any person duly admitted a law agent is entitled to practise before any court in Scotland. In the United States the term solicitor is used in some states in the sense of a law agent practising before a court of equity.

Many of the great public offices in England and the United States have their solicitors. In England the treasury solicitor fills an especially important position. He is responsible for the enforcement of payments due to the treasury, and conducts generally its legal business. The office of king's proctor is also combined with that of treasury solicitor. Under his powers as king's proctor the treasury solicitor acts as administrator of the personal estate of an intestate which has lapsed to the crown, and intervenes in cases of divorce where collusion is alleged (see under PROCTOR). Under the Prosecution of Offences Act 1884 he also acted as director of public prosecutions, and was sometimes called Crown Solicitor. By the Prosecution of Offences Act 1908 the office of director of public prosecutions was separated from that of treasury solicitor and made a separate appointment. In Ireland, solicitors called crown solicitors are attached to each circuit, their duty being to prepare the case for the crown in all criminal prosecutions. In the United States the office of solicitor to the treasury was created by Act of Congress in 1830. His principal duties are to take measures for protecting the revenue and to deal with lands acquired by the United States by judicial process or vested in them by security for payment of debts.

See E. B. V. Christian, *A Short History of Solicitors*; Cordery on *Solicitors*; and A. P. Poley, *Law Affecting Solicitors*.

SOLICITOR-GENERAL, in England, one of the law officers of the crown, appointed by letters patent. He is always a member of the House of Commons and of the political party in power, changing with it. His duties are practically the same as those of the attorney-general (*q.v.*), to whom he is subordinate, and whose business and authority would devolve upon him in case of a vacancy in the office. He receives a salary of £6000 a year, in addition to fees for any litigious business he may conduct on behalf of the crown. The position of the solicitor-general for Scotland in the main corresponds with that of the English solicitor-general. He is next in rank to the lord-advocate. In the United States the office of solicitor-general was created by Act of Congress in 1870.

SOLINGEN, a town of Germany, in the Prussian Rhine Province, on a height above the Wupper, 13 m. S.E. of

Düsseldorf, and 20 m. N.E. of Cologne by rail. Pop. (1905), 49,018. Solingen is one of the chief seats of the German iron and steel industry, its speciality consisting in all kinds of cutlery, Solingen sword-blades have been celebrated for centuries, and are widely used outside Germany, while bayonets, knives, scissors, surgical instruments, files, steel frames and the like are also produced in enormous quantities. These articles are largely made by the workmen at their own homes and supplied to the dépôts of the large dealers; there are about 20,000 workers in steel in Solingen and the vicinity. Solingen received its municipal charter in 1374. Sword-blades have been made here since the early middle ages, and tradition affirms that the art was introduced during the Crusades by smiths from Damascus.

SOLINUS, GAIUS JULIUS, Latin grammarian and compiler, probably flourished during the first half of the 3rd century A.D. He was the author of *Collectanea rerum memorabilium*, a description of curiosities in a chorographical framework. Adventus, to whom it is dedicated, is identified with Oclatinus Adventus, consul A.D. 218. It contains a short description of the ancient world, with remarks on historical, social, religious and natural history questions. The greater part is taken from Pliny's *Natural History* and the geography of Pomponius Mela. According to Mommsen, Solinus also used a chronicle (possibly by Cornelius Bocchus) and a *Chorographia pliniana*, an epitome of Pliny's work with additions made about the time of Hadrian. Schanz, however, suggests the *Roma* and *Pratum* of Suetonius. The *Collectanea* was revised in the 6th century under the title of *Polyhistor* (subsequently taken for the author's name). It was popular in the middle ages, hexameter abridgments being current under the names of Theodericus and Petrus Diaconus.

The commentary by Saumaise in his *Plinianae exercitationes* (1689) is indispensable; best edition by Mommsen (1895), with valuable introduction on the MSS., the authorities used by Solinus, and subsequent compilers. See also Teuffel, *Hist. of Roman Literature* (Eng. trans., 1900), 389; and Schanz, *Geschichte der römischen Litteratur* (1904), iv. 1. There is an old English translation by A. Golding (1587).

SOLIPSISM (Lat. *solus*, alone, *ipse*, self), a philosophical term, applied to an extreme form of subjective idealism which denies that the human mind has any valid ground for believing in the existence of anything but itself. "It may best be defined, perhaps, as the doctrine that all existence is experience, and that there is only one experient. The Solipsist thinks that *he is the one!*" (Schiller). It is presented as a solution of the problem of explaining the nature of our knowledge of the external world. We cannot know things-in-themselves: they exist for us only in our cognition of them, through the medium of sense-given data. In F. H. Bradley's words (*Appearance and Reality*): "I cannot transcend experience, and experience is *my* experience. From this it follows that nothing beyond myself exists; for what is experience is its (the self's) states."

See IDEALISM; also F. C. S. Schiller, *Mind*, New Series (April 1909).

SOLÍS, ANTONIO DE (1610-1686), Spanish dramatist and historian, was born in 1610 at Alcalá de Henares (less probably, Plasencia), and studied law at Salamanca, where he produced a comedy entitled *Amor y obligación*, which was acted in 1627. He became secretary to the count of Oropesa, and in 1654 he was appointed secretary of state as well as private secretary to Philip IV. Later he obtained the lucrative post of chronicler of the Indies, and, on taking orders in 1667, severed his connexion with the stage. He died at Madrid on the 19th of April 1686. Of his ten extant plays, two have some place in the history of the drama. *El Amor al uso* was adapted by Scarron and again by Thomas Corneille as *L'Amour à la mode*, while *La Gitanilla de Madrid*, itself founded on the *novela* of Cervantes, has been utilized directly or indirectly by P. A. Wolff, Victor Hugo and Longfellow. The titles of the remaining seven are *Triunfos de amor y fortuna*, *Euridice y Orfeo*, *El Alcázar del secreto*, *Las Amazonas*, *El Doctor Carlino*, *Un Bobo hace ciento*, and *Amparar el enemigo*. *Amor y obligación* survives in a manuscript at the Biblioteca Nacional. The

Historia de la conquista de Méjico, covering the three years between the appointment of Cortes to command the invading force and the fall of the city, deservedly ranks as a Spanish prose classic. It was published in 1684; an English translation by Townshend appeared in 1724.

SOLITAIRE (Fr. for "solitary"), a game played on a board indented with 33 or 37 hemispherical hollows, with the same number of balls or marbles. An unoccupied hollow is left by removing one ball, and the balls, or pieces, are then captured as in draughts. No moves are allowed in diagonal directions or over more than one space at a time.

SOLO, OR SOLO WHIST, a card game which is a modification of whist, the chief distinctive feature being that a single player generally has to oppose the other three. The game came into vogue in England towards the end of the 19th century. The following "declarations" can be made, the order being important: (1) proposition; (2) acceptance; (3) solo; (4) *misère*; (5) *abondance* (or abundance); (6) *misère ouverte*; (7) *abondance déclarée* (declared abundance). Proposition and acceptance go together, as will be seen; of the rest "solo" can be declared over "proposition," *misère* over solo, and so on. The stakes—regarding sixpence as the unit—are: for proposition, sixpence; for solo, sixpence (sometimes a shilling); for *misère*, a shilling; for abundance, eighteenpence; for open *misère*, two shillings; for declared abundance, three shillings. A further stake may be arranged for "overtricks," to be paid to the player for every trick made above the number proposed, and for "undertricks," to be paid by the player for every trick below that number.

A full pack is used; players cut as at whist for deal and seats; the cards may be dealt singly, but are more commonly dealt by threes, with a single card for the last round. The last card is turned up and left exposed for a round, whether it is used for trumps or not. One deal constitutes a game. The laws of whist obtain, where applicable, in such matters as following suit, revoking, the passing of the deal, &c. The player on the dealer's left is first to declare or pass: if he proposes, any player may accept, the right going first to the player on his left, but any player when his turn comes may make a higher declaration than any that has gone before him, though a player whose call has been superseded may amend his call afterwards. If all the players pass, either there is a new deal, or by arrangement there is a general *misère*, when the player who takes the most tricks—sometimes, the last trick—pays a single stake all round.

The Declarations.—(1) *Proposal*: This is an invitation to another player to "accept," i.e. to join the proposer in an attempt to make eight tricks. (2) *Solo*: Here a player undertakes to win five tricks, playing against the other three in combination. (3) *Misère*: This is a declaration by a player that he will not win a single trick. There are no trumps, but the turn-up card is left exposed for the first round. If the caller wins a trick the game is at an end (there are no overtricks or undertricks), but he has a right to see the opponents' hands, to be sure that no revoke has been made. A trick that has been turned may not be seen afterwards. (4) *Abundance* is a declaration that a player will make nine tricks single-handed. The caller makes any suit trumps, but abundance in the turn-up suit takes precedence over abundance in other suits. The trump suit must be declared after the other players have passed, before the first round is played. (5) *Misère ouverte*: This call is a declaration to lose all thirteen tricks, but after the first trick the caller's cards are placed on the table, though he may play them as he pleases. (6) *Declared Abundance*: This is a declaration of the caller to make all thirteen tricks by his own hand. He makes his own trumps and always leads, but a declaration in the suit of the turn-up card takes precedence over others. The game ends when the caller loses a trick. There are no undertricks.

SOLOGNE (*Secalaunia* from Lat. *secale*, rye), a region of north-central France extending over portions of the department of Loiret, Loir-et-Cher and Cher. Its area is about 1800 sq. m., and its boundaries are, on the N. the river Loire, on the S. the Cher, on the E. the districts of Sancerre and Berry. The Sologne is watered by the Cossou and the Beuvron, tributaries of the Loire, and the Sauldre, an affluent of the Cher, all three having a west-south-westerly direction. The pools and marshes which are characteristic of the region are due to the impermeability

of its soil, which is a mixture of sand and clay. The consequent unhealthiness of the climate has been greatly mitigated since the middle of the 19th century, when Napoleon III. led the way in the reclamation of swamps, the planting of pines and other trees and other improvements. Arable farming and stock-raising are fairly flourishing in the Sologne, but there is little manufacturing activity, the cloth manufacture of Romorantin being the chief industry. Game is abundant, and the region owes much of its revived prosperity to the creation of large sporting estates.

SOLOLA, the capital of the department of Sololá, in Guatemala; on the northern shore of lake Atitlán, 46 m. W.N.W. of Guatemala city. Pop. (1905), about 17,000. Sololá is the ancient capital of the Cakchiquel Indians, who form the bulk of the population. In the city coarse cloth, pottery, cigars and soap are manufactured, and there is a large prison and reformatory. Among the surrounding mountains are large and successful coffee plantations, owned by German settlers. On the 18th of April 1902 Sololá was wrecked by an earthquake, but as most of the houses were constructed of wood it was speedily rebuilt.

SOLOMON¹ (10th century B.C.), the son of David by Bathsheba, and his successor in the kingdom of Israel. The many floating and fragmentary notes of various dates that have found a place in the account of his reign in the book of Kings (*q.v.*) show how much Hebrew tradition was occupied with the monarch under whom the throne of Israel reached its highest glory; and that time only magnified in popular imagination the proportions of so striking a figure appears from the opinions entertained of him in subsequent writings. The magnificence and wisdom of Solomon (*cf.* Matt. vi. 29; Luke xi. 31) and the splendour of his reign present a vivid contrast to the troublous ages which precede and follow him, although the Biblical records prove, on closer inspection, to contain so many incongruous elements that it is very difficult to form a just estimate of his life and character. A full account is given of the circumstances of the king's accession (contrast the summary notices, 1 Kings xxii. 41 seq., 2 Kings xv. 1, xxi. 24, xxiv. 18, &c.). He was not the true heir to the throne, but was the son of David by Bathsheba, wife of Uriah the Hittite, whom David sent to his death "in the forefront of the battle." The child of the illegitimate union died; the second was called Jedidiah ("beloved of Yah [weh]") or Shēlōmōh (the idea of requital or recompense may be implied); according to 1 Chron. iii. 5, on the other hand, Solomon was the fourth, or rather the fifth, child of Bathsheba and David. The episode forms the prelude to family rivalries. David's first-born, Amnon, perished at the hands of the third son, Absalom, who lost his life in his revolt (2 Sam. xiii.–xx.). The second, Chileab, is not mentioned in the history, and the fate of the fourth, who regarded himself as the future king, is described in 1 Kings i., ii. Bathsheba, relying upon David's promise that Solomon should succeed him, vigorously advanced her son's claims with the support of Zadok the priest, the military officer Benaiah, and David's bodyguard; Adonijah, for his part, had David's old priest Abiathar, the commander Joab, and the men of Judah. A more serious breach could scarcely be imagined. The adherents of Solomon gained the day, and with his accession a new régime was inaugurated, not, however, without bloodshed.

Solomon's age at his accession is not recorded. The tradition that he was only twelve (1 Kings ii. 12 Septuagint; or fourteen, *Jos. Ant.* viii. 7, 8) may rest upon iii. 7 ("I am but a little child"; if this is not hyperbole), or upon the chronological scheme embodied in 2 Sam. xiii. 23, 38, xiv. 28, xv. 7. It agrees with his subordinate position in portions of ch. i., but his independent actions in ch. ii. suggest a more mature age, and according to xi. 42, xiv. 21, his son Rehoboam was already born (but contrast again xii. 24 Septuagint, 2 Chron. xiii. 7). See further, *Ency. Bib.* col. 4681, n. 5.

¹ Heb. *Shēlōmōh*, as though "his peace"; but the true meaning is uncertain; evidence for its connexion with the name of a god is given by H. Winckler and Zimmern, *Keilinschr. u. das Alte Test.*, 3rd ed., pp. 224, 474 seq. The English form follows the *Σολῶμων* of N.T. and Josephus; the Lat. *Salomo* agrees with *Σαλῶμων* (one of several variant forms shown in MSS. of the LXX.).

The acute observation that 2 Sam. ix.-xx.; 2 Kings i. ii. 1-9, 13 sqq., were evidently incorporated after the Deuteronomic redaction of the books of Samuel (K. Budde, *Samuel*, p. xi.) is confirmed by the framework of Kings with its annalistic material similar to that preserved in 2 Sam. v.-viii., xxi.-xxiv.; 1 Kings ii. 10-12. With this may belong iii. 3 (the compiler's judgment); and especially v. 3 sqq., where reference is made to David's incessant wars (2 Sam. viii.). That 2 Sam. ix.-xx., &c., had previously been omitted by the Deuteronomic redactor himself (Budde) cannot be proved. These post-Deuteronomic narratives preserve older material, but with several traces of revision, so that 1 Kings i. ii. now narrate both the end of David's reign and the rise of Solomon (see I. Benzinger's commentary on Kings, p. xi.; C. Holzhey, *Buch d. Könige*, p. 17). The latter, however, is their present aim, and some attempt appears to have been made in them to exculpate one whose accession finds a Judaeic parallel in Jehoram (2 Chron. xxi. 1-4). Thus it has been held that David's charges (ii. 1-9) were written to absolve Solomon, and there is little probability in the story that Adonijah after his pardon really requested the hand of Abishag (ii. 13-25), since in Oriental ideas this would be at once viewed as a distinct encroachment upon Solomon's rights as heir (cf. W. R. Smith, *Kinship and Marriage*, 2nd ed., p. 110).

Every emphasis is laid on the wisdom of Solomon and his wealth. Yahweh appeared to Solomon in a dream and offered to grant whatever he might ask. Confessing his inexperience, the king prayed for a discerning heart, and was rewarded with the gift of wisdom together with riches and military glory. There follows an example of his sagacity: the famous story of the steps he took to determine which of two claimants was the mother of a child (iii. 16-28).¹ His wisdom excelled that of Egypt and of the children of the East; by the latter may be meant Babylonia, or more probably the Arabs, renowned through all ages for their shrewdness. Additional point is made by emphasizing his superiority over four renowned sages, sons of Mahol; but the allusion to these worthies (who are incorporated in a Judaeic genealogy, 1 Chron. ii. 6) is no longer intelligible. He is also credited with an interest in botany and natural history (iv. 33), and later Jewish legend improved this by ascribing to him lordship over all beasts and birds and the power of understanding their speech. To this it added the sovereignty over demons, from a wrong interpretation of Eccles. ii. 8 (see Lane, *Arabian Nights*, intro., n. 21, and ch. 1, n. 25). As his fame spread abroad, people came to hear his wisdom, and costly presents were showered upon him. The sequel was the visit of the Queen of Sheba (1 Kings iv. 29-34; x.). The interesting narrative appears in another light when we consider Solomon's commercial activity and the trading intercourse between Palestine and south Arabia.² His wealth was in proportion to his wisdom. Trading journeys were conducted with Phoenician help to Ophir and Tarshish. With the horse-breeding districts of the north he traded in horses and chariots (x. 28 seq.; see MIZRAIM), and gold accumulated in such enormous quantities that the income for one year may be reckoned at about £4,100,000 in weight (x. 11 seq., 14 sqq.). Silver was regarded as stones; the precious cedars of Lebanon as sycamores. His realm extended from Tiphshah (Thapsacus) on the Euphrates to the borders of Egypt (iv. 21, 24), and it agrees with this that he gains important conquests in the north (2 Chron. viii. 3 seq.; but see 1 Kings ix. 18). He maintained a very large harem (xi.), and among his wives was the daughter of an Egyptian Pharaoh. For his distinguished consort, who brought Gezer as a dowry, a special palace was built (iii. 1, ix. 16, 24), and this was only one of many building enterprises.

The description of the magnificent temple of Jerusalem,

¹ For parallels, see R. Flint in Hastings's *Dict. Bib.* iv. 562, n. 1. For the Pompeian wall-painting representing Solomon's judgment (the figures are pygmies!), see A. Jeremias, *Altes Test. im Lichte d. alt. Orients* 2nd ed., p. 492 seq. (with illustration and references).

² For Mahomedan stories of Solomon, the hoopoe and the queen of Sheba, see the Koran, Sur. xxvii., which closely follows the second Targum to Esther i. 2, where the Jewish fables may be read in full. On this story, see also J. Halévy, *École pratique des hautes études* (1905), pp. 5-24, and the Chinese parallel in the *Mittheilungen* of the Berlin Seminar for Oriental Languages (1904), vii. i. pp. 117-172. For the late legends of Solomon see M. Grünbaum, *Neue Beiträge zur semit. Sage*, pp. 198-237 (Leiden, 1893); G. Salzberger, *Die Salomo-Sage in der semitischen Literatur* (Berlin, 1907).

which occupies considerable space in Solomon's history (v.-viii.), appears in more elaborate form in the chronicler's later work. The detailed record stands in contrast to the brief account of his other buildings, e.g. the palace, which, from an Oriental point of view, was of the first importance (vii. 1-12). But the Temple and palace were adjoining buildings, separated only by a wall (cf. Ezek. xlii. 20, xliii. 7 seq.), and it cannot be said that the former had originally the prominence now ascribed to it. Nor can the accounts given by Deuteronomic writers of its significance for the religious worship of Israel be used for an estimate of contemporary religion (v. 1-6, viii.). Whatever David had instituted at Jerusalem, it is at Gibeon that Solomon observed the opening sacrificial ceremonies, and there he received the divine revelation, "for that was the great high-place" (iii. 4 sqq.). Though this is justified by a late writer (iii. 2), subsequent history shows that the high-places, like the altars to heathen deities in Jerusalem itself, long remained undisturbed; it was the Deuteronomic reformation, ascribed to Josiah, which marked the great advance in the religion of Yahweh, and under its influence the history of the monarchy has been compiled. Moreover, with the emphasis which is laid upon the Jerusalem Temple is to be associated the new superiority of Zadok, the traditional ancestor of the Zadokites, the Jerusalem priests, whose supremacy over the other Levitical families only enters into the history of a much later age (see LEVITES).

In fact, Solomon, the pious saint, is not the Solomon of the earlier writings. Political, commercial and matrimonial alliances inevitably left their mark upon national religion, and the introduction of foreign cults which ensued is characteristically viewed as an apostasy from Yahweh of which he was guilty *in his old age*.³ The Deuteronomic writer finds in it the cause of the subsequent separation of the two kingdoms (xi. 1-13), and he connects it with certain external troubles which prove to have affected the *whole* course of his reign. The general impression of Solomon's position in history is in fact seriously disturbed when the composite writings are closely viewed. On the one side we see genial internal conditions prevailing in the land (iv. 20, 25), or the exalted position of the Israelites as officials and overseers, while the remnant of the pre-Israelite inhabitants serve in labour gangs (ix. 20 sqq.). On the other hand is the mass of toiling Israelites, whose oppressed condition is a prelude to the later dissensions (1 Kings v. 13 sqq.; cf. 1 Kings xii.; see the divergent tradition in 2 Chron. ii.). The description of Solomon's administration not only ignores the tribal divisions which play an important part in the separation of Israel from Judah (xii. 16; cf. 2 Sam. xix. 43-xx. 2), but represents a kingdom of modest dimensions in which Judah apparently is not included. Some north Judaeic cities might be named (iv. 9 seq.), but south Judah and Hebron the seat of David's early power find no place, and it would seem as though the district which had shared in the revolt of Adonijah was freed from the duty of furnishing supplies. But the document has intricate textual peculiarities and may be the Judaeic adaptation of a list originally written from the standpoint of the north-Israelite monarchy. Further speculation is caused when it is found that Solomon fortifies such cities as Megiddo, Beth-horon and Tamar, and that the Egyptian Pharaoh had slain the Canaanites of Gezer (ix. 15 sqq.). We learn, also, that Hadad, a young Edomite prince, had escaped the sanguinary campaign in the reign of David (2 Sam. viii. 13 seq.), and had taken refuge in Egypt. He was kindly received by Pharaoh, who gave him the sister of his queen Tahpenes to wife. On David's death he returned and ruled over Edom, thus not merely controlling the port of Elath and the trade-routes, but even (according to the Septuagint) oppressing Israel (xi. 14-22, 25, see Septuagint on v. 22).⁴ Moreover, an Aramaean dependant

³ On the relation between trade and religion in old Oriental life, see the valuable remarks by G. A. Smith, *Ency. Bib.* col. 5157 seq.

⁴ The narrative contains composite features (see the literature cited in article KINGS). There is a curious resemblance between one form of the story and the Septuagint account of the rise of Jeroboam (q.v.).

of Hadadezer, king of Zobah, to the north of Palestine (see David's war, 2 Sam. viii. 3 sqq., x. 6 sqq.), deserted his lord, raised a band of followers and eventually captured Damascus, where he established a new dynasty. Like Hadad, "he was an adversary to Israel all the days of Solomon" (xi. 23-25). To these notices must also be added the cession of territory in north Palestine to Hiram, king of Phoenicia (ix. 11). It is parenthetically explained as payment for building materials, which, however, are otherwise accounted for (v. 6, 11); or it was sold for 120 talents of gold (nearly £750,000 sterling), presumably to assist Solomon in continuing his varied enterprises—but the true nature of the transaction has been obscured, although the consequences involved in the loss of the territory are unmistakable. If these situations can with difficulty find a place in our picture of Solomon's might, it is clear that some of them form the natural introduction to the subsequent history, when his death brought internal discontent to a head, when the north under Jeroboam refused allegiance to the south, and when the divided monarchy enters upon its eventful career by the side of the independent states of Edom, Damascus and Phoenicia.

It is now generally recognized in histories of the Old Testament that a proper estimate of Solomon's reign cannot start from narratives which represent the views of Deuteronomic writers, although, in so far as late narratives may rest upon older material more in accordance with the circumstances of their age, attempts are made to present reconstructions from a combination of various elements. Among the recent critical attempts to recover the underlying traditions may be mentioned those of T. K. Cheyne (*Ency. Bib.*, art. "Solomon") and H. Winckler (*Keil-inschr. u. d. Alte Test.*, 3rd. ed., pp. 233 sqq.). But, in general, where the traditions are manifestly in a later form they are in agreement with later backgrounds, and it is questionable whether earlier forms can be safely recovered when it is held that they have been rewritten or when the historical kernel has been buried in legend or myth. It is impossible not to be struck with the growing development of the Israelite tribes after the invasion of Palestine, their strong position under David, the sudden expansion of the Hebrew monarchy under Solomon, and the subsequent slow decay, and this, indeed, is the picture as it presented itself to the last writers who found in the glories of the past both consolation for the present and grounds for future hopes. But this is not the original picture, and, since very contradictory representations of Solomon's reign can be clearly discerned, it is necessary in the first instance to view them in the light of an independent examination of the history of the preceding and following periods where, again, serious fluctuation of standpoint is found. Much therefore depends upon the estimate which is formed of the position of David (*q.v.*). See also **JEWES: History**, § 7 seq; **PALESTINE: Old Testament History**.

On Solomon's relation to philosophical and proverbial literature, see **PROVERBS**. Another aspect of his character appears in the remarkable "Song of Solomon," on which see **CANTICLES**. Still another phase is represented in the monologue of Ecclesiastes (*q.v.*). In the Book of Wisdom, again, the composition of an Egyptian Hellenist, who from internal evidence is judged to have lived somewhat earlier than Philo, Solomon is introduced uttering words of admonition, imbued with the spirit of Greek philosophers, to heathen sovereigns. The so-called Psalter of Solomon, on the other hand, a collection of Pharisee psalms written in Hebrew soon after the taking of Jerusalem by Pompey, and preserved to us only in a Greek version, has nothing to do with Solomon or the traditional conception of his person, and seems to owe its name to a transcriber who thus distinguished these newer pieces from the older "Psalms of David" (see **SOLOMON, PSALMS OF**). (S. A. C.)¹

SOLOMON ISLANDS (Ger., *Salomoinseln*), an archipelago of the Western Pacific Ocean, included in Melanesia, and forming a chain (in continuation of that of the Admiralty Islands and New Mecklenburg in the Bismarck Archipelago) from N.W. to S.E. between 154° 40' and 162° 30' E., 5° and 11° S., with a total land area of 17,000 sq. m. (For map, see **PACIFIC OCEAN**.) A comparatively shallow sea surrounds the islands and indicates physical connexion with the Bismarck Archipelago and New Guinea, whereas directly east of the Solomons there

are greater depths. The principal island at the north-west end of the chain is Bougainville (3900 sq. m.), and that at the south-east San Cristoval or Bauro. Between these the chain is double, consisting (from the north-west) of Choiseul (2260 sq. m.), Isabel (Ysabel, of about the same area as Choiseul) and Malaita (2400 sq. m.) to the north, and Vella Lavella, Ronongo, Kulambangra, Kausagi, Marovo (New Georgia or Rubiana) and the Hammond Islands, and Guadalcanar² or Guanbata (2500 sq. m.). Between and around these main islands there are many smaller islands. Ongtong Java, a coral reef of many islets, lies considerably north of the main group to which, geographically, it can hardly be said to belong.³ Bougainville, the largest of the group, contains Mt Balbi (10,170 ft.), and two active volcanoes. In Guadalcanar is Mt Lammas (8000 ft.), while the extreme heights of the other islands range between 2500 and 5000 ft. The islands (by convention of 1899) are divided unequally between Great Britain and Germany, the boundary running through Bougainville Strait, so that that island and Buka belong to Germany (being officially administered from Kaiser Wilhelm's Land), but the rest (South Solomons) are British.

The islands are well watered, though the streams seem to be small; the coasts afford some good harbours. All the large and some of the small islands appear to be composed of ancient volcanic rock, with an incrustation of coral limestone showing here and there along the coast. The mountains generally fall steeply to the sea. There is some level land in Bougainville, but little elsewhere. Deep valleys separate the gently rounded ridges of forest-clad mountains, lofty spurs descend from the interior, and, running down to the sea, terminate frequently in bold rocky headlands 800 to 1000 ft. in height, as in San Cristoval (north coast). On the small high island of Florida there is much undulating grass-land interspersed with fine clumps of trees; patches of cultivated land surround its numerous villages, and plantations on the hill-sides testify to the richness of its soil. The whole chain of islands appears to be rising steadily. Some of the smaller islands are of recent calcareous formation. Barrier and fringing reefs, as well as atolls, occur in the group, but the channels between the islands are dangerous chiefly from the strong currents which set through them.

The climate is very damp and debilitating. The rainfall is unusually heavy. Fever and ague prevail on the coast. The healthiest portions are the highlands, where most exposed to the south-east trades. The dry season, with north-west winds, lasts from December to May. Vegetation is luxuriant; magnificent forests clothe the mountains, and sandalwood, ebony and lignum vitae, besides a variety of palms, are found in them. Mangrove swamps are common on the coasts. The probable geological connexion with New Guinea would account for the Papuan character of the fauna of the Solomons, which form the eastern limit of certain Papuan types. The existence of peculiar types in the Solomons, however, points to an early severance. Mammals are not numerous; they include the cuscus, several species of bat, and some rats of great size. There are various peculiar species of frogs, lizards and snakes, including the great frog *Rana Guppyi*, from 2 to 3 lb in weight. Of birds, several parrots and other genera are characteristically Papuan and are unknown east of the Solomons.

Population.—The Solomon islanders are of Melanesian (Papuan) stock, though in different parts of the group they vary considerably in their physical characteristics, in some islands approaching the pure Papuan, in some showing Polynesian crossings and in others resembling the Malays. As a race they are small and sturdy, taller in the north than in the south. Projecting brows, deeply sunk dark eyes, short noses, either straight or arched, but always depressed at the root, and moderately thick lips, with a somewhat receding chin, are general characteristics. The mesocephalic appears to be the preponderant form of skull; though this is unusual among Melanesian races. In colour the skin varies from a black-brown to a copperish hue, but the darker are the most common shades. The hair is naturally dark, but is often dyed red or fawn, and crisp, inclining to woolly. The islanders of the Bougainville Straits have lank, almost straight, black hair and very dark skins.

To strangers the natives have long had the reputation of being treacherous. They are cannibals, infanticide is common, and head

² Guadalcanal of the Spanish discoverers.

³ This group, so named by Abel Tasman in 1643, is also called Leutenewa or Lord Howe, and is densely inhabited by natives said to be of Polynesian origin.

¹ Some sentences from W. R. Smith's article in *Ency. Brit.*, 9th ed., have been retained and in places modified.

hunting was formerly prevalent. The average lot of the women is that of slaves. In some cases there is belief in a good spirit inhabiting a pleasant land, and an evil spirit associated with a volcano; also in a future life. The language is of pure Melanesian type, though a number of dialects are spoken. The natives are good agriculturists. The Solomon Islands are, in the Pacific, the eastern limit of the use of the shield. The canoes are skilfully built of planks sewn together and caulked. The high carved prow and stern give the craft almost a crescent shape. These and the gunwale are tastefully inlaid with mother-of-pearl and wreathed with shells and feathers.

The British islands are under a resident commissioner, and have some trade in copra, ivory, nuts, pearl shell and other produce. Coco-nuts, pine-apples and bananas, with some cocoa and coffee, are cultivated on small areas. The German islands have a small trade in sandalwood, tortoise-shell, &c. The total population may be roughly estimated at 180,000.

History.—The Spanish navigator Alvaro Mendaña must be credited with the discovery of these islands in 1567, though it is somewhat doubtful whether he was actually the first European who set eyes on them. In anticipation of their natural riches he named them *Islas de Salomon*. The expedition surveyed the southern portion of the group, and named the three large islands San Cristoval, Guadalcanal and Ysabel. On his return to Peru, Mendaña endeavoured to organize another expedition to colonize the islands, but it was not before June 1595 that he, with Pedro Quiros as second in command, was able to set sail for this purpose. The Marquesas and Santa Cruz islands were now discovered; but on one of the latter, after various delays, Mendaña died, and the expedition collapsed.

Even the position of the Solomon Islands was now in uncertainty, for the Spaniards, fearing lest they should lose the benefits expected to accrue from these discoveries, kept secret the narratives of Mendaña and Quiros. The Solomon Islands were thus lost sight of until, in 1767, Philip Carteret lighted on their eastern shores at Gower Island, and passed to the north of the group, without, however, recognizing that it formed part of the Spanish discoveries. In 1768 Louis de Bougainville found his way thither. He discovered the three northern islands (Buka, Bougainville and Choiseul), and sailed through the channel which divides the two last and bears his name. In 1769 a French navigator, M. de Surville, was the first, in spite of the hostility of the natives, to make any lengthened stay in the group. He gave some of the islands the French names they still bear,¹ and brought home some detailed information concerning them which he called *Terre des Arsacides* (Land of the Assassins); but their identity with Mendaña's *Islas de Salomon* was soon established by French geographers. In 1788 the English lieutenant Shortland coasted along the south side of the chain, and supposing it to be a continuous land, named it New Georgia; and in 1792 Captain Edward Manning sailed through the strait which separates Ysabel from Choiseul and now bears his name. In the same year, and in 1793, d'Entrecasteaux surveyed portions of the coast-line of the large islands. Dumont d'Urville in 1838 continued the survey.

Traders now endeavoured to settle in the islands, and missionaries began to think of this fresh field for labour, but neither met with much success, and little was heard of the islanders save accounts of murder and plunder. In 1845 the French Marist Fathers went to Isabel, where Mgr Epaulle, first vicar-apostolic of Melanesia, was killed by the natives soon after landing. Three years later this mission had to be abandoned; but in 1881 work was again resumed. In 1856 John Coleridge Patteson, afterwards bishop of Melanesia, had paid his first visit to the islands, and native teachers trained at the Melanesian mission college subsequently established themselves there. About this date the yacht "Wanderer" cruised in these seas, but her owner, Mr Benjamin Boyd, was kidnapped by the natives and never afterwards heard of. In 1873 the "foreign-labour" traffic in plantation hands for Queensland and Fiji extended its baneful influence from the New Hebrides to these islands. In 1893 the islands Malaita, Marovo, Guadalcanar

¹ He called Gower, Inattendue; Ulava, Contrariété; and named Port Praslin, the harbour at the north-west of Ysabel.

and San Cristoval with their surrounding islets were annexed by Great Britain, and the final delimitation of German and British influence in the archipelago was made by the convention of the 14th of November 1899.

See H. B. Guppy, *The Solomon Islands* (London, 1887), where full references to earlier works are given; C. Ribbe, *Zwei Jahre unter den Kannibalen der Salomon-Inseln* (Dresden, 1903).

SOLOMON, ODES OF, a collection of 42 hymns, probably dating from the end of the 1st century, known to the early Christian Church (as is proved by the quotations and comments in the 3rd century gnostic book, *Pistis Sophia*, and a short extract in the *Institutes* of Lactantius). They were recovered by Dr Rendel Harris in 1908 from a 16th-century Syriac manuscript (containing also the *Psalms of Solomon*, see below) in his possession. The first, second, and part of the third odes are missing, but the first has been restored from the *Pistis Sophia*. Of their authorship nothing is known, "Solomon" being a recognized pseudonym. While there are thoughts and expressions which lend themselves to gnostic use, there is nothing in the odes which is of distinctively gnostic origin. Many of them, indeed, are unmistakably Christian, and the writer of the *Pistis Sophia* seems to have regarded them as almost if not quite canonical, a fact which secures at latest a 2nd-century origin. Dr Harris indeed would date several of them between A.D. 75 and 100. They contain few traces of the New Testament, and the words "gospel" and "church" are not found. Here and there a Johannine atmosphere is detected, though not sufficiently to justify the assumption that the author knew the writer of the Fourth Gospel. References to the life and teaching of Christ are rare, though the Virgin Birth is alluded to in Ode 19 in a passage marked by legendary embellishment, and the descent into Hades is spoken of in quite the apocryphal style in Ode 42. These odes are probably among the latest in the book. There are no clear allusions to baptism and none at all to the eucharistic celebration. One passage speaks of ministers (perhaps=deacons) who are entrusted with the water of life to hand to others; the word "priest" occurs once, at the beginning of Ode 20, "I am a priest of the Lord, and to Him I do priestly service, and to Him I offer the sacrifices of His thought." The odes, which are perhaps the product of a school of writers, and were originally written in Greek, vary in execution and spiritual tone, but are generally characterized by a buoyant feeling of Christian joy. Harnack considers that they form a Jewish *Grundschrift*, with a number of Christian interpolations; only two are "purely Christian," while several "colourless" ones are more likely Jewish. He finds in them a link between the piety and theology of the *Testaments of the Twelve Patriarchs* and that of the Johannine gospel and epistles.

See J. Rendel Harris, *The Odes and Psalms of Solomon* (1909); *An Early Christian Psalter* (1909); Joh. Flemming and A. Harnack, *Ein jüdisch-christliches Psalmbuch aus dem ersten Jahrhundert* (Leipzig, 1910); *The Times* (April 7, 1910); W. E. Barnes, in *Journ. of Theol. Studies*, xi. 615, and *The Expositor* (July 1910); F. Spitta, in *Zeitschrift für N.T. Wissenschaft*, xi. 193.

SOLOMON, PSALMS OF. These psalms, eighteen in all, enjoyed but small consideration in the early Christian Church; for only six direct references to them are found in early Christian literature, though in the Jewish Church they must have played an important rôle; for they were used in the worship of the synagogue.

They were of course not written by Solomon, but were subsequently ascribed to him. The fact that they do not contain a single reference to Solomon is in favour of their having been first published anonymously. On the other hand, their author (or authors) may have placed over them the superscription "Psalms of Solomon" in order to gain currency for this new collection under the shelter of a great name of the past.

MSS. AND TEXTS.—Before the publication of Swete's second edition and the edition of von Gebhardt, only five MSS., A, H, V, M, P (of which H represents the Copenhagen MS.) were known, and these were utilized to the full in the splendid edition of Ryle and James (*ᾠδαὶ Σολομῶντος, Psalms of the Pharisees commonly called the Psalms of Solomon, the Text newly revised from all the MSS., 1891*). In Swete's edition (*The Old Testament in Greek*,² 1894) there was given in addition to the above a collation of the Vatican

MS. R. Finally in 1895, von Gebhardt published from five MSS. his edition entitled *Ψαλμοὶ Σολομῶντος, Die Psalmen Salomos zum erstenmale mit Benutzung der Athoshandschriften und des Cod. Casanatensis herausgegeben*. The five MSS. used by this last editor are C, H, J, L, R, of which C, J, L are exploited for the first time and represent respectively the MSS. Casanatensis, Iberiticus and Laura-Kloster. He represents the affinities of the MSS. in the following table, where Z stands for the archetype:—

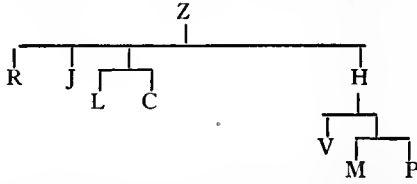

Thus H is the only MS. common to this edition and that of Ryle and James; for Gebhardt regards the secondary MSS. V, M, P as not deserving consideration. Notwithstanding there is a much finer critical training for the student in the textual discussions and retroversions in the latter edition than in the former.*

TRANSLATIONS.—Wellhausen, *Die Pharisäer und die Sadducäer* (1874), 131 sqq. This translation is unfortunately based on the *editio princeps* of De la Cerda published in 1626. Pick's translation which appeared in the *Presbyterian Review* for October 1883, pp. 775-813, is based on the same text and is imperfect owing to a faulty knowledge of English. Ryle and James (*op. cit.*). Kittel's translation (Kautzsch, *Apokr. u. Pseudep.* i. 1900, ii. 127 sqq.) was made from von Gebhardt's text.

The Original Language.—All modern scholars are practically agreed that the Psalms were written in Hebrew. It is unnecessary to enter into this question here, but a point or two might be mentioned which call for such a presupposition. (i.) First we find that, after the manner of the canonical Psalms, the musical symbol *דָּבָלָמָא* (דָּבָלָמָא) is inserted in xvii. 31 and xviii. 10, a fact which points to their use in the divine worship in the synagogue. (ii.) Next we find that a great number of passages cannot be understood unless by retroversion into Hebrew, when the source of the error becomes transparent. One such instance occurs in ii. 29, *τοῦ εἰπεῖν τὴν ὑπερηφανίαν τοῦ δράκοντος ἐν ἀτιμίᾳ*. Here *εἰπεῖν*, which is utterly meaningless, = *קָבַל* a corruption of *קָבַל* or *קָבַל* "to change," "turn" (Wellhausen). Thus we arrive at the sense required, "To turn the pride of the dragon into dishonour." (iii.) Finally, there are several passages where the text exhibits the future tense, when it ought to give the past imperfect. This phenomenon can easily be explained as a false rendering of the Hebrew imperfect.¹

Date.—The date can be determined from references to contemporary events. Thus the book opens with the alarms of war (i. 2, viii. 1), in the midst of a period of great prosperity (i. 3, 4, viii. 7), but the prosperity is merely material, for from the king to the vilest of his subjects they are altogether sinful (xvii. 21, 22). The king, moreover, is no descendant of David, but has usurped his throne (xvii. 6-8). But judgment is at hand. "A mighty striker" has come from the ends of the earth (viii. 16), who when the princes of the land greeted him with words of welcome (viii. 18), seized the city (viii. 21), cast down its walls (ii. 1), polluted its altar (ii. 2), put its princes and counsellors to the sword (viii. 23), and carried away its sons and daughters captive to the west (viii. 24, xvii. 14). But the dragon who conquered Jerusalem (ii. 29), and thought himself to be more than man (ii. 32, 33), at last meets with shameful death on the shores of Egypt (ii. 30, 31).

The above allusions are easy to interpret. The usurping kings who are not descended from David are the Maccabeans. The "mighty striker" is Pompey. The princes who welcomed his approach are Aristobulus II. and Hyrcanus II. Pompey carried off princes and people to the west, and finally perished on the coast of Egypt in 48 B.C. Thus Ps. ii. was written soon after 48 B.C., while Ps. i., viii., xvii. fall between 63 and 48 B.C., for they presuppose Pompey's capture of Jerusalem, but show no knowledge of his death. Ps. v., vii., ix., xiii., xv.

¹ In addition to Ryle and James, *Introd.* pp. lxxvii.-lxxviii., see Perles, "Die Erklärung der Psalm. Sal." (*Oriental. Litteraturzeit.*, 1902, v. 7-10).

belong apparently to the same period, but iv. and xii. to an earlier one. On the whole Ryle and James are right in assigning 70-40 B.C. as the limits within which the psalms were written.

Authorship.—The authors were Pharisees. They divide their countrymen into two classes—"the righteous" (ii. 38-39, iii. 3-5, 7, 8), and "the sinners" (ii. 38, iii. 13, iv. 9); "the saints" (iii. 10) and "the transgressors" (iv. 11). The former are the Pharisees; the latter the Sadducees. The authors protest against the Asmonaeon (*i.e.* the Maccabees) for usurping the throne of David and laying violent hands on the high priesthood (xvii. 5, 6, 8), and proclaim the coming of the Messiah, the true son of David (xvii. 23-25), who is to set all things right and establish the supremacy of Israel. The Messiah is to be pure from sin (xvii. 41), purge Jerusalem from the defilement of sinners and of the Gentiles (xvii. 29, 30, 36), destroy the hostile nations and extend his righteous rule over all the remaining peoples of the earth (xvii. 27, 31, 32, 34, 38).²

Ps. xvii., xviii. and i.-xvi. can hardly be assigned to the same authors. The hopes of the Messiah are confined to the former, and a somewhat different eschatology underlies the two works (see Charles, *Eschatology: Hebrew, Jewish and Christian*, 220-225).

In addition to the literature mentioned above, also in Ryle and James's edition and Schürer, *Gesch. des jüd. Volkes*, 3rd ed., iii. 150 sqq, see *Ency. Bib.* i. 241-245.

(R. H. C.)

SOLON (7th and 6th century B.C.), Athenian statesman, the son of Execestides of the family of Codrus, was born about 638 B.C. The prodigality of his father made it necessary for Solon to maintain himself by trade, especially abroad. In his youth he became well known as the author of amatory poems and later of patriotic and didactic verse. Hence his inclusion among the Seven Sages. Solon's first public service was the recovery of Salamis from the Megarians. A law had been passed forbidding any reference to the loss of the island; Solon solved the difficulty by feigning madness, and reciting an inflammatory poem in the agora. It appears that Solon was appointed to recover the "fair island" and that he succeeded in expelling the Megarians. Sparta finally arbitrated in favour of the Athenians (*c.* 596), who ascribed their success to Solon. About a year later he seems to have moved a decree before the Amphictyons declaring war on Cirrha. At this period the distress in Attica and the accumulating discontent of the poorer classes, for whom Draco's code had proved inadequate, reached its height. Solon was summoned by all classes unanimously to discover a remedy; under the legal title of Archon, he received unlimited powers which he exercised in economic and constitutional reforms (see below). From various sources we learn that these reforms met with considerable opposition, to escape from which Solon left Athens for ten years. After visiting Egypt, he went to Cyprus, where Philocyprus, king of Aepea, received him with honour. Herodotus (v. 113) says that Philocyprus, on the advice of Solon, built himself a new town called, after his guest, Soli. The story that Solon visited Croesus in Lydia, and made to him the famous remark—"Call no man happy till he is dead"—is unfortunately discredited by the fact that Croesus seems to have become king nearly thirty years after Solon's legislation, whereas the story must be dated within ten years of it. Subsequently Solon returned to Athens, to find civil strife renewed, and shortly afterwards his friend (perhaps his relative) Peisistratus made himself tyrant. About 558 B.C. Solon died, and, according to the story in Diogenes Laërtius i. 62 (but see Plutarch's *Solon*, 32), his ashes were scattered round the island of Salamis. If the story is true, it shows that he was regarded as the oecist of Salamis.

Reforms.—The date of Solon's archonship has been usually fixed at 594 B.C. (Ol. 46. 3), a date given by Diog. Laërt. (i. 62) on the evidence of the Rhodian Sosicrates (*fl.* 200-128 B.C.; see Clinton, *Fast. Hell.* ii. 298, and Busolt, 2nd ed., ii. 259). The date 594 is confirmed by statements in the Aristotelian *Constitution of Athens* (ch. 14). For various reasons, the dates 592, ²The conception of the Messiah is vigorous, but the influence of such a conception was hurtful; for by connecting the Messianic with the popular aspirations of the nation, the former were secularized and the way prepared for the ultimate destruction of the nation.

591 and even 590 have been suggested by various historians (for the importance of this question see the concluding paragraph of this article). The historical evidence for the Solonian reforms has always been unsatisfactory. There is strong reason to conclude that in the 5th and 4th centuries there was no general tradition as to details. In settling differences there is no appeal to tradition, and this though there occur radical and insoluble contradictions. Thus the *Constitution of Athens* (ch. vi.) says that the Seisachtheia ("shaking off of burdens") consisted in a cancelling of all debts public and private, whereas Androtion, an elder contemporary, denies this specifically, and says that it consisted in the reduction of the rate of interest and the debasement of the coinage. The *Constitution* (ch. x.) denies the existence of any connexion between the coinage reform and the relief of debtors. The absence of tradition is further confirmed by the fact that the *Constitution* always appeals for corroboration to Solon's *Poems*. Of the *Laws* it is probable that in the 4th century, though some dealing with agrarian distress were in existence, those embodying the Seisachtheia were not, and few if any of the purely constitutional laws remained. The main source of the account in the *Constitution* is, therefore, the *Poems* of Solon, from which numerous quotations are made (see chs. 5-12).

The reforms of Solon may be divided under three heads—economic, constitutional and miscellaneous. They were necessary owing mainly to the tyrannical attitude of the rich to the poorer classes. Of these many had become slaves in lieu of payment of rent and loans, and thus the land had fallen gradually into the hands of the capitalists. It was necessary to readjust the economic balance and to provide against the evil of aristocratic and capitalist predominance.

A. Economic Reforms.—Solon's economic reforms consisted of the Seisachtheia and certain commercial laws (e.g. prevention of export trade except in olive oil, *Plut. Sol.* 24). Among all the problems connected with the Seisachtheia, it is clear (1) that Solon abolished the old Attic law of debt which permitted loans on the security of the debtor's person; (2) that he restored to freedom those who had been enslaved for debt; (3) that he refused the demand for the division of the land (γῆς ἀνάσσωμος). As to the cancelling of all debts (χρεῶν ἀποκοπή) there is some controversy; Gilbert and Busolt maintain that all debts were cancelled; strong reasons, may however, be advanced against it. It is possible that the statement in the *Constitution* is a hypothesis to explain the restoration of the slaves to freedom. Further, Solon seems to have regulated the accumulation of land (cf. in Rome the legislation of Tiberius Gracchus) and the rate of interest; and to have simplified commerce by replacing the Pheidonian standard by the Euboic, which was in use among the Ionian traders, in commerce with whom he foresaw that prosperity lay. It is impossible here to enter into the details of the controversy in connexion with Solon's land reforms; it must suffice to give the bare outlines of the dispute. There is no question that (1) the distressed class whom Solon sought to relieve were the *Hektemors*, and that (2) the achievement on which he prided himself was the removal of the *ῥοοὶ* or stones which were seen everywhere in Attica, and were symbolic of the slavery of the soil. Almost all writers say that these *ῥοοὶ* were mortgage-pillars: that they were originally boundary stones and that when land was mortgaged the terms of the agreement were carved on the stones, as evidence. Now firstly, though such mortgage-pillars existed in the time of Demosthenes, none are found earlier than the year 400 B.C., nor is there any reference before that year to this special sense of the word. If then these stones which Solon removed were mortgage-pillars, it is strange that none should have been found till two hundred years later. Secondly, it is highly improbable that the terms on which land was then cultivated admitted of mortgaging at all. The *Hektemors*, who, according to the *Constitution*, paid the sixth part of their produce as rent,¹ were not freeholders but tenants, and therefore, could not mortgage their land at all. From this it follows that when Solon said he had "removed the stones" he referred to the fatal accumulation of land by landowners. The tenants failed to pay rent, were enslaved, and the "boundary stone" of the landowner was moved forward to include their land. Thus the removal of the *ῥοοὶ* was a measure against the accumulation of land in the form of enclosures (τεμνῆ), and fits in with the statement at the end of chapter iv. of the *Constitution*,

¹ Others say they were: (1) labourers who received one-sixth of the produce as wages; (2) tenants who paid five-sixths as rent and kept one sixth, or (3) tenants who paid one-sixth as rent and kept five-sixths. As to (3) it is said such tenants could not have been in real distress, and as to (1) and (2) it is said that such a position would have meant starvation from the first.

"the land was in the hands of a few." It should be noted (1) that from this releasing of the land it follows that Solon's law against lending on the security of the person must have been retrospective (i.e. in order to provide a sufficient number of freeholders for the land released); and (2) that it is one of the most remarkable facts in Athenian economic history that when at the end of the Peloponnesian War a proposal was brought forward to limit the franchise to freeholders, it was found that only five thousand failed to satisfy this requirement.

B. Constitutional Reforms.—It is on this part of his work that Solon's claim to be considered a great statesman is founded. By his new constitution he laid the foundations of the Athenian democracy and paved the way for its later developments. It should be noted in the first place that the following account is written on the assumption that the Draconian constitution described in chapter iv. of the *Constitution of Athens* had never existed (see DRACO). In some respects that alleged constitution is more democratic than Solon's. This, coupled with the fact that Solon is always spoken of as the founder of democracy, is one of the strongest reasons for rejecting the Draconian constitution. It will be seen that Solon's state was by no means a perfected democracy, but was in some respects rather a moderate oligarchy in which political privilege was graduated by possession of land. To Solon are generally ascribed the four classes—Pentacosiomedimni, Hippeis, Zeugitae and Thetes. Of these the first consisted of those whose land produced as many measures (*medimni*) of corn and as many measures (*metretae*) of oil and wine as together amounted to 500 measures. The Hippeis (the horsemen, i.e. those who could provide a war-horse for the service of the state) were rated at over 300 and under 500 medimni; the third class (those who tilled their land with a yoke of oxen) at 200 medimni and the Thetes below 200 medimni. The Zeugites probably served as heavy-armed soldiers, and the Thetes were the sailors of the state. It is likely that the Zeugites were mainly *Hektemors* (see above) whom Solon converted into freeholders. Whether Solon invented these classes is uncertain, but it seems clear that he first put them into definite relation with the political organism. The Thetes (who included probably the servants of the Eupatridae, now secured as freemen), the fishermen of the Paralia (or sea-coast), and the artisans (*cerameis*) of Athens for the first time received political existence by their admission to the sovereign assembly of the Ecclesia (*q.v.*). Of these classes the first alone retained the right of holding the offices of archon and treasurer; other offices were, however, opened to the second and third classes (sc. the Poletae, the Eleven and the Colacretae; see CLEISTHENES [I.] footnote). It is of the utmost importance to observe that the office of Strategus (*q.v.*) is not mentioned in connexion with Solon's reform. It is often said that Solon used his classification as the basis of a sliding scale of taxation. Against this, it is known that Peisistratus, whose faction was essentially the poorer classes, established a uniform 5% tax, and it is highly unlikely that he would have reversed an existing arrangement which was particularly favourable to his friends. The admission of the Thetes to the Ecclesia was an important step in the direction of democracy (for the powers which Solon gave to the Ecclesia, see ECCLESIA). But the greatest reform of Solon was undoubtedly the institution of the Heliaca (or courts of justice). The jury were appointed by lot from all the citizens (including the Thetes), and thus the same people elected the magistrates in the Ecclesia and subsequently tried them in the Heliaca. Hence Solon transferred the sovereign power from the areopagus and the magistrates to the citizens as a whole. Further, as the archons, at the expiry of their year of office, passed into the areopagus, the people exercised control over the personnel of that body also (see AREOPAGUS). In spite of the alleged Draconian constitution, alluded to above, it is still very generally held that Solon invented the Boulē or Council of Four Hundred, one hundred from each of the old tribes. The importance of this body as an advisory committee of the Ecclesia, and the functions of the Prytaneis are explained under BOULĒ. It is sufficient here to point out that, according to Plutarch's *Solon* (ch. 19) the state henceforth rested on two councils "as on anchors," and that the large powers exercised by the Cleisthenean Boulē were not exercised by the Solonian. From this, and the articles AREOPAGUS, BOULĒ, ECCLESIA and GREEK LAW, it will be seen that Solon contrived an absolutely organic constitution of a "mixed" type, which had in it the seeds of the great democratic growth which reached its maturity under Pericles. It should be added here, in reference to the election of magistrates under Solon's constitution, that there is discrepancy between the *Politics* and the *Constitution*; the latter says that Solon gave to the Thetes nothing but a share in the Ecclesia and the courts of justice, and that the magistrates were elected by a combination of selection and lot (κληρώσει ἐκ προκλήσεων), whereas the *Politics* says that Solon gave them only the power to elect the magistrates and try them at the end of their year. It seems likely for other reasons that the former scheme should be assigned to the years after Marathon, and, therefore, that the account in the *Politics* is correct (but see ARCHON).

C. Miscellaneous.—The miscellaneous laws of Solon are interesting primarily as throwing light upon the social condition of Athens at the time (see Evelyn Abbot, *History of Greece*, I. xiii. § 18).

In the matter of trade it has been said that he favoured one export only, that of olive oil, in which Athens was peculiarly rich; further he encouraged the settlement of aliens (*metoeci*) engaged in commerce, and compelled fathers to teach their sons a useful trade under penalty of losing all right to support in old age. The influence of women Solon regarded as most pernicious. Wealthy wives he forbade; no bride might bring more than three changes of raiment and a little light furniture to the house; all brothels and gymnasia were put under stringent state-control (see PROSTITUTION). Solon also regulated intestate succession, the marriage of heiresses, adoption, the use and sinking of wells, bee-farming, the planting of olives and figs, the cutting down of olive trees, the calendar. Further, he ordained that each citizen must show how he obtained his living (Herod. ii. 177) and must, under penalty of losing the franchise, adhere to one or other party in a sedition (for these laws see Plutarch's *Solon*, chs. 20-24).

The laws were inscribed on *Kyrbais* or tablets framed in wood which could be swung round (hence also called *axones*). The *boulé* as a body swore to observe the laws, and each archon undertook to set up a life-size golden statue at Delphi if he should be convicted of transgressing them.

Solon appears to have supplemented his enactments by a law that they should remain in force for one hundred years, and according to another account that his laws, though not the best, should stand unchanged for ten years (Plut. *Solon*, 25; Herod. i. 29). Yet according to the *Constitution of Athens* (chs. 11-13) (without which the period from Solon to Peisistratus was a blank), when Solon went abroad in 593(?) the city was disturbed, and in the fifth year dissension became so acute that no archon was elected (for the chronological problem, see J. E. Sandys, *Constitution of Athens*, ch. 13, note); again four years later the same *anarchia* (i.e. no archon elected) occurred. Then four years later the archon Damasias (582?) continued in office illegally for two years and two months. The office of the archon was then put into commission of ten: five from the Eupatrids, three from the Agroeci and two from the Demurgi, and for twenty years the state was in a condition of strife. Thus we see that twelve years of strife (owing to Solon's financial reforms) ended in the reversal of Solon's classification by assessment. We are, therefore, driven to conclude that the practical value of his laws was due to the strong and enlightened government of Peisistratus, whose tyranny put an end to the quarrels between the Shore, the Upland and the Plain, and the *stasis* of rich and poor.

See editions with notes of *Constitution of Athens* (q.v.); histories of Greece later than 1891 (e.g. Busolt, &c.). See also Gilliard, *Quelques réformes de Solon* (1907); Cavaignac, in *Revue de Philol.*, 1908. All works anterior to the publication of the *Constitution* are so far out of date, but reference should be made to the work of Grote. (J. M. M.)

SOLSTICE (Lat. *solstitium*, from *sol*, sun, and *sistere*, to stand still), in astronomy either of the two points at which the sun reaches its greatest declination north or south. Each solstice is upon the ecliptic midway between the equinoxes, and therefore 90° from each. The term is also applied to the moment at which the sun reaches the point thus defined.

SOLUNTUM (Gr. *Σολοῦς* or *Σολοῦς*), an ancient town of Sicily, one of the three chief Phoenician settlements in the island, situated on the north coast, 10 m. E. of Panormus (Palermo), 600 ft. above sea-level, on the S.E. side of Monte Catalfano (1225 ft.), in a naturally strong situation, and commanding a fine view. The date of its first occupation is, like that of Panormus, unknown. It continued to be a Carthaginian possession almost uninterruptedly until the First Punic War, when, after the fall of Panormus, it opened its gates to the Romans. In the Roman period it seems to have been of no great importance; an inscription, erected by the citizens in honour of Fulvia Plautilla, the wife of Caracalla, was found there in 1857. It was perhaps destroyed by the Saracens and is now entirely deserted. Excavations have brought to light considerable remains of the ancient town, belonging entirely to the Roman period, and a good deal still remains unexplored. An archaic oriental Artemis sitting between a lion and a panther; found here, is in the museum at Palermo, with other antiquities from this site. With the exception of the winding road by which the town was approached on the south, the streets, despite the unevenness of the ground, which in places is so steep that steps have to be introduced, are laid out regularly, running from east to west and from north to south, and intersecting at right angles. They are as a rule paved with slabs of stone. The houses were constructed of rough walling, which was afterwards plastered over; the natural rock is often used for the lower part of the walls. One of the largest of them, with a peristyle, is currently, though

wrongly, called the Gymnasium. Near the top of the town are some cisterns cut in the rock, and at the summit is a larger house than usual, with mosaic pavements and paintings on its walls. (T. As.)

SOLUTION (from Lat. *solvere*, to loosen, dissolve). When a solid such as salt or sugar dissolves in contact with water to form a uniform substance from which the components may be regained by evaporation the substance is called a solution. Gases too dissolve in liquids, while mixtures of various liquids show similar properties. Certain solids also consist of two or more components which are united so as to show similar effects. All these cases of solution are to be distinguished from chemical compounds on the one hand, and from simple mixtures on the other. When a substance contains its components in definite proportions which can only change, if at all, by sudden steps, it may be classed as a chemical compound. When the relative quantities of the components can vary continuously within certain limits, the substance is either a solution or a mixture. The distinction between these two classes is not sharp; though when the properties of the resultant are sensibly the sum of those of the pure components, as is nearly the case for a complex gas such as air, it is usual to class it as a mixture. When the properties of the resultant substance are different from those of the components and it is not a chemical compound we define it as a solution.

Historical.—Solutions were not distinguished from definite chemical compounds till John Dalton discovered the laws of definite and multiple proportions, but many earlier observations on the solubility of solids in water and the density of the resulting solutions had been made. As early as 1788 Sir Charles Blagden (1748-1820) made measurements of the freezing points of salt solutions, and showed that the depression of freezing point was roughly proportional to the amount of salt dissolved. About 1850 Thomas Graham published his famous experiments on diffusion, both with and without a separating membrane. In 1867 botanical investigations by M. Traube, and in 1877 others by W. Pfeffer, made known the phenomena of the osmotic pressure which is set up by the passage of solvent through a membrane impermeable to the dissolved substance or solute. The importance of these experiments from the physical point of view was recognized by J. H. van't Hoff in 1885, who showed that Pfeffer's results indicated that osmotic pressure of a dilute solution conformed to the well-known laws of gas pressure, and had the same absolute value as the same number of molecules would exert as a gas filling a space equal to the value of the solvent. The conception of a semi-permeable membrane, permeable to the solvent only, was used by van't Hoff as a means of applying the principles of thermodynamics to the theory of solution.

Another method of applying the same principles is due to J. Willard Gibbs, who considered the whole problem of physical and chemical equilibrium in papers published in 1877, though the application of his principles only began to make extensive progress about twenty years after the publication of his purely theoretical investigations. The phenomena of solution and of vapour pressure constitute cases of equilibrium, and conform to the laws deduced by Gibbs, which thus yield a valuable method of investigating and classifying the equilibria of solutions.

Solubility.—Some pairs of liquids are soluble in each other in all proportions, but, in general, when dealing with solutions of solids or gases in liquids, a definite limit is reached to the amount which will go into solution when the liquid is in contact with excess of the solid or gas. This limit depends on the nature of the two components, on the temperature and on the pressure. When the limit is reached the solution is said to be saturated, and the system is in equilibrium. If the solution of a solid more soluble when hot be cooled below the saturation point, the whole of the solid sometimes remains in solution. The liquid is then said to be supersaturated. But here the conditions are different owing to the absence of solid. If a crystal of the solid be added, the condition of supersaturation is destroyed,

and the ordinary equilibrium of saturation is reached by precipitation of solid from solution.

The quantity of substance, or solute, which a given quantity of liquid or solvent will dissolve in presence of excess of the solute measures the solubility of the solute in the given solvent in the conditions of temperature and pressure. The solubilities of solids may be expressed in terms of the mass of solute which will dissolve in 100 grammes of water.

The following may be taken as examples:—

Solute.	Chemical Constitution of the Solid.	Solubility		
		at 0° C.	at 20° C.	at 100° C.
Sodium chloride	NaCl	35.7	36.0	39.8
Potassium nitrate	KNO ₃	13.3	31.2	247.0
Barium chloride	BaCl ₂	30.9	35.7	58.8
Copper sulphate	CuSO ₄	15.5	22.0	73.5
Calcium carbonate	CaCO ₃	0.0018	—	0.0018
Silver nitrate	AgNO ₃	121.9	227.3 (at 19°·5)	1111.0 (at 110°)

When dealing with gases it is usually more convenient to express the solubility as the ratio of the volume of the gas absorbed to the volume of the absorbing liquid. For gases such as oxygen and nitrogen dissolved in water the solubility as thus defined is independent of the pressure, or the mass of gas dissolved is proportional to the pressure. This relation does not hold for very soluble gases, such as ammonia, at low temperatures. As a general rule gases are less soluble at high than at low temperatures—unlike the majority of solids. Thus oxygen, 4.89 volumes of which dissolve at atmospheric pressure in 1 volume of water at 0° C., only dissolves to the extent of 3.10 volumes at 20° and 1.70 volumes at 100°.

Cause of Solubility.—At the outset of the subject we are met by a fundamental problem, to which no complete answer can be given: Why do certain substances dissolve in certain other substances and not in different substances? Why are some pairs of liquids miscible in each other in all proportions, while other pairs do not mix at all, or only to a limited extent? No satisfactory correlation of solubility with chemical or other properties has been made. It is possible to state the conditions of solubility in terms of the theory of available energy, but the result comes to little more than a re-statement of the problem in other terms. Nevertheless, such a re-statement is in itself sometimes an advance in knowledge. It is certain then that when dissolution occurs the available energy of the whole system is decreased by the process, while when equilibrium is reached and the solution is saturated the available energy is a minimum. When a variable quantity is at a minimum a slight change in the system does not affect its value, and therefore, when a solution is saturated, the increase in the available energy of the liquid phase produced by dissolving in it some of the solid must be equal to the decrease in the available energy of the solid phase, caused by the abstraction from the bulk of that part dissolved. The general theory of such equilibria will be studied later under the head of the phase rule.

It is possible that a correlation may be made between solubility and the energy of surface tension. If a solid is immersed in a liquid a certain part of the energy of the system depends on, and is proportional to, the area of contact between solid and liquid. Similarly with two liquids like oil and water, which do not mix, we have surface energy proportional to the area of contact. Equilibrium requires that the available energy and therefore the area of contact should be a minimum, as is demonstrated in Plateau's beautiful experiment, where a large drop of oil is placed in a liquid of equal density and a perfect sphere is formed. If, however, the energy of surface tension between the two substances were negative the surface would tend to a maximum, and complete mixture would follow. From this point of view the natural solubility of two substances involves a negative energy of surface tension between them.

Gibbs's Phase Rule.—A saturated solution is a system in equilibrium, and exhibits the thermodynamic relations which hold for all such systems. Just as two electrified bodies are in equilibrium when their electric potentials are equal, so two parts of a chemical and physical system are in equilibrium when there is equality between the *chemical potentials* of each component present in the two parts. Thus water and steam are in

equilibrium with each other when the chemical potential of water substance is the same in the liquid as in the vapour. The chemical potentials are clearly functions of the composition of the system, and of its temperature and pressure. It is usual to call each part of the system of uniform composition throughout a *phase*; in the example given, water substance, the only component is present in two phases—a liquid phase and a vapour phase, and when the potentials of the component are the same in each phase equilibrium exists.

If in unit mass of any phase we have n components instead of one we must know the amount of $n-1$ components present in that unit mass before we know the exact composition of it. Thus if in one gramme of a mixture of water, alcohol and salt we are told the amount of water and salt, we can tell the amount of alcohol. If, instead of one phase, we have r phases, we must find out the values of $r(n-1)$ quantities before we know the composition of the whole system. Thus, to investigate the composition of the system we must be able to calculate the value of $r(n-1)$ unknown quantities. To these must be added the external variables of temperature and pressure, and then as the total number of variables, we have $r(n+1) + 2$.

To determine these variables we may form equations between the chemical potentials of the different components—quantities which are functions of the variables to be determined. If μ_1 and μ_2 denote the potentials of any one component in two phases in contact, when there is equilibrium, we know that $\mu_1 = \mu_2$. If a third phase is in equilibrium with the other two we have also $\mu_1 = \mu_3$. These two equations involve the third relation $\mu_2 = \mu_3$, which therefore is not an independent equation. Hence with three phases we can form two independent equations for each component. With r phases we can form $r-1$ equations for each component, and with n components and r phases we obtain $n(r-1)$ equations.

Now by elementary algebra we know that if the number of independent equations be equal to the number of unknown quantities all the unknown quantities can be determined, and can possess each one value only. Thus we shall be able to specify the system completely when the number of variables, viz. $r(n-1) + 2$, is equal to the number of equations, viz. $n(r-1)$; that is when $r = n + 2$. Thus, when a system possesses two more phases than the number of its components, all the phases will be in equilibrium with each other at one definite composition, one definite temperature and one definite pressure, and in no other conditions. To take the simplest case of a one component system water substance has its three phases of solid ice, liquid water and gaseous vapour in equilibrium with each other at the freezing point of water under the pressure of its own vapour. If we attempt to change either the temperature or the pressure ice will melt, water will evaporate or vapour condense until one or other of the phases has vanished. We then have in equilibrium two phases only, and the temperature and pressure may change. Thus, if we supply heat to the mixture of ice, water and steam ice will melt and eventually vanish. We then have water and vapour in equilibrium, and, as more heat enters, the temperature rises and the vapour-pressure rises with it. But, if we fix arbitrarily the temperature the pressure of equilibrium can have one value only. Thus by fixing one variable we fix the state of the whole system. This condition is represented in the algebraic theory when we have one more unknown quantity than the number of equations; i.e. when $r(n-1) + 2 = n(r-1) + 1$ or $r = n + 1$, and the number of phases is one more than the number of components. Similarly if we have F more unknowns than we have equations to determine them, we must fix arbitrarily F coordinates before we fix the state of the whole system. The number F is called the *number of degrees of freedom* of the system, and is measured by the excess of the number of unknowns over the number of variables. Thus $F = r(n-1) + 2 - n(r-1) = n - r + 2$, a result which was deduced by J. Willard Gibbs (1839-1903) and is known as Gibbs's Phase-Rule (see *ENERGETICS*).

The phenomena of equilibrium can be represented on diagrams. Thus, if we take our co-ordinates to represent pressure and temperature, the state of the systems with ice, water and vapour in equilibrium is represented by the point O where the pressure is that of the vapour of water at the freezing point and the temperature is the freezing point under that pressure. If all the ice be melted, we pass along the vapour pressure curve of water OA. If all the water be frozen, we have the vapour pressure curve of ice OB; while, if the pressure be raised, so that all the vapour vanishes, we get the curve OC of equilibrium between the pressure and the freezing point of water. The slope of these curves is determined by the so-called "latent heat equation"

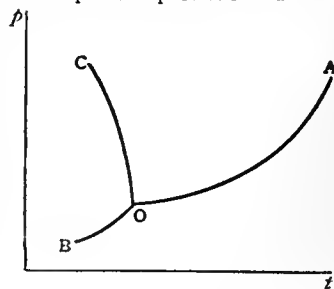

FIG. 1.

(see THERMODYNAMICS), $dp/dt = \lambda/t(v_2 - v_1)$, where p and t denote the pressure and temperature, λ the heat required to change unit mass of the systems from one phase to the other, and $v_2 - v_1$ the resulting change in volume. The phase rule combined with the latent heat equation contains the whole theory of chemical and physical equilibrium.

Application to Solutions.—In a system containing a solution we have to deal with two components at least. The simplest case is that of water and a salt, such as sodium chloride, which crystallizes without water. To obtain a non-variant system, we must assemble four phases—two more than the number of components. The four phases are (1) crystals of salt, (2) crystals of ice, (3) a saturated solution of the salt in water, and (4) the vapour, which is that practically of water alone, since the salt is non-volatile at the temperature in question. Equilibrium between these phases is obtained at the freezing point of the saturated solution under the pressure of the vapour. At that pressure and temperature the four phases can co-exist, and, as long as all of them are present, the pressure and temperature will remain steady. Thus a mixture of ice, salt and the saturated solution has a constant freezing point, and the composition of the solution is constant and the same as that of the mixed solids which freeze out on the abstraction of heat. This constancy both in freezing point and composition formerly was considered as a characteristic of a pure chemical compound, and hence these mixtures were described as components and given the name of "cryohydrates."

In representing on a diagram the phenomena of equilibrium in a two-component system we require a third axis along which to plot the composition of a variable phase. It is usual to take three axes at right angles to each other to represent pressure, temperature and the composition of the variable phase. On a plane figure this solid diagram must be drawn in perspective, the third axis C being imagined to lie out of the plane of the paper. The phase-rule diagram that we construct is then a sketch

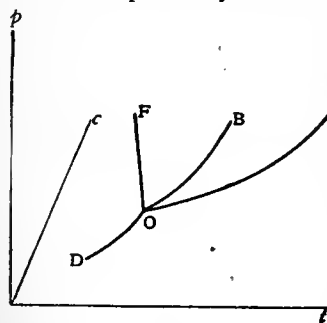

FIG. 2.

of a solid model, the lines of which do not really lie in the plane of the paper.

Let us return to the case of the system of salt and water. At the cryohydric point O we have four phases in equilibrium at a definite pressure, temperature and composition of the liquid phase. The condition of the system is represented by a single point on the diagram. If heat be added to the mixture ice will melt and salt dissolve in the water so formed. If the supply of ice fails first the temperature will rise, and, since solid salt remains, we pass along a curve OA giving the relation between temperature and the vapour pressure of the saturated solution. If, on the other hand, the salt of the cryohydrate fails before the ice the water given by the continued fusion dilutes the solution, and we pass along the curve OB which shows the freezing points of a series of solutions of constantly increasing dilution. If the process be continued till a very large quantity of ice be melted the resulting solution is so dilute that its freezing point B is identical with that of the pure solvent. Again, starting from O , by the abstraction of heat we can remove all the liquid and travel along the curve OD of equilibrium between the two solids (salt and ice) and the vapour. Or, by increasing the pressure, we eliminate the vapour and obtain the curve OF giving the relation between pressure, freezing point and composition when a saturated solution is in contact with ice and salt.

If the salt crystallizes with a certain amount of water as well as with none, we get a second point of equilibrium between four phases. Sodium sulphate, for instance, crystallizes below 32.6° as $\text{Na}_2\text{SO}_4 \cdot 10\text{H}_2\text{O}$, and above that temperature as the anhydrous solid Na_2SO_4 . Taking the point O to denote the state of equilibrium between ice, hydrate, saturated solution and vapour, we pass along OA till a new solid phase, that of Na_2SO_4 , appears at 32.6° ; from this point arise four curves, analogous to those diverging from the point O .

For the quantitative study of such systems in detail it is convenient to draw plane diagrams which are theoretically projections of the curves of the solid phase rule diagram on one or other of these planes. Experiments on the relation between

temperature and concentration are illustrated by projecting the curve OA of fig. 2 on the t - c -plane. The pressure at each point should be that of the vapour, but since the solubility of a solid does not change much with pressure, measurements under the constant atmospheric pressure give a curve practically identical with the theoretical one.

Fig. 3 gives the equilibrium between sodium sulphate and water in this way. B is the freezing point of pure water, O that

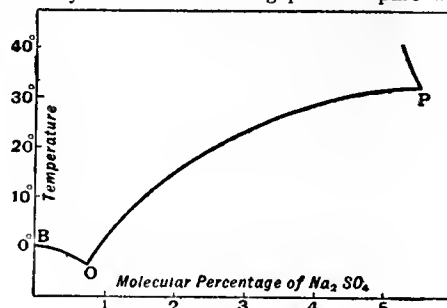

FIG. 3.

of a saturated solution of $\text{Na}_2\text{SO}_4 \cdot 10\text{H}_2\text{O}$. The curve OP represents the varying solubility of the hydrate as the temperature rises from the cryohydric point to 32.6° . At that temperature crystals of the anhydrous Na_2SO_4 appear, and a new fixed equilibrium exists between the four phases—hydrate, anhydrous salt, solution and vapour. As heat is supplied, the hydrate is transformed gradually into the anhydrous salt and water. When this process is complete the temperature rises, and we pass along a new curve giving the equilibrium between anhydrous crystals, solution and vapour. In this particular case the solubility decreases with rise of temperature. This behaviour is exceptional.

Two Liquid Components.—The more complete phenomena of mutual solubility are illustrated by the case of phenol and water.

In fig. 4 A represents the freezing point of pure water, and AB the freezing point curve showing the depression of the freezing point as phenol is added. At B is a non-variant system made up of ice, solid phenol, saturated solution and vapour. BCD is the solubility curve of phenol in water. At C a new liquid phase appears—the solution of water in liquid phenol, the solubility of which is represented by the curve

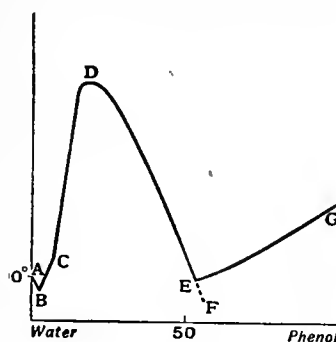

FIG. 4.

DE . At D the composition of the two liquids becomes identical, and at temperatures above D , 68°C the liquids are soluble in each other in all proportions, and only one liquid phase can exist. If the two substances are soluble in each other in all proportions at all temperatures above their melting points we get a diagram reduced to the two fusion curves cutting each other at a non-variant point. This behaviour is illustrated by the case of silver and copper (fig. 5).

At the non-variant point the two metals freeze out together and the composition of the liquid is the same as that of the mixed solid which crystallizes from it. The solid is then known as a eutectic alloy.

A liquid in which the composition is nearly that of the eutectic shows the changes in the rate of fall of temperature as it is allowed to cool. First a small quantity of one of the pure components begins to crystallize out, and the rate of cooling is thereby diminished owing to the latent heat liberated by the change of state. This process continues till the composition of the liquid phase reaches that of the eutectic, when the whole mass solidifies on the further loss of heat without change of temperature, giving a very definite freezing point. The process of cooling is thus represented by a path which runs vertically downwards till it cuts the

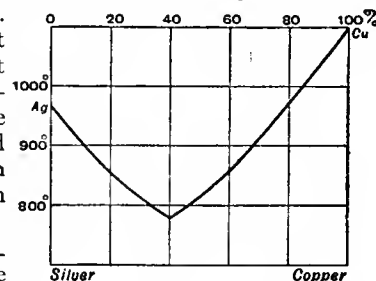

FIG. 5.

freezing point curve, and then travels along it till the non-variant point is reached. In this way two temperature points are obtained in the investigation—the higher giving a point on the equilibrium curve, the lower showing the non-variant point.

Other pairs of alloys, showing more complicated relations, are described in ALLOY. Experiments on alloys are, in some ways, easier to make than on pairs of non-metallic substances, partly owing to the possibility of polishing sections for microscopic examination, and the investigation of alloys has done much to elucidate the general phenomena of solution, of which metallic solution constitutes a special case.

When the two components form chemical compounds with each other, the phenomena of mutual solubility become more complex.

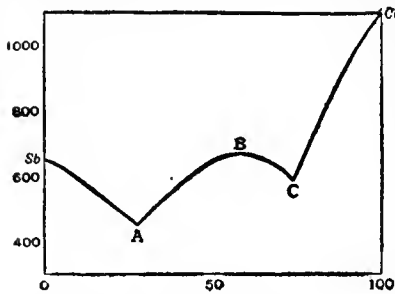

FIG. 6.

For a simple case to serve as an introduction, let us again turn to alloys. Copper and antimony form a single compound $SbCu_2$. If either copper or antimony be added to this compound, the freezing point is lowered just as it would be if a new substance were added to a solvent. Thus on each side of the point B representing this compound, the curve falls. Proceeding along the curve in either

direction, we come to a non-variant or eutectic point. In one case (represented by the point A in the figure) the solid which freezes out is a conglomerate of crystals of the compound with those of antimony, in the other case C with those of copper. Thus in interpreting complicated freezing point curves, we must look for chemical compounds where the curve shows a maximum, and for a eutectic or cryohydrate where two curves meet at a minimum point.

We are now ready to study a case where several compounds are formed between the two components. A good example is the

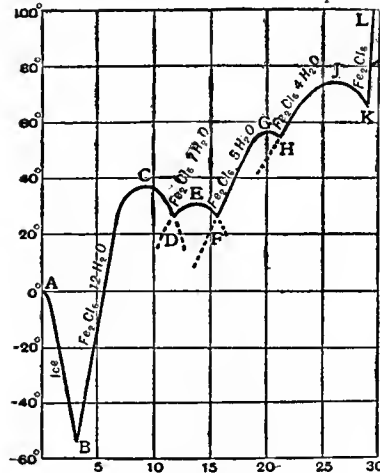

FIG. 7.

melting point again, till at D we obtain another non-variant point. This indicates the appearance of a new compound, which should exist pure at E, the next maximum, and, led by these considerations, Roozeboom discovered and isolated a previously unknown hydrate, $Fe_2Cl_6 \cdot 7H_2O$. In a similar way the curve FGH, between 30° and 55° , shows the effect of the hydrate $Fe_2Cl_6 \cdot 5H_2O$, and the curve HJK that of the hydrate $Fe_2Cl_6 \cdot 4H_2O$, which, when pure, melts at 73.5° —the point J on the diagram. At the point K, 66° , begins the solubility curve of the anhydrous salt, Fe_2Cl_6 , the fusion point of which when pure is beyond the limits of the diagram. Let us now trace the behaviour of a solution of ferric chloride which is evaporated to dryness at a constant temperature of 31° . The phenomena may be investigated by following a horizontal line across the diagram. When the curve BC is reached, $Fe_2Cl_6 \cdot 12H_2O$ separates out, and the solution solidifies. Further renewal of water will cause first liquefaction, as the curve CD is passed, and then resolidification to $Fe_2Cl_6 \cdot 7H_2O$ when DE is cut. Again the solid will liquefy and once more become solid as $Fe_2Cl_6 \cdot 5H_2O$. Still further evaporation causes these crystals to effloresce and pass into the anhydrous salt. As we have seen, the maxima of the various curve-branches at C, E, G, and J correspond with the melting points of the various hydrates at 37° , 32.5° , 56° and 73.5° respectively; and at these points melting or solidification of the whole mass can occur at constant temperature. But we have also found this behaviour to be characteristic of the non-variant or transition points, which, in this case, are represented by the points B, D, F, H and K (-55° , 27.4° , 30° , 55° and 66°). Thus

in two ways at least a constant melting point can be obtained in a two-component system.

Solid Solutions.—In all the cases hitherto considered, the liquid phase alone has been capable of continuous variation in composition. The solid phases each have been of one definite substance. Crystals of ice may lie side by side with crystals of common salt, but each crystalline individual is either ice or salt; no one crystal contains both components in proportions which can be varied continuously. But, in other cases, crystals are known in which both components may enter. Such phenomena are well known in the alums—double sulphates of aluminium with another metal. Here the other metal may be one, such as potassium, or two, such as potassium and sodium, and, in the latter case, the proportion between the two may vary continuously throughout wide limits. Such structures are known as mixed crystals or solid solutions.

The theoretical form of the freezing point diagrams when solid solutions are present depends on the relation between the available energy and the composition in the two phases. This relation is known when the amount of either component present in the other is very small, for it is then the relation for a dilute system and can

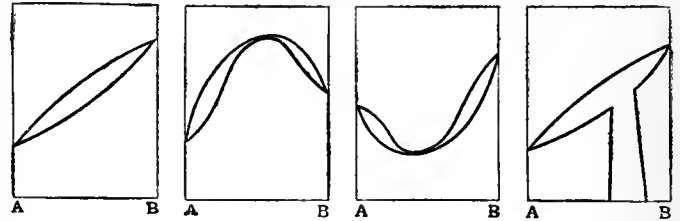

FIG. 8.

FIG. 9.

FIG. 10.

FIG. 11.

be calculated. But at intermediate compositions we can only guess at the form of the energy-composition curve, and the freezing point composition curve, deduced from it, will vary according to the supposition which we make. With the most likely forms for the energy curves we get the accompanying diagrams for the relation between freezing point and concentration.

It will be noticed that in all these theoretical curves the points of initial fusion and solidification do not in general coincide; we reach a different curve first according as we approach the diagram from below, where all is solid, or from above, where all is liquid. Again, it will be seen that the addition of a small quantity of one component, say B, to the other, A, does not necessarily lower the melting point, as it does with systems with no solid solutions; it is quite as likely to cause it to rise. The second and third figures, too, show that the presence of solid solutions may simulate the phenomena of chemical combination, where the curve reaches a maximum, and of non-variant systems where we get a minimum. The fourth figure shows that, in some cases, it should be possible for solid solutions to be present in a limited part of the field only, being absent between the two nearly vertical lines in fig. 11. Experiment has revealed the existence of systems in which these phenomena are displayed. As an example we may take the case of mixtures of naphthalene and β -naphthol, substances which form solid solutions in each other. The freezing and melting point curves are exactly similar to theoretical curves of fig. 8, the point A representing pure naphthalene and B pure β -naphthol. When the equilibria become more complex difficulties of interpretation of the experimental results often arise. It is often very difficult to distinguish between a chemical compound, for example, and the case of solid solution represented by fig. 9. All available evidence, from the freezing point curve and from other sources must be scrutinized before an opinion is pronounced. But the elucidation of the complicated phenomena of solid solutions would have been impossible without the theoretical knowledge deduced from the principle of available energy.

Supersaturation.—When a crystal of the solid phase is present the equilibrium of a solution is given by the solubility curves we have studied. If, however, a solution be cooled slowly past its saturation point with no solid present, crystallization does not occur till some lower temperature is reached. Between the saturation point and this lower temperature, the liquid holds in solution more of the solute than corresponds with equilibrium, and is said to be supersaturated. A familiar example is to be found in solutions of sodium sulphate, which may be cooled much below their saturation point and kept in the liquid state till a crystal of the hydrate $Na_2SO_4 \cdot 10H_2O$ is dropped in, when solidification occurs with a large evolution of latent heat. These phenomena are explicable if we consider the energy relations,

for the intrinsic energy of a system will contain terms depending on the area of contact between different phases, and, for a given mass of material, the area will be greater if the substance is finely divided. Hence the conditions necessary to secure equilibrium when the solid phase is present are not the same as those necessary to cause crystallization to start in a number of crystals at first excessively minute in size. The corresponding phenomenon in the case of vapours is well known. Dust-free air will remain supersaturated with water-vapour in conditions where a dense cloud would be formed in presence of solid dust-nuclei or electric ions which serve the same purpose.

If a solution of a salt be stirred as it cools in an open vessel, a thin shower of crystals appears at or about the saturation temperature. These crystals grow steadily, but do not increase in number. When the temperature has fallen about 10° C. below this point of saturation, a dense shower of new crystals appear suddenly. This shower may be dense enough to make the liquid quite opaque. These phenomena have been studied by H. A. Miers and Miss F. Isaac. If the solution be confined in a sealed glass tube, the first thin shower is not formed, and the system remains liquid till the secondary dense shower comes down. From this and other evidence it has been shown that the first thin shower in open vessels is produced by the accidental presence of tiny crystals obtained from the dust of the air, while the second dense shower marks the point of spontaneous crystallization, where the decrease in total available energy caused by solidification becomes greater than the increase due to the large surface of contact between the liquid and the potentially existing multitudinous small crystals of the shower.

If the temperature at which this dense spontaneous shower of crystals is found be determined for different concentrations of solution, we can plot a "supersolubility curve," which is found generally to run roughly parallel to the "solubility curve" of steady equilibrium between liquid and already existing solid. When two substances are soluble in each other in all proportions, we get solubility curves like those of copper and silver shown in fig. 5. We should expect to find supersolubility curves lying below the solubility curves, and this result has been realized experimentally for the supersolubility curves of mixtures of salol (phenyl salicylate) and betol (β -naphthol calicylate) represented by the dotted lines of fig. 12.

In practical cases of crystallization in nature, it is probable that these phenomena of supersaturation often occur. If a liquid mixture of A and B (fig. 12) were inoculated with crystals of A when its composition was that represented by x , cooled very slowly and stirred, the conditions would be those of equilibrium throughout. When the temperature sank to a , on the freezing point curve, crystals of pure A would appear. The residual liquid would thus become richer in B, and the temperature and composition would pass along the curve till E, the eutectic point, was reached. The liquid then becomes saturated with B also, and, if inoculated with B crystals, will deposit B alongside of A, till the whole mass

is solid. But, if no solid be present initially, or if the cooling be rapid, the liquid of composition x becomes supersaturated and may cool till the supersaturation curve is reached at b , and a cloud of A crystals comes down. The temperature may then rise and the concentration of B increase in the liquid in a manner represented by some such line as $b f$. The conditions may then remain those of equilibrium along the curve $f E$, but before reaching f the solution may become supersaturated with B and deposit B crystals spontaneously. The eutectic point may never be reached. The possibility of these phenomena should be borne in mind when attempts are made to interpret the structure of crystalline bodies in terms of the theory of equilibrium.

Osmotic Pressure.—The phase rule combined with the latent heat equation enables us to trace the general phenomena of equilibrium in solutions, and to elucidate and classify cases even of great complexity. But other relations between the different properties of solutions have been investigated by another series of conceptions which we shall proceed to develop. Some botanical experiments made about 1870 suggested the idea of semi-permeable membranes, *i.e.* membranes which allow a solvent to pass freely but are impervious to a solute when dissolved in that solvent. It was found, for instance, that a film of insoluble copper ferrocyanide, deposited in the walls of a

porous vessel by the inward diffusion and meeting of solutions of copper sulphate and potassium ferrocyanide, would allow water to pass, but retained sugar dissolved in that liquid. It was found, too, when water was placed on one side of such a membrane, and a sugar solution in a confined space on the other, that water entered the solution till a certain pressure was set up when equilibrium resulted.

The importance of these experiments from the point of view of the theory of solution, lay in the fact that they suggested the conception of a perfect or ideal semi-permeable partition, and that of an equilibrium pressure representing the excess of hydrostatic pressure required to keep a solution in equilibrium with its pure solvent through such a partition. Artificial membranes are seldom or never perfectly semi-permeable—some leakage of solute nearly always occurs, but the imperfections of actual membranes need no more prevent our use of the ideal conception than the faults of real engines invalidate the theory of ideal thermodynamics founded on the conception of a perfect, reversible, frictionless, heat engine. Further, in the free surface the solutions of an involatile solute in a volatile solvent, through which surface the vapour of the solvent alone can pass, and in the boundary of a crystal of pure ice in a solution, we have actual surfaces which are in effect perfectly semi-permeable. Thus the results of our investigations based on ideal conceptions are applicable to the real phenomena of evaporation and freezing.

Dilute Solutions.—Before considering the more complicated case of a concentrated solution, we will deal with one which is very dilute, when the theoretical relations are much simplified. The vapour pressure of a solution may be measured experimentally by two methods. It may be compared directly with that of the pure solvent, as the vapour pressure of a pure liquid is determined, by placing solvent and solution respectively above the mercury in two barometer tubes, and comparing the depressions of the mercury with the height of a dry barometer at the same temperature. This method was used by Raoult. On the other hand, a current of dry air may be passed through the series of weighed bulbs containing solution and solvent respectively, and the loss in weight of each determined. The loss in the solution bulbs gives the mass of solvent absorbed from the solution, and the loss in the solvent bulbs the additional mass required to raise the vapour pressure in the air-current to equilibrium with the pure solvent. The relative lowering of vapour pressure of the solution compared with that of the solvent is measured by the ratio of the extra mass absorbed from the solvent bulbs to the total mass absorbed from both series of bulbs. Experiments by this method have been made by W. Ostwald and J. Walker, and by Lord Berkeley and E. G. J. Hartley.

The vapour pressure of the solution of a non-volatile solute is less than the vapour pressure of the pure solvent. Hence if two vessels, one filled with solvent and one with solution, be placed side by side in an exhausted chamber, vapour will evaporate from the solvent and condense on the solution. The solution will thus gain solvent, and will grow more and more dilute. Its volume will also increase, and thus its upper surface will rise in the vessel. But as we ascend in an atmosphere the pressure diminishes; hence the pressure of the vapour in the chamber is less the higher we go, and thus eventually we reach a state of equilibrium where the column of vapour is in equilibrium at the appropriate level both with solvent and solution. Neglecting the very small buoyancy of the vapour, the hydrostatic pressure P at the foot of the column of solution is $h g \rho$ where h is the height of the column and ρ the mean density of the solution. If the height be not too great, we may assume the density of the vapour to be uniform, and write the difference in vapour pressure at the surfaces of the solvent and of the solution as $p - p' = h g \sigma$. Hence we find that $p - p' = P \sigma / \rho$ for a very dilute solution, where the difference $p - p'$ is small and the height of the balancing column of solution small.

In practice the time required to reach these various conditions of equilibrium would be too great for experimental demonstration, but the theoretical consideration of vapour pressures is of fundamental importance. Let us suppose that we possess a partition such as that described above, which is permeable to the solvent but not to the solute when dissolved in it, and let us connect the solution and solvent of fig. 13 with each other through such a partition. If solvent were to flow one way or the other through the partition, the

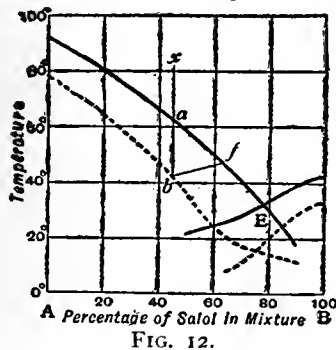

FIG. 12.

height of the column of solution would rise or fall and the equilibrium with the vapour be disturbed. A continual circulation might thus be set up in an isothermal enclosure and maintained with the performance of an unlimited supply of work. This result would be contrary to all experience of the impossibility of "perpetual motion," and hence we may conclude that through such a semi-permeable wall, the solvent and the solution at the foot of the column would

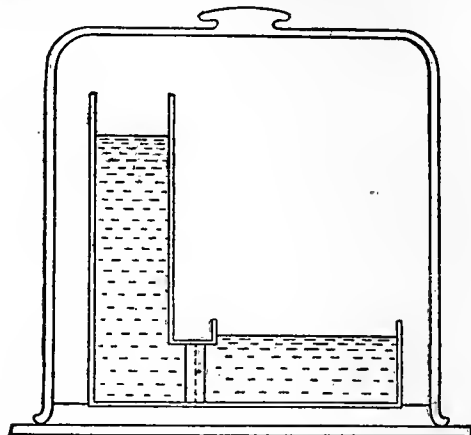

FIG. 13.

be in equilibrium under the excess of hydrostatic pressure represented when the solution is very dilute by $P = (p - p^s) \rho / \sigma$. But such a pressure represents the equilibrium osmotic pressure discussed above. Therefore the equilibrium osmotic pressure of a solution is connected with the vapour pressure, and, in a very dilute solution, is expressed by the simple relation just given.

Another relation becomes evident if we use as a semi-permeable partition a "vapour sieve" as suggested by G. F. Fitzgerald. If a number of small enough holes be drilled through a solid substance which is not wetted by the liquid, our knowledge of the phenomena of capillarity shows us that it needs pressure to force the liquid into the holes. A piston made of such a perforated substance, therefore, may be used to exert pressure on the liquid, while all the time the vapour is able to pass. By evaporation and condensation, then, the solvent can pass through this perforated partition, which thus acts as a perfect semi-permeable membrane. When the solution and solvent are in equilibrium across the partition, the vapour pressure of the solution has been increased by the application of pressure till it is equal to that of the solvent. In any solution, then, the osmotic pressure represents the excess of hydrostatic pressure which it is necessary to apply to the solution in order to increase its vapour pressure to an equality with that of the solvent in the given conditions.

Similar considerations show that, since at its freezing point the vapour pressure of a solution must be in equilibrium with that of ice, the depression of freezing point produced by dissolving a substance in water can be calculated from a knowledge of the vapour pressure of ice and water below the freezing point of pure water. But another method of investigation will illustrate new ways of treating our subject.

By imagining that a dilute solution is put through a thermodynamic cycle we may deduce directly relations between its osmotic pressure and its freezing point. Let us freeze out unit mass of solvent from a solution at its freezing point $T - dT$ and remove the ice, which is assumed to be the ice of the pure solvent. Then let us heat both ice and solution through the infinitesimal temperature range dT to the freezing point T of the solvent, melt the ice by the application of an amount of heat L , which measures its latent heat of fusion, and allow the solvent so formed to enter the solution reversibly through a semi-permeable wall into an engine cylinder, doing an amount of work $P dv$. By cooling the resultant solution through the range dT we recover the original state of the system. The well-known expression for the efficiency of the cycle of reversible operation gives us

$$P dv / L = dT / T \text{ or } dT = T P dv / L$$

as a value for the depression of the freezing point of the solution compared with that of the pure solvent.

The freezing point of a solution may be determined experimentally. The solution is contained in an inner tube, surrounding which is an air space. Then comes an outer vessel, in which a freezing mixture can be placed. This solution is stirred continuously and the temperature falls slowly below the freezing point, till the supersaturation point is reached, or until a crystal of ice is introduced. The solution then freezes, until the heat liberated is enough to raise the tem-

perature to the point of equilibrium given by the tendency of the solution taken in contact with ice to approach the true freezing point on one side and the temperature of the enclosure on the other. To get the true freezing point then, it is well to arrange that the temperature of the enclosure should finally be nearly that of the freezing point to be observed. One way in which this has been secured is by obtaining the under cooling by temporary cooling of the air space by a spiral tube in which ether may be evaporated, the outer vessel being filled with ice in contact with a solution of equivalent concentration to that within. Modifications of this method have been used by many observers, among others by Raoult, Loomis, H. C. Jones, and by E. H. Griffiths and T. G. Bedford, who compared directly the freezing points of dilute solutions with those of the pure solvent in similar conditions by the accurate methods of platinum thermometry.

Another application of the theory of energy enables us to co-ordinate the osmotic pressure of a dilute solution with the pressure of a gas occupying the same space. On the fundamental hypotheses of the molecular theory, we must regard a solution as composed of a number of separate particles of solute, scattered throughout the solvent. Each particle may react in some way on the solvent in its neighbourhood, but if the solution be so dilute that each of these spheres of influence is unaffected by the rest, no further addition of solvent will change the connexion between one particle of solute and its associated solvent. The only effect of adding solvent will be to separate further from each other the systems composed of solute particle as nucleus and solvent as atmosphere; it will not affect the action of each nucleus on its atmosphere. Thus the result will be the same whatever the nature of the interaction may be. If solvent be allowed to enter through a semi-permeable wall into an engine cylinder, the work done when the solution within is already dilute will be the same whatever the nature of the interaction between solute and solvent, that is, whatever be the nature of the solvent itself. It will even be the same in those cases where, with a volatile solute, the presence of a solvent may be dispensed with, and the solute exist in the same volume as a gas. Now the work done by allowing a small quantity of solvent to enter reversibly into an osmotic cylinder is measured by the product of the osmotic pressure into the change in volume. Hence the osmotic pressure is measured by the work done per unit change of volume of the solution. The result of our consideration, therefore, is that the osmotic pressure of a dilute solution of a volatile solute must have the same value as the gaseous pressure the same number of solute particles would exert if they occupied as gas a volume equal to that of the solution.

The reasoning given above is independent of the temperature, so that the variation with temperature of the osmotic pressure of a dilute solution must be the same as that of a gas, while Boyle's law must equally apply to both systems. Experimental evidence confirms these results, and extends them to the cases of non-volatile solutes—as is, indeed, to be expected, since volatility is merely a matter of degree. When the solution ceases to be dilute in the thermodynamic sense of the word, that is, when the spheres of influence of the solute particles intersect each other, this reasoning ceases to apply, and the resulting modification of the gas laws as applied to solutions becomes a matter for further investigation, theoretical or experimental. In the limit then, when the concentration of the solution becomes vanishingly small, theory shows that the osmotic pressure is equal to the pressure of a gas filling the same space. Experiments with membranes of copper ferrocyanide have verified this result for solutions of cane-sugar of moderate dilutions. But the most accurate test of the theory depends on measurements of freezing points.

A quantity of gas measured by its molecular weight in grammes when confined in a volume of one litre exerts a pressure of 22.2 atmospheres, and thus the osmotic pressure of a dilute solution divided by its concentration in gramme-molecules per litre has a corresponding value. But we have seen that the depression of dT of the freezing point of a dilute solution is measured by $T P dv / L$. Putting the absolute temperature of the freezing point of water as 273° , the osmotic pressure P as 22.2 atmospheres or 22.4×10^6 C.G.S. units per unit concentration, L the latent heat as $79.4 \times 4.184 \times 10^7$ in the corresponding units, and dv the volume change

**Absolute
Value of
Osmotic
Pressure.**

in the solution for unit mass of solvent added we get for the quantity dT/c , where c is the concentration of the solution, the value 1.857°C . per unit concentration. Experimental measurements of freezing points of various non-electrolytic solutions have been made by Raoult, Loomis, Griffiths, Bedford and others and numbers ranging round 1.85 found for this concentration. Equally good comparisons have been obtained for solutions in other solvents such as acetic acid 3.88, formic acid 2.84, benzene 5.30, and nitrobenzene 6.95. Such a concordance between theory and experiment not only verifies the accuracy of thermodynamic reasoning as applied to dilute solutions, but gives perhaps one of the most convincing experimental verifications of the general validity of thermodynamic theory which we possess.

Another verification may be obtained from the phenomena of vapour pressure. Since, in dilute solutions, the osmotic pressure has the gas value, we may apply the gas equation $PV = nRT = npv_1$ to osmotic relations. Here n is the number of gramme-molecules of solute, T the absolute temperature, R the gas constant with its usual "gas" value, p the vapour pressure of the solvent and v_1 the volume in which one gramme-molecule of the vapour is confined.

In the vapour pressure equation $p - p' = P\sigma/p$, we have the vapour density σ equal to M/v_1 , where M is the molecular weight of the solvent. The density of the liquid is MN/V , where N is the number of solvent molecules, and V the total volume of the liquid. Substituting these values, we find that the relative lowering of vapour pressure in a very dilute solution is equal to the ratio of the numbers of solute and solvent molecules, or $(p - p')/p = n/N$.

The experiments of Raoult on solutions of organic bodies in water and on solutions of many substances in some dozen organic solvents have confirmed this result, and therefore the theoretical value of the osmotic pressure from which it was deduced.

Although even good membranes of copper ferrocyanide are rarely perfectly semi-permeable, and in other membranes such as india-rubber, &c., which have been used, the defects from the theoretical values of the equilibrium pressure are very great, yet, in the light of the exact verification of theory given by the experiments described above, it is evident that such failures to reach the limiting value in no wise invalidate the theory of osmotic equilibrium. They merely show that, in the conditions of the particular experiments, the thermodynamic equilibrium value of the osmotic pressure cannot be reached—the thermodynamic or theoretical osmotic pressure (which must be independent of the nature of the membrane provided it is truly semi-permeable) is a different thing from the equilibrium pressure actually reached in a given experiment, which measures the balance of ingress and egress of solvent through an imperfect semi-permeable membrane.

Dilute solutions of substances such as cane-sugar, as we have seen, give experimental values for the connected osmotic properties—pressure, freezing point and vapour pressure—in conformity with the theoretical values.

All these solutions are non-conductors of electricity. On the other hand, solution of mineral acids and salts conduct the current with chemical decomposition—they are called electrolytes. In order to explain the electrical properties of a solution, for instance of potassium chloride, we are driven to believe that each molecule of the salt is dissociated into two parts, potassium and chlorine, each associated with an electric charge equal in amount but opposite in sign. The movement in opposite directions of these charged ions constitutes the electric current in the solution. To explain the electrical properties of sulphuric acid in aqueous solution, the supposition of three ions, two of hydrogen and one of the chemical group SO_4 , is necessary. Now measurements of osmotic properties of these solutions show that their osmotic pressures are abnormally great and that, at extreme dilution, the ratio of their osmotic pressures to that of equivalent solutions of non-electrolytes is equal to the number of ions indicated by the electrolytic properties. From the osmotic side also, then, electrolytic dissociation is indicated, and indeed, it was from this side that the idea was first suggested by S. Arrhenius in 1887. The subject is dealt with in ELECTROLYSIS and CONDUCTION, ELECTRIC: § *Ir Liquids*.

Concentrated Solutions.—Having dealt with the relations between the properties of an ideally dilute solution, we now turn to the consideration of the general case where the simplifying assumption of great dilution is not made.

The height of the column of solution in fig. 13 required for osmotic equilibrium through a semi-permeable wall below is now very great, since the osmotic pressure of strong solutions may reach many hundred atmospheres. Hence we must not assume that the density of the vapour in the surrounding

atmosphere is constant, or that the solution, when equilibrium is reached, is of uniform concentration throughout. The osmotic pressure (defined as the difference in the hydrostatic pressures of the solution and solvent when their vapour pressures are equal and they are consequently in equilibrium through a perfect semi-permeable membrane) may also depend on the absolute values of the hydrostatic pressures, as may the vapour pressure of the liquids.

To investigate the osmotic pressure of a strong solution we may consider the hydrostatic pressure required to increase its vapour pressure to an equality with that of the solvent. The relation between hydrostatic pressure and the vapour pressure of a pure liquid may be obtained at once by considering the rise of liquid in a capillary tube. The difference in vapour pressure at the top and at the bottom of the column is $p - p' = P\sigma/p$, as shown above for a column of solution. Writing v for $1/\sigma$, the specific volume of the vapour at the pressure p , and V for $1/\rho$, the specific volume of the liquid at the pressure P , and restricting the result to small changes, we get $vdP = VdP$.

In considering the corresponding relation for a solution instead of a pure liquid, possible differences in concentration make the column method difficult of application, and it is better to attach the problem by means of an imaginary cycle of isothermal operation. The simplest way to do this is to imagine a vapour-sieve piston through which the vapour but not the liquid can pass. As we have explained above, such a vapour sieve may be constructed by boring a number of small enough holes through a solid not wetted by the liquid.

Let us imagine unit mass of solution of volume V confined in a cylinder ABC between a fixed vapour sieve B and a solid piston A

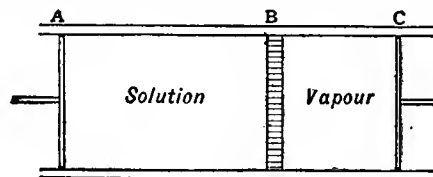

FIG. 14.

by which a pressure P is applied. The vapour at pressure p in equilibrium with the liquid is bounded by a solid piston C, which we can also move to change the pressure or volume.

With such an imaginary apparatus, H. L. Callendar has shown that the variation of vapour pressure of a solution with pressure is given by the expression $V'dP = vdP$, where V' is the change in volume of the solution when unit mass of solvent is mixed with it. The corresponding relation for a pure liquid can be regained by considering that at infinite dilution the liquid becomes pure solvent, and the change of volume becomes equal to the volume V of solvent added.

The osmotic pressure P_0 is the difference of the hydrostatic pressures P' and P of the solution and the solvent when their vapour pressures are equal. Hence $dP_0 = dP' - dP$ and $dP_0/dP = (V - V')/V$ or $dP_0/dP' = (V - V')/V$. If $V = V'$ there is no change in osmotic pressure with hydrostatic pressure, and osmotic pressure depends on concentration and temperature only.

The relation between the equilibrium pressures P and P' for solution and solvent corresponding to the same value p_0 of the vapour pressure is obtained by integrating the equation $V'dP' = vdP$ between corresponding limits for solution and solvent. We get

$$\int_{P'}^{P} V'dP' = \int_{p'}^{p} vdP \quad \text{and} \quad \int_{P}^{P'} VdP = \int_{p}^{p'} vdP,$$

$$\text{whence} \quad \int_{P'}^{P} V'dP' - \int_{P}^{P'} VdP = \int_{p}^{p'} vdP,$$

where p and p' are the vapour pressures of solvent and solution each under its own vapour pressure only.

If we measure the osmotic pressure P_0 when the solvent is under its own vapour pressure only, that is, when $P = p = p_0$, the term involving V vanishes, and the limit of integration P' becomes $P_0 + p$. If we assume that V' , the volume change on dilution, varies regularly or not appreciably with pressure, we may write the first integral as $V'(P_0 + p - p')$ where V' now denotes its mean value between the limits.

To evaluate the second integrals vdP we may subtract a constant b to represent the defect of the volume of the vapour from the ideal volume Rt/p . This gives

$$V'(P_0 + p - p') = Rt \log (p/p') - b(p - p').$$

For most experimental purposes the small terms involving the factor $(p - p')$ may be neglected, and we have, approximately,

$$P_0 V' = Rt \log (p/p').$$

From this equation the osmotic pressure P_0 required to keep a solution in equilibrium as regards its vapour and through a

semi-permeable membrane with its solvent, when that solvent is under its own vapour pressure, may be calculated from the results of observations on vapour pressure of solvent and solution at ordinary low hydrostatic pressures. The chief difficulty lies in the determination of the quantity V' , the change in volume of the solution under the pressure P_0 when unit mass of solvent is mixed with it. This determination involves a knowledge of the density and of the compressibility of the solution; the latter property is difficult to measure accurately.

In some solutions such as those of sugar the change in volume on dilution is nearly equal to the volume of solvent added; V' then becomes equal to V , the specific volume of the solvent. The osmotic pressures of strong sugar solutions were measured successfully by a direct method with semi-permeable membranes of copper ferrocyanide by Lord Berkeley and E. G. J. Hartley, who also determined the vapour pressures by passing a current of air successively through weighed vessels containing solution and water respectively.

Their table of comparison published in 1906 shows the following agreement:—

Concentration in grammes per litre of solution.	Osmotic pressure at 0° C. in atmospheres.	
	From vapour pressures.	From direct measurement.
420	44.3 (at 12.6°)	43.97
540	69.4	67.51
660	101.9	100.78
750	136.0	133.74

It seems likely that measurements of vapour pressure and compressibility may eventually enable us to determine accurately osmotic pressures in cases where direct measurement is impossible.

The slope of the temperature vapour pressure curves in the neighbourhood of the freezing point of the solvent is given by the latest heat equation. The difference in the two slopes for water and ice is $dp/dT - dp'/dT = L/Tv$, where L , the latent heat of fusion, is the difference between the heats of evaporation for ice and water, and v is the specific volume of the vapour.

The difference in the lowering of vapour pressures $dp - dp'$ may be put equal to VdP/v , where P is the osmotic pressure, and V the specific volume of the solvent. We then get $VdP = LdT/T$.

In order to integrate this expression we need to know L and v as functions of the temperature and pressure. The latent heat L at any temperature is given by $L = L_0 - \int_{T_0}^T (s - s')dT$, where L_0 is value at T_0 and $s - s'$ is the difference in the specific heats of water and ice. The probable error in neglecting any variation of specific heat is small, and we may calculate L from the values of $L_0 - (s - s')(T_0 - T)$, where $s - s'$ is about 0.5 calories. The variation of L with pressure is probably small.

The volume of a gramme of water also depends on temperature and pressure. Approximately one degree lowering of freezing point corresponds with a change of 12 atmospheres in the osmotic pressure. From the known coefficients of compressibility and thermal expansion we find that V may be represented by the linear equation $V = 1.000 + 0.0008 \Delta$, where Δ is the lowering of the freezing point below 0°.

Putting in these values and integrating we have, neglecting terms involving Δ^3 , $P = 12.06 \Delta - 0.021 \Delta^2$ where P is the osmotic pressure in atmospheres.

H. W. Morse and J. C. W. Frazer, who have made direct measurements of osmotic pressure of solution of cane-sugar, have also measured the freezing points of corresponding solutions. From these results the equation just given has been examined by G. N. Lewis.

Concentration in gramme-molecules per litre of water.	Depression of the freezing point = Δ .	Osmotic pressure.	
		Calculated from Δ .	Observed.
0.1	0.195	2.35	2.44
0.5	0.985	11.8	11.8
1.0	2.07	24.9	24.8

Thus the theory of the connexion of osmotic pressure with freezing point (like that with vapour pressure) seems to give results which accord with experiments.

At the limit of dilution, when the concentration of a solution approaches zero, we have seen that thermodynamical theory, verified by experiment, shows that the osmotic pressure has the same value as the gas pressure of the same number of molecules in the same space. Gases at high pressures fail to conform to Boyle's law, and solu-

tions at moderate concentrations give osmotic pressures which increase faster than the concentration. The variation of gases from Boyle's law is represented in the equation of Van der Waals by subtracting a constant b from the total volume to represent the effect of the volume of the molecules themselves. The corresponding correction in solutions consists in counting only the volume of the solvent in which the solute is dissolved, instead of the whole volume of the solution.

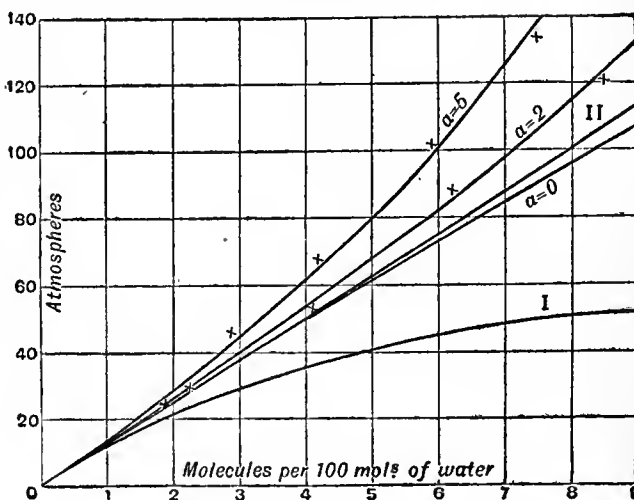

FIG. 15.

In fig. 15 the curve I represents Boyle's law if the volume is taken to be that of the solution, and the curve II if the volume is that of the solvent. Even this correction is not sufficient in solution of sugar, where the theoretical curve II lies below the experimental observations. A further correction may be made by adding more empirical terms to the equation, but a more promising idea, due to J. H. Poynting and H. L. Callendar is to trace the effect of possible combination of molecules of solute with molecules of the solvent. These combined solvent molecules are thus removed from existence as solvent, the effective volume of which is reduced to that of the remaining free molecules of solvent. The greater the number of water molecules attached to one sugar molecule, the less the residual volume, and the greater the theoretical pressure. Callendar finds that five molecules of water in the case of cane-sugar or two molecules in the case of dextrose are required to bring the curves into conformity with the observations of Berkeley and Hartley, which in fig. 15 are indicated by crosses.

Solubility and Heat of Solution.—The conceptions of osmotic pressure and ideal semi-permeable membranes enable us to deduce other thermodynamic relations between the different properties of solutions. As an example, let us take the following investigation:—

An engine cylinder may be imagined to possess a semi-permeable bottom and to work without friction. If it be filled with a solution and the bottom immersed in the pure solvent, pressure equal to the osmotic pressure must be exerted on the piston to maintain equilibrium. Such a system is in the thermodynamic equilibrium. The slightest change in the load will cause motion in one direction or the other—the system is thermodynamically reversible. Such an arrangement may be put through a cycle of operations as in Carnot's engine (see THERMODYNAMICS) and all the laws of reversible engines applied to it. If the solution in the cylinder be kept saturated by the presence

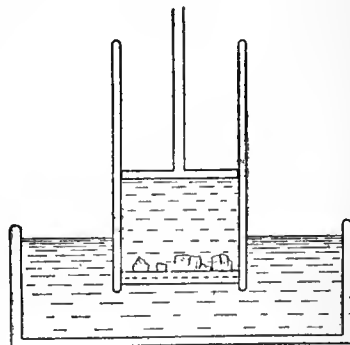

FIG. 16.

of crystals of the solute, crystals will dissolve as solvent enters, and the solution remains saturated throughout. By an imaginary cycle of operations we may then justify the application to solutions of the latent heat equation which we have already assumed as applicable. In the equation $dp/dT = \lambda/T(v_2 - v_1)$, P is the osmotic pressure, T the absolute temperature and λ the heat of solution of unit mass of the solute when dissolving to form a volume $v_2 - v_1$ of saturated solution in an osmotic cylinder. This process involves the performance of

an amount of osmotic work $P(v_2 - v_1)$. If the heat of solution be measured in a calorimeter, no work is done, so that, if we call this calorimetric heat of solution L , the two quantities are connected by the relation $L = \lambda + P(v_2 - v_1)$. If L is zero or negligible, $\lambda = -P(v_2 - v_1)$ and we have $dP/dT = -P/T$ or $dP/P = -dT/T$, which on integration gives $\log P = \log T + C$, or $P = kT$, i.e. the osmotic pressure is proportional to the absolute temperature. This result must hold good for any solution, but if the solution be dilute when saturated, that is, if the solubility be small, the equation shows that if there be no heat effect when solid dissolves to form a saturated solution, the solubility is independent of temperature, for, in accordance with the gas laws, the osmotic pressure of a dilute solution of constant concentration is proportional to the absolute temperature. It follows that if the thermodynamic heat of solution be positive, that is, if heat be absorbed to keep the system at constant temperature, the solubility will increase with rising temperature, while if heat be evolved on dissolution, the solubility falls when the system is heated.

In all this investigation it should be noted that the heat of solution with which we are concerned is the heat effect when solid dissolves to form a saturated solution. It is not the heat effect when solid is dissolved in a large excess of solvent, and may differ so much from that effect as to have an opposite sign. Thus cupric chloride dissolves in much water with an evolution of heat, but when the solution is nearly saturated, it is cooled by taking up more of the solid.

In a very dilute solution no appreciable heat is evolved or absorbed when solvent is added, but such heat effects are generally found with more concentrated solutions. The result is to change the relation between temperature and the osmotic pressure of a solution of constant concentration, a relation which, in very dilute solutions, is a direct proportionality.

The equation of available energy (see **ENERGETICS**) $A = U + TdA/dT$ may be applied to this problem. The available energy A is the work which may be gained from the system by a small reversible isothermal operation with an osmotic cylinder, that is Pdv . If l is the heat of dilution per unit change of volume in a calorimeter where all the energy goes to heat, the change in internal energy U is measured by ldv . We then have

$$Pdv = ldv + T \frac{d}{dT}(Pdv).$$

Neglecting the volume change with temperature this gives $P = l + TdP/dT$ for the relation required. In the case where l is negligible we have $P/dP = T/dT$, which on integration shows that the osmotic pressure, as in the special case of a dilute solution, is proportional to the absolute temperature.

Theories of Solution.—The older observers, noticing the heat effects which often accompany dissolution, regarded solutions as chemical compounds of varying composition. The physical investigation of osmotic pressure, and its correlation by Van't Hoff with the pressure of a gas, brought forward a new aspect of the phenomena, and suggested an identity of physical *modus operandi* as well as of numerical value. On this view, the function of the solvent is to give space for the solute to diffuse, and the pressure on a semi-permeable membrane is due to the excess of solvent molecules entering over those leaving in consequence of the smaller number which impinge on the membrane from the side of the solution; the defect in the number must be proportional, roughly at any rate, to the number of solute molecules, present, that is, to the strength of the solution.

Whatever view, if any, be adopted as to the nature of a solution, the thermodynamic relations we have investigated equally hold good. It is the strength and weakness of thermodynamic methods that they are independent of theories of constitution. The results are true whatever theory be in vogue, but the results throw no light on the problem of which theory to choose. All the thermodynamic relations we have deduced hold on any theory of solution and favour no one theory rather than another. Whether osmotic pressure be due to physical impact or to chemical affinity it must necessarily have the gas value in a dilute solution, and be related to vapour pressure and freezing point in the way we have traced. But for any theory of solution to be tenable, it must at least be consistent with the known thermodynamic relations, verified as those relations are by experiment.

On certain assumptions required for the extension of the methods of the kinetic theory of gases to liquids, L. Boltzmann offered a demonstration of the law of osmotic pressure in dilute

solutions, based on the idea that the mean energy of translation of a molecule should be the same in the liquid as in the gaseous state. But, whether or not the assumption underlying this demonstration be accepted, the similarity between solution and chemical action remains, and the osmotic law has been examined from this side by J. H. Poynting and by H. L. Callendar. The fundamental phenomenon they take to be the identity of vapour pressure, and consider the combination necessary to reduce the vapour pressure of a solution to the right value. If each molecule of the solute combines with a certain number of molecules of the solvent in such a way as to render them inactive for evaporation, we get a lowering of vapour pressure. Let us assume that the ratio p/p' of the vapour pressures of the solvent and solution is equal to the ratio of the number of free molecules of solvent to the whole number of molecules in the solution. Each molecular complex, formed by solution and solvent, is treated as a single molecule. If there are n molecules of solute to N of solvent originally, and each molecule of solute combines with a molecule of solvent, we get for the ratio of vapour pressures $p/p' = (N - an)/(N - an + n)$, while the relative lowering of vapour pressure is $(p - p')/p = n/(N - an)$.

In the limit of dilution when n is very small compared with N this gives Raoult's experimental law that the relative lowering is n/N , which we deduced from the osmotic law, and conversely from which the osmotic law follows, while for more concentrated solutions agreement is obtained by assigning arbitrary values to a , which, as we have seen, is 5 in the case of cane-sugar.

Certain solvents, such as water, liquid ammonia or liquid hydrocyanic acid, possess the power of making some solutes, such as mineral salts and acids, when dissolved in them, conductors of electricity. The special properties of these solutions are dealt with under **ELECTROLYSIS** and **CONDUCTION**, **ELECTRIC**, § *In Liquids*. Attempts have been made to co-ordinate this ionizing power of solvents with their dielectric constants, or with their chemical properties. On the lines of Poynting's theory of solution, each ion in electrolytes must combine with one or more molecules of solvent.

Diffusion in Solutions.—The passage of dissolved substances through animal and vegetable membranes was the subject of many early experiments. It was found that substances like mineral salts, which crystallize well from solution, passed such membranes with comparative ease, while the jelly-like substances such as albumen passed with extreme slowness if at all. The first to make systematic experiments on the free diffusion of dissolved substances with no separating membrane was Thomas Graham (1804–1869), who immersed in a large volume of water a wide-mouthed bottle containing a solution, and after some time measured the quantity of substance which had diffused into the water. Again the two classes of substances mentioned above were found to be distinguished, and Graham called the slowly diffusible non-crystalline bodies colloids, in contrast to the quickly diffusible crystalloids. Graham showed that the diffusion was approximately proportional to the difference in concentration, and on these lines a theory of diffusion was founded on the lines of Fourier's treatment of the conduction of heat.

The quantity of substance which diffuses through unit area in one second may be taken as proportional to the difference in concentration between the fluids at that area and at another parallel area indefinitely near it. This difference in concentration is proportional to the rate of variation $-dc/dx$ of the concentration c with the distance x , so that the number of gramme-molecules of solute which, in a time dt , cross an area A of a long cylinder of constant cross section is $dN = -DA(dc/dx)dt$, where D is a constant known as the diffusion constant or the diffusivity.

The osmotic pressure of a solution depends on the concentration, and, if we regard the difference in that pressure as the effective force driving the dissolved substance through the solution, we are able to obtain the equation of diffusion in another form. When the solution is dilute enough for the osmotic pressure to possess "the gas" value the equation becomes—

$$dN = -\frac{RT}{F} A \frac{dc}{dx} dt,$$

where R is the usual gas constant, T the absolute temperature, and F the force required to drive one gramme-molecule of the solute through the solution with unit velocity.

By comparison with the first equation we see that RT/F is equal to D , the diffusion constant. This constant can be measured experimentally, and for such a substance as sugar or water comes out about 0.3, at 20° C., the unit of time being the day. Hence the force required to drive one gramme-molecule of sugar through water with a velocity of one centimetre per second may be calculated as some thousands of millions of kilogrammes weight.

In the case of electrolytes we can go further, and calculate the diffusion constant itself from the theory of electrolytic dissociation (see CONDUCTION, ELECTRIC, § *In Liquids*). On that theory the ions of a dilute solution migrate independently of each other. Since some ions are more mobile than others, a separation will ensue when water is placed in contact with a solution, the faster moving ion penetrating quicker into the water under the driving force of the osmotic pressure gradient. This separation causes a difference of potential, which can be calculated and is found to agree with the values obtained experimentally. The separation also sets up electrostatic forces, which increase until they are strong enough to drag the slower moving ions along faster, and to retard the naturally faster ions till they travel at the same rate. The resistance offered by the liquid, and therefore the force F , required to drive one gramme-molecule through the liquid with unit velocity is the sum of the corresponding quantities for the individual ions. Now the velocities u and v of the opposite ions under unit potential gradient, and therefore U and V under unit force, are known from electrical data. Thus F , which is equal to $1/U + 1/V$, is known. The osmotic pressure of an electrolyte consisting of two ions is double that of a non-electrolyte. Hence for a binary electrolyte the diffusion constant is measured by $2RT/F$ or $2UVRT/(U+V)$. This result gives a value of D for dilute hydrochloric acid equal to 2.49 to compare with the observed value of 2.30. Other substances give equally good agreements; thus sodium chloride has a calculated constant of 1.12 and an observed one of 1.11. Such concordance gives strong support to the theory of diffusion outlined above.

Colloidal Solutions.—Besides a large number of animal and vegetable substances, many precipitates formed in the course of inorganic chemical reactions are non-crystalline and appear in the colloidal state, instances are the sulphides of antimony and arsenic and the hydroxides of iron and alumina. Some of these colloids dissolve in water or other liquids to form solutions called by Graham *hydrosols*; Graham named the solids formed by the setting or coagulation of these liquids *hydrogels*. Solutions of colloids in solvents such as water and alcohol seem to be divisible into two classes. Both mix with warm water in all proportions, and will solidify in certain conditions. One class, represented by gelatin, will redissolve on warming or diluting, while the other class, containing such substances as silica, albumen, and metallic, hydrosulphides, will solidify on heating or on the addition of electrolytes to form a solid "gel" which cannot be redissolved. Solidification of the first kind may be termed "setting," that of the second "coagulation."

The power of coagulation of colloids shown by electrolytes depends in a curious manner on the chemical valency of the effective ion. The average of the coagulative powers of salts of univalent, divalent and trivalent metals have been found by experiment to be proportional to the numbers 1 : 35 : 1023. If we assume that a certain minimum electric charge must be brought into contact with a group of colloid particles to produce coagulation, twice as many univalent ions must collect to produce the same effect as a number of divalent ions, and three times as many as an effective number of trivalent ions. We can calculate, by the help of the kinetic theory and the theory of chances, the frequency with which the necessary conjunctions of ions will occur, and show that the general law will be that the coagulative powers should be in the ratios of 1 : x : x^2 . Putting $x = 32$, we get 1 : 32 : 1024 to compare with the experimental numbers. The ordinary surface energy of a two-phase system tends to diminish the area of contact, and thus to help the growth of the larger aggregates required for coagulation. A natural electric charge on the particles would oppose this tendency, and tend to increase the free surface and thus promote disintegration and solution. The function of the electrolyte may be to annul such a natural charge and thus allow the non-electric surface energy to produce coagulation. This explanation is supported by some experiments by W. B. Hardy, who found that certain colloids did possess electric charges, the sign of which depended on whether the surrounding liquid was slightly acid or slightly alkaline. At the neutral point, when the particles possessed no charge, their

stability was destroyed, and they were precipitated. But recent experiments have shown that the simple theory of coagulation here outlined needs amplification in certain directions. The phenomena seem to be dependent on variables such as time, and are more complicated than seemed likely at first.

The size of the suspended particles in colloidal solutions varies greatly. In some solutions they are visible under a good microscope. In other cases, while too small to be directly visible, they are large enough to scatter and polarize a beam of light. In yet other solutions, the particles are smaller again, and seem to approach in size the larger molecules of crystalloid substances. It is not yet agreed whether colloid solution is the same in kind though different in degree from crystalloid solution or is a phenomenon of an entirely different order.

REFERENCES.—The properties and theory of solutions are treated in all works on general physical chemistry; Ostwald's discussion in his *Lehrbuch* was translated into English in 1891 by M. M. P. Muir entitled *Solution*. Special works are W. C. D. Whetham, *Theory of Solution* (1902); W. Rothmund, *Löslichkeit* (1907). Solubility tables are given in Landolt, Börnstein and Meyerhoffers, *Tabellen* (1905); A. M. Comey, *Dictionary of Solubilities (Inorganic)* (1896); A. Seidell, *Dictionary of the Solubilities of Inorganic and Organic Substances* (1907). (W. C. D. W.)

SOLUTRIAN EPOCH, in archaeology, the name given by G. de Mortillet to the second stage of his system of cave-chronology, and that synchronous with the third division of the Quaternary period. It is so called from the Solutré Cave, Maçon district, Saône-et-Loire. The period is characterized by two series of chipped flints, one modelled on the laurel-leaf, the other on that of the willow. Those of the first series are artistically chipped upon the two faces and the end, and are readily distinguishable from the flints of the preceding Mousterian epoch. Large thin spear-heads; scrapers with edge not on the side but on the end; flint knives and saws, but all still chipped, not ground or polished; long spear-points, with tang and shoulder on one side only, are also characteristic implements of this epoch. Bone or horn, too, was used. The Solutrian work exhibits a transitory stage of art between the flint implements of the Mousterian and the bone implements of the Madelenian epochs. The fauna includes the horse, reindeer, mammoth, cave lion, rhinoceros, bear and urus. Solutrian "finds" have been also made in the caves of Les Eyzies and Laugerie Haute, and in the Lower Beds of Cresswell Cave (Derbyshire).

SOLWAY FIRTH, an estuarine inlet of the Irish Sea, between England and Scotland. If its mouth be taken as between St Bee's Head on the English and Burrow Head on the Scottish coast, its length is 50 m. The breadth at the mouth is 32 m.; near the head, where the Solway viaduct of the Caledonian railway crosses the firth, it is nearly 1½ m. The general direction is north-easterly from the mouth. The Scottish counties bordering the firth are Wigtownshire, Kirkcudbright and Dumfriesshire; the English coast belongs to Cumberland. On the English side the low Solway Plain borders the firth, except for a short distance above St Bees Head. The Scottish shore, however, is not continuously flat, and such elevations as Criffell (1866 ft.), Bengairn (1250) and Cairnharow (1497), above Wigtown Bay, rise close to it. The shore line is broken on both sides by the estuaries of several rivers. Thus in Scotland the Cree and other streams enter Wigtown Bay; the Dee, Kirkcudbright Bay; Auchencairn Bay and Rough Firth receive numerous small streams, and the Nith discharges through a long estuary. The Annan has its mouth near the town of that name; and the Esk and Eden at the head of the firth, in Cumberland. On this shore Morecambe Bay receives the Wampool and Waver from the plain, the Ellen has its mouth at Maryport, and the Derwent from the Lake District at Workington. The waters of the firth are shallow, and a tidal bore occurs periodically. The fisheries are extensive, and though there are no ports of the first magnitude on the firth, a considerable shipping trade is carried on at Whitehaven, Harrington, Workington, Maryport and Silloth in Cumberland, and at Annan, Kirkcudbright, Creetown and Wigtown on the Scottish side.

SOMA (Sanskrit for "pressed juice," from the root *su*, to press), in Hindu mythology the god who is a personification of the soma plant (*Asclepias acida*), from which an intoxicating milky juice is squeezed. Soma is the Indian Bacchus, and one of the most important of the Vedic gods. All the 114 hymns of the ninth book of the Rig Veda are in his praise. He is celebrated as a dual divinity with Indra, Agni, Pushan or Rudra, in other books. The preparation of the soma juice was a very sacred ceremony, and the worship of the god is very old, soma being identifiable with the Avestan *homa*, prepared and celebrated in the Indo-Iranian period. The plant's true home is heaven, and soma is drunk by gods as well as men, and it is under its influence that Indra is related to have created the universe and fixed the earth and sky in their place. In post-Vedic literature soma is a regular name for the moon, which is regarded as being drunk up by the gods and so waning, till it is filled up again by the sun. In both the Rig Veda and Zend Avesta soma is the king of plants; in both it is a medicine which gives health, long life and removes death. In both the celestial is distinguished from the terrestrial soma, and the liquor from the god. The first soma is supposed to have been stolen from its guardian demon by an eagle, this soma-bringing eagle of Indra being comparable with the nectar-bringing eagle of Zeus, and with the eagle which, as a metamorphosis of Odin, carried off the mead. See A. A. Macdonell, *Vedic Mythology* (Strassburg, 1897).

SOMALILAND, a country of East Africa, so named from its Somali inhabitants. It is also known as the "Eastern Horn of Africa," because it projects somewhat sharply eastwards into the Indian Ocean, and is the only section of the continent which can be spoken of as a peninsula. In general outline it is an irregular triangle, with apex at Cape Guardafui. From the apex the north side extends over 600 m. along the south shore of the Gulf of Aden westwards to Tajura Bay, and the east side skirts the Indian Ocean south-west for over 1000 m. to the mouth of the Juba. Somali also inhabit the coast region and considerable areas inland, as far south as the Tana river. The country between the Tana and Juba rivers now forms part of British East Africa (*q.v.*), and in this article is not included in Somaliland. Inland the limits of Somaliland correspond roughly with the Shoan and Harrar Hills, and the Galla district south of Shoa and east of Lake Rudolf. The 40° east may be taken as the western limit of Somali settlements. The triangular space thus roughly outlined has a total area of about 356,000 sq. m. The population is estimated at about 1,100,000, but no trustworthy data are available. It is partitioned between Great Britain, Italy, France, and Abyssinia as under:—

	Area in sq. m.	Population.
British Somaliland . . .	68,000	300,000
French Somaliland . . .	12,000	50,000
Italian Somaliland . . .	146,000	400,000
Abyssinian Somaliland ¹ . .	130,000	350,000
Total	356,000	1,100,000

Somaliland was not generally adopted as the name of the country until the early years of the 19th century. The northern and central districts were previously known as Adel, the north-east coast as Ajan. By the ancients the country was called *regio romatica*, from the abundance of aromatic plants which it produced.

Physical Features.—The whole region is characterized by a remarkable degree of physical uniformity, and may be broadly described as a vast plateau of an average elevation of 3000 ft., bounded westwards by the Ethiopian and Galla highlands and northwards by an inner and an outer coast range, skirting the south side of the Gulf of Aden in its entire length from the Harrar uplands to Cape Guardafui. The plateau, known as the Ogaden plateau, everywhere presents the same monotonous aspect of a boundless steppe clothed with a scanty vegetation of scrubby plants and herbaceous growths.

The incline is uniformly to the south-east, and apart from the few coast streams that reach the Gulf of Aden during the rains, all the running waters are collected in three rivers—the Nogal in the north, the Webi Shebeli in the centre, and the Juba (*q.v.*)

in the south—which have a parallel south-easterly direction towards the Indian Ocean. But so slight is the precipitation that the Juba alone has a permanent discharge seawards. The Nogal sends down a turbulent stream during the freshets, while the Shebeli, notwithstanding the far greater extent of its basin, does not reach the sea. At a distance of about 12 m. from the coast it is intercepted by a lone line of dunes, which it fails to pierce and is thus deflected southwards, flowing in this direction for nearly 170 m. parallel with the coast, and then disappearing in a swampy depression (the Bali marshes) before reaching the Juba estuary.²

Geology.—The Somaliland plateau is chiefly composed of gneiss and schist. In the north the plateau is overlain by red and purple unfossiliferous sandstones, capped near its edge by a cherty limestone also unfossiliferous but possibly of Lower Cretaceous age. The plains inland from Berbera, and the maritime margins between the coast and foot of the plateau, consist of limestones of Lower Oolitic age with *Belemnites subhastatus*. At Duba some limestones may belong to the Lower Cretaceous.

Climate.—In general the climate is dry and bracing all over the plateau. Temperature is as a rule high but with considerable variation, from 60° F. or less in the early morning to 100° or over in the early afternoon. On an average the coast-belt temperatures are some 10° higher than those of the plateau. Four seasons are recognized—January–April, very dry and great heat; May–June, cooler and the "heavy" rains; July–September, the season of extreme heat and the south-west monsoon; October–December, the "light" rains. The "heavy" rains are little experienced in the coast districts. The rainfall is from 4 to 8 in. a year. In consequence of the elevation of the plateau and the dryness of the air, the heat is less oppressive than is indicated by the temperatures recorded. Malaria prevails in the valley of the Webi Shebeli.

Flora.—The highlands, which in an almost continuous line traverse East Africa, have to a great extent isolated the flora of Somaliland in spite of the general resemblance of its climate and soil to the country on the western side of the band of high ground. In the northern mountainous regions of Somaliland the flora resembles, however, to some extent, that of the Galla country and Abyssinia. On the plateau many forms common elsewhere in East Africa, such as the *Borassus* palm and the baobab tree, are missing. The greater part of the country is covered either with tall coarse grasses (these open plains being called *ban*), or more commonly with thick thorn-bush or jungle, among which rise occasional isolated trees. The prevalent bush plants are *khansa* (umbrella mimosa), acacias, aloes, and, especially, *Boswellia* and *Commiphora*, which yield highly fragrant resins and balsams, such as myrrh, frankincense (*olibanum*) and "balm of Gilead." The bilbil is a thorn-bush growing about 10 ft. high and covered with small curved hooks of great strength. The bush contains also numerous creepers, one of the most common being known as the *armo*. It is a vivid green and has large, fleshy, heart-shaped leaves. Of the thorns, the *guda* and the *wadi* often grow from 30 to 50 ft. high and have large flat-topped branches. In places there are forests of these trees. On the summit of the Golis range the cedars form forests. Among the larger trees are the mountain cedar, reaching to 100 ft.; the *gob*, which bears edible berries in appearance something like the cherry with the taste of an apple, grows to some 80 ft., and is found fringing the river beds; the *hassādan*, a kind of euphorbia, attaining a height of about 70 ft.; and the *darei*, a fig tree. There are patches of dense reeds, reaching 10 ft. high, and thickets of tamarisk along the river beds, and on either side the jungle is high and more luxuriant than on the open plateau. Of herbaceous plants the *kissenia*, the sole representative of the order Loasaceae, which is common in America but very rare elsewhere, is found in Somaliland, which also possesses forms belonging to the eastern Mediterranean flora.

Fauna.—Somaliland is rich in the larger wild animals. Among them are the lion (Somali name *libah*) and elephant, though these have been to a large extent driven from the northern coast districts; the black or double-horned rhinoceros, common in central Ogaden; leopards, abundant in many districts, and daring—they have given their name to the Webi Shebeli ("River of the Leopards"); panthers; spotted and striped hyenas (the latter rare); foxes, jackals, badgers and wild dogs; giraffes and a great variety of antelopes. The antelopes include the beisa oryx, fairly common and widely distributed; the greater and lesser kudu (the greater kudu is not found on the Ogaden plateau); the Somali hartebeest (*Bubalis Swaynei*), found only in the Haud and Ogo districts; waterbuck, rare except along the Webi Shebeli and the Nogal; the dol or Somali bushbuck; the dibatag or Clarke's gazelle; the giraffe-like gerenuk or Waller's gazelle, very common; the aoul or Soemmering's gazelle, widely distributed; the dero (*Gazella Speki*); and the small dikdik or sakaro antelope, found in almost every thicket. The zebra (*Equus grevyi*) is found in Ogaden and places to the south, the wild ass in the northern regions. There are wart hogs, baboons (maned and maneless varieties), a tree monkey, jumping shrews, two kinds of squirrel, a small hare, rock rabbits

² It is probable that a divergent branch leaves the Shebeli some distance above the swamps and that at high water an overflow into the Juba occurs (see *Geog. Journ.*, Nov. 1909).

¹ See also ABYSSINIA.

and a weasel-like animal which hunts in packs. Ostriches are found in the open plains; the rivers swarm with crocodiles, but hippopotami are rare. Birds of prey are numerous and include eagles, vultures, kites, ravens and the carrion stork. Among game birds are three varieties of bustard, guinea fowl, partridges, sand grouse and wild geese. Snakes are common, an adder, a variegated rock snake and a

Hadramut with forty followers about the 13th century. Other traditions trace their origin to the Himyaritic chiefs Sanhāj and Samamah, said to have been coeval with a King Afrikus, who is supposed to have conquered Africa about A.D. 400. These legends should perhaps be interpreted as pointing to a

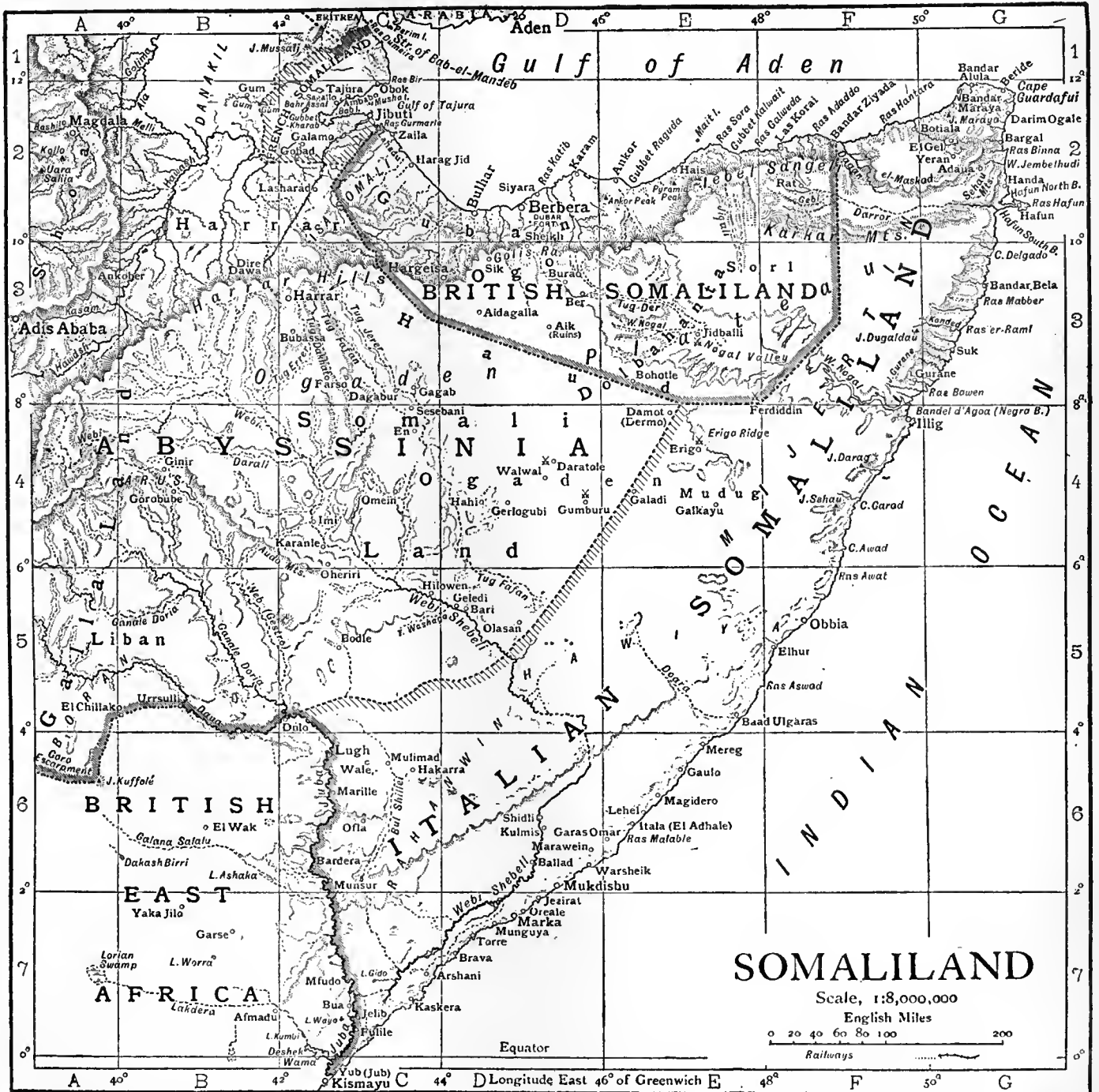

black snake called *muss* being those most dreaded. Mosquitoes are rarely troublesome; gadflies, and a large spider (*hangeyu*), which spins a web resembling golden silk, are common, as are scorpions and centipedes. Termites rear sharp pointed "hills," often over 20 ft. high. A species of lizard grows nearly 4 ft. long.

Inhabitants.—The Somali belong to the Eastern (Ethiopic) Hamitic family of tribes, of which the other chief members are the neighbouring Galla and Afar, the Abyssinian Agau and the Beja tribes between the Nubian Nile and the Red Sea. They have been identified with the people of Punt, who were known to the Egyptians of the early dynasties. The Somali, however, declare themselves to be of Arab origin, alleging their progenitor to have been a certain Sherif Ishak b. Ahmad, who crossed from

series of Arab immigrations, the last two of which are referred to the 13th and 15th centuries. But these intruders seem to have been successively absorbed in the Somali stock; and the Arabs never succeeded in establishing permanent communities in this region. Their influence has been very slight even on the Somali language, whose structure and vocabulary are essentially Hamitic, with marked affinities to the Galla on the one hand and to the Dankali (Afar) on the other.

The present Somali peoples are possessed of no general type. They are not pure Hamites, and their physical characteristics vary considerably, showing signs of interbreeding with Galla, Afar, Arabs, Abyssinians, Bantus and Negroes. They are a

race of magnificent physique, tall, active and robust, with fairly regular features, but showing Negro blood in their frequently black complexion and still more in their kinky and even woolly hair. Their colour varies from the Arab hue to black, and curiously enough the most regular features are to be found among the darkest groups.

There are four classes in Somaliland: (1) nomads who breed ponies, sheep, cattle and camels, live entirely on milk and meat, and follow the rains in search of grass; (2) settled Somali, comparatively few, living in or near the coasts; (3) outcast races, not organized in tribes but living scattered all over Somaliland; they are hunters, workers in iron and leather, and the chief collectors of gum and resin; (4) traders. The national dress is the "tobe," a simple cotton sheet of two breadths sewn together, about 15 ft. long. Generally it is thrown over one or both shoulders, a turn given round the waist, and allowed to fall to the ankles. The "tobes" are of all colours from brown to white. A ceremonial "tobe" of red, white and blue, each colour in two shades, with a narrow fringe of light yellow, is sometimes worn. Old men shave the head and sometimes grow a beard. Middle-aged men wear the hair about an inch and a half long; young men and boys in a huge mop; while married women wear it in a chignon, and girls in mop-form but plaited.

The Somali are a fighting race and all go armed with spear, shield and short sword (and guns when they can get them). During the rains incessant intertribal lootings of cattle take place. Among certain tribes those who have killed a man have the right to wear an ostrich-feather in their hair. They are great talkers, keenly sensitive to ridicule, and quick-tempered.

Women hold a degraded position among the Somali (wives being often looted with sheep), doing most of the hard work. The Somali love display; they are inordinately vain and avaricious; but they make loyal and trustworthy soldiers and are generally bright and intelligent.

The Somali have very little political or social cohesion, and are divided into a multiplicity of *vers* or *fakidas* (tribes, clans). Three main divisions, however, have been clearly determined, and these are important both on political and ethnical grounds.

I. The **HASHIYA** (Abud's *Asha*), with two great subdivisions: *Daroda*, with the powerful Mijertins, War-Sangeli, Dolbohanti and others; and *Ishak*, including the Gadibursi, Issa (Aissa), Habr-Wal, Habr-Tol, Habr-Yuni, Babilbi, Bertiri. All these claim descent from a member of the Hashim branch of the Koreish (Mahomet's tribe), who founded a powerful state in the Zaila district. All are Sunnites, and, although still speaking their Somali national tongue, betray a large infusion of Arab blood in their oval face, somewhat light skin, and remarkably regular features. Their domain comprises the whole of British Somaliland, and probably most of Italian Somaliland.

II. The **HAWIYA**, with numerous sub-groups, such as the Habr-Jalet, Habr-Gader, Rer-Dollol, Daji, Karanle, Badbadan, Kunli, Bajimal and Ugass-Elmi; mostly fanatical Mahommedans forming the powerful Tarika sect, whose influence is felt throughout all the central and eastern parts of Somaliland. The Hawiya domain comprises the Ogaden plateau and the region generally between the Nogal and Webi-Shebéli rivers. Here contact has been chiefly with the eastern Galla tribes.

III. The **RAHANWIN**, with numerous but little-known sub-groups, including, however, the powerful and warlike Abgals, Barawas, Gobrons, Tuni, Jidus and Kalallas, occupy in part the region between the Webi-Shebéli and Juba, but chiefly the territory extending from the Juba to the Tana, where they have long been in contact, mostly hostile, with the Wa-Pokomo and other Bantu peoples of the British East Africa Protectorate. Of all the Somali the Rahanwin betray the largest infusion of negroid blood.

Of the outcast races the best known are the Midgan, Yebir, and Tomal. The Midgan, who are of slightly shorter stature than the average Somali, are the most numerous of these peoples. They are great hunters and use small poisoned arrows to bring down their game. The Yebir are noted for their leather work, and the Tomal are the blacksmiths of the Somali.

Prehistoric Remains.—The discovery of flint implements of the same types as those found in Egypt, Mauritania, and Europe show Somaliland to have been inhabited by man in the Stone age. That the country was subsequently occupied by a more highly civilized people than the Somali of to-day is evidenced by the ruins which are found in various districts. Many of

these ruins are attributable to the Arabs, but older remains are traditionally ascribed to a people who were "before the Galla." Blocks of dressed stone overgrown by grass lie in regular formation; a series of parallel revetment walls on hills commanding passes exist, as do relics of ancient water-tanks. This ancient civilization is supposed to have been swept away by Mahommedan conquerors; before that event the people, in the opinion of several travellers, professed a degraded form of Christianity, which they had acquired from their Abyssinian neighbours. Of more recent origin are the ruins known as Galla graves (*Taalla Galla*). These are cairns of piled stones, each stone about the size of a man's head. The cairns are from 12 to 15 ft. high and about 8 yds. in diameter. Each is circular with a central depression.

Exploration.—Somaliland was one of the last parts of Africa to be explored by Europeans. The occupation of Aden by the British in 1839 proved the starting-point in the opening up of the country, Aden being the chief port with which the Somali of the opposite coast traded. The task of mapping the coast was largely undertaken by officers of the Indian navy, while the first explorers of the interior were officers of the Indian army quartered at Aden—Lieut. Cruttenden (1848), Lieut. (afterwards Captain Sir Richard) Burton, and Lieut. J. H. Speke (the discoverer of the Nile source). In 1854 Burton, unaccompanied, penetrated inland as far as Harrar. Later on the expedition was attacked by Somali near Berbera, both Burton and Speke being wounded, and another officer, Lieut. Stroyan, R.N., killed. For twenty years afterwards no attempt was made to open up the country. The occupation of Berbera by the Egyptians in 1875 was, however, followed by several journeys into the interior. Of those who essayed to cross the waterless Haud more than one lost his life. In 1883 a party of Englishmen—F. L. and W. D. James (brothers), G. P. V. Aylmer, and E. Lort-Phillips—penetrated from Berbera as far as the Webi-Shebéli, and returned in safety. At the instance of the Indian government surveys of the country between the coast and the Webi-Shebéli and also east towards the Wadi Nogal were executed by Major H. G. C. Swayne and his brother Captain E. J. E. Swayne between 1886 and 1892. Meanwhile a French traveller, G. Révoil, had (1878–1881) made three journeys in the north-east corner of the protectorate, especially in the Darror valley. The first person who reached the Indian Ocean, going south from the Gulf of Aden, was an American, Dr A. Donaldson Smith (b. 1864). He explored (1894–1895) the headstreams of the Shebéli, reached Lake Rudolf, and eventually descended the Tana river to the sea, his journey thus taking him through southern Somaliland. Meantime the greater part of the eastern seaboard having fallen under Italian influence, the exploration of the hinterland had been undertaken by travellers of that nationality. In 1890 Brichetti-Robecchi made a journey along the eastern coast from Obbia to beyond Cape Guardafui. In the following year he went from Mukdishu to Obbia, and thence crossed through Ogaden to Berbera on the Gulf of Aden. In the same year Prince Eugenio Ruspoli made a journey southwards from Berbera, while two other Italians penetrated to Imi on the upper Shebéli, which place was also reached in 1903 by H. G. C. Swayne. In 1892 Captain Vittorio Bottego and a companion left Berbera and made their way past Imi to the upper Juba, which Bottego explored to its source, both travellers finally making their way via Lugh to the east coast. Prince Ruspoli in 1893 reached Lugh from the north, thence turning north-west. He was killed in the Galla country by an elephant. In 1895 Bottego, with three European companions, left Brava to investigate the river system north of Lake Rudolf, and succeeded in tracing the Omo to that lake. Subsequently in the Abyssinian highlands the expedition was attacked by Galla and Captain Bottego was killed. Dr Sacchi, who was returning to Lugh with some of the scientific results of the mission, was also killed by natives. An English expedition under H. S. H. Cavendish (1896–1897) followed somewhat in Donaldson Smith's steps, and the last named traveller again crossed Somaliland in his journey from Berbera via Lake Rudolf

to the Upper Nile (1899-1900). In 1902-1903 a survey of the Galla-Somali borderlands between Lake Rudolf and the upper Juba was executed by Captain P. Maud of the British army. Military operations during 1901-4 led to a more accurate knowledge of the south-eastern parts of the British protectorate and of the adjacent districts of Italian Somaliland.

BRITISH SOMALILAND

The British Somaliland protectorate extends along the Gulf of Aden for about 400 m. from the Lahadu Wells, near Jibuti, in the west, to Bandar Ziyada in 49° E., 180 m. W. of Cape Guardafui, and stretches from the coast inland for a breadth varying from 80 to 220 m. The protectorate is bounded W. by French Somaliland, S.W. by Abyssinian territory, and S.E. and E. by Italian Somaliland. About 50,000 persons are settled in the coast towns; the rest are nomads.

Topography, &c.—Physically the protectorate may be described as almost mountainous in contrast with the somewhat monotonous plains of the interior. Between the Harrar plateau and Cape Guardafui the coast ranges maintain a mean altitude of from 4000 to 5000 ft., and fall generally in steep escarpments down to the narrow strip of sandy lowlands skirting the Gulf of Aden. At some points the rugged cliffs, furrowed by deep ravines, approach close to the sea; elsewhere the hills leave a considerable maritime plain between their base and the shore line. South of Berbera are two ranges nearly parallel with the coast. They increase in elevation landwards, culminating in the inner and loftier Golis range, about 9500 ft. high, its crest covered with mountain cedar. The country between the two ranges is known as Guban. South of the Golis the ground falls gradually to the central plateau known as the Haud, a waterless but not unfertile district. The Haud (only the northern part of which is British territory—the rest is Abyssinian) consists partly of thorn jungle, the *haud* of the Somali, partly of rolling grass plains, called *ban*, and partly of semi-desert country called *aror*. Westward of Berbera the ascent to the high country is not so abrupt as in the east but is made by several steps, the mountains forming a chaotic mass. Eastwards the mountain system, the Jebel Sangeli, maintains the same general character as far as Bandar Gori (Las Korai), where the precipitous northern cliffs approach within 200 or 300 yards of the gulf, their bare brown rocks and clays presenting the same uninviting appearance as the light brown hills skirting the Red Sea. Immediately south of the Jebel Sangeli are the comparatively fertile Jidali and Gebi districts or river valleys—the Gebi flowing east in the direction of Ras Hafun, while the Jidali has a southerly course towards the Wadi Nogal. Its waters are lost in the arid stony plateau of the Sorl. To this succeeds the Nogal district, separated both from the Sorl and the Haud by ranges of low hills. The Nogal and the neighbouring regions of the Haud are also known, from the tribes inhabiting them, as the Dolbahanta country. The prevailing formations appear to be granites which are veined with white quartz, and underlying old sedimentary brown sandstone and limestone formations.

The average annual rainfall at Berbera is about 8 in., and more than half of this amount has fallen in one day. The mean annual rainfall is greater on the slopes of the ranges by which the moisture-bearing clouds are intercepted. These slopes are the home of aromatic flora which yields myrrh and frankincense.

The chief domestic animals are the camel and the ass, both of prime stock. The camels make excellent mounts, swift and hardy; and the extensive caravan trade is everywhere carried on exclusively by means of these pack-animals. The Somali have also large herds of cattle—oxen, sheep and goats. They possess a hardy breed of ponies, for which the Dolbahanta country is famed.

Chief Towns.—Berbera (*q.v.*) is the capital and chief seaport of the protectorate. About 45 m. west of Berbera is the exposed port of Bülhar. Close to the French frontier stands the seaport of Zaila (*q.v.*). East of Berbera are Las Korai, Karam, Haïs and other small seaports. Inland the most important settlement is Hargeisa (*i.e.* little Harrar), 60 m. S.S.W. of Bülhar, a centre for caravans from Shoa and Ogaden. Sheikh, Burao and Bohotle are all on the caravan route from Ogaden to Berbera.

Industries and Trade.—Fibre is obtained from the aloe plants, this industry being in the hands of women; ostriches are reared for the sake of their feathers, and large quantities of gum and resin are collected. But the wealth of the people consists chiefly in their livestock. Trade is largely with Harrar and the Ogaden country—both Abyssinian possessions. The important exports are gums and resin, fibre, hides, ivory, ostrich feathers, coffee, ghee, livestock, gold ingots from Abyssinia and mother-of-pearl; the shells being found along the coast from Zaila to beyond Berbera. There is also a profitable shark fishery in the hands of Arabs. The imports are mainly white longcloth, grey shirting, rice, jowaree, dates and sugar. Jowaree is displacing rice as the staple food of the Somali. The trade with Abyssinia suffers owing to the absence of railway communication, which the neighbouring French colony possesses. Thus in 1899-1900 the total value of trade was £751,900, the French railway being then but just begun; in 1902-1903, the railway being

completed during the year, the value of trade was but £487,900. The average annual value of trade for 1904-1909 was about £500,000.

History.—An Arah sultanate, with its capital at Zaila (Zeyla), was founded by Koreishite immigrants from the Yemen in, it is said, the 7th century A.D. In the 13th century it had become a comparatively powerful state, known as the empire of Adel. In the 16th century the capital of the state (in which Arab influence was a decreasing factor) was transferred to Harrar (*q.v.*). The state was greatly harassed by Galla invaders in the 17th century, and broke up into a number of petty independent emirates and sultanates under Somali chiefs. Zaila became a dependency of Yemen and thus nominally part of the Turkish empire. The British connexion with the Somali coast dates from the early years of the 19th century; the first treaty between the British and Somali having been signed in 1827 after the plundering of an English ship by the Habr-Wal. In 1840 various treaties were concluded by Captain Robert Moresby of the Indian Navy "on the part of the English Government in India" with the sultan of Tajura and the governor of Zaila, who engaged not to enter into treaties with any other foreign power. At the same time Musha Island, at the entrance to the Gulf of Tajura, was bought by the British "for ten bags of rice," Bab Island, in the same gulf, and Aubad Island, off Zaila, were also purchased, the object of the East India Company being to obtain a suitable place "for the harbour of their ships without any prohibition whatever." From this time onward the Indian government exercised considerable influence on the Somali coast, but British authority was not definitely established, and in 1854 Richard Burton's expedition was attacked at Berbera. In 1874-1875 the ambition of Ismail Pasha, khedive of Egypt, who claimed jurisdiction over the whole coast as far as Cape Guardafui, led him to occupy the ports of Tajura, Berbera and Bulhar as well as Harrar in the hinterland. Ismail also obtained (July 1875) a firman from the sultan of Turkey making over Zaila to Egypt in return for an increase of £15,000 yearly to the tribute paid to the Porte. In 1884, in consequence of the revolt of the mahdi in the Egyptian Sudan, the khedival garrisons were withdrawn. Thereupon Great Britain, partly to secure the route to the East via the Suez Canal, which the occupation of the country by another power might menace, occupied Zaila, Berbera and Bulhar, officials being sent from Aden to govern the ports. With respect to Zaila Turkey **Establishment of a British Protectorate.** was given the option of resuming possession, but no advantage was not taken of the offer (see Lord Cromer's *Modern Egypt*, 1908, vol. ii.). During 1884, 1885, 1886 treaties guaranteeing British protection were concluded with various Somali tribes and in 1888 the limits of the British and French spheres were defined, all claims to British jurisdiction in the Gulf of Tajura and the islands of Musha and Bab being abandoned. The other inland boundaries of the protectorate were defined by agreements with Italy (1894) and Abyssinia (1897).

In 1899 troubles arose between the administration and a mullah of the Habr Suleiman Ogaden tribe, who had acquired great influence in the Dolbahanta country and had married into the Dolbahanta Ali Gheri. This mullah, Mahommed bin Abdullah by name, had made several pilgrimages to Mecca, where he had attached himself to a sect which enjoined strict observance of the tenets of Islam and placed an interdiction on the use of the leaves of the kat plant—much sought after by the coast Arabs and Somali for their stimulating and intoxicating properties. At first the mullah's influence was exerted for good, and he kept the tribes over whom he had control at peace. Accredited with the possession of supernatural powers he gathered around him a strong following. In 1899 the mullah began raiding tribes friendly to the British; in August of that year he occupied Burao, 80 m. south and east of Berbera, and declared himself the mahdi. In the autumn of 1900 the mullah was again harassing the tribes on the southern border of the British protectorate and the neighbouring Abyssinian districts. The tribes hostile to the mullah sought British protection, and Colonel (afterwards Sir) E. J. E. Swayne raised a Somali levy of 1500 men, and in May 1901 occupied Burao.

On the 2nd of June a small force, zeribaed under Captain Malcolm McNeill, was attacked by the mullah's followers but repulsed after desperate fighting. Colonel Swayne thrice defeated the enemy, who lost 1200 men and 600 taken prisoners, and the mullah fled across the Haud, taking refuge with the Mijertin in Italian territory. In December 1901 the mullah was, however, once more raiding in the neighbourhood of Burao, and in May

Wars with the Mullah. 1902 Colonel Swayne led another expedition against him, the Somali levies being strengthened by the 2nd **Mahomed King's African Rifles**, consisting of Yaos from Nyasa-**Abdullah** land. Overcoming in a remarkable manner the difficulties of operating in the dry season, Colonel Swayne harried the mullah incessantly, and followed him across the Haud into the more fertile region of Mudug in Italian territory, permission so to do being granted by Italy. On the 6th of October, while marching through dense bush at Erigo, the British force was ambuscaded. The British lost 101 killed and 85 wounded, but put the enemy to flight. The mullah lost some 700 men and retreated to Galadi, west of Mudug, a place with ample water supplies. Colonel Swayne was not able to continue the pursuit, and returned to Berbera. It was then determined that in the further operations against the mullah the main advance should be from a base on the east coast of Italian Somaliland—the open roadstead of Obbia being chosen. The command was given to Brigadier-General W. H. Manning, and small numbers of British and Boer mounted infantry, Indian and African troops were employed, while an Abyssinian force held the line of the Webi Shebéli. Manning advanced from Obbia in February 1903, and in March got in touch with the northern column, the line of communication stretching over 500 m. The mullah was west of this line in the neighbourhood of Galadi. The wells at Galadi were occupied by the British early in April without opposition. A reconnoitring force of 500 men under Lieut.-Colonel A. S. Cobbe (who had gained the V.C. at Erigo) was pushed west to Gumburu, and came into contact with the enemy. A detachment of this force, consisting of 200 Yaos and Sikhs under Lieut.-Colonel Plunket, was attacked on the 17th of April and overwhelmed. Of the whole party only 40 Yaos, of whom 36 were wounded, escaped; 10 British officers being among the slain. Meantime from Bohotle a force had advanced under Major Gough to Daratole, a spot not far from Gumburu. It had a stiff fight on the 23rd of April and was obliged to fall back. After these events the Obbia line of communication was closed up, and Manning's force concentrated at Bohotle. The mullah now broke away to the north, and, crossing the line of the British communication, established himself in the Nogal district.

Another campaign being deemed necessary, reinforcements bringing the fighting force up to 7000 men were sent out, and Major-General Sir C. C. Egerton assumed supreme command, Manning retaining command of the first column. In October 1903 a new forward movement was begun, the mullah being still in the eastern Nogal, while he had also seized the Italian seaport of Illig, north of Obbia. In a pitched battle fought on the 10th of January 1904 at Jidballi in the Nogal country the enemy were routed, losing over 1000 men in killed alone, while the British loss in killed and wounded was 58. The mullah and his chief adviser, a Haji Sudi, formerly an interpreter on a British warship, were not at the battle, and with his Ali Gheri followers he now fled north across the Sorl, apparently intending, if further pressed to retreat to Illig. This port was accordingly for a short time (April 1904) occupied by a British naval force. By May the mullah had been driven out of the British protectorate and became a refugee among the Mijertin. It was decided therefore to abandon offensive operations. In 1905 the Italians effected an arrangement apparently satisfactory to all parties (see § *Italian Somaliland*).

For some three years the mullah remained quiescent, but in 1908 he quarrelled with the Mijertins and in 1909 he was again raiding tribes in the British protectorate. The British government (the Asquith cabinet) came to the conclusion that another expedition against

the mullah would be useless; that they must either build a railway, make roads and effectively occupy the whole of the protectorate, or else abandon the interior completely. The latter course was decided upon, and during the first months of 1910 the advanced posts were withdrawn and the British administration confined to the coast towns. In support of this decision it was urged that it was no good pursuing people whom it was impossible to catch, that the isolated posts in the interior had not been able to protect the friendly tribes; and that the semi-desert nature of the country did not justify any attempt at economic development. (The proposal to build a railway from Zaila or Berbera to Harrar, which would have competed with the French line from Jibuti for the trade of southern Abyssinia, had been vetoed on grounds of general policy.) Before the withdrawal arrangements—more or less ineffective—were made for arming and organizing the tribes in the protectorate in their own defence.

From 1884 to 1898 the protectorate was attached for administrative purposes to Bombay, and was immediately dependent on Aden; in the last-named year it was transferred to the Foreign Office, and in 1905 passed under the control of the Colonial Office. From 1902 to 1906 Colonel Swayne was commissioner; he was succeeded by Captain H. E. S. Cordeaux, who had served in Somaliland since 1898. Legislative power is in the hands of the commissioner, and revenue is obtained largely from customs. The revenue, £22,000 in 1900-1901, was £30,000 in 1908-1909, while the expenditure, £51,000 in the first-named year, was £134,000 in 1908-1909. Deficits are made good by grants from the imperial treasury.

FRENCH SOMALILAND

French Somaliland (*Côte française des Somalis*) lies at the entrance to the Red Sea. The sea frontier extends from Ras Dumeira on the Straits of Bab-el-Mandeb, a little north of Perim Island, to Ras Gurmarle, a few miles south of the Gulf of Tajura. The protectorate is bounded N. by the Danakil country; S. by British Somaliland; W. by the Harrar province of Abyssinia. It extends inland at its greatest depth about 130 m.

The country consists chiefly of slightly elevated arid plains, largely waterless save along the southern frontier. The only good harbour along the coast is at Jibuti. The Gulf of Tajura is 28 m. across at its entrance and penetrates inland 36 m. At its western end an opening 870 yds. wide leads into the circular bay of Gubbet-Kharab (Hell's Mouth), behind which rise a chaotic mass of volcanic rocks, destitute of vegetation and presenting a scene of weird desolation. A pass through the hills gives access to Bahr-Assal; the last of a chain of salt lakes beginning 60 m. inland in the depression in which the waters of the Hawash (see ABYSSINIA) lose themselves. It is conjectured that at some remote period the Hawash flowed into Tajura Bay and that the present condition of the country is the result of volcanic upheaval. Assal Lake, according to this theory, formed part of the sea bed. It is now 5 m. inland from Gubbet-Kharab, is 5 m. long by 4 broad, and lies 490 ft. below sea level. About 160 ft. above the present level of the lake a white band marks distinctly a former level. The waters of Bahr-Assal are deeply impregnated with salt, which, in thick crusts, forms crescent-shaped round the banks—dazzling white when reflected by the sun. Two streams, one saline and at a temperature of 194° F., flow into the lake. The climate of the protectorate is very hot, but not unhealthy for Europeans if reasonable precautions be taken.

Inhabitants and Towns.—The inhabitants are, on the north side of the Gulf of Tajura, chiefly Danakils (Afars, *q.v.*); on the southern shore Galla and Somali. There are a number of Arabs, Abyssinians, Indians, and about 2000 Europeans and Levantines. The chief town and seat of administration is Jibuti (*q.v.*), pop. about 15,000, which has taken the place of Obok (*q.v.*), on the opposite (northern) side of the Gulf of Tajura. Also situated on the gulf are the small towns of Tajura, Sagallo, Gobad and Ambabo.

Trade and Communications.—The collection of salt from Bahr-Assal is an industry of some importance. In 1903 a beginning was made in the cultivation of cotton in the dry river beds, where water can always be obtained at a depth of 10 ft. On the coast turtle and mother-of-pearl fishing are carried on. But the value of the protectorate depends upon the carrying trade with Harrar and the supplying of victuals and coals to French warships. In 1897 the building of a railway from Jibuti towards Harrar was begun. By Christmas 1902 the railway, called the Imperial Ethiopian railway, was completed to Dire Dawa (or Adis Harrar), 30 m. short of Harrar, and 188 by rail from Jibuti, of which but 64 m. are in French territory. By a law passed by the French chambers in 1902 a subvention of £20,000 a year for fifty years was granted to the company owning the railway (see further ABYSSINIA).

The exports are chiefly coffee, hides, ivory (all from Abyssinia), gum, mother-of-pearl and a little gold; the imports cotton and other

European stuffs, cereals, beverages, tobacco and arms and ammunition for the Abyssinians. The total volume of trade in 1902, the year of the completion of the railway, was £725,000, in 1905 it had risen to £1,208,000—imports £480,000, exports £728,000.

History.—French interest in the Somali and Danakil coasts dates from the days of the Second Empire. Count Stanislas Russell, a naval officer, was sent on a mission to the Red Sea in 1857, and he reported strongly on the necessity of a French establishment in that region in view of the approaching completion of the Suez Canal. The only result of his enterprise was the abortive treaty for the cession to France of Zula (*q.v.*), now in the Italian colony of Eritrea. In 1856, however, M. Mönge, vice-consul of France at Zaila, had bought Ambabo, and shortly afterwards Henri Lambert, French consul at Aden, bought the town and territory of Obok. Lambert (who was assassinated by Arabs, June 1859) had the support of his government, which viewed with alarm the establishment (1857) of the British on Perim Island, at the entrance to the Red Sea. The cession of Obok was ratified by a treaty (signed on the 11th of March 1862) between the French government and various Danakil chiefs. It was not, however, until 1883 that, in consequence of events in Egypt and the Sudan (see EGYPT: *History*), formal possession was taken of Obok by the French government. In 1884 Léonce Lagarde, subsequently French minister to Abyssinia, was sent to administer the infant colony. Between 1883 and 1887 treaties with Somali sultans gave France possession of the whole of the Gulf of Tadjura. An agreement with Great Britain (February 1888) fixed the southern limits of the protectorate; protocols with Italy (January 1900 and July 1901) the northern limits. The frontier towards Abyssinia was fixed by a convention of March 1897 with the Negus Menelik. In this direction the protectorate extends inland some 56 m. In 1889 a Cossack chief, Captain Atchinoff, who had occupied Sagallo, was forcibly removed by the French authorities (see SAGALLO). The transference of the seat of government to Jibuti in May 1896 and the building of the railway to Harrar gave the protectorate a stability which it had previously lacked. Its importance to France is, nevertheless, chiefly strategic and political. It serves as a coaling station for men-of-war and as a highroad to Abyssinia.

ITALIAN SOMALILAND

Italian Somaliland extends on the coast from Bandar Ziyada, a point on the Gulf of Aden intersected by 49° E., eastward to Cape Guardafui, and thence southward to the mouth of the river Juba in 0° 15' S. Bounded N. and E. by the Indian Ocean it is separated S. from British East Africa by the Juba. Westward it is bounded by Abyssinian and British Somaliland. From the east coast the protectorate extends inland from 100 to 300 m.

The coast-line is largely rock-bound and little indented, and throughout the 1200 m. of its extent there is not one good harbour. The northern shore, along the Gulf of Aden, is backed by tablelands separated by the beds of mountain torrents—generally dry. From the table-land rise hills, such as Jebel Kurma, which have an altitude of 4000 ft. or more. The coast rises in a succession of hills (fringed by a narrow margin of beach) until Cape Guardafui is reached. Cape Guardafui is in 11° 75' N., 51° 26' 32" E., and forms, as it were, the tip of the Horn of Africa. The cape, which faces north and east, presents on its northern face a nearly vertical wall of rock rising from the sea to a height of 900 ft. The water is deep right to the base of the cliff and owing to the winds and the strength of the ocean currents, navigation is dangerous. The headland is known to the Somali as Girdif or Yardaf—whence in all probability comes the European form Guardafui. But in the *lingua franca* of the Levant the Italian word *guarda* means "beware," a meaning also attached to the Portuguese word *guardafu*. Rounding Guardafui the coast trends southwards, and some 90 m. from that cape is Ras Hafun or Medudda—the most easterly point of the continent of Africa—being in 10° 45' S., 51° 27' 52" E., or about a mile and a half east of Guardafui. Ras Hafun consists of a rocky peninsula rising 600 ft. above the sea, and is connected with the mainland by an isthmus 12 m. long. A little south is the mouth of the Darror, a usually dry watercourse with a length of over 200 m., which rises, as the Gebi, in the north-east of the British protectorate. From this point a zone of upheaved coral rocks skirts the shore for some distance.

Chief Towns.—The chief towns are on the coast. They are Mukdishu (*q.v.*), pop. about 5000, Brava (4000), Marka (5000),

Warsheik (3000) and Yub. These are all in the southern part of the protectorate between 0° 15' S. and 2° 19' N., and are known generically as El-Benadir (the ports), a name also applied to the coast between the ports. Yub (Jub) is a small town at the mouth of the Juba river. In every case the port is much exposed and unapproachable for months together. Obbia, 5° 22' N., and Illig in 7° 60' N., are points of departure for the Ogaden and Dolbahanta countries. Alula, on the Gulf of Aden, is the chief town of the Mijertin Somali.

In the interior is Lugh, a populous city on the left bank of the Juba, about 240 m. from the coast, and further inland is Dolo at the confluence of the Daua and Ganale to form the Juba. These places are entrepôts for the trade of the interior, especially with the Boran district.

In the coast towns of the eastern seaboard there are Swahili, Arab and Indian settlements, and tribes, such as the Amaran, of mixed Arab and Somali blood.

Agriculture and Trade.—Though much of the land is barren, the soil is fairly fertile in the valleys of the Webi Shebeli and Wadi Nogal. But the most fertile district is the valley of the lower Juba, where for over 100 m. is a strip of land varying from a few hundred yards to some 4 m. wide, annually inundated by the rise of the river. Here are cultivated rich crops of millet and other grains. In other districts lack of water impedes cultivation, though after the rains pasturage is abundant, and resinous plants are so varied and numerous as to justify the ancient name of the region.

Ivory, cattle, butter, coffee, cotton, myrrh, gums and skins are exported from the Benadir country. In the northern ports there is a similar but smaller trade and one also in ostrich feathers. The chief imports are textile fabrics, rice and petroleum. During 1896–1897 the value of the Benadir trade was £120,000; in 1906–1907 it had risen to over £250,000.

History.—The Somali coast, as has been seen, early fell under Moslem influence. The towns on the eastern seaboard, of which Mukdishu and Brava were the chief, formed part of the Zenz "empire" (see ZANZIBAR) and shared its fate, being conquered in turn by the Portuguese (16th century), the imams of Muscat (17th century), and the sultans of Zanzibar (1866). On account, probably, of the inhospitable nature of the shore the northern portion of the protectorate appears to have been little subject to hostile invasion. By treaties with Somali sultans in 1889 and by subsequent agreements with Great Britain, Zanzibar and Abyssinia, the coast east of the British Somali protectorate fell within the Italian sphere of influence (see AFRICA, § 5). In August 1892 the sultan of Zanzibar leased the Benadir ports of Italy for fifty years. They were administered first by the Filonardi Company, and from 1898 by the Benadir Company. By an agreement dated the 13th of January 1905 the sultan of Zanzibar ceded his sovereign rights in the Benadir ports to Italy in return for the payment of a lump sum of £144,000. Thereafter the Italian government assumed the direct administration of the ports, a purely commercial undertaking replacing the Benadir Company. In 1905 also Great Britain leased to Italy a piece of land near Kismayu to facilitate communications with the Benadir country. In 1908 a royal decree placed that part of the country between the Juba and the sultanate of Obbia under a civil governor.

A notable event in the history of the protectorate was the co-operation of the Italian authorities in the campaigns against the Mullah Abdullah. In 1904 negotiations were opened with the mullah by the Italians, and by arrangement with the sultan of Obbia and the sultan of the Mijertins the territory between Ras Aswad and Ras Bowen, which was claimed by both parties, was handed over to the mullah. This region, that of the lower Nogal, included the port of Illig. Here Mahommed b. Abdullah established himself under Italian surveillance, and by an agreement dated the 5th of March 1905, peace was declared between the mullah, the Italians, British and Abyssinians, and all other Somali tribes. In 1908–1909, however, fighting was renewed, the mullah and the Mijertins failing to agree. Italian (native) troops were sent to the district to restore order. The mullah also attacked tribes living in the British protectorate (see § 2).

The station of Lugh, the most advanced point occupied by Italy, had been founded by Captain Bottego in 1895. After the treaty of Adis Adowa, recognizing the independence of Abyssinia, had been concluded in 1896, negotiations were opened for defining the Italian-Abyssinian frontier in the Somali regions. In 1897 an agreement was come to that from the point on the

British Somaliland frontier where 47° E. intersected 8° N. the frontier line should be drawn, at a distance of about 180 m. from the Indian Ocean, to the Juba. At the close of 1907 the Negus Menelik, in return for a pecuniary indemnity (£120,000), agreed to a modification of the 1897 line, whereby the Italian protectorate was extended north of Lugh to Dolo. From Dolo the frontier goes east to the Webi Shebeli, whence the 1897 line is followed to the British-Abyssinian frontier. By this arrangement (ratified by a convention dated the 16th of May 1908) the Benadir coast obtained a suitable hinterland.

BIBLIOGRAPHY.—*a.* General descriptions, history and books of travel. G. Ferrand, *Les Comôlis* (Paris, 1903), a brief but comprehensive survey; R. Burton, *First Footsteps in East Africa* (London, 1856); F. L. James, *The Unknown Horn of Africa* (London, 1888); H. G. C. Swayne, *Seventeen Trips through Somaliland* (3rd ed., London, 1903), perhaps the best general book on the country, contains a special fauna section; G. Révoil, *La Vallée de Darror* (Paris, 1882) and *Dix mois à la côte orientale d'Afrique* (Paris, 1888); A. Donaldson Smith, *Through Unknown African Countries* (London, 1897); V. Bottego, *Il Guiba esplorato* (Rome, 1895); L. Robecchi-Bricchetti, *Somalia e Benadir . . . Prima traversata della Somalia italiana* (Milan, 1899) and *Nel paese degli Aromi* (Milan, 1903); M. Guillaïn, *Documents sur l'histoire . . . de l'Afrique orientale* (Paris, n.d. [1856]); P. Paulitschke, *Harar* (Leipzig, 1888).

b. Ethnology, flora, fauna, geology, &c. P. Paulitschke, *Ethnographie Nordost-Afrikas. Die materielle Cultur der Danakil, Galla und Somäl*, vol. ii. (Berlin, 1893). *Die geistige Cultur der Danakil*, &c. (1896), and *Beiträge zur Ethnographie und Anthropologie der Somäl, Galla und Harrari* (Leipzig, 1886), containing fine plates; H. M. Abud, *Genealogies of the Somäl . . .* (London, 1896); A. Engler on the flora in the *Sitzungsberichte of the Prussian Academy of Science*, Nos. x.-xii. (1904); G. Révoil, *Faune et flore des pays Somalis* (Paris, 1882); C. V. A. Peel, *Somaliland . . . with a complete list of every animal and bird known to inhabit that country . . .* (London, 1900), and "On a collection of Insects and Arachnids" in *Proc. Zool. Soc.* (1900); R. E. Drake-Brockman, *The Mammals of Somaliland* (London, 1910); J. W. Gregory, "The Geology of Somaliland," *Geol. Mag.* (1896).

c. Language. Leo Reinisch, *Die Somalie Sprache* (Vienna, 1900, et seq.); F. M. Hunter, *Grammar of the Somal Language* (Bombay, 1880); E. de Larajasse and C. de Sampont, *A Practical Grammar of the Somal Language* (London, 1897); E. de Larajasse, *Somali-English and English-Somali Dictionary* (London, 1897).

d. For the various protectorates, (1) British—the annual reports issued by the Colonial Office, London; *Official History of the Operations in Somaliland, 1901-1904* (2 vols., London, 1907); War Office maps on the scale of 1:1,000,000, also sketch map 1:3,000,000 (1907). (2) French protectorate—*L'Année coloniale* (Paris); L. Henrique, *Les Colonies françaises* (Obock) (Paris, 1899); L. de Salma, *Obock* (Paris, 1893); *Carte de la côte française des Somalis*, 1:500,000 (Paris, 1908). (3) Italian protectorate—*Somalia italiana, 1885-1895* (official "Green Book"); C. Rossetti, *Somalia italiana settentrionale*, with map (Rome, 1906); U. Ferrandi, *Seconda spedizione Bottego: Lugh emporio commerciale sul Giuba* (Rome, 1903).

The *Bibliografia etiopica* of G. Fumagalli (Milan, 1893) includes works dealing with Somaliland. (F. R. C.)

SOMBRERO, a wide-brimmed hat, made of felt, largely worn throughout South and Central America, but originating in Spain. The Spanish word is derived from *sombra*, shade, generally taken to be from Lat. *sub umbra*, beneath the shade; but the etymology, like that of "sombre," dark, gloomy, has been disputed.

SOMERS, JOHN SOMERS (OR SOMMERS), BARON (1651-1716), English lord chancellor, was born on the 4th of March 1651, near Worcester, the eldest son of John Somers, an attorney in large practice in that town, who had formerly fought on the side of the Parliament, and of Catherine Ceaverne of Shropshire. After being at school at Worcester he was entered as a gentleman commoner at Trinity College, Oxford, and afterwards studied law under Sir Francis Winington, who became solicitor-general, and joined the Middle Temple. He appears, in addition to his legal studies, to have written several poems and pamphlets. He soon became intimate with the leaders of the country party, especially with Essex, William Russell, and Algernon Sidney, but never entered into their plans so far as to commit himself beyond recall. He was the author of the *History of the Succession of the Crown of England, collected out of Records, &c.*, and was reputed to have written the *Just and Modest Vindication of the Two Last Parliaments*, which was put forward as the answer to

Charles II.'s famous declaration of his reasons for dissolving them. This, however, was by Sidney, though probably Somers was responsible for the final draft. When the grand jury of Middlesex threw out the bill against Shaftesbury, and were vehemently attacked for so doing, Somers wrote in defence of the rights of grand juries. In 1683 he was counsel for the sheriffs Pilkington and Shute before the court of King's Bench, and secured a reputation which continually increased until the trial of the seven bishops, in which he was junior counsel. "Somers rose last. He spoke little more than five minutes, but every word was full of weighty matter; and when he sat down his reputation as an orator and a constitutional lawyer was established." In the secret councils of those who were planning the revolution Somers took a leading part, and in the Convention Parliament was elected a member for his native town. He was immediately appointed one of the managers for the Commons in the conferences between the houses, and in arguing the questions whether James II. had left the throne vacant by abdication and whether the acts of the Convention Parliament were legal—that parliament having been summoned without the usual writs—he displayed great learning and legal subtlety. He was further distinguished by being made chairman of the committee which drew up the celebrated Declaration of Right.

In May 1689 Somers was made solicitor-general. He now became William III.'s most confidential adviser. In the controversy which arose between the Houses on the question of the legality of the decision of the court of King's Bench regarding Titus Oates, and of the action of the Lords in sustaining this decision, Somers was again the leading manager for the Commons, and has left a clear and interesting account of the debates. He was next employed in January 1690 as chairman of the select committee of the House of Commons on the Corporation Bill, by which those corporations which had surrendered their charters to the Crown during the last two reigns were restored to their rights; but he refused to associate himself with the violent measures of retaliation which the Whigs on that occasion endeavoured to include in the bill. In April a speech by him carried through the lower house, without opposition, the bill which declared all the laws passed by the Convention Parliament to be valid. As solicitor-general he had to conduct the prosecution of Preston and Ashton in 1691, and did so with a moderation and humanity which were in marked contrast to the customs of the former reigns. He was soon after appointed attorney-general, and in that capacity strongly opposed the bill for the regulation of trials in cases of high treason. On the 23rd of March 1693, the great seal having meanwhile been in commission, Somers was appointed lord-keeper, with a pension of £2000 a year from the day on which he should quit his office, and at the same time was made a privy councillor. He had previously been knighted. Somers now became the most prominent member of the Junto, the small council which comprised the chief members of the Whig party. When William left in May 1695 to take command of the army in the Netherlands, Somers was made one of the seven lords-justices to whom the administration of the kingdom during his absence was entrusted; and he was instrumental in bringing about a reconciliation between William and the princess Anne.

In April 1697 Somers was made lord chancellor, and was created a peer by the title of Baron Somers of Evesham. When the discussion arose on the question of disbanding the army, he summed up the case against disbanding, in answer to Trenchard, in a remarkable pamphlet called "The Balancing Letter." In August 1698 he went to Tunbridge Wells for his health. While there he received the king's letter announcing the first Partition Treaty, and at once replied with a memorandum representing the necessity in the state of feeling in England of avoiding further war. When the king, on the occasion of the Disbanding Bill, expressed his determination to leave the country, Somers boldly remonstrated, while he clearly expressed in a speech in the Lords the danger of the course that was being taken. Hitherto Somers's character had kept him free from attack at the hands

of political opponents; but his connexion in 1699 with the notorious Captain William Kidd, to the cost of whose expedition Somers had given £1000, afforded an opportunity; the vote of censure, however, proposed upon him in the House of Commons for giving Kidd a commission under the great seal was rejected by 199 to 131. The attack was renewed shortly on the ground of his having accepted grants of Crown property to the amount of £1600 a year, but was again defeated. On the subject of the Irish forfeitures a third attack was made in 1700, a motion being brought forward to request the king to remove Somers from his counsels and presence for ever; but this again was rejected by a large majority. In consequence, however, of the incessant agitation William now requested Somers to resign; this he refused to do, but gave up the seals to William's messenger. In 1701 he was impeached by the Commons on account of the part he had taken in the negotiations relating to the Partition Treaty in 1698, and defended himself most ably before the house, answering the charges seriatim. The impeachment was voted and sent up to the Lords, but was there dismissed. On the death of the king Somers retired almost entirely into private life. He was president of the Royal Society from 1699 to 1704. He was, however, active in 1702 in opposing the Occasional Conformity Bill, and in 1706 was one of the managers of the union with Scotland. In the same year he carried a bill regulating and improving the proceedings of the law courts. He was made president of the council in 1708 upon the return of the Whigs to power, and retained the office until their downfall in 1710. He died on the 26th of April 1716. Somers was never married, but left two sisters, of whom the eldest, Mary, married Charles Cocks, whose grandson, Sir Charles Cocks, bart., became the second Lord Somers in 1784, the title subsequently descending in this line.

For a contemporary character of Somers Addison's paper in the *Freeholder* for the 14th of May 1716 should be referred to; and there is in Macaulay's *History* (iv. 53) an eloquent and worthy tribute to his stainless character and comprehensive learning. A catalogue of his publications will be found in Walpole's *Royal and Noble Authors*. (O. A.)

SOMERSET, EARLS AND DUKES OF. In the 11th century Somerset and Dorset were under the jurisdiction of one sheriff, and for a considerable period titles derived from each of these shires were borne by the same person. (See DORSET, EARLS, MARQUESSSES AND DUKES OF.)

The earldom of Somerset in the Beaufort family dated from 1397, in which year it was granted by Richard II. to John Beaufort (c. 1373-1410), the eldest of the three illegitimate, but afterwards legitimated, sons of John of Gaunt, duke of Lancaster, by Catherine, wife of Sir Hugh Swynford, and daughter of Sir Payne Roelt. He was followed in the earldom successively by his three sons: Henry, who died unmarried in 1418; John (1404-1444), who in 1443 was created earl of Kendal and duke of Somerset, both of which titles became extinct at his death; and Edmund, who was created earl of Dorset in 1441, marquess of Dorset in 1443, and duke of Somerset in 1448. (See SOMERSET, EDMUND BEAUFORT, DUKE OF.) On the execution of Edmund's son Henry, 5th earl and 2nd duke of Somerset, by the Yorkists in 1464, his titles were forfeited by act of parliament; but his brother Edmund was from that date styled duke of Somerset by the Lancastrian party till his death in May 1471, when the house of Beaufort became extinct. (See BEAUFORT.) In 1499 Henry VII. nominated his infant son Edmund to the dukedom of Somerset at his baptism, but the child, who died within a few months, was probably never formally created a peer; the title, conjoined with the dukedom of Richmond, was, however, borne by Henry Fitzroy, illegitimate son of Henry VIII., from 1525 till his death without heirs in 1536.

EDWARD SEYMOUR, duke of Somerset (*q.v.*), known as the Protector, was the first of the line of dukes to which the holder of the title at the present day belongs, having been created Viscount Beauchamp of Hache, Co. Somerset, in 1536; earl of Hertford in 1537; and in 1547 Baron Seymour and duke of Somerset. His honours, which were entailed on the issue of

his second in priority to that of his first marriage, being forfeited by attainder in 1552, Robert Carr became earl of Somerset (*q.v.*) in 1613, but died without male issue in 1645, when his title became extinct. A curious incident in the history of this title was the grant by Charles I. in 1644 of a commission to Edward Somerset, son of Henry, 1st marquess of Worcester, empowering him to fill up certain blank patents of peerage with a promise of the title of duke of Somerset for himself. After the Restoration this instrument was cancelled in consequence of a resolution of the House of Lords declaring it to be "in prejudice to the peers"; and the grantee, who had meantime succeeded to the marquessate of Worcester, surrendered his claim to the dukedom of Somerset in September 1660. In the same month the dukedom of Somerset and barony of Seymour were restored to William Seymour (1588-1660), great-grandson of the Protector, who in 1621 inherited the titles of earl of Hertford and Baron Beauchamp which had been granted to his grandfather Edward Seymour in 1559, and who, in 1640, had himself been created marquess of Hertford. This nobleman, who in early life had incurred the displeasure of James I. by marrying the king's cousin, Lady Arabella Stuart, and had been imprisoned in the Tower for the offence, had later an exceptional claim on the gratitude of the royal house of Stewart, for he fought with distinction on the royalist side in the civil war, and was one of four lords (the others being the duke of Richmond, and the earls of Lindsey and Southampton) who petitioned the Commons to be allowed to assume responsibility for the actions of Charles I. and to suffer death in his place. He died in November 1660, a few weeks after his restoration to the dukedom, and, having outlived his three eldest sons, was succeeded by his grandson William, 3rd duke of Somerset (c. 1651-1671). As the latter died unmarried, his sister Elizabeth brought to her husband, Thomas Bruce, 2nd earl of Ailesbury, the great estates of Tottenham Park and Savernake Forest in Wiltshire; while the Somerset title devolved on John Seymour (c. 1628-1675), the 2nd duke's fifth and youngest son. At the death of the latter without issue in April 1675 the marquessate of Hertford became extinct, and his cousin Francis Seymour (1658-1678) became 5th duke of Somerset. This nobleman was the eldest surviving son of Charles Seymour, 2nd Baron Seymour of Trowbridge, whose father Sir Francis Seymour (c. 1590-1664), a younger brother of the 2nd duke of Somerset, was created a baron in 1641.

CHARLES SEYMOUR, 6th duke of Somerset (1662-1748), succeeded his brother Francis, the 5th duke, when the latter was shot in 1678 at the age of twenty, by a Genoese gentleman named Horatio Botti, whose wife Somerset was said to have insulted at Lerici. Charles, who thus inherited the barony of Seymour of Trowbridge along with the dukedom of Somerset, was educated at Trinity College, Cambridge; and in 1682 he married a great heiress, Elizabeth, daughter of Joceline Percy, earl of Northumberland, who brought him immense estates, including Alnwick Castle, Petworth, Syon House and Northumberland House in London. (See NORTHUMBERLAND, EARLS AND DUKES OF.) In 1683 Somerset received an appointment in the king's household, and two years later a colonelcy of dragoons; but at the revolution he bore arms for the prince of Orange. Having befriended Princess Anne in 1692, he became a great favourite with her after her accession to the throne, receiving the post of master of the horse in 1702. Finding himself neglected by Marlborough, he made friends with the Tories, and succeeded in retaining the queen's confidence, while his wife replaced the duchess of Marlborough as mistress of the robes in 1711. In the memorable crisis when Anne was at the point of death, Somerset acted with Argyll, Shrewsbury and other Whig nobles who, by insisting on their right to be present in the privy council, secured the Hanoverian succession to the Crown. He retained the office of master of the horse under George I. till 1716, when he was dismissed and retired into private life; he died at Petworth on the 2nd of December 1748. The duke's first wife having died in 1722, he married secondly, in 1726, Charlotte, daughter of the 2nd earl of Nottingham. He was a remarkably handsome man, and inordinately fond of taking a

conspicuous part in court ceremonial; his vanity, which earned him the sobriquet of "the proud duke," was a byword among his contemporaries and was the subject of numerous anecdotes; Macaulay's description of him as "a man in whom the pride of birth and rank amounted almost to a disease," is well known. His son Algernon (1684-1750), by his first wife Elizabeth Percy, was called to the House of Lords as Baron Percy in 1722; and after succeeding his father as 7th duke of Somerset in 1748, was, on account of his maternal descent, created Baron Warkworth and earl of Northumberland in 1749, with remainder to Sir Hugh Smithson, husband of his daughter Elizabeth; and also Baron Cockermouth and earl of Egremont, with remainder to the children of his sister, Lady Catherine Wyndham. At his death without male issue in February 1750 these titles therefore passed to different families in accordance with the remainders in the patents of their creation; the earldom of Hertford, the barony of Beauchamp, and the barony of Seymour of Trowbridge became extinct; and the dukedom of Somerset, together with the barony of Seymour, devolved on a distant cousin, Sir Edward Seymour, 6th baronet of Berry Pomeroy, Devonshire. (See SEYMOUR, or ST MAUR.)

The Seymours of Berry Pomeroy were the elder branch of the family, being descended from the protector Somerset by his first marriage, the issue of which had been excluded from succession to the titles and estates until after the failure of the issue of his second marriage (see above), which failure occurred on the death of the above-named Algernon, 7th duke. Sir Edward Seymour (1695-1757), who thus became 8th duke of Somerset, was grandson of Sir Edmund Seymour, Speaker of the House of Commons in the reign of Charles II. His two sons succeeded in turn to the dukedom, and his grandson Edward Adolphus, 11th duke (1775-1855), was a mathematician and scientist of some distinction. The latter's son Edward Adolphus, 12th duke (1804-1885), was educated at Eton and Christ Church, Oxford, and from 1830 till he succeeded to the peerage in 1855 he was a Liberal member of the House of Commons as Lord Seymour, first for Okehampton, and afterwards for Totnes. He held various offices in Lord Melbourne's administration from 1835 to 1841; was a member of Lord John Russell's cabinet in 1851; and first lord of the admiralty from 1859 to 1866. In 1863 he was created Earl St Maur of Berry Pomeroy. He refused to join W. E. Gladstone's ministry in 1868, but he gave independent support to the chief measures of the government. He died in November 1885. In 1830, while still Lord Seymour, he married Jane Georgiana, youngest of the three celebrated daughters of Thomas Sheridan, who was the "Queen of Beauty" at the famous Eglinton Tournament in 1839. The duke was the author of *Christian Theology and Modern Scepticism* (1872), and *Monarchy and Democracy* (1880). As his two sons both died unmarried in his lifetime, the family titles, except the earldom of St Maur, which became extinct, devolved on his two brothers successively; the younger of whom, Algernon Percy Banks, 14th duke (1813-1894), was succeeded by his son Algernon (b. 1846) as 15th duke of Somerset.

The title of Earl St Maur adopted by the 12th duke in 1863 is said to have been the original form of the family name of which Seymour was a later corruption, and since the last-mentioned date it has been assumed as the family surname of the dukes of Somerset.

See SEYMOUR, or ST MAUR, and the authorities there cited.

(R. J. M.)

SOMERSET, EDMUND BEAUFORT, DUKE OF (c. 1404-1455), was the younger son of John, earl of Somerset, and grandson of John of Gaunt, duke of Lancaster. He was taken prisoner at Baugé in 1421 during his first campaign, and did not return to England till 1431. He was then styled earl of Mortain, and in 1432 was one of the envoys to the council of Basel. In 1436 he served at the relief of Calais, two years later he commanded with some success in Maine, and in 1440 recovered Harfleur. Next year he was made earl, and in 1443 marquess of Dorset. In 1444 on the death of his elder brother he became duke of Somerset. As head of the Beaufort party he was the rival of

Richard of York, whom in 1446 he superseded as lieutenant of France. He lacked statesmanship, and as a general could do nothing to stop French successes. The loss of Rouen and Normandy during the next four years was precipitated by his incompetence, and his failure naturally made him a special object of Yorkist censure. The fall of Suffolk left Somerset the chief of the king's ministers, and the Commons in vain petitioned for his removal in January 1451. In spite of York's active hostility he maintained his position till Henry's illness brought his rival the protectorate in March 1454. For a year he was kept a prisoner in the Tower "without any lawful process." On the king's recovery he was honourably discharged, and restored to his office as captain of Calais. Mistrust of Somerset was York's excuse for taking up arms. The rivalry of the two leaders was ended by the defeat of the Lancastrians and death of Somerset at St Albans on the 22nd of May 1455. Though loyal to his family, Somerset was without capacity as a leader. It was a misfortune for Henry VI. that circumstances should have made so weak a man his chief minister. Thomas Basin, the French chronicler, describes Somerset as a handsome, courteous and kindly man. By his wife, Eleanor, daughter and co-heiress of Richard Beauchamp, earl of Warwick, he had two sons, Henry and Edmund, who were executed by Edward IV. after the battles of Hexham and Tewkesbury.

For further information see Sir James Ramsay's *Lancaster and York* (Oxford, 1892), and C. Oman's *Political History of England, 1377-1485* (1906), with authorities there cited. (C. L. K.)

SOMERSET, EDWARD SEYMOUR, DUKE OF (c. 1506-1552), protector of England, born about 1506, was the eldest surviving son of Sir John Seymour of Wolf Hall, Wiltshire, by his wife Margaret, eldest daughter of Sir Henry Wentworth of Nettledsted, Suffolk. The Seymours claimed descent from a companion of William the Conqueror, who took his name from St Maur-sur-Loire in Touraine; and the protector's mother was really descended from Edward III. His father was knighted by Henry VII. for his services against the Cornish rebels at Blackheath in 1497, was present at the two interviews between Henry VIII. and Francis I. in 1520 and 1532, and died on the 21st of December 1536. Edward was "enfant d'honneur" to Mary Tudor at her marriage with Louis XII. in 1514, served in Suffolk's campaign in France in 1523, being knighted by the duke at Roze on the 1st of November, and accompanied Wolsey on his embassy to France in 1527. Appointed esquire of the body to Henry VIII. in 1529, he grew in favour with the king, who visited his manor at Elvetham in Hampshire in October 1535. On the 5th of June 1536, a week after his sister Jane's marriage to Henry, he was created Viscount Beauchamp of Hache in Somerset, and a fortnight after Edward VI.'s birth in October 1537, he was raised to the earldom of Hertford.

Queen Jane's death was a blow to his prospects, and in 1538 he was described as being "young and wise" but of "small power." He continued, however, to rise in political importance. In 1541, during Henry's absence in the north, Hertford, Cranmer and Audley had the chief management of affairs in London; in September 1542 he was appointed warden of the Scottish marches, and a few months later lord high admiral, a post which he almost immediately relinquished in favour of the future duke of Northumberland (*q.v.*). In March 1544 he was made lieutenant-general of the north and instructed to punish the Scots for their repudiation of the treaty of marriage between Prince Edward and the infant Mary Queen of Scots. He landed at Leith in May, captured and pillaged Edinburgh, and returned a month later. In July he was appointed lieutenant of the realm under the queen regent during Henry's absence at Boulogne, but in August he joined the king and was present at the surrender of the town. In the autumn he was one of the commissioners sent to Flanders to keep Charles V. to the terms of his treaty with England, and in January 1545 he was placed in command at Boulogne, where on the 26th he brilliantly repelled an attempt of Marshal de Biez to recapture the town. In May he was once more appointed lieutenant-general in the north to avenge the Scottish victory at Ancrum Moor; this he did by a savage foray

into Scotland in September. In March 1546 he was sent back to Boulogne to supersede Surrey, whose command had not been a success; and in June he was engaged in negotiations for peace with France and for the delimitation of the English conquests. From October to the end of Henry's reign he was in attendance on the king, engaged in that unrecorded struggle for predominance which was to determine the complexion of the government during the coming minority. Personal, political and religious rivalry separated him and Lisle from the Howards, and Surrey's hasty temper precipitated his own and his father's ruin. They could not acquiesce in the Imperial ambassador's verdict that Hertford and Lisle were the only noblemen of fit age and capacity to carry on the government; and Surrey's attempt to secure the predominance of his family led to his own execution and to his father's imprisonment in the Tower.

Their overthrow had barely been accomplished when Henry VIII. died on the 28th of January 1547. Preparations had already been made for a further advance in the ecclesiastical reformation and for a renewal of the design upon Scotland; and the new government to some extent proceeded on the lines which Chapuys anticipated that Henry VIII. would have followed had he lived. He had no statutory power to appoint a protector, but in the council of regency which he nominated Hertford and Lisle enjoyed a decisive preponderance; and the council at its first meeting after Henry's death determined to follow precedent and appoint a protector. Hertford was their only possible choice; he represented the predominant party, he was Edward VI.'s nearest relative, he was senior to Lisle in the peerage and superior to him in experience. Seven weeks later, however, after Lord-Chancellor Wriothesley, the leading Catholic, had been deprived of office Hertford, who had been made duke of Somerset, succeeded in emancipating himself from the trammels originally imposed on him as protector; and he became king in everything but name and prestige.

His ideas were in striking contrast with those of most Tudor statesmen, and he used his authority to divest the government of that apparatus of absolutism which Thomas Cromwell had perfected. He had generous popular sympathies and was by nature averse from coercion. "What is the matter, then?" wrote Paget in the midst of the commotions of 1549, "By my faith, sir, . . . liberty, liberty. And your grace would have too much gentleness." In his first parliament, which met in November 1547, he procured the repeal of all the heresy laws and nearly all the treason laws passed since Edward III. Even with regard to Scotland he had protested against his instructions of 1544, and now ignored the claim to suzerainty which Henry VIII. had revived, seeking to win over the Scots by those promises of autonomy, free trade, and equal privileges with England, which many years later eventually reconciled them to union. But the Scots were not thus to be won in 1547: "What would you say," asked one, "if your lad were a lass, and our lass were a lad?" and Scottish sentiment backed by Roman Catholic influence and by French intrigues, money and men, proved too strong for Somerset's amiable invitations. The Scots turned a deaf ear to his persuasions; the protector led another army into Scotland in September 1547, and won the battle of Pinkie (Sept. 10). He trusted to the garrisons he established throughout the Lowlands to wear down Scottish opposition; but their pressure was soon weakened by troubles in England and abroad, and Mary was transported to France to wed Francis II. in 1557.

Somerset apparently thought that the religious question could be settled by public discussion, and throughout 1547 and 1548 England went as it pleased so far as church services were concerned; all sorts of experiments were tried, and the country was involved in a grand theological debate, in which Protestant refugees from abroad hastened to join. The result convinced the protector that the government must prescribe one uniform order which all should be persuaded or constrained to obey; but the first Book of Common Prayer, which was imposed by the first Act of Uniformity in 1549, was a studious compromise between the new and the old learning, very different from the

aggressive Protestantism of the second book imposed after Somerset had been removed, in 1552. The Catholic risings in the west in 1549 added to Somerset's difficulties, but were not the cause of his fall. The factious and treasonable conduct of his brother, the lord high admiral, in whose execution (March 20, 1549) the protector weakly acquiesced, also impaired his authority; but the main cause of his ruin was the divergence between him and the majority of the council over the questions of constitutional liberty and enclosures of the commons. The majority scouted Somerset's notions of liberty and deeply resented his championship of the poor against greedy landlords and capitalists. His efforts to check enclosures by means of parliamentary legislation, royal proclamations, and commissions of inquiry were openly resisted or secretly foiled, and the popular revolts which their failure provoked cut the ground from Somerset's feet. He was divided in mind between his sympathy with the rebels and his duty to maintain law and order. France, which was bent on ruining the protector's schemes in Scotland and on recovering Boulogne, seized the opportunity to declare war on August the 8th; and the outlying forts in the Boulonnais fell into their hands, while the Scots captured Haddington.

These misfortunes gave a handle to Somerset's enemies. Warwick combined on the same temporary platform Catholics who resented the Book of Common Prayer, Protestants who thought Somerset's mildness paltering with God's truth, and the wealthy classes as a whole. In September he concerted measures with the ex-lord-chancellor Wriothesley; and in October, after a vain effort to rouse the masses in his favour, Somerset was deprived of the protectorate and sent to the Tower. But the hostile coalition broke up as soon as it had to frame a constructive policy; Warwick jockeyed the Catholics out of the council and prepared to advance along Protestant lines. He could hardly combine proscription of the Catholics with that of Somerset, and the duke was released in February 1550. For a time the rivals seemed to agree, and Warwick's son married Somerset's daughter. But growing discontent with Warwick made Somerset too dangerous. In October 1551, after Warwick had been created duke of Northumberland, Somerset was sent to the Tower on an exaggerated charge of treason, which broke down at his trial. He was, however, as a sort of compromise, condemned on a charge of felony for having sought to effect a change of government. Few expected that the sentence would be carried out, and apparently Northumberland found it necessary to forge an instruction from Edward VI. to that effect. Somerset was executed on the 22nd of January 1552, dying with exemplary patience and fortitude. His eldest son by his second wife was re-created earl of Hertford by Elizabeth, and his great-grandson William was restored as 2nd duke of Somerset in 1660. His children by his first wife had been disinherited owing to the jealousy of his second; but their descendants came into the titles and property when the younger line died out in 1750.

See A. F. Pollard's *England Under Protector Somerset* (1900; full bibliography, pp. 327-339), also his article in *Dict. Nat. Biog.* and vol. vi. of *Political History of England* (1910). (A. F. P.)

SOMERSET, ROBERT CARR (OR KER), EARL OF (c. 1590-1645), Scottish politician, the date of whose birth is unrecorded, was a younger son of Sir Thomas Ker of Ferniehurst by his second wife, Janet, sister of Sir Walter Scott of Buccleuch. He accompanied James I. as page to England, but being then discharged from the royal service, sought for a time to make his fortune in France. Returning to England he happened to break his arm at a tilting match, at which James was present, and was recognized by the king. Entirely devoid of all high intellectual qualities, Carr was endowed with good looks, excellent spirits, and considerable personal accomplishments. These advantages were sufficient for James, who knighted the young man and at once took him into favour. In 1607 an opportunity enabled the king to confer upon him a more substantial mark of his affection. Sir W. Raleigh had through his attainder forfeited his life-interest in the manor of Sherborne, but he had previously executed a conveyance by which the property was to pass on his death to his

eldest son. This document was, unfortunately, rendered worthless by a flaw which gave the king eventual possession of the property. Acting on Salisbury's suggestion, James resolved to confer the manor on Carr. The case was argued at law, and judgment was in 1609 given for the Crown. Lady Raleigh received some compensation, apparently inadequate, and Carr at once entered on possession. His influence was already such that in 1610 he persuaded the king to dissolve the parliament, which had shown signs of attacking the Scottish favourites. On the 25th of March 1611 he was created Viscount Rochester, and subsequently a privy councillor, while on Lord Salisbury's death in 1612 he began to act as the king's secretary. On the 3rd of November 1613 he was advanced to the earldom of Somerset, on the 23rd of December was appointed treasurer of Scotland, and in 1614 lord chamberlain. He supported the earl of Northampton and the Spanish party in opposition to the old tried advisers of the king, such as Lord-Chancellor Ellesmere, who were endeavouring to maintain the union with the Protestants abroad, and who now in 1614 pushed forward another candidate for the king's favour. Somerset, whose head was turned by the sudden rise to power and influence, became jealous and peevish, and feeling his position insecure, obtained in 1615 from the king a full pardon, to which, however, the chancellor refused to put the Great Seal. He still, however, retained the king's favour, and might possibly have remained in power for some time longer but for the discovery of the murder of Sir Thomas Overbury. Before 1609, while still only Sir Robert Carr, Somerset had begun an intrigue with Lady Essex. Supported by the king, the latter obtained a decree of nullity of marriage against Lord Essex in September 1613, and in December she married the earl of Somerset. Ten days before the court gave judgment, Sir Thomas Overbury, who apparently knew facts concerning Lady Essex which would have been fatal to her success, and had been imprisoned in the Tower, was poisoned. No idea seems to have been entertained at the time that Lady Essex and her future husband were implicated. The crime, however, was not disclosed till September 1615. Coke and Bacon were set to unravel the plot. After four of the principal agents had been convicted and punished, the earl and countess were brought to trial. The latter confessed, and of her guilt there can be no doubt. Somerset's share is far more difficult to discover, and probably will never be fully known. The evidence against him rested on mere presumption, and he consistently declared himself innocent. Probabilities are on the whole in favour of the hypothesis that he was not more than an accessory after the fact. James, who had been threatened by Somerset with damaging disclosures, let matters take their course, and both earl and countess were found guilty. The sentence was not carried into effect against either culprit. The countess was pardoned immediately, but both remained in the Tower till January 1622. The earl appears to have refused to buy forgiveness by concessions, and it was not till 1624 that he obtained his pardon. He only once more emerged into public view when in 1630 he was prosecuted in the Star Chamber for communicating a paper of Sir Robert Dudley's to the earl of Clare, recommending the establishment of arbitrary government. He died in July 1645, leaving one daughter, Anne, the sole issue of his ill-fated marriage, afterwards wife of the 1st duke of Bedford.

See the article by S. R. Gardiner in *Dict. Nat. Biog.*, with authorities there cited, and the same author's *History of England*; *State Trials II.*; *Life and Letters of Bacon*, ed. by Spedding; *Studies in Eng. Hist.*, by Gairdner and Spedding.

SOMERSET, LORD ROBERT EDWARD HENRY (1776-1842), British soldier, was the third son of the 5th duke of Beaufort, and elder brother of Lord Raglan. Joining the 15th Light Dragoons in 1793, he became captain in the following year, and received a majority after serving as aide-de-camp to the duke of York in the Dutch expedition of 1799. At the end of 1800 he became a lieutenant-colonel, and in 1801 received the command of the 4th Light Dragoons. From 1799 to 1802 he represented the Monmouth boroughs in the House of Commons, and from 1803 to 1823 sat for Gloucestershire. He commanded his regiment at the battles of Talavera and Busaco, and in 1810

received a colonelcy and the appointment of A.D.C. to the king. In 1811, along with the 3rd Dragoon Guards, the 4th Light Dragoons fought a notable cavalry action at Usagre, and in 1812 Lord Edward Somerset was engaged in the great charge of Le Marchant's heavy cavalry at Salamanca. His conduct on this occasion (he captured five guns at the head of a single squadron) won him further promotion, and he made the remaining campaigns as a major-general at the head of the Hussar brigade (7th, 10th and 15th Hussars). At Orthes he won further distinction by his pursuit of the enemy; he was made K.C.B., and received the thanks of parliament. At Waterloo he was in command of the Household Cavalry Brigade, which distinguished itself not less by its stern and patient endurance of the enemy's fire than by its celebrated charge on the cuirassiers of Milhaud's corps. The brigadier was particularly mentioned in Wellington's despatches, and received the thanks of parliament as well as the Maria Theresa and other much-prized foreign orders. He died a general and G.C.B. in 1842.

SOMERSETSHIRE, a south-western county of England, bounded N. and N.W. by the Bristol Channel, N. and N.E. by Gloucestershire, N.E. and E. by Wiltshire, S.E. by Dorsetshire, S.W. and W. by Devonshire. The area is 1630.3 sq. m. In shape the county resembles an ill-drawn crescent, curving inward where Bridgwater Bay bends south-west and broader at its eastern than at its western horn. It falls into three natural divisions, being in fact a broad alluvial plain bordered by two hill-regions. The Mendip range, breaking off from the high ground near Wiltshire, extends north-west towards the channel, where it ends with Brean Down; while the island of Steep Holm stands as an outpost between the heights of Somerset and Glamorgan. The summit of the Mendips is a long table-land, reaching an extreme height, towards the western end, of 1068 ft. in Black Down, sloping away gently towards the lower hills of the north, but rising on the south in an abrupt line, broken by many coombes or glens; the most striking of which are the cliffs of Ebbor Rocks, near Wells, and the gorge of Cheddar (*q.v.*), which winds for nearly a mile between huge and fantastic rocks. South of the Mendips lies a broad plain watered by the Parrett and the Brue, and known generally as Sedgemoor, but with different names in different parts. This plain, intersected by ditches known as *rhines*, and in some parts rich in peat, is broken by isolated hills and lower ridges, of which the most conspicuous are Brent Knoll near Burnham, the Isle of Avalon, rising with Glastonbury Tor as its highest point, and the long low ridge of Polden ending to the west in a steep bluff. West of Sedgemoor the second great region of hills extends from Devonshire to the sea. It consists of the Black Down, Brendon and Quantock hills, with Exmoor Forest (*q.v.*) in the extreme west. This entire district is famous for the grandeur of its bare and desolate moors, and the bold outlines and height of its mountains; the chief of which are Dunkery, in Exmoor (1707 ft.); Lype Hill, the westernmost point of the Brendon range (1391 ft.); and Will's Neck, among the Quantocks (1261 ft.). The two principal rivers of Somerset are the Avon and the Parrett. The Avon, after forming for a short distance the boundary with Wiltshire, crosses the north-eastern corner of the county, encircling Bath, and forms the boundary with Gloucestershire till it reaches the sea 6 m. beyond Bristol. It is navigable for barges as far as Bath. The Parrett from South Perrott in Dorset, on the borders of Somerset, crosses the centre of the county north-westwards by Bridgwater, receiving the Yeo and Cary on the right, and the Isle and Tone on the left. Among other streams are the Axe, which rises at Wookey Hole in the Mendips and flows north-westward along their base to the Bristol Channel near Blackrock; the Brue, which rises to the east of Bruton, near the borders of Wiltshire, and enters the Bristol Channel near the mouth of the Parrett; and the Exe (with its tributary the Barle), which rises in Exmoor forest and passes southward into Devon. Some of the Somersetshire streams, especially the Exe and Barle, are in high favour with trout fishermen. Weston-super-Mare is a flourishing seaside resort, and Minehead and other coast villages are also frequented.

Geology.—The oldest formation in the county is the Devonian, which extends eastwards from Devonshire across Exmoor to the Brendon and Quantock hills, and consists of sandstones, slates and limestones of marine origin. The Old Red Sandstone, the supposed estuarine or lacustrine equivalent of the Devonian, is a series of red sandstones, marls and conglomerates, which rise as an anticline in the Mendips (where they contain volcanic rocks), and also appear in the Avon gorge and at Portishead. The Carboniferous Limestone, of marine origin, is well displayed in the Mendip country (Cheddar Cliffs, &c.) and in the Avon gorge; at Weston-super-Mare it contains volcanic rocks. The Coal Measures of the Radstock district (largely concealed by Trias and newer rocks) consist of two series of coal-bearing sandstones and shales separated by the Pennant Sandstone; locally the beds have been intensely folded and faulted, as at Vobster. Indeed, all the formations hitherto mentioned were folded into anticlines and synclines before the deposition of the Triassic rocks. These consist of red marls, sandstones, breccias and conglomerates, which spread irregularly over the edges of the older rocks; the so-called Dolomitic Conglomerate is an old shingle-beach of Triassic (Keuper Marl) age. The Rhaetic beds are full of fossils and mark the first invasion of the district by the waters of the Jurassic sea. The Lias consists of clays and limestones; the latter are quarried and are famous for their ammonites and reptilian remains. Above the Lias comes the Lower or Bath Oolite Series (Inferior Oolite group, Fuller's Earth and Great Oolite group), chiefly clays and oolitic limestone; the famous Bath Stone is got from the Great Oolite. The Oxford Clay is the chief member of the Middle or Oxford Oolite Series. Above these follow the Upper Cretaceous rocks, including the Gault, Upper Greensand and Chalk, which extend into the county from Wiltshire near Frome and from Dorset near Chard. There are apparently no true glacial deposits. Low-lying alluvial flats and peat-bogs occupy much of the surface west of Glastonbury. Caves in the Carboniferous Limestone (e.g. Wookey Hole, near Wells) have yielded Pleistocene mammalia and palaeolithic implements. The thermal waters of Bath (120° F.) are rich in calcium and sodium sulphates, &c. The chief minerals are coal, freestone and limestone, and ores of lead, zinc and iron.

Agriculture.—The climate partakes of the mildness of the south-western counties generally. A high proportion, exceeding four-fifths of the total area of the county, is under cultivation. In a county where cattle-feeding and dairy-farming are the principal branches of husbandry, a very large area is naturally devoted to pasture; and there are large tracts of rich meadow land along the rivers, where many of the Devonshire farmers place their herds to graze. Floods, however, are common, and the Somerset Drainage Act was passed by parliament on the 11th of June 1877, providing for the appointment of commissioners to take measures for the drainage of lands in the valleys of the Parrett, Isle, Yeo, Brue, Axe, Cary and Tone. Cheese is made in various parts, notably the famous Cheddar Cheese, which is made in the farms lying south of the Mendips. Sheep-farming is practised both in the lowlands and on hill pastures, Leicesters and Southdowns being the favourite breeds. In the Vale of Taunton heavy crops of wheat are raised; this grain, barley and oats being raised on about equal areas. Turnips, swedes and mangolds occupy most of the area under green crops. Somerset ranks after Devon and Hereford in the extent of its apple orchards, and the cider made from these apples forms the common drink of the peasantry, besides being largely exported. Wild deer are still found on Exmoor, where there is a peculiar breed of ponies, hardy and small. The Bristol Channel and Bridgwater Bay abound in white- and shell-fish; salmon and herring are also caught, the principal fishing stations being Porlock, Minehead and Watchet.

Other Industries.—Coal, from the Mendips, and freestone, largely quarried near Bath, are the chief mineral products of Somerset, although brown ironstone, zinc, limestone and small quantities of slate, gravel, sand, sulphate of strontia, gypsum, ochre, Fuller's earth, marl, cement, copper and manganese are also found. Lead mining is carried on near Wellington, and lead washing in the Mendips; but these industries, like the working of spathose iron ore among the Brendon hills, are on the wane. The chief manufactures are those of woollen and worsted goods, made in a large number of towns; silk made at Frome, Taunton and Shepton Mallet; gloves at Yeovil, Stoke, Martock and Taunton; lace at Chard; linen and sailcloth at Crewkerne; horsehair goods at Bruton, Castle Cary and Crewkerne; crape at Dulverton and Shepton Mallet. Tobacco, snuff and spirits are also manufactured; and there are large potteries at Bridgwater, where the celebrated bath-brick is made, and at Weston-super-Mare; carriage works at Bath and Bridgwater; engineering and machine-works also at Bridgwater. On the Avon, copper and iron are smelted, while several other rivers provide power for cotton, worsted and paper mills. The bulk of the export trade passes through Bristol, which is situated mainly in Gloucestershire, though it has large docks on the Somerset side of the Avon, and others at Portishead.

Communication.—Somerset is well furnished with railways. The Great Western runs between Frome, Radstock, Bath and Bristol, and from Bristol it curves south-west through Weston and Bridgwater to Taunton, dividing there and passing on into Devon.

Branches leave the main line for Portishead, Clevedon and Minehead on the north, and for Witham Friary via Wells, Yeovil via Langport, and Chard via Ilminster on the south. The South-Western main line from London passes through the south-west of Somerset, running from Templecombe to Axminster in Devon, and the Somerset and Dorset runs from Bath to Shepton Mallet via Radstock. The Kennet and Avon Canal flows from Bradford in Wiltshire to Bath, and there joins the Avon, meeting on its way the two branches of the Somersetshire Coal Canal which flow from Paulton and Radstock. The Taunton and Bridgwater Canal flows into the River Parrett.

Population and Administration.—The area of the ancient county is 1,043,409 acres, with a population in 1891 of 484,337, and in 1901 of 508,256. The area of the administrative county is 1,037,484 acres. The county contains 40 hundreds and two liberties. The municipal boroughs are—Bath, a city and county borough (pop. 49,839), Bridgwater (15,209), Chard (4437), Glastonbury (4016), Taunton (21,087), Wells, a city (4849), Yeovil (9861). The urban districts are—Burnham (2897), Clevedon (5900), Crewkerne (4226), Frome (11,057), Highbridge (2233), Ilminster (2287), Midsomer Norton (5809), Minehead (2511), Portishead (2544), Radstock (3355), Shepton Mallet (5238), Street (4018), Watchet (1880), Wellington (7283), Weston-super-Mare (19,845), Wiveliscombe (1417). Among other towns may be mentioned Bruton (1788), Castle Cary (1902), Cheddar (1975), Keynsham (3512) and Wincanton (1892). The county is in the western circuit, and assizes are held at Taunton and Wells. It has one court of quarter sessions, and is divided into 22 petty sessional divisions. The boroughs of Bath and Bridgwater have separate courts of quarter sessions and commissions of the peace, and those of Taunton, Wells and Yeovil have separate commissions of the peace. The total number of civil parishes is 485. Somerset is in the diocese of Bath and Wells, excepting small parts in the dioceses of Bristol and Salisbury; it contains 508 ecclesiastical parishes or districts, wholly or in part. There are seven parliamentary divisions—Northern, Wells, Frome, Eastern, Southern, Bridgwater and Western or Wellington, each returning one member; while the parliamentary borough of Bath returns two members, and that of Taunton one member; and the county includes the greater part of the southern division of the parliamentary borough of Bristol.

History.—In the 6th century Somerset was the debatable borderland between the Welsh and Saxons, the latter of whom pushed their way slowly westward, fighting battles yearly and raising fortifications at important points to secure their conquered lands. Their frontier was gradually advanced from the Axe to the Parrett, and from the Parrett to the Tamar, Taunton being a border fort at one stage and Exeter at another. By 658 Somerset had been conquered by the West Saxons as far as the Parrett, and there followed a struggle between the kingdoms of Wessex and Mercia, decided by a great victory of Ine in 710, which led to the organization of the lands east of the Parrett as part of the kingdom of Wessex. There were still occasional inroads by the Welsh, Taunton Castle being captured in 721, but from the 8th century the West Saxon kings were rulers of what is now known as Somersetshire. About this time the bishopric of Wells was founded, and the monastery of Glastonbury restored by Ine. The next hundred and fifty years were the period of Danish invasions. Egbert, king of Wessex, became Bretwalda or overlord of all England in 827, and under him Wessex with the other frontier kingdoms was organized for defence against the Danes, and later the assessment of danegeld led to the subdivision of Wessex for financial and military purposes, which crystallized into the divisions of hundreds and tithings, probably with the system of assessment by hidation. King Alfred's victory in 878, followed by the Peace of Wedmore, ended the incursions of the Danes for a time, but a hundred years later they were again a great danger, and made frequent raids on the west coast of Somerset. At some time before the Conquest, at a date usually given as 1016, though evidence points to a much earlier and more gradual establishment, England was divided into shires, one of which was Somerset, and tradition gives the name of the first earl as Hun, who was followed by Earnulf and Sweyn, son of Godwin. There has been curiously little variation in the territory

included in the county, from the date of the Gheld Inquest in 1084 to the second half of the 19th century, when certain minor alterations were made in the county boundary. These have been practically the only changes in the county boundary for 900 years, if we except the exclusion of Bristol from the county jurisdiction in 1373.

At the Conquest Somerset was divided into about 700 fiefs held almost entirely by the Normans. The king's lands in Somerset were of great extent and importance, and consisted in addition to the ancient demesne of the Crown of the lands of Godwin and Earl Harold and the estates of Queen Edith who died in 1074. The bishop of Winchester owned a vast property of which Taunton was the centre, and about one-tenth of the county was included in the estates of the bishop of Coutances, which were akin to a lay barony and did not descend as a whole at the bishop's death. The churches of Glastonbury, Athelney and Muchelney still owned vast lands, but Norman spoliation had deprived them of much that they had held before the Conquest. Among the great lay tenants who divided the conquered lands were the count of Mortain (the Conqueror's half-brother), Roger de Corcelles, Walter de Douai, Roger Arundel and William de Mohun. About this time or a little later many Norman castles were built, some of which have survived. The castles at Richmond (near West Harptree), Nunney, Farleigh, Bridgwater, Stoke Courcy, Taunton and Dunster were probably the most important. Somerset was very rich in boroughs at the time of Domesday, which points to a considerable development of trade before the Conquest; Bath, Taunton, Ilchester, Frome, Milborne Port, Bruton, Langport and Axbridge were all boroughs in 1087, and there was the nucleus of a borough at Yeovil. Somerton, Ilchester and Taunton were successively the meeting-places of the shire court. There were joint sheriffs for Somerset and Dorset until 1566 when a separate sheriff for each county was appointed. In the 7th century Somerset, as part of the kingdom of Wessex, was included in the diocese of Winchester. The new bishopric of Sherborne, founded in 704, contained Somerset until 910 when the see was divided into the dioceses of Salisbury, Exeter and Wells, the latter including the whole county of Somerset. The diocese was divided into three archdeaconries, Bath with two deaneries, Wells with seven and Taunton with four. Disputes between the chapters of Bath and Wells as to the election of the bishop led to a compromise in 1245, the election being by the chapters jointly, and the see being known as the bishopric of Bath and Wells. There has always been a strongly marked division of the county into East and West Somerset, a relic of the struggles between the Welsh and Saxons, which was recognized for parliamentary purposes by the act of 1832. Somerset contained 37 hundreds in 1087, and now contains 41. There have been considerable modifications of these hundredal divisions by aggregation or subdivision, but since the 15th century there has been little change. The meeting-place of the hundred courts was at the village or town which gave its name to the hundred in the cases of Bruton, Cannington, Carhampton, Chew, Chewton, Crewkerne, Frome, Glaston Twelve Hides, Huntspill, Kilmersdon, Kingsbury East, Milverton, North Curry, North Petherton, Norton Ferris, Pitney, Portbury, Somerton, South Petherton, Taunton, Tintinhull, Wellow, Wells Forum and Winterstoke. The hundred of Abdick and Bulstone met at Ilford Bridges in Stocklinch Magdalen, Andersfield hundred court was held at the hamlet of Andersfield in the parish of Goathurst, Bath Forum hundred met at Wedcombe, Bempstone at a huge stone in the parish of Allerton, Brent and Wrington at South Brent, Catsash at an ash tree on the road between Castle Cary and Yeovil, Hartcliffe and Bedminster at a lofty cliff between the parishes of Barrow Gurnes and Winford, Horethorne or Horethorne Down near Milborne Port, Whitstone at a hill of the same name near Shepton Mallet, Williton and Freemanors in the village of Williton in the parish of St Decumans, and Whitley at Whitley Wood in Walton parish. In the case of Kingsbury the meeting-place of the hundred is not known. The great liberties of the county were Cranmore, Wells and Leigh, which belonged to the abbey of

Glastonbury; Easton and Amrill and Hampton and Claverton, which were the liberties of the abbey of Bath; Hinton and Norton, which belonged to the Carthusian priory of Hinton; Witham Priory, a liberty of the house of that name; and Williton Freemanor, which belonged for a time to the Knights Templars.

The chief families of the county in the middle ages were those of De Mohun, Malet, Revel, De Courcy, Montacute, Beauchamp and Beaufort, which bore the titles of earls or dukes of Somerset from 1396 to 1472. Edward Seymour was made duke of Somerset in 1547, and in 1660 the title was restored to the Seymour family, by whom it is still held. The marquess of Bath is the representative of the Thynne family, which has long been settled in the county, and the predecessors of the earl of Lovelace have owned land in Somerset for three centuries. Hinton St George has been the seat of the Poulet family since the 16th century. The De Mohun family were succeeded in the 14th century by the Luttrells, who own great estates round Dunster Castle. The families of Hood, Wyndham, Acland, Strachey, Brokeley, Portman, Hobhouse and Trevelyan have been settled in Somerset since the 16th century.

Somerset was too distant and isolated to take much share in the early baronial rebellions or the Wars of the Roses, and was really without political history until the end of the middle ages. The attempt of Perkin Warbeck in 1497 received some support in the county, and in 1547 and 1549 there were rebellions against enclosures. Somerset took a considerable part in the Civil War, and with the exception of Taunton, was royalist, all the strongholds being garrisoned and held for the king. Waller was defeated at Landsdown near Bath in 1643, and Goring at the battle of Allermoor in 1645. This defeat was followed by the capture of the castles held by the royalists. Bridgwater and Bath fell in July 1645, Sherborne Castle was taken in August, and after the capture of Nunney, Farleigh and Bristol in September 1645 the whole county was subdued, and very heavy fines were inflicted upon the royalists, who included nearly all the great landowners of the county. Somerset was the theatre of Monmouth's rebellion, and he was proclaimed king at Taunton in 1685. The battle of Sedgemoor on the 4th of July was followed in the autumn by the Bloody Assize held by Judge Jeffreys.

Somerset has always been an agricultural county. Grain was grown and exported from the 11th to the end of the 18th century. Cider-making has been carried on for centuries. Among other early industries, salmon and herring fisheries on the west coast were very profitable, and mining on the Mendips dated from the pre-Roman period. Stone quarrying at Hambdon Hill and Bath began very early in the history of the county; and the lead mines at Wellington and the slate quarries at Wiveliscombe and Treborough have been worked for more than a century. Coal has been mined at Radstock from a very remote date, but it did not become of great importance commercially until the county was opened up by canals and railways in the 19th century. Sheep-farming was largely carried on after the period of enclosures, and the woollen trade flourished in Frome, Bath, Bridgwater, Taunton and many other towns from the 14th to the 19th centuries. Glove-making was centred at Stoke and Yeovil at the end of the 18th century and became an important subsidiary occupation in many country districts. The county was represented in the parliament of 1290 and probably in the earlier parliamentary councils of Henry III. In 1295 it was represented by two knights, and twelve boroughs returned two burgesses each. There have been many fluctuations in the borough representation, but the county continued to return two members until 1832, when it was divided into Somerset East and Somerset West, each of which divisions returned two members. Two additional members were returned after 1867 for a third—the Mid-Somerset—division of the county, until by the act of 1885 the whole county was divided into seven divisions.

Antiquities.—The great possessions of the bishopric and of the abbey of Glastonbury led to a remarkable lack of castles in the mid part of the county, and also tended to overshadow all other ecclesiastical foundations. Even in the other parts of the county castles are not a prominent feature, and no monastic churches remain perfect except those of Bath and its cell, Dunster. At the dissolution of monasteries Bath was suppressed, the monastery of Glastonbury was destroyed, as were most of the smaller monasteries also. Of those which have left any remains, Woodspring, Montacute (Cluniac) and Old Cleeve (Cistercian)

are the most remarkable. Athelney, founded by Alfred on the spot where he found shelter, has utterly perished. Montacute and Dunster fill a place in both ecclesiastical and military history. The castle of Robert of Mortain, the Conqueror's brother, was built on the peaked hill (*mons acutus*) of Leodgaresburh, where the holy cross of Waltham was found. The priory arose at the foot. Dunster, one of the few inhabited castles in England, stands on a hill crowned by an English mound. Besides these there are also remains at Nunney and Castle Cary. In ecclesiastical architecture the two great churches of Wells and Glastonbury supply a great study of the development of the Early English style out of the Norman. But the individual architectural interest of the county lies in its great parish churches, chiefly in the Perpendicular style, which are especially noted for their magnificent towers. They are so numerous that it is not easy to select examples, but besides those at Bath, Taunton and Glastonbury, the churches at Bridgwater, Cheddar, Crewkerne, Dunster, Ilminster, Kingsbury, Leigh-on-Mendip, Martock and Yeovil may be specially indicated. Of earlier work there is little Norman, and hardly any pre-Conquest, but there is a characteristic local style in some of the smaller buildings of the 14th century. The earlier churches were often cruciform, and sometimes with side towers. In domestic remains no district is richer, owing to the abundance of good stone. Clevedon Court is a very fine inhabited manor-house of the 14th century, and the houses, great and small, of the 15th, 16th and 17th centuries are very numerous. Indeed, the style has never quite gone out, as the gable and the mullioned window have lingered on to this day. Barrington Court in the 16th century and Montacute House in the 17th are specially fine examples. There are also some very fine barns, as at Glastonbury, Wells and Pilton.

See J. Collinson, *History and Antiquities of the County of Somerset* (Bath, 1791); W. Phelps, *History and Antiquities of Somerset* (London, 1839); R. W. Eyton, *Domesday Studies: Analysis of the Somerset Survey* (London, 1880); F. T. Elworthy, *West Somerset Word-Book* (Dialect Society, London, 1886); Roger, *Myths and Worthies of Somerset* (London, 1887); C. R. B. Barrett, *Somerset Highways, Byways and Waterways* (London, 1894); C. Walters, *Bygone Somerset* (London, 1897); *Victoria County History: Somerset*; also various publications by the Somerset Record Society, the *Proceedings of the Somerset Archaeological and Natural History Society*, and *Somerset Notes and Queries*.

SOMERSWORTH, a city of Strafford county, New Hampshire, U.S.A., on the Salmon Falls river, 5 m. N. of Dover, and opposite the town of Berwick, Maine, industrially a part of Somersworth. Pop. (1890) 6207; (1900) 7023 (3166 foreign-born); (1910) 6704. Somersworth is served by the Boston & Maine railroad, and is connected by electric line with Rochester and Dover. The river furnishes good water power, and the city's chief interests are in the manufacture of cotton and woollen goods, and boots and shoes. It has a public library. In the southwest part is Central Park, lying along the shore of Willand's Pond. The municipality owns and operates the waterworks. A settlement was established here in the latter part of the 17th century, when the territory was a part of Dover. In 1729 the parish of Summersworth was organized; in 1754 this parish was erected into the town of Somersworth; in 1821 the first company was formed to develop the water-power and establish cotton and woollen mills; in 1849 the southern half of the town was set-off and incorporated as Rollinsford; and in 1893 Somersworth was chartered as a city.

See W. D. Knapp, *Somersworth, an Historical Sketch* (1894).

SOMERVILLE, WILLIAM (1675-1742), English poet, eldest son of a country gentleman, was born at Edstone, Worcestershire, on the 2nd of September 1675. He was educated at Winchester College and at New College, Oxford. After his father's death in 1705 he lived on his estate, devoting himself especially to field sports, which supplied the subjects of his best-known poems. His publications were *The Two Springs* (1725), a fable; *Occasional Poems*. . . (1727); *The Chase* (1735) *Hobbinol, or the Rural Games* (1740), a burlesque poem; and *Field Sports* (1742), a poem on hawking. Somerville died on the 19th of July 1742.

His *Chase* passed through many editions. It was illustrated by Bewick (1796), by Stothard (1800), and by Hugh Thomson (1896), with a preface by R. F. Sharp.

SOMERVILLE, MARY (1780-1872), British scientific writer, was the daughter of Admiral Sir William George Fairfax, and was born on the 26th of December 1780 in the manse of Jedburgh, the house of her mother's sister, wife of Dr Thomas Somerville (1741-1830), author of *My Own Life and Times*, whose son was her second husband. She received a rather desultory education, and mastered algebra and Euclid in secret after she had left school, and without any extraneous help. In 1804 she married her cousin, Captain Samuel Greig, who died in 1806; and in 1812 she married another cousin, Dr William Somerville (1771-1860), inspector of the army medical board, who encouraged and greatly aided her in the study of the physical sciences. After her marriage she made the acquaintance of the most eminent scientific men of the time, among whom her talents had attracted attention before she had acquired general fame, Laplace paying her the compliment of stating that she was the only woman who understood his works. Having been requested by Lord Brougham to translate for the Society for the Diffusion of Useful Knowledge the *Mécanique Céleste* of Laplace, she greatly popularized its form, and its publication in 1831, under the title of *The Mechanism of the Heavens*, at once made her famous. Her other works are the *Connexion of the Physical Sciences* (1834), *Physical Geography* (1848), and *Molecular and Microscopic Science* (1869). Much of the popularity of her writings was due to their clear and crisp style and the underlying enthusiasm for her subject which pervaded them. In 1835 she received a pension of £300 from government. She died at Naples on the 28th of November 1872. In the following year there appeared her *Personal Recollections*, consisting of reminiscences written during her old age, and of great interest both for what they reveal of her own character and life and the glimpses they afford of the literary and scientific society of bygone times.

SOMERVILLE, a city of Middlesex county, Massachusetts, U.S.A., on the Mystic river, adjoining Boston (Charlestown), Cambridge, Medford and Arlington. Pop. (1890), 40,152; (1900), 61,643, of whom 17,232 were foreign-born; (1910 census), 77,236. Of the foreign-born in 1900 6400 were English-Canadians, 5542 were Irish, 1321 were English, 610 were French-Canadians, 590 were Italians, 576 were Scotch and 556 were Swedish. Somerville is served by the Boston & Maine railroad and by suburban electric railway lines. It is a residential and manufacturing suburb of Boston, of which, industrially, it forms a part; it is included in the metropolitan water, sewer and park districts, and in the Boston postal district. It comprises an irregular (land) area of 4.06 sq. m. in the Mystic Valley and along a range of hills or ridges, of which the largest are Prospect, Spring, Winter, Central and Clarendon hills. Among its public buildings and institutions are a fine public library (1872) with 80,000 volumes in 1908, the city hall, a state armoury, Somerville Hospital, the city poor house, a Roman Catholic home for the aged, and two high schools (English and classical). Among the parks are Broadway Park, Central Hill Park, Prospect Hill Park, Lincoln Park, and Nathan Tufts Park. The total value of the city's factory product in 1905 was \$22,955,197, an increase of 14.4 per cent. over that of 1900; in 1890 the product value was only \$7,307,522. The establishments include slaughtering and meat-packing houses, whose product is by far the most valuable in the city, bleacheries, finishing factories, glassworks, machine shops, tube works, jewelry factories, and a desk factory. There are also lumber and coal yards. Blue slate-stone used for building purposes is quarried.

Somerville, originally a part of Charlestown, was settled in 1630. Six hundred acres, the "Ten Hills Farm," were granted here in 1631 to John Winthrop, who built and launched here in that year the "Blessing of the Bay," the first ship built in Massachusetts. For more than a century it was a sparsely settled farming community, the only article of manufacture

being bricks. On the 19th of April 1775 the British columns returning from Concord were harassed by the farmers here, as in the other towns along the line of march. Several of the hills of Somerville (e.g. Prospect and Central Hills) were fortified during the siege of Boston. On Prospect Hill on the 18th of July 1775 Israel Putnam raised the "Appeal to Heaven" flag, and here also is said to have been raised on the 1st of January 1776 one of the earliest of the Continental standards, the Union Jack and Stripes. On Powder House Hill (originally Quarry Hill), in Nathan Tufts Park, there still stands an interesting old slate-stone powder house, a circular building, 30 ft. high, with a conical cap, originally built (about 1703) for a windmill, deeded in 1747 to the Massachusetts Bay Colony, used in 1756-1822 as a powder house, and now marked by a bronze tablet erected by the Massachusetts Society of the Sons of the Revolution; on the 1st of September 1774, General Gage seized 250 half-barrels of powder stored here in anticipation of the outbreak of hostilities; in 1775 the powder house became the magazine of the American forces besieging Boston, and at that time Nathanael Greene maintained his headquarters at the Samuel Tufts House, and Charles Lee had his headquarters at the Oliver Tufts House, in Somerville. After the battle of Saratoga some of Burgoyne's officers were housed here. The opening of the Middlesex Canal through the town in 1803 and of the Boston & Lowell railroad in 1835 gave an impetus to the town's growth. In 1834 an Ursuline Convent, built in 1827 on Mt Benedict, was sacked and destroyed by an anti-Catholic mob. In 1842 Somerville was separated from Charlestown and incorporated under its present name; it was chartered as a city in 1871.

See T. H. Hurd, *History of Middlesex County* (3 vols., Philadelphia, 1890); S. A. Drake, *History of Middlesex County* (2 vols., Boston, 1880); E. A. Samuels, *Somerville Past and Present* (Boston, 1897); Miss M. A. Haley, *The Story of Somerville* (Boston, 1903).

SOMERVILLE, a borough and the county-seat of Somerset county, New Jersey, U.S.A., in the north central part of the state, on the Raritan river, about 36 m. S.W. of New York City. Pop. (1890), 3861; (1900), 4843, of whom 560 were foreign-born; (1905), 4782; (1910), 5069. It is served by the Central Railroad of New Jersey and by inter-urban electric lines. Adjoining the borough on the west is the town of Raritan (pop. in 1905, 3954). Places of interest in Somerville are the Old Parsonage of the Dutch Reformed Church, built in 1750-1751 of brick imported from Holland by the Rev. Theodorus Jacobus Frelinghuysen, the first pastor; the Wallace House, built in 1778 and occupied by General Washington as his headquarters during the following winter, when the main army was in camp at Bound Brook; and Duke's Park (partly in Raritan), the immense private estate (laid out as a park and open to the public) of James B. Duke, president of the American Tobacco Company. Somerville has a fine county court house (1909) of Alabama white marble. Among the borough's manufactures are stoves, ranges, soil pipe, brick, woollen goods and shirts. Settlements were made within the present limits of Somerville in the last quarter of the 17th century, and the village was at first called Raritan, all that part of the Raritan Valley from Bound Brook to the junction of the north and south branches of the river, and including the present Somerville and Raritan, then being popularly called "Raritans." The present name was adopted in 1801. Somerville became the county-seat in 1783, after the destruction of the court-house in what is now the borough of Millstone (in Hillsborough township, about 6 m. south of Somerville) on the 27th of October 1779 by British troops under Colonel John Graves Simcoe; it was incorporated as a town in 1863, and as a borough in 1909.

SOMME, a department of northern France, formed in 1790 of a large part of the province of Picardy (comprising Vermandois, Santerre, Amiénois, Ponthieu, Vimeu, and Marquenterre) and a small portion of Artois. Pop. (1906), 532,567. Area 2423 sq. m. It is bounded on the N. by Pas-de-Calais, E. by Aisne, S. by Oise, and S.W. by Seine-Inférieure, and its sea-coast extends 28 m. along the English Channel. Two streams flowing into the

Channel—the Authie on the north and the Bresle on the south-west—bound it in these directions. The surface consists of great rolling plains, generally well cultivated and very fertile. The highest point, about 700 ft. above the sea, lies in the south-west, not far from Aumale. From the mouth of the Authie to the Bay of the Somme the coast is lined with a belt of sand dunes about 2 m. broad, behind which is the Marquenterre, a tract of 50,000 acres reclaimed from the sea by means of dykes and traversed by drainage canals. The Bay of the Somme, obstructed by dangerous sandbanks, contains the three fishing ports of Crotoy, St Valery, which is also the chief commercial port, and Le Hourdel. Next come the shingle banks, behind which the low fields of Cayeux (25,000 acres) have been reclaimed; and then at the hamlet of Ault commence the chalk cliffs, which continue onwards into Normandy.

The river Somme rises to the N.N.E. of St Quentin in the department of Aisne, where it has a course of about 25 m.; it traverses the department of Somme from the south-east to the north-west for a distance of about 125 m., through a marshy valley abounding in peat. Commanded by Ham, Péronne, Amiens and Abbeville, this valley forms a northern line of defence for Paris. Apart from the water-power it supplies, the Somme is of great commercial value, being accompanied by a canal all the way from its source wherever it is not itself navigable. From Abbeville to St Valery its lower course forms a maritime canal 165 ft. wide, 12 ft. deep, and 8 to 9 m. long, capable of bearing at high tide vessels of 300 tons burden. From St Valery to the open sea the current hollows out a very variable bed accessible at certain tides for vessels of 500 tons. The most important affluents of the Somme—the Ancre from the north-east by way of Albert and Corbie, the Avre from the south-east by Roye, and the Selle from the south by Conty—join the main streams at Amiens. The Authie and the Bresle are respectively 63 and 45 m. long. The latter ends in a maritime canal about 2 m. long between Eu and Tréport.

The mean temperature is lower than that of Paris (49° F. at Abbeville). The mean annual rainfall is 33 in. at Abbeville. The department, especially in the north-east, is one of the best cultivated in France. Beetroot for sugar is the staple crop of the Péronne arrondissement; cereals, chiefly wheat, fodder and mangel-wurzels, oil plants, poppy, colza, flax, hemp and potatoes are grown throughout the department, the latter more largely on the seaboard. Stock-raising of all kinds is successfully carried on. No wine is grown, the principal drinks being beer and cider. Market gardening is of great importance round Amiens. Peat-cutting is actively carried on, the best qualities and the deepest workings being in the valley of the Somme, between Amiens and Abbeville. Phosphate of lime is also an important mineral product. The manufacture of a great variety of textile goods, especially velvet (Amiens), of beet sugar and alcohol, and of locks, safes and the like (in the Vimeu), are characteristic industries of the department, which also carries on saw-milling, flour-milling, brewing, dyeing, ironfounding and forging, printing and the manufacture of paper, chemical products, machines and ironmongery, hosiery (in the Santerre), &c. Cereals, horses of the Boulogne or Norman breed, cattle, hemp and linen, and the manufactured goods are the exports of the department. St Valery (pop. 3389) exports vegetables and farm-products (to England), and shingle for the manufacture of earthenware. Besides the raw materials for the manufacturing industries, wines and timber, the latter largely imported at St Valery, dyestuffs and coal are imported.

The department is served principally by the Northern railway, and its canals and rivers provide 140 m. of navigable waterway. Administratively the department comprises 5 arrondissements (those of Amiens, the capital, Abbeville, Doullens, Montdidier and Péronne), 41 cantons and 836 communes. The department belongs to the *académie* (educational circumscription) of Lille, and constitutes the diocese of Amiens, which city is also the seat of a court of appeal and the headquarters of the region of the II. army corps, wherein the department is included.

The most noteworthy places are Amiens (the capital), Abbeville, Montdidier, Péronne, Doullens, St Riquier, Crécy and Ham, which are treated under those headings. The following places may also be mentioned: Albert (pop. 6656), after Amiens and Abbeville the most populous town in the department and a centre for machine construction; Villers-Bretonneux (pop. 4447), a centre of hosiery manufacture; Corbie, once celebrated for its Benedictine abbey (founded in the 7th century) the church of which (16th-18th century) is still to be seen; L'Étoile, with the well-preserved remains of a Roman camp; Folleville, which has a church (15th century) containing the fine Renaissance tomb of Raoul de Lannoy; Picquigny, with

the remains of a château of the 14th, 15th and 16th centuries, once one of the chief strongholds of Picardy; Rue, where there is a fine chapel of the 15th century; and Tilloloy, which has a Renaissance church.

SOMMER, in architecture, a girder or main beam of a floor; if supported on two storey posts and open below, it is called a *brass* or *breast-sommer*. The word is also spelled "summer," and is the same as "sumpter," a pack-horse, Fr. *sommier*, O. Fr., *saume*, from Low Lat. *salma*, pack, burden, Gr. *σάγμα*, *σάρτεω*, to fasten a pack on a horse.

SOMMERFELD, a town of Germany, in the Prussian province of Brandenburg, on the Lubis, 40 m. S.E. of Frankfort-on-Oder, by the railway from Berlin to Breslau. Pop. (1905), 12,251. It has a Roman Catholic church, three Evangelical churches, several schools and a hospital. Its manufactures of woollen cloth are important; and it also contains finishing and dye-works, an ironfoundry, boiler-works and breweries.

SOMMERS, WILLIAM (d. 1560), court fool of Henry VIII., is said to have been brought to the king at Greenwich by Richard Fermor, about 1525. He was soon in high favour with Henry, whose liberality to Sommers is attested by the accounts of the royal household. The jester possessed a shrewd wit, which he exercised even on Cardinal Wolsey. He is said to have warned his master of the wasteful methods of the exchequer and to have made himself the advocate of the poor. His portrait is shown in a painting of Henry VIII. and his family at Hampton Court, and he again appears with Henry VIII. in a psalter which belonged to the king and is now in the British Museum. He was probably the William Sommers whose death is recorded in the parish of St Leonard's, Shoreditch, on the 15th of June 1560.

For his position in 16th- and 17th-century literature see T. Nash, *Pleasant Comedie called Summers' last Will and Testament* (pr. 1600); S. Rowlands, *Good Newes and Bad Newes* (1622); and a popular account, *A Pleasant Historie of the Life and Death of William Sommers* (reprinted 1794). See also John Doran, *History of Court Fools* (1858).

SOMNAMBULISM (from Lat. *somnus*, sleep, and *ambulare*, to walk), or sleep-walking, the condition under which people are known to walk along while asleep, apparently unconscious of external impressions, return to bed, and when they awake have no recollection of any of these occurrences. Sometimes the actions performed are of a complicated character and bear some relation to the daily life of the sleeper. Thus a cook has been known to rise out of bed, carry a pitcher to a well in the garden, fill it, go back to the house, fill various vessels carefully and without spilling a drop of water, then return to bed, and have no recollection of what had transpired. Again, somnambulists have been observed to write letters or reports, execute drawings, and play upon musical instruments. Frequently they have gone along dangerous paths, executing delicate movements with precision.

Four types of somnambulists may be noticed: (1) those who speak without acting, a common variety often observed in children and not usually considered somnambulist; (2) those who act without speaking, also well known and the most common type; (3) those who both act and speak, more exceptional; and (4) those who both act and speak and who have not merely the sense of touch active but also the senses of sight and hearing. The fourth class is the most extreme type and merges into the physiological condition of mesmerism or hypnotism (*q.v.*), and it is necessary here only to notice it in connexion with the subject of sleep. Many observations indicate that, at all events in some cases, the somnambulist engaged, for example, in writing, has a mental picture of the page before him and of the words he has written. He does not see what he really writes. This has been proved by causing persons to write on a sheet of paper lying on the top of other sheets. After he had been allowed to write a few sentences, the sheet was carefully withdrawn and he continued his writing on the next sheet, beginning on the new sheet at the corresponding point where he left off on the first one. Moreover, the somnambulist, by force of habit, stroked t's and dotted i's at the exact places

where the t's and i's would have been had he written continuously on one sheet, showing that what he was conscious of was not what was before him, but the mental picture of what he had done.

The following table, modified from two such tables given by Benjamin Ball (b. 1833) and Chambard in their classical article "Somnambulisme" in the *Dictionnaire encyclopédique des sciences médicales*, shows the relation of the various intermediate conditions of sleeping and awaking and of the dreaming and somnambulist states. The horizontal stroke indicates the presence of the condition the name of which heads the column:—

	Organic life.	Consciousness.	Imaginative faculties.	Co-ordinating faculties.	Power of movement and sensibility.
Normal waking state . . .	—	—	—	—	—
Sleep, 1st degree . . .	—	—	—	—	—
" 2nd degree . . .	—	—	—	—	—
" 3rd degree . . .	—	—	—	—	—
Deep sleep . . .	—	—	—	—	—
Waking, 1st degree . . .	—	—	—	—	—
" 2nd degree (specially dreaming state) . . .	—	—	—	—	—
" 3rd degree . . .	—	—	—	—	—
Complete waking . . .	—	—	—	—	—
Dreaming state . . .	—	—	—	—	—
Ordinary somnambulism —(2) above. . .	—	—	—	—	—
Profound somnambulism (perfect unconsciousness) . . .	—	—	—	—	—
Somnambulist dream (movements in a dream) . . .	—	—	—	—	—

The somnambulist acts his dream. His condition is that of a vivid dream in which the cerebrum is so active as to influence centres usually concerned in voluntary movements. Under the dominant idea he executes the movements that this idea would naturally excite in the waking state. Many of his movements are in a sense purposive; his eyes may be shut so that the movements are executed in the dark, or the eyes may be open so that there is a picture on the retina that may awaken no consciousness, and yet may, by reflex mechanisms, be the starting-point of definite and deliberate movements. In many cases he does not hear, the auditory centres not responding; but in others suggestive words may alter the current of his dream and lead him to perform other actions than what he intended to do. On awaking there is either no memory of what has taken place or the dim recollection of a fading dream.

It is important to notice that there is scarcely any action of which a somnambulist may not be capable, and immoral acts from which the individual would shrink in waking hours may be performed with indifference. Considering the abrogation of self-control peculiar to the physiological condition, it is evident that no moral responsibility can be attached to such actions. In cases where somnambulist propensities place a person in danger, an endeavour should be made to induce him to return to bed without awakening him; as a rude awakening may produce a serious shock to the nervous system. Inquiry should then be made into the exciting cause of the somnambulist dream, such as a particular train of thought, over-excitement, the reading of special books, the recollection of an accident or of a crisis in the person's history, with the view of removing the cause if possible. It should never be forgotten that somnambulism, like chorea, hysteria and epilepsy, is the expression of a general morbid predisposition, an indication of a nervous diathesis, requiring careful treatment so as to avoid more dangerous maladies.

See also SLEEP and MUSCLE AND NERVE (physiology).

SOMNATH, an ancient decayed city of Kathiawar in the province of Bombay, India. Pop. (1901), 8341. It is situated on a bay of the Arabian Sea. The port, which is called Verāwal, is distinct from the city proper (Deva-Pattan, Somnāth-Pattan, or Prabhas). The latter occupies a prominence on the south side of the bay, is surrounded by massive fortifications, and retains in its ruins and numerous tombs many traces of its former greatness as a commercial port. But the city was most famous for the temple just outside its walls in which stood the great idol or rather columnar emblem of Siva called Somnāth (Moon's lord), which was destroyed by Mahmūd of Ghazni. The famous "Gates of Somnath," which were supposed to have been carried off by Mahmūd to Ghazni, had probably no connexion with Somnath. They are built of deodar (11 ft. in height and 9½ in width) and are richly carved in geometric

Saracenic patterns. The gates were attached to the building covering Mahmūd's tomb at Ghazni until their removal to India, under Lord Ellenborough's orders, on the evacuation of Afghanistan in 1842. They are now contained in the arsenal at Agra.

SOMNUS, the Latin name for the personification of sleep, in Greek Hypnos (Ἵπνος). He is the son of Night and the twin brother of Death, with whom he dwells in the darkness of the underworld. At first the difference between the two is strongly marked. While Death is cruel and merciless, and never lets go his prey once seized, Sleep is gentle and kindly, the bestower of rest and pleasant dreams, the soother of care and sorrow. Even Zeus is unable to resist his influence, and on two occasions was put to sleep by him at the instance of Hera. In time, however, the conception of Death was greatly modified, until at last he was depicted as a beautiful boy, with or without wings. In like manner, Sleep came to be used as a euphemism for Death. In art the representations of Sleep are numerous and varied. On the chest of Cypselus, Night was depicted holding in her hands two sleeping children—one white (Sleep), the other black (Death). His most common form is that of a vigorous young man, with wings on his forehead; his attributes a stalk of poppy, and a horn from which he drops slumber upon those whom he puts to rest. In Ovid (*Metam.* xi. 592) the home of Sleep is placed in a dark grotto in the land of the Cimmerians, where he dwells surrounded by a band of Dreams.

See Homer, *Iliad* xiv. 231—xvi. 672; Hesiod, *Theog.* 212, 758; Pausanias, v. 18, 1.

SONATA (From Ital. *sonare*, to sound), in music, originally merely a piece "played" as opposed to "cantata," a piece sung, though the term is said to have been applied once or twice to a vocal composition. By the time of Corelli two polyphonic types of sonata were established, the *sonata da chiesa* and the *sonata da camera*.

The *sonata da chiesa*, generally for one or more violins and bass, consisted normally of a slow introduction, a loosely fugued allegro, a cantabile slow movement¹ and a lively finale in some such "binary" form (see SONATA FORMS) as suggests affinity with the dance-tunes of the SUITE (*q.v.*). This scheme, however, is not very clearly defined, until the works of Bach and Handel, when it becomes the sonata *par excellence* and persists as a tradition of Italian violin music even into the early 19th century in the works of Boccherini.

The *sonata da camera* consisted almost entirely of idealized dance-tunes. By the time of Bach and Handel it had, on the one hand, become entirely separate from the sonata, and was known as the *suite*, *partita*, *ordre* or (when it had a prelude in the form of a French opera-overture) the *overture*. On the other hand, the features of *sonata da chiesa* and *sonata da camera* became freely intermixed. But Bach, who does not use those titles, yet keeps the two types so distinct that they can be recognized by style and form. Thus, in his six solo violin sonatas, Nos. 1, 3 and 5 are *sonate da chiesa*, and Nos. 2, 4 and 6 are called *partitas*, but are admissible among the sonatas as being *sonate da camera*.

The sonatas of Domenico Scarlatti (*q.v.*) are a special type determined chiefly by those kinds of keyboard technique that are equally opposed, on the one hand, to contrapuntal style, and, on the other hand, to the supporting of melodies on a lifeless accompaniment. Longo's complete collection of Scarlatti's sonatas shows that, short of the true developed sonata-style, there is nothing between the old *sonata da chiesa* and Beethovenish experiments in unorthodox "complementary keys" that Scarlatti does not carry off with a delightfully irresponsible "impressionism" that enables him to be modern in effect without any serious modern principle. Great, however, as the variety of his forms is now known to be, and numerous as are

¹ A *movement* is a piece of music forming a complete design, or at least not merely introductory; and within such limits as either to contain no radical change of pace or else to treat changes of pace in a simple and symmetrical alternation of episodes. The first complete movement of a sonata seldom leads without break to the others, except in modern examples; but the later movements are often connected.

the newly published slow movements, the normal Scarlatti sonata is that which the concert-player popularizes; fireworks in binary form, with a perfunctory opening, a crowd of pregnant ideas in the complementary key, and, after the double bar, a second part reproducing these ideas as soon as possible in the tonic. The sonatas of Paradies are mild and elongated works of this type with a graceful and melodious little second movement added. The manuscript on which Longo bases his edition of Scarlatti frequently shows a similar juxtaposition of movements, though without definite indication of their connexion. The style is still traceable in the sonatas of the later classics, whenever a first movement is in a uniform rush of rapid motion, as in Mozart's violin sonata in F (Köchel's Catalogue, No. 377), and in several of Clementi's best works.

The sonata in its main classical significance is a work for one or two instruments consisting of a group of movements, four movements being the full scheme; the last movement in the same key as the first; each movement normally in one tempo, complete in design, independent from the other movements in themes, but aptly related to them in key and style; and constructed in the SONATA FORMS (*q.v.*).

Though, since the time of Bach (when trios were called sonatas), the term is not applied to works for more than two instruments, the full (and even the normal) characteristics of this most important of all instrumental art-forms are rarely revealed except in trios, quartets, &c., and symphonies.

SONATA FORMS, in music. The sonata forms (see SONATA above) cover the whole ground of instrumental music from C. P. E. Bach to the advent of the instrumental lyric as matured by Schumann and of the symphonic poem originated by Liszt. They also have a profound influence on classical opera and vocal music, and hence, by repulsion, upon Wagner, whose life-work consisted in emancipating the music-drama from them. The conditions which developed them were the conditions which made Gluck's reform of opera possible; for they are at once the means and the expression of that 18th-century change in the language of music which made it a truly dramatic medium. Hence our present task is the discussion of the largest and most central problems pure music has ever dealt with; and, while the external technicalities are numerous and prominent, they are significant only so long as we maintain their connexion with those problems with which the true masters (and only the true masters) of the sonata forms are concerned. Much, then, that is essential to the true sonata forms must come under the headings of instrumentation, harmony, and other musical categories. But here we must confine ourselves to the purely formal aspect, allowing only such allusion to other aspects as will help us to see behind superficial appearances.

1. *The Sonata Style*.—The sonata forms are representative of the type of music that attracts us primarily by its design and its larger contrasts, and only in the second place by the vitality of its texture. In Bach's art the reverse is the case; we listen chiefly to the texture, and our delight in the larger designs, though essential, is seldom more than subconscious. Art-forms existed already in Bach's time, in which the shape, and not the texture, was the object of attention, but these were lighter forms. Bach himself was the greatest master of them, but he never transcended what was then their legitimate limit as an art which is related to his larger work much as decorative designs are related to architecture. Bach's suites and partitas (see SUITE) contain (apart from their great preludes, in which other principles are involved) one form embodied in several different dance rhythms, which is the germ from which the sonata was developed. It is sometimes known as the "binary" form; but as some eminent writers classify its later development as "ternary," we shall here avoid both terms, and refer to it in its earlier manifestations as the "suite" form, and in its later as the "sonata" form. In the suite it may be represented by the following diagram:—

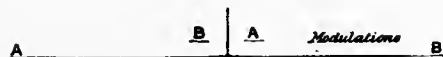

where the long horizontal line represents the main key, the short horizontal lines represent a second key, the perpendicular line represents the division into two portions,¹ and the letters represent the phrases. This form is often typified in the compass of a single melody without change of key or marked division, as in that beautiful English tune "Barbara Allen," where the half-close on the dominant in the fourth bar is symmetrically reproduced as the full close on the tonic at the end (see MELODY, example 1). On a larger scale it admits of great variety and elaboration, but the style of the classical suite never allows it to become much more than the musical analogue of a pattern on a plate. The passage from the material in the main key to that in the foreign key (from A to B in the above diagram) is continuous and unnoticeable, nor is the second part of the design which leads to the return of B in the tonic noticeably different in style or movement from the earlier part. It has a slightly greater range of key, for the sake of variety, but no striking contrast. Lastly, the rhythms, and such texture as is necessary to keep the details alive, are uniform throughout.

Now, the essential advance shown by the true sonata forms involves a direct denial of all these features of the suite style. No doubt one natural consequence of working on a larger scale is that the sonata composer tends to use several contrasting themes where the suite composer used only one; and an equally natural consequence is that the shape itself is almost invariably amplified by the introduction of a recapitulation of A as well as of B in the tonic, so that our diagram would become modified into the following:—



But these facts do not constitute a vital difference between sonata and suite forms. They do not, for instance, enable composers like Boccherini and the later Italian violin writers to emancipate themselves from the influence of the suite forms, though the designs may be enlarged beyond the bursting point. The real difference lies, indeed, in every category of the art, but primarily in a variety of rhythm that carries with it an entirely new sense of motion, and enables music to become not only, as hitherto, architectural in grandeur and decorative in detail, but dramatic in range. The gigue of Bach's C major suite for violoncello, and the allemande of his D major clavier partita, will show that the suite forms were amply capable of digesting a non-polyphonic style and a group of several contrasted themes; but they still show the uniformity of rhythm and texture which confines them to the older world in which visible symmetry of form is admissible only on a small scale. Haydn can write a movement, perhaps shorter than some of Bach's larger dance movements, containing only one theme and mainly polyphonic in texture, as in the finale of his tiny string quartet in D minor, *Op.* 42; but the transformations of his one theme will be contrasted in structure, the changes of rhythm will be a continual surprise, the passage from the first key to the second will be important and emphatic, and at every point the difference in scope between his sonata music and Bach's suite music will be as radical as that between drama and lyric. The process of this change was gradual; indeed, no artistic revolution of such importance can ever have been accomplished more smoothly and rapidly. Yet Philipp Emmanuel Bach, the first to realize the essentials of the new style, obtained his object only at the cost of older elements that are essential to artistic completeness. And Haydn himself was hardly able to reinfuse such vitality of texture as would give the new form permanent value, before he was forty years of age.

Haydn's earlier string quartets, from *Op.* 1 to *Op.* 33, present one of the most fascinating spectacles of historical development in all music. He was content to begin at a lower level of brilliance

¹ In all stages of development it has been usual to repeat at least the first portion. The repetition is indicated by a sign and may be ignored in analysis, though Haydn, Beethoven and Brahms have sometimes produced special effects by it. The repetition of the second part is now obsolete, and that of the first nearly so.

than some of his contemporaries; because from the outset his object was the true possibilities of the new style, and no luxuriance of colour could blind him to the lifelessness of an art that is merely suite-form spun out. Haydn's earliest quick movements in sonata forms are often as short as any suite movement, except when he writes for orchestra, where he is influenced by the style of the operatic overture as we find it in Gluck and in the symphonies of Philipp Emmanuel Bach. In his slow movements he at first more often than not worked in the style and form of the operatic aria; and in so mature a piece as the quartet in G major, *Op.* 17, No. 5, he not only endorses Philipp Emmanuel Bach's evident conviction that operatic recitative is within the scope of the sonata, but convinces us that he is right. It was easy for the early composers of sonatas to introduce theatrical features into their instrumental music; for the very fact that the sonata forms were in polyphonic days the forms of lighter music is a consequence of their original identity with the forms of stage-music and dance (see OVERTURE and SYMPHONY). But it needed a very great composer to realize not only the radically dramatic character of a sonata form in which the rhythm and texture is emancipated from the metrical bondage of the suite, but also its true limitations as pure instrumental music. As Haydn's work proceeded, so did the freedom of his rhythm and its consequent inner dramatic life increase; while the external operatic influences soon disappeared, not so much because they were out of place, as because opera itself "paled its ineffectual fires" in the daylight of the pure instrumental drama with its incomparably swifter and terser action. Polyphony, on the other hand, steadily increased, and was so openly encouraged that in the first set of Haydn's quartets which is entirely free from archaism (*Op.* 20) three of the finales are regular fugues. And from that time onward there is hardly a work of Haydn's in which highly organised *fugato* passages are not a frequent means of contrast.

2. *The Sonata Form.*—In the last-mentioned quartets of Haydn and the works of Mozart's boyhood, the normal sonata form, as we now accept it, is firmly established, and may be represented as follows:—

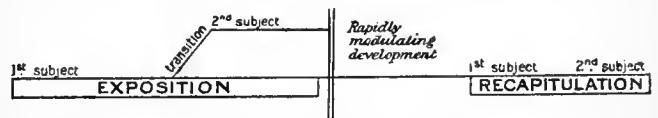

This diagram is, no doubt, equally true of Philipp Emmanuel Bach's form; and thus we see how little the external shape of a movement tells us as to the ripeness or genuineness of the specimen. Apart from this, much confusion of thought is caused by the unfortunate terms "first and second subject," which have misled not only many teachers but nearly all pseudo-classical composers into regarding the exposition of the movement as consisting essentially of two themes expanded to the requisite size by appropriate discourse. When we use the terms "first and second subject," then, let us be understood to mean any number of different themes, in any variety of proportion, but separable into two groups of which the first is in the tonic while the second is in another related key, which is called the complementary key. The exposition of a movement in sonata form contains, then, these two "subjects" and represents these two keys; and unless the work is too large or too emotional for merely decorative emphasis, the exposition is generally repeated. Then the development follows. It is normally founded on the materials of the exposition, but neither confines itself steadily to any key nor leaves its material as it found it. On the contrary, its function is to provide a wide range of modulation, and to put the materials into fresh light by regrouping them (see MELODY, examples 2-7). It cannot be too strongly insisted that in the sonata forms there are no rules whatever for the number of themes and their relative prominence among themselves and in their development. After the development the first subject returns in the tonic, with an effect which, after so many changes of key, is always reassuring as regards

design, and sometimes intensely dramatic. The second subject follows, also in the tonic. This recapitulation is normally very exact, except for the alteration necessary to bring the second subject into the tonic instead of the complementary key, an alteration which, of course, will chiefly affect the first subject, if, indeed, the original transition was not so simple that it could be merely suppressed. In highly organized works, however, this point is often marked by some special stroke of genius, and even in the most exact recapitulations the great masters make minute changes which throw the second subject into higher relief. Modern criticism tends to dismiss the recapitulation as a conventional and obsolescent feature; but this is a great mistake. The classics, from Scarlatti to Brahms, give overwhelming proof that it is a primary instinct of composers with a living sense of form to conceive of all kinds of exposition as predestined to gain force by recapitulation, especially in any part that resembles a second subject. Haydn we shall find to be an extreme case; but we have only to regard his true second subject as residing in the very end of his exposition, and his mature work will then illustrate the point with special force. Beethoven seems to give one notorious detail to the contrary effect, in the first movement of his C minor symphony, but the passage only proves the rule more forcibly when seen in its context. The powerful phrase that announced the second subject is in the recapitulation transferred from the resounding triumph of the horns to the impotent croaking fury of the bassoons. This looks like a mere inconvenient result of the fact that in 1808 the horns could not transfer the phrase from E flat to C without a change of crook. But in earlier works Beethoven has made them change crooks on far less provocation; and besides, he could easily have contrived a dozen tone-colours more dignified than that of the bassoons. The point must, then, be one of Beethoven's touches of Shakespearean grotesqueness; and certainly it draws attention to the recapitulation. But even if we dismiss it with impatience we are then immediately confronted with a new melodic and harmonic poignancy in the subsequent *crescendo*, produced by changes as unobtrusive and as essential to the life of the whole as are the deviations from mechanical symmetry in the forms of leaves and flowers. With the recapitulation the bare essentials of sonata form end; but the material will probably, in works on a large scale, furnish ample means of adding a more emphatic conclusion, which is then called the coda. In Beethoven's hands the coda ranges from a dramatic non-existence, as in the distant thunder in which the first movement of the D minor sonata expires, to the mighty series of new developments and climaxes which, in the 3rd and 9th symphonies and many other works, tower superbly above the normal structure.

Haydn's later treatment of sonata form is very free. He shows a sense of space and breadth which, if second to Beethoven's, can only be said to be so because the terms of Haydn's art did not give it fuller expression. The scale on which he worked was so small that he soon found that a regular recapitulation took up all the room he wanted for larger growths to a brilliant climax. Moreover, he found that if his second subject began with material in sharp contrast to the first, it tended to make his movements sound too undeveloped and sectional for his taste; and so in his later works he generally makes his second subject on the same material as his first, until the very end of the exposition, where an exquisitely neat new theme forms the close. This cadence-theme also rounds off the whole movement with an appearance of regularity which has led to the belief that Haydn, like Mozart, observes a custom of rigid recapitulation from which Beethoven was the first to emancipate the form. The truth is that the brilliant new developments which oust the recapitulation almost entirely in Haydn's form are more like Beethoven's codas than anything else in earlier music, and the final appearance of the neat cadence-theme at the end is, from its very formality, the most brilliant stroke of all. Lastly, these tendencies are characteristic, not of Haydn's early, but of his late work. They have been described as "showing form in the making"; but this is far from true. They show

form in an advanced state of development; and further progress was only possible by the introduction of new qualities which at first had a decidedly restraining effect.

Mozart's greater regularity is due, not to a more formalizing tendency than Haydn's, but to the fact that he works on a larger scale and with a higher polyphony. In actual length, Mozart's movements are so much greater than Haydn's that sharply contrasted themes and regular recapitulations do not hamper him. On the contrary, they give his designs the necessary breadth. This was not more his aim than Haydn's; but he had the opportunities of a later generation and the example of Haydn's own earlier work, besides a vast experience of composition (both in contrapuntal and sonata forms) that began in his miraculous infancy and made all technical difficulties vanish before he was fifteen. At sixteen he was writing string-quartets in which his blending of polyphonic and sonata style is more surprising, though less subtle, than Haydn's. At twenty-two he was treating form with an expansiveness which sometimes left his music perilously thin, though he was never merely redundant. The emphatic reiterations in the *Paris* symphony are not mannerisms or formulas; they are the naturally simple expression of a naturally simple material. In a series of easy-going works of this kind he soon learnt the conditions of breadth on a large scale; and, by the time he came under the direct influence of Haydn, every new polyphonic, rhythmic and instrumental resource enlarged the scale of his designs as fast as it increased their terseness and depth. His career was cut short, and his treatment of form reached its limit only in the direction of emotional expression. The sonata style never lost with him its dramatic character, but, while it was capable of pathos, excitement, and even vehemence, it could not concern itself with catastrophes or tragic climaxes. The G minor symphony shows poignant feeling, but its pathos is not that of a tragedy; it is there from first to last as a result, not a foreboding nor an embodiment, of sad experiences. In the still more profound and pathetic G minor quintet we see Mozart for once transcending his limits. The slow movement rises to a height not surpassed by Beethoven himself until his second period; an adequate finale is unattainable with Mozart's resources, and he knows it. He writes an introduction, beautiful, mysterious, but magnificently reserved, and so reconciles us as he best can to the enjoyment of a lighthearted finale which has only here and there a note of warmth to suggest to us any pretension of compatibility with what went before.

Beethoven discovered all the new resources needed to make the sonata a means of tragic expression, and with this a means of expressing a higher rapture than had ever been conceived in music since Palestrina. He did not, as has sometimes been said, emancipate sonata forms from the stiffness of the recapitulation. On the contrary, where he alters that section it is almost invariably in order to have, not less recapitulation, but more, by stating some part of the second subject in a new key before bringing it into the tonic. Here, as has been suggested above, the effect of his devices is, both in minutiae and in surprises, to throw the second subject into higher relief. Every one of the changes which appear in the outward form of his work is a development from within; and, as far as any one principle is more fundamental than others, that development is primarily harmonic. We have elsewhere mentioned his practice of organizing remote or apparently capricious modulations on a steady sequential progression of the bass, thereby causing such harmonies to appear not as mere surprises or special effects (a form in which they have a highly artistic function in Mozart and Haydn) but as inevitable developments (see *BEEETHOVEN* and *HARMONY*). The result of this and a host of similar principles is an incalculable intensification of harmonic and emotional expression. Let us compare the opening of the second subject of Haydn's quartet in A major, *Op.* 20, No. 6, with the corresponding passage in the first movement of Beethoven's sonata, *Op.* 2, No. 2. Haydn executes the masterly innovation of a second subject that before establishing its true key passes through a series of rich modulations. He begins in E minor,

rapidly passing through G and A minor, and so to the dominant of E, in various phases of tender humour and cheerful climax. The keys are remote but not unrelated, the modulations are smooth, and the style is that of a witty improvisation. Beethoven's second subject is intensely agitated; its modulation begins like Haydn's as regards key, but its harmonies are startling and its pace tremendous. Its regular rising bass carries it in two steps to a totally unrelated key, through which it is urged by the same relentless process with increasing speed, and when it is at last driven to the threshold of the key which it seeks as its home there is a moment of suspense before it plunges joyfully into its cadence. Such resources as this enable Beethoven to give rational dramatic force to every point in his scheme, and so they soon oust those almost symbolical formulas of transition and cadence which are a natural feature in Mozart's music and a lifeless convention in imitations of it. The growth of Beethoven's forms is externally most evident in his new freedom of choice for the complementary key. Hitherto the only possible key for the second subject was in major movements the dominant, and in minor movements the relative major or dominant minor. A sonata which begins by treating all directly related keys as mere incidents in establishing the tonic, will very probably choose some remoter key as its main contrast; and it is worth while trying the opening of the *Waldstein* sonata (*Op.* 53) with the simple alteration of C sharp and A natural for C natural and A sharp in the bass of the twenty-first bar, so as to bring the whole transition to the second subject on to the orthodox dominant of G, in order to see, on the one hand, how utterly inadequate that key is as a contrast to the opening, and, on the other hand, how unnecessarily long the transition seems when that is the key which it is intended to establish.

3. *The Sonata as a whole.*—The history of the *Waldstein* sonata marks the irrevocable transition from Mozart to Beethoven (see iv. 88); and in his rejection of the well-known *Andante in F* (which was originally intended for its slow movement) Beethoven draws attention to the problem of the sonata as a whole, and the grouping of its movements. The normal sonata, in its complete (or symphonic) form, consists of four movements: firstly, a quick movement in that sonata form *par excellence* to which our discussion has been hitherto confined; then two middle movements, interchangeable in position, the one a slow movement in some lighter form, and the other a dance movement (the minuet, or scherzo) which in earlier examples is of hardly wider range than a suite movement. The finale is a quick movement, which may be in sonata form, but generally tends to become influenced by the lighter and more sectional rondo form, if indeed it is not a set of variations, or even, in the opposite extreme, a fugue. Aesthetically, if not historically, this general scheme is related to that of the suite, in so far as it places the most elaborate and highly organized movement first, corresponding to the *allemande* and *courante*; while the slow movement, with its more lyric character and melodious expression, corresponds to the *sarabande*; the minuet or scherzo to the lighter dance tunes or "*Galanterien*" (such as the *gavotte* and *bourrée*), and the lively finale to the *gigue*. But just as the whole language of the sonata is more dramatic, so are the contrasts between its movements at once sharper and more essential to its unity. Hence, the diversity of outward forms within the limits of these four movements is incalculable.

The first movement is almost always in the sonata form *par excellence*, because that admits of higher organization and more concentrated dramatic interest than any other. Often after such a movement a slow piece in the form conveniently known as A B A, or simple "ternary" form (*i.e.* a broad melody in one key, followed by a contrasted melody in another, and concluded by a recapitulation of the first) is found to be a welcome relief, and of great breadth of effect. Of course in all true classics the very simplicity of such movements will be inspired by that sense of rhythmic freedom and possibility of development that permanently raises sonata forms from the level of a mere decorative design; nor, on the other hand, is there any limit to the complexity

of form possible to a slow movement, except that imposed by the inevitable length of every step in its slow progress. Still, the tendency of slow movements, even more than of finales, is to prefer a loose and sectional organization. Sonata form is frequently used in them by Haydn and Mozart with the success attainable only by the greatest masters of rhythmic flow; but even in their works the development is apt to be episodic in character, and is very often omitted.

The minuet, in Haydn's and Mozart's hands, shows a surprising amount of rhythmic variety and freedom within the limits of a dance tune; but Haydn, as is well known, sighed for its development into something larger; and, though Beethoven had long emerged from his "first period" before he could surpass the splendid minuet in Haydn's quartet in G major, *Op.* 77, No. 1, he achieved in the scherzo of his *Eroica* symphony the first of a long line of movements which establish the scherzo (*q.v.*) as an essentially new art-form.

The only condition that affects the forms of finales is that a sonata involves a considerable stretch of time, and therefore its end must be so designed as to relieve the strain on the attention. In a drama or a story the deeper artistic necessity for this is masked by the logic of cause and effect, which automatically produces the form of an intrigue ending in a *dénouement*. In music the necessity appears in its purest form. There is no need for finales to be less serious than first movements; or even, in certain ways, less complex; but the attention which could be aroused at the outset by problems must be maintained at the end by something like a solution. Hence the use of the lighter rondo forms, which, by dividing the work into shorter and more distinct sections, make the development easier without unduly limiting its range. Hence, also, the influence of rondo style upon such finales as are cast in true sonata form; and hence, lastly, the paradox that the fugue has occasionally been found a possible means of expression for the finale of a dramatic sonata. For the complexity of the fugue, though incessant, is purely a complexity of texture, and the mind in following that texture instinctively abandons any effort to follow the form at all, finding repose in the change of its interests.

Now, just as within the typical scheme of first and second subject development and recapitulation in the first movement, there is room for genius in the contrasting of different rhythms and proportions, so, within the limits of the simple four-movement scheme of the whole sonata is there room for genius in the contrast of various types and degrees of organization. The complete four-movement scheme seldom appears in works for less than three instruments. Beethoven was the first to adopt it for solo sonatas, and he soon thought fit to make omissions. In Haydn's work for less than four instruments it was not even necessary that the "sonata" form itself should be represented at all. Its essential spirit could be realized in the melodic and rhythmic freedom of a group or couple of more sectional movements, nor did Beethoven (in *Op.* 26 and *Op.* 27, No. 1) consider such works unworthy of the name of sonata, or (in *Op.* 54) incapable of expressing some of his most original ideas. No design is known to pure instrumental music that is not possible as a movement of a sonata, if it has the characteristic freedom of rhythm and is not much over a quarter of an hour in length. There is no form that has not been so applied; and, indeed, the only instrumental form that has maintained a larger development outside than inside the scheme of the sonata is that of *variations* (*q.v.*).

As the scope and complexity of the sonata style grew, so did the interdependence of its movements become more evident. With Mozart and Haydn it is already vital, as we have seen in the crucial case of Mozart's G minor quintet; but the differences between one scheme and another are not remarkable until we study them closely; and, except in key-relationship, it would be difficult to trace anything more concrete than principles of contrast as interacting between one movement and another. But Beethoven's dramatic power finds as free expression in the contrasts between whole movements as it finds within the movements themselves. In his later works, the increase in harmonic

range, with the consequent prominence of remoter key-relationships, necessitating the dwelling on these keys at greater length causes the key-system of each movement to react on the others to an extent that would be purposeless in the art of Haydn and Mozart. Thus in the B flat trio, *Op. 97*, we find such remote keys as G major, D flat and D major placed in positions of great functional importance, until we come to the finale, which keeps us in suspense by its very low and quiet key-colour, contrasting so oddly with its bacchanalian temper. But when the whole main body of this finale has passed before us in the drab colours of tonic, dominant and sub-dominant, the coda marvellously explains everything by opening with an enharmonic modulation to the most distant key yet attained except as a transitory modulation.

As Beethoven proceeded, his growing sense of the functional expression of musical forms enabled him to modify and strengthen them until their interaction was as free as its principles were exact. In the C sharp minor quartet (*Op. 131*) the opening fugue is functionally an enormously developed introduction. The following *allegro*, in the startling key of D major, the "artificial" flat supertonic, is a first movement, with its development suppressed, and with certain elements of rondo style as a necessary contrast to the preceding fugue. The startling effect produced by this key of D major necessitates a simple and limited key-system within the movement itself, thus accounting for the absence of a development. The remaining movements fall into their place among the keys that lie between the keys of D major and C sharp minor. Thus the slow movement (to which the brief *allegro moderato* forms a dramatic introduction) is a great set of variations in A major, and the strictness of its variation form allows no change of key until the two brilliant bursts of remoter harmony, F and C, in the coda. Then follows a scherzo of extremely simple design, in E major, with a small part of its trio in A. A short introduction in G sharp minor, the dominant, completes the circle of related keys and leads to the finale which (though cast in a compound of rondo and sonata form that would allow it a free range of modulation) contents itself with very simple changes, until towards the end, where it systematically demonstrates the exact relationship of that first surprising key of D major to C sharp minor.

4. *The Unity of the Sonata*.—The gigantic emotional range of Beethoven's work is beyond the scope of technical discussion, except in so far as the technical devices themselves suggest their emotional possibilities. The struggle between decadence and reaction since the time of Beethoven indicates on the one side the desire to rival or surpass Beethoven in emotional expression without developing the necessary artistic resources; and, on the other side, a tendency to regard form as a scheme which the artist first sets up and then fills out with material. Early in the 19th century these tendencies gave rise to controversies which are not yet settled; and before we discuss what has taken place since Beethoven we must consider the connexion between sonata movements in a last new light.

Historical views of art are apt to be too exclusively progressive and to regard higher and lower degrees of organization in an art-form as differing like truth and falsehood. But in trying to prove that the megatherium could not survive under present conditions, we must beware of arguing that it never existed; nor must we cite the fact that man is a higher organism in order to argue that a jelly-fish is neither organic nor alive. Organization in art, as elsewhere, may be alive and healthy in its lowest forms. The uniformity of key in the suite forms is low organization; but it is not inorganic until a mild seeker after novelty, like A. G. Muffat, tries to introduce more keys than it will hold. The interdependence of movements in Haydn and Mozart is not such high organization as the ideal form of the future, in which there is no more breaking up of large instrumental works into separate movements at all; but neither is it a mere survival from the decorative contrasts of the suite. Evolutionists must not forget that in art, as in nature, the survival of the fit means the adaptability to environment. And the immortal works of art bring their proper environment with them into later ages.

The large instrumental forms have, until recent times, remained grouped into sonata movements, because their expression is so concentrated and their motion so swift that they cannot, within the limits of a single design, give the mind time to dwell on the larger contrasts they themselves imply. Thus, in the "Sonata Appassionata," the contrast between the first subject and the main theme of the second is magnificent; but that calm second theme lasts just the third part of a minute before it breaks off. Now, though the third part of a minute bears about the same proportion to the whole design as five hundred lines does to the design of *Paradise Lost*; though, moreover, this theme recurs three times later on, once in an exact recapitulation, and twice transformed in terribly tragic climaxes; yet the mind refuses to be whirled in less than ten minutes through a musical tragedy of such Shakespearian power without opportunity for repose in a larger scheme of contrasts than any attainable by the perfection and breadth of the single design within these limits. Hence the need for the following slow set of variations on an intensely quiet tune, which, by its rigorous confinement to the tonic of a nearly related key, its perfect squareness of rhythm, and the absolute simplicity and strictness of its variations, reveals the true pathos of the first movement by contrast with its own awful repose; until its last chord, the first in a new key, falls like a stroke of fate, and carries us headlong into the torrent of a finale in which nothing dares oppose itself to those sublime forces that make the terror of tragedy more beautiful than any mere appeal for sympathy. Thus the dramatic interdependence of sonata movements is very strict. Yet the treatment by each movement of its own thematic material is so complete that there is little or no scope for one movement to make use of the themes of another. Such instances as may be suspected in Beethoven's later works (for example, the similarity of opening themes in various movements of the sonatas, *Op. 106*¹ and *Op. 110*) are too subtle to be felt more than subconsciously; while the device of clearly quoting an earlier movement occurs only in three intensely dramatic situations (the introductions to the finales in *Op. 101*, the violoncello sonata, *Op. 102*, No. 1, and the 9th symphony) where its whole point is that of a surprise.

5. *The Sonata since Beethoven*.—It is unlikely that really vital sonata work will ever be based on a kind of Wagnerian *Leit-motif* system, until the whole character of instrumental form shall have attained the state of things in which the movements are not separated at all. There has been no ambitious or "progressive" composer since Beethoven who has not, almost as a matter of etiquette, introduced the ghosts of his earlier movements into his finale, and defended the procedure as the legitimate consequence of Beethoven's *Op. 101*. But, while there is no a priori reason for condemning such devices, they illustrate no principle, new or old. The nearest approach to some such principle is furnished once by Schumann, who always ingeniously adapts the outward forms of the sonata to his own peculiar style of epigrammatic and antithetic expression, discarding as beyond his scope the finer aspects of freedom and continuity of rhythm, and constructing works which bear much the same relation to the classical sonata as an elaborate mosaic bears to an easel-picture. Dealing thus with a looser and more artificial type of organization, Schumann was able in his D minor symphony to construct a large work in which the movements are thematically connected to an extent which in more highly organized works would appear like poverty of invention, but which here furnishes a rich source of interest. Many other experiments have been tried since Beethoven, by composers whose easy mastery is that of the artist who, from long practice in putting material into a ready-made form, becomes interested in the construction of new ready-made forms into which he can continue to put the same material. A sense of beauty is not a thing to be despised, even in pseudo-classical art; and neither the many beautiful, if mannered, works of Spohr, which disguise one stereotyped form in a bewildering variety of instrumental

¹ In *Op. 106* the first two notes of the slow movement were an afterthought added (as Beethoven told his publisher) for the purpose of producing such a connexion.

and literary externals, nor the far more important and essentially varied works of Mendelssohn deserve the contempt which has been the modern correction for their high position in their day. But we must not forget that the subject of sonata forms is no mere province, but covers the whole of classical instrumental music; and we must here pay attention only to the broadest essentials of its central classics, mentioning what diverges from them only in order to illustrate them. Schubert's tendencies are highly interesting, but it would carry us too far to attempt to add to what is said of them in the articles on MUSIC and SCHUBERT.

The last great master of the sonata style is Brahms. A larger scale and more dramatic scope than Beethoven's seems unattainable within the limits of any music identifiable with the classical forms; and the new developments of Brahms lie too deep for more than a bare suggestion of their scope here. Much of the light that can as yet be shed upon them will come through the study of Counterpoint and Contrapuntal Forms (*q.v.*). Outwardly we may see a further evolution of the coherence of the key-system of works as wholes; and we may especially notice how Brahms's modern use of key-relationships makes him carry on the development of a first movement rather in a single remote key (or group of keys) than in an incessant flow of modulations which, unless worked out on an enormous scale (as in the 2nd and 4th symphonies), will no longer present vivid enough colours to contrast with those of the exposition. Beethoven's last works already show this tendency to confine the development to one region of key. Another point, fairly easy of analysis, is Brahms's unlimited new resources in the transformation of themes. Illustrations of this, as of older principles of thematic development, may be found in musical type in the article MELODY (examples 8-10). But no mere formal analysis or argument will go further to explain the greatness of Brahms than to explain that of Beethoven, Haydn or Mozart. Yet by that outward sign of dramatic mastery in the true sonata style, that variety of rhythmic motion which we have taken as our criterion, Brahms has not only shown in every work his kinship with Haydn, Mozart and Beethoven, but in one particular work he has given us documentary evidence of his faith in it. In his last years he revised, or rather recomposed, his first piece of chamber music, the trio in B major, *Op. 8*. The new material differs from the old, not only as a fresh creative impulse, but also in the simple fact that it moves literally four times as fast. Such rapidity is not shown by any external display of energy; indeed there is incomparably more repose in the new version than in the old. But the comparison of the two clearly demonstrates that the true sonata style is, now, as at the outset, primarily a matter of swift action and rhythmic variety; and nothing more certainly indicates the difference between the true style and the lifelessness of decadence or academicism than this sense of motion and proportion.

In so far as the tendencies of modern instrumental music represent an artistic ideal which is foreign to that of the sonata without being false, they represent a different type of motion, wider in its sweep, and consequently slower in its steps. The forms such a motion will produce may owe much to the sonata when they are realized, but they will certainly be beyond recognition different. In all probability they constitute the almost unconscious aims of the writers of *symphonic poems* (*q.v.*) from Liszt onwards, just as the classical sonata constituted the half-conscious aim of more than one quaint writer of 18th-century programme-music. But the growing importance and maturity of the symphonic poem does not exclude the continued development of the sonata forms, nor has it so far realized sufficient consistency and independence of style to take as high a place in a sound artistic consciousness. The wider sweep of what we may conveniently call "ultra-symphonic" rhythm owes its origin to Wagner's life-work, which consisted in evolving it as the only musical medium by which opera could be emancipated from the necessity of keeping step with instrumental music. Small wonder, then, that the new art of our time is as yet, like that of Haydn's youth, stage-struck; and that all our popular criteria suffer from the same obsession. One thing is

certain, that there is more artistic value and vitality in a symphonic poem which, whatever its defects of taste, moves at the new pace and embodies, however imperfectly, such forms as that pace is fit for, than in any number of works in which the sonata form appears as a clumsy mould for ideas that belong to a different mode of thought. If from the beginnings exemplified by the symphonic poems of the present day a new art-form arises in pure instrumental music that shall stand to the classical sonata as the classical sonata stands to the suite, then we may expect a new epoch no less glorious than that which seems to have closed with Brahms. Until this aim is realized the sonata forms will represent the highest and purest ideal of an art-form that music, if not all art, has ever realized.

See also BEETHOVEN; CONCERTO; HARMONY; OVERTURE; RONDO; SCIERZO; SERENADE; SYMPHONY; VARIATIONS. (D. F. T.)

SONCINO, a town of Lombardy, Italy, in the province of Cremona, 11 m. E. of Crema by steam tramway, 282 ft. above sea-level. Pop. (1901), 6150 (town); 8136 (commune). It contains a handsome castle built in 1469-1475 for Galeazzo Maria Sforza by Benedetto Terrini (cf. L. Beltrami, *Il Castello di Soncino*, Milan, 1890). The town was the seat of a Hebrew printing-press founded in 1472, but suppressed in 1597, when the Jews were expelled from the duchy of Milan.

SONDERBURG, a seaport and seaside resort of Germany, in the Prussian province of Schleswig-Holstein, on the S.W. coast of the island of Alsen, of which it is the chief town, and 17 m. by steamboat N.E. from Flensburg. Pop. (1905), 7047. It is connected with the mainland by a pontoon bridge, and has a castle, now used as barracks, in the beautiful chapel of which many members of the Sonderburg-Augustenburg line lie buried; a Lutheran church and a town hall. There is an excellent harbour, and a considerable shipping trade is done. The town, which existed in the middle of the 13th century, was burnt down in 1864 during the assault by the Prussians upon the Düppler trenches.

SONDERSHAUSEN, a town of Germany, capital of the principality of Schwarzburg-Sondershausen, situated in a plain 37 m. by rail N. of Erfurt. Pop. (1905), 7383. It possesses a castle, with natural history and antiquarian collections, and a parish church (restored 1891), with the mausoleum (1892) of the reigning princes. There are manufactures of woollens and pins.

SONDRIO, a town of Lombardy, Italy, capital of the province of Sondrio, in the Valtellina, 1140 ft. above sea-level, on the river Adda, 26 m. E. of Lake Como and 82 m. by rail N.E. of Milan. Pop. (1901), 4425 (town); 7707 (commune). The Valtellina, of which Sondrio is the capital, produces a considerable quantity of red wine. Sondrio also has silk-works. Above the town to the north rise the snowclad peaks of the Bernina group. The railway goes on to Tirano, 16 m. farther east, from which diverge the Bernina and Stelvio roads.

SONE, or **SON**, a river of central India which has been identified with the Erannoboas of the Greek geographers. With the exception of the Jumna it is the chief tributary of the Ganges on its right bank. It rises in the Amarkantak highlands about 3500 ft. above sea-level, the Nerbudda and Mahanadi also having their sources in the same table-land. From this point it flows north-west through an intricate mass of hills, until it strikes the Kaimur range, which constitutes the southern wall of the Gangetic plain. Here it turns east and continues in that direction until it falls into the Ganges about 10 m. above Patna, after a total course of 465 m. Its upper waters drain about 300 m. of wild hilly country, which has been imperfectly explored; while in its lower section of 160 m. it traverses the British districts of Mirzapur, Shahabad, Gaya and Patna. The Sone canals, fed by the river, form a great system of irrigation in the province of Behar. The headworks are situated at Dehri about 25 m. below the point where the river leaves the hilly ground. The weir across the Sone at this point is believed to be the longest constructed in a single unbroken piece of masonry, the length between abutments being 12,460 ft. A main canal is taken off on either bank of the river, and each of these is divided into branches,

according to the requirements of the ground. The system consists of some 370 m. of canals and 1200 m. of distributaries, irrigating 555,000 acres. The Sone canals were begun in 1869, and came into operation in 1874; they form a valuable protection to the rice crop of Behar.

SONG, either an actual "singing" performance, or in a literary sense a short metrical composition adapted for singing or actually set to music. In the second sense of the word it must strictly be lyrical in its nature; but musicians and others frequently use the word in the wider sense of any short poem set to music. A "song," as a form of poem, usually turns on some single thought or emotion, expressed subjectively in a number of stanzas or strophes. Almost every nation is in possession of an immense store of old simple ballads (*q.v.*), which are the spontaneous outcome of the inspiration of the people ("folk-songs"), and represent in a remarkable degree their tastes, feelings and aspirations; but in addition to these, there are, of course, the more finished and regular compositions born of the conscious art of the civilized poet.

In a purely literary sense the song may exist, and does largely exist, without any necessary accompaniment of music. With the accession of Elizabeth the attention of the English poets was immediately drawn to the importance of this branch of lyrical literature. The miscellanies, one of which Master Slender would have paid more than forty shillings to have in his pocket on a celebrated occasion, were garlands of songs, most of them a little rude in form, only mere "packets of bald rhymes." But about 1590 the popularity of the song having greatly increased, more skilful writers were attracted to its use, and the famous *England's Helicon* of 1600 marked the hey-day of Elizabethan song-writing. In this Shakespeare, Sidney, Lodge, Barnfield and Greene, to name no others, were laid under contribution. Lyly, with such exquisite numbers as "Cupid and my Campaspe" (1584), had preceded the best anthologies, and is really the earliest of the artist-songsters of England. Among superb song-writers who followed were Marlowe ("Come live with me and be my love"), Campion ("My sweetest Lesbia") Ben Jonson ("Drink to me only with thine eyes") and Fletcher ("Here ye Ladies, that depise"), most of these being dramatists, who illuminated their plays, and added a delicate ornament to them, by means of those exquisite lyrical interpolations. Side by side with such poets, and a little later, began to flourish the school of cavalier song-writers, for whose purpose the lyric was self-sufficient. They added to our literature jewels of perennial lustre—Wither, with his "Shall I wasting in despair," Herrick with "Bid me to live" and "Gather ye Rosebuds," Carew with "Ask me no more where June bestows," Waller with "Go, lovely Rose," Suckling with "Why so pale and wan, fond Lover?" and Lovelace with "Tell me not, Sweet, I am unkind." This was the classic age of the true British song, which survived all other forms of poetry after the decay of taste, and continued to flourish in the hands of Dryden, Sedley, Aphra Behn and Rochester down to the last decade of the 18th century. That outburst of song was followed by nearly a hundred years during which the simplest and more direct forms of lyrical utterance found comparatively little encouragement. Just before the romantic revival the song reasserted its position in literature, and achieved the most splendid successes in the hands of Burns, who adapted to his purpose all kinds of fragmentary material which had survived up to his time in the memories of rustic persons. In Scotland, indeed, the song was rather revived and adorned than resuscitated; in England it may be said to have been recreated by Blake. At the opening of the 19th century it became the vehicle of some of the loveliest fancies and the purest art of Coleridge, Keats, Shelley, Byron and Landor; while in a later day songs of rare perfection were composed by Tennyson and by Christina Rossetti. (E. G.)

Song in Music.

The history of song as a musical form falls into two main divisions, the one belonging to the folk-song, the other to the art-song. Though the line of demarcation between the two

cannot be definitely drawn, for they have acted and reacted upon each other ever since music existed as a cultivated art, yet it may reasonably be maintained that the folk-song, which lies at the base of all music, preserves, and has in all ages preserved, characteristics such as must always distinguish the rude and unconscious products of the human mind, working more by instinct than by method, from the polished and conscious products of the schools. For the purposes then of this article, *art-song* may be distinguished from folk-song by the fact that it is the work of trained musicians and is designed, at any rate after the close of the 16th century, for voice with instrumental accompaniment, whereas we shall restrict the term *folk-song* to such melodies as appear to have been the work of untutored minds, and to have arisen independently of any felt necessity for harmonic support.

The early history of song on its musical side may be regarded as the history of the evolution of melody: and since what is known of melody before the end of the 16th century, apart from the folk-song, is extremely slight, it is in the folk-song itself that this evolution is primarily to be studied. Previously to the period named the instrumental accompaniment to vocal melody, both in the folk-song and in the art-song, played an entirely insignificant part. Afterwards the new conception of harmony which came in with the 17th century not only shifted the basis of melody itself but made the instrumental accompaniment an essential feature of artistic song. Though it lies beyond the province of this article to discuss fully the complex questions involved in the evolution of vocal melody, some slight sketch is a necessary preliminary to a proper understanding of the subject under consideration.

It may be assumed that in the course of ages the uncouth vocal utterances of primitive man developed, under the influence of an instinct for expressing his inner nature through a more expressive medium than language alone, into sounds of more or less definite pitch, bearing intelligible relationships one to another; and that from these emerged short phrases, in which rhythm probably played the principal part, reiterated with that interminable persistency, which many travellers have noted as characteristic of savage nations in the present day. A further stage is reached when some such primitive phrase is repeated at a different level by way of contrast and variety, but melody in any true sense of the word does not begin till two different phrases come to be combined in some sort of scheme or pattern. When the power to produce such combinations become common in a nation, its musical history may be said to have begun.¹ Racial characteristics are displayed in the choice of notes out of which such phrases are formed. But in all races it may be surmised that the main determining cause in the first instance is that natural rise and fall of the voice which gives expressiveness and meaning to speech, even though contributory causes arising from the imitative faculty common to man may perhaps be admitted—such as the sound of the wind, the waves of the sea, the cries of animals, the notes of birds, the striking of one object against another, and finally the sounds made by primitive instruments. The tendency of the speaking voice to fall a fourth and to rise a fifth has often been noted. It is probable that these intervals were among the first to be defined, and that the many modes or scales, underlying the popular melodies of the various nations of the world, were the result of different methods

¹ If the one phrase is represented by *A*, and the other by *B*, the commonest melodic schemes presented by the folk-songs of the world may be viewed thus—*AB*, *AAB*, *ABB*, *ABA*, *ABAB*, *AABB*, *AABA*, *ABBA*. Of these, those in which the opening phrase *A* is repeated at the conclusion are the most satisfactory, for both instinct and reason are gratified by a connexion between the beginning and the end.

As exact conformity to pattern becomes wearisome and is alien to the progressive instinct, the element of surprise is introduced into the above schemes by various modifications of the repeated phrase on its second appearance, or by the entrance of an entirely new phrase *C*. In some fine melodies there is no repetition of phrase, a number of different phrases being knit, by principles, which defy analysis, into one structure. Such melodies imply a melodic sense of an exceptional order. Many melodies involve more than four phrases; of these the rondo form should be mentioned—*ABACADA*.

of determining the intervening sounds. It has been generally assumed that the fall of a fourth is the interval earliest arrived at by the instinct of the Indo-European race—and that intervening sounds were added which resulted eventually in the three possible forms of the diatonic tetrachord, the earliest being that which is characteristic of the ancient Dorian mode or scale (the basis of the Greek musical system) in which two tetrachords, having the semitone between the lowest note and the next above it, are superimposed (see Bourgault Ducoudray, Introduction to 30 *Chansons de Grèce et d'Orient*).

It must, however, be remembered that the popular instinct knows nothing about tetrachords or scales, which are abstractions, and only creates melodies, or at least successions of sounds, which are the outward expression of inward feelings. The Greek theorists therefore, in recording certain modes as being in use in their day, were in effect merely stating results arrived at by analysing popular melodies—and from the persistence with which the Greeks, and following them, most of the musical historians of Europe, have insisted upon a tetrachordal basis for the art of music it may be assumed that in these melodies a basis of four diatonic notes was a conspicuous feature.

It is a feature which marks a considerable number of folk-songs heard in Greece at the present day, and also of many folk-songs which are not Greek, the Breton, for example (see Bourgault Ducoudray, *Chansons de Basse-Bretagne*). The interval of a fourth is nearly always prominent too in the music of savages. If it is natural to connect these facts with the drop of a fourth, characteristic of the speaking voice, it is dangerous to assume an exclusively "tetrachordal period" of primitive song, at any rate till it can be shown that melodies based on other principles did not exist side by side with those that are tetrachordal. From the rise of a fifth and the fall of a fourth, the octave, which results from combining these intervals, may well have become familiar at a very early epoch. Indeed a prolonged howl beginning on a high note and descending a full octave in semitones—or notes approximately resembling semitones—is recorded both of the Caribs and of the natives of Australia, so that familiarity with the octave need not presuppose an advanced stage of musical development.

To pass from the sphere of mere speculation nearer to the domain of history, it may be asserted with confidence that the oldest form of song or chant which can be established is found in certain recitation formulae. These, as is natural, will be found to be derived from the rise and fall of the voice in speech. It is therefore not surprising that O. Fleischer (*Sammelbände der internationalen Musik-Gesellschaft*, Jan.-Mar. 1902) is able to trace practically identical formulae in the traditional methods of reciting the Vedas, the Koran, the Jewish and Christian liturgies. The simplest form consists of four notes (a diatonic tetrachord), a reciting note, preceded by two notes rising to it, and followed by a fall, or cadence, for the close, the voice rising above the reciting note in order to emphasize important words, or according to the nature of the sentence. An extended form is both natural and common.

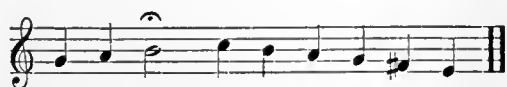

The influence of these and similar formulae¹ upon popular melodies can be illustrated by countless examples (for which

¹ The derivation of such formulae from more primitive incantations of magicians and medicine-men is a possible and plausible theory (see J. Combarieu, *La Musique: ses lois et son évolution*, Paris, 1907).

the reader is referred to *I.M.G.*). As characteristic as any is the melody of the Christian hymn which begins

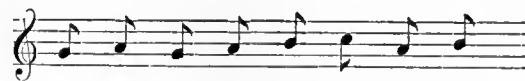

Te lu - cis an - te ter - mi - num,

and concludes



Sis prae - sul et cus - to - di - a.

Another is the Hungarian folk-song: *Nem Szoktam*.



Many French songs have been collected in recent years, of which the following formula, or variations of it, form an essential feature:—



This corresponds closely with the third example given above. That the melodies in question are of great antiquity may be inferred from the fact that they are almost confined to the oldest class of folk-song, that which celebrates May Day and the beginning of spring. M. Tiersot (*La Chanson populaire en France*, Paris, 1889) plausibly finds in them a survival of a melodic fragment, which may have belonged to pagan hymns in honour of spring, basing his supposition upon the fact that the phrase in question occurs in the melody of the Easter hymn "O Filii et Filiae." The medieval Church, acting on principles familiar in all ages, may well have helped to merge a pagan in a Christian festival by adopting, not merely old rites and observances, but the actual melody with which these had for ages been associated. A similar survival in French folk-song is that of the melody of the *Tonus peregrinus*, the chant used for the psalm "When Israel came out of Egypt" (mentioned in the 9th century by Aurelian Réomé as being very old). Its appearance, like that of the Easter hymn, in songs, which on other grounds can be proved to be of great antiquity, points to the probability of its being of popular origin. It also bears equally strong marks of being derived from a recitation formula, as indeed its appropriation for chanting a psalm sufficiently indicates.

Endeavours to detach other primitive formulae from the popular melodies in which they are enshrined form a branch of folk-lore now being actively pursued. It may be hoped that "comparative melody" —if the phrase may be coined—will do for this department of musical knowledge what the science of comparative philology has done for language. Oscar Fleischer (*I.M.G.* i. 1) has endeavoured to trace the history in Europe of the primitive phrases belonging to the melody of "Les Séries" (or *Unus est Deus*) as given by De Villemarqué in *Barzaz-Breiz*

No. 1, in the musical appendix, as also of the opening phrase in the old Christian hymn, "Conditor alme siderum" (attributed to Bishop Ambrose):—



The phrase here belongs to a melody in the Phrygian mode, but when it is used in major melodies its characteristic notes are those of the common chord, with a rise to the sixth at the point of climax, corresponding to the rise in the recitation formulae given above.

By what processes the notes of the common chord became universally established it is not possible to determine, but it may be said in a general way that the reference to a given tonic was felt in all ages to be a necessary condition even of the simplest melody, and that, as the melodic instinct grew, an almost equal necessity was found for a point of contrast, and that this point of contrast became with most nations of Aryan origin the fifth note above the tonic, at any rate in the more popular scales. Coimbarieu (*La Musique*, p. 121) observes that we owe the use of the octave, the fifth and the fourth to the South and East, but that the importance of the third in our modern musical system is due to the instinctive genius of the West and North, *i.e.* to England and Scandinavia (see also Hugo Riemann, *Geschichte der Musiktheorie*, Leipzig, 1898, and Wooldridge, *Oxford History of Music*, i. 161-162, where the well-known quotation from Giraldus Cambriensis, or Gerald Barry, of the 12th century, establishing the fact of part-singing in England, is given). If, as has been shown, the origin of many melodies can be traced to formulae originally used for chanting or reciting, it must not be forgotten that formulae thus derived assume very different characters under the influence of more decided rhythms than that of speech. To accompany bodily movements (which by a natural law become rhythmical when often repeated) with music, vocal or instrumental, is an almost universal human instinct, whether to alleviate the burden or the monotony of labour, as in rowing, sowing, spinning, hammering and a score of other pursuits, or to promote pleasure and excitement, as in the dance.

It is unsafe to infer, as some have done, from the custom, known in all ages, of dancing and singing at the same time, that song arose as a mere accessory to the dance. It is more probable that the dance has its origin in the mimetic actions, which are the natural accompaniment of rudimentary song. At the same time, no one will deny that races with ballads of their own early made use of them for the dance, and that, especially on the rhythmical side, melody owes to the dance an incalculable debt.¹

It may be assumed then that upon some such basis as has been roughly indicated the different nations of the world have developed each their own musical phraseology, emanating from and answering to their several needs and temperaments and that the short melodic phrases, out of which folk-tunes are made, have their roots in a past as distant as that in which the elements of language were formed, and that the popular instinct which through countless ages has diversified those forms and arranged them into melodies, whose constructions are mostly susceptible to analysis, is the same instinct as that which has given to language its grammar and its syntax.

In proceeding now to the actual history of song in Europe, it must be remembered that it is inseparably connected with poetry. Melody till within comparatively recent times continued to fulfil its original function of enhancing the value and expressiveness of language. For poetry of the epic kind with the long lines common to early European peoples, some such forms of chanting as have been indicated must have sufficed.

¹ For the growth of the refrain from communal dancing and singing, see C. J. Sharp, *English Folk-Songs*, p. 93. Nor should the association of dancing with all primitive religious ceremonies be forgotten—see K. J. Freeman, *Schools of Hellas* (1907).

Melody, as we understand it, with compact form and balanced phrases, could only have existed if and when the same qualities appeared in popular poetry. This was probably the case long before the taste for long epic narratives began to disappear in favour of more concise forms of ballad and of lyric. The stanza form must have been generally familiar in the early middle ages from the Latin hymns of the Church, and these hymns themselves are likely to have been formed, in part at any rate, on models which were already known and popular.

We have definite information that in the early middle ages two sorts of popular poetry existed—the historical ballads (descendants of those alluded to by Tacitus in his *Germania* as characteristic of the Germans, and as constituting their only historical records), and popular songs of a character which caused them to be described as *cantica nefaria* by St Augustine; the council of Agde (506) forbade Christians to frequent assemblies where they were sung: St Césaire, bishop of Arles, speaks of the *chants diaboliques* sung by country folk, both men and women; the Council of Châlons menaced the women, who seem to have been the chief offenders, with excommunication and whipping; lastly Charlemagne, whose love for the better class of song is attested by the fact that he ordered a collection of them to be made for his own use, said of the other "canticum turpe et luxuriosum circa ecclesias agere omnino, quod et ubique vitandum est." Beyond the fact of their existence we know nothing of these songs of the early middle ages. Their influence on the popular mind was vigorously resisted, as we have seen, by the Church, and for many centuries efforts were made to supplant them by songs, the subjects of which were taken from the Gospel narratives and the lives of the saints, so that folk-song and church song strove together for popularity. Doubtless the church song borrowed musical elements from its rival: nor was the folk-song uninfluenced in its turn by the traditional music of the Church. In considering this latter music, it is important to distinguish between the melodies adapted to the prose portions of the ritual without definite rhythm, and those of the hymns, where the metre of the Latin verses and their stanza form necessitated a corresponding rhythm and musical form. Rhythm in music, which has its origin and counterpart in the regular bodily movements involved in various departments of labour and in the dance, must, as has already been said, have always been an essential feature of popular melody, and it is reasonable to conclude from its absence in the plain-song, and indeed for many centuries in the compositions of musicians, which had the plain-song for their basis, that these hymns, which represented the popular part of the Church services, were also representative of the popular tastes of the time. In all ages the Church has drawn largely from popular song for the melodies of its hymns. It is moreover in the highest degree improbable that the Church should have been able to evolve out of its inner consciousness, without pre-existing models, a melody—to take a single instance—like that of "Conditor alme siderum"—the survival of which in innumerable European folk-songs has already been alluded to.

Numerous additions to the store of plain-song melodies were made by the monastic composers of the middle ages: the most notable is that of the *Dies Irae*, of which the words are attributed to Thomas de Celano (d. 1250).

Reference should also be made to the music of the liturgical dramas or mysteries, popular in medieval times: *The Lamentation of Rachel*, *The Wise and Foolish Virgins* and *The Prophets of Christ*, are given, both text and music, in Coussemaker's *L'Harmonie au moyen âge*. They reflect the severe style of the plain-song, and were probably intended for cultivated rather than popular audiences. The same is probably true of the secular songs quoted in the same work. These have a special interest as being the earliest specimens of song which have come down to us in Christian times. The best known is the "Complainte," on the death of Charlemagne (quoted in many histories), the dignified, if somewhat dreary, melody of which revolves mostly on the first three notes of a major scale, once rising to the fourth (thus recalling the old recitation formula). Rhythm is practically

absent. On the other hand, the song in honour of Otto III. has definite rhythm and a degree of tunefulness. The "modus Ottino" was a well-known air, which, unlike the rest of those quoted by Coussemaker, was probably of popular origin, for the Latin words do not fit the melody and probably represent a free translation from an original in the vernacular tongue.¹

Modus Ottinc.

Mag - nus Cae - sar Ot - to, quem hic mo - dus
re - fert, in no - mi - ne Ot - tine dic - tus, quadam
noc - te mem - bra su - a dum col - lo - cat Pa - la - ti - um
ca - su su - bi - to in - flam - ma - tur.
(12 more stanzas.)

More remarkable still is a "Chanson de Table" of the 10th century, a really graceful melody, the quotation of which may serve to destroy the illusion that the major scale, so often described as modern, has any other claim to the title than the fact that it has been preserved by modern musicians, while others have been discarded.

Jam, dul - cis a - mi - ca, ve - ni - to, quam si - cut cor
me - um di - li - go; In - tra in cu - bi - cu - lum
me - um, or - na - men - tis cunc - tis or - na - tum.

In the same collection may be found, beside other historical songs, two odes of Boethius and two odes of Horace, set to music;² but whether the melodies given represent medieval or Roman music, corrupted or not, it is impossible to determine. These songs have been dwelt upon, for they not only represent some kinds of music that were sung in the 9th and 10th centuries, but indicate the sources from which later on the work of the troubadours was derived. They may be summed up as a church-song and folk-song, and the songs by more or less cultured persons made after these models. For the subsequent history of the art the folk-song represents by far the most potent influence, but the melodies quoted by Coussemaker which might be regarded as the works of the popular instinct afford insufficient data for safe generalization. More direct evidence is to be found in the 12th-century pastoral play—*Le Jeu de Robin et de Marion*, till within recent years considered as the work of Adam de la Hale, but since the able criticisms of M. Tiersot in the work referred to above, likely henceforth to be regarded as

¹ This melody, which is plainly derived from recitation, with *A as tonus carrens*, closely resembles that of Ljómur, a folk-song of the Faeroe islanders, noted by H. Thuren in 1902 and identified by him with a piece of recitation ("Fili car") from a 12th-century "Drame liturgique" (deciphered by O. Fleischer, *Neumenstudien*, Bd. II. p. 23). See *Folklesangen paa Farøerne*, H. Thuren (Copenhagen, 1908). Identity of style between a popular song of the 9th century, a *drame liturgique* of the 12th and a folk-song still sung in the 20th is sufficiently striking—especially in view of the fact that in the Faeroe Islands instrumental music is practically unknown.

² Lord Ashburnham has a Virgil of the 10th century, "dans lequel les discours directs de l'Eneide sont accompagnés de notations musicales" (Coussemaker).

the oldest collection of folk-songs in existence; for the original compositions which Maître Adam has bequeathed to posterity preclude us from believing that he could have originated the dainty airs contained in that play, of which *Robin m'aime* is generally familiar, and is still to be heard on the lips of peasants in the north of France (see Tiersot, p. 424, n.). If M. Tiersot's view is correct, the melodies in *Robin et Marion* may be taken to represent the popular style of an epoch considerably anterior to the date of the play itself (though allowance must be made for the correcting hand of a professional musician) which is our excuse for introducing them at this place.

Before speaking of the songs of troubadours, trouvères and minnesingers, allusion must be made to a class of men who played a part the importance of which both in the social and political life of the middle ages is attested by innumerable chroniclers and poets, viz. the skalds, bards or minstrels—the chief depositories of the musical and poetical traditions of the several countries to which they belonged. They varied greatly in rank. Some were attached to the retinue of kings and nobles, whilst others catered for the ear of the peasantry (eventually to be classed with jugglers, acrobats, bearwards and the like, sharing the unenviable reputation which attached to these representatives of popular medieval amusements). That these latter were also welcome at the halls of the great, is an established fact, which may serve as a reminder that in feudal times the distinction that now exists between the music of the cultivated classes and of the peasantry was but slight. The style of the church music was as universally familiar as the style of the folk-song. For musicians, both of high and low degree, no other models existed. This fact is patently clear when the songs of the troubadours, trouvères and minnesingers are studied. Those minstrels continued the traditions of the better class of their predecessors, with strivings after a more polished, elaborate and artistic style. In forming their style upon an admixture of folk-song and church-song they in fact assimilated neither, and created a mongrel product without real vitality—a product that left practically no mark upon the subsequent development of the art. The astonishing skill which they exhibited in adapting the language of poetry to the most complicated metrical forms deserted them when they touched the question of musical form and of melody. Indeed their music, except in rare instances, was an adornment which the poetry could have dispensed with, and may be regarded in the main simply as a concession to the immemorial custom of treating music and poetry as inseparable arts.

The real importance of these courtly minstrels in the history of song consists in their having firmly established the rhyming stanza as the vehicle for the expression of lyrical feeling, for with the rhyming stanza a corresponding compact and symmetrical melodic form was bound to come. It was, however, reserved for the popular instinct, and not for trouvères and minnesingers, to develop this form (it is probable too that some at least of the stanza forms employed belonged first to popular poetry and were afterwards developed and elaborated by these musicians of the great houses). The scheme upon which the lyrical stanza was usually based was one in which two similar parts (called by the German *Meistersingers*, *Stollen* or props, and constituting the *Aufgesang* or opening song) were followed by an independent third part, the length of which was not prescribed (called *Abgesang* or concluding song). The complete stanza was called *Lied* and was knit together by different schemes of rhyme. For the first part the trouvères and *Meistersingers* were content with some simple phrase, often borrowed direct from the folk-song, repeating it, as was natural, for the exactly similar second part: then for the third the style was apt to change towards the ecclesiastical and to wander aimlessly on to an unconvincing conclusion. The popular instinct was finer, for we find in innumerable folk-songs, belonging to the 14th and 15th centuries, that the greater length of the *Abgesang* was seized upon as an opportunity, not merely for introducing fresh material, after the repetition of the phrase attached to the two *Stollen*, but also for a return to that phrase,

or some reminiscence or variation of it, by way of conclusion, thus producing a compact form, answering to the natural requirements of the artistic sense. Thus the favourite scheme of the troubadours, which may be represented as AAB, had developed in the folk-song into the scheme AABA—and this scheme has served for thousands of popular melodies throughout Europe. In some rare cases the contrasting portion might be conceived as implying modulation into the key of the dominant, thus foreshadowing the form of the first movement in modern sonatas and symphonies.¹ But the present writer is sceptical, from the evidence afforded by folk-song melodies recently collected, of an instinct for modulation among a peasantry unfamiliar with harmonic music. Be that as it may, the courtly minstrels both of France and Germany rendered a real service to music in following the popular verdict in favour of the major scale or Ionian mode, and in so doing prepared the way for modern harmony, which is based upon a particular relationship of contrast between the notes composing the chord of the tonic and those composing the chords of the dominant and the sub-dominant—a relationship inherent in no other scale of the Gregorian system but the Ionian. On it the secret of musical form in the modern sense depends, for it brings with it the power of modulation (unknown to medieval times), *i.e.* the power of treating the same note as belonging to different tone centres (G, for instance, as the dominant of the scale of C, and also as the tonic of the scale of G), and the further power, by means of the chord of the dominant seventh, of proceeding from one tone centre to another. As long then as musicians held the Ionian scale at arm's length, progress in the modern direction was impossible. They did indeed arrive eventually at the goal, partly through the practice of using popular melodies as the foundation, or *canto fermo*, of masses and motets, and of arranging the melodies themselves for choirs of voices, and also through the increasing need, as the art of part-writing became more elaborate and better understood, of modifying the strict character of the modes by the introduction of accidentals, till, as Sir Hubert Parry remarks, "after centuries of gradual and cautious progress they ultimately completed a scale which they had known all along, but had rather looked down upon as an inferior specimen of its kind." The melodic instinct, thus developing consciously in the minds of trained musicians, and unconsciously in the makers of folk-songs, arrived eventually at the same result. But the major scale once firmly established, the trained musician based upon it a new art of harmony; further, he modified existing minor scales for harmonic purposes, leaving the old traditional scales as the almost exclusive possession of the folk-song (which has cherished and preserved them in their pristine integrity up to the present day) and working out the problem of musical composition, and of melody itself, on a new foundation.²

The fall of the Hohenstaufen dynasty, and the troublous times that ensued in Europe, involved the removal of the patronage to which the higher kinds of minstrelsy owed their position and their influence. Song passed with the close of the age of chivalry from the noble to the burgher class. The *Minnesingers* were succeeded by the *Meistersingers*, the first guild of whom is said to have been established in 1311 by Heinrich von Meissen (popularly known as Frauenlob) at Mainz. In their hands song was treated more in the spirit of a trade than an art, and subjected to many absurd and pedantic regulations. In Wagner's famous opera is given a very accurate and faithful

¹For examples see Böhme, *Altdeutsches Liederbuch*, Nos. 131 and 195.

²Modal folk-song melodies are often tested by their conformity or otherwise to the modes as known from medieval composers. This is to limit our conception of natural forces by the use made of them by a few men at a particular epoch for special purposes. If a mode can be said to exist for a purpose, that purpose is melody: to apply to modal folk-melodies the canons laid down by composers with whom melody was a *quantité négligeable* is sheer perversity. Recent discoveries in the field of folk-song place us in a far better position for understanding the true nature of the modes than medieval composers: for in the folk-song their free development has not been hampered by restrictions, which were a necessary condition of polyphonic work.

picture of their methods and ideals. Their importance in the history of song consists not so much in actual work achieved as in the enthusiasm widely spread through their means in the class from which most of the great German composers were eventually to spring.

The real interest for the historian of song centres during this period not in the attempts of minstrels and burgher guilds to improve upon the folk-song, but in the folk-song itself. Those who have studied the large collection of medieval melodies contained in Böhme's *Altdeutsches Liederbuch* for Germany, and in Duyse's *Het oude Nederlandshe Lied* for the Netherlands, will on other grounds than those mentioned above be ready to confirm this judgment. It is not too much to say that they contain many of the noblest melodies which the world possesses, earnest and dignified in spirit, broad of outline, and knit together in all their parts with rare and unconscious art, on principles of structure which are carefully analysed in the chapter on folk-song in Sir Hubert Parry's *The Art of Music*. To the examples there quoted may be added the wonderful *Tagelied* ("Der Dag wil nict verborghen sin"), *Ik sek adieu*, *Lieblieh hab sich gesellet*, *Abschied von Innsbruck* (of which both Bach and Mozart are reported to have said that they would rather have been the author than of any of their own compositions), and "Entlaubet ist der Walde" (which, like so many of the popular songs of the 14th and 15th centuries, was utilized by the Reformers for one of their finest hymns).

A characteristic feature of many of these songs, both German and Dutch, is the *melisma*, or vocal flourish, of the concluding phrase, derived, if German historians are to be trusted, from the vocalization on the last syllable of the word Alleluia, which in the early Church represented the congregational portion of its services and which afterwards developed into the sequences, so popular in the middle ages.

A similar feature is not uncommon in French melodies of the same period (see *L'Amour de moi*, *Vrai Dieu d'amour*, and *Réveillez-vous*, *Piccars*, in *Chansons du xv^e siècle*, by Gaston Paris and Gevaert, Paris, 1875). If the charming English song "The Nightingale" (Medieval and Plainsong Society) is of popular origin, it may serve as an indication that these melismata were also common in England (cf. also "Ah! the sighs that come from my heart," which belongs to the reign of Henry VIII.).

It is in the highest degree unfortunate that no collections were made of English popular songs of the middle ages: everything points to the fact that quantities of them existed. The importance of song in the social life of every class is attested by all the chroniclers and poets. An age that produced "Sumer is a cumyn in" (1240) must have been prolific of melody. It is impossible to regard it as an isolated phenomenon. The beauty of songs by early composers, and of others, which are possibly of popular origin, met with in the reigns of Henry VII., Henry VIII., Edward VI. and Elizabeth (see Wooldridge's edition of Chappell's *Popular Music of the Olden Time*) argue a great and healthy activity in the preceding centuries. It is sufficient to mention Morley's "It was a lover and his lass" and "O Mistress mine," or "The Three Ravens," which though it first appeared in print in 1611 is undoubtedly a folk-song belonging to a much earlier period (for versions still to be heard see Kidson's *Traditional Times*). The same is probably true of "A poor soul sat sighing" and many others. It is to be remarked, however, that printed versions of popular songs can seldom be relied upon as faithfully representing their original form, or even the form in which they were sung at a particular epoch. Editors have seldom resisted the temptation of tampering with popular airs, if by so doing they can render them more attractive to polite tastes. Within recent years, however, the collection and publication of folk-songs has been undertaken in a different spirit—and it is possible in most countries to study the folk-songs in versions which have been taken direct from the lips of the peasantry and are presented without editorial alterations. The question as to the propriety of such alterations, or the larger question of what is suitable in the way of

instrumental accompaniment, need not be discussed here more than to point out that the strictly scientific point of view—which seeks to understand the folk-song in its native simplicity—should not be mixed up with that of the artist who aims at adding to the world's store of beautiful music.

It is to be deplored that the English composers of the 15th and 16th centuries did not follow the example of Dutch, German and French musicians, who utilized popular melodies as the foundation or *canto fermo* of their masses and motets (one example only is known, "O Westron Wynde") and also arrange them in parts for music-loving circles (to a limited extent this appears to have been done in England, e.g. the Freeman's Songs in *Deuteromela*). But in England, as in other European countries, survivals of medieval melodies are still to be found among the peasantry in quantities which vary according to the degree in which modern music has penetrated to country districts. In Germany, for instance, where musical culture has been most widely spread, the medieval folk-song, according to Herr Böhme, is no longer heard; it is possible, however, that this statement may be contradicted or modified, if the same systematic search for the Germanic folk-song, which has been made recently in France, England and elsewhere, is undertaken before it is too late. Melodies formed by composers under the principles of modern harmonic music have largely usurped their place.¹

The folk-song is eventually killed by the products of the musical manufactories of the town. The peasantry provided with songs from outside is relieved from the necessity of providing for its own needs, or of cherishing with the love of earlier times its own traditional inheritance. It is true that for many centuries numbers of composed songs have found their way into the popular repertory and have there undergone in many instances transformations which serve as a complete disguise to their real origin: but in general a fine ear can detect these intruders. For even when they have suffered change or transformation in passing through a new environment the stamp of an individual or a period remains, whereas the folk-song of tradition is the work not of one age, but of many, not of the individual, but the collective mind. For songs made by uncultivated persons, and passed on to others without the aid of writing or of printing, soon lose in the course of oral transmission even such traces of individual authorship as they may once have possessed. Moreover the makers of folk-songs are concerned with nothing so little as the assertion of their own individuality. They know that it is the most familiar that is the most acceptable. Novelty has no charms for themselves or their audiences. Instinct as well as policy keep them to recognized types and formulae; and the innumerable variations which these undergo from age to age are probably far more frequently due to lapses of memory than to capacity for invention. Major tunes inadvertently sung in minor modes, or vice versa, or the accidental application of a tune to verses, for which it was not originally intended, give rise in many cases to practically new melodies. Though an author might be named, if it were possible to know the history of a folk-melody, for each change that it has assumed in the course of its history, it is clear that authorship of this kind is not what we mean when we name Dibdin as the author of "Tom Bowling." The theory that the folk-song is but the degenerate offspring of a cultivated ancestry, that the peasantry have, in fact, taken their music from a superior class, and transformed it to suit their own tastes and idioms, has been and is still held apparently by many (see Closson, *Chansons populaires belges*; and Combarieu, *La Musique*, p. 114). This is tantamount to the assumption that the presence among songs of the

peasantry of beautiful melodies involves pre-existing musical civilization, and that the popular instinct is incapable, without cultivation, of creating melodies that are artistically beautiful. It would be difficult to support this assumption in the case of the German and Dutch medieval songs, to which reference has been made; the cases that could be cited, in which well-known airs of the town have passed to the country and suffered transformation, are insufficient data for establishing a general rule as to the origin of folk-songs. Indeed, the very fact of such transformation tends to prove the existence of a strictly popular music, into whose idiom the town music is transformed. To deny that uncultivated peasants can create melody is to forget that the languages even of savages have their grammar and syntax, as well as qualities that are rhythmical and musical, and that even among civilized people those same qualities existed long before they were analysed and tabulated by grammarians, and further developed by trained literary men. The case of melody is strictly analogous to that of languages.

As every country has its own store of folk-songs in which national characteristics find expression through idioms which differentiate its songs from those of other countries, it would be arbitrary to select the songs of one country rather than those of another for separate discussion.

The history of the art-song has now to be considered, of solo song, that is, with instrumental accompaniment as an essential part. Songs for two or more voices with or without accompaniment, though they properly belong to the subject of this article, are passed over, for they but exhibit the tendencies manifested in solo song when applied to more complicated forms. Operatic songs and arias are likewise omitted (except in the early Italian period), as belonging to a branch of music which requires separate treatment (see ARIA; OPERA). Instrumental song arose during the 16th century, a time in which composers, released by the spirit of the Renaissance from the exclusive service of the Church, were already becoming active in secular directions. The madrigal was the favourite form of composition and was rapidly approaching its period of maturity: it was now to be superseded as the popular diversion of cultivated society by solo song. The habit had already sprung up of supplying voices that might be missing in a madrigal by instruments: if all the voices but one were absent, the effect of a solo with instrumental accompaniment was realized. A still nearer approach to solo song was made when singers, selecting one part of a madrigal for the voice, themselves played the rest on lute or *chitarra*. In such performances the voice part was likely to receive most attention—even in madrigal-singing it was not unknown for the soprano to embroider her part with *gruppetti* and ornamental passages (see Kiesewetter's *Schicksale u. Beschaffenheit des Weltlichen Gesanges*, p. 72, for an example of a simple part as embellished by the well-known Signora Vittoria Archilei)—and the accompaniment to undergo processes of simplification, thus preparing the way for melodies, simple or ornate, with unobtrusive accompaniments, and perhaps also contributing to the invention of that declamatory or recitative style, attributed to Cavalieri, Peri and Caccini, the founders of oratorio and opera. Such melodies are found in Caccini's famous *Nuove Musiche*, published in Venice in 1601 ("Peri Selvaggi" may serve as a beautiful specimen of simple melody; "Cor mio" is typical of the ornate style, "Deh! dove son fuggite" of the declamatory: the last two are quoted in Kiesewetter, *Geschichte und Beschaffenheit des Weltlichen Gesanges*, p. 73). Caccini claimed in the preface to that work to be the first to invent songs "for a single voice to the accompaniment of a simple instrument." It is true that his friends in Rome (his native city), at whose houses these new compositions were performed, assured him that they had never heard the like before, and that his style exhibited possibilities for the expression of feeling, that were excluded, when the voice sang merely one part in a contrapuntal work. But, about thirty years before Caccini, lutenists in France had anticipated his innovations, and composed solo songs, with lute accompaniments, in which is evidenced the struggle, not always successful,

¹ The error must be guarded against of supposing that melodies, heard to-day among the peasantry, which suggest medieval times, are necessarily medieval in origin. It has been already indicated that dorian, aeolian and mixolydian modes (to name those which are most prevalent) are natural modes, not church modes; they are still employed by folk-singers in many parts of Europe. A melody in the modern major scale is just as liable at the present day to submit to transformation into the mixolydian or some other mode, as melodies in other modes are liable to become major.

The
Art-Song.

to break away from polyphonic traditions. Le Roy's *Airs de Cour*, published in 1571, may be cited in proof of this statement. Of these airs "Je suis amour" is somewhat in the declamatory recitative style of Caccini's *Nuove musiche* (see *Sammelbände, Int. Musik Gesellschaft*, article "Airs de Cour of Adrien le Roy," by Janet Dodge). Generally speaking, it may be said of early French songs that they were longer in shaking off the influence of the past than the songs of the Italians, many tricks of expressions, belonging to polyphonic times, surviving both in voice parts and accompaniments. In the voice parts sometimes the influence of popular song is evident, at others they are neither melodious nor yet declamatory, but merely suggest a single part in a polyphonic composition, while the accompaniments for the lute are generally a mixture of chords used with harmonic effects, and certain polyphonic tricks inherited from the past two centuries. In England two books of "Ayres," for a single voice with lute accompaniment, one by Jones, and another by Campion and Rosseter, were published in 1601; Jones in his preface claims that his songs were the first of the kind, and Rosseter says that those of Campion had been for some time "privately imparted to his friends." Both sets therefore seem to be independent of Caccini's *Nuove musiche*, the influence of which was not felt for some years. In England the break with the past was less violent and sudden than in Italy; for the established practice of arranging popular songs and dances as lute solos led naturally to, and profoundly influenced, the later "ayres" with lute accompaniment. As Dr Walker remarks (*History of Music in England*, p. 121, Clarendon Press, 1907), "A folk-song of 1500, a song of Thomas Campion and a song of Henry Lawes are all bound together by a clear and strong tie." In a simple and unpretentious way these first English attempts at solo-song were singularly successful. The best of them, such as Rosseter's "And would you see my Mistress' face?" and Campion's "Shall I come if I swim?" rank as masterpieces of their kind. Both in structure and in feeling they exactly catch the essentials of the lyrics of the period. Their daintiness and charm make it easy to forgive an air of artificiality, which was after all inevitable—if the songs were to represent the spirit of their environment.¹

Meanwhile Italian composers, who, in spite of the frottole, villote, villanelle, balletti and falalas (arrangements in vocal parts of popular melodies common in the last half of the 16th century) seem to have been unaffected in the new song movement by popular influences, went straight from the polyphonic to the recitative style, and advanced with extraordinary rapidity. Melody was quickly added to relieve the monotony of recitative which must have been acutely felt by the hearers of the early operas, and considerable advance in this direction was made by Cavalli and Cesti (see *Oxford History of Music*, vol. iii., for details of their methods). Monteverde, though a greater genius than either of them, did not succeed in forcing the daring qualities of his own conceptions on others. The famous lament of Ariadne was the expression of an individual genius casting all rules aside for the sake of poignant emotional effect rather than the beginning of a new epoch in song. Carissimi and Rossi in oratorio and cantata (a word which then merely described a piece that was sung, as sonata a piece that was played, and consisted generally of alternate recitative and aria) brought the organization of melody to a high degree of elaboration, far beyond anything attempted by Cavalli and Cesti. In their hands the declamatory methods of Monteverde were made subordinate to larger purposes of design. A broad and general characterization

¹ John Dowland, the chief of English lutenists, published his first book of songs and ayres in four parts in 1597, "So made that all the parts together or either of them severally may be sung to the lute, orpherion or viol da gamba." Though not strictly speaking solo-songs they are too important not to be mentioned. Three other books followed in 1600, 1603 and 1612, in the second of which appears the famous "Flow my tears" (*Lachrymae*) for two voices, but almost equally effective as a solo, and doubtless often used as such. It is published in vol. vii. of *Euterpe* (Breitkopf & Härtel, London), which also contains a valuable monograph on English lutenists and lute music by Miss Janet Dodge. Dowland's few solo-songs are unimportant.

of emotional situations was more natural to them and to their successors than a treatment in which points are emphasized in detail. It was moreover inevitable in these early developments of musical style, in which melody had to play the leading part, that such sacrifices as were necessary in balancing the rival claims of expression and form should be in favour of the latter rather than the former. But the formal perfection of melody was not the only problem which 17th-century Italian composers had to face. The whole question of instrumental accompaniment had to be worked out; the nature and capacities of instruments, including the voice itself, had to be explored; the reconciliation of the new art of harmony with the old art of counterpoint to be effected. It speaks volumes for the innate musical sense and technical skill of the early Italian composers that the initial stage of tentative effort passed so quickly, and that at the close of the 17th century we are conscious of breathing an atmosphere not of experimental work, but of mature art. Alessandro Scarlatti (1659-1725) sums up the period for Italy. That much of his work is dry, a mere exhibition of consummate technical skill without inspiration, is not surprising when the quantity of it is realized, and also the unfavourable conditions under which operatic composers had to work, but the best of it is singularly noble in conception and perfect in design. The same is true of the best work of Legrenzi, Stradella, Caldara, Leonardo Leo, Durante, work which was of incalculable importance for the development of musical, and particularly of vocal, art, and which will always, for minds attuned to its atmosphere of classical intellectuality, severity and self-restraint, possess an abiding charm: but comparatively few specimens have retained the affections of the world at large. Carissimi's "Vittoria," Scarlatti's "O Cessate" and "Le Violette" are the most notable exceptions ("Pietà Signore" is not included, as no one now attributes it to Stradella).

The almost universal preference of the Italians in the 17th and 18th centuries for the aria in *da capo* form involved serious sacrifices on the dramatic and emotional side: for although this form was but an elaboration of the folk-song type, *ABA*, yet it involved, as the folk-song type did not, the repetition note merely of the melody of the opening part, but of the words attached to it. It is this double repetition which from the point of view of dramatic sincerity forms so disturbing an element. But composers, as has been remarked, were too much occupied with exploring the formal possibilities of melody to establish a really intimate connexion between music and text (Monteverde being a notable exception), a detailed interpretation of which lay outside their scheme of song. Elaboration of melody soon came to involve much repetition of words, and this was not felt as an absurdity so long as the music was broadly in accord with the atmosphere or situation required. A few lines of poetry were thought sufficient for a fully developed aria. Exceptions are however to be found in what is known as the *recitativo arioso*—of which remarkably fine specimens appear in some of Scarlatti's cantatas—and in occasional songs in slighter form than the tyrannous *da capo* aria, such as Caldara's "Come raggio di sol"—which foreshadows with its dignified and expressive harmonies the Schubertian treatment of song.

Before Scarlatti's death in 1725 symptoms of decline had appeared. He was himself often compelled to sacrifice his finer instincts to the popular demand for mere vocal display. A race of singers, who were *virtuosi* rather than artists, dominated the taste of the public, and forced composers to furnish opportunities in each rôle for a full display of their powers. An opera was expected to provide for each favourite five kinds of aria! (*aria cantabile*, *aria di portamento*, *aria di mezzo carattere*, *aria parlante* and *aria d' agilità*). It was not long before easier and more obvious types of melody, expressing easier and more obvious feelings, became the fashion. The varied forms of accompaniment, in which a good contrapuntal bass had been a conspicuous feature, were wasted upon a public which came to hear vocalists, not music; and stereotyped figures, of the kind which second-rate art after the first half of the 18th century has made only too familiar, took the place of sound contrapuntal workmanship,

till the Italian school, which had stood as a model for the world, became identified with all that was trivial, insipid, conventional, melodramatic. Not that the Italian tendency in the direction of mere tunefulness was in itself either unhealthy or unworthy. It was indeed a necessary reaction from the severe earlier style, as soon as that style began to lose its earnestness and sincerity, and to pass into cold and calculating formalism. But the spirit of shallowness and frivolity which accompanied the reaction involved the transference of musical supremacy from Italy to Germany, the only country, which, while accepting what was necessary to it of Italian influences, steadily remained true to its own ideals.

Before speaking of German song, it is necessary to glance at what was being done outside of Italy in the 17th century. Reference has already been made to the French as pioneers in establishing solo song to lute accompaniment, which here, as in Italy, originated in adaptations of polyphonic compositions. But in France from the first the main influence was derived from popular sources, the native folk-song and the vaudeville, the ditties of country and of town. In both that union of grace, simplicity and charm, characteristic of the French nation, tended to produce an art of dainty unpretentious attractiveness, in strong contrast to the serious and elaborate Italian work. It preserved these characteristics in spite of the artificial atmosphere of the French court, in which it mainly flourished up to the time of the Revolution, in spite too of the somewhat different influences which might have been expected to affect it, derived from opera, the mania for which did not, as in Italy, kill the smaller branch of vocal music. Brunettes, musettes, minuets, vaudevilles, bergerettes, pastourelles, as the *airs de cour* were styled according to the nature of the poetry to which they were attached, may be found in Weckerlin's *Échos du temps passé*, but the reader must beware of judging the real character of these songs from that which they assume under the hands of the modern arranger.

With the latter part of the 18th century came in the languid and sentimental romance, in which the weaker phases of Italian melody are felt as an enervating influence. The romance became after the Revolution the most popular form of polite song, leading by degrees to that purely melodious type of which Gounod may be considered the best representative, and which other composers, such as Godard, Massenet, Widor, have been for the most part content to follow and develop, leaving to more adventurous spirits the excitement of exploring less obviously accessible regions.

In England, as in France and Italy, the beginning of the 17th century brought into existence solo song. Its beginnings have already been alluded to in speaking of the songs of Rosseter, Jones, Campion and Dowland. The work of H. Lawes, and his contemporaries, William Lawes, Coleman and Wilson, was equally unpretentious and simple. A gem here and there, such as "Gather ye Rosebuds" (W. Lawes), is the student's reward for a mass of uninspired, though not ungraceful, work in which is to be noted an attempt to come to closer quarters with poetry, by "following as closely as they could the rhythmical outlines of non-musical speech: they listened to their poet friends reciting their own verses and then tried to produce artificially exact imitations in musical notes" (Ernest Walker, *History of Music in England*, p. 130), producing what was neither good melody nor good declamation. Such tentative work, in spite of Milton's sonnet to H. Lawes, could only have a passing vogue, especially with a Purcell so near at hand to show the world the difference between talent and genius, between amateurish effort and the realized conceptions of a master of his craft. Songs like "Let the dreadful Engines" and "Mad Bess of Bedlam" reach a level of dramatic intensity and declamatory power, which is not surpassed by the best work of contemporary Italian composers. "I attempt from love's sickness to fly" is so familiar in its quiet beauty that we are apt to forget that melodies so perfectly proportioned were quite new to English art (though Dr Blow's "The Self-banished" deserves fully to stand with it side by side). Monteverde's

"Lament of Ariadne" has already been alluded to. It is interesting to contrast its emotional force, obtained by daring defiance of rule, with the equally intense, but more sublime pathos of Purcell's "Lament of Dido," in which song a ground bass is used throughout. The "Elegy on the death of Mr John Playford" (quoted in full by Dr Walker, p. 176 of his history) exhibits the same feature and the same mastery of treatment. The "Morning Hymn" is scarcely less remarkable, and has likewise a ground bass. Purcell died in 1695; Bach and Handel were then but ten years old, and Scarlatti had still thirty years to live—facts of which the significance may be left to speak for itself.

It is among the ironies of musical history that so great a beginning was not followed up. There are echoes of Purcell in the generation that succeeded him, in Croft, Greene, Boyce and Arne: but they quickly died away. The genius of Handel first and of Mendelssohn later seem to have prevented Englishmen from thinking musically for themselves. At least this is the orthodox explanation: but it should be borne in mind that a list of English composers, who have been willing to sacrifice ease and prosperity to a life of devotion to artistic ideals, would be exceedingly difficult to draw up and would certainly not include many of the best-known names. From the death of Purcell to the Victorian era there is no consistent development of artistic song that is worth recording in detail. The only songs that have survived are of the melodious order; of these Arne contributes several that are still acceptable for an air of freshness and gracefulness which marks them as his own. "Where the Bee sucks" and "Blow, blow, thou Winter Wind" are typical of his style at its best, as "The Soldier tired of War's Alarms" is typical of it at its worst. Song writers that followed him, Shield, Hook, Dibdin, Storace, Horn, Linley (the elder) and Bishop, were all prolific melodists, who have each left a certain number of popular songs by which their names are remembered, and which are still pleasant enough to be heard occasionally; but there is no attempt to advance in any new direction, no hint that song could have any other mission than to gratify the public taste for tuneful melodies allied to whatever poetry—pastoral, bacchanalian, patriotic or sentimental—lay readiest to hand.

The musical genius of Germany, which has created for the world the highest forms as yet known of symphony, oratorio and opera, is not less remarkable as the originator of the *Lied*—the term by which are most easily conveyed the modern conceptions of ideal song. German Progress. Germany is moreover the only country in which in orderly and progressive development the art of song may be traced from the simple medieval *Volkslied* to the elaborate productions of Schubert, Schumann and Brahms. If Germany is united to the rest of Europe in her debt to Italy, still her final conceptions of song belong to herself alone. And these conceptions have more profoundly influenced the rest of Europe than any Italian conception ever influenced Germany. When the rest of Europe was content with the rapid outpourings of Italian and pseudo-Italian puerilities, an acute observer could have read the signs in Germany, from which the advent of a Schubert might have been foretold. The student therefore is more profitably employed in studying the phases of song-development in Germany than in any other country. German ideals and German methods of technique have permeated the best modern song-work of countries differing as widely in idiom as Russia, Norway, France and England.

It is not necessary to dwell, except in very general terms, upon German song of the 17th century. There had been no development corresponding with that which produced the *airs de cour* of France and the ayres of England. The very literature necessary for such development was wanting. Indeed German art was too profoundly affected by the spirit which produced the Reformation to develop freely in secular directions. Even in the domain of the *Volkslied* the sacred songs can scarcely have been less numerous than the secular; and at the Reformation adaptations of secular airs to sacred words constituted

borrowings on a very large scale. In the 17th century the work of the Italian monodists was bound eventually to stimulate German composers to make songs, but their main interest lay in larger choral-instrumental works, in which solo songs naturally appear, not in song as an independent branch of art. A good general view of such isolated songs as appeared can be obtained from Reimann's collections *Das deutsche geistliche Lied* and *Das deutsche Lied* (Simrock). In spite of some stiffness and awkwardness, these 17th-century songs exhibit a loftiness of aim, a touching earnestness and sincerity, which mark them off as quite distinct from any work done elsewhere at the same time. On the other hand there is not that sure grasp of their material, nor the melodic and declamatory power, which make Purcell in England stand out pre-eminently as the greatest song composer of the 17th century. The treatment of the aria by Bach and Handel is discussed in separate articles (see ARIA; BACH; HANDEL), which render unnecessary any further comment here. Nor need we pause to consider the vastly inferior work of lesser composers such as Telemann, Marpurg and Agricola, most of which is confined to opera, oratorio and cantata. Our concern is rather with the smaller lyrical forms, and to these the absence of suitable poetry was for long an insurmountable barrier. It was not till the middle of the 18th century that the reform in German poetry associated with the name of Martin Opitz (who translated Rinuccini's text of *Dafne*, J. Peri's first opera, for Heinrich Schütz) bore real fruit.

At the outset it is necessary to make a broad distinction between the more distinctly popular form of song, known as the *Volkstümliches Lied*, in which the same music served for each stanza of a poem (as in the *Volklied* itself, on which the *Volkstümliches Lied* was modelled), and the *Kunstlied*, or, to adopt the more descriptive term, the *durch-componirtes Lied*, in which the music forms a running commentary on a poem, without respect to its form—or, if stanza form is preserved, varying the music in some stanzas or in all in accordance with their poetical significance. Generally speaking the former aims at a wider audience than the *Kunstlied*, the appreciation of which, when it is worth appreciating, involves some degree of culture and intelligence, inasmuch as it aims as a rule at interpreting more complex and difficult kinds of poetry. In the 18th century the simpler *Volkstümliches Lied* in strophic form was most in favour, and those who care to trace its history in the hands of popular composers like J. A. Hiller, J. A. P. Schulz, Reichardt, Berger and Zelter, can easily do so by consulting Härtel's *Liederlexicon* (Leipzig, 1867) or one of a number of similar publications. Side by side with the outpouring of somewhat obvious and sentimental melodiousness, which such volumes reveal, it must be remembered that the attention of greater men to instrumental composition, the growing power to compose for keyed instruments (which began to replace the lute in the middle of the 17th century), and the mechanical improvements, through which spinet, clavichord and harpsichord were advancing toward the modern pianoforte, were preparing the way for the modern *Lied*, in which the pianoforte accompaniment was to play an increasingly important part. C. P. E. Bach (d. 1788) alone of his contemporaries gave serious attention to lyrical song, selecting the best poetry he could get hold of, and aspiring to something beyond merely tuneful melody. The real outburst of song had to wait for the inspiration which came with Goethe and Schiller.

It is unfortunate that Haydn and Mozart, pre-eminently endowed with every gift that makes for perfect song except that of literary discernment, should have left us so little of real value. There is indeed much to admire in some of Haydn's canzonets, of which "My Mother bids me bind my Hair" fully deserves its continued popularity, while Mozart's "Schlafe mein Prinzchen"—if it is Mozart's—and a few others, like these in simple strophic form, are isolated treasures which we could not afford to lose. But in only two songs by Mozart, "Abendempfindung" and "Das Veilchen," is the goal, to which the art was to advance, clearly discerned and in the latter case perfectly attained. Both are *durchcomponirt*, that is, they

follow the words in detail; in both the general spirit, as well as each isolated point of beauty in the verses, is seized and portrayed with unerring insight. "Abendempfindung" is indeed seriously marred by some carelessness in accentuation (worse examples may be seen in "An Chloe") and by annoying repetition of words, due to the development of the melody into a formal and effective climax. In the process the balance of the poem is destroyed, and the atmosphere of suffused warmth and tenderness, which pervades the rest of the song, is almost lost. The lyrical mood passes into one in which the operatic aria is suggested on the one hand, and on the other the formality of instrumental methods of developing melody. Not till Schubert were these traditions, fatal to the pure lyric, finally overthrown, and the conditions of true union between music and poetry perfectly realized. In "Das Veilchen" however, where Mozart touched a poem that was worthy of his genius and appealed to his extraordinarily fine dramatic instinct, he produced a masterpiece—rightly regarded as the first perfect specimen of the *durch-componirtes Lied*. Every incident in the flower's story is minutely followed, with a detailed pictorial and dramatic treatment (involving several changes of key, contrasts between major and minor, variations of rhythm and melody, declamatory or recitative passages) which was quite new to the art. The accompaniment too takes its full share, illustrating each incident with exquisite fancy, delicacy and discretion—and all with no violence done to the form of the poem.

With Beethoven song was suddenly exalted to a place among the highest branches of composition. Taken in hand with the utmost seriousness by the greatest musician of the age and associated by him for the most part with lyrical poetry of a high order, it could at last raise its head, and, freed from the conventional formalities of the salon, look a larger world confidently in the face. It cannot, however, be admitted that Beethoven, in spite of several noble songs, was an ideal song composer. His genius moved more easily in the field of abstract music. The forms of poetry were to him rather a hindrance than a help. His tendency is to press into his melodies more meaning than the words will bear. The very qualities in fact which make his instrumental melodies so inspiring tell against his songs. Though his stronger critical instinct kept him as a rule from the false accentuation which marred some of the work of Haydn and Mozart, yet, like them, he often failed to escape from the instrumentalist's point of view, especially in the larger song-forms. The concluding melody of "Busslied" would be equally effective played as a violin solo: the same might be said of the final movements of "Adelaide" and of the otherwise noble cycle "An die ferne Geliebte"—movements in which the words have to adapt themselves as well as they can to the exigencies of thematic development, and to submit to several displacements and tiresome repetitions. In songs of a solemn or deeply emotional nature Beethoven is at his best, as in that cycle, to sacred words of Gellert, of which "Die Ehre Gottes aus der Natur" stands as a lasting monument of simple but expressive grandeur, in "Trocknet nicht," in "Partenza," "In questa tomba," in the first of his four settings of Goethe's "Nur wer die Sehnsucht kennt," and more than all, in the cycle "An die ferne Geliebte," which represents a further stage reached in song on the road marked out by Mozart in "Das Veilchen." We have left behind the pretty artificialities so dear to the 18th century, that play around fictitious shepherds and shepherdesses, and entered the field of deeper human feeling with the surrounding influences upon it of nature and romance. The new spirit of the age, represented in German poetry by the lyrics of Bürger, Voss, Claudius and Hölty, members of the famous Göttinger Hainbund, and more notably by those of Goethe and Schiller, communicates itself in Beethoven to song, which now assumes its rightful position of joint interpreter. It needs no deep study of Beethoven's songs to perceive that the accompaniment has assumed, especially in the "Liederkreis," an importance, immeasurably greater than in the songs of any previous composer. It begins to act the part of the chorus in Greek drama and to

provide both a background and a commentary to the central personages.

The tentative and uninspired work of Zelter, Reichardt, Schulz and others, when they attempted anything beyond a merely tuneful melody in the strophic form, may be passed over, but a word is due to J. R. Zumsteeg, because in spite of the sometimes childish simplicity of his work he yet, in the kind of use which he made of modulation as a means of lyrical expression, anticipated, more than any other composer of songs, one of the chief features of the greatest song writer of all ages, Franz Schubert. Schubert's "Erlkönig" was written a few months before Beethoven's "Liederkreis," "Gretchen am Spinnrade" about a year before the "Erlkönig." He was eighteen when he composed the latter, in 1815. Lyrical song, divorced from all hindering elements and associations, whether of *salon* or theatre, was here at the threshold of his short career in almost full maturity and plenitude of power. It is sufficiently remarkable that a lad with so little education should have composed such music: it is more astonishing still that he should have penetrated with such unerring insight into the innermost secrets of the best poetry. Two of the necessary qualifications for a great song composer were thus at last united. Schubert possessed the third—a knowledge of the human voice, partly intuitive, partly the result of his experience as a chorister boy. The beauty of his melodies is scarcely more striking than the gratefulness of their purely vocal qualities. The technique of singing had indeed been understood for nearly two centuries; but Schubert was the first to divine fully its emotional range, and to dissociate it in lyrical work from all traditions of the schools. From the beginning to the end of his career he never penned a note or a phrase because it was vocally effective. What he wrote for the voice to sing was there because for him the poetry could not have it otherwise. This was inherent in his method of working, in which he relied implicitly upon his musical inspiration for a response, usually instantaneous, to the inordinate receptivity of his mind to the impressions of poetry. To read through a poem was for him not only to seize its innermost significance, and every salient point of language or of form, but also to visualize the scheme by which both the whole and the parts could be translated and glorified through the medium of music. As the singer Vogl, the first of his profession to appreciate him, remarked, "He composed in a state of *clairvoyance*." Hence the impossibility of summarizing in a short space the innovations he introduced, for new poems invariably suggested new types of song. His settings of Goethe's lyrics (that is, the best of them) differ as essentially from his settings to those of W. Müller in the cycles "Die Schöne Müllerin" and "Die Winterreise," as these again from his settings of Heine. Hardly a single development in subsequent phases of the art (except those which eliminate the melodious element) is not foreshadowed in one or other of his six hundred (and more) songs. Brahms, perhaps the greatest of his successors, said that there was something to be learned from every one of Schubert's songs. He was as perfectly at home in the *durchcomponiertes Lied* as in the simple strophic type or the purely declamatory ("Der Wegweiser," "Nähe des Geliebten," "Der Doppelgänger" may serve as familiar but supreme examples of each). Certain features may be selected for emphasis, first, his use of modulation as a means of emotional expression. "Du liebst mich nicht" traverses in two pages more keys than would serve most composers for a whole symphony, whilst the discords on the words "Die Sonne vermissen" and "Was blüh'n die Narcissen" gave a piercingly thrilling effect, which is quite modern. The modulations in "Wehmuth" illustrate the subtle atmospheric effects which he loved to produce by sudden contrasts between major and minor harmonies. More familiar instances occur in "Gute Nacht," "Die Rose," "Rosamunde." Secondly, his inexhaustible fertility in devising forms of accompaniment, which serve to illustrate the pictorial or emotional background of a poem; we have the galloping horses (and the horn) in "Die Post," the spinning wheel in "Gretchen," murmuring brooks in many songs from "Die Schöne Müllerin" and in "Liebesbot-

schaft," the indication of an emotional mood in "Die Stadt" or "Litanei." Occasionally, it is true, the persistence of a particular figure and rhythm induces monotony, as in "Ave, Maria!" or "Normans Gesang," but generally Schubert has plenty of means at his command to prevent it, such as the presence of an appropriate subsidiary figure making its appearance at intervals, as in "Halt," "Der Einsame," or some enchanting ritornello, by which a phrase of the vocal melody is echoed in the accompaniment, as in "Liebesbotschaft," "An Sylvia," "Ständchen" and "Fischerweise." Thirdly, the sudden entrance of declamatory passages, as in "Der Neugier'ge," "Am Feierabend," in "Gretchen," at the famous "Ach sein Kuss," and in "Erlkönig" at "Mein Vater, mein Vater." Fourthly, the realistic touches by which suggestions in a poem are incorporated into the accompaniment, such as the cock crowing in "Frühlingstraum," the convent bell in "Die Junge Nonne," the nightingale's song in "Ganymed" or the falling tears in "Ihr Bild." Finally should be noted the extreme rarity of any slips in the matter of the just accentuation of syllables, and this is especially remarkable in a song writer who relies so much upon pure melody as Schubert, for to preserve a perfect melodic outline which shall do not the least violence to a poet's text, presents far more difficult problems than the declamatory style. Yet Schubert is as successful in "Liebesbotschaft" as in "Prometheus." Purists may be disturbed by the repetitions of words involved in the magnificent "Dithyrambe"—but Schubert cannot be expected to betray a sensitiveness which is really post-Wagnerian. Nor is it just to a composer of over 600 songs to fasten for critical purposes on those which do not represent him at his best. His best level is so often attained as to make attacks on points which he has missed—as in some of the songs from Wilhelm Meister—somewhat beside the mark. It is usually the work of enthusiasts who wish to exalt others at Schubert's expense. For further details the reader is referred to the brilliant essay on Song with which Mr Hadow concludes vol. v. of the *Oxford History of Music*. It must suffice here to point out in a general way that in wideness of scope and aim, in intensity of expression Schubert produced the same transformation in the lyrical field that Beethoven had produced in the larger forms of sonata, string quartet and symphony. Beethoven's work was necessary before Schubert could arise, but Schubert's conceptions and methods were the fruit of his own genius. Of his contemporaries Loewe deserves mention for his singular success in overcoming the difficulties involved in setting long ballads to music. To preserve homogeneity in a form in which simple narration presents perpetually shifting changes of action, of picture, of mood, is a problem which Schubert himself only once triumphantly solved. Weber contributed nothing to song, except in his operas, of permanent value, beyond a few strophic songs of a popular nature. He disqualified himself for higher work by that singular preference for vapid and trivial verse which so often led Haydn and Mozart astray. Mendelssohn's literary tastes took him to the best poetry, but he made but little attempt as a rule, to penetrate beyond its superficial and obvious import. His own lovable personality is far more clearly revealed in his songs than the spirit of his poets. Differences of literary style affected the style of his music perhaps less than that of any other distinguished composer. He attained his highest level in "Auf Flügeln des Gesanges," the first of the two songs to Zuleika, and Nachtlied. It is noteworthy that there is no trace of Schubert's influence. Had Schubert not lived, Mendelssohn's songs would have been just the same. Hence in spite of graceful and flowing melodies, elegant but simple in form, and instinct with that polished taste and charm of manner which endeared both himself and his works to his own generation, his songs have exercised no permanent influence upon the art. Their immediate influence, it is true, was enormous: it is felt occasionally in Schumann, only too often in Robert Franz, and a host of lesser composers in many countries besides his own, such as Gade, Lindblad, Sterndale Bennett, and others who need not be specified.

Of far greater importance is the work of Robert Schumann, whose polyphonic methods of technique and peculiarly epigrammatic style enabled him to treat complex phases of thought and feeling which had hardly become prominent in Schubert's time with quite extraordinary success. Both by temperament and by choice he is identified with the so-called romantic movement, a movement in which both poetry and music have tended more and more to become rather a personal revelation than "a criticism of life." Thus with Schubert the note of universality, the abiding mark of the classical composers, is stronger than the impress of his own personality. With Schumann the reverse is the case. If the romantic movement gave a new impetus of vast importance both to music and literature, yet it had its weaker side in extremes of sensibility, which were not always equivalent to strength of feeling. Mendelssohn's songs admittedly err on the side of pure sentimentality—Schumann, with Liszt, Jensen and Franz, frequently betrays the same weakness, but his best work, his settings to Heine (especially the *Dichterliebe*), the *Eichendorff* "Liederkreis," Chamisso's "Frauenliebe u. Leben" (with some reservations), besides a fair number of other songs, such as "Widmung," "Der Nussbaum," "Ihre Stimme," and his one completely successful ballad, "Die beiden Grenadiere," are strong in feeling and full of poetic and imaginary qualities of the very highest order. The new poetry called for new methods of treatment. These Schumann, instinctively an experimenter, provided, first, by a closer attention to the minutiae of declamation than had hitherto been attempted—and herein syncopation and suspension furnished possibilities unsuspected even by Schubert—secondly by increasing the rôle of the pianoforte accompaniment—and in this he was helped on the one hand by novel methods of technique, of which himself and Chopin were the chief originators, and on the other by his loving study of Bach, which imparted a polyphonic treatment, quite new to song. In nearly all Schubert's songs, and in quite all of Mendelssohn's, the melody allotted to the voice maintained its position of supremacy. In Schumann it not infrequently becomes the secondary factor, the main rôle of lyric interpreter passing to the accompaniment, as in "Es ist ein Flöten u. Geigen" or "Röselein." He also gave quite a new prominence to the opening and closing instrumental symphonies, which become in his hands no merely formal introduction or conclusion but an integral part of the whole conception and fabric of the *Lied*. This may be illustrated by many numbers of the *Dichterliebe*, but most remarkable is the final page, in which the pianoforte, after the voice has stopped, sums up the whole tenour of the cycle. This feature has been seized upon by many subsequent composers, but by few with Schumann's rare insight and judgment. In Franz, for instance, the concluding symphony is often introduced without necessity, and becomes a mere irritating mannerism. In Brahms however it is developed, both at the opening and close of many songs, to an importance and pregnancy of meaning which no other composer has attained.

A third point in Schumann's method is his fondness for short interrupted phrases (often repeated at different levels) in place of the developed Schubertian melodies; it is alluded to here because of the great extension of the practice by later composers, too often, as in the case of Franz, without Schumann's tact. On many grounds, then, Schumann may be regarded as having widely extended the conception of the *Lied*; his example has encouraged later composers to regard no lyric poetry as too subtle for musical treatment. Unfortunately in presenting complexity of mood Schumann was not invariably careful to preserve structural solidity. Many later composers have followed the occasional looseness of design which is his fault, without approaching the beauty of spirit, in which he stands alone.

A bold experimenter in song was Franz Liszt, whose wayward genius, with its irrepressible bent towards the theatrical and melodramatic, was never at home within the limits of a short lyric. It is true that there is sincerity of feeling, if not of the deepest kind, in "Es muss ein Wunderbares sein" and "Über allen Gipfeln"; but concentrated emotion, which involves for

its expression highly organized form, was alien to Liszt's genius, which is more truly represented in songs like "Die Lorelei," "Kennst du das Land," "Am Rhein"—in which are presented a series of pictures loosely connected, giving the impression of clever extemporizations on paper. It is not sufficiently recognized that such work is far easier to produce than a successful strophic song, even of the simplest kind, because the composer ignores the fact that a formal lyric implies formal music, and that the most formal poetry is often the most emotional. Critics, who measure the advance of song by the increase in number of those that are *durchcomponirt*, and the decreasing output of those which have the same music to each stanza, are in danger of forgetting the best qualities both of music and of poetry. Formless music never interpreted a finely formed poem, and unless the *durchcomponirtes Lied* has more form instead of less than the strophic song, it is artistically valueless. The popularity therefore of "Die Lorelei" is not so much a tribute to Liszt's genius as an example of the extent to which gifted singers and undiscerning critics can mislead the public. Mere scene painting, however vivid, however atmospheric—and these qualities may be conceded to Liszt and to others who have followed his example—takes its place upon the lower planes of art.

The admiration expressed by Liszt and Wagner for the songs of Robert Franz, and the cordial welcome extended by Schumann to those which first made their appearance, have led to an undue estimate of their importance in many quarters. They are characterized by extreme delicacy both of feeling and of workmanship, but the ingenuity of his counterpoint, which he owed to his intimate knowledge of Bach and Handel, cannot conceal the frequent poverty of inspiration in his melodic phrases nor the absence of genuine constructive power. To build a song upon one or two phrases repeated at different levels and coloured by changing harmonies to suit the requirements of the poetic text (as in "Für Musik" and "Du bist elend") is a dangerous substitute for the power to formulate large and expressive melodies. But it is the method which Franz instinctively preferred and elaborated with skill. His songs are mostly very short and in the strophic form, some alteration being nearly always reserved to give point to the last verse. His tricks of style and procedure so quickly become familiar as to exhaust the patience even of the most sympathetic student. But the sincerity of his aims, the idealistic and supersensitive purity of his mind (which banished as far as possible even the dramatic element from his lyrics), its receptiveness to the beauties of nature and all that is chaste, tender and refined in human character render his songs an important contribution to our knowledge of the intimate side of German feeling, and compensate in some degree for the lack of the larger qualities of style and imagination. All his best qualities are represented in the beautiful setting of Lenau's "Stille Sicherheit." Those who care to study his limitations may compare his settings of Heine's lyrics with the masterpieces of Schumann in the same field, or the dulness of his "Verborgeneheit" (Mörike) with the romantic fervour imparted to that poem by the later genius of Hugo Wolf.

A higher value than is usually conceded attaches to the songs of Peter Cornelius, a friend of Liszt and Wagner, but a follower of neither. Before he came under their influence he had undergone a severe course of contrapuntal training, so that his work, though essentially modern in spirit, has that stability of structure which makes for permanence. He was, moreover, an accomplished linguist, a brilliant essayist, and a poet. That perfect fusion between poetry and music, which since Schubert has increasingly been the ideal of German song, is realized in an exceptional manner when, with Cornelius as with Wagner, librettist and musician are one person. More exquisite declamation is hardly to be found in the whole range of song than in the subtly imaginative "Auftrag," whilst for nobility of feeling, apart from technical excellencies of the highest order, the "Weihnachtslieder," the "Brautlieder" and much of the sacred cycle "Vater Unser," are hardly surpassed even by Schumann

at his best, and point to Cornelius as one of the most beautiful and original spirits of the 19th century.

In the song-work of the 19th century, though Schubert remains the rock upon which it has been built, Schumann represents the most directly inspiring influence, even when, as in the case of Adolph Jensen (whose spontaneously melodious and graceful, if not very deep, songs deserve mention), there are importations from such widely divergent sources as those of Mendelssohn and Wagner.

The application of the principles of Wagnerian music-drama to lyrical work, allied, as was natural, with the exaggerations and unconventionalities of Liszt and Berlioz, was sooner or later bound to come, bound also for a time to issue in confusion; to rescue song from which was the work of two men of genius, who, though approaching the task from standpoints removed by the whole distance of pole to pole, may be considered as placing the crown of final achievement upon the aspirations of 19th-century song—Hugo Wolf and Johannes Brahms.

Wolf exhibits an entirely unconventional and original style. He is as untroubled by tradition as Schubert, whom he resembles not often, as in "Fussreise," and "Der Gärtner," in pure melodiousness, but in the intensity of his power to penetrate to the very heart of poetry. To him may also be most fitly applied the epithet *clairvoyant*. He is the first who published songs for voice and pianoforte, not songs with pianoforte accompaniment, thus finally asserting the identity of singer and accompanist in true lyrical interpretation.

The unerring sagacity of Brahms discerned that the possibilities of song on the lines set by Schubert were far from being exhausted: his practical mind preferred to develop those possibilities rather than to seek after strange and novel methods, conforming thus in song to his practice in other branches of composition. A broad melodic outline is for him an essential feature: equally essential is a fine contrapuntal bass. In form the majority of his songs follow the orthodox A B A pattern, the central portion being so organized as to offer, with the least possible introduction of new unrelated material, a heightened contrast with the opening portion by means of new treatment and new tonalities and at the same time to justify itself by producing the mood in which the return to the opening portion is felt as a logical necessity. Chromatic effects in Brahms's scheme of melody are rarely introduced till the middle section, the opening being almost invariably diatonic. It must however be admitted that Brahms's formal perfection involves occasionally an awkward handling of words, and that in a few instances (see *Magelone-lieder*, Nos. 3 and 6), they are frankly sacrificed to that formal development of his material which has been criticized in the cases of Mozart and Beethoven. No part of his songs deserves closer study than the few bars of instrumental prelude and conclusion, in which is enshrined the very essence of his conception of a poem. It may almost be said that, since Schumann set the example, the first and the last word has passed from the voice to the instrument. Accompanist, like singer, must understand poetry as well as music: but with no composer is his responsibility greater than with Brahms. Complete mastery in close organization of form was allied in Brahms not only with the warmth and tenderness of romance, but with the imagination and insight of a profound thinker. Concentration of style and of thought have nowhere in the whole history of song been combined on a plane so high as that which is reached, with all perfection of melodic and harmonic beauty, in "Schwermuth," "Der Tod das ist die kühle Nacht," "Mit vierzig Jahren," "Am Kirchhof," "O wüsst' ich doch den Weg zurück" and the "Vier ernste Gesänge," which closed the list of his 197 songs. The alliance to song of so dangerous a companion as philosophy, or at any rate of thoughts which are philosophical rather than lyrical, proved no obstacle to Brahms's equal success in the realm of romance. This side of his genius may be illustrated by numerous songs from the *Magelone* cycle (notably "Wie froh und frisch" and "Ruhe, süß, Liebchen") and by others, of which "Liebestreu," "Die Mainacht," "Feldeinsamkeit," "Wie rafft' ich mich auf in der Nacht,"

"Minnelied" and "Wir wandelten" are a few examples picked at random.

It has already been indicated that Brahms was a deep student of Schubert. If he had not Schubert's absolute spontaneity of melody, he restored it to its Schubertian place of supreme importance. In spite of all the tendencies of his age he never shirked that supreme test of a composer, the power to originate and organize melody: but it is melody often of a type so severe in its outline and proportions as to repel those hearers who are unable to attain to his level of thought and feeling. All mere prettiness and elegance are as alien to his nature as even the slightest approach to sentimental weakness on the one hand, or to realistic scene-painting on the other, so that for the world at large his popularity is jeopardized by an attitude which is felt to be uncompromisingly lofty and severe. It has hardly yet had time to reconcile itself to the union of modern lyrical poetry with a style whose elaborate contrapuntal texture differs as much from the delicate polyphony of Schumann as that in its turn differed from the broad harmonic system of Schubert. But that Brahms was never difficult without reason, or elaborate when he might have been simple, appears plainly from the preference he felt for his slighter songs in the *Volkstümlich* style and form, rather than for those which were *durchcomponirt*. He was strongly influenced by the *Volkslieder* of his country, the words of which he loved to repeat to himself, as they suggested ideas even for his instrumental compositions. His arrangements of *Volkslieder* mark an epoch in that field of work.¹

In the history of song Brahms's name is likely to stand for the closing of a chapter. It is difficult to conceive of more complete work on lines that are essentially classical. The soundest traditions find in him their justification and their consummation. He has enshrined the best thought and the noblest feeling of his age in forms where elaboration and complexity of detail serve essential purposes of interpretation, and are never used as a brilliant artifice to conceal foundations which are insecure.

It is not proposed to discuss the work and tendencies of contemporary German composers—of whom Felix Weingartner (b. 1863), Max Reger (b. 1873) and Richard Strauss have attracted the largest share of attention. The above summary, though necessarily incomplete and confined only to the most conspicuous names, may yet provide some points of view from which the songs of other countries than Germany may be regarded, especially those in which German conceptions and German methods of technique have been dominant factors. Actual settings of German lyrics figure largely in the works of many non-German composers, and these it is hard to judge except by German standards. But, strongly as German influence has been felt in Russia, for instance, in Norway and in Finland, yet the last half century has seen the rise of more distinctly national schools of song in all these countries, and to this result the cult of the folk-song has very largely contributed. Glinka, Rimsky-Korsakov, Borodin, Balakirev, César Cui (b. 1835), and Moussorgsky in Russia, Nordraak (1842-1866) and Grieg in Norway, Sibelius (b. 1865) in Finland, are conspicuous names in this connexion.

The Latin countries have, as is natural, been but little subject to German influences; of these France alone seems to be working her way towards a solution of artistic problems which has interest for those who live beyond her borders and which bears emphatically her own hall-mark. The melodious style of Gounod, which has so powerfully affected composers like Massenet, Godard and Widor, has

¹Their value may be tested by comparing them with the small volume containing arrangements by R. Franz, which are sympathetically done but without inspiration, with those of Tappert, which are models of what such things ought not to be, and with the dull, uninviting work of A. Saran. Many of Reimann's arrangements, however, deserve cordial recognition as both sympathetic and scholarly. One fact emerges clearly from the study of folk-song arrangements, in Germany and elsewhere, that success depends upon qualities which are as rare as, and are seldom dissociated from, the power of original composition. Only a great composer can be a great arranger.

begun to yield during the last quarter of a century to tendencies which correspond closely with those of the impressionist movements in French literature and painting. The deeper side of the movement, in which a strong element of mysticism plays an important part, is represented in the best songs of César Franck, Fauré and Bruneau, a notable group of composers, whose occasional extravagances are atoned for by original impressions of nature in her more unusual moods, and by much that arrests attention both in thought and style. The songs of Duparc (b. 1848) and Vincent d'Indy likewise repay study. Nothing can be clearer than that traditional methods were inadequate, if modern French poetry was to find interpretation in the sister sphere of music; but how far the work of composers such as those named is likely to be regarded as final, it is premature to ask. The world had hardly had time to feel at home with them before it was called upon to face what it is difficult not to regard as representing the extreme limits of impressionistic style in Debussy. We are still too much accustomed to melody and rhythm, to harmonies that have some intelligible principle in their successions, to judge securely of music which is neither melodious nor rhythmical nor in the accepted sense harmonious. We are still too much accustomed to music regulated by analysable laws to feel at ease with music that seems, at any rate at present, to acknowledge none. Whether the work of Debussy is the beginning of a new epoch the future alone can decide, but it is permissible to feel apprehensive of an art which is based upon impressions rather than upon convictions; and the value of impressions is apt to be measured more by the degree in which they are fugitive, elusive, evanescent, or merely peculiar to the composer's temperament, than by the relation which they bear to permanent elements in nature or humanity. Hence in the modern school of song-writers, which finds its culmination in Debussy, the quality of unselfconsciousness is the one which seems most difficult for them to attain. In French art we are too often reminded how close the sublime is to the ridiculous, the dramatic to the theatrical, pathos to bathos, truth to paradox. Even in the quieter pictures we are conscious of a forced atmosphere, an unnatural calm, not the abiding peace of a landscape by Corot or Millet. Lastly, the opinion of Bruneau (*La Musique française*, p. 233) that prose will in time supplant poetry in drama and song is, at least to those to whom form is still an essential element of beauty, a disquieting omen for the future. The best qualities of the French nation, its unaffected gaiety, its sincerity, grace, humour, pathos, tenderness, are far more touchingly and truthfully revealed in the simple melodies of the country-side—or in the less pretentious songs (of which Bruneau and Massenet have given examples, as well as many others) formed upon their model.

Limitations of space do not form the only reason for dealing in a cursory manner with English songs of the 19th century.

Modern English Song. A more valid one is to be found in the absence until its two closing decades, of great names to which can be attached the history of any orderly development, of any well-conceived and definite ideals. The authors of the very limited number of good songs are too often the authors of others in larger quantities which are bad, and that not in every case owing to failure of inspiration but to a lowering of ideals in order to gratify the tastes of an unintelligent public on the one hand, and the demands of exacting publishers on the other. That a healthier art might have arisen is indicated by the presence of such songs as Hatton's "To Anthea," Loder's unexpectedly fine setting of "The Brooklet" (the words of which Schubert had already immortalized in its original German version as "Wohin"), Sullivan's fresh and original settings of several Shakespearian lyrics, and of Tennyson's uninspired cycle of verses entitled "The Songs of the Wrens," and Clay's "I'll sing thee songs of Araby." The name of Sterndale Bennett stands out as that of a composer who remained steadfastly true to his ideals. His output was indeed a small one, and covered a somewhat limited range of style and feeling: but the thought, like the workmanship, is always of delicate and beautiful quality. Though Mendelssohn's influence is

apparent he has a touch which is all his own. "To Chloe in sickness," "Forget-me-not," "Gentle Zephyr" and "Sing, Maiden, sing," have certainly not yet lost their charm. Sterndale Bennett marks the beginning of higher ideals in English song—but it is only within the last twenty-five years that we have begun to see their realization, owing to the training of many English musicians in German schools and to the increasing familiarity of the musical public with the best German *Lieder*. The lead has been taken by Parry and Stanford—composers who have published large numbers of songs in great variety of styles, and with uniform seriousness of aim and treatment. Parry's delightfully fresh early work is represented at its best in "A Spring Song," "A Contrast," and "Why does azure deck the skies?" The transition to a later manner is marked by the four anacreontic odes; and several small volumes of lyrics have since made their appearance. If some of these miss the true lyrical note, of which absolute spontaneity is an essential condition, yet a lofty level of thought and workmanship is always manifest, rising to highest inspiration perhaps in "When we two parted," "Through the ivory gate," and "I'm weaving Sweet Violets." Stanford has essayed songs in many styles, suited to poems drawn from many periods, but he is most himself and most successful in Keats's weird and dramatic ballad "La Belle dame sans merci," in Browning's cavalier songs, in the cycle of sea songs (H. Newbolt) and above all in the Irish idyll (Moirá O'Neill)—where in six pieces of rarest beauty the composer has revealed different phases of Irish feeling, pathos and humour with a poetical and imaginative power unequalled in British art. It is hard to imagine a more perfect alliance between poetry and music, from the general conception of each song down to the minutest detail of declamation, than is found here. As an arranger of Irish melodies—of which four volumes have been published—Stanford has also shown himself a complete master. Cowen, Mackenzie and Elgar have contributed few songs worthy of reputations gained in larger forms of composition. Of the work done and being done by younger composers much might be said. There is activity in many directions; a cycle of songs by Arthur Somervell from Tennyson's *Maud* is an artistic work of very real value, beautiful and original as music, and forming a highly interesting commentary upon the poem. R. Vaughan Williams, in the more difficult task of setting six sonnets from Rossetti's *House of Life* and in three of Stevenson's *Songs of Travel*, has displayed imaginative qualities of a remarkable order. Not less original is the highly finished and poetical work of H. Walford Davies. Somewhat slighter in style and thought, but instinct with true lyrical tenderness and charm, are the songs of Roger Quilter, drawn mainly from the Elizabethan period, and the poems of Herrick. Various songs by Maude V. White, W. H. Hadow, Hamilton Harty, Harold Darke, Ernest Walker, Donald Tovey, William Wallace and others give evidence, with the work already mentioned, of a revolution in the treatment and conception of song in England, which is full of promise for the future. Its fulfilment however is likely to depend upon a change in the prevailing conditions, under which professional vocalists have a financial interest in popularizing inferior productions. Good songs, apart from the initial difficulty of finding a publisher, are thus penalized from the start, whilst the larger and less instructed portion of the public, which forms its taste upon what the singers of the day provide, remains ignorant of precisely those works which are most necessary for its enlightenment.

BIBLIOGRAPHY.—In Grove's *Dictionary of Music and Musicians* (new ed.) Mrs E. Woodhouse's article on "Song" (vol. iv.) gives a practically exhaustive bibliography of the whole subject of song and folk-song, country by country; her account is quite unique, and indispensable to the student. The following list is mainly of books which the present writer has found most valuable: Sir Hubert Parry, *Art of Music* (London, 1897); *Oxford History of Music* (1901-1905), esp. vol. iii.; "The Seventeenth Century" by Sir Hubert Parry, vol. iv.; "The Age of Bach and Handel" by J. A. Fuller-Maitland, vol. v.; "The Viennese Period" by W. H. Hadow, vol. vi.; "The Romantic Period" by E. Dannreuther; Combarieu, *La Musique, ses lois et son évolution* (Paris, 1907); Ambros, *Geschichte der Musik* (1862-1882); Coussemaker, *Histoire de l'harmonie au moyen*

âge (1852); Kiesewetter, *Schicksale u. Beschaffenheit des weltlichen Gesanges* (1841); Reissmann, *Das deutsche Lied* (1861; rewritten as *Geschichte des deutschen Liedes*, 1874); Schneider, *Das musikalische Lied* (1863); E. Walker, *History of Music in England* (1907); W. Nagel, *Geschichte der Musik in England* (1894-1897); C. J. Sharp, *English Folk-songs, some Conclusions* (1907); J. Tiersot, *Histoire de la chanson populaire en France* (1889); Lavoix, *La Musique française* (1891).

Collections of songs with valuable introduction and notes (those marked with an asterisk have pianoforte accompaniments): F. M. Boehme, *Altdeutsches Liederbuch* (Breitkopf & Härtel, 1877); Gaston Paris and Gevaert, *Chansons du XV^e siècle* (Paris, 1875); J. Tiersot, *Chansons populaires des Alpes françaises* (Grenoble, 1903); De la Villemarqué, *Barzaz-Breiz, Chansons pop. de la Bretagne* (Paris, 1867); *Bourgault-Ducoudray, *30 mélodies pop. de la Basse-Bretagne* (Paris, 1885); *Champfleury and Weckerlin, *Chansons pop. des provinces de France* (Paris, 1860); *Weckerlin, *Echos du temps passé* (3 vols., Paris, 1855), and **Chansons pop. du pays de France* (2 vols. Paris, 1903); *V. D'Indy, *Chansons pop. du Vivarais*, op. 52 (Paris); Hjalmar Thurn, *Folkesangen paa Faererne* (Copenhagen, 1908); F. van Duyse, *Het oude nederlandse Lied* (The Hague, 1903-1905); *E. Closson, *Chansons pop. des provinces belges* (Brussels, 1905); *Bourgault-Ducoudray, *30 mélodies pop. de Grèce et d'orient* (Paris, 1897); Eugénie Lineff, *Peasant Songs of Great Russia* (St Petersburg and London, 1905); *W. Chappell, *Popular Music of the Olden Time* (London, 1855-1859); *E. Wooldridge, revised edition of the above, with title *Old English Popular Music* (London, 1893); Folk-song Society's Journals; *C. J. Sharp, *Folk-songs from Somerset* (5 vols., Barnicott & Pearce, Taunton); *J. A. Fuller-Maitland and L. E. Broadwood, *County Songs* (Novello); *Sharp and Baring-Gould, *Songs of the West* (Methuen); *L. E. Broadwood, *English Traditional Songs and Carols* (Boosey). (W. A. J. F.)

THE SONG OF BIRDS

The characteristic modulated voice of birds is the outstanding example of natural "song" in the animal world. The essential requirements of a vocal organ, the pressure of vibratory membranes or chord, are found in the bird's *syrix* (see BIRD), but how these membranes act in particular, and how their tension is modified by the often numerous syringeal muscles, we do not know. The voice of birds is produced entirely by the *syrix*; the larynx no doubt modifies it, but the tongue seems to play no part in it. The "loosening of the tongue" by cutting its *frenum*, in order to assist a bird in talking &c., is an absolutely silly operation. The possession of the most elaborate *syrix* is not enough to enable a bird to sing. In this respect they are like ourselves: special mental faculties are required to control the apparatus. Anatomically the raven has the same elaborate *syrix* as the thrush or the nightingale, and yet the raven cannot "sing" although it can modulate its voice and can even learn to talk. As a rule the faculty of singing is restricted to the males, although the females possess the same organs; moreover, birds vary individually. Some learn to sing marvellously well, while others remain tyros in spite of the best education. But given all the necessary mental faculties, birds sing only when they are in such a healthy condition that there is a surplus of energy. This, of course, is greatest during the time of propagation, when much of the surplus of the general metabolism comes out—to use homely words—in unwonted functions, such as dancing, posing, spreading of feathers and giving voice. Every one of these muscular exertions is a spasm, releasing some energy, and—again in homely parlance—relieving the mind. In many cases these antics and other manifestations become rhythmical, and music consists of rhythmical sounds. Of course birds, like other creatures, are to a certain extent reflex machines, and they often sing because they cannot help it, just as male frogs continue to croak long after the pairing season, and not necessarily because they or their mates appreciate those sounds. But birds stand mentally on such a high level that we can scarcely doubt that in many cases they enjoy, and therefore sing their song. Many a tame bird, a canary, starling, magpie, will repay its keeper with its song, out of season, for any kindness shown to it, or for his mere presence.

If we regard any sound made by a bird under the all-powerful influence of love or lust as its "song," then probably every bird is possessed of this faculty, but in the ordinary acceptance of the term very few, besides the oscines, can sing, and even this group contains many which, like the ravens and the crows,

are decidedly not songsters. On the other hand, it seems unfair not to call the charming series of notes of the dove its song.

D. Barrington in a very remarkable paper ("Experiments and Observations on the Singing of Birds," *Phil. Trans.*, 1773, pp. 249-291) defines a bird's song "to be a succession of three or more different notes, which are continued without interruption during the same interval with a musical bar of four crotchets in an adagio movement, or whilst a pendulum swings four seconds." The late A. Newton (*Ency. Brit.*, 9th ed., iii. 771; see also *Dict. Birds*, s.v. "Song," pp. 892-894), taking a much wider view of "song," proceeds as follows:—

"It seems impossible to draw any but an arbitrary line between the deep booming of the emeu, the harsh cry of the guillemot (which, when proceeding from a hundred or a thousand throats, strikes the distant ear in a confused murmur like the roar of a tumultuous crowd), the plaintive wail of the plover, the melodious whistle of the wigeon, 'the cock's shrill clarion,' the scream of the eagle, the hoot of the owl, the solemn chime of the bell-bird, the whip-cracking of the manakin, the chaffinch's joyous burst, or the hoarse croak of the raven, on the one hand, and the bleating of the snipe or the drumming of the ruffled grouse, on the other. Innumerable are the forms which such utterances take. In many birds the sounds are due to a combination of vocal and instrumental powers, or, as in the cases last mentioned, to the latter only. But, however produced—and of the machinery whereby they are accomplished there is not room here to speak—all have the same cause and the same effect. The former has been already indicated, and the latter is its consummation. Almost coinstantaneously with the hatching of the nightingale's brood the song of the sire is hushed, and the notes to which we have for weeks hearkened with rapt admiration are changed to a guttural croak, expressive of alarm and anxiety, inspiring a sentiment of the most opposite character. No greater contrast can be imagined, and no instance can be cited which more completely points out the purpose which 'song' fulfils in the economy of the bird, for if the nightingale's nest at this early time be destroyed or its contents removed, the cock speedily recovers his voice, and his favourite haunts again resound to his bewitching strains. For them his mate is content again to undergo the wearisome round of nest-building and incubation. But should some days elapse before disaster befalls their callow care, his constitution undergoes a change and no second attempt to rear a family is made. It would seem as though a mild temperature, and the abundance of food by which it is generally accompanied, prompt the physiological alteration which inspires the males of most birds to indulge in the 'song' peculiar to them. Thus after the annual moult is accomplished, and this is believed to be the most critical epoch in the life of any bird, cock thrushes, skylarks, and others begin to sing, not indeed with the jubilant voice of spring but in an uncertain cadence which is quickly silenced by the super-vention of cold weather. Yet some birds we have which, except during the season of moult, hard frost, and time of snow, sing almost all the year round. Of these the redbreast and the wren are familiar examples, and the chiffchaff repeats its two-noted cry, almost to weariness, during the whole period of its residence in this country.

"Akin to the 'song of birds,' and undoubtedly proceeding from the same cause, are the peculiar gestures which the males of many perform under the influence of the approaching season of pairing, but these again are far too numerous here to describe with particularity. It must suffice to mention a few cases. The ruff on his hillock in a marsh holds a war-dance. The snipe and some of his allies mount aloft and wildly execute unlooked-for evolutions almost in the clouds. The woodcock and many of the goatsuckers beat evening after evening the same aerial path with its sudden and sharp turnings. The ring-dove rises above the neighbouring trees and then with motionless wings slides down to the leafy retreat they afford. The capercally and blackcock, perched on a commanding eminence, throw themselves into postures that defy the skill of the caricaturist—other species of the grouse-tribe assume

the strangest attitudes and run in circles till the turf is worn bare. The peacock in pride spreads his train so as to show how nearly akin are the majestic and the ludicrous. The bower-bird, not content with its own splendour, builds an arcade, decked with bright feathers and shining shells, through and around which he paces with his gay companions. The larks and pipits never deliver their song so well as when seeking the upper air. Rooks rise one after the other to a great height and, turning on their back, wantonly precipitate themselves many yards towards the ground, while the solemn raven does not scorn a similar feat, and, with the tenderest of croaks, glides supinely alongside or in front of his mate."

The following may be cited as the principal treatises on the subject, besides Barrington's paper quoted above: J. Blackwall, *Mem. Litt. Phil. Soc.*, Manchester (1824), pp. 289-323; also in Froriep's *Notizen* (1825), col. 292-298; F. Savart, *Mémoire sur la voix des oiseaux*, Froriep's *Notizen* (1826), col. 1-10; C. L. Brehm, *Naumannia* (1855), pp. 54-59, 96-101, 181-195; and *Journ. f. Ornith.* (1855, pp. 348-351; 1856, pp. 250-255); C. Gloger, *Journ. f. Ornith.* (1859), pp. 439-459; J. E. Harting, *Birds of Middlesex* (London, 1866), where the notes of many of the common English birds are musically expressed; J. A. Allen, *Bull. Comp. Zool. Harvard* (1871), ii. 166-450; L. Paolucci, *Il Canto degli uccelli* (Milan, 1878), and *Milano soc. ital. atti.* 20 (1877), pp. 125-247; C. L. Hett, *A Dictionary of Bird Notes* (Brigg, 1898); C. A. Witchell, *Bird-Song and its Scientific Teaching* (Gloucester, 1892); F. S. Mathews, *Field Book of Wild Birds and their Music* (New York, 1904). See also W. Warde Fowler, *A Year With the Birds* (1886). (H. F. G.)

SONGHOI, **SONRHAY**, **SURHAI**, &c., a great negroid race inhabiting a large tract of country on both banks of the middle Niger. They formed a distinct state from the 8th to the 16th century, being at one period masters of Timbuktu (*q.v.*) and the most powerful nation in the western Sudan. The origin of this people, who are said still to number some two millions, though their national independence is lost, has been a source of much dispute. Heinrich Barth, who has given the fullest account of them, reckoned them as aborigines of the Niger valley; but he also tried to connect them with the Egyptians. The people themselves declare their original home to have been to the eastward, but it seems unlikely that they or their culture are to be connected at all with the Nile valley. According to the *Tarik é Sudan*, a 17th century history of the Sudan written by Abderrahman Sadi of Timbuktu, the first king of the Songhoi was called Diallyaman (Arabic *Dia min al Jemen*, "he is come from Yemen"), and the account given in this Arabic manuscript leaves little doubt that he was an Arab adventurer who, as has been frequently the case, became chief of a negro people and led them westward. The Songhoi emigration must have begun towards the middle of the 7th century, for Jenné, their chief city, was founded one hundred and fifty years after the Hejira (about A.D. 765), and it represents the extreme western point in their progress. From a hundred to a hundred and twenty years would be about the time which must be allowed for the years of wandering and those of settlement and occupation in the Songhoi countries. In the north they have mixed with the Ruma "Moors," and in the south with the Fula. The Songhoi, then, are probably Sudanese negroes much mixed with Berber and even Arab blood, who settled among and crossed with the natives of the Niger valley, over whom they long ruled.

In their physique they bear out this theory. Although often as black as the typical West African, their faces are frequently more refined than those of pure negroes. The nose of the Songhoi is straight and long, pointed rather than flat; the lips are comparatively thin, and in profile and jaw projection they are easily distinguishable from the well-known nigrific type. They are tall, well-made and slim. In character, too, they are a contrast to the merry light-heartedness of the true negro. Barth says that of all races he met in negroland they were the most morose, unfriendly and churlish. The Songhoi language, which, owing to its widespread use, is, with Hausa, called *Kalam al Sudan* ("language of the Sudan") by the Arabs, is often known as Kissur. According to Friedrich Müller it resembles in structure none of the neighbouring tongues, though its vocabulary shows Arab influence. Keane states that the language "has not the remotest connexion with any form

of speech known to have been at any time current in the Nile valley."

See Heinrich Barth, *Travels and Discoveries in Northern and Central Africa* (1857-1858); A. H. Keane, *Man Past and Present* (Cambridge, 1899); Brix Förster in *Globus*, lxxi. 193; Felix Dubois, *Timbuctoo the Mysterious* (1897); Lady Lugard, *A Tropical Dependency* (1905).

SONNEBERG, a town of Germany, in the duchy of Saxe-Meiningen, situated in a narrow valley of the Thuringian forest, 13 m. by rail N.E. of Coburg. Pop. (1905), 15,003. It is famous for its manufacture of toys; its other industries are the making of glass and porcelain articles, electrical works and breweries. The town possesses a fine Gothic church, and a hydropathic establishment.

SONNENTHAL, ADOLF VON (1834-1909), Austrian actor, was born of Jewish parentage in Budapest on the 21st of December 1834. Though brought up in penury and apprenticed to a working tailor, he yet cultivated the histrionic art, and was fortunate in receiving the support of a co-religionist, the actor Bogumil Dawison, who trained him for the stage. He made his first appearance at Temesvar in 1851, and after engagements at Hermannstadt and Graz came in the winter of 1855-1856 to Königsberg in Prussia, where his first performance was so successful that he was engaged by Heinrich Laube for the Burgtheater in Vienna, making his first appearance as Mortimer in Schiller's *Maria Stuart*. Under Laube's careful tuition he developed within three years into an actor of the first order, excelling both in tragedy and comedy; and in 1882, after 25 years of brilliant service at the Court Theatre, he was given a patent of nobility. In 1884 he became manager-in-chief of the theatre; and in 1887-1888 acted as artistic adviser. He visited the United States in 1885, and again in 1890 and 1902, achieving great success. His chief parts were Nathan in Lessing's *Nathan der Weise*, Wallenstein, and Der Meister von Palmyra.

SONNET (Ital. *Sonetto*, dim. of *Suono*, Fr. *Sonnet*). The sonnet in the literature of modern Europe is a brief poetic form of fourteen rhymed verses, ranged according to prescription. Although in a language like the English it does no doubt require considerable ingenuity to construct a satisfactory sonnet of octave and sestet running upon four rhymes, this ingenuity is only a means to an end, the end being properly that a single wave of emotion, when emotion is either too deeply charged with thought, or too much adulterated with fancy, to pass spontaneously into the movements of pure lyric, shall be embodied in a single metrical flow and return. Whether any given sonnet be composed like that of Pier delle Vigne (of two quatrains with rhymes running a, b, a, b, a, b, a, b, and of two tercets with rhymes running, c, d, e, c, d, e), or whether the verses be arranged (on the authority of Shakespeare and Drayton) in three quatrains of alternate rhymes clinched by a couplet, or, as in the sonnet of Petrarch, in an octave of two rhymes and a sestet of either two or three rhymes—in each case the peculiar pleasure which the ear derives from the sonnet as a metrical form lies in the number and arrangement of the verses being prescribed, and distinctly recognizable as being prescribed. That the impulse to select for the rendering of single phases of feeling or reflection a certain recognized form is born of a natural and universal instinct is perhaps evidenced by the fact that, even when a metrical arrangement discloses no structural law demanding a prescriptive number and arrangement of verses, the poet will nevertheless, in certain moods, choose to restrict himself to a prescribed number and arrangement, as in the cases of the Italian *stornello*, the Welsh *triban*, and the beautiful rhymeless short ode of Japanese poetry. And perhaps, if we probed the matter deeply, we should find that the recognized prescription of form gives a sense of oneness that nothing else save the refrain can give to a poem which, being at once too long for a stanza in a series and too short to have the self-sustaining power of the more extended kinds of poetic art, suffers by suggesting to the ear a sense of the fragmentary and the inchoate. It is not then merely the number of the verses, it is also their arrangement as to rhymes—an arrangement leading the ear to expect

a prescribed sequence and then satisfying that expectation—which entitles a form of fourteen verses to be called a sonnet.

Hence the so-called irregular sonnets of S. T. Coleridge, which lead the ear of the reader to expect the pleasure of a prescribed arrangement when what they have to offer is a pleasure of an exactly opposite kind—the pleasure of an absolute freedom from prescribed arrangement—are unsatisfactory, while (as the present writer has often pointed out) the same poet's fourteen-line poem, "Work without Hope," in which the reader expects and gets freedom from prescription, is entirely satisfactory. This same little poem of Coleridge's also affords an excellent illustration of another point in connexion with the sonnet. If we trace the history and the development of the sonnet from Pier delle Vigne to D. G. Rossetti we shall find that the poet's quest from the very first has been to write a poem in fourteen verses so arranged that they should, better than any other number and arrangement of verses, produce a certain melodic effect upon the ear, and an effect, moreover, that should bear iteration and reiteration in other poems similarly constructed. Now if we ask ourselves whether, beautiful as is this poem, "Work without Hope," taken as a single and original metrical arrangement, we should get out of a series of poems modelled line for line upon it that pleasure of iteration which we get out of a series of Petrarchan sonnets, we shall easily see why the regular sonnet of octave and sestet on the one hand, and what is called the Shakespearean sonnet on the other, have survived all other competing forms.

In modern Europe the sonnet has always had a peculiar fascination for poets of the first class—poets, that is, in whom poetic energy and plastic power are equally combined. It would seem that the very fact that the sonnet is a recognized structure suggestive of mere art—suggestive in some measure, indeed, of what Schiller would call "sport" in art—has drawn some of the most passionate poets in the world to the sonnet as the medium of their sincerest utterances. Without being coldly artificial, like the *rondeau*, the *sestina*, the *ballade*, the *villanelle*, &c., the sonnet is yet so artistic in structure, its form is so universally known, recognized, and adopted as being artistic, that the too fervid spontaneity and reality of the poet's emotion may be in a certain degree veiled, and the poet can whisper, as from behind a mask, those deepest secrets of the heart which could otherwise only find expression in purely dramatic forms.

That the sonnet was invented, not in Provence, as French critics pretend, but in Italy in the 13th century, is pretty clear, but by whom is still perhaps an open question. S. Waddington and several other critics have attributed to Fra Guittone the honour of having invented the form. But J. A. Symonds has reminded us that the sonnet beginning *Però ch' amore*, attributed to Pier delle Vigne, secretary of state in the Sicilian court of Frederick, has claims which no student of early Italian poetry can ignore.

As regards English sonnets, whether the Petrarchan and the Shakespearean are really the best of all possible forms we need not inquire. But, inasmuch as they have become so vital and so dominant over other sonnet forms that whenever we begin to read the first verse of an English sonnet we expect to find one or other of these recognized rhyme-arrangements, any departure from these two arrangements, even though the result be such a magnificent poem as Shelley's "Ozymandias," disappoints the expectation, baffles the ear, and brings with it that sense of the fragmentary and the inchoate to which we have before alluded. If, however, some writer should arise with sufficient originality of metrical endowment and sufficient poetic power to do what Keats, in a famous experiment of his, tried to do and failed—impress the public ear with a new sonnet structure, impress the public ear so powerfully that a new kind of expectance is created the moment the first verse of a sonnet is recited—then there will be three kinds of English sonnets instead of two.

With regard to the Petrarchan sonnet, all critics are perhaps now agreed that, while the form of the octave is invariable, the form of the sestet is absolutely free, save that the emotions should govern the arrangement of the verses. But as regards

the division between octave and sestet, Mark Pattison says, with great boldness, but perhaps with truth, that by blending octave with sestet Milton missed the very object and end of the Petrarchan scheme. Another critic, however, Hall Caine, contends that by making "octave flow into sestet without break of music or thought" Milton consciously or unconsciously invented a new form of sonnet; that is to say, Milton, in his use of the Petrarchan octave and sestet for the embodiment of intellectual substance incapable of that partial disintegration which Petrarch himself always or mostly sought, invented a species of sonnet which is English in impetus, but Italian, or partially Italian, in structure. Hence this critic, like William Sharp, divides all English sonnets into four groups: (1) sonnets of Shakespearean structure; (2) sonnets of octave and sestet of Miltonic structure; (3) sonnets of contemporary structure, *i.e.* all sonnets on the Petrarchan model in which the metrical and intellectual "wave of flow and ebb" (as originally formulated by the present writer in a sonnet on the sonnet, which has appeared in most of the recent anthologies) is strictly observed, and in which, while the rhyme-arrangement of the octave is invariable, that of the sestet is free; (4) sonnets of miscellaneous structure.

With regard to what is called the contemporary form—a Petrarchan arrangement with the sestet divided very sharply from the octave—the crowning difficulty and the crowning triumph of the sonnet writer has always been to so handle the rhythm of the prescribed structure as to make it seem in each individual sonnet the inevitable and natural rhythm demanded by the emotion which gives the individual sonnet birth, and this can perhaps only be achieved when the richness and apparent complexity of the rhyme-arrangement is balanced by that perfect lucidity and simplicity of syntax which is the special quest of the "sonnet of flow and ebb."

The wave theory has found acceptance with such students of the sonnet as Rossetti and Mark Pattison, J. A. Symonds, Hall Caine, and William Sharp. Symonds, indeed, seems to hint that the very name given by the Italians to the two tercets, the *volta* or turn, indicates the metrical meaning of the form. "The striking metaphorical symbol," says he, "drawn from the observation of the swelling and declining wave can even in some examples be applied to sonnets on the Shakespearean model; for, as a wave may fall gradually or abruptly, so the sonnet may sink with stately volume or with precipitate subsidence to its close. Rossetti furnishes incomparable examples of the former and more desirable conclusion; Sydney Dobell, in 'Home in War Time,' yields an extreme specimen of the latter."

And now as to the Shakespearean sonnet. Some very acute critics have spoken as if this form were merely a lawless succession of three quatrains clinched by a couplet, and as if the number of the quatrains might just as well have been two or four as the present prescribed number of three. If this were so, it would unquestionably be a serious impeachment of the Shakespearean sonnet, for, save in the poetry of ingenuity, no metric arrangement is otherwise than bad unless it be the result of a deep metrical necessity.

If the prescriptive arrangement of *three* quatrains clinched by a couplet is not a metrical necessity, if it is not demanded in order to prevent the couplet from losing its power, such an arrangement is idle and worse than idle; just as in the case of the Petrarchan sonnet, if it can be shown that the solid unity of the outflowing wave can be maintained as completely upon three rhymes as upon two, then the restriction of the octave to two rhymes is simple pedantry. But he who would test the metrical necessity of the arrangement in the Shakespearean sonnet has only to make the experiment of writing a poem of two quatrains with a couplet, and then another poem of four quatrains with a couplet, in order to see how inevitable is the metrical necessity of the Shakespearean number and arrangement for the achievement of the metrical effect which Shakespeare, Drayton and others sought. While in the poem of two quatrains the expected couplet has the sharp epigrammatic effect of the couplet in ordinary stanzas (such as that of *ottava rima*,

and as that of the "Venus and Adonis" stanza), destroying that pensive sweetness which is the characteristic of the Shakespearean sonnet, the poem of four quatrains is just sufficiently long for the expected pleasure of the couplet to be dispersed and wasted.

The quest of the Shakespearean sonnet is not, like that of the sonnet of octave and sestet, sonority, and, so to speak, metrical counterpoint, but sweetness; and the sweetest of all possible arrangements in English versification is a succession of decasyllabic quatrains in alternate rhymes knit together and clinched by a couplet—a couplet coming not so far from the initial verse as to lose its binding power, and yet not so near the initial verse that the ring of epigram disturbs the "linked sweetness long drawn out" of this movement, but sufficiently near to shed its influence over the poem back to the initial verse. A chief part of the pleasure of the Shakespearean sonnet is the expectance of the climacteric rest of the couplet at the end (just as a chief part of the pleasure of the sonnet of octave and sestet is the expectance of the answering ebb of the sestet when the close of the octave has been reached); and this expectance is gratified too early if it comes after two quatrains, while if it comes after a greater number of quatrains than three it is dispersed and wasted altogether.

The French sonnet has a regular Petrarchan octave with a sestet of three rhymes beginning with a couplet. The Spanish sonnet is also based on the pure Italian type, and is extremely graceful and airy. The same may be said of the Portuguese sonnet—a form of which the illustrious Camoens has left nearly three hundred examples. (T. W.-D.)

See also ENGLISH LITERATURE: 3, *Elizabethan*; Sidney Lee on the Elizabethan sonnet in Arber's *English Garner* (1904); J. A. Noble, *The Sonnet in England* (1893); M. Jasinski, *Histoire du sonnet en France* (1903); C. A. Lentzner, *Das Sonnett in d. eng. Dichtung bis Milton* (1886); S. Waddington, *English Sonnets by Living Writers* (1881), and *Sonnets of Europe* (1886); T. Hall Caine, *Sonnets of Three Centuries* (1882); William Sharp, *Sonnets of this Century* (1886), and *American Sonnets* (1889); John Dennis, *English Sonnets* (1873).

SONNINO, SIDNEY, BARON (1847–), Italian statesman and financier, was born at Florence on the 11th of March 1847. Entering the diplomatic service at an early age, he was appointed successively to the legations of Madrid, Vienna, Berlin and Versailles, but in 1871 returned to Italy, to devote himself to political and social studies. On his own initiative he conducted exhaustive inquiries into the conditions of the Sicilian peasants and of the Tuscan *métayers*, and in 1877 published in co-operation with Signor Leopoldo Franchetti a masterly work on Sicily (*La Sicilia*, Florence, 1877). In 1878 he founded a weekly economic review, *La Rassegna Settimanale*, which four years later he converted into a political daily journal. Elected deputy in 1880, he distinguished himself by trenchant criticism of Magliani's finance, and upon the fall of Magliani was for some months, in 1889, under-secretary of state for the treasury. In view of the severe monetary crisis of 1893 he was entrusted by Crispi with the portfolio of finance (December 1893), and in spite of determined opposition dealt energetically and successfully with the deficit of more than £6,000,000 then existing in the exchequer. By abolishing the illusory pensions fund, by applying and amending the Bank Laws, effecting economies, and increasing taxation upon corn, incomes from consolidated stock, salt and matches, he averted national bankruptcy, and placed Italian finance upon a sounder basis than at any time since the fall of the Right. Though averse from the policy of unlimited colonial expansion, he provided by a loan for the cost of the Abyssinian War in which the tactics of General Baratieri had involved the Crispi cabinet, but fell with Crispi after the disaster at Adowa (March 1896). Assuming then the leadership of the constitutional opposition, he combated the alliance between the Di Rudini cabinet and the subversive parties, criticized the financial schemes of the treasury minister, Luzzatti, and opposed the "democratic" finance of the first Pelloux administration as likely to endanger financial stability. After the modification of the Pelloux cabinet (May 1899) he became leader of the ministerial majority, and bore the brunt of the struggle

against Socialist obstruction in connexion with the Public Safety Bill. Upon the formation of the Zanardelli cabinet (Feb. 1901) he once more became leader of the constitutional opposition, and in the autumn of the year founded a daily organ, *Il Giornale d'Italia*, the better to propagate moderate Liberal ideas. Although highly esteemed for his integrity and genuine ability, it was not until February 1906 that he was called upon to form a ministry, on the fall of the Fortis cabinet. He immediately set about introducing certain urgent reforms, suppressed all subsidies to the press, and declared his intention of governing according to law and justice. In May, however, an adverse vote of the Chamber on a purely technical matter led to his resignation.

SONORA, a northern state of Mexico, bounded N. by the United States, E. by Chihuahua, S. by Sinaloa and W. by the Gulf of California. It is the second largest state in the republic, having an area of 76,900 sq. m. Pop. (1900), 221,682, a large part being Indian. The surface of the state is much broken by the Sierra Madre Occidental, which extends through it from north to south and covers its entire width with parallel ranges, enclosing fertile valleys. Four important rivers traverse the state from east to west with courses of 145 to 390 m. and discharge into the Gulf of California, viz.: the Altar, or Asunción, Sonora, Yaqui and Mayo. The longest is the Yaqui, which has its source on the eastern side of the Sierra Tarahumare in Chihuahua and breaks through several ranges of the Sierra Madre before reaching the gulf near Guaymas. The smaller tributaries of these rivers of Sonora are often only dry canyons in the dry season. Agriculture has been developed only to a limited extent in Sonora, because of its aridity, lack of irrigation facilities, lack of railways and roads, and the unsettled state of the country. The soil of the sierra valleys is fertile, and when it is irrigated forage and cereal crops may be grown in abundance. Sugar-cane, tobacco, maguey, cotton, in small quantities, and fruits are also produced. There are excellent pasture lands, especially in the upland districts, and stock-raising is an important and profitable industry. Land is held in large estates, some of them upwards of 100 sq. m. in area. The mineral resources include silver, gold, copper, lead, tin, iron and coal, and mining is the chief industry. The lack of transportation facilities has been partly relieved by the construction of a branch of the Southern Pacific (American) from Nogales southward to Guaymas and the Sinaloa frontier, from which it has been extended to Mazatlán. Guaymas is the only port of importance on the coast, but it has a large trade and is visited by the steamers of several lines. The capital of the state (since 1882) is Hermosillo (pop. 1900, 17,618), on the Sonora river, 110 m. north of Guaymas, with which it is connected by rail. It suffered much in 1865–1866 from the savage struggle between Imperialists and Republicans, and in subsequent partisan warfare. Other important towns are Alamos (pop. 1895, 6197), 132 m. E.S.E. of Guaymas, Moctezuma, 90 m. north of Hermosillo, and Ures, the old capital of Sonora and seat of a bishopric, 33 m. north-east of Hermosillo.

The first Jesuit mission in Sonora, founded among the Mayos in 1613, seems to have been the first permanent settlement in the state, although Coronado passed through it and its coast had been visited by early navigators. The hostility of certain tribes prevented its rapid settlement. Ures was founded in 1636, and Arizpe in 1648. Near the end of the century Sonora and Sinaloa were divided into two districts, in 1767 the Jesuit missions were secularized, in 1779 the government of the province was definitely organized by Caballero de Croix, and in 1783 Arizpe became the provincial capital. The bishopric of Sonora was created in 1781 with Arizpe as its seat. Up to this time the history of the province is little else than a record of savage warfare with the Apaches, Seris, Yaquis and other tribes. The development of rich gold and silver mines brought in more Spanish settlers, and then the record changes to one of partisan warfare, which continued down to the administration of President Porfirio Diaz.

SONPUR, a feudatory state of India, in the Orissa division of Bengal, to which it was transferred from the Central Provinces

in 1905. Area, 906 sq. m. Pop. (1901), 169,877, showing a decrease of 13% in the decade, due to the results of famine. Estimated revenue £8000, tribute £600. The chief is a Rajput of the Patna line. Rice and timber are exported, and iron ore is said to abound. The town of Sonpur is on the Mahanadi river just above the point where it enters Orissa. Pop. (1901), 8887.

SONSONATE, the capital of the department of Sonsonate, Salvador; on the river Sensunapan and the railway from San Salvador to the Pacific port of Acajutla, 13 m. south. Pop. (1905), about 17,000. Sonsonate is the centre of a rich agricultural district, and one of the busiest manufacturing towns in the republic. It produces cotton cloth, pottery, mats and baskets, boots and shoes, sugar, starch, cigars and spirits. Through Acajutla it exports coffee and sugar, and imports grain for distribution to all parts of the interior.

SOOT (O. Eng. *sot*, cf. Icel. *sot*, Dan. *sod*; possibly from root *sed*, to sit), the black substance produced in the process of the combustion of fuel and deposited in finely granulated particles on the interior of chimneys or pipes through which the smoke passes. Soot is a natural nitrogenous manure (*q.v.*), and its value depends on the ammonia salts contained in it.

SOPHIA (1630–1714), electress of Hanover, twelfth child of Frederick V., elector palatine of the Rhine, by his wife Elizabeth, a daughter of the English king James I., was born at the Hague on the 14th of October 1630. Residing after 1649 at Heidelberg with her brother, the restored elector palatine, Charles Louis, she was betrothed to George William afterwards duke of Lüneburg-Celle; but in 1658 she married his younger brother, Ernest Augustus, who became elector of Brunswick-Lüneburg, or Hanover, in 1692. Her married life was not a happy one. Her husband was unfaithful; three of her six sons fell in battle; and other family troubles included an abiding hostility between her and Sophia Dorothea, the wife of her eldest son, George Louis. Sophia became a widow in 1698, but before then her name had been mentioned in connexion with the English throne. When considering the Bill of Rights in 1689 the House of Commons refused to place her in the succession, and the matter rested until 1700 when the state of affairs in England was more serious. William III. was ill and childless; William, duke of Gloucester, the only surviving child of the princess Anne, had just died. The strong Protestant feeling in the country, the danger from the Stuarts, and the hostility of France, made it imperative to exclude all Roman Catholics from the throne; and the electress was the nearest heir who was a Protestant. Accordingly by the Act of Settlement of 1701 the English Crown, in default of issue from either William or Anne, was settled upon "the most excellent princess Sophia, electress and duchess-dowager of Hanover" and "the heirs of her body, being Protestant." Sophia watched affairs in England during the reign of Anne with great interest, although her son, the elector George Louis, objected to any interference in that country, and Anne disliked all mention of her successor. An angry letter from Anne possibly hastened Sophia's death, which took place at Herrenhausen on the 8th of June 1714; less than two months later her son, George Louis, became king of Great Britain and Ireland as George I. on the death of Anne. Sophia, who corresponded with Leibnitz, was a strong woman both mentally and physically, and possessed wide and cultured tastes.

See *Memoiren der Kurfürstin Sophie von Hannover*, edited by A. Köcher (Leipzig, 1879; Eng. trans., 1888); *Briefwechsel der Herzogin Sophie von Hannover mit ihrem Bruder*, &c., edited by E. Bodemann (Leipzig, 1885 and 1888); L. von Ranke, *Aus den Briefen der Herzogin von Orleans, Elisabeth Charlotte, an die Kurfürstin Sophie von Hannover* (Leipzig, 1870); E. Bodemann, *Aus den Briefen der Herzogin, Elisabeth Charlotte von Orleans, an die Kurfürstin Sophie von Hannover* (Hanover, 1891); R. Fester, *Kurfürstin Sophie von Hannover* (Hamburg, 1893); A. W. Ward, *The Electress Sophia and the Hanoverian Succession* (London, 1909); O. Klopp, *Der Fall des Hauses Stuart* (Vienna, 1875–1888); *Correspondance de Leibnitz avec l'Électrice Sophie*, edited by O. Klopp (Hanover, 1864–1875); and R. S. Rait, *Five Stuart Princesses* (London, 1902).

SOPHIA ALEKSYEEVNA (1657–1704), tsarevna and regent of Russia, was the third daughter of Tsar Alexius and Maria

Miloslavskaya. Educated on semi-ecclesiastical lines by the learned monk of Kiev, Polotsky, she emancipated herself betimes from the traditional tyranny of the *terem*, or women's quarters. Setting aside court etiquette, she had nursed her brother Tsar Theodore III. in his last illness, and publicly appeared at his obsequies, though it was usual only for the widow of the deceased and his successor to the throne to attend that ceremony. Three days after little Peter, then in his fourth year, had been raised to the throne, she won over the *stryeltsy*, or musketeers, who at her instigation burst into the Kreml, murdering everyone they met, including Artamon Matvyeev, Peter's chief supporter, and Ivan Naruishkin, the brother of the tsaritsa-regent Natalia, Peter's mother (May 15–17, 1682). When the rebellion was over there was found to be no government. Everyone was panic-stricken and in hiding except Sophia, and to her, as the only visible representative of authority, the court naturally turned for orders. She took it upon herself to pay off and pacify the *stryeltsy*, and secretly worked upon them to present (May 29) a petition to the council of state to the effect that her half-brother Ivan should be declared senior tsar, while Peter was degraded into the junior tsar. As Ivan was hopelessly infirm and half idiotic, it is plain that the absurd duumvirate was but a stepping-stone to the ambition of Sophia, who thus became the actual ruler of Russia. The *stryeltsy* were not only pardoned for their atrocities, but petted. A general amnesty in the most absolute terms was granted to them, and at their special request a triumphal column was erected in the Red Square of the Kreml, to commemorate their cowardly massacre of the partisans of Peter. When, however, instigated by their leader Prince Ivan Khovansky, who is suspected to have been aiming at the throne himself, and supported by the reactionary elements of the population, conspicuous among whom were the *raskolniks* or dissenters, they proceeded on the 5th of July to the great reception-hall of the palace in the Kreml to present a petition against all novelties, Sophia boldly faced them. Supported by her aunts and the patriarch, and secretly assured of the support of the orthodox half of the *stryeltsy*, she forbade all discussion and browbeat the rebels into submission. A later attempt on the part of Khovansky to overthrow her was anticipated and severely punished. By the 6th of November Sophia's triumph was complete. The conduct of foreign affairs she committed entirely to her paramour, Prince Vasily Golitsuin, while the crafty and experienced clerk of the council, Theodore Shaklovity, looked after domestic affairs and the treasury. Sophia's fondness for Golitsuin induced her to magnify his barely successful campaigns in the Crimea into brilliant triumphs which she richly rewarded, thus disgusting everyone who had the honour of the nation at heart. Most of the malcontents rested their hopes for the future on the young tsar Peter, who was the first to benefit by his sister's growing unpopularity. Sophia was shrewd enough to recognize that her position was becoming very insecure. When Peter reached man's estate she would only be in the way, and she was not the sort of woman who is easily thrust aside. She had crowned her little brothers in order that she might reign in their names. She had added her name to theirs in state documents, boldly subscribing herself "Sovereign Princess of all Russia." She had officially informed the doge of Venice that she was the co-regent of the tsars. And now the terrible term of her usurped authority was approaching. In her extremity she took council of Shaklovity, and it was agreed (1687) between them that the *stryeltsy* should be employed to dethrone Peter. The *stryeltsy*, however, received the whole project so coldly that it had to be abandoned. A second conspiracy to seize him in his bed (August 1689) was betrayed to Peter, and he fled to the fortress-monastery of Troitsa. Here all his friends rallied round him, including the bulk of the magnates, half the *stryeltsy*, and all the foreign mercenaries. From the 12th of August to the 7th of September Sophia endeavoured to set up a rival camp in the Kreml; but all her professed adherents gradually stole away from her. She was compelled to retire within the Novo-Dyeyichy monastery, but without

taking the veil. Nine years later (1698), on suspicion of being concerned in the rebellion of the *stryeltsy*, she was shorn a nun and imprisoned for life under military supervision. As "Sister Susannah" she disappeared from history. Russian historians are still divided in their opinion concerning this extraordinary woman. While some of them paint her in the darkest colours as an unprincipled adventuress, the representative of a new Byzantinism, others simply regard her as the victim of circumstances. Others, more indulgent still, acquit her of all blame; and a few, impressed by her indisputable energy and ability, evade a decision altogether by simply describing her as a prodigy.

See J. E. Zabyelin, *Domestic Conditions of the Russian Princes* (Rus.; Moscow, 1895); N. G. Ustryalov, *History of the Reign of Peter the Great* (Rus.; Petersburg, 1858); N. Y. Aristov, *The Moscow Rebellions during the Regency of Sophia* (Rus.; Warsaw, 1871); R. N. Bain, *The First Romanovs* (London, 1905). (R. N. B.)

SOPHIA DOROTHEA (1666–1726), wife of George Louis, elector of Hanover (George I. of England), only child of George William, duke of Brunswick-Lüneburg-Celle, by a Huguenot lady named Eleanore d'Olbreuzé (1639–1722), was born on the 15th of September 1666. George William had undertaken to remain unmarried, but his desire to improve the status of his mistress (whom in spite of his promise he married in 1676) and of his daughter greatly alarmed his relatives, as these proceedings threatened to hinder the contemplated union of the Lüneburg territories. However, in 1682, this difficulty was bridged over by the marriage of Sophia Dorothea with her cousin George Louis, son of Duke Ernest Augustus, who became elector of Hanover in 1692. This union was a very unhappy one. The relatives of George Louis, especially his mother, the electress Sophia, hated and despised his wife, and this feeling was soon shared by the prince himself. It was under these circumstances that Sophia Dorothea made the acquaintance of Count Philipp Christoph von Königsmark (*q.v.*), with whom her name is inseparably associated. Königsmark assisted her in one or two futile attempts to escape from Hanover, and rightly or wrongly was regarded as her lover. In 1694 the count was assassinated, and the princess was divorced and imprisoned at Ahlden, remaining in captivity until her death on the 23rd of November 1726. Sophia Dorothea is sometimes referred to as the "princess of Ahlden." Her two children were the English king, George II., and Sophia Dorothea, wife of Frederick William I. of Prussia, and mother of Frederick the Great. Sophia's infidelity to her husband is not absolutely proved, as it is probable that the letters which purport to have passed between Königsmark and herself are forgeries.

See *Briefwechsel des Grafen Königsmark und der Prinzessin Sophie Dorothea von Celle*, edited by W. F. Palmblad (Leipzig, 1847); A. F. H. Schaumann, *Sophie Dorothea Prinzessin von Ahlden*, and *Kurfürstin Sophie von Hannover* (Hanover, 1878); C. L. von Pöllnitz, *Histoire secrète de la duchesse d'Hanovre* (London, 1732); W. H. Wilkins, *The Love of an Uncrowned Queen* (London, 1900); A. Köcher, "Die Prinzessin von Ahlden," in the *Historische Zeitschrift* (Munich, 1882); Vicomte H. de Beaucaire, *Une Mésalliance dans la maison de Brunswick* (Paris, 1884); and A. D. Greenwood, *Lives of the Hanoverian Queens of England* (1909), vol. i.

SOPHISTS (from Gr. σοφιστής, literally, man of wisdom), the name given by the Greeks about the middle of the 5th century B.C. to certain teachers of a superior grade who, distinguishing themselves from philosophers on the one hand and from artists and craftsmen on the other, claimed to prepare their pupils, not for any particular study or profession, but for civic life. For nearly a hundred years the sophists held almost a monopoly of general or liberal education. Yet, within the limits of the profession, there was considerable diversity both of theory and of practice. Four principal varieties are distinguishable, and may be described as the sophistries of culture, of rhetoric, of politics, and of "eristic," *i.e.* disputation. Each of these predominated in its turn, though not to the exclusion of others, the sophistry of culture beginning about 447, and leading to the sophistry of eristic, and the sophistry of rhetoric taking root in central Greece about 427, and merging in the sophistry of politics. Further, since Socrates and the Socratics were educators, they too might

be, and in general were, regarded as sophists; but, as they conceived truth—so far as it was attainable—rather than success in life, in the law court, in the assembly, or in debate, to be the right end of intellectual effort, they were at variance with their rivals, and are commonly ranked by historians, not with the sophists, who confessedly despaired of knowledge, but with the philosophers, who, however unavailing, continued to seek it. With the establishment of the great philosophical schools—first, of the Academy, next of the Lyceum—the philosophers took the place of the sophists as the educators of Greece.

The sophistic movement was then, primarily, an attempt to provide a general or liberal education which should supplement the customary instruction in reading, writing, gymnastic and music. But, as the sophists of the first period chose for their instruments grammar, style, literature and oratory, while those of the second and third developments were professed rhetoricians, sophistry exercised an important influence upon literature. Then again, as the movement, taking its rise in the philosophical agnosticism which grew out of the early physical systems, was itself persistently sceptical, sophistry may be regarded as an interlude in the history of philosophy. Finally, the practice of rhetoric and eristic, which presently became prominent in sophistic teaching, had, or at any rate seemed to have, a mischievous effect upon conduct; and the charge of seeking, whether in exposition or in debate, not truth but victory—which charge was impressively urged against the sophists by Plato—grew into an accusation of holding and teaching immoral and unsocial doctrines, and in our own day has been the subject of eager controversy.

1. *Genesis and Development of Sophistry.*—Sophistry arose out of a crisis in philosophy. The earlier Ionian physicists, Thales, Anaximander and Anaximenes, in their attempts to trace the Multiplicity of things to a single material element, had been troubled by no misgivings about the possibility of knowledge. But, when Heraclitus to the assumption of fire as the single material cause added the doctrine that all things are in perpetual flux, he found himself obliged to admit that things cannot be known. Thus, though, in so far as he asserted his fundamental doctrine without doubt or qualification, he was a dogmatist, in all else he was a sceptic. Again, the Eleatic Parmenides, deriving from the theologian Xenophanes the distinction between *ἐπιστήμη* and *δόξα*, conceived that, whilst the One exists and is the object of knowledge, the Multiplicity of things becomes and is the object of opinion; but, when his successor Zeno provided the system with a logic, the consistent application of that logic resolved the fundamental doctrine into the single proposition "One is One," or, more exactly, into the single identity "One One." Thus Eleaticism, though professedly dogmatic, was inconsistent in its theory of the One and its attributes, and openly sceptical in regard to the world of nature. Lastly, the philosophers of the second physical succession—Empedocles, Anaxagoras, Leucippus—not directly attacking the great mystery of the One and the Many, but in virtue of a scientific instinct approaching it through the investigation of phenomena, were brought by their study of sensation to perceive and to proclaim the inadequacy of the organs of sense. Thus they too, despite their air of dogmatism, were in effect sceptics. In short, from different standpoints, the three philosophical successions had devised systems which were in reality sceptical, though they had none of them recognized the sceptical inference.

Towards the middle of the 5th century, however, Protagoras of Abdera, taking account of the teaching of the first, and possibly of the second, of the physical successions, and Gorgias of Leontini, starting from the teaching of the metaphysical succession of Elea, drew that sceptical inference from which the philosophers had shrunk. If, argued Protagoras in a treatise entitled *Truth*, all things are in flux, so that sensation is subjective, it follows that "Man is the measure of all things, of what is, that it is, and of what is not, that it is not"; in other words, there is no such thing as objective truth. Similarly, Gorgias, in a work *On Nature, or on the Nonent*, maintained

(a) that nothing is, (b) that, if anything is, it cannot be known, (c) that, if anything is and can be known, it cannot be expressed in speech; and the summaries which have been preserved by Sextus Empiricus (*Adv. Math.* vii. 65-87) and by the author of the *De Melisso*, &c. (chs. 5, 6), show that, in defending these propositions, Gorgias availed himself of the arguments which Zeno had used to discredit the popular belief in the existence of the Many; in other words, that Gorgias turned the destructive logic of Zeno against the constructive ontology of Parmenides, thereby not only reducing Eleaticism to nothingness, but also, until such time as a better logic than that of Zeno should be provided, precluding all philosophical inquiry whatsoever. Thus, whereas the representatives of the three successions had continued to regard themselves as philosophers or seekers after truth, Protagoras and Gorgias, plainly acknowledging their defeat, withdrew from the ungrateful struggle.

Meagre as were the results which the earlier thinkers had obtained, the extinction of philosophy just at the time when the liberal arts became more technical and consequently less available as employments of leisure, threatened to leave a blank in Hellenic life. Accordingly Protagoras, while with the one hand he put away philosophy, with the other offered a substitute. Emphasizing the function of the teacher, which with the philosophers had been subordinate, and proclaiming the right end of intellectual endeavour to be, not "truth" (*ἀλήθεια*) or "wisdom" (*σοφία*), which was unattainable, but "virtue" or "excellence" (*ἀρετή*), he sought to communicate, not a theory of the universe, but an aptitude for civic life. "The lesson which I have to teach," Plato makes him say (*Prot.* 318 E), "is prudence or good counsel, both in respect of domestic matters that the man may manage his household aright, and in respect of public affairs, that he may be thoroughly qualified to take part, both by deed and by word, in the business of the state. In other words, I profess to make men good citizens." As instruments of education Protagoras used grammar, style, poetry and oratory. Thus, whereas hitherto the young Greek, having completed his elementary training in the schools of the *γραμματιστής*, the *κθαριστής*, and the *παιδοδρίβης*, was left to prepare himself for his life's work as best he might, by philosophical speculation, by artistic practice, or otherwise, one who passed from the elementary schools to the lecture-room of Protagoras received from him a "higher education." The programme was exclusively literary, but for the moment it enabled Protagoras to satisfy the demand which he had discovered and evoked. Wherever he went, his lecture-room was crowded with admiring pupils, whose homage filled his purse and enhanced his reputation.

After Protagoras the most prominent of the literary sophists was Prodicus of Ceos. Establishing himself at Athens, he taught "virtue" or "excellence," in the sense attached to the word by Protagoras, partly by means of literary subjects; partly in discourses upon practical ethics. It is plain that Prodicus was an affected pedant; yet his simple conventional morality found favour, and Plato (*Rep.* 600 C) couples him with Protagoras in his testimony to the popularity of the sophists and their teaching.

At Athens, the centre of the intellectual life of Greece, there was soon to be found a host of sophists; some of them strangers, others citizens; some of them bred under Protagoras and Prodicus, others self-taught. In the teaching of the sophists of this younger generation two points are observable. First, their independence of philosophy and the arts being assured, though they continued to regard "civic excellence" as their aim, it was no longer necessary for them to make the assertion of its claims a principal element in their exposition. Secondly, for the sake of novelty they extended their range, including scientific and technical subjects, but handling them, and teaching their pupils to handle them, in a popular way. In this stage of sophistry then, the sophist, though not a specialist, trenched upon the provinces of specialists; and accordingly Plato (*Prot.* 318 E) makes Protagoras pointedly refer to sophists who, "when young men have made their escape from the arts, plunge them

once more into technical study, and teach them such subjects as arithmetic, astronomy, geometry and music." The sophist of whom the Platonic Protagoras is here thinking was Hippias of Elis, who gave popular lectures, not only upon the four subjects just mentioned, but also upon grammar, mythology, family history, archaeology, Homerology and the education of youth. In this polymath we see at once the degradation of the sophistry of culture and the link which connects Protagoras and Prodicus with the eristics, who at a later period taught, not, like Hippias, all branches of learning, but a universally applicable method of disputation.

Meanwhile, Gorgias of Leontini, who, as has been seen, had studied and rejected the philosophy of western Greece, gave to sophistry a new direction by bringing to the mother country the technical study of rhetoric—especially forensic rhetoric (Plato, *Gorg.* 454 B; cf. Aristotle, *Rhet.* 1354, b 26)—which study had begun in Sicily with Corax and Tisias nearly forty years before. Gorgias was already advanced in years and rich in honours when, in 427, he visited Athens as the head of an embassy sent to solicit aid against Syracuse. Received with acclamation, he spent the rest of his long life in central Greece, winning applause by the display of his oratorical gifts and acquiring wealth by the teaching of rhetoric. There is no evidence to show that at any period of his life he called himself a sophist; and, as Plato (*Gorg.* 449 A) makes him describe himself as a *ρήτωρ*, it is reasonable to suppose that he preferred that title. That he should do so was only natural, since his position as a teacher of rhetoric was already secure when Protagoras made his first appearance in the character of a sophist; and, as Protagoras, Prodicus and the rest of the sophists of culture offered a comprehensive education, of which oratory formed only a part, whilst Gorgias made no pretence of teaching "civic excellence" (Plato, *Meno*, 95 C), and found a substitute for philosophy, not in literature generally, but in the professional study of rhetoric alone, it would have been convenient if the distinction between sophistry and rhetoric had been maintained. But though, as will be seen hereafter, these two sorts of education were sometimes distinguished, Gorgias and those who succeeded him as teachers of rhetoric, such as Thrasymachus of Chalcedon and Polus of Agrigentum, were commonly called by the title which Protagoras had assumed and brought into familiar use.

Rhetorical sophistry, as taught by Gorgias with special reference to the requirements of the law courts, led by an easy transition to political sophistry. During the century which had elapsed since the expulsion of the Peisistratids and the establishment of the democracy, the Athenian constitution had developed with a rapidity which produced an oligarchical reaction, and the discussion of constitutional principles and precedents, always familiar to the citizen of Athens, was thus abnormally stimulated. The Peloponnesian War, too, not only added a deeper interest to ordinary questions of policy, but also caused the relations of dissident parties, of allied and belligerent states, of citizens and aliens, of bond and free, of Greeks and barbarians, to be eagerly debated in the light of present experience. It was only natural then that some of those who professed to prepare young Athenians for public life should give to their teaching a distinctively political direction; and accordingly we find Isocrates recognizing teachers of politics, and discriminating them at once from those earlier sophists who gave popular instruction in the arts and from the contemporary eristics. To this class, that of the political sophists, may be assigned Lycophron, Alcidas and Isocrates himself. For, though that celebrated personage would have liked to be called, not "sophist" but "political philosopher," and tried to fasten the name of "sophist" upon his opponents the Socratics, it is clear from his own statement that he was commonly ranked with the sophists, and that he had no claim, except on the score of superior popularity and success, to be dissociated from the other teachers of political rhetoric. It is true that he was not a political sophist of the vulgar type, that as a theorist he was honest and patriotic, and that, in addition to his fame as a teacher, he

had a distinct reputation as a man of letters; but he was a professor of political rhetoric, and, as such, in the phraseology of the day, a sophist. He had already reached the height of his fame when Plato opened a rival school at the Academy, and pointedly attacked him in the *Gorgias*, the *Phaedrus* and the *Republic*. Thenceforward, there was a perpetual controversy between the rhetorician and the philosopher, and the struggle of educational systems continued until, in the next generation, the philosophers were left in possession of the field.

While the sophistry of rhetoric led to the sophistry of politics, the sophistry of culture led to the sophistry of disputation. It has been seen that the range of subjects recognized by Protagoras and Prodicus gradually extended itself, until Hippias professed himself a teacher of all branches of learning, including in his list subjects taught by artists and professional men, but handling them from a popular or non-professional point of view. The successors of the polymath claimed to possess and to communicate, not the knowledge of all branches of learning, but an aptitude for dealing with all subjects, which aptitude should make the knowledge of any subject superfluous. In other words, they cultivated skill in disputation. Now skill in disputation is plainly a valuable accomplishment; and, as the Aristotelian logic grew out of the regulated discussions of the eristics and their pupils, the disputant sophistry of the 4th century deserves more attention and more respect than it usually receives from historians of Greek thought. But when men set themselves to cultivate skill in disputation, regarding the matter discussed not as a serious issue, but as a thesis upon which to practise their powers of controversy, they learn to pursue, not truth, but victory; and, their criterion of excellence having been thus perverted, they presently prefer ingenious fallacy to solid reasoning and the applause of bystanders to the consciousness of honest effort. Indeed, the sophists generally had a special predisposition to error of this sort, not only because sophistry was from the beginning a substitute for the pursuit of truth, but also because the successful professor, travelling from city to city, or settling abroad, could take no part in public affairs, and thus was not at every step reminded of the importance of the "material" element of exposition and reasoning. Paradox, however, soon becomes stale, and fallacy wearisome. Hence, despite its original popularity, eristical sophistry could not hold its ground. The man of the world who had cultivated it in his youth regarded it in riper years as a foolish pedantry, or at best as a propaedeutic exercise; while the serious student, necessarily preferring that form of disputation which recognized truth as the end of this, as of other intellectual processes, betook himself to one or other of the philosophies of the revival.

In order to complete this sketch of the development of sophistry in the latter half of the 5th century and the earlier half of the 4th, it is necessary next to take account of Socrates and the Socratics. A foe to philosophy and a renegade from art, Socrates took his departure from the same point as Protagoras, and moved in the same direction, that of the education of youth. Finding in the cultivation of "virtue" or "excellence" a substitute for the pursuit of scientific truth, and in disputation the sole means by which "virtue" or "excellence" could be attained, he resembled at once the sophists of culture and the sophists of eristic. But, inasmuch as the "virtue" or "excellence" which he sought was that of the man rather than that of the official, while the disputation which he practised had for its aim, not victory, but the elimination of error, the differences which separated him from the sophists of culture and the sophists of eristic were only less considerable than the resemblances which he bore to both; and further, though his whole time and attention were bestowed upon the education of young Athenians, his theory of the relations of teacher and pupil differed from that of the recognized professors of education, inasmuch as the taking of fees seemed to him to entail a basic surrender of the teacher's independence. The principal characteristics of Socrates's theory of education were accepted, *mutatis mutandis*, by the leading Socratics. With these resemblances to the contemporary professors of education, and with these

differences, were Socrates and the Socratics sophists or not? To this question there is no simple answer, yes or no. It is certain that Socrates's contemporaries regarded him as a sophist; and it was only reasonable that they should so regard him, because in opposition to the physicists of the past and the artists of the present he asserted the claims of higher education. But, though according to the phraseology of the time he was a sophist, he was not a typical sophist—his principle that, while scientific truth is unattainable by man, right opinion is the only basis of right action, clearly differentiating him from all the other professors of "virtue." Again, as the Socratics—Plato himself, when he established himself at the Academy, being no exception—were, like their master, educators rather than philosophers, and in their teaching laid especial stress upon discussion, they, too, were doubtless regarded as sophists, not by Isocrates only, but by their contemporaries in general; and it may be conjectured that the disputatious tendencies of the Megarian school made it all the more difficult for Plato and others to secure a proper appreciation of the difference between dialectic, or discussion with a view to the discovery of truth, and eristic, or discussion with a view to victory. Changing circumstances, however, carry with them changes in the meaning and application of words. Whereas, so long as philosophy was in abeyance Socrates and the Socratics were regarded as sophists of an abnormal sort, as soon as philosophy revived it was dimly perceived that, in so far as Socrates and the Socratics dissented from sophistry, they preserved the philosophical tradition. This being so, it was found convenient to revise the terminology of the past, and to include in the philosophical succession those who, though not philosophers, had cherished the sacred spark. As for Socrates, he ranked himself neither with the philosophers, who professed to know, nor with the sophists, who professed to teach; and, if he sometimes described himself as a *φιλόσοφος* he was careful to indicate that he pretended to no other knowledge than that of his own limitations.

It would seem then, (1) that popular nomenclature included under the term "sophist" all teachers—whether professors, or like Socrates, amateurs—who communicated, not artistic skill, nor philosophical theory, but a general or liberal education; (2) that, of those who were commonly accounted sophists, some professed culture, some forensic rhetoric, some political rhetoric, some eristic, some (*i.e.* the Socratics) dialectic; (3) that the differences between the different groups of sophists were not inconsiderable, and that in particular the teaching of the rhetoricians was distinct in origin, and, in so far as its aim was success in a special walk of life, distinct in character, from the more general teaching of the sophists of culture, the eristics, and the dialecticians, while the teaching of the dialecticians was discriminated from that of the rest, in so far as the aim of the dialecticians was truth, or at least the bettering of opinion; and, consequently, (4) that, in awarding praise and blame to sophistry and its representatives, the distinctive characteristics of the groups above enumerated must be studiously kept in view.

Lapse of time and change of circumstances brought with them not merely changes in the subjects taught, but also changes in the popular estimate of sophistry and sophists. The first and most obvious sentiment which sophistry evoked was an enthusiastic and admiring interest. The sophist seemed to his youthful hearers to open a new field of intellectual activity and thereby to add a fresh zest to existence. But in proportion to the fascination which he exercised upon the young was the distrust which he inspired in their less pliable elders. Not only were they dismayed by the novelty of the sophistical teaching, but also they vaguely perceived that it was subversive of authority, of the authority of the parent over the child as well as of the authority of the state over the citizen. Of the two conflicting sentiments, the favour of the young, gaining as years passed away, naturally prevailed; sophistry ceased to be novel, and attendance in the lecture-rooms of the sophists came to be thought not less necessary for the youth than attendance in the elementary schools for the boy. The lively enthusiasm

and the furious opposition which greeted Protagoras had now burnt themselves out, and before long the sophist was treated by the man of the world as a harmless, necessary pedagogue.

That sophistry must be studied in its historical development was clearly seen by Plato, whose dialogue called the *Sophist* contains a formal review of the changing phases and aspects of sophistical teaching. The subject which is discussed in that dialogue and its successor, the *Statesman*, being the question "Are sophist, statesman, and philosopher identical or different?" the Eleate who acts as protagonist seeks a definition of the term "sophist" by means of a series of divisions or dichotomies. In this way he is led to regard the sophist successively—(1) as a practitioner of that branch of mercenary persuasion in private which professes to impart "virtue" and exacts payment in the shape of a fee, in opposition to the flatterer who offers pleasure, asking for sustenance in return; (2) as a practitioner of that branch of mental trading which purveys from city to city discourses and lessons about "virtue," in opposition to the artist who similarly purveys discourses and lessons about the arts; (3) and (4) as a practitioner of those branches of mental trading, retail and wholesale, which purvey discourses and lessons about "virtue" within a city, in opposition to the artists who similarly purvey discourses and lessons about the arts; (5) as a practitioner of that branch of eristic which brings to the professor pecuniary emolument, eristic being the systematic form of antilogic, and dealing with justice, injustice and other abstractions, and antilogic being that form of disputation which uses question and answer in private, in opposition to forensic, which uses continuous discourse in the law-courts; (6) as a practitioner of that branch of education which purges away the vain conceit of wisdom by means of cross-examination, in opposition to the traditional method of reproof or admonition. These definitions being thus various, the Eleate notes that the sophist, in consideration of a fee, disputes, and teaches others to dispute, about things divine, cosmical, metaphysical, legal, political, technical—in fact, about everything—not having knowledge of them, because universal knowledge is unattainable; after which he is in a position to define the sophist (7) as a conscious impostor who, in private, by discontinuous discourse, compels his interlocutor to contradict himself, in opposition to the *δημολογικός*, who, in public, by continuous discourse, imposes upon crowds.

It is clear that the final definition is preferred, not because of any intrinsic superiority, but because it has a direct bearing upon the question "Are sophist, statesman and philosopher identical or different?" and that the various definitions represent different stages or forms of sophistry as conceived from different points of view. Thus the first and second definitions represent the founders of the sophistry of culture, Protagoras and Prodicus, from the respective points of view of the older Athenians, who disliked the new culture, and the younger Athenians, who admired it; the third and fourth definitions represent imitators to whom the note of itinerancy was not applicable; the fifth definition represents the earlier eristics, contemporaries of Socrates, whom it was necessary to distinguish from the teachers of forensic oratory; the sixth is framed to meet the anomalous case of Socrates, in whom many saw the typical sophist, though Plato conceives this view to be unfortunate; and the seventh and final definition, having in view eristical sophistry fully developed, distinguishes it from *δημολογική*, i.e. political rhetoric, but at the same time hints that, though *σοφιστική* and *δημολογική* may be discriminated, they are nevertheless near akin, the one being the ape of philosophy, the other the ape of statesmanship. In short, Plato traces the changes which, in less than a century, had taken place in the meaning of the term, partly through changes in the practice of the sophists, partly through changes in their surroundings and in public opinion, so as to show by a familiar instance that general terms which do not describe natural kinds cannot have a stable connotation.

Now it is easy to see that in this careful statement Plato recognizes three periods. The first four definitions represent the period of Protagoras, Prodicus, and their immediate successors, when the object sought was "virtue," "excellence," "culture," and the means to it was literature. The fifth and sixth definitions represent the close of the 5th century, when sophistry handled eristically, and perhaps, though Plato demurs to the inclusion, dialectically, questions of justice, injustice and the like, *δικανική* or forensic rhetoric being its proximate rival. The seventh definition represents the first half of the 4th century, when sophistry was eristical in a wider field, having for its rival, not forensic rhetoric, but the rhetoric of the assembly. Plato's classification of educational theories is then substantially the classification adopted in this article, though, whereas here, in accordance with well-attested popular usage, all the educational theories mentioned are included under the head of sophistry, Plato allows to rhetoric, forensic and political, an independent position, and hints that there are grounds for denying the title of sophist to the dialectician Socrates. Incidentally we gather two important facts—(1) that contemporary with the dialectic of Socrates there was an eristic, and (2) that this eristic was mainly applied to ethical questions. Finally, we may be sure that, if Plato was thus careful to distinguish the phases and aspects of sophistical development, he could never have fallen into the modern error of

bestowing upon those whom the Greeks called sophists either indiscriminate censure or indiscriminate laudation.

2. *Relations of Sophistry to Education, Literature and Philosophy.*—If then the sophists, from Protagoras to Isocrates, were before everything educators, it becomes necessary to inquire whether their labours marked or promoted an advance in educational theory and method. At the beginning of the 5th century B.C. every young Greek of the better sort already received rudimentary instruction, not only in music and gymnastics, but also in reading and writing. Further, in the colonies, and especially the colonies of the West, philosophy and art had done something for higher education. Thus in Italy the Pythagorean school was, in the fullest sense of the term, an educational institution; and in Sicily the rhetorical teaching of Corax and Tisias was presumably educational in the same sense as the teaching of Gorgias. But in central Greece, where, at any rate down to the Persian Wars, politics, domestic and foreign, were all-engrossing, and left the citizen little leisure for self-cultivation, the need of a higher education had hardly made itself felt. The overthrow of the Persian invaders changed all this. Henceforward the best of Greek art, philosophy, and literature gravitated to Athens, and with their concentration and consequent development came a general and growing demand for teaching. As has been seen, it was just at this period that philosophy and art ceased to be available for educational purposes, and accordingly the literary sophists were popular precisely because they offered advanced teaching which was neither philosophical nor artistic. Their recognition of the demand and their attempt to satisfy it are no small claims to distinction. That, whereas before the time of Protagoras there was little higher education in the colonies and less in central Greece, after his time attendance in the lecture-rooms of the sophists was the customary sequel to attendance in the elementary schools, is a fact which speaks for itself.

But this is not all. The education provided by the sophists of culture had positive merits. When Protagoras included in his course grammar, style, interpretation of the poets, and oratory, supplementing his own continuous expositions by disputations in which he and his pupils took part, he showed a not inadequate appreciation of the requisites of a literary education; and it may be conjectured that his comprehensive programme, which Prodicus and others extended, had something to do with the development of that versatility which was the most notable element in the Athenian character.

There is less to be said for the teachers of rhetoric, politics and eristic, who, in limiting themselves each to a single subject—the rhetoricians proper or forensic rhetoricians to one branch of oratory, the politicians or political rhetoricians to another, and the eristics to disputation—ceased to be educators and became instructors. Nevertheless, rhetoric and disputation, though at the present day strangely neglected in English schools and universities, are, within their limits, valuable instruments; and, as specialization in teaching does not necessarily imply specialization in learning, many of those who attended the lectures and the classes of a rhetorician or an eristic sought and found other instruction elsewhere. It would seem then that even in its decline sophistry had its educational use. But in any case it may be claimed for its professors that in the course of a century they discovered and turned to account most of the instruments of literary education.

With these considerable merits, normal sophistry had one defect, its indifference to truth. Despairing of philosophy—that is to say, of physical science—the sophists were prepared to go all lengths in scepticism. Accordingly the epideictic sophists in exposition, and the argumentative sophists in debate, one and all, studied, not matter but style, not accuracy but effect, not proof but persuasion. In short, in their hostility to science they refused to handle literature in a scientific spirit. That this defect was serious was dimly apprehended even by those who frequented and admired the lectures of the earlier sophists; that it was fatal was clearly seen by Socrates, who, himself commonly regarded as a sophist, emphatically reprehended,

not only the taking of fees, which was after all a mere incident, objectionable because it seemed to preclude independence of thought, but also the fundamental disregard of truth which infected every part and every phase of sophistical teaching. To these contemporary censures the modern critic cannot refuse his assent.

To literature and to oratory the sophists rendered good service. Themselves of necessity stylists, because their professional success largely depended upon skilful and effective exposition, the sophists both of culture and of rhetoric were professedly teachers of the rules of grammar and the principles of written and spoken discourse. Thus, by example as well as by precept, they not only taught their hearers to value literary and oratorical excellence, but also took the lead in fashioning the style of their time. Their influence in these respects was weighty and important. Whereas, when sophistry began, prose composition was hardly practised in central Greece, the sophists were still the leaders in literature and oratory when Plato wrote the *Republic*, and they had hardly lost their position when Demosthenes delivered the *Philippics*. In fact, it is not too much to say that it was the sophists who provided those great masters with their consummate instrument, and it detracts but little from the merit of the makers if they were themselves unable to draw from it its finer tones.

The relation of sophistry to philosophy was throughout one of pronounced hostility. From the days of Protagoras, when this hostility was triumphant and contemptuous, to the days of Isocrates, when it was jealous and bitter, the sophists were declared and consistent sceptics. But, although Protagoras and Gorgias had examined the teaching of their predecessors so far as to satisfy themselves of its futility and to draw the sceptical inference, their study of the great problem of the day was preliminary to their sophistry rather than a part of it; and, as the overthrow of philosophy was complete and the attractions of sophistry were all-powerful, the question "What is knowledge?" ceased for a time to claim or to receive attention. There is, then, no such thing as a "sophistical theory of knowledge." Similarly, the recognition of a "sophistical ethic" is, to say the least, misleading. It may have been that the sophists' preference of seeming to reality, of success to truth, had a mischievous effect upon the morality of the time; but it is clear that they had no common theory of ethics, and there is no warrant for the assumption that a sophist, as such, specially interested himself in ethical questions. When Protagoras asserted "civic excellence" or "virtue" to be the end of education, he neither expressed nor implied a theory of morality. Prodicus in his platitudes reflected the customary morality of the time. Gorgias said plainly that he did not teach "virtue." If Hippias, Polus and Thrasymachus defied conventional morality, they did so independently of one another, and in this, as in other matters, they were disputants maintaining paradoxical theses, rather than thinkers announcing heretical convictions. The morality of Isocrates bore a certain resemblance to that of Socrates. In short, the attitude of the sophists towards inquiry in general precluded them, collectively and individually, from attachment to any particular theory. Yet among the so-called sophists there were two who had philosophical leanings, as appears in their willingness to be called by the title of philosopher. First, Socrates, whilst he conceived that the physicists had mistaken the field of inquiry, absolute truth being unattainable, maintained, as has been seen, that one opinion was better than another, and that consistency of opinion, resulting in consistency of action, was the end which the human intellect properly proposes to itself. Hence, though an agnostic, he was not unwilling to be called a philosopher, in so far as he pursued such truth as was attainable by man. Secondly, when sophistry had begun to fall into contempt, the political rhetorician Isocrates claimed for himself the time-honoured designation of philosopher, "herein," says Plato, "resembling some tinker, bald-pated and short of stature, who, having made money, knocks off his chains, goes to the bath, buys a new suit, and then takes advantage of the poverty and desolation of his master's daughter

to urge upon her his odious addresses" (*Rep.* vi. 495 E). It will be seen, however, that neither Socrates nor Isocrates was philosopher in any strict sense of the word, the speculative aims of physicists and metaphysicians being foreign to the practical theories both of the one and of the other.

As for the classification of sophistical methods, so for their criticism, the testimony of Plato is all-important. It may be conjectured that, when he emerged from the purely Socratic phase of his earlier years, Plato gave himself to the study of contemporary methods of education and to the elaboration of an educational system of his own, and that it was in this way that he came to the metaphysical speculations of his maturity. It may be imagined further that, when he established himself at the Academy, his first care was to draw up a scheme of education, including arithmetic, geometry (plane and solid), astronomy, harmonics and dialectic, and that it was not until he had arranged for the carrying out of this programme that he devoted himself to the special functions of professor of philosophy. However this may be, we find amongst his writings—intermediate, as it would seem, between the Socratic conversations of his first period of literary activity and the metaphysical disquisitions of a later time—a series of dialogues which, however varied their ostensible subjects, agree in having a direct bearing upon education. Thus the *Protagoras* brings the educational theory of Protagoras and the sophists of culture face to face with the educational theory of Socrates, so as to expose the limitations of both; the *Gorgias* deals with the moral aspect of the teachings of the forensic rhetorician Gorgias and the political rhetorician Isocrates, and the intellectual aspect of their respective theories of education is handled in the *Phaedrus*; the *Meno* on the one hand exhibits the strength and the weakness of the teaching of Socrates, and on the other brings into view the makeshift method of those who, despising systematic teaching, regarded the practical politician as the true educator; the *Euthydemus* has for its subject the eristical method; finally, having in these dialogues characterized the current theories of education, Plato proceeds in the *Republic* to develop an original scheme. Plato's criticisms of the sophists are then, in the opinion of the present writer, no mere *obiter dicta*, introduced for purposes of literary adornment or dramatic effect, but rather the expressions of profound and reasoned conviction, and, as such, entitled at any rate to respect. For the details of Plato's critique the reader should go not to the summaries of commentators, but to the dialogues themselves. In this place it is sufficient to say that, while Plato accounts no education satisfactory which has not knowledge for its basis, he emphatically prefers the scepticism of Socrates, which, despairing of knowledge, seeks right opinion, to the scepticism of the sophists, which, despairing of knowledge, abandons the attempt to better existing beliefs.

3. *The Theory of Grote*.—The post-Platonic historians and critics, who, while they knew the earlier sophistry only through tradition, were eyewitnesses of the sophistry of the decadence, were more alive to the faults than to the virtues of the movement. Overlooking the differences which separated the humanists from the eristics, and both of these from the rhetoricians, and taking no account of Socrates, whom they regarded as a philosopher, they forgot the services which Protagoras and Prodicus, Gorgias and Isocrates had rendered to education and to literature, and included the whole profession in an indiscriminate and contemptuous censure. This prejudice, establishing itself in familiar speech, has descended from antiquity to modern times, colouring, when it does not distort, the narratives of biographers and the criticisms of commentators. "The sophists," says Grote, "are spoken of as a new class of men, or sometimes in language which implies a new doctrinal sect or school, as if they then sprang up in Greece for the first time—ostentatious impostors, flattering and duping the rich youth for their own personal gain, undermining the morality of Athens, public and private, and encouraging their pupils to the unscrupulous prosecution of ambition and cupidity. They are even affirmed to have succeeded in corrupting the general morality, so that Athens had become miserably degenerated and vicious in the latter years of the Peloponnesian War, as compared with what she was in the time of Miltiades and Aristides;" and, although amongst the pre-Grotian scholars there were some who saw as clearly as Grote himself that "the sophists are a much-calumniated race" (G. H. Lewes), it is certain that historians of philosophy, and editors of Plato, especially the "acumen plumbeum Stallbaumii," had given ample occasion for the energetic protest contained in the famous sixty-seventh chapter of Grote's *History of Greece*. Amongst the many merits of that

admirable scholar, it is one of the greatest that he has laid "the fiend called *die Sophistik*," that is to say, the theory that sophistry was an organized conspiracy against law and morals. Nevertheless, in this matter he is always an advocate; and it may be thought that, while he successfully disposes of the current slander, his description of his clients needs correction in some important particulars. Hence the following paragraphs, while they will resume and affirm his principal results, will qualify and impugn some of his positions.

In so far as he is critical, Grote leaves little to be desired. That the persons styled sophists "were not a sect or school, with common doctrines or method," is clear. Common doctrine, that is to say, common doctrine of a positive sort, they could not have, because, being sceptics, they had nothing which could be called positive doctrine; while there was a period when even their scepticism was in no wise distinctive, because they shared it with all or nearly all their contemporaries. Neither were they united by a common educational method, the end and the instruments of education being diversely conceived by Protagoras, Gorgias and Isocrates, to say nothing of the wider differences which separate these three from the eristics, and all the four normal types from the abnormal type represented by Socrates.

Again, it is certain that the theoretical and practical morality of the sophists, regarded as a class, was "neither above nor below the standard of the age." The taking of fees, the pride of professional success, and the teaching of rhetoric are no proofs either of conscious charlatanism or of ingrained depravity. Indeed, we have evidence of sound, if conventional, principle in Prodicus's apologue of the "Choice of Heracles," and of honourable, though eccentric, practice in the story of Protagoras's treatment of defaulting pupils. But, above all, it is antecedently certain that defection from the ordinary standard of morality would have precluded the success which the sophists unquestionably sought and won. In fact, public opinion made the morality of the sophists, rather than the sophists the morality of public opinion. Hence, even if we demur to the judgment of Grote that "Athens at the close of the Peloponnesian War was not more corrupt than Athens in the days of Miltiades and Aristides," we shall not "consider the sophists as the corrupters of Athenian morality," but rather with Plato lay the blame upon society itself, which, "in popular meetings, law courts, theatres, armies and other great gatherings, with uproarious censure and clamorous applause" (*Rep.* vi. 492), educates young and old, and fashions them according to its pleasure.

Nor can we regard "Plato and his followers as the authorized teachers of the Greek nation and the sophists as the dissenters." On the contrary, the sophists were in quiet possession of the field when Plato, returning to Athens, opened the rival school of the Academy; and, while their teaching in all respects accommodated itself to current opinion, his, in many matters, ran directly counter to it.

But if thus far Grote's protest against prevalent assumptions carries an immediate and unhesitating conviction, it may be doubted whether his positive statement can be accounted final. "The appearance of the sophists," he says, "was no new fact. . . . The paid teachers—whom modern writers set down as the sophists, and denounce as the modern pestilence of their age—were not distinguished in any marked or generic way from their predecessors." Now it is true that before 447 B.C., besides the teachers of writing, gymnastics and music, to whom the young Greek resorted for elementary instruction, there were artists and artisans who not only practised their crafts, but also communicated them to apprentices and pupils, and that accordingly the Platonic Protagoras recognizes in the gymnast Iccus, the physician Herodicus, and the musicians Agathocles and Pythocles, forerunners of the sophists. But the forerunners of the sophists are not to be confounded with the sophists themselves, and the difference between them is not far to seek. Though some of those who resorted to the gymnasts, physicians and musicians derived from them such

substitute for "higher education" as was before 447 generally obtainable, it was only incidentally that professional men and artists communicated anything which could be called by that name. Contrariwise, the sophists were always and essentially professors of the higher education; and, although in process of time specialization assimilated sophistry to the arts, at the outset at any rate, its declared aim—the cultivation of the civic character—sufficiently distinguished sophistical education both from professional instruction and from artistic training. It is true too that in some of the colonies philosophy had busied itself with higher education; but here again the forerunners of the sophists are easily distinguished from the sophists, since the sophists condemned not only the scientific speculations of their predecessors, but also their philosophical aims, and offered to the Greek world a new employment for leisure, a new intellectual ambition.

Nor is it altogether correct to say that "the persons styled sophists had no principles common to them all and distinguishing them from others." Various as were the phases through which sophistry passed between the middle of the 5th century and the middle of the 4th, the sophists—Socrates himself being no exception—had in their declared antagonism to philosophy a common characteristic; and, if in the interval, philosophical speculation being temporarily suspended, scepticism ceased for the time to be peculiar, at the outset, when Protagoras and Gorgias broke with the physicists, and in the sequel, when Plato raised the cry of "back to Parmenides," this common characteristic was distinctive.

Further, it may be doubted whether Grote is sufficiently careful to distinguish between the charges brought against the sophists personally and the criticism of their educational methods. When the sophists are represented as conscious imposters who "poisoned and demoralized by corrupt teaching the Athenian moral character," he has, as has been seen, an easy and complete reply. But the question still remains—Was the education provided by Protagoras, by Gorgias, by Isocrates, by the eristics and by Socrates, good, bad or indifferent? And, though the modern critic will not be prepared with Plato to deny the name of education to all teaching which is not based upon an ontology, it may nevertheless be thought that normal sophistry—as opposed to the sophistry of Socrates—was in various degrees unsatisfactory, in so far as it tacitly or confessedly ignored the "material" element of exposition by reasoning.

And if Grote overlooks important agreements he seems also to understate important differences. Regarding Protagoras, Gorgias and Isocrates as types of one and the same sophistry (pp. 487, 493, 495, 499, 544, 2nd ed.), and neglecting as slander or exaggeration all the evidence in regard to the sophistry of eristic (p. 540), he conceives that the sophists undertook "to educate young men so as to make them better qualified for statesmen or ministers," and that "that which stood most prominent in the teaching of Gorgias and the other sophists was, that they cultivated and improved the powers of public speaking in their pupils." Excellent as a statement of the aim and method of Isocrates, and tolerable as a statement of those of Gorgias, these phrases are inexact if applied to Protagoras, who, making "civic virtue" his aim, regarded statesmanship and administration as parts of "civic virtue", and consequently assigned to oratory no more than a subordinate place in his programme, while to the eristics—whose existence is attested not only by Plato, but also by Isocrates and Aristotle—and to Socrates—whom Grote himself accounts a sophist—the description is plainly and palpably inappropriate.

Grote's note about the eristical sophists is perhaps the least satisfactory part of his exposition. That "there were in Athens persons who abused the dialectical exercise for frivolous puzzles" he admits; but "to treat Euthydemus and Dionysodorus as samples of 'the Sophists' is," he continues, "altogether unwarrantable." It would seem, then, that, while he regards rhetoric as the function of normal sophistry, taking indifferently as his types Protagoras, Gorgias and Isocrates, he accounts Euthydemus and Dionysodorus (together with Socrates) as sophists, but as sophists of an abnormal sort, who may therefore be neglected. Now this view is inconsistent with the evidence of Plato, who, in the

Sophist, in his final and operative definition, gives prominence to the eristical element, and plainly accounts it the main characteristic not indeed of the sophistry of the 5th century, but of the sophistry of the 4th. It must be presumed, then, that, in virtue of his general suspicions of the Platonic testimony, Grote in this matter leaves the *Sophist* out of account. There is, however, another theory of the significance of Plato's allusions to eristical sophistry, that of Professor H. Sidgwick, whose brilliant defence of Grote is an indispensable supplement to the original document. Giving a hearty general assent to Grote's theory, Sidgwick nevertheless introduces qualifications similar to some of those which are suggested in this article. In particular he allows that "there was at any rate enough of charlatanism in Protagoras and Hippias to prevent any ardour for their historical reputation," that the sophists generally "had in their lifetime more success than they deserved," that it was "antagonism to their teaching which developed the genius of Socrates," and, above all, that, "in his anxiety to do justice to the Sophist, Grote laid more stress than is at all necessary on the partisanship of Plato." Now this last admission precludes Sidgwick from neglecting, as Grote had done, the evidence of the *Euthydemus*. Pointing out that the sophists of that dialogue "profess *εἰς ἀρετῆς ἐπιμέλειαν προτρέφει* by means of dialogue," that "they challenge the interlocutor *ὑπέχειν λόγον*," that "their examples are drawn from common objects and vulgar trades," that "they maintain positions that we know to have been held by Megarians and Cynics," he infers that "what we have here presented to us as 'sophistic' is neither more nor less than a caricature of the Megarian logic"; and further, on the ground that "the whole conception of Socrates and his effect on his contemporaries, as all authorities combine to represent it, requires us to assume that his manner of discourse was quite novel, that no one before had systematically attempted to show men their ignorance of what they believed themselves to know," he is "disposed to think that the art of disputation which is ascribed to sophists in the *Euthydemus* and the *Sophistes* (and exhaustively analysed by Aristotle in the *Περὶ σοφιστικῶν ἐλέγχων*) originated entirely with Socrates, and that he is altogether responsible for the form at least of this second species of sophistic." To this theory the present writer is unable to subscribe. That Plato was not careful to distinguish the Megarians and the Cynics from the eristical sophists, and that the disputants of the 4th century affected some of the mannerisms of the greatest disputant of the 5th century, he willingly concedes. But he cannot allow either that the Megarians and the Cynics were the only eristics, or that eristical sophistry began with Socrates. Plainly this is not the place for a full examination of the question; yet it may be remarked—(1) that the previous history of the sophists of the *Euthydemus*, who had been professors of tactics (Xenophon, *Mem.* iii. 1, 1), swordsmanship, and forensic argumentation, implies that they came to eristic not from the sophistry of Socrates, but from that of the later humanists, polymaths of the type of Hippias; (2) that the fifth and sixth definitions of the *Sophist*, in which "that branch of eristic which brings pecuniary gain to the practitioner" is opposed to the "patience-trying, purgative elenchus" of Socrates, indicate that contemporary with Socrates there were eristics whose aims were not his; (3) that, whereas the sophist of the final definition "disputes, and teaches others to dispute, about things divine, cosmical, metaphysical, legal, political, technical, in fact, about all things," we have no ground for supposing that the Megarians and the Cynics used their eristic for any purpose except the defence of their logical heresies.

Nor is it possible to accept the statements that "the splendid genius, the lasting influence, and the reiterated polemics of Plato have stamped the name sophist upon the men against whom he wrote as if it were their recognized, legitimate and peculiar designation," and that "Plato not only stole the name out of general circulation, in order to fasten it specially upon his opponents the paid teachers, but also connected with it express discreditable attributes which formed no part of its primitive and recognized meaning and were altogether distinct from, though grafted upon, the vague sentiment of dislike associated with it." That is to say, Grote supposes that for at least eight and forty years, from 447 to 399, the paid professors had no professional title; that, this period having elapsed, a youthful opponent succeeded in fastening an uncomplimentary title not only upon the contemporary teachers, but also, retrospectively, upon their predecessors; and that, artfully enhancing the indignity of the title affixed, he thus obscured, perverted and effaced the records and the memories of the past. Manifestly all three propositions are antecedently improbable. But more than this: whereas in the nomenclature of Plato's contemporaries Protagoras, Gorgias, Socrates, Dionysodorus and Isocrates were all of them sophists, Plato himself, in his careful investigation summarized above, limits the meaning of the term so that it

shall include the humanists and the eristics only. Now, if his use of the term was stricter than the customary use, he can hardly be held answerable for the latter.

Nor is Grote altogether just in his account of Plato's attitude towards the several sophists, or altogether judicious in his appreciation of Plato's testimony. However contemptuous in his portraiture of Hippias and Dionysodorus, however severe in his polemic against Isocrates, Plato regards Protagoras with admiration and Gorgias with respect. While he emphasizes in the later sophists the consequences of the fundamental error of sophistry—its indifference to truth—he does honour to the genius and the originality of the leaders of the movement. Indeed, the author of this article finds in the writings of Plato a grave and discriminating study of the several forms of sophistry, and no trace whatsoever of that blind hostility which should warrant us in neglecting his clear and precise evidence.

In a word, the present writer agrees with Grote that the sophists were not a sect or school with common doctrine or method; that their theoretical and practical morality was neither above nor below that of their age, being, in fact, determined by it; and that Plato and his followers are not to be regarded as the authorized teachers of the Greek nation, nor the sophists as the dissenters, but vice versa. At the same time, in opposition to Grote, he maintains that the appearance of the sophists marked a new departure, in so far as they were the first professors of "higher education" as such; that they agreed in the rejection of "philosophy"; that the education which they severally gave was open to criticism, inasmuch as, with the exception of Socrates, they attached too much importance to the form, too little to the matter, of their discourses and arguments; that humanism, rhetoric, politic and disputation were characteristic not of all sophists collectively, but of sections of the profession; that Plato was not the first to give a special meaning to the term "sophist" and to affix it upon the professors of education; and, finally, that Plato's evidence is in all essentials trustworthy.

BIBLIOGRAPHY.—On the significance of the sophistical movement, see E. Zeller, *Philosophie d. Griechen*, i. 932-1041 (4th ed., Leipzig, 1876); *Presocratic Philosophy*, ii. 394-516 (London, 1881); G. Grote, *History of Greece*, ch. lxvii. (London, 1851, &c.); E. M. Cope, "On the Sophists," and "On the Sophistical Rhetoric," in *Journ. Class. and Sac. Philol.* vol. ii. (Cambridge, 1855), and vol. iii. (1857), an erudite but inconclusive reply to Grote; H. Sidgwick, "The Sophists," in *Journ. of Philol.*, vol. iv. (Cambridge, 1872), and vol. v. (1874), a brilliant defence of Grote; A. W. Benn, *The Greek Philosophers* i. 53-107 (London, 1882). For lists of treatises upon the life and teaching of particular sophists, see Ueberweg, *Grundriss d. Gesch. d. Philos.*, i. §§ 27-32 (*History of Philosophy*, London, 1880). On the later use of the term "sophist," see RHECTORIC. (H. JA.)

SOPHOCLES (495-406 B.C.), Greek tragic poet, was born at Colonus in the neighbourhood of Athens. His father's name was Sophillus; and the family burial-place is said to have been about a mile and a half from the city on the Decelean Way. The date assigned for the poet's birth is in accordance with the tale that young Sophocles, then a pupil of the musician Lamprus, was chosen to lead the chorus of boys in the celebration of the victory of Salamis (480 B.C.). The time of his death is fixed by the allusions to it in the *Frogs* of Aristophanes and in the *Muses*, a lost play of Phrynichus, the comic poet, which were both produced in 405 B.C., shortly before the capture of Athens. And the legend which implies that Lysander allowed him funeral honours is one of those which, like the story of Alexander and Pindar's house at Thebes, we can at least wish to be founded on fact, though we should probably substitute Agis for Lysander. Apart from tragic victories, the event of Sophocles' life most fully authenticated is his appointment at the age of fifty-five as one of the generals who served with Pericles in the Samian War (440-439 B.C.). Conjecture has been rife as to the possibility of his here improving acquaintance with Herodotus, whom he probably met some years earlier at Athens. But the distich quoted by Plutarch—

Ἦνδ' Ἰπρόδοτῳ τεύξεν Σοφοκλῆς ἑτέων ἄν
Πέντ' ἐπὶ πενήκοντα—

is a slight ground on which to reject the stronger tradition according to which Herodotus was ere this established at Thuri;

and the coincidences in their writings may be accounted for by their having drawn from a common source. The fact of Sophocles' generalship is the less surprising if taken in connexion with the interesting remark of his biographer (whose *Life*, though absent from the earliest MS. through some mischance, bears marks of an Alexandrian origin) that he took his full share of civic duties, and even served on foreign embassies. The large acquaintance-ship which this implies, not only in Athens, but in Ionic cities generally, is a point of main importance in considering the opportunities of information at his command. And, if we credit this assertion, we are the more at liberty to doubt the other statement, though it is not incredible, that his appointment as general was due to the political wisdom of his *Antigone*.

The testimony borne by Aristophanes in the *Frogs* to the amiability of the poet's temper (ὁ δ' εὐκόλος μὲν ἐνθάδ', εὐκόλος δ' ἐκέει) agrees with the record of his biographer that he was universally beloved. And the anecdote recalled by Cephalus in Plato's *Republic*, that Sophocles welcomed the release from the passions which is brought by age, accords with the spirit of his famous Ode to Love in the *Antigone*. The Sophocles who, according to Aristotle (*Rhet.* iii. 18), said of the government of the Four Hundred that it was the better of two bad alternatives (probably the same who was one of the *probuloi*), may or may not have been the poet. Other gossiping stories are hardly worth repeating—as that Pericles rebuked his love of pleasure and thought him a bad general, though a good poet; that he humorously boasted of his own "generalship" in affairs of love; or that he said of Aeschylus that he was often right without knowing it, and that Euripides represented men as they are, not as they ought to be. (This last anecdote has the authority of Aristotle.) Such trifles rather reflect contemporary or subsequent impressions of a superficial kind than tell us anything about the man or the dramatist. The gibe of Aristophanes (*Pax* 695 seq.), that Sophocles in his old age was become a very Simonides in his love for gain, may turn on some perversion of fact, without being altogether fair to either poet. It is certainly irreconcilable with the remark (*Vit. anon.*) that in spite of pressing invitations he refused to leave Athens for kings' courts. And the story of his indictment by his son Iophon for incompetence to manage his affairs—to which Cicero has given some weight by quoting it in the *De senectute*—appears to be really traceable to Satyrus (fl. c. 200 B.C.), the same author who gave publicity to the most ridiculous of the various absurd accounts of the poet's death—that his breath failed him for want of a pause in reading some passage of the *Antigone*. Satyrus is at least the sole authority for the defence of the aged poet, who, after reciting passages from the *Oed. Col.*, is supposed to have said to his accusers, "If I am Sophocles I am no dotard, and if I dote I am not Sophocles." On the other hand, we need not the testimony of biographers to assure us that he was devoted to Athens and renowned for piety. He is said to have been priest of the hero Alcon, and himself to have received divine honours after death.

That the duty of managing the actors as well as of training the chorus belonged to the author is well known. But did Aeschylus act in his own plays? This certainly is implied in the tradition that Sophocles, because of the weakness of his voice, was the first poet who desisted from doing so. In his *Thamyris*, however, he is said to have performed on the lyre to admiration, and in his *Nausicaa* (perhaps as coryphaeus) to have played gracefully the game of ball. Various minor improvements in decoration and stage carpentry are attributed to him—whether truly or not who can tell? It is more interesting, if true, that he wrote his plays having certain actors in his eye; that he formed an association for the promotion of liberal culture; and that he was the first to introduce three actors on the stage. It is asserted on the authority of Aristoxenus that Sophocles was also the first to employ Phrygian melodies. And it is easy to believe that *Aj.* 693 seq., *Trach.* 205 seq., were sung to Phrygian music, though there are strains in Aeschylus (e.g. *Choeph.* 152 seq., 423 seq.) which it is hard to distinguish essentially from these. Ancient critics had also noted his familiarity with Homer, especially with the *Odyssey*, his power

of selection and of extracting an exquisite grace from all he touched (whence he was named the "Attic Bee"), his mingled felicity and boldness, and, above all, his subtle delineation of human nature and feeling. They observed that the balanced proportions and fine articulation of his work are such that in a single half line or phrase he often conveys the impression of an entire character. Nor is this verdict of antiquity likely to be reversed by modern criticism.

His minor poems, elegies, paeans, &c., have all perished; and of his hundred and odd dramas only seven remain. These all belong to the period of his maturity (he had no decline); and not only the titles but some scanty fragments of more than ninety others have been preserved. Several of these were, of course, satyric dramas. And this recalls a point of some importance, which has been urged on the authority of Suidas, who says that "Sophocles began the practice of pitting play against play, instead of the tetralogy." If it were meant that Sophocles did not exhibit tetralogies, this statement would have simply to be rejected. For the word of Suidas (A.D. 950) has no weight against quotations from the lists of tragic victories (*διδασκαλῖαι*), which there is no other reason for discrediting. It is distinctly asserted on the authority of the *διδασκαλῖαι* that the *Bacchae* of Euripides, certainly as late as any play of Sophocles, was one of a trilogy or tetralogy. And if the custom was thus maintained for so long it was clearly impossible for any single competitor to break through it. But it seems probable that the trilogy had ceased to be the continuous development of one legend or cycle of legends—"presenting Thebes or Pelops' line"—if, indeed, it ever was so exclusively; and if a Sophoclean tetralogy was still linked together by some subtle bond of tragic thought or feeling, this would not affect the criticism of each play considered as an artistic whole. At the same time it appears that the satyric drama lost its grosser features and became more or less assimilated to the milder form of tragedy. And these changes, or something like them, may have given rise to the statement in Suidas.

The small number of tragic victories attributed to Sophocles, in proportion to the number of his plays, is only intelligible on the supposition that the dramas were presented in groups.

If the diction of Sophocles sometimes reminds his readers of the *Odyssey*, the subjects of his plays were more frequently chosen from those later epics which subsequently came to be embodied in the epic cycle—such as the *Aethiopsis*, the *Little Iliad*, the *Iliupersis*, the *Cypria*, the *Nosti*, the *Telegonia* (all revolving round the tale of Troy), the *Thebaica*, the *Οἰχαλίας ἄλωσις*, and others, including probably, though there is no mention of such a thing, some early version of the Argonautic story. In one or other of these heroic poems the legends of all the great cities of Hellas were by this time embodied; and though there must also have been a cloud of oral tradition floating over many a sacred spot, Sophocles does not seem, unless in his *Oedipus Coloneus*, to have directly drawn from this. He was content to quarry from the epic rhapsodies the materials for his more concentrated art, much as Shakespeare made use of Hollingshed or Plutarch, or as the subjects of Tennyson's *Idylls of the King* were taken from Sir Thomas Malory. As Sophocles has been accused of narrowing the range of tragic sympathy from Hellas to Athens, it deserves mention here that, of some hundred subjects of plays attributed to him, fifteen only are connected with Attica, while exactly the same number belong to the tale of Argos, twelve are Argonautic, and thirty Trojan. Even Corinthian heroes (Bellerophon, Polyidus) are not left out. It seems probable on the whole that, within the limits allowed by convention, Sophocles was guided simply by his instinctive perception of the tragic capabilities of a particular fable.

To say that subsidiary or collateral motives were never present to Sophocles in the selection of a subject would, however, be beyond the mark. His first drama, the *Triptolemus*, must have been full of local colouring; the *Ajax* appealed powerfully to the national pride; and in the *Oedipus Coloneus* some faint echoes even of oligarchical partisanship may be possibly discerned

(see below). But, even where they existed, such motives were collateral and subsidiary; they were never primary. All else was subordinated to the dramatic, or, in other words, the purely human, interest of the fable. This central interest is even more dominant and pervading in Sophocles than the otherwise supreme influence of religious and ethical ideas. The idea of destiny, for example, was of course inseparable from Greek tragedy. Its prevalence was one of the conditions which presided over the art from its birth, and, unlike Aeschylus, who wrestles with gods, Sophocles simply accepts it, both as a *datum* of tradition and a fact of life. But in the free handling of Sophocles even fate and providence are adminicular to tragic art. They are instruments through which sympathetic emotion is awakened, deepened, intensified. And, while the vision of the eternal and unwritten laws was holier yet, for it was not the creation of any former age, but rose and culminated with the Sophoclean drama, still to the poet and his Periclean audience this was no abstract notion, but was inseparable from their impassioned contemplation of the life of man—so great and yet so helpless, aiming so high and falling down so far, a plaything of the gods and yet essentially divine. This lofty vision subdued with the serenity of awe the terror and pity of the scene, but from neither could it take a single tremor or a single tear. Emotion was the element in which Greek tragedy lived and moved, albeit an emotion that was curbed to a serene stillness through its very depth and intensity.

The final estimate of Sophoclean tragedy must largely depend upon the mode in which his treatment of destiny is conceived. That Aeschylus had risen on the wings of faith to a height of prophetic vision, from whence he saw the triumph of equity and the defeat of wrong as an eternal process moving on toward one divine event—that he realized sin, retribution, responsibility as no other ancient did—may be gladly conceded. But it has been argued that because Sophocles is saddened by glancing down again at actual life—because in the fatalism of the old fables he finds the reflection of a truth—he in so far takes a step backward as a tragic artist. This remark is not altogether just. His value for what is highest in man is none the less because he strips it of earthly rewards, nor is his reverence for eternal law less deep because he knows that its workings are sometimes pitiless. Nor, once more, does he disbelieve in Providence, because experience has shown him that the end towards which the supreme powers lead forth mankind is still unseen. Not only the utter devotion of Antigone, but the lacerated innocence of Oedipus and Deianira, the tempted truth of Neoptolemus, the essential nobility of Ajax, leave an impress on the heart which is ineffaceable, and must elevate and purify while it remains. In one respect, however, it must be admitted that Sophocles is not before his age. There is an element of unrelieved vindictiveness, not merely inherent in the fables, but inseparable from the poet's handling of some themes, which is only too consistent with the temper of the "tyrant city." Aeschylus represents this with equal dramatic vividness, but he associates it not with heroism, but with crime.

Sophocles is often praised for skilful construction. But the secret of his skill depends in large measure on the profound way in which the central situation in each of his fables has been conceived and felt. Concentration is the distinguishing note of tragedy, and it is by greater concentration that Sophocles is distinguished from other tragic poets. In the *Septem contra Thebas* or the *Prometheus* of Aeschylus there is still somewhat of epic enlargement and breadth; in the *Hecuba* and other dramas of Euripides separate scenes have an idyllic beauty and tenderness which affect us more than the progress of the action as a whole, a defect which the poet sometimes tries to compensate by some novel *dénouement* or catastrophe. But in following a Sophoclean tragedy we are carried steadily and swiftly onward, looking neither to the right nor to the left; the more elaborately any scene or single speech is wrought the more does it contribute to enhance the main emotion, and if there is a deliberate pause it is felt either as a welcome breathing space or as the calm of brooding expectancy.

The result of this method is the union, in the highest degree, of simplicity with complexity, of largeness of design with absolute finish, of grandeur with harmony. Superfluties are thrown off without an effort through the burning of the fire within. Crude elements are fused and made transparent. What look like ornaments are found to be inseparable from the organic whole. Each of the plays is admirable in structure, not because it is cleverly put together, but because it is so completely alive.

The seven extant tragedies probably owe their preservation to some selection made for educational purposes in Alexandrian times. A yet smaller "syllogè" of three plays (*Ajax*, *Electra*, *Oedipus Tyrannus*) continued current amongst Byzantine students and many more copies of these exist than is the case with the other four. Of these four the *Antigone* seems to have been the most popular, while an inner circle of readers were specially attracted by the *Oedipus Coloneus*.

No example of the poet's earliest manner has come down to us. The *Antigone* certainly belongs to the Periclean epoch, and while Creon's large professions (lines 175-190) have been supposed to reflect the policy of the Athenian statesman, the heroine's grand appeal to the unwritten laws may have been suggested by words which an Attic orator afterwards quoted as having been spoken by Pericles himself: "They say that Pericles once exhorted you that in the case of persons guilty of impiety you should observe not only the written laws, but also those unwritten, which are followed by the Eumolpidae in their instructions—laws which no man ever yet had power to abrogate, or dared to contradict, nor do the Eumolpidae themselves know who enacted them, for they believe that who so violates them must pay the penalty not only to man, but to the gods" ([Lysias] *contra Andocidem*, § x. p. 104).

Modern readers have thought it strange that Creon when convinced goes to bury Polynices before attempting to release Antigone. It is obvious how this was necessary to the catastrophe, but it is also true to character, for Creon is not moved by compunction for the maiden nor by anxiety on Haemon's account, but by the fear of retribution coming on himself and the state, because of the sacred law of sepulture which he has defied. Antigone is the martyr of natural affection and of the religion of the family. But, as Kaibel pointed out, she is also the high-born Cadmean maiden, whose defiance of the oppressor is accentuated by the pride of race. She despises Creon as an upstart, who has done outrage not only to eternal ordinance, but to the rights of the royal house.

The *Ajax*, that tragedy of wounded honour, still bears some traces of Aeschylean influence, and may be even earlier than the *Antigone*. But it strikes the peculiarly Sophoclean note, that the great and noble spirit, although through its own or others' errors it may be overclouded for a time and rejected by contemporaries amongst mankind, is notwithstanding accepted by the gods and shall be held in lasting veneration. The construction of the *Ajax* has been adversely criticized, but without sufficient reason. If it has not the concentration of the *Antigone*, or of the *Oedipus Tyrannus*, it has a continuous movement which culminates in the hero's suicide, and develops a fine depth of sympathetic emotion in the sequel.

In the *King Oedipus* the poet attains to the supreme height of dramatic concentration and tragic intensity. The drama seems to have been produced soon after the outbreak of the Peloponnesian War, but certainly not in the year of the plague—else Sophocles, like his predecessor Phrynichus, might be said to have reminded his countrymen too poignantly of their home troubles. "The unwritten laws" are now a theme for the chorus. The worship of the Delphic Apollo is associated with a profound sense of the value and sacredness of domestic purity, and in the command to drive out pollution there is possibly an implied reference to the expulsion of the Alcmaeonidae.

The *Electra*, a less powerful drama, is shown by the metrical indications to be somewhat later than the *Oedipus Rex*. The harshness of the *vendetta* is not relieved as in Aeschylus by long-drawn invocations of the dead, nor, as in Euripides, is it made a subject of casuistry. Electra's heroic impulse, the offspring

of filial love, through long endurance hardened into a "fixed idea," is irrepressible, and Orestes, supported by Pylades, goes directly to his aim in obedience to Apollo. But nothing can exceed the tenderness of the recognition scene—lines 1098–1321, and the description of the falsely reported chariot race (681–763) is full of spirit.

In the *Trachinian Maidens* there is a transition towards that milder pathos which Sophocles is said to have finally approved (*ἡθικώτατον καὶ ἀριστόν*). The fate of Deianira is tragic indeed. But in her treatment of her rival, Iole, there are modern touches reminding one of Shakespeare. The play may have been produced at a time not far removed from the peace of Nicias; and if this were so Deianira's prayer that her descendants may never undergo captivity—lines 303–305—might remind Athenian matrons of the captive Heracleids from Pylos, descendants through Hyllus of Deianira herself. The "modern" note is even more conspicuous in the *Philoctetes*, where the inward conflict in the mind of Neoptolemus, between ambition and friendship, is delineated with equal subtlety and force, and the contrast of the ingenuous youth with the aged solitary, in whom just resentment has become a dominant idea, shows great depth of psychological insight. The tragic catastrophe of the *Oedipus Tyrannus* and the *Trachiniae* is absent here. The contending interests are reconciled by the intervention of the deified Heracles. But even more clearly than in the *Ajax* the heroic sufferer, rejected by men, is accepted by the gods and destined to triumph in the end. The *Philoctetes* is known to have been produced in the year 408 B.C., when Sophocles was 87 years old. The *Oedipus Coloneus* is said to have been brought out after the death of Sophocles by his grandson in the archonship of Micon, 402 B.C.

The question naturally arises, why a work of such surpassing merit should not have appeared in the lifetime of the poet. The answer is conjectural, but acquires some probability when several facts are taken into one view. It is surely remarkable that in a drama which obviously appeals to Athenian patriotism, local sanctities should obtain prominence to the exclusion of the corresponding national shrines on the Acropolis. It has been thought that the aged poet felt a peculiar satisfaction in celebrating the beauty and sacredness of his native district. This may well have been so, but could hardly supply a sufficient motive for a work destined to be presented to the assembled Athenians in the Dionysiac theatre. But there was a crisis in Athenian politics when "Colonus of the Knights" acquired a national significance. Those who organized the constitution of the Four Hundred made the precinct of Poseidon at Colonus the place of meeting, and probably sacrificed at the very altar which is consecrated by Theseus in this play. There must have been some reason for this. May it not have been that the occupants of the whole region, including the Academy, belonged mostly to the oligarchic faction? May not those who honoured Colonus by frequenting it—lines 62 and 63—have belonged to the order of knighthood? The name Colonus Hippius (or *τῶν ἵππέων*) would then have an appropriate meaning, and the equestrian statue of the eponymous hero (line 59) would be symbolical. In times of political agitation Colonus would then be regarded like St Germain, as the aristocratic quarter, while the Peiraeus was that of the extreme democracy, a sort of Faubourg St Antoine. It was there that the counter-movement reached its culmination. If so much be granted, is it not possible that this play, so deeply tinged with oligarchic influence, may have been thought too dangerous, and consequently withheld from production until after the amnesty, when the name of Sophocles was universally beloved, and this work of his old age could be prudently made public by his descendant? The knights in Aristophanes (424 B.C.) make their special appeal to Poseidon of the chariot race and to the Athene of victory. The Coloniates celebrate the sons of Theseus as worshippers of Athene Hippias, and of Poseidon.

Theseus in Euripides (*Supplices*) is the first citizen of a republic. In this drama he is the king whose word is law, and he is warned by Oedipus to avoid the madness of revolutionary

change (lines 15361–538). The tragic story of Oedipus is resumed, but in a later and deeper strain of thoughtful emotion. Once more the noble spirit, rejected by man, is accepted by the gods. The eternal laws have been vindicated. Their decrees are irreversible, but the involuntary unconscious criminal is not finally condemned. He has no more hope in this world, but is in mysterious communion with unseen powers. The sufferer is now a holy person and an author of blessing. An approach is even made to the New Testament doctrine of the sacredness of sorrow.

Whatever may have been the nature of a Sophoclean tetralogy, the practice which at one time prevailed of describing the *Oedipus Rex*, *Oedipus Coloneus* and *Antigone* as "the Theban trilogy" was manifestly erroneous and misleading. The three plays belong to different periods in the life-work of the poet, and the *Antigone* is the earliest of the three.

The spectator of a Sophoclean tragedy was invited to witness the supreme crisis of an individual destiny, and was possessed at the outset with the circumstances of the decisive moment. Except in the *Trachiniae*, where the retrospective soliloquy of Deianira is intended to emphasize her lonely position, this exposition is effected through a brief dialogue, in which the protagonist may or may not take part. In the *Oedipus Tyrannus* the king's entrance and his colloquy with the aged priest introduce the audience at once to the action and to the chief person. In the *Ajax* and *Philoctetes* the entrance or discovery of the hero is made more impressive by being delayed. Immediately after the prologos the chorus enter, numbering fifteen, either chanting in procession as in the *Antigone* and *Oedipus Tyrannus*, or dispersedly as in the *Oedipus Coloneus* and *Philoctetes*, or, thirdly, as in the *Electra*, where, after entering silently during the monody of the heroine, and taking up their position in the orchestra, they address her one by one. With a remarkable exception, to be noted presently, the chorus, having once entered, remain to the end. They always stand in some carefully adjusted relation to the principal figure. The elders of Thebes, whose age and coldness throw into relief the fervour and the desolation of Antigone, are the very men to realize the calamity of Oedipus, and, while horror-stricken, to lament his fall. The rude Salaminian mariners are loyal to Ajax, but cannot enter into his grief. The Trachinian maidens would gladly support Deianira, who has won their hearts, but they are too young and inexperienced for the task. The noble Argive women can sympathize with the sorrows of Electra, but no sympathy can soothe her distress.

The parodos of the chorus is followed by the first scene or episode, with which the action may be said to begin. For in the course of this the spectator's interest is strongly roused by some new circumstance involving an unforeseen complication—the awakening of Ajax (*Aj.*), the burial of Polynices (*Ant.*), the dream of Clytaemnestra (*El.*), the dark utterance of Teiresias (*Oed. Tyr.*), the arrival of Lichas with Iole (*Trach.*), the report of Ismene announcing Creon's coming (*Oed. Col.*), the sudden entreaty of Philoctetes crossed by the entrance of the pretended mariner (*Phil.*). The action from this point onwards is like a steadily flowing stream into which a swift and turbulent tributary has suddenly fallen, and the interest advances with rapid and continuous climax until the culmination is reached and the catastrophe is certain. The manner in which this is done, through the interweaving of dialogue and narration with the various lyrical portions, is very different in different dramas, one of the principal charms of Sophocles being his power of ingenious variation in the employment of his resources. Not less admirable is the strength with which he sustains the interest after the *peripeteia*,¹ whether, as in the *Antigone*, by heaping sorrow upon sorrow, or, as in the first *Oedipus*, by passing from horror to tenderness and unlocking the fountain of tears. The extreme point of boldness in arrangement is reached in the *Ajax*, where the chorus and Tecmessa, having been warned of the impending

¹ A tragic action has five stages, whence the five acts of the modern drama: the start, the rise, the height, the change, the close.

danger, depart severally in quest of the vanished hero, and thus leave not only the stage but the orchestra vacant for the soliloquy that precedes his suicide.

No such general description as has been here attempted can give even a remote impression of the march of Sophoclean tragedy—by what subtle yet firm and strongly marked gradations the plot is unfolded; how stroke after stroke contributes to the harmonious totality of feeling; what vivid interplay, on the stage, in the orchestra, and between both, builds up the majestic, ever-moving spectacle. Examine, for example, the opening scene or *πρόλογος* of the *Oedipus Tyrannus*. Its function is merely to propound the situation; yet it is in itself a miniature drama. First there is the silent spectacle of the eager throng of suppliants at the palace gate—young children, youths and aged priests. To them the king appears, with royal condescension and true public zeal. The priest expresses their heartfelt loyalty, describes the distress of Thebes, and, extolling Oedipus's past services, implores him to exercise his consummate wisdom for the relief of his people. The king's reply unveils yet further his incessant watchfulness and anxious care for his subjects. And he discloses a new object to their expectancy and hope. Creon, a royal person, had been sent to Delphi, and should ere then have returned with the response of Apollo. At this all hearts are trembling in suspense, when Creon is seen approaching. He is wreathed with Apollo's laurel; he looks cheerfully. What has Phoebus said? Another moment of suspense is interposed. Then the oracle is repeated—so thrilling to the spectator who understands the story, so full of doubt and hope and dread to all the persons of the drama: "It is for the blood of Laius—his murderers are harboured in the land of Thebes. The country must be purged." That is the culminating point of the little tragedy. While Oedipus asks for information, while in gaiety of heart he undertakes the search, while he bids the folk of Cadmus to be summoned thither, the spectators have just time to take in the full significance of what has passed, which every word that is uttered sends further home. All this in 150 lines!

Or, once more, consider the employment of narrative by this great poet. The *Tyrannus* might be again adduced, but let us turn instead to the *Antigone* and the *Trachiniae*. The speech of the messenger in the *Antigone*, the speeches of Hyllus and the Nurse in the *Trachiniae*, occur at the supreme crisis of the two dramas. Yet there is no sense of any retardation in the action by the report of what has been happening elsewhere. Much rather the audience are carried breathlessly along, while each speaker brings before their mental vision the scene of which he had himself been part. It is a drama within the drama, an action rising from its starting-point in rapid climax, swift, full, concentrated, until that wave subsides, and is followed by a moment of expectation. Nor is this all. The narrative of the messenger is overheard by Eurydice, that of Hyllus is heard by Deianira, that of Nurse by the chorus of Maidens. And in each case a poignancy of tragic significance is added by this circumstance, while the speech of the Messenger in the *Antigone*, and that of Hyllus in a yet higher degree, bind together in one the twofold interest of an action which might otherwise seem in danger of distracting the spectator's sympathies.

So profound is the contrivance, or, to speak more accurately, such is the strength of central feeling and conception, which secures the grace of unity in complexity to the Sophoclean drama.

The proportion of the lyrics to the level dialogue is considerably less on the average in Sophocles than in Aeschylus, as might be expected from the development of the purely dramatic element, and the consequent subordination of the chorus to the protagonist. In the seven extant plays the lyrical portion ranges from one-fifth to nearly one-third, being highest in the *Antigone* and lowest in the *Oedipus Tyrannus*. The distribution of the lyrical parts is still more widely diversified. In the *Electra*, for instance, the chorus has less to do than in the *Oedipus Tyrannus*, although in the former the lyrics constitute

one-fourth, and in the latter only one-fifth of the whole. But then the part of *Electra* is favourable to lyrical outbursts, whereas it is only after the tragic change that Oedipus can appropriately pass from the stately *senarius* to the broken language of the *dochmiac* and the "lamenting" *anapaest*. The protagonists of the *Ajax* and the *Philoctetes* had also large opportunities for vocal display.

The union of strict symmetry with freedom and variety, which is throughout characteristic of the work of Sophocles, is especially noticeable in his handling of the tragic metres. In the iambics of his dialogue, as compared with those of Aeschylus, there is an advance which may be compared with the transition from "Marlowe's mighty line" to the subtler harmonies of Shakespeare. Felicitous pauses, the linking on of line to line, trisyllabic feet introduced for special effects, alliteration both hard and soft, length of speeches artfully suited to character and situation, adaptation of the caesura to the feeling expressed, are some of the points which occur most readily in thinking of his *senarii*. A minute speciality may be noted as illustrative of his manner in this respect. Where a line is broken by a pause towards the end and the latter phrase runs on into the following lines, elision sometimes takes place between the lines, e.g. (*Oed. Tyr.*, 332-333):—

Ἐγὼ οὐτ' ἑμαυτὸν οὐτε σ' ἀλγυνῶ. τί ταῦτ'
ἄλλως ἐλέγχεις;

This is called *synarphaea*, and is peculiar to Sophocles.

He differentiates more than Aeschylus does between the metres to be employed in the *κομμοί* (including the *κομματικά*) and in the choral odes. The *dochmius*, *cretic*, and free *anapaest* are employed chiefly in the *κομμοί*. In the *stasima* he has greatly developed the use of *logaoedic* and particularly of *glyconic* rhythms, and far less frequently than his predecessor indulges in long continuous runs of dactyls or trochees. The light trochaic line $\underline{\text{v}}\text{—}\underline{\text{v}}\text{—}\underline{\text{v}}\text{—}\underline{\text{v}}\text{—}$, so frequent in Aeschylus, is comparatively rare in Sophocles. If, from the very severity with which the choral element is subordinated to the purely dramatic, his lyrics have neither the magnificent sweep of Aeschylus nor the "linked sweetness" of Euripides, they have a concinnity and point, a directness of aim, and a truth of dramatic keeping, more perfect than is to be found in either. And even in grandeur it would be hard to find many passages to bear comparison with the second *stasimon*, or central ode, either of the *Antigone* (*εὐδαίμονες οἴσι κακῶν*) or the first *Oedipus* (*εἰ μοι ξυνείη φέρωντι*). Nor does anything in Euripides equal in grace and sweetness the famous eulogy on Colonus (the poet's birthplace) in the *Oedipus Coloneus*.

BIBLIOGRAPHY.—Sophocles was edited (probably from the Venetian MSS.) by Aldus Manutius, with the help of Musurus, in 1502. The Juntine editions in which the text of Aldus was slightly modified with the help of Florentine MSS. were published in 1522, 1547, respectively. An edition of the Scholia, very nearly corresponding to those on the margin of the Medicean or chief Laurentian MS. (La or L) has previously appeared at Rome in 1518. The first great modification of the text was due to Turnebus, who had access to the Parisian MSS.; but he was not fortunate in his selection. The earliest editors had been aware that the traditional arrangement of the metres was faulty, but little way had been made towards a readjustment. Now it so happens that the Parisian MS. T, which is a copy of the recension of Triclinius, an early 14th-century scholar, contains also the metrical views of the same editor; and, having found (as he erroneously supposed) a sound authority, Turnebus (1552) blindly adopted it, and was followed in this by H. Stephanus (1568), and by Canter in Holland (1579), who was the first to recognize the arrangement of the odes in *strophe* and *antistrophe*. The error was to a large extent corrected by Brunck (1786), who rightly preferred Par. A (2712), a 13th-century MS., belonging, as it happened, to the same family with Ven. 467, which Aldus had mainly followed. Thus after nearly three centuries the text returned (though with conjectural variations) into the former channel. Musgrave's edition was published posthumously in 1800, and Gilbert Wakefield had published a selection shortly before. Erfurd in Germany then took up the succession, and his edition formed the basis of Hermann's, whose psychological method set the example of a new style of commentary which was adopted by Wunder. A new era commenced with Peter Elmsley's collation of the Laurentian MS. (made in 1818, but only published in full after his death). His transcription of the Scholia still exists in the Bodleian Library. The most important German commentaries

since Hermann's have been those of Schneidewin, G. Wolff and Wecklein. L. Campbell's edition of the plays and fragments (1871-1881) was quickly followed by Jebb's edition of the seven plays (1881-1896). Editions of one or more dramas most worth consulting are Elmsley's *Oedipus Tyrannus* and *Oedipus Coloneus*, Böckh's *Antigone*, Lobeck's *Ajax*, J. W. Donaldson's *Antigone*, O. Jahn's *Electra* and J. William White's *Oed. Tyr.* A monograph on the *Antigone* by Kaibel is also well worth mentioning. Translations: in verse, by Francklin, Potter, Dale, Plumptre, L. Campbell, Whitelaw; in prose by R. C. Jebb. The chief German translations are those of Solger (1824), Donner (1839), Hartung (1853) and Thudichum. The French prose translation by Leconte de Lisle, and the Italian in verse by Bellotti deserve special mention. The *Antigone* was produced at Berlin with Mendelssohn's music in 1841 and the *Oedipus Coloneus* in 1845. They have been reproduced in English several times—the *Antigone* notably with Helen Faucit (Lady Martin) in the title-rôle in 1845. The *Oedipe Roi* (trans. La Croix) and the *Antigone* (trans. Vacquerie) have been frequently performed in Paris. A performance of the *Oedipus Tyrannus* in Greek at Harvard University, U.S.A. (1880), was remarkably successful. Of dissertations immediately devoted to Sophocles those of Lessing, Patin, Dronke and Evelyn Abbott (in *Hellenica*) are especially noteworthy. (L. C.)

SOPHOMORE, the name in American universities (corresponding to "sophister" at Cambridge, England, and Trinity College, Dublin) for a student who has completed his first year of academic studies. It is a corruption of the earlier "sophomore," due to a supposed derivation from σοφός, wise, and μῶρος, foolish, alluding to the air of wisdom assumed by students after their freshman's year was concluded. The earlier word "sophimore" (cf. "Laws of Yale Coll., 1774," in Hall's *College Words*) represents "sophismor," a doublet of "sophister," and means an arguer or debater (cf. the Cambridge use of "wrangler"), and is formed from the Greek σόφισμα, sophism, an ingenious or captious argument.

SOPHRON, of Syracuse, writer of mimes, flourished about 430 B.C. He was the author of prose dialogues in the Doric dialect, containing both male and female characters, some serious, others humorous in style, and depicting scenes from the daily life of the Sicilian Greeks. Although in prose, they were regarded as poems; in any case they were not intended for stage representation. They were written in pithy and popular language, full of proverbs and colloquialisms. Plato is said to have introduced them into Athens and to have made use of them in his dialogues; according to Suídas, they were Plato's constant companions, and he even slept with them under his pillow. Some idea of their general character may be gathered from the 2nd and 15th idylls of Theocritus, which are said to have been imitated from the Ἀκίστρια and Ἰσθμιάζουσαι of his Syracusan predecessor. Their influence is also to be traced in the satires of Persius. The fragments will be found in H. L. Ahrens's *De graecae linguae dialectis* (1843), ii. (app.). Latest edition by C. J. Botzon (1867); see also his *De Sophrone et Xenarcho mimographis* (1856).

SOPHRONIUS, Greek "sophist" and theological writer, was born at Damascus. For many years he was a monk in the monastery of Theodosius, near Jerusalem, removed to Alexandria, whence he was driven out by the advance of the Persians, and finally settled in Palestine, where he became (634) successor of Modestus in the patriarchate of Jerusalem. After his elevation he showed himself a staunch supporter of orthodox principles and one of the most determined opponents of the Monothelites. In 636, when Jerusalem surrendered to the Arabs under Omar, he succeeded in obtaining important concessions for the Christians in the exercise of their worship. He did not long survive the capture of the city, and after his death the see remained unfilled for 29 years. Sophronius was a prolific writer, both in prose and verse, in various departments of literature. His chief work is a long account of the Egyptian saints and martyrs Cyrus and John, and of the miraculous cures effected by them, valuable for its information concerning the topography of Egypt. The *Life of Mary of Egypt*, who abandoned immorality for a life of the strictest penance in Palestine for 48 years, is generally attributed to him. He was also the author of anacreontic odes, hymns, and epigrams.

Works in J. P. Migne, *Patrologia graeca*, lxxxvii., and list in Fabricius, *Bibliotheca graeca*, ix. 162; see also L. de St Aignan, *Vie de Sophronius* (Orleans, 1884); C. Krumbacher, *Geschichte der byzantinischen Litteratur* (1897); and for Sophronius and Omar, Gibbon, ch. 51.

SOPRANO (a variant of Ital. *sovrano*, supreme, sovereign, Late Lat. *superanus*, from *super*, above), the term applied in music to the highest natural range of the human voice, and often restricted to that range in the female voice, "treble" being used of a boy's voice. Male *soprani*, either natural or artificially produced, as formerly in the *castrati* of the papal choirs (see EUNUCH), are also found. The female voice whose range is intermediate between that of a soprano or a contralto is termed "mezzo-soprano."

SOPRON (Ger. *Oedenburg*; Med. Lat. *Sopronium*), a town of Hungary, capital of the county of the same name, 140 m. W. of Budapest by rail. Pop. (1900), 30,628, about 60% Germans. It lies in an extensive valley enclosed on all sides by the outskirts of the Rosalien mountains, a group belonging to the eastern outliers of the Alps. In the principal square are the Benedictine church, built at the end of the 13th century and restored in the 15th century, and the town hall, completed in 1894. The Dominican church, built in 1674; the church of St Michael, in the Gothic style, completed in 1484, the most interesting church in the town; and the old tower, 200 ft. high, are all worth notice. Sopron has a thriving industry in sugar, soap, vinegar, bell-founding and machinery, and it carries on an active trade in cereals, fruit and wine. Large cattle markets are also held here. Within the county a good quality of wine is produced, especially near the little town of Ruszt (pop. 1608) and at the village of Balf (Ger., *Wolfs*) on the shores of the Neusiedler lake. In the neighbourhood of Sopron is the Brennberg, with extensive coal-mines. Sopron was a Roman colony under the name of *Scarabantia*. It was afterwards occupied by German settlers and became a royal free town in the 11th century. Matthias Corvinus granted the town special privileges in 1464. An important Diet of Hungarian Protestants took place here in 1681.

About 12 m. north, at the foot of the Leitha mountains, lies the town of Kismarton (Ger. *Eisenstadt*; pop., 2951), which contains a magnificent castle of the Esterhazy family, built in 1683 and enlarged in 1805. About 10 m. north-west lies Nagymarton (Ger. *Mattersdorf*; pop., 3789); and not far from it, on the frontier of Austria, the well-preserved castle of Forchtenstein, the cradle of the Esterhazy family. About 12 m. east, not far from the Neusiedler lake, lies Esterhaza, with a beautiful castle in the French Renaissance style, belonging to Count Esterhazy. About 9 m. south-east lies the village of Nagyczenk (Ger. *Zinkendorff*), with the castle of the Szechenyi family.

SORA, a city of Campania, Italy, in the province of Caserta, 77 m. N. by W. of that town on the railway between Roccaseca and Avezzano, 920 ft. above sea-level. Pop. (1901), 6,950 (town); 16,022 (commune). It is built in a plain on the banks of the Liris. This part of the valley is the seat of some important manufactures, especially of paper-mills. The original cathedral, consecrated by Pope Adrian IV. in 1155, was destroyed by the earthquake of 1634. On the precipitous rock above the town (1768 ft.) which guards the Liris valley and the entrance to the Abruzzi are remains of polygonal walls; here, possibly, was the citadel of the original Volscian town. There are also remains of medieval fortifications. In the town itself there are no remains of antiquity nor buildings of interest. The district around Sora is famous for the costumes of its peasants.

Sora, an ancient Volscian town, was thrice captured by the Romans, in 345, 314 and 305 B.C., before they managed, in 303, by means of a colony 4000 strong, to confirm its annexation. In 209 it was one of the colonies which refused further contributions to the war against Hannibal. By the lex Julia it became a *municipium*, but under Augustus it was colonized by soldiers of the legio IV. Sorana, which had been mainly enrolled there. It belonged technically to *Lalium Adjectum*. The castle of Sorella, built on the rocky height above the town,

was in the middle ages a stronghold of some note. Charles I. of Anjou made Sora a duchy for the Cantelmi; it was afterwards seized by Pius II., but, being restored to the Cantelmi by Sixtus IV., it ultimately passed to the Della Rovere of Urbino. Against Caesar Borgia the city was heroically defended by Giovanni di Montefeltro. It was purchased by Gregory XIII. for 11,000 ducats and bestowed on the Buoncompagni, the ancestors of the line of Buoncompagni-Ludovisi. In ancient times Sora was the birthplace of the Decii, Attilius Regulus, and Lucius Mummius; and among its later celebrities is Cardinal Baronius.

(T. As.)

SORACTE, a mountain in the province of Rome, Italy. It is a narrow, isolated limestone ridge, some 5 m. S.E. of Civita Castellana, and $3\frac{1}{2}$ m. in length. The highest summit is 2267 ft. above sea-level; just below it is a monastery removed there from the summit in 1835; it was originally founded about 748 by Carloman, son of Charles Martel (the altar has, indeed, fragments of sculptures of this period), and until modern times was occupied by Trinitarian monks. On the actual summit is a church. Owing to the isolated position of the mountain the view is magnificent, and Soracte is a conspicuous object in the landscape, being visible from Rome itself. It is thus mentioned by Horace ("vides ut alta stet nive candidum Soracte?" *Carm.* i. 9), and Virgil, who mentions Apollo as its guardian deity, though no traces of his temple exist; and in reality it was sacred to Dis Pater and the gods of the lower world. At the bottom of the mountain on the east is a disused limestone quarry. The village of S. Oreste at the south-east end of the ridge owes its name to a corruption of the ancient name. In the communal palace is a fine processional cross of the 11th century in the Byzantine style (see *Römische Quartalschrift*, 1905, 209—Archäologie).

SORANUS, Greek physician, born at Ephesus, lived during the reigns of Trajan and Hadrian (A.D. 98–138). According to Suidas, he practised in Alexandria and subsequently in Rome. He was the chief representative of the school of physicians known as "methodists." Two treatises by him are extant: *On Fractures* (in J. L. Ideler, *Physici et medici minores*, i. 1841) and *On Diseases of Women* (first published in 1838, later by V. Rose, in 1882, with a 6th-century Latin translation by Moschio, a physician of the same school). Of his most important work (*On Acute and Chronic Diseases*) only a few fragments in Greek remain, but we possess a complete Latin translation by Caelius Aurelianus (5th century). The *Life of Hippocrates* (in Ideler) probably formed one of the collection of medical biographies by Soranus referred to by Suidas, and is valuable as the only authority for the life of the great physician, with the exception of articles in Suidas and Stephanus of Byzantium (s.v. Κῶς). The *Introduction to the Science of Medicine* (V. Rose, *Anecdota graeca*, ii. 1870) is considered spurious.

See article by J. Hahn, in Dechambre's *Dictionnaire encyclopédique des sciences médicales*, 3rd series, tom. 10; W. Christ, *Geschichte der griechischen Literatur* (1898); J. Ilberg, *Die Überlieferung der Gynaekologie des Soranos von Ephesos* (Leipzig, 1910).

SORANUS, BAREA, Roman senator, lived in the reign of Nero. His gentile name was possibly Servilius. In 52 he was consul suffectus, and (perhaps in 61) proconsul of Asia. The upright and considerate manner in which he treated the provincials won him their affection, but at the same time brought upon him the hatred of Nero, who felt specially aggrieved because Soranus had refused to punish a city which had defended the statues of its gods against the Imperial commissioners. Soranus was accused of intimacy with Rubellius Plautus (another object of Nero's hatred), and of endeavouring to obtain the goodwill of the provincials by treasonable intrigues. One of the chief witnesses against him was Egnatius Celer of Berytus, his client and former tutor. Soranus was condemned to death (in 65 or 66), and committed suicide. His daughter Servilia, who was charged with having consulted the sorcerers, professedly in regard to her father's fate, but in reality with evil designs against the emperor, was involved in his downfall. The accuser, who was condemned to death in the reign of Vespasian

for his conduct on this occasion, is a standing example of ingratitude and treachery.

Tacitus, *Annals*, xvi. 30, 32; *Hist.* iv. 10; Juvenal iii. 116; Dio Cassius lxii. 26.

SORAU, a town of Germany, in the Prussian province of Brandenburg, on the Sorebach, 54 m. S.E. of Frankfort-on-Oder by rail, and at the junction of lines to Cottbus and Görlitz. Pop. (1905), 16,410. One of the oldest towns in Lower Lusatia, Sorau contains a number of ancient buildings, among which the most prominent are several of the churches (one dating from 1204), the town hall, built in 1260, and the old palace of 1207 (now a prison). The new palace, erected in 1711 by Count Erdmann II. of Promnitz, is utilized for government offices. The varied manufactures of the town comprise cloth, linen, wax candles, starch, glass and porcelain.

Sorau is said to have existed in 840, and to have belonged to the abbey of Fulda till the 12th century. It received civic rights in 1260. With the surrounding district, known as the barony of Sorau, it became the seat of successive noble families; and in 1400 it was united with the barony of Triebel. The last Count of Promnitz, whose ancestor had purchased both baronies from Frederick of Bohemia in 1556, sold them in 1765 to the elector of Saxony for an annuity of 12,000 thalers (£1800). In 1815 Saxony ceded them to Prussia.

See Worbs, *Geschichte der Herrschaft Sorau und Triebel* (Sorau, 1826).

SORBONNE, the name given originally to the college founded by Robert de Sorbon in Paris; hence applied afterwards popularly to the theological faculty, and so to the institution which is now the seat of the Académie of that city (see UNIVERSITIES). The Sorbonne owes its origin and its name to Robert of Sorbon, near Reims (1201–1274), who went to Paris about the beginning of the reign of St Louis in order to qualify for the priesthood, attained high repute by his sanctity and eloquence, and was appointed by the king to be his confessor. Assisted by royal liberality, he built a modest establishment in which were accommodated seven priests charged with the duty of teaching theology gratuitously; to this he added a college of preparatory studies, all under the direction of a provisor, under whom was an annual prior who had the actual management. The new institution was authorized in 1252 by a deed signed by Queen Blanche, on behalf of Louis IX. (who was in Palestine); and in 1257 a site was given by the king in the heart of the Latin quarter. It was declared "useful to religion" by Pope Alexander IV. in 1259, and papal bulls authorizing and confirming the college were granted in 1263 and 1268. Destined originally for poor students (and called *domus magistrorum pauperrima*, "most poor house of masters"), the Sorbonne soon became a meeting-place for all the students of the university of Paris, who resorted thither to hear the lectures of the most learned theologians of the period—Guillaume de Saint Amour, Eudes de Douai, Laurent l'Anglais, Pierre d'Ailly. At the close of the century it was organized into a full faculty of theology, and under this definite form it conferred bachelors', licentiates' and doctors' degrees, and the severity of its examinations gave an exceptional value to its diplomas. The so-called "thèse sorbonnique," instituted towards the beginning of the 14th century, became the type of its order by the length and difficulty of its tests. Ultimately the professors of the Sorbonne came to be resorted to not only for lectures and examinations, but also for dogmatic decisions and judgments in canon law; the clergy of France and of the whole Catholic world had recourse to them in difficult cases, and the Curia Romana itself more than once laid its doubts before them, giving them the title of "Concilium in Gallia subsistens." To the Sorbonne belongs the glory of having introduced printing into France in 1469: within its precincts it assigned quarters for Ulric Gering and two companions in which to set up their presses. The Sorbonne took a leading part in the religious discussions which agitated France during the 16th and 18th centuries, and its influence thus inevitably extended to political questions. During the insanity of Charles VI. it helped to bring about the absolution of Jean Sans-Peur for the assassination of the duke of Orleans.

Shortly afterwards it demanded and supported the condemnation of Joan of Arc; during the Reformation it was the animating spirit of all the persecutions directed against Protestants and unbelievers: without having advised the massacre of St Bartholomew, it did not hesitate to justify it, and it inflamed the League by its vigorous anathemas against Henry III. and the king of Navarre, hesitating to recognize the latter even after his abjuration. From this point dates the beginning of its decadence, and when Richelieu in 1626 ordered the reconstruction of its church and buildings the following prophetic couplet was circulated—

"Instaurata ruet jamjam Sorbona. Caduca
Dum fuit, inconcussa stetit; renovata peribit."

The declaration of the clergy in 1682, which it subscribed, proved fatal to its authority with the Curia Romana; it revived for a short time under Louis XV. during the struggle against Jansenism, but this was its last exploit; it was suppressed like the old universities in 1792.

When the university of France was organized in 1808 the Sorbonne became the seat of the *académie* of Paris; and between 1816 and 1821 the faculties of theology (since disappeared), science and literature were installed there. The university library was transferred to the Sorbonne in 1823. In 1868 was organized the *École des Hautes Études*, and in 1897 the *École des Chartes* also found its home at the Sorbonne.

In 1852 the Sorbonne was made the property of the city of Paris; a reconstruction of the buildings, projected by Napoleon III., was begun in 1884, under the architectural direction of Nénot, and completed in 1889. The old church containing the tomb of Richelieu was retained on account of its artistic merit. This new Sorbonne is one of the finest university edifices in the world, and has developed into the chief French centre of learning.

See A. Franklin, *La Sorbonne* (1875); Denifle, *Documents relatifs à la fondation de l'université de Paris* (1883); J. A. Randolph, *History of the Sorbonne*.

SORBS, the tribal name of the Slavonic people, whom the Germans call Wends in Lusatia (Lausitz); they call themselves Serbs or Lužičane. Their country includes the western extremity of the kingdom of Saxony and parts of the districts of Hoyerswerda, Muskau, Kottbus, Kalau, Spremberg and Sorau in Prussia; they are now surrounded on all sides by Germans, but they formerly had them as neighbours only on the west along the Fulda, while on the north towards Köpenick they marched with the Lutiči, on the east with the Poles and Silesians along the Queiss and Bobr, and on the south were separated from the Bohemians by the mountains that now make the Austrian frontier. The Sorbs are divided into High and Low along a line from Sagan to Muskau and Spremberg. They are in all about 180,000 in number; 80,000 Low Sorbs and 40,000 of the 100,000 High Sorbs are in Prussia, and 60,000 High Sorbs in Saxony. These have gained definite rights for their language in school and administration, so that Bautzen (Budyšin), their capital, is the intellectual centre not only for Saxon subjects, but for all High Sorbs and to a great extent for Low Sorbs. The first monuments of both dialects belong to the Reformation period, these being translations of Luther's Catechism by Warichius and Moller. Some Sorbs are Protestants, though the Saxon Sorbs are mostly Roman Catholics. Early in the 19th century the High Sorbs had a revival under the leadership of F. A. Klin, a lawyer and politician; A. Seidler, a considerable poet, and S. E. Smoler, an ethnographer and publicist. More recent writers are J. Čišinsk and J. Radyserb. A *Macica* or Literary and Linguistic Society was founded in 1847, and publishes a *Casopsis* or Periodical. Meanwhile Low Sorb has remained almost uncultivated owing to the pressure of the Prussian administration.

The two dialects stand between Polish and Čech; they have lost the nasal vowels, have the accent on the first syllable, and make *tj* into *č*, *dj* into *z*, like Čech, but they retain *x* and *y* and, like Polish, have *grad* for Čech *grad*. High Sorb has *h*, Low the original *g*. They have kept the old aorist and dual. Sorb is usually printed in German blackletter variously adapted; the *Macica* publishes some books spelt after the Čech system.

BIBLIOGRAPHY.—G. Kral, *Grammatik der wendischen Sprache in der Oberlausitz* (Bautzen, 1895); K. E. Mucke, *Historische und vergleichende Laut- u. Formen-Lehre d. niedersorbischen Sprache* (*Jablonowski Preisschrift*, xviii.) (Leipzig, 1891); Pfuhl, *Lausitzisch-Wendisch Wörterbuch* (High Sorb) (Bautzen, 1866); J. G. Zwahr, *Niederlausitz-wendisch-deutsches Handwörterbuch* (Spremberg, 1847); M. Hórnik, *Čitanka* (Chrestomathy of High Sorb) (Bautzen, 1863); L. Haupt and J. S. Smoler, *Volklieder der Wenden in der Ober- und Niederlausitz* (Grimma, 1842–1843). (E. H. M.)

SORBY, HENRY CLIFTON (1826–1908), English microscopist and geologist, was born at Woodbourne near Sheffield on the 10th of May 1826. He early developed an interest in natural science, and one of his first papers related to the excavation of valleys in Yorkshire. He subsequently dealt with the physical geography of former geological periods, with the wave-structure in certain stratified rocks, and the origin of slaty cleavage. He took up the study of rocks and minerals under the microscope, and published an important memoir *On the Microscopical Structure of Crystals* in 1858 (*Quart. Journ. Geol. Soc.*). In England he was one of the pioneers in petrography; he was awarded the Wollaston medal by the Geological Society of London in 1869, and when president of the society he published in his addresses the results of original researches on the structure and origin of limestones, and of the non-calcareous stratified rocks (1879–1880). He had previously been president of the Royal Microscopical Society. He wrote on the construction and use of the micro-spectroscope in the study of animal and vegetable colouring matter, and in later essays he dealt with such varied subjects as the microscopical structure of iron and steel, and the temperature of the water in estuaries. He also applied his skill in making preparations of invertebrate animals for lantern-slides. In 1882 he was elected president of Firth Cöllege, Sheffield. He died on the 9th of March 1908.

SORCERY, magic, enchantment, witchcraft; the use of supposed supernatural powers by the agency of evil spirits called forth by spells, incantations, &c., on the part of the magician, sorcerer or witch. The word meant originally divination by means of the casting or drawing of lots, and is derived from the O. Fr. *sorterie*, *sorcier*, a sorcerer, Med. Lat. *sortarius*, one who practises divination by lots, *sortes* (see **MAGIC, DIVINATION** and **WITCHCRAFT**).

SORDELLO, a 13th-century Italian troubadour, born at Mantua, who is praised by Dante in the *De vulgari eloquio*, and in the *Purgatorio* made the type of patriotic pride. He is also the hero of a well-known poem by Robert Browning. The real Sordello, so far as we have authentic facts about his life, hardly seems to justify these idealizations, though he was the most famous of the Italian troubadours. About 1220 he appears at Florence in a tavern brawl; and in 1226, while at the court of Richard of Bonifazio at Verona, he abducts his master's wife, Cunizza, at the instigation of her brother, Ezze-lino da Romano. The scandal resulted in his flight (1229) to Provence, where he seems to have been for some time. He entered the service of Charles of Anjou, and probably accompanied him (1265) on his Naples expedition; in 1266 he was a prisoner in Naples. The last documentary mention of him is in 1269, and he is supposed to have died in Provence. His didactic poem, *L'Ensenhamen d'onor*, and his love songs and satirical pieces have little in common with Dante's presentation, but the invective against negligent princes which Dante puts into his mouth in the 7th canto of the *Purgatorio* is more adequately paralleled in his *Serventesse* (1237) on the death of his patron Blacatz, where he invites the princes of Christendom to feed on the heart of the hero.

For Sordello's life and works see the edition of Cesare de Lollis (Halle, 1896); for Browning's poem see Stopford Brooke's *Browning* (1902).

SORDINO, SORDONI, SORDUNI, Italian terms somewhat promiscuously applied by various writers (1) to contrivances for damping or muting wind, string and percussion instruments (*Sordini*); (2) to a family of obsolete wind instruments blown by means of a double reed (*Sordoni* or *Sordun*); (3) to a stringed instrument. To these must also be added the *Surdellina* or

Sordellina, a kind of musette invented (see BAGPIPE) in Naples in the 17th century, and evidently named after class 2.

1. Under the Italian term *sordini* are comprised the dampers used with stringed instruments, such as the violin, and the dampers of keyboard instruments, all well known, and described with the instruments themselves. As a certain amount of misconception exists concerning the *sordini* (Fr. *sourdines*, Ger. *Dämpfer*), used from the 16th century with the trumpet and later with the horn, they may be briefly described. It would appear that the art has almost been lost of making mutes for trumpets and French horns, which should affect the timbre only, giving it a certain veiled mysterious quality similar to that of the *sons bouchés* or hand-stopped notes, but affecting the pitch not at all. We read that when it is necessary to produce this peculiar timbre on the valve-horn, as for instance in Wagner's *Rheingold*, the rise of a semi-tone in pitch caused by the introduction of the mute or the hand into the bell of the horn must be compensated by means of the second piston which lowers the pitch a semi-tone.¹

If the *sordino* used early in the 17th century had had this effect of raising the pitch, the fact would have been stated by such writers as Mersenne and Praetorius; it would, moreover, have rendered the mute useless with instruments on which no sort of compensation was possible. H. Domnich² and J. Fröhlich,³ however, describe the *sordino* which leaves the pitch unaffected: it consisted of a hollow cone of wood or cardboard, truncated at the apex to allow the air to pass through and escape through a hole in the base. The bore of the instrument thus continued through the cone of the mute was the essential point, and the proportions to be maintained between the diameters of the two bores were also, no doubt, of importance. Domnich expressly states that it was when Hampel substituted a plug of cotton-wool (therefore solid and providing no central passage for the air) for the mute, that he found the pitch of the horn raised a semi-tone. Domnich's evidence is of value, for his father was a horn-player contemporary with Hampel, and he himself was the intimate friend and colleague of Punto, Hampel's most celebrated pupil.

2. The *sordun* or *sordoni* family are often confused with the dolcians (Fr. *courtaud*, Eng. *single curtail*, Ger. *Kort* or *Koriholt*), from which, however, they differed radically. This difference was not understood by Michael Praetorius, who acknowledges his mystification. The contra-bass *sordun*, he says, hardly half the length of the contra-fagotto, is yet practically of the same pitch, which is astonishing since the bore is only double once upon itself as in the fagotto. The *kort* likewise is of the same size as the bass *sordun*, and yet in pitch it is but a tenor. The following description of the construction and acoustic properties of the *sordoni* will clear up the mystery. The body consisted of a cylinder of wood in which were cut two parallel channels of narrow cylindrical bore, communicating with each other at the bottom through a bend, but not with ambient air. At the top of the cylinder was fitted a double-reed mouthpiece giving access to the column of air at one end of the bore, while the other was vented through a small hole in the side, similar to the finger-holes; in the tenor, bass and contra members of the family, the reed was attached to a curved brass crook similar to that of the fagotto. So far the description would almost apply to the dolcian also, but in the latter there is the radical difference that the bore of the channels is conical, so that it has the acoustic properties of the open pipe. The *sordun*, however, having a cylindrical bore, has the acoustic properties of the stopped pipe, i.e. the sound waves are twice the length of the pipe, so that to produce a sound of any given pitch, for instance for C, the bore need only be half the length, i.e. 4 ft. long. Overblowing, on the *sordoni*, moreover, produced as first harmonic (the only one required for reed-blown instruments in order to produce the diatonic scale for the second octave) not the octave, but the twelfth, or number 3 of the series. This accounts for the fact that instruments of the fagotto and dolcian type require but 6 or 7 holes to give the diatonic scale throughout the compass, whereas the *sordoni* require 11 or 12 holes. Praetorius states that those figured by him (Plate XII.) have 12 open holes, and that some specimens have in addition two keys; a hole is also bored through the bottom of the instrument to allow the moisture condensed from the breath to be shaken out. The 12 holes are stopped by means of fingers and thumbs and by the ball of the hand or the fleshy underpart of the joints of the fingers. The compass of the 5 sizes of *sordoni* was as follows:—



¹ See Victor Mahillon, "Le Cor," *Instruments à vent*, pt. ii. (Brussels and London, 1907), pp. 34 and 53.

² *Méthode de premier et de second cor* (Paris, c. 1807), pp. 3 and 4.

³ *Vollständige theor.-prakt. Musiklehre für alle bei dem Orchester gebräuchliche Instrumente* (Cologne and Bonn, c. 1811).

Two *sourdines* belonging to the Museum of the Brussels Conservatoire, said to be facsimiles of some instruments belonging to the emperor Maximilian I.'s band, are reproduced in Captain C. R. Day's *Descriptive Catalogue of Musical Instruments* (London, 1891). They differ slightly in construction from the Italian instruments described by Praetorius. The straight crook is set in the side of the instrument, almost at right angles, the top of the cylinder is surmounted by a cap, and there are but 6 open holes, the rest being covered by brass keys in wooden boxes. The pitch of these instruments lies within a semi-tone of that of the contra-bass and bass of Praetorius. (K. S.)

SOREL, AGNES (c. 1422–1450), mistress of King Charles VII. of France, was born of a family of the lesser nobility at Fromenteau in Touraine. While still a girl she was attached to the service of Isabel of Lorraine, queen of Sicily, wife of René of Anjou, the brother-in-law of Charles VII. From 1444 until her death in 1450 she was the acknowledged mistress of the king, the first woman to hold that semi-official position which was to be of so great importance in the subsequent history of the old régime. Her ascendancy dated from the festivals at Nancy in 1444, the first brilliant court of Charles VII. Here her great beauty captivated the king, whose love for her remained constant until her death. He gave her wealth, castles and lands, and secured for her the state and distinction of a queen. This first public recognition of his mistress by a king of France scandalized all good people and awakened jealousy and intrigue. Her sudden death from dysentery, shortly after the birth of her fourth child, was accordingly attributed to poison. Burgundian historians even openly accused the Dauphin, afterwards Louis XI., of her death, and later the enemies of Jacques Cœur, in their search for crimes to be brought against him, used this rumour to charge him with the one crime most likely to turn the king against him. Her heart was buried in the abbey of Jumièges, her body in the collegiate church of Loches. Contemporary writers all bear witness to her extraordinary beauty, but no genuine portraits of her have come down to us.

Legend has made an entirely different character of this first official mistress of the French kings. The date of her birth was placed at about 1409, her liaison with the king dated from 1433. Then, so the story ran, she drew him from his indolence, continuing the work of Joan of Arc, both by nerving the king to warlike enterprises—she did apparently induce him to take part personally in the conquest of Normandy—and by surrounding him with that band of wise advisers who really administered France during her ascendancy. Recent investigation has exploded this romantic story by simply showing that Charles VII. had not met her until ten years later than in the legend. Instead of being his sole good angel, she seems rather to have demoralized the king, who, hitherto chaste, henceforth gave himself up to courtesans. Yet she favoured the best advisers of the king, and at least in this deserved the gratitude of the realm. Pierre de Brézé seems especially to have used Agnes to gain his ascendancy over the king.

See A. Vallet de Viriville's articles in *Bibliothèque de l'École des chartes* (3rd series, tom. i.); and R. Duquesne, *Vie et aventures galantes de la belle Sorel* (1909).

SOREL, ALBERT (1842–1906), French historian, was born at Honfleur on the 13th of August 1842. He was of a characteristically Norman type, and remained all his life a lover of his native province and its glories. His father, a rich manufacturer, would have liked him to succeed to the business, but his literary vocation prevailed. He went to live in Paris, where he studied law, and after a prolonged stay in Germany entered the Foreign Office (1866). He had strongly-developed literary and artistic tastes, was an enthusiastic musician, even composing a little, and wrote both verses and novels, which appeared a little later (*La Grande Falaise*, 1785–1793, in 1871, *Le Docteur Egra* in 1873); but he did not go much into society. He was anxious to know and understand present as well as past events, but he was above all things a student. In 1870 he was chosen as secretary by M. de Chaudordy, who had been sent to Tours as a delegate in charge of the diplomatic side of the problem of national defence; in these affairs he proved himself a most valuable collaborator;

he was unremitting in his labours, full of *finesse*, good temper and excellent judgment, and at the same time so discreet that we can only guess at the part he played in these terrible crises. After the war, when Boutmy founded the *École libre des sciences politiques*, Sorel was appointed to teach diplomatic history (1872), a duty which he performed with striking success. Some of his courses have formed books: *Le Traité de Paris du 20 novembre 1815* (1873); *Histoire diplomatique de la guerre franco-allemande* (1875); we may also add the *Précis du droit des gens* which he published (1877) in collaboration with his colleague Théodore Funck-Brentano. In 1875 Sorel left the Foreign Office and became general secretary to the newly-created office of the *Présidence du sénat*. Here again, in a congenial position where, without heavy responsibilities, he could observe and review affairs, he performed valuable service, especially under the presidency of the duc d'Audiffred Pasquier, who was glad to avail himself of his advice in the most serious crises of internal politics. His duties left him, however, sufficient leisure to enable him to accomplish the great work of his life, *L'Europe et la révolution française*. His object was to do over again the work already done by Sybel, but from a less restricted point of view and with a clearer and more calm understanding of the chess-board of Europe. He spent almost thirty years in the preparation and composition of the eight volumes of this history (vol. i., 1885; vol. viii., 1904). For he was not merely a conscientious scholar; the analysis of the documents, mostly unpublished, on French diplomacy during the first years of the Revolution, which he published in the *Revue historique* (vol. v.-viii., x.-xiii.), shows with what scrupulous care he read the innumerable despatches which passed under his notice. He was also, and above all things, an artist. He drew men from the point of view of a psychologist as much as of a historian, observing them in their surroundings and being interested in showing how greatly they are slaves to the fatality of history. It was this fatality which led the rashest of the Conventionals to resume the tradition of the Ancien Régime, and caused the revolutionary propaganda to end in a system of alliances and annexations which carried on the work of Louis XIV. This view is certainly suggestive, but incomplete; it is largely true when applied to the men of the Revolution, inexperienced or mediocre as they were, and incompetent to develop the enormous enterprises of Napoleon I. In the earlier volumes we are readily dominated by the grandeur and relentless logic of the drama which the author unfolds before our eyes; in the later ones we begin to make some reservations; but on the whole the work is so complete and so powerfully constructed that it commands our admiration. Side by side with this great general work, Sorel undertook various detailed studies more or less directly bearing on his subject. In *La Question d'Orient au XVIII^e siècle, les origines de la triple alliance* (1878), he shows how the partition of Poland on the one hand reversed the traditional policy of France in eastern Europe, and on the other hand contributed towards the salvation of republican France in 1793. In the *Grands écrivains* series he was responsible for *Montesquieu* (1887) and *Mme de Staël* (1891); the portrait which he draws of Montesquieu is all the more vivid for the intellectual affinities which existed between him and the author of the *Lettres persanes* and the *Esprit des lois*. Later, in *Bonaparte et Hoche en 1797*, he produced a critical comparison which is one of his most finished works (1896); and in the *Recueil des instructions données aux ambassadeurs* he prepared vol. i. dealing with Austria (1884). Most of the articles which he contributed to various reviews and to the *Temps* newspaper have been collected into volumes: *Essais d'histoire et de critique* (1883), *Lectures historiques* (1894), *Nouveaux essais d'histoire et de critique* (1898), *Études de littérature et d'histoire* (1901); in these are to be found a great deal of information and of ideas not only about political men of the last two centuries, but also about certain literary men and artists of Normandy. Honours came to him in abundance, as an eminent writer and not as a public official. He was elected a member of the Académie des sciences morales et politiques (December 18, 1889) on the death of Fustel de Coulanges, and of the Académie française (1894)

on the death of Taine. His speeches on his two illustrious predecessors show how keenly sensible he was of beauty, and how unbiased was his judgment, even in the case of those whom he most esteemed and loved. He had just obtained the great Prix Osiris of a hundred thousand francs, conferred for the first time by the Institut de France, when he was stricken with his last illness and died at Paris on the 29th of June 1906.

(C. B*.)

SOREL, CHARLES, SIEUR DE SOUVIGNY (1597-1674), French novelist and miscellaneous writer, was born in Paris about 1597. Very little is known of his life except that in 1635 he was historiographer of France. He wrote on science, history and religion, but is only remembered by his novels. He tried to destroy the vogue of the pastoral romance by writing a novel of adventure, the *Histoire comique de Francion* (1622). The episodic adventures of Francion found many readers, who nevertheless reserved their admiration for the *Astrée* it was intended to ridicule. Sorel decided to make his intention unmistakable, and in *Le Berger extravagant* (3 vols., 1627) he wrote a burlesque, in which a Parisian shop-boy, his head turned by sentiment, chooses an unprepossessing mistress and starts life as a shepherd with a dozen sheep on the banks of the Seine. Sorel did not succeed in founding the novel of character, and what he accomplished was more in the direction of farce, but he struck a shrewd blow at romance. Among his other works are *Polyandre* (1648) and *La Connaissance des bons livres* (1673). He died in Paris on the 8th of March 1674.

SOREL, a town and port of entry of Quebec, Canada, capital of Richelieu county, 42 m. N.E. of Montreal, at the confluence of the Richelieu and St Lawrence rivers. Pop. (1901), 7057. It is on the Grand Trunk and the Quebec Southern railways, and is a port of call for the Montreal and Quebec river steamers. It contains iron and leather manufactories, and shipbuilding is carried on. It occupies the site of a fort built in 1665 by A. de Tracy to guard the route by way of the Richelieu to Lake Champlain and the Hudson, and is named after the first commandant of the garrison.

SORGHUM, a genus of grasses belonging to the tribe Andropogoneae, and including one of the most important tropical grains, *Sorghum vulgare*, great millet, Indian millet or Guinea corn. In India it is known as *jawari* (Hindustani), *jowari* (Bengali), *cholum* (Tamil), and *jonna* (Telugu), and in the West Indies as Negro or Guinea Corn. It is a strong grass, growing to a height of from 4 to 8 or even 16 ft.; the leaves are sheathing, solitary, and about 2 in. broad and 2½ ft. in length; the panicles are contracted and dense, and the grains, which are enclosed in husks and protected by awns, are round, hard, smooth, shining, brownish-red, and somewhat larger than mustard seeds. The plant is cultivated in various parts of India and other countries of Asia, in the United States, and in the south of Europe. Its culms and leaves afford excellent fodder for cattle; and the grain, of which the yield in favourable situations is upwards of a hundredfold, is used for the same purposes as maize, rice, corn and other cereals.



Sorghum vulgare.

Speaking of its cultivation, Eduard Hackel (in his article on "Grasses" in *Die natürlichen Pflanzenfamilien*) says the culture of Sorghum probably had its origin in Africa, where a variety

known as durra is now cultivated over the entire continent, and has become the most important cereal; the natives also chew the stem, which contains sugar. In Europe it is raised less for bread than for mechanical purposes; the panicles are made into the so-called rice-brooms and into brushes. In Germany it is occasionally raised for green fodder. From the fruit the Kaffirs make an alcoholic drink, *Tialoa*, and the negroes one known as *Merisa*. Allied species are *S. bicolor*, much valued in India as a forage-plant, and *S. saccharatum*, commonly called sorghum or Chinese sugar-cane, which is extensively cultivated in China, North India and Africa. The latter species is grown in America chiefly for the manufacture of molasses from its juice, and in France as a source of alcohol.

A full account of the cultivation and use of the species in India will be found in Sir G. Watt's *Dictionary of the Economic Products of India* (1893).

SORIA, a province of Spain, formed in 1833 of districts belonging to Old Castile, and bounded on the N. by Logroño, E. by Saragossa, S. by Guadalajara and W. by Segovia and Burgos. Pop. (1900), 150,462; area, 3983 sq. m. Soria is a bleak and lofty region, bounded on three sides by mountains. A range of sierras culminating in the peaks of Urbion (7389 ft.) and Cebollera (7139 ft.) on the north, and the great Sierra del Moncayo (7707 ft.) on the east, separate the valley of the Duero (Douro) from that of the Ebro, while on the south it is divided from the valley of the Tagus by a continuation of the Sierra Guadarrama. Almost the whole of the province belongs to the region watered by the Duero and its affluents. This river rises among the southern slopes of Urbion and traverses the province in a circuitous course, first to the south and then to the west. The other rivers are mostly affluents of the Duero, but a few of the tributaries of the Ebro have their sources within the limits of the province. The soil is not remarkable for fertility; a large proportion of the area being occupied with barren mountains, which are covered with snow for a great part of the year. There are, however, in some places extensive forests of pine, oak and beech; while in others there are large tracts of pasture land, on which numbers of cattle, sheep and swine are reared. Grain and vegetables are raised, but neither of very good quality nor in sufficient quantities to supply the wants of the population. The climate is cold and dry, and the scenery grand, but austere. Most of the people are employed in farming and rearing cattle; but the cutting and sawing of timber and the preparation of charcoal also occupy a considerable number. There is a great want of roads; and, although three railways traverse the province, commerce is consequently very limited. Fine wool was formerly produced; but the only important articles of trade at present are timber, salt, asphalt, leather and cheese, which are sent to Madrid and Aragon. Salt and asphalt are the only minerals worked, though others are known to exist. The capital, Soria, is described below. The only other town with more than 3500 inhabitants is El Burgo de Osma (3509), an episcopal see. Between 1887 and 1900 the population decreased by nearly 7000; its density in the last-named year was 37.7 per sq. m., or lower than that of any other Spanish province except Cuenca (37.6). The gradual depopulation of many districts is due to the stagnation of industry, and the attraction of emigrants to large towns outside the province.

SORIA, the capital of the Spanish province of Soria; on the right bank of the river Duero (Douro), 155 m. N.E. of Madrid by the Madrid-Alcuneza-Soria railway. Pop. (1900), 7151. Soria has a provincial institute, schools for teachers of both sexes, many primary schools, savings banks, two hospitals, barracks, a theatre and a bull-ring. The churches of Santo Domingo and San Nicolas, the cloisters of the convent of San Juan, and several other ecclesiastical buildings are fine specimens of Romanesque work of the 12th and 13th centuries. Near the Duero are the ruins of the old citadel, and in many places the remains of the 13th century walls of the city are yet standing. The more modern streets are clean and well paved. The bridge across the Duero is a massive structure which formerly had a tower in the centre. The population is chiefly agricultural;

but there are also flour mills, tanneries, potteries, &c.; and some trade in timber, wool and fruit is carried on. The Iberian and Carthaginian city of Numantia, captured in 133 B.C. by the Romans, after a long and heroic resistance, was situated 3 m. N., on a hill overlooking the confluence of the small river Tera with the Duero.

SOROKI, a town of south Russia, in the government of Bessarabia, 81 m. N.N.W. of Kishinev, in a narrow ravine on the right bank of the Dnieper. Pop. (1900), 25,523, half of whom were Jews. It is an important river port for the export of corn, wool, fruit, wine and cattle. Formerly it was the old Genoese colony of Olchionia, and has still the ruins of a 13th-century Genoese castle. In the 15th century the Moldavians erected here a fort, which the Poles took in the 17th century. Peter the Great captured the place in 1711, but it was returned to the Turks, and was only definitely annexed to Russia in 1812. (M. H. S.)

SOROLLA Y BASTIDA, JOAQUIN (1863-), Spanish painter, was born in Valencia, and received his art education first in his native town and under F. Pradilla, and then in Italy and Paris. His first striking success he achieved with "Another Margaret," which was awarded a gold medal in Madrid and was bought for the St Louis Gallery. He soon rose to general fame and became the acknowledged head of the modern Spanish school of painting. His picture of the "Fishermen's Return" was much admired at the Paris Salon and was acquired by the state for the Luxembourg Museum. His exhibit at the Paris Universal Exposition of 1900 won him a medal of honour and his nomination as Knight of the Legion of Honour. A special exhibition of his works—figure subjects, landscapes and portraits—at the Georges Petit Gallery in Paris in 1906 eclipsed all his earlier successes and led to his appointment as Officer of the Legion of Honour. He is represented at the Berlin National Gallery, at the Venice and Madrid Museums, and in many private collections in Europe and America, especially in Buenos Aires. He painted portraits of King Alphonso and Queen Victoria Eugénie of Spain, and a magnificent portrait group of the family of Don Aureliano de Beruete. Three of his works were shown in London at the Spanish Exhibition, Guildhall, 1901.

SORREL, *Rumex Acetosus*, a member of the natural order Polygonaceae, a hardy perennial, native to Britain and found throughout the north temperate zone. The leaves are used in soups, salads and sauces. Sorrel grows freely in any good garden soil, and is increased by dividing the roots during the early part of spring. They should be planted in rows 15 to 18 in. apart. The leaves, when fully grown, are gathered singly. The common garden sorrel is much superior to the wild plant; but the Belleville, which is the kind generally cultivated near Paris, is still better, its leaves being larger and not so acid. The Blistered-leaved, which has large leaves with a blistered surface, has the advantage of being slow in running to seed. French Sorrel (*Rumex scutatus*) is a hardy perennial, distributed through Europe but not native in Britain, with densely-branched trailing stems. The leaves are roundish, heart-shaped and glaucous; they are more acid than those of the common sorrel.

SORRENTO (anc. *Surrentum*, *q.v.*), a city of Campania, Italy, in the province of Naples, 10 m. by electric tramway (along the highroad) S.W. from Castellammare di Stabia, and served also by steamer from Naples (16 m.). Pop. (1901), 6849 (town); 8832 (commune). It stands on cliffs about 160 ft. above sea-level on the north side of the peninsula that separates the Bay of Naples from the Bay of Salerno. Sorrento contains only a few ancient remains, and its present prosperity depends mainly on its reputation as a place of resort both in winter and in summer, its northerly aspect rendering it comparatively cool. Its climate is delightful and healthy, and it is situated amid picturesque coast scenery. The chief local industries are the inlaying of wood, silk and lace-making and straw-plaiting, and the growing of oranges and lemons. In ancient times the Surrentine wines had a great repute.

In 1558 the corsair Pialy attacked the town and carried off two thousand prisoners. It was at Sorrento that Bernardo Tasso wrote his *Amadigi*; and Torquato Tasso, to whom a marble

statue has been erected in the Piazza, was born in the town in 1544.

SOSIGENES, Greek astronomer and mathematician, probably of Alexandria, flourished in the 1st century B.C. According to Pliny (*Nat. Hist.* xviii. 25), he was employed by Julius Caesar in the reform of the Roman calendar (46 B.C.), and wrote three treatises, which he conscientiously corrected. From another passage of Pliny (ii. 8) it is inferred that Sosigenes maintained the doctrine of the motion of Mercury round the sun, which is referred to by his contemporary Cicero, and was also held by the Egyptians.

The astronomer is to be distinguished from the Peripatetic philosopher of the same name, who lived at the end of the 2nd century A.D. He was the tutor of Alexander of Aphrodisias, the most famous of the commentators on Aristotle. He wrote a work on *Revolving Spheres*, from which some important extracts have been preserved in Simplicius's commentary on Aristotle's *De caelo* (the subject is fully discussed by T. H. Martin, "Sur deux Sosigène," in *Annales de la fac. des lettres de Bordeaux*, i., 1879).

SOSITHEUS (c. 280 B.C.), Greek tragic poet, of Alexandria Troas, a member of the Alexandrian "pleiad." He must have resided at some time in Athens, since Diogenes Laërtius tells us (vii. 5, 4) that he attacked the Stoic Cleanthes on the stage, and was hissed off by the audience. As Suidas also calls him a Syracusan, it is conjectured that he belonged to the literary circle at the court of Hiero II. According to an epigram of Dioscorides in the Greek Anthology (*Anth. Pal.* vii. 707) he restored the satyric drama in its original form. A considerable fragment is extant of his pastoral play *Daphnis* or *Lityerses*, in which the Sicilian shepherd, in search of his love Pimplea, is brought into connexion with the Phrygian reaper, son of Midas, who slew all who unsuccessfully competed with him in reaping his corn. Heracles came to the aid of Daphnis and slew Lityerses.

See O. Crusius s.v. Lityerses in Roscher's *Lexikon der griechischen und römischen Mythologie*. The fragment of twenty-one lines in Nauck's *Tragicorum graecorum fragmenta* apparently contains the beginning of the drama. Two lines from the *Aethlius* (probably the traditional first king of Elis, father of Endymion) are quoted by Stobaeus (*Flor.* li. 23).

SOTADES, Greek satirist, of Maronea in Thrace (or of Crete), chief representative of the writers of coarse satirical poems, called *κίναδοι*,¹ composed in the Ionic dialect and in a metre named after him "sotadic." He lived in Alexandria during the reign of Ptolemy II. Philadelphus (285-247 B.C.). For a violent attack on the king, on the occasion of his marriage to his own sister Arsinoë, Sotades was imprisoned, but escaped to the island of Caunus, where he was afterwards captured by Patroclus, Ptolemy's admiral, shut up in a leaden chest, and thrown into the sea (Athenaeus xiv. p. 620; Plutarch, *De educatione puerorum*, 14).

Only a few genuine fragments of Sotades have been preserved (see J. G. Hermann, *Elementa doctrinae metricae*, 1816); those in Stobaeus are generally considered spurious. Ennius translated some poems of this kind, included in his book of satires, under the name of *Sota*.

SOTER, pope from about 167 to 174. He wrote to the Church of Corinth and sent it aid. His letter is mentioned in the reply given by Dionysius, bishop of Corinth, and Harnack thinks it can be identified with the second so-called epistle of Clement to the Corinthians.

SOTHEBY, WILLIAM (1757-1833), English author, was born in London on the 9th of November 1757. He was educated at Harrow, and subsequently procured a commission in a cavalry regiment. In 1780 he retired from the army on his marriage and devoted himself to literature, becoming a prominent figure in London literary society. His ample means enabled him to play the part of patron to many struggling authors, and his friends included Scott, Byron, Wordsworth, Coleridge, Southey, Hallam and Tom Moore. He himself soon acquired a considerable reputation as a translator, his verse translation of Virgil's

¹The word is also used of the dancers in indecent ballets, to which such poems were probably written as an accompaniment. In Greek and Latin authors *κίναδος* (*cinaedus*) generally means "catamite."

Georgics (1800) being specially praised by contemporary critics, while in later life he published translations of the *Iliad* and *Odyssey*. He also wrote several historical tragedies for the stage, of which one was acted, and some poems. He died on the 30th of December 1833.

SOTHERN, EDWARD ASKEW (1826-1881), English actor, was born in Liverpool on the 1st of April 1826, the son of a merchant. He began acting as an amateur, and in 1849 drifted into a professional engagement with a dramatic company at St Heliers in Jersey, where he appeared as Claude Melnotte in Bulwer Lytton's *Lady of Lyons*. Between then and 1858 he played in various companies without particular success, in Birmingham and in America, where he went in 1852. On the 12th of May 1858 Tom Taylor's *Our American Cousin*, a play of no special merit, was brought out in New York, with Southern in the small part of Lord Dundreary, a caricature of an English nobleman. He gradually worked up the humour of this part so that it became the central figure of the play. In 1861, when it was produced at the Haymarket Theatre, in London, he made such a hit that the piece ran for nearly five hundred nights: "Dundreary whiskers" became the fashion, and Dundreary this, that or the other made its appearance on every side. At various times Sothern revived the character, which retained its popularity in spite of all the extravagances to which he developed its amusing features; and his name will always be famous in connexion with this rôle. In T. W. Robertson's *David Garrick* (1864) he again had a great success, his acting in the title-part, which he created, being wonderfully effective. He won wide popularity also from his interpretation of Sam Slingsby in Oxenford's *Brother Sam* (1865). Sothern was a born comedian, and off the stage had a passion for practical joking that amounted almost to a mania. His house in Kensington was a resort for people of fashion, and he was as much a favourite in America as in the United Kingdom. He died in London on the 21st of January 1881.

Sothern had three sons, all actors, the second of them, EDWARD H. SOTHERN (b. 1859), being prominent on the American stage.

SOTHIC PERIOD, in ancient Egyptian chronology, the period in which the year of 365 days circled in succession through all the seasons. The tropical year, determined as it was in Egypt by the heliacal rising of Sirius (Sothis), was almost exactly the Julian year of precisely 365¼ days (differing from the true solar year, which was 11 minutes less than this). The sothic period was thus 1461 years.

See EGYPT, *Ancient*, § F. "Chronology."

SOTO, FERDINANDO [FERNANDO, or HERNANDO] DE (1496?-1542), Spanish captain and explorer, often, though wrongly, called the discoverer of the Mississippi (first sighted by Alonso de Pineda in 1519), was born at Jeréz de los Caballeros, in Estremadura, of an impoverished family of good position, and was indebted to the favour of Pedrarias d'Avila for the means of pursuing his studies at the university. In 1519 he accompanied d'Avila on his second expedition to Darien. In 1528 he explored the coast of Guatemala and Yucatan, and in 1532 he led 300 volunteers to reinforce Pizarro in Peru. He played a prominent part in the conquest of the Incas' kingdom (helping to seize and guard the person of Atahualpa, discovering a pass through the mountains to Cuzco, &c.), and returned to Spain with a fortune of 180,000 ducats, which enabled him to marry the daughter of his old patron d'Avila, and to maintain the state of a nobleman. Excited by the reports of Alvaro Nuñez (Cabeza de Vaca) and others as to the wealth of Florida (a term then commonly used in a much wider extension than subsequently), he sold great part of his property, gathered a force of 620 foot and 123 horse, armed four ships, and obtained from Charles V. a commission as "adelantado of the Lands of Florida" and governor of Cuba. Sailing from San Lucar in April 1538, he first went to Havana, his advanced base of operations; starting thence on the 12th of May 1539 he landed in the same month in Espiritu Santo Bay, on the west coast of the present state of Florida. For nearly four years he led his men in fruitless search of gold hither and thither over the south-east of the North

American continent. His exact route is often doubtful; but it seems to have passed north into Georgia as far as 35° N., then south to the neighbourhood of Mobile, and finally north-west towards the Mississippi. This river was reached early in 1541, and the following winter was spent on the Ouachita, in modern Arkansas and Louisiana, west of the Mississippi. As they were returning in 1542 along the Mississippi, De Soto died (either in May or June; the 25th of June is perhaps the true date), and his body was sunk in its waters. Failing in an attempt to push westwards again, De Soto's men, under Luis Moscoso de Alvarado, descended the Mississippi to the sea in nineteen days from a point close to the junction of the Arkansas with the great river, and thence coasted along the Gulf of Mexico to Panuco.

Of this unfortunate expedition three very different narratives are extant, of seemingly independent origin. The first was published in 1557 at Evora, and professes to be the work of a Portuguese gentleman of Elvas, who had accompanied the expedition: *Relaçam verdadeira dos trabalhos q̄ ho governador dō Fernão d'Soulo & certos fidalgos portugueses passaram no d'scobrimẽto da Provincia da Florida. Agora nouamete feita per hu fidalgo Deluas*. An English translation was published by Hakluyt in 1609 (reprinted from the 1611 edition by the Hakluyt Society [London, 1851]), and another by an anonymous translator in 1686, the latter being based on a French version by Citri de la Guette (Paris, 1685). The second narrative is the famous history of Florida by the Inca, Garcilasso de la Vega, who obtained his information from a Spanish cavalier engaged in the enterprise; it was completed in 1591, first appeared at Lisbon in 1605 under the title of *La Florida del Ynca*, and has since passed through many editions in various languages. The third is a report presented to Charles V. of Spain in his Council of the Indies in 1544, by Luis Hernandez de Biedma, who had accompanied De Soto as His Majesty's factor. It is to be found in Ternaux-Compans' "Recueil de pièces sur la Floride" in the *Historical Collections of Louisiana* (Philadelphia, 1850) and in W. B. Rye's reprint for the Hakluyt Society of Hakluyt's translation of the Portuguese narrative (*The Discovery and Conquest of Terra Florida*, London, 1851).

See also Bancroft's *History of the United States*, vol. i.; J. H. M'Culloch, *Researches . . . concerning the aboriginal history of America* (Baltimore, 1829); Albert Gallatin, "Synopsis of the Indian Tribes," in *Archæologia americana*, vol. ii. (Cambridge, Mass., 1836); E. G. Bourne (ed.), *Narratives of the Career of Hernando de Soto in the Conquest of Florida* (2 v., New York, 1904); J. W. Monette, *History of the Discovery and Settlement of the Valley of the Mississippi* (New York, 1846, 2 vols.).

SOU (O. Fr. *sol*, Lat. *solidus*, sc. *nummus*), the name of the bronze 5-centime French coin, corresponding to the English "halfpenny." It is still colloquially used in France in reckoning, and the franc, 2 and 5-franc pieces are known as *pièce de vingt*, *quarante* and *cent sous* respectively. The *solidus* was originally a gold coin, first struck c. A.D. 312 by Constantine to take the place of the *aureus*. In the Eastern Empire this gold coin was the standard down to 1453, and, as the "bezant," circulated from Portugal to the Indies. In the West after Pippin gold coinage ceased and the *solidus* in silver became the standard, one pound of silver making 22 *sols* (*solidi*) and 264 *deniers* (*denarii*). Under Charlemagne one pound of silver = 20 *sols* = 240 *deniers*. The *livre* (*libra*), the *sol* and the *denier* formed the universal money of account throughout France until the Revolution; and they have left their mark on the English money symbols *£ s. d.*, for pounds, shillings and pence.

SOUBISE, BENJAMIN DE ROHAN, DUC DE (? 1589-1642), Huguenot leader, younger brother of Henri de Rohan, inherited his title through his mother Catherine de Parthenay. He served his apprenticeship as a soldier under Prince Maurice of Orange-Nassau in the Low Countries. In the religious wars from 1621 onwards his elder brother chiefly commanded on land and in the south, Soubise in the west and along the sea-coast. His exploits in the conflict have been sympathetically related by his brother, who if he was not quite an impartial witness, was one of the best military critics of the time. Soubise's chief exploit was a singularly bold and well-conducted attack (in 1625) on the Royalist fleet in the river Blavet (which included the cutting of a boom in the face of superior numbers) and the occupation of Oléron. He commanded at Rochelle during the famous siege, and (if we may believe his brother) the failure of the defence and of the English attack on Rhé was mainly due to the alternate obstinacy of the townsfolk and the English commanders in refusing to

listen to Soubise's advice. When surrender became inevitable he fled to England, which he had previously visited in quest of succour. He died in 1642 in London. The Soubise title afterwards served as the chief second designation (not for heirs apparent, but for the chief collateral branch for the time being) of the house of Rohan-Chabot.

The name Soubise appears again in the military history of France in the person of CHARLES DE ROHAN, PRINCE DE SOUBISE (1715-1787), peer and marshal of France, the grandson of the princesse de Soubise, who is known to history as one of the mistresses of Louis XIV. He accompanied Louis XV. in the campaign of 1744-48 and attained high military rank, which he owed more to his courtiership than to his generalship. Soon after the beginning of the Seven Years' War, through the influence of Mme de Pompadour, he was put in command of a corps of 24,000 men, and in November 1757 he sustained the crushing defeat of Rossbach. He was more fortunate, however, in his later military career, and continued in the service until the general peace of 1763, after which he lived the life of an ordinary courtier and man of fashion in Paris, dying on the 4th of July 1787.

SOUHAM, JOSEPH, COUNT (1760-1837), French soldier, was born at Lubersac on the 30th of April 1760, and served in the French army as a private from 1782 to 1790. In 1792, having shown himself active in the cause of the Revolution, he was elected commandant of a volunteer battalion, and by 1793 he had risen to the rank of general of division. He served with credit under Pichegru in Holland (1795), but in 1799 fell into disgrace on suspicion of being concerned in Royalist intrigues. He was reinstated in 1800 and served under Moreau in the Danube campaign of that year. During the Consulate he appears to have been involved in conspiracies, and along with his old commanders Moreau and Pichegru was disgraced for alleged participation in that of Georges Cadoudal. He regained his rank, however, in 1809, took a notable part in Gouvion St Cyr's operations in Catalonia, and won the title of count by his conduct at the action of Vich, in which he was wounded. In 1812 Marshal Masséna, in declining the command of Marmont's army which had just been defeated at Salamanca, recommended Souham for the post. The latter was thus pitted against Wellington, and by his skilful manœuvres drove the English general back from Burgos and regained the ground lost at Salamanca. In 1813 he distinguished himself again at Lützen and at Leipzig (when he was wounded). At the fall of the First Empire he deserted the emperor, and having suffered for the Royalist cause was well received by Louis XVIII., who gave him high commands. These Souham lost at the return of Napoleon and regained after the Second Restoration. He retired in 1832, and died on the 28th of April 1837.

SOULARY, JOSEPHIN [JOSEPH MARIE] (1815-1891), French poet, son of a Lyons merchant of Genoese origin (Solari), was born on the 23rd of February 1815. He entered a line regiment when he was sixteen, serving for five years. He was chef de bureau in the prefecture of the Rhône from 1845 to 1867, and in 1868 he became librarian to the *Palais des arts* in his native town. He died at Lyons on the 28th of March 1891. His works include *À travers champs* (1837); *Les Cinq cordes du luth* (1838); *Les Ephémères* (two series, 1846 and 1857); *Sonnets humoristiques* (1862); *Les Figulines* (1862); *Pendant l'invasion* (1871); *Les Rimes ironiques* (1877); *Jeux divins* (1882), and two comedies. His *Œuvres poétiques* were collected in three volumes (1872-1883). His *Sonnets humoristiques* attracted great attention, and charmed their readers by the mixture of gaiety and tragedy. His mastery over the technical difficulties of his art, especially in the sonnet, won him the title of the "Benvenuto of rhyme."

See also Paul Mariéton, *Soulary et la Pléiade lyonnaise* (1884).

SOULT, NICOLAS JEAN DE DIEU, Duke of Dalmatia (1769-1851), marshal of France, was born at Saint-Amans-la-Bastide (now in department of the Tarn) on the 29th of March 1769, and was the son of a country notary at that place. He was fairly well educated, and intended for the bar, but his father's death when

he was still a boy made it necessary for him to seek his fortune, and he enlisted as a private in the French infantry in 1785. His superior education ensured his promotion to the rank of sergeant after six years' service, and in July 1791 he became instructor to the first battalion of volunteers of the Bas-Rhin. He served with his battalion in 1792. By 1794 he was adjutant-general (with the rank of *chef de brigade*). After the battle of Fleurus, in which he greatly distinguished himself for coolness, he was promoted general of brigade by the representatives on mission. For the next five years he was constantly employed in Germany under Jourdan, Moreau, Kléber and Lefebvre, and in 1799 he was promoted general of division and ordered to proceed to Switzerland. It was at this time that he laid the foundations of his military fame, and he particularly distinguished himself in Masséna's great Swiss campaign, and especially at the battle of Zürich. He accompanied Masséna to Genoa, and acted as his principal lieutenant throughout the protracted siege of that city, during which he operated with a detached force without the walls, and after many successful actions he was wounded and taken prisoner at Monte Cretto on the 13th of April 1800. The victory of Marengo restoring his freedom, he received the command of the southern part of the kingdom of Naples, and in 1802 he was appointed one of the four generals commanding the consular guard. Though he was one of those generals who had served under Moreau, and who therefore, as a rule, disliked and despised Napoleon, Soult had the wisdom to show his devotion to the ruling power; in consequence he was in August 1803 appointed to the command-in-chief of the camp of Boulogne, and in May 1804 he was made one of the first marshals of France. He commanded a corps in the advance on Ulm, and at Austerlitz (*q.v.*) he led the decisive attack on the allied centre. He played a great part in all the famous battles of the *Grande Armée*, except the battle of Friedland (on the day of which he forced his way into Königsberg), and after the conclusion of the peace of Tilsit he returned to France and was created (1808) duke of Dalmatia. In the following year he was appointed to the command of the II. corps of the army with which Napoleon intended to conquer Spain, and after winning the battle of Gamonal he was detailed by the emperor to pursue Sir John Moore, whom he only caught up at Corunna.

For the next four years Soult remained in Spain, and his military history is that of the Peninsular War (*q.v.*). In 1809, after his defeat by Sir John Moore, he invaded Portugal and took Oporto, but, busying himself with the political settlement of his conquests in the French interests and, as he hoped, for his own ultimate benefit as a possible candidate for the throne, he neglected to advance upon Lisbon, and was eventually dislodged from Oporto by Sir Arthur Wellesley, making a painful and almost disastrous retreat over the mountains. After the battle of Talavera he was made chief of staff of the French troops in Spain with extended powers, and on the 19th of November 1809 won the great victory of Ocaña. In 1810 he invaded Andalusia, which he speedily reduced, with the exception of Cadiz. In 1811 he marched north into Estremadura, and took Badajoz, and when the Anglo-Portuguese army laid siege to it he marched to its rescue, and fought the famous battle of Albuera (May 16). In 1812, however, he was obliged, after Wellington's great victory of Salamanca, to evacuate Andalusia, and was soon after recalled from Spain at the request of Joseph Bonaparte, with whom, as with the other marshals, he had always disagreed. In March 1813 he assumed the command of the IV. corps of the *Grande Armée* and commanded the centre at Lützen and Bautzen, but he was soon sent, with unlimited powers, to the south of France to repair the damage done by the great defeat of Vittoria. His campaign there is the finest proof of his genius as a general, although he was repeatedly defeated by the English under Wellington, for his soldiers were but raw conscripts, while those of Wellington were the veterans of many campaigns.

Such was the military career of Marshal Soult. His political career was by no means so creditable, and it has been said of him that he had character only in front of the enemy. After

the first abdication of Napoleon he declared himself a Royalist, received the order of St Louis, and acted as minister for war from the 3rd of December 1814 to the 11th of March 1815. When Napoleon returned from Elba Soult at once declared himself a Bonapartist, was made a peer of France and acted as major-general (chief of staff) to the emperor in the campaign of Waterloo, in which rôle he distinguished himself far less than he had done as commander of an over-matched army. At the Second Restoration he was exiled, but not for long, for in 1819 he was recalled and in 1820 again made a marshal of France. He once more tried to show himself a fervent Royalist and was made a peer in 1827. After the revolution of 1830 he made out that he was a partisan of Louis Philippe, who welcomed his adhesion and revived for him the title of marshal-general. He served as minister for war from 1830 to 1834, as ambassador extraordinary to London for the coronation of Queen Victoria in 1838, and again as minister for war from 1840 to 1844. In 1848, when Louis Philippe was overthrown, Soult again declared himself a republican. He died at his castle of Soultberg, near his birthplace, on the 26th of November 1851. Soult himself wrote but little. He published a memoir justifying his adhesion to Napoleon during the Hundred Days, and his notes and journals were arranged by his son Napoleon Hector (1801-1857), who published the first part (*Mémoires du maréchal-général Soult*) in 1854. Le Noble's *Mémoires sur les opérations des Français en Galicie* are supposed to have been written from Soult papers.

See A. Sallé, *Vie politique du maréchal Soult* (Paris, 1834); A. de Grozelier, *Le Maréchal Soult* (Castres, 1851); A. Combes, *Histoire anecdotique du maréchal Soult* (Castres, 1869).

SOMET, ALEXANDRE (1788-1845), French poet, was born on the 8th of February 1788 at Castelnaudary, department of Aude. His father wished him to enter the army, but an early-developed love of poetry turned the boy's ambition in other directions. He was an admirer of Klopstock and Schiller, then little known in France, and reproached Mme de Staël with lack of enthusiasm for her subject in *De l'Allemagne*. Soumet came to Paris in 1810, and some poems in honour of Napoleon secured his nomination as auditor of the Conseil d'État. His well-known elegy *La Pauvre fille* appeared in 1814, and two successful tragedies produced in 1822, *Clytemnestre* and *Saül*, secured his admission to the Academy in 1824. *Jeanne d'Arc* (1825) aroused great enthusiasm, and was the best of his plays. Among his other pieces *Élisabeth de France* (1828), a weak imitation of Schiller's *Don Carlos*, may be noted, but Soumet's real bent was towards epic poetry. His most considerable work is a poem inspired by Klopstock, *La Divine épopée*, which describes the descent of Christ into Hades. Under Louis XVIII. he became librarian of Saint-Cloud, and subsequently was transferred to Rambouillet and to Compiègne. He died on the 30th of March 1845, leaving an unfinished epic on Jeanne d'Arc. His daughter Gabrielle (Mme Beauvain d'Altenheim) had collaborated with him in some of his later works.

SOUND,¹ subjectively the sense impression of the organ of

¹ "Sound" is an interesting example of the numerous homonymous words in the English language. In the sense in which it is treated in this article it appears in Middle English as *soun*, and comes through Fr. *son* from Lat. *sonus*; the *d* is a mere addition, as in the nautical term "bound" (outward, homeward bound) for the earlier "boun," to make ready, prepare. In the adjectival meaning, healthy, perfect, complete, chiefly used of a deep undisturbed sleep, or of a well-based argument or doctrine, or of a person well trained in his profession, the word is in O. Eng. *sund*, and appears also in Ger. *gesund*, Du. *gezond*. It is probably cognate with the Lat. *sanus*, healthy, whence the Eng. sane, insanity, sanitation, &c. Lastly, there is a group of words which etymologists are inclined to treat as being all forms of the word which in O. Eng. is *sund*, meaning "swimming." These words are for (1) the swim-bladder of a fish; (2) a narrow stretch of water between an inland sea and the ocean, or between an island and the mainland, &c., cf. SOUND, THE, below; (3) to test or measure the depth of anything, particularly the depth of water in lakes or seas (see SOUNDING, below). As a substantive the term is used of a surgical instrument for the exploration of a wound, cavity, &c., a probe. In these senses the word has frequently been referred to Lat. *sub unda*, under the water; and Fr. *sombre*, gloomy, possibly from *sub umbra*, beneath the shade, is given as a parallel.

hearing, and objectively the vibratory motion which produces the sensation of sound. The physiological and psychical aspects of sound are treated in the article HEARING. In this article, which covers the science of Acoustics, we shall consider only the physical aspect of sound, that is, the physical phenomena outside ourselves which excite our sense of hearing. We shall discuss the disturbance which is propagated from the source to the ear, and which there produces sound, and the modes in which various sources vibrate and give rise to the disturbance.

Sound is due to Vibrations.—We may easily satisfy ourselves that, in every instance in which the sensation of sound is excited, the body whence the sound proceeds must have been thrown, by a blow or other means, into a state of agitation or tremor, implying the existence of a vibratory motion, or motion to and fro, of the particles of which it consists.

Thus, if a common glass-jar be struck so as to yield an audible sound, the existence of a motion of this kind may be felt by the finger lightly applied to the edge of the glass; and, on increasing the pressure so as to destroy this motion the sound forthwith ceases. Small pieces of cork put in the jar will be found to dance about during the continuance of the sound; water or spirits of wine poured into the glass will, under the same circumstances, exhibit a ruffled surface. The experiment is usually performed, in a more striking manner, with a bell-jar and a number of small light wooden balls suspended by silk strings to a fixed frame above the jar, so as to be just in contact with the widest part of the glass. On drawing a violin bow across the edge, the pendulums are thrown off to a considerable distance, and falling back are again repelled, and so on.

It is also in many cases possible to follow with the eye the motions of the particles of the sounding body, as, for instance, in the case of a violin string or any string fixed at both ends, when the string will appear through the persistence of visual sensation to occupy at once all the positions which it successively assumes during its vibratory motion.

Sound takes Time to Travel.—If we watch a man breaking stones by the roadside some distance away, we can see the hammer fall before we hear the blow. We see the steam issuing from the whistle of a distant engine long before we hear the sound. We see lightning before we hear the thunder which spreads out from the flash, and the more distant the flash the longer the interval between the two. The well-known rule of a mile for every five seconds between flash and peal gives a fair estimate of the distance of the lightning.

Sound needs a Material Medium to Travel Through.—In order that the ear may be affected by a sounding body there must be continuous matter reaching all the way from the body to the ear. This can be shown by suspending an electric bell in the receiver of an air-pump, the wires conveying the current passing through an air-tight cork closing the hole at the top of the receiver. These wires form a material channel from the bell to the outside air, but if they are fine the sound which they carry is hardly appreciable. If while the air within the receiver is at atmospheric pressure the bell is set ringing continuously, the sound is very audible. But as the air is withdrawn by the pump the sound decreases, and when the exhaustion is high the bell is almost inaudible.

Usually air is the medium through which sound travels, but it can travel through solids or liquids. Thus in the air-pump experiment, before exhaustion it travels through the glass of the receiver and the base plate. We may easily realise its transmission through a solid by putting the ear against a table and scratching the wood at some distance, and through a liquid by keeping both ears under water in a bath and tapping the side of the bath.

Sound is a Disturbance of the Wave Kind.—As sound arises in general from vibrating bodies, as it takes time to travel, and as the medium which carries it does not on the whole travel forward, but subsides into its original position when the sound has passed, we are forced to conclude that the disturbance is of the wave kind. We can at once gather some idea of the nature of sound waves in air by considering how they are produced by a bell.

Let AB (fig. 1) be a small portion of a bell which vibrates to and fro from CD to EF and back. As AB moves from CD to EF it pushes forward the layer of air in contact with it. That layer presses against and pushes forward the next layer and so on. Thus a push or a compression of the air is transmitted onwards in the direction OX. As AB returns from EF towards CD the layer of air next to it follows it as if it were pulled back by AB. Really, of course, it is pressed into the space made for it by the rest of the air, and flowing into this space it is extended. It makes room for the next layer of air to move back and to be extended and so on, and an extension of the air is transmitted onwards following the compression which has already gone out. As AB again moves from CD towards EF another compression or push is sent out, as it returns from EF towards CD another extension or pull, and so on. Thus waves are propagated along OX, each wave consisting of one push and one pull, one wave emanating from each complete vibration to and fro of the source AB.

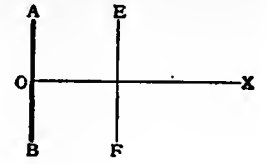

FIG. 1.

Crova's Disk.—We may obtain an excellent representation of the motion of the layers of air in a train of sound waves by means of a device due to Crova and known as "Crova's disk." A small circle, say 2 or 3 mm. radius, is drawn on a card as in fig. 2, and round this circle equidistant points, say 8 or 12, are

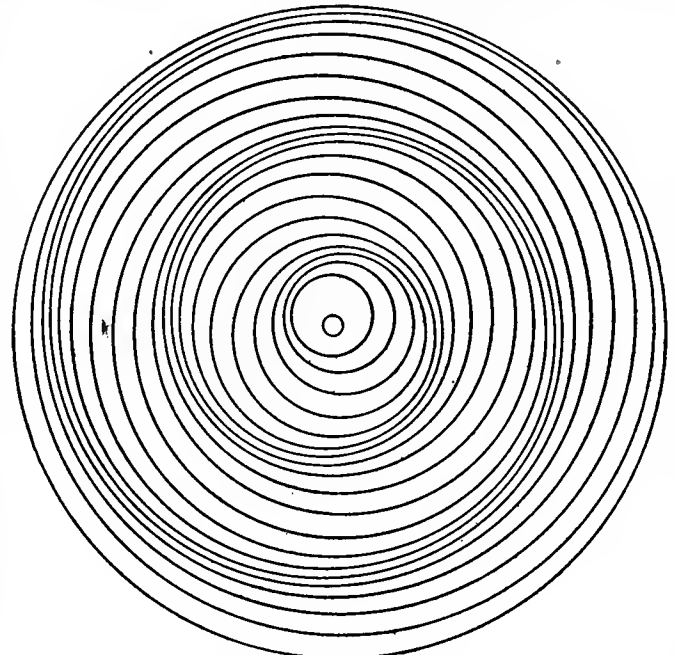

FIG. 2.

taken. From these points as centres, circles are drawn in succession, each with radius greater than the last by a fixed amount, say 4 or 5 mm. In the figure the radius of the inner circle is 3 mm. and the radii of the circles drawn round it are 12, 16, 20, &c. If the figure thus drawn is spun round its centre in the right direction in its own plane waves appear to travel out from the centre along any radius. If a second card with a narrow slit in it is held in front of the first, the slit running from the centre outwards, the wave motion is still more evident. If the figure be photographed as a lantern slide which is mounted so as to turn round, the wave motion is excellently shown on the screen, the compressions and extensions being represented by the crowding in and opening out of the lines.

Another illustration is afforded by a long spiral of wire with coils, say 2 in. in diameter and $\frac{1}{2}$ in. apart. It may be hung up by threads so as to lie horizontally. If one end is sharply pressed in, a compression can be seen running along the spring.

The Disturbance in Sound Waves is Longitudinal.—The motion of a particle of air is, as represented in these illustrations, to and fro in the direction of propagation, i.e. the disturbance

is "longitudinal." There is no "transverse" disturbance, that is, there is in air no motion across the line of propagation, for such motion could only be propagated from one layer to the next by the "viscous" resistance to relative motion, and would die away at a very short distance from the source. But transverse disturbances may be propagated as waves in solids. For instance, if a rope is fixed at one end and held in the hand at the other end, a transverse jerk by the hand will travel as a transverse wave along the rope. In liquids sound waves are longitudinal as they are in air. But the waves on the surface of a liquid, which are not of the sound kind, are both longitudinal and transverse, the compound nature being easily seen in watching the motion of a floating particle.

Displacement Diagram.—We can represent waves of longitudinal displacement by a curve, and this enables us to draw very important conclusions in a very simple way. Let a train of waves be passing from left to right in the direction ABCD (fig. 3). At every point

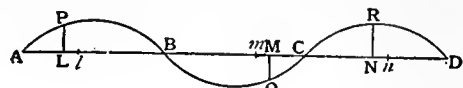

FIG. 3.

let a line be drawn perpendicular to AD and proportional to the displacement of the particle which was at the point before the disturbance began. Thus let the particle which was at L be at l , to the right or forwards, at a given instant. Draw LP upward and some convenient multiple of LL. Let the particle which was at M originally be at m at the given instant, being displaced to the left or backwards. Draw MQ downwards, the same multiple of Mm. Let N be displaced forward to n . Draw NR the same multiple of Nn and upwards. If this is done for every point we obtain a continuous curve APBQCRD, which represents the displacement at every point at the given instant, though by a length at right angles to the actual displacement and on an arbitrary scale. At the points ABCD there is no displacement, and the line AD through these points is called the *axis*. Forward displacement is represented by height above the axis, backward displacement by depth below it. In ordinary sound waves the displacement is very minute, perhaps of the order 10^{-5} cm., so that we multiply it perhaps by 100,000 in forming the displacement curve.

Wave Length and Frequency.—If the waves are continuous and each of the same shape they form a "train," and the displacement curve repeats itself. The shortest distance in which this repetition occurs is called the *wave-length*. It is usually denoted by λ . In fig. 3, $AC = \lambda$. If the source makes n vibrations in one second it is said to have "frequency" n . It sends out n waves in each second. If each wave travels out from the source with velocity U the n waves emitted in one second must occupy a length U and therefore $U = n\lambda$.

Distribution of Compression and Extension in a Wave.—Let fig. 4 be the displacement diagram of a wave travelling from left to right.

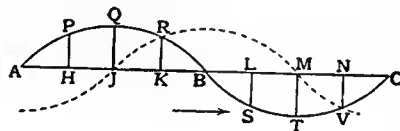

FIG. 4.

At A the air occupies its original position, while at H it is displaced towards the right or away from A since HP is above the axis. Between A and H, then, and about H, it is extended. At J the displacement is forward, but since the curve at Q is parallel to the axis the displacement is approximately the same for all the points close to J, and the air is neither extended nor compressed, but merely displaced bodily a distance represented by JQ. At B there is no displacement, but at K there is displacement towards B represented by KR, i.e. there is compression. At L there is also displacement towards B and again compression. At M, as at J, there is neither extension nor compression. At N the displacement is away from C and there is extension. The dotted curve represents the distribution of compression by height above the axis, and of extension by depth below it. Or we may take it as representing the pressure-excess over the normal pressure in compression, defect from it in extension.

The figure shows that when the curve of displacement slopes down in the direction of propagation there is compression, and the pressure is above the normal, and that when it slopes up there is extension, and the pressure is below the normal.

Distribution of Velocity in a Wave.—If a wave travels on without alteration the travelling may be represented by pushing on the displacement curve. Let the wave AQBTC (fig. 5) travel to

A'QB'TC' in a very short time. In that short time the displacement at H decreases from HP to HP' or by PP'. The motion of the particle is therefore backwards towards A. At J the displacement remains the same, or the particle is not moving. At K it increases by RR' forwards, or the motion is forwards towards B. At L the displacement backward decreases, or the motion is forward

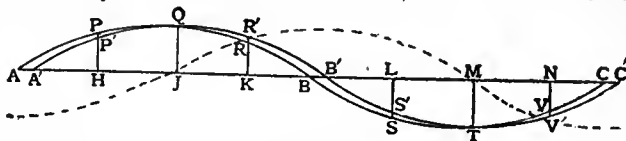

FIG. 5.

At M, as at J, there is no change, and at N it is easily seen that the motion is backward. The distribution of velocity then is represented by the dotted curve and is forward when the curve is above the axis and backward when it is below.

Comparing figs. 4 and 5 it is seen that the velocity is forward in compression and backward in extension.

The Relations between Displacement, Compression and Velocity.—The relations shown by figs. 4 and 5 in a general manner may easily be put into exact form. Let OX (fig. 6) be the direction

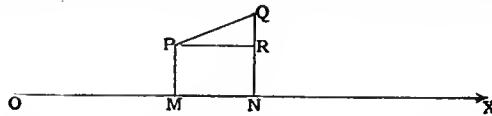

FIG. 6.

of travel, and let x be the distance of any point M from a fixed point O. Let $ON = x + dx$. Let $MP = y$ represent the forward displacement of the particle originally at M, and $NQ = y + dy$ that of the particle originally at N. The layer of air originally of thickness dx now has thickness $dx + dy$, since N is displaced forwards dy more than M. The volume dx , then, has increased to $dx + dy$ or volume 1 has increased to $1 + dy/dx$ and the increase of volume is dy/dx .

Let E be the bulk modulus of elasticity, defined as increase of pressure \div decrease of volume per unit volume where the pressure increase is so small that this ratio is constant, ω the small increase of pressure, and $-(dy/dx)$ the volume decrease, then

$$E = \omega / (-dy/dx) \text{ or } \omega / E = -dy/dx \quad (1)$$

This gives the relation between pressure excess and displacement.

To find the relation of the velocity to displacement and pressure we shall express the fact that the wave travels on carrying all its conditions with it, so that the displacement now at M will arrive at N while the wave travels over MN. Let U be the velocity of the wave and let u be the velocity of the particle originally at N. Let $MN = dx = Udt$. In the time dt which the wave takes to travel over MN the particle displacement at N changes by QR, and $QR = -udt$, so that $QR/MN = -u/U$. But $QR/MN = dy/dx$. Then

$$u/U = -dy/dx \quad (2)$$

This gives the velocity of any particle in terms of the displacement. Equating (1) and (2)

$$u/U = \omega/E \quad (3)$$

which gives the particle velocity in terms of the pressure excess.

Generally, if any condition ϕ in the wave is carried forward unchanged with velocity U , the change of ϕ at a given point in time dt is equal to the change of ϕ as we go back along the curve a distance $dx = Udt$ at the beginning of dt .

Then
$$\frac{d\phi}{dx} = -\frac{1}{U} \frac{d\phi}{dt}$$

The Characteristics of Sound Waves Corresponding to Loudness, Pitch and Quality.—Sounds differ from each other only in the three respects of loudness, pitch and quality.

The *loudness* of the sound brought by a train of waves of given wave-length depends on the extent of the to and fro excursion of the air particles. This is obvious if we consider that the greater the vibration of the source the greater is the excursion of the air in the issuing waves, and the louder is the sound heard. Half the total excursion is called the amplitude. Thus in fig. 4 QJ is the amplitude. Methods of measuring the amplitude in sound waves in air have been devised and will be described later. We may say here that the energy or the intensity of the sound of given wave-length is proportional to the square of the amplitude.

The *pitch* of a sound, the note which we assign to it, depends on the number of waves received by the ear per second. This is generally equal to the number of waves issuing from the source per second, and therefore equal to its frequency of vibration. Experiments, which will be described most conveniently when

we discuss methods of determining the frequencies of sources, prove conclusively that for a given note the frequency is the same whatever the source of that note, and that the ratio of the frequencies of two notes forming a given musical interval is the same in whatever part of the musical range the two notes are situated. Here it is sufficient to say that the frequencies of a note, its major third, its fifth and its octave, are in the ratios of 4 : 5 : 6 : 8.

The quality or timbre of sound, i.e. that which differentiates a note sounded on one instrument from the same note on another instrument, depends neither on amplitude nor on frequency or wave-length. We can only conclude that it depends on wave form, a conclusion fully borne out by investigation. The displacement curve of the waves from a tuning-fork on its resonance box, or from the human voice sounding *oo*, are nearly smooth and symmetrical, as in fig. 7*a*. That for the air waves from a violin are probably nearly as in fig. 7*b*.

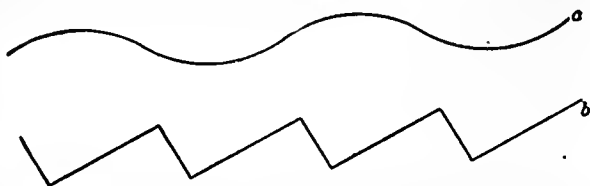

FIG. 7.

Calculation of the Velocity of Sound Waves in Air.—The velocity with which waves of longitudinal disturbance travel in air or in any other fluid can be calculated from the resistance to compression and extension and the density of the fluid. It is convenient to give this calculation before proceeding to describe the experimental determination of the velocity in air, in other gases and in water, since the calculation serves to some extent as a guide in conducting and interpreting the observations.

The waves from a source surrounded by a uniform medium at rest spread out as spheres with the source as centre. If we take one of these spheres a distance from the source very great as compared with a single wave-length, and draw a radius to a point on the sphere, then for some little way round that point the sphere may be regarded as a plane perpendicular to the radius or the line of propagation. Every particle in the plane will have the same displacement and the same velocity, and these will be perpendicular to the plane and parallel to the line of propagation. The waves for some little distance on each side of the plane will be practically of the same size. In fact, we may neglect the divergence, and may regard them as "plane waves."

We shall investigate the velocity of such plane waves by a method which is only a slight modification of a method given by W. J. M. Rankine (*Phil. Trans.*, 1870, p. 277).

Whatever the form of a wave, we could always force it to travel on with that form unchanged, and with any velocity we chose, if we could apply any "external" force we liked to each particle, in addition to the "internal" force called into play by the compressions or extensions. For instance, if we have a wave with displacement curve of form ABC (fig. 8), and we require it to travel

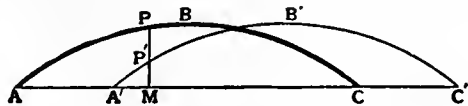

FIG. 8.

on in time dt to $A'B'C'$, where $AA' = Udt$, the displacement of the particle originally at M must change from PM to $P'M$ or by PP' . This change can always be effected if we can apply whatever force may be needed to produce it.

We shall investigate the external force needed to make a train of plane waves travel on unchanged in form with velocity U .

We shall regard the external force as applied in the form of a pressure X per square centimetre parallel to the line of propagation and varied from point to point as required in order to make the disturbance travel on unchanged in form with the specified velocity U . In addition there will be the internal force due to the change in volume, and consequent change in pressure, from point to point.

Suppose that the whole of the medium is moved backwards in space along the line of propagation so that the undisturbed portions travel with the velocity U . The disturbance, or the train of waves, is then fixed in space, though fresh matter continually enters the disturbed region at one end, undergoes the disturbance, and then leaves it at the other end.

Let A (fig. 9) be a point fixed in space in the disturbed region, B a fixed point where the medium is not yet disturbed, the medium

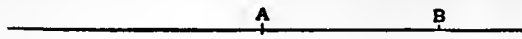

FIG. 9.

moving through A and B from right to left. Since the condition of the medium between A and B remains constant, even though the matter is continually changing, the momentum possessed by the matter between A and B is constant. Therefore the momentum entering through a square centimetre at B per second is equal to the momentum leaving through a square centimetre at A . Now the transfer of momentum across a surface occurs in two ways, firstly by the carriage of moving matter through the surface, and secondly by the force acting between the matter on one side of the surface and the matter on the other side. U cubic centimetres move in per second at B , and if the density is ρ_0 the mass moving in through a square centimetre is $\rho_0 U$. But it has velocity U , and therefore momentum $\rho_0 U^2$ is carried in. In addition there is a pressure between the layers of the medium, and if this pressure in the undisturbed parts of the medium is P , momentum P per second is being transferred from right to left across each square centimetre. Hence the matter moving in is receiving on this account P per second from the matter to the right of it. The total momentum moving in at B is therefore $P + \rho_0 U^2$. Now consider the momentum leaving at A . If the velocity of a particle at A relative to the undisturbed parts is u from left to right, the velocity of the matter moving out at A is $U - u$, and the momentum carried out by the moving matter is $\rho(U - u)^2$. But the matter to the right of A is also receiving momentum from the matter to the left of it at the rate indicated by the force across A . Let the excess of pressure due to change of volume be ω , so that the total "internal" pressure is $P + \omega$. There is also the "external" applied pressure X , and the total momentum flowing out per second is

$$X + P + \omega + \rho(U - u)^2.$$

Equating this to the momentum entering at B and subtracting P from each

$$X + \omega + \rho(U - u)^2 = \rho_0 U^2. \tag{4}$$

If y is the displacement at A , and if E is the elasticity, substituting for ω and u from (2) and (3) we get

$$X - E \frac{dy}{dx} + \rho U^2 \left(1 + \frac{dy}{dx}\right)^2 = \rho_0 U^2.$$

But since the volume dx with density ρ_0 has become volume $dx + dy$ with density ρ

$$\rho \left(1 + \frac{dy}{dx}\right) = \rho_0.$$

Then

$$X - E \frac{dy}{dx} + \rho_0 U^2 \left(1 + \frac{dy}{dx}\right) = \rho_0 U^2,$$

or

$$X = (E - \rho_0 U^2) dy/dx. \tag{5}$$

If then we apply a pressure X given by (5) at every point, and move the medium with any uniform velocity U , the disturbance remains fixed in space. Or if we now keep the undisturbed parts of the medium fixed, the disturbance travels on with velocity U if we apply the pressure X at every point of the disturbance.

If the velocity U is so chosen that $E - \rho_0 U^2 = 0$, then $X = 0$, or the wave travels on through the action of the internal forces only, unchanged in form and with velocity

$$U = \sqrt{E/\rho}. \tag{6}$$

The pressure X is introduced in order to show that a wave can be propagated unchanged in form. If we omitted it we should have to assume this, and equation (6) would give us the velocity of propagation if the assumption were justified. But a priori we are hardly justified in assuming that waves can be propagated at all, and certainly not justified in assuming that they go on unchanged by the action of the internal forces alone. If, however, we put on external forces of the required type X it is obvious that any wave can be propagated with any velocity, and our investigation shows that when U has the value in (6) then and only then X is zero everywhere, and the wave will be propagated with that velocity when once set going.

It may be noted that the elasticity E is only constant for small volume changes or for small values of dy/dx .

Since by definition $E = -v(dp/dv) = \rho(dp/d\rho)$ equation (6) becomes

$$U = \sqrt{dp/d\rho}. \tag{7}$$

The value $U = \sqrt{E/\rho}$ was first virtually obtained by Newton (*Principia*, bk. ii., § 8, props. 48-49). He supposed that in air Boyle's law holds in the extensions and compressions, or that $p = k\rho$, whence $dp/d\rho = k = p/\rho$. His value of the velocity in air is therefore

$$U = \sqrt{p/\rho} \tag{Newton's formula.}$$

At the standard pressure of 76 cm. of mercury or 1,014,000 dynes / sq. cm., the density of dry air at 0° C. being taken as 0.001293, we get for the velocity in dry air at 0° C.

$$U_0 = 28,000 \text{ cm. sec. (about 920 ft./sec.)}$$

approximately. Newton found 979 ft./sec. But, as we shall see, all the determinations give a value of U_0 in the neighbourhood of 33,000 cm./sec., or about 1080 ft./sec. This discrepancy was not explained till 1816, when Laplace (*Ann. de chimie*, 1816, vol. iii.) pointed out that the compressions and extensions in sound waves in air alternate so rapidly that there is no time for the temperature inequalities produced by them to spread. That is to say, instead of using Boyle's law, which supposes that the pressure changes so exceedingly slowly that conduction keeps the temperature constant, we must use the adiabatic relation $p = k\rho\gamma$, whence

$$\frac{dp}{d\rho} = \gamma k \rho^{\gamma-1} = \gamma p / \rho, \quad \text{and} \quad U = \sqrt{\gamma p / \rho} \quad \text{[Laplace's formula].} \quad (8)$$

If we take $\gamma = 1.4$ we obtain approximately for the velocity in dry air at 0°C .

$$U_0 = 33,150 \text{ cm./sec.},$$

which is closely in accordance with observation. Indeed Sir G. G. Stokes (*Math. and Phys. Papers*, iii, 142) showed that a very small departure from the adiabatic condition would lead to a stifling of the sound quite out of accord with observation.

If we put $p = k\rho(1+at)$ in (8) we get the velocity in a gas at $t^\circ \text{C}$.

$$U_t = \sqrt{\{\gamma k(1+at)\}}.$$

At 0°C . we have $U_0 = \sqrt{\gamma k}$, and hence

$$U_t = U_0 \sqrt{1+at} = U_0(1+0.00184t) \quad \text{(for small values of } t\text{).} \quad (9)$$

The velocity then should be independent of the barometric pressure, a result confirmed by observation.

For two different gases with the same value of γ , but with densities at the same pressure and temperature respectively ρ_1 and ρ_2 , we should have

$$U_1/U_2 = \sqrt{(\rho_2/\rho_1)}, \quad (10)$$

another result confirmed by observation.

Alteration of Form of the Waves when Pressure Changes are Considerable.—When the value of dy/dx is not very small E is no longer constant, but is rather greater in compression and rather less in extension than γP . This can be seen by considering that the relation between p and ρ is given by a curve and not by a straight line. The consequence is that the compression travels rather faster, and the extension rather slower, than at the speed found above.

We may get some idea of the effect by supposing that for a short time the change in form is negligible. In the momentum equation (4) we may now omit X and it becomes

$$\omega + \rho(U-u)^2 = \rho_0 U^2.$$

Let us seek a more exact value for ω . If when P changes to $P+\omega$ volume V changes to $V-v$ then $(P+\omega)(V-v) = PV\gamma$,

$$\text{whence} \quad \omega = P \left(\frac{v}{V} + \frac{\gamma(\gamma+1)v^2}{2V^2} \right) = \frac{Pv}{V} \left(1 + \frac{\gamma+1}{2} \frac{v}{V} \right).$$

We have $U-u = U(1-u/U) = U(1-v/V)$, since $u/U = -dy/dx = v/V$. Also since $\rho(V-v) = \rho_0 V$, or $\rho = \rho_0/(1-v/V)$, then $\rho(U-u)^2 = \rho_0 U^2 (1-v/V)$.

Substituting in the momentum equation, we obtain

$$\frac{Pv}{V} \left(1 + \frac{\gamma+1}{2} \frac{v}{V} \right) + \rho_0 U^2 \left(1 - \frac{v}{V} \right) = \rho_0 U^2,$$

whence

$$U^2 = \frac{\gamma P}{\rho_0} \left(1 + \frac{\gamma+1}{2} \frac{v}{U} \right).$$

If $U = \sqrt{\gamma P/\rho_0}$ is the velocity for small disturbances, we may put U_0 for U in the small term on the right, and we have

$$U = U_0 \left(1 + \frac{\gamma+1}{4} \frac{v}{U_0} \right)$$

or

$$U = U_0 + \frac{1}{4}(\gamma+1)u. \quad (11)$$

This investigation is obviously not exact, for it assumes that the form is unchanged, *i.e.* that the momentum issuing from A (fig. 9) is equal to that entering at B, an assumption no longer tenable when the form changes. But for very small times the assumption may perhaps be made, and the result at least shows the way in which the velocity is affected by the addition of a small term depending on and changing sign with u . It implies that the different parts of a wave move on at different rates, so that its form must change. As we obtained the result on the supposition of unchanged form, we can of course only apply it for such short lengths and such short times that the part dealt with does not appreciably alter. We see at once that, where $u=0$, the velocity has its "normal" value, while where u is positive the velocity is in excess, and where u is negative the velocity is in defect of the normal value. If, then, a (fig. 10) represents the displacement curve of a train of waves, b will represent the pressure excess and particle velocity, and from (11) we see that while the nodal conditions of b , with $\omega=0$ and $u=0$, travel with velocity $\sqrt{E/\rho}$, the crests exceed that velocity by $\frac{1}{4}(\gamma+1)u$, and the hollows fall short of it by $\frac{1}{4}(\gamma+1)u$, with the result that the fronts of the pressure waves become steeper and steeper, and the train b changes into something like c . If the steepness gets very great our investigation ceases to apply, and neither experiment nor theory has yet shown what happens. Probably there is a breakdown of the wave somewhat

like the breaking of a water-wave when the crest gains on the next trough. In ordinary sound-waves the effect of the particle velocity in affecting the velocity of transmission must be very small.

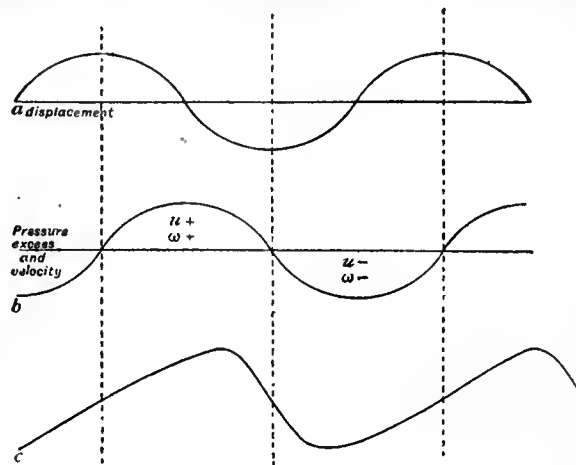

FIG. 10.

Experiments, referred to later, have been made to find the amplitude of swing of the air particles in organ pipes. Thus Mach found an amplitude 0.2 cm. when the issuing waves were 250 cm. long. The amplitude in the pipe was certainly much greater than in the issuing waves. Let us take the latter as 0.1 mm. in the waves—a very extreme value. The maximum particle velocity is $2\pi na$ (where n is the frequency and a the amplitude), or $2\pi aU/\lambda$. This gives maximum u = about 8 cm./sec., which would not seriously change the form of the wave in a few wavelengths. Meanwhile the waves are spreading out and the value of u is falling in inverse proportion to the distance from the source, so that very soon its effect must become negligible.

In loud sounds, such as a peal of thunder from a near flash, or the report of a gun, the effect may be considerable, and the rumble of the thunder and the prolonged boom of the gun may perhaps be in part due to the breakdown of the wave when the crest of maximum pressure has moved up to the front, though it is probably due in part also to echo from the surfaces of heterogeneous masses of air. But there is no doubt that with very loud explosive sounds the normal velocity is quite considerably exceeded. Thus Regnault in his classical experiments (described below) found that the velocity of the report of a pistol carried through a pipe diminished with the intensity, and his results have been confirmed by J. Violle and T. Vautier (see below). W. W. Jacques (*Phil. Mag.*, 1879, 7, p. 219) investigated the transmission of a report from a cannon in different directions; he found that it rose to a maximum of 1267 ft./sec. at 70, to 90 ft. in the rear and then fell off.

A very curious observation is recorded by the Rev. G. Fisher in an appendix to Captain Parry's *Journal of a Second Voyage to the Arctic Regions*. In describing experiments on the velocity of sound he states that "on one day and one day only, February 9, 1822, the officer's word of command 'fire' was several times heard distinctly both by Captain Parry and myself about one beat of the chronometer [nearly half a second] after the report of the gun." This is hardly to be explained by equation (11), for at the very front of the disturbance $u=0$ and the velocity should be normal.

The Energy in a Wave Train.—The energy in a train of waves carried forward with the waves is partly strain or potential energy due to change of volume of the air, partly kinetic energy due to the motion of the air as the waves pass. We shall show that if we sum these up for a whole wave the potential energy is equal to the kinetic energy.

The kinetic energy per cubic centimetre is $\frac{1}{2}\rho u^2$, where ρ is the density and u is the velocity of disturbance due to the passage of the wave. If V is the undisturbed volume of a small portion of the air at the undisturbed pressure P , and if it becomes $V-v$ when the pressure increases to $P+\omega$, the average pressure during the change may be taken as $P+\frac{1}{2}\omega$, since the pressure excess for a small change is proportional to the change. Hence the work done on the air is $(P+\frac{1}{2}\omega)v$, and the work done per cubic centimetre is $(P+\frac{1}{2}\omega)v/V$. The term Pv/V added up for a complete wave vanishes, for P/V is constant and $\Sigma v=0$, since on the whole the compression equals the extension. We have then only to consider the term $\frac{1}{2}\omega v/V$.

$$\text{But } v/V = u/U \text{ from equation (2)}$$

$$\text{and } \omega = Eu/U \text{ from equation (3)}$$

$$\text{Then } \frac{1}{2}\omega v/V = \frac{1}{2}Eu^2/U^2 = \frac{1}{2}\rho u^2 \text{ from equation (6)}$$

Then in the whole wave the potential energy equals the kinetic energy and the total energy in a complete wave in a column 1 sq. cm.

$$\text{cross-section is } W = \int_0^\lambda \rho u^2 dx.$$

We may find here the value of this when we have a train of waves in which the displacement is represented by a sine curve of amplitude a , viz. $y = a \sin \frac{2\pi}{\lambda}(x - Ut)$. For a discussion of this type of wave, see below.

We have
$$u = \frac{dy}{dt} = -\frac{2\pi}{\lambda} U a \cos \frac{2\pi}{\lambda}(x - Ut),$$

and
$$\int_0^\lambda \rho u^2 dx = \rho \frac{4\pi^2 U^2 a^2}{\lambda^2} \int_0^\lambda \cos^2 \frac{2\pi}{\lambda}(x - Ut) dx = 2\rho\pi^2 U^2 a^2 / \lambda \quad (12)$$

The energy per cubic centimetre on the average is
$$\frac{2\rho\pi^2 U^2 a^2}{\lambda^2} \quad (13)$$

and the energy passing per second through 1 sq. cm. perpendicular to the line of propagation is

$$2\rho\pi^2 U^3 a^2 / \lambda^2 \quad (14)$$

The Pressure of Sound Waves.—Sound waves, like light waves, exercise a small pressure against any surface upon which they impinge. The existence of this pressure has been demonstrated experimentally by W. Altberg (*Ann. der Physik*, 1903, 11, p. 495). A small circular disk at one end of a torsion arm formed part of a solid wall, but was free to move through a hole in the wall slightly larger than the disk. When intense sound waves impinged on the wall, the disk moved back through the hole, and by an amount showing a pressure of the order given by the following investigation:—

Suppose that a train of waves is incident normally on the surface S (fig. 11), and that they are absorbed there without reflection.

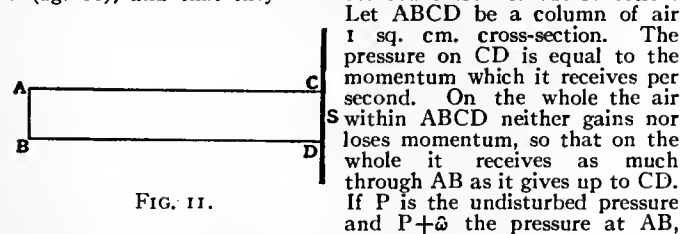

FIG. 11.

Let ABCD be a column of air 1 sq. cm. cross-section. The pressure on CD is equal to the momentum which it receives per second. On the whole the air within ABCD neither gains nor loses momentum, so that on the whole it receives as much through AB as it gives up to CD. If P is the undisturbed pressure and $P + \hat{\omega}$ the pressure at AB,

the momentum entering through AB per second is $\int_0^1 (P + \hat{\omega} + \rho u^2) dt$. But $\int_0^1 P dt = P$ is the normal pressure, and as we only wish to find the excess we may leave this out of account.

The excess pressure on CD is therefore $\int_0^1 (\hat{\omega} + \rho u^2) dt$. But the values of $\hat{\omega} + \rho u^2$ which occur successively during the second at AB exist simultaneously at the beginning of the second over the distance U behind AB. Or if the conditions along this distance U could be maintained constant, and we could travel back along it uniformly in one second, we should meet all the conditions actually arriving at AB and at the same intervals. If then $d\xi$ is an element of the path, putting $dt = d\xi/U$, we have the average excess of pressure

$$p = \int_0^1 (\hat{\omega} + \rho u^2) dt = \frac{1}{U} \int_0^U (\hat{\omega} + \rho u^2) d\xi.$$

Here $d\xi$ is an actual length in the disturbance. We have $\hat{\omega}$ and u expressed in terms of the original length dx and the displacement dy so that we must put $d\xi = dx + dy = (1 + \frac{dy}{dx}) dx$, and

$$p = \frac{1}{U} \int_0^U (\hat{\omega} + \rho u^2) \left(1 + \frac{dy}{dx}\right) dx.$$

We have already found that if V changes to $V - v$

$$\hat{\omega} = \gamma P \left(\frac{v}{V} + \frac{\gamma + 1}{2} \frac{v^2}{V^2} \right) = \rho_0 U^2 \left\{ -\frac{dy}{dx} + \frac{\gamma + 1}{2} \left(\frac{dy}{dx} \right)^2 \right\}$$

since $v/V = -dy/dx$.

We also have $\rho u^2 = \rho_0 u^2 / (1 + dy/dx)$. Substituting these values and neglecting powers of dy/dx above the second we get

$$p = \frac{1}{U} \int_0^U \rho_0 U^2 \left\{ -\frac{dy}{dx} + \frac{\gamma + 1}{2} \left(\frac{dy}{dx} \right)^2 \right\} dx.$$

But $\int_0^U \frac{dy}{dx} dx = 0$ since the sum of the displacements = 0. Then

putting $(dy/dx)^2 = (u/U)^2$, we have

$$p = \frac{\gamma + 1}{2} \cdot \frac{1}{U} \int_0^U \rho_0 u^2 dx = \frac{1}{2} (\gamma + 1) \text{ average energy per cubic centimetre,} \quad (15)$$

a result first published by Lord Rayleigh (*Phil. Mag.*, 1905, 10, p. 364).

If the train of waves is reflected, the value of p at AB will be the sum of the values for the two trains, and will, on the average, be doubled. The pressure on CD will therefore be doubled. But the energy will also be doubled, so that (15) still gives the average excess of pressure.

Experimental Determinations of the Velocity of Sound.

An obvious method of determining the velocity of sound in air consists in starting some sound, say by firing a gun, and stationing an observer at some measured distance from the gun. The observer measures by a clock or chronometer the time elapsing between the receipt of the flash, which passes practically instantaneously, and the receipt of the report. The distance divided by the time gives the velocity of the sound. The velocity thus obtained will be affected by the wind. For instance, William Derham (*Phil. Trans.*, 1708) made a series of observations, noting the time taken by the report of a cannon fired on Blackheath to travel across the Thames to Upminster Church in Essex, 12½ m. away. He found that the time varied between 55½ seconds when the wind was blowing most strongly with the sound, to 63 seconds when it was most strongly against the sound. The value for still air he estimated at 1142 ft. per second. He made no correction for temperature or humidity. But when the wind is steady its effect may be eliminated by "reciprocal" observations, that is, by observations of the time of passage of sound in each direction over the measured distance.

Let D be the distance, U the velocity of sound in still air, and w the velocity of the wind, supposed for simplicity to blow directly from one station to the other. Let T_1 and T_2 be the observed times of passage in the two directions. We have $U + w = D/T_1$ and $U - w = D/T_2$. Adding and dividing by 2

$$U = \frac{D}{2} \left(\frac{1}{T_1} + \frac{1}{T_2} \right).$$

If T_1 and T_2 are nearly equal, and if $T = \frac{1}{2}(T_1 + T_2)$, this is very nearly $U = D/T$.

The reciprocal method was adopted in 1738 by a commission of the French Academy (*Mémoires de l'académie des sciences*, 1738). Cannons were fired at half-hour intervals, alternately at Montmartre and Montlhéry, 17 or 18 m. apart. There were also two intermediate stations at which observations were made. The times were measured by pendulum clocks. The result obtained at a temperature about 6° C. was, when converted to metres, $U = 337$ metres/second.

The theoretical investigation given above shows that if U is the velocity in air at t° C. then the velocity U_0 at 0° C. in the same air is independent of the barometric pressure and that $U_0 = U / (1 + 0.00184t)$, whence $U_0 = 332$ met./sec.

In 1822 a commission of the Bureau des Longitudes made a series of experiments between Montlhéry and Villejuif, 11 m. apart. Cannons were fired at the two stations at intervals of five minutes. Chronometers were used for timing, and the result at 15.0° C. was $U = 340.9$ met./sec., whence $U_0 = 330.6$ met./sec. (F. J. D. Arago, *Connaissance des temps*, 1825).

When the measurement of a time interval depends on an observer, his "personal equation" comes in to affect the estimation of the quantity. This is the interval between the arrival of an event and his perception that it has arrived, or it may be the interval between arrival and his record of the arrival. This personal equation is different for different observers. It may differ even by a considerable fraction of a second. It is different, too, for different senses with the same observer, and different even for the same sense when the external stimuli differ in intensity. When the interval between a flash and a report is measured, the personal equations for the two arrivals are, in all probability, different, that for the flash being most likely less than that for the sound. In a long series of experiments carried out by V. Regnault in the years 1862 to 1866 on the velocity of sound in open air, in air in pipes and in various other gases in pipes, he sought to eliminate personal equation by dispensing with the human element in the observations, using electric receivers as observers. A short account of these experiments is given in *Phil. Mag.*, 1868, 35, p. 161, and the full account, which serves as an excellent example of the extraordinary care and ingenuity of Regnault's work, is given in the *Mémoires de l'académie des sciences*, 1868, xxxvii. On page 459 of the *Mémoire* will be found a list of previous careful experiments on the velocity of sound.

In the open-air experiments the receiver consisted of a large

cone having a thin india-rubber membrane stretched over its narrow end. A small metal disk was attached to the centre of the membrane and connected to earth by a fine wire. A metal contact-piece adjustable by a screw could be made to just touch a point at the centre of the disk. When contact was made it completed an electric circuit which passed to a recording station, and there, by means of an electro-magnet, actuated a style writing a record on a band of travelling smoked paper. On the same band a tuning-fork electrically maintained and a seconds clock actuating another style wrote parallel records. The circuit was continued to the gun which served as a source, and stretched across its muzzle. When the gun was fired, the circuit was broken, and the break was recorded on the paper. The circuit was at once remade. When the wave travelled to the receiver it pushed back the disk from the contact-piece, and this break, too, was recorded. The time between the breaks could be measured in seconds by the clock signals, and in fractions of a second by the tuning-fork record. The receiving apparatus had what we may term a personal equation, for the break of contact could only take place when the membrane travelled some finite distance, exceedingly small no doubt, from the contact-piece. But the apparatus was used in such a way that this could be neglected. In some experiments in which contact was made instead of broken, Regnault determined the personal equation of the apparatus.

To eliminate wind as far as possible reciprocal firing was adopted, the interval between the two firings being only a few seconds. The temperature of the air traversed and its humidity were observed, and the result was finally corrected to the velocity in dry air at 0° C. by means of equation (10).

Regnault used two different distances, viz. 1280 metres and 2445 metres, obtaining from the first $U_0 = 331.37$ met./sec.; but the number of experiments over the longer distance was greater, and he appears to have put more confidence in the result from them, viz.

$$U_0 = 330.71 \text{ met./sec.}$$

In the *Phil. Trans.*, 1872, 162, p. 1, is given an interesting determination made by E. J. Stone at the Cape of Good Hope. In this experiment the personal equations of the observers were determined and allowed for.

Velocity of Sound in Air and other Gases in Pipes.—In the memoir cited above Regnault gives an account of determinations of the velocity in air in pipes of great length and of diameters ranging from 0.108 metres to 1.1 metres. He used various sources and the method of electric registration. He found that in all cases the velocity decreased with a diameter. The sound travelled to and fro in the pipes several times before the signals died away, and he found that the velocity decreased with the intensity, tending to a limit for very feeble sounds, the limit being the same whatever the source. This limit for a diameter 1.1 m. was $U_0 = 330.6$ met./sec., while for a diameter 0.108 it was $U_0 = 324.25$ met./sec.

Regnault also set up a shorter length of pipes of diameter 0.108 m. in a court at the Collège de France, and with this length he could use dry air, vary the pressure, and fill with other gases. He found that within wide limits the velocity was independent of the pressure, thus confirming the theory. Comparing the velocities of sound U_1 and U_2 in two different gases with densities ρ_1 and ρ_2 at the same temperature and pressure, and with ratios of specific heats γ_1, γ_2 , theory gives

$$U_1/U_2 = \sqrt{\gamma_1 \rho_2 / \gamma_2 \rho_1}.$$

This formula was very nearly confirmed for hydrogen, carbon dioxide and nitrous oxide.

J. Violle and T. Vautier (*Ann. chim. phys.*, 1890, vol. 19) made observations with a tube 0.7 m. in diameter, and, using Regnault's apparatus, found that the velocity could be represented by

$$331.3(1 + C\sqrt{P}),$$

where P is the mean excess of pressure above the normal. According to von Helmholtz and Kirchhoff the velocity in a tube should be less than that in free air by a quantity depending on the diameter of the tube, the frequency of the note used, and the viscosity of the gas (Rayleigh, *Sound*, vol. ii. §§ 347-8).

Correcting the velocity obtained in the 0.7 m. tube by Kirchhoff's formula, Violle and Vautier found for the velocity in open air at 0° C.

$$U_0 = 331.10 \text{ met./sec.}$$

with a probable error estimated at ± 0.10 metre.

It is obvious from the various experiments that the velocity of sound in dry air at 0° C. is not yet known with very great accuracy. At present we cannot assign a more exact value than

$$U_0 = 331 \text{ metres per second.}$$

Violle and Vautier made some later experiments on the propagation of musical sounds in a tunnel 3 metres in diameter (*Ann. chim. phys.*, 1905, vol. 5). They found that the velocity of propagation of different musical sounds was the same. Some curious effects were observed in the formation of harmonics in the rear of the primary tone used. These have yet to find an explanation.

Velocity of Sound in Water.—The velocity in water was measured by J. D. Colladon and J. K. F. Sturm (*Ann. chim. phys.*, 1827 (2), 36, p. 236) in the water of Lake Geneva. A bell under water was struck, and at the same instant some gunpowder was flashed in air above the bell. At a station more than 13 kilometres away a sort of big ear-trumpet, closed by a membrane, was placed with the membrane under water, the tube rising above the surface. An observer with his ear to the tube noted the interval between the arrival of flash and sound. The velocity deduced at 8.1° C. was $U = 1435$ met./sec., agreeing very closely with the value calculated from the formula $U^2 = E/\rho$.

Experiments on the velocity of sound in iron have been made on lengths of iron piping by J. B. Biot, and on telegraph wires by Wertheim and Brequet. The experiments were not satisfactory, and it is sufficient to say that the results accorded roughly with the value given by theory.

Reflection of Sound.

When a wave of sound meets a surface separating two media it is in part reflected, travelling back from the surface into the first medium again with the velocity with which it approached. Echo is a familiar example of this. The laws of reflection of sound are identical with those of the reflection of light, viz. (1) the planes of incidence and reflection are coincident, and (2) the angles of incidence and reflection are equal. Experiments may be made with plane and curved mirrors to verify these laws, but it is necessary to use short waves, in order to diminish diffraction effects. For instance, a ticking watch may be put at the focus of a large concave metallic mirror, which sends a parallel "beam" of sound to a second concave mirror facing the first. If an ear-trumpet is placed at the focus of the second mirror the ticking may be heard easily, though it is quite inaudible by direct waves. Or it may be revealed by placing a sensitive flame of the kind described below with its nozzle at the focus. The flame jumps down at every tick.

Examples of reflection of sound in buildings are only too frequent. In large halls the words of a speaker are echoed or reflected from flat walls or roof or floor; and these reflected sounds follow the direct sounds at such an interval that syllables and words overlap, to the confusion of the speech and the annoyance of the audience.

Some curious examples of echo are given in Herschel's article on "Sound" in the *Encyclopaedia Metropolitana*, but it appears that he is in error in one case. He states that in the whispering gallery in St Paul's, London, "the faintest sound is faithfully conveyed from one side to the other of the dome but is not heard at any intermediate point." In some domes, for instance in a dome at the university of Birmingham, a sound from one end of a diameter is heard very much more loudly quite close to the other end of the diameter than elsewhere, but in St Paul's Lord Rayleigh found that "the abnormal loudness with which a whisper is heard is not confined to the position diametrically opposite to that occupied by the whisperer, and therefore, it would appear, does not depend materially upon the symmetry

of the dome. The whisper seems to creep round the gallery horizontally, not necessarily along the shorter arc, but rather along that arc towards which the whisperer faces. This is a consequence of the very unequal audibility of a whisper in front and behind the speaker, a phenomenon which may easily be observed in the open air" (*Sound*, ii. § 287).

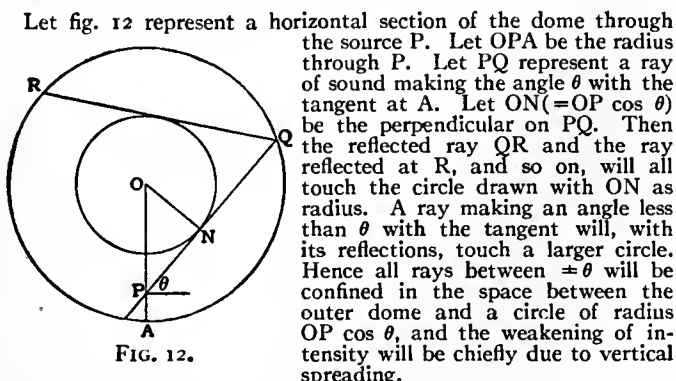

FIG. 12.

Rayleigh points out that this clinging of the sound to the surface of a concave wall does not depend on the exactness of the spherical form. He suggests that the propagation of earthquake disturbances is probably affected by the curvature of the surface of the globe, which may act like a whispering gallery.

In some cases of echo, when the original sound is a compound musical note, the octave of the fundamental tone is reflected much more strongly than that tone itself. This is explained by Rayleigh (*Sound*, ii. § 296) as a consequence of the irregularities of the reflecting surface. The irregularities send back a scattered reflection of the different incident trains, and this scattered reflection becomes more copious the shorter the wavelength. Hence the octave, though comparatively feeble in the incident train, may predominate in the scattered reflection constituting the echo.

Refraction of Sound.

When a wave of sound travelling through one medium meets a second medium of a different kind, the vibrations of its own particles are communicated to the particles of the new medium, so that a wave is excited in the latter, and is propagated through it with a velocity dependent on the density and elasticity of the second medium, and therefore differing in general from the previous velocity. The direction, too, in which the new wave travels is different from the previous one. This change of direction is termed *refraction*, and takes place, no doubt, according to the same laws as does the refraction of light, viz. (1) The new direction or *refracted ray* lies always in the *plane of incidence*, or plane which contains the incident ray (*i.e.* the direction of the wave in the first medium), and the normal to the surface separating the two media, at the point in which the incident ray meets it; (2) The *sine* of the angle between the normal and the incident ray bears to the *sine* of the angle between the normal and the refracted ray a ratio which is constant for the same pair of media. As with light the ratio involved in the second law is always equal to the ratio of the velocity of the wave in the first medium to the velocity in the second; in other words, the *sines* of the angles in question are *directly* proportional to the velocities.

Hence sound rays, in passing from one medium into another, are bent in towards the normal, or the reverse, according as the velocity of propagation in the former exceeds or falls short of that in the latter. Thus, for instance, sound is refracted *towards* the perpendicular when passing into air from water, or into carbonic acid gas from air; the converse is the case when the passage takes place the opposite way.

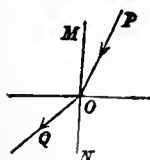

FIG. 13.

It further follows, as in the analogous case of light, that there is a certain angle termed the *critical angle*, whose sine is found by dividing the less by

the greater velocity, such that all rays of sound meeting the surface separating two different bodies will not pass onward, but suffer total reflection back into the first body, if the velocity in that body is less than that in the other body, and if the angle of incidence exceeds the limiting angle.

The velocities in air and water being respectively 1090 and 4700 ft. the limiting angle for these media may be easily shown to be slightly above $15\frac{1}{2}^\circ$. Hence, rays of sound proceeding from a distant source, and therefore nearly parallel to each other, and to PO (fig. 13), the angle POM being greater than $15\frac{1}{2}^\circ$, will not pass into the water at all, but suffer total reflection. Under such circumstances, the report of a gun, however powerful, should be inaudible by an ear placed in the water.

Acoustic Lenses.—As light is concentrated into a focus by a convex glass lens (for which the velocity of light is less than for the air), so sound ought to be made to converge by passing through a convex lens formed of carbonic acid gas. On the other hand, to produce convergence with water or hydrogen gas, in both which the velocity of sound exceeds its rate in air, the lens ought to be concave. These results have been confirmed experimentally by K. F. J. Sondhauss (*Pogg. Ann.*, 1852, 85. p. 378), who used a collodion lens filled with carbonic acid. He found its focal length and hence the refractive index of the gas, C. Hajech (*Ann. chim. phys.*, 1858, (iii). vol. 54) also measured the refractive indices of various gases, using a prism containing the gas to be experimented on, and he found that the deviation by the prism agreed very closely with the theoretical values of sound in the gas and in air.

Osborne Reynolds (*Proc. Roy. Soc.*, 1874, 22, p. 531) first pointed out that refraction would result from a variation in the temperature of the air at different heights. The velocity of sound in air is independent of the pressure, ^{Temperature} *Refraction.* but varies with the temperature, its value at t° C. being as we have seen

$$U = U_0(1 + \frac{1}{2}at)$$

where U_0 is the velocity at 0° C., and a is the coefficient of expansion $\cdot 00365$. Now if the temperature is higher overhead than at the surface, the velocity overhead is greater. If a wave front is in a given position, as a 1 (fig. 14), at a given instant

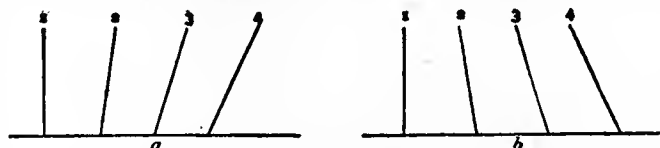

FIG. 14.

the upper part, moving faster, gains on the lower, and the front tends to swing round as shown by the successive positions in a 2, 3 and 4; that is, the sound tends to come down to the surface. This is well illustrated by the remarkable horizontal carriage of sound on a still clear frosty morning, when the surface layers of air are decidedly colder than those above. At sunset, too, after a warm day, if the air is still, the cooling of the earth by radiation cools the lower layers, and sound carries excellently over a level surface. But usually the lower layers are warmer than the upper layers, and the velocity below is greater than the velocity above. Consequently a wave front such as b 1 tends to turn upwards, as shown in the successive positions b 2, 3 and 4. Sound is then not so well heard along the level, but may still reach an elevated observer. On a hot summer's day the temperature of the surface layers may be much higher than that of the higher layers, and the effect on the horizontal carriage of sound may be very marked.

It is well known that sound travels far better with the wind than against it. Stokes showed that this effect is one of refraction, due to variation of velocity of the air from the surface upwards (*Brit. Assoc. Rep.*, 1857, p. ^{Refraction} *by Wind.* 22). It is, of course, a matter of common observation that the wind increases in velocity from the surface upwards. An excellent illustration of this increase was pointed out by F. Osler in the shape of old clouds; their upper portions always appear dragged forward and they lean over, as it were, in the

direction in which the wind is going. The same kind of thing happens with sound-wave fronts when travelling with the wind.

The velocity of any part of a wave front relative to the ground will be the normal velocity of sound + the velocity of the wind at that point. Since the velocity increases as we go upwards the front tends to swing round and travel downwards, as shown in the successive positions *a* 1, 2, 3 and 4, in fig. 14, where we must suppose the wind to be blowing from left to right. But if the wind is against the sound the velocity of a point of the wave front is the normal velocity—the wind velocity at the point, and so decreases as we rise. Then the front tends to swing round and travel upwards as shown in the successive positions *b* 1, 2, 3, and 4, in fig. 14, where the wind is travelling from right to left. In the first case the waves are more likely to reach and be perceived by an observer level with the source, while in the second case they may go over his head and not be heard at all.

Diffraction of Sound Waves.

Many of the well-known phenomena of optical diffraction may be imitated with sound waves, especially if the waves be short. Lord Rayleigh (*Scientific Papers*, iii. 24) has given various examples, and we refer the reader to his account. We shall only consider one interesting case of sound diffraction which may be easily observed. When we are walking past a fence formed by equally-spaced vertical rails or overlapping boards, we may often note that each footstep is followed by a musical ring. A sharp clap of the hands may also produce the effect. A short impulsive wave travels towards the fence, and each rail as it is reached by the wave becomes the centre of a new secondary wave sent out all round, or at any rate on the front side of the fence.

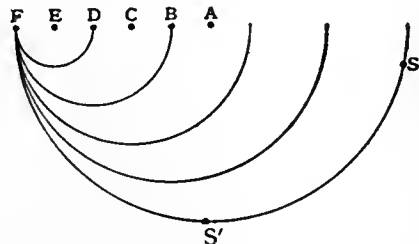

FIG. 15.

Let S (fig. 15) be the source very nearly in the line of the rails ABCDEF. At the instant that the original wave reaches F the wave from E has travelled to a circle of radius very nearly equal to EF—not quite, as S is not quite in the plane of the rails. The wave from D has travelled to a circle of radius nearly equal to DF, that from C to a circle of radius nearly CF, and so on. As these "secondary waves" return to S their distance apart is nearly equal to twice the distance between the rails, and the observer then hears a note of wave-length nearly 2EF. But if an observer is stationed at S' the waves will be about half as far apart and will reach him with nearly twice the frequency, so that he hears a note about an octave higher. As he travels further round the frequency increases still more. The railings in fact do for sound what a diffraction grating does for light.

Frequency and Pitch.

Sounds may be divided into noises and musical notes. A mere noise is an irregular disturbance. If we study the source producing it we find that there is no regularity of vibration. A musical note always arises from a source which has some regularity of vibration, and which sends equally-spaced waves into the air. A given note has always the same frequency, that is to say, the hearer receives the same number of waves per second whatever the source by which the note is produced. Various instruments have been devised which produce any desired note, and which are provided with methods of counting the frequency of vibration. The results obtained fully confirm the general law that "pitch," or the position of the note in the musical scale, depends solely on its frequency. We shall now describe some of the methods of determining frequency.

Savart's toothed wheel apparatus, named after Félix Savart (1791-1841), a French physicist and surgeon, consists of a brass wheel, whose edge is divided into a number of equal projecting

teeth distributed uniformly over the circumference, and which is capable of rapid rotation about an axis perpendicular to its plane and passing through its centre, by means of a series of multiplying wheels, the last of which is turned round by the hand. The toothed wheel being set in motion, the edge of a card or of a funnel-shaped piece of common notepaper is held against the teeth, when a note will be heard arising from the rapidly succeeding displacements of the air in its vicinity. The pitch of this note will rise as the rate of rotation increases, and becomes steady when that rotation is maintained uniform. It may thus be brought into unison with any sound of which it may be required to determine the corresponding number of vibrations per second, as for instance the note A₃, three octaves higher than the A which is indicated musically by a small circle placed between the second and third lines of the G clef, which A is the note of the tuning-fork usually employed for regulating concert-pitch. A₃ may be given by a piano. Now, suppose that the note produced with Savart's apparatus is in unison with A₃, when the experimenter turns round the first wheel at the rate of 60 turns per minute or one per second, and that the circumferences of the various multiplying wheels are such that the rate of revolution of the toothed wheel is thereby increased 44 times, then the latter wheel will perform 44 revolutions in a second, and hence, if the number of its teeth be 80, the number of taps imparted to the card every second will amount to 44×80 or 3520. This, therefore, is the number of vibrations corresponding to the note A₃. If we divide this by 2³ or 8, we obtain 440 as the number of vibrations answering to the note A. If, for the single toothed wheel, be substituted a set of four with a common axis, in which the teeth are in the ratios 4:5:6:8, and if the card be rapidly passed along their edges, we shall hear distinctly produced the fundamental chord C, E, G, C₁ and shall thus satisfy ourselves that the intervals C, E; C, G and C, C₁ are $\frac{1}{3}$, $\frac{1}{2}$ and 2 respectively.

Neither this instrument nor the next to be described is now used for exact work; they merely serve as illustrations of the law of pitch.

The *siren* of L. F. W. A. Seebeck (1805-1849) is the simplest form of apparatus thus designated, and consists of a large circular disk mounted on a central axis, about which it may be made to revolve with moderate rapidity. This disk is perforated with small round holes arranged in circles about the centre of the disk. In the first series of circles, reckoning from the centre the openings are so made as to divide the respective circumferences, on which they are found, in aliquot parts bearing to each other the ratios of the numbers 2, 4, 5, 6, 8, 10, 12, 16, 20, 24, 32, 40, 48, 64. The second series consists of circles each of which is formed of two sets of perforations, in the first circle arranged as 4:5, in the next as 3:4, then as 2:3, 3:5, 4:7. In the outer series is a circle divided by perforations into four sets, the numbers of aliquot parts being as 3:4:5:6, followed by others which we need not further refer to.

The disk being started, then by means of a tube held at one end between the lips, and applied near to the disk at the other, or more easily with a common bellows, a blast of air is made to fall on the part of the disk which contains any one of the above circles. The current being alternately transmitted and shut off, as a hole passes on and off the aperture of the tube or bellows, causes a vibratory motion of the air, whose frequency depends on the number of times per second that a perforation passes the mouth of the tube. Hence the note produced with any given circle of holes rises in pitch as the disk revolves more rapidly; and if, the revolution of the disk being kept as steady as possible, the tube be passed rapidly across the circles of the first series, a series of notes is heard, which, if the lowest be denoted by C, form the sequence C, C₁, E₁, G₁, C₂, &c. In like manner, the first circle in which we have two sets of holes dividing the circumference, the one into say 8 parts, and the other into 10, or in ratio 4:5, the note produced is a compound one, such as would be obtained by striking on the piano two notes separated by the interval of a major third ($\frac{1}{3}$). Similar results are obtainable by means of the remaining perforations.

A still simpler form of siren may be constituted with a good spinning-top, a perforated card disk, and a tube for blowing with.

The siren of C. Cagniard de la Tour is founded on the same principle as the preceding. It consists of a cylindrical chest of brass, the base of which is pierced at its centre with an opening in which is fixed a brass tube projecting outwards, and intended for supplying the cavity of the cylinder with compressed air or other gas, or even liquid. The top of the cylinder is formed of a plate perforated near its edge by holes distributed uniformly in a circle concentric with the plate, and which are cut obliquely through the thickness of the plate. Immediately above this fixed plate, and almost in contact with it, is another of the same dimensions, and furnished with the same number, *n*, of openings similarly placed, but passing obliquely through in an opposite direction from those in the fixed plate, the one set being inclined to the left, the other to the right.

This second plate is capable of rotation about an axis perpendicular to its plane and passing through its centre. Now, let the movable plate be at any time in a position such that its holes are immediately above those in the fixed plate, and let the bellows by which air is forced into the cylinder (air, for simplicity, being

Seebeck's Siren.

Siren of Cagniard de la Tour.

supposed to be the fluid employed) be put in action; then the air in its passage will strike the side of each opening in the movable plate in an oblique direction (as shown in fig. 16), and will therefore urge the latter to rotation round its centre. After $1/n$ th of a revolution, the two sets of perforations will again coincide, the lateral impulse of the air repeated, and hence the rapidity of rotation increased. This will go on



FIG. 16.

continually as long as air is supplied to the cylinder, and the velocity of rotation of the upper plate will be accelerated up to a certain maximum, at which it may be maintained by keeping the force of the current constant.

Now, it is evident that each coincidence of the perforations in the two plates is followed by a non-coincidence, during which the air-current is shut off, and that consequently, during each revolution of the upper plate, there occur n alternate passages and interceptions of the current. Hence arises the same number of successive impulses of the external air immediately in contact with the movable plate, which is thus thrown into a state of vibration at the rate of n for every revolution of the plate. The result is a note whose pitch rises as the velocity of rotation increases, and becomes steady when that velocity reaches its constant value. If, then, we can determine the number m of revolutions performed by the plate in every second, we shall at once have the number of vibrations per second corresponding to the audible note by multiplying m by n .

For this purpose the axis is furnished at its upper part with a screw working into a toothed wheel, and driving it round, during each revolution of the plate, through a space equal to the interval between two teeth. An index resembling the hand of a watch partakes of this motion, and points successively to the divisions of a graduated dial. On the completion of each revolution of this toothed wheel (which, if the number of its teeth be 100, will comprise 100 revolutions of the movable plate), a projecting pin fixed to it catches a tooth of another toothed wheel and turns it round, and with it a corresponding index which thus records the number of turns of the first toothed wheel. As an example of the application of this siren, suppose that the number of revolutions of the plate, as shown by the indices, amounts to 5400 in a minute, that is, to 90 per second, then the number of vibrations per second of the note heard amounts to $90n$, or (if number of holes in each plate = 8) to 720.

H. N. Dove (1803-1879) produced a modification of the siren by which the relations of different musical notes may be more readily ascertained. In it the fixed and movable plates are each furnished with four concentric series of perforations, dividing the circumferences into different aliquot parts, as, for example, 8, 10, 12, 16. Beneath the lower or fixed plate are four metallic rings furnished with holes corresponding to those in the plates, and which may be pushed round by projecting pins, so as to admit the air-current through any one or more of the series of perforations in the fixed plate. Thus may be obtained, either separately or in various combinations, the four notes whose vibrations are in the ratios of the above numbers, and which therefore form the fundamental chord (CEGC₁). The inventor has given to this instrument the name of the *many-voiced siren*.

Helmholtz (*Sensations of Tone*, ch. viii.) further adapted the siren for more extensive use, by the addition to Dove's instrument

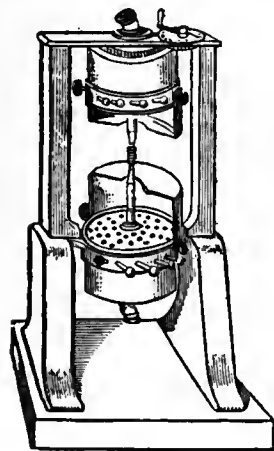

FIG. 17.

of another chest containing its own fixed and movable perforated plates and perforated rings, both the movable plates being driven by the same current and revolving about a common axis. Annexed is a figure of this instrument (fig. 17).

Graphic Methods.—The relation between the pitch of a note and the frequency of the corresponding vibrations has also been studied by graphic methods. Thus, if an elastic metal slip or a pig's bristle be attached to one prong of a tuning-fork, and if the fork, while in vibration, is moved rapidly over a glass plate coated with lamp-black, the attached style touching the plate lightly, a wavy line will be traced on the plate answering to the vibrations to and fro of the fork. The same result will be obtained with a stationary fork and a

movable glass plate; and, if the time occupied by the plate in moving through a given distance can be ascertained and the number of complete undulations exhibited on the plate for that distance, which is evidently the number of vibrations of the fork in that time, is reckoned, we shall have determined the numerical vibration-

value of the note yielded by the fork. Or, if the same plate be moved in contact with two tuning-forks, we shall, by comparing the number of sinuosities in the one trace with that in the other, be enabled to assign the ratio of the corresponding numbers of vibrations per second. Thus, if the one note be an octave higher than the other, it will give double the number of waves in the same distance. The motion of the plate may be simply produced by dropping it between two vertical grooves, the tuning-forks being properly fixed to a frame above.

Greater accuracy may be attained with a revolving-drum chronograph first devised by Thomas Young (*Lect. on Nat. Phil.*, 1807, i. 190), consisting of a cylinder which may be coated with lamp-black, or, better still, a metallic cylinder round which a blackened sheet of paper is wrapped. The cylinder is mounted on an axis and turned round, while the style attached to the vibrating body is in light contact with it, and traces therefore a wavy circle, which, on taking off the paper and flattening it, becomes a wavy straight line. The superiority of this arrangement arises from the comparative facility with which the number of revolutions of the cylinder in a given time may be ascertained. In R. Koenig's arrangement (*Quelques expériences d'acoustique*, p. 1) the axis of the cylinder is fashioned as a screw, which works in fixed nuts at the ends, causing a sliding as well as a rotatory motion of the cylinder. The lines traced out by the vibrating pointer are thus prevented from overlapping when more than one turn is given to the cylinder. In the phonograph of E. L. Scott (*Comptes rendus*, 1861, 53, p. 108) any sound whatever may be made to record its trace on the paper by means of a large parabolic cavity resembling a speaking-trumpet, which is freely open at the wider extremity, but is closed at the other end by a thin stretched membrane. To the centre of this membrane is attached a small feather-fibre, which, when the reflector is suitably placed, touches lightly the surface of the revolving cylinder. Any sound (such as that of the human voice) transmitting its rays into the reflector, and communicating vibratory motion to the membrane, will cause the feather to trace a sinuous line on the paper. If, at the same time, a tuning-fork of known number of vibrations per second be made to trace its own line close to the other, a comparison of the two lines gives the number corresponding to the sound under consideration. The phonograph (*q.v.*) may be regarded as an instrument of this class, in that it records vibrations on a revolving drum or disk.

Lissajous Figures.—A mode of exhibiting the ratio of the frequencies of two forks was devised by Jules Antoine Lissajous (1822-1880). On one prong of each fork is fixed a small plane mirror. The two forks are fixed so that one vibrates in a vertical, and the other in a horizontal, plane, and they are so placed that a converging beam of light received on one mirror is reflected to the other and then brought to a point on a screen. If the first fork alone vibrates, the point on the screen appears lengthened out into a vertical line through the changes in inclination of the first mirror, while if the second fork alone vibrates, the point appears lengthened out into a horizontal line. If both vibrate, the point describes a curve which appears continuous through the persistence of the retinal impression. Lissajous also obtained the figures by aid of the vibration microscope, an instrument which he invented. Instead of a mirror, the objective of a microscope is attached to one prong of the first fork and the eyepiece of the microscope is fixed behind the fork. Instead of a mirror the second fork carries a bright point on one prong, and the microscope is focused on this. If both forks vibrate, an observer looking through the microscope sees the bright point describing Lissajous figures. If the two forks have the same frequency, it is easily seen that the figure will be an ellipse (including as limiting cases, depending on relative amplitude and phase, a circle and a straight line). If the forks are not of exactly the same frequency the ellipse will slowly revolve, and from its rate of revolution the ratio of the frequencies may be determined (Rayleigh, *Sound*, i. § 33). If one is the octave of the other a figure of 8 may be described, and so on. Fig. 18 shows curves given by intervals of the octave, the twelfth and the fifth.

The kaleidophone devised by Charles Wheatstone in 1827 gives these figures in a simple way. It consists of a straight rod clamped in a vice and carrying a bead at its upper free end. The bead is illuminated and shows a bright point of light. If the rod is circular in section and perfectly uniform the end will describe a circle, ellipse or straight line; but, as the elasticity is usually not exactly the same in all directions, the figure usually changes and revolves. Various modifications of the kaleidophone have been made (Rayleigh, *Sound*, § 38).

Koenig devised a clock in which a fork of frequency 64 takes the place of the pendulum (*Wied. Ann.*, 1880, ix. 394). The motion of the fork is maintained by the clock acting through an escapement, and the dial registers both the number of vibrations of the fork and the seconds, minutes and hours. By comparison with a clock of known rate the total number of vibrations of the fork in any time may be accurately determined. One prong of the fork carries a microscope objective, part of a vibration microscope, of which the eyepiece is fixed at the back of the clock and the Lissajous figure

made by the clock fork and any other fork may be observed. With this apparatus Koenig studied the effect of temperature on a standard fork of 256 frequency, and found that the frequency decreased by 0.0286 of a vibration for a rise of 1°, the frequency being exactly 256 at 26.2° C. Hence the frequency may be put as $256 \{1 - 0.000113 (t - 26.2)\}$.

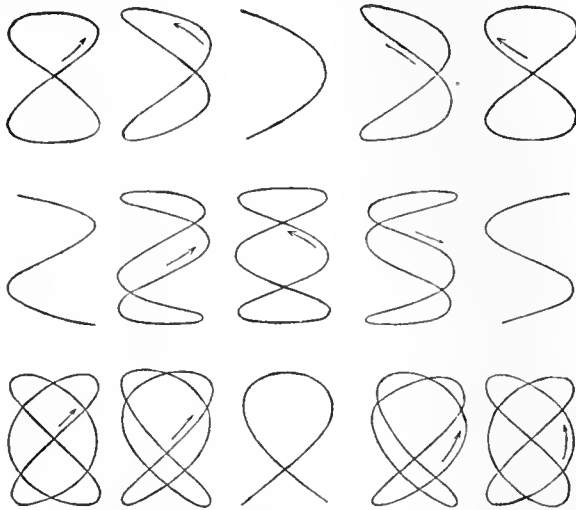

(From Lord Rayleigh's *Theory of Sound*, by permission of Macmillan & Co., Ltd.)
FIG. 18.

Koenig also used the apparatus to investigate the effect on the frequency of a fork of a resonating cavity placed near it. He found that when the pitch of the cavity was below that of the fork the pitch of the fork was raised, and vice versa. But when the pitch of the cavity was exactly that of the fork when vibrating alone, though it resounded most strongly, it did not affect the frequency of the fork. These effects have been explained by Lord Rayleigh (*Sound*, i. § 117).

In the stroboscopic method of H. M'Leod and G. S. Clarke, the full details of which will be found in the original memoir (*Phil. Trans.*, 1880, pt. i. p. 1), a cylinder is ruled with equidistant white lines parallel to the axis on a black ground. It is set so that it can be turned at any desired and determined speed about a horizontal axis, and when going fast enough it appears grey. Imagine now that a fork with black prongs is held near the cylinder with its prongs vertical and the plane of vibration parallel to the axis, and suppose that we watch the outer outline of the right-hand prong. Let the cylinder be rotated so that each white line moves exactly into the place of the next while the prong moves once in and out. Hence when a white line is in a particular position on the cylinder, the prong will always be the same distance along it and cut off the same length from view. The most will be cut off in the position of the lines corresponding to the furthest swing out, then less and less till the furthest swing in, then more and more till the furthest swing out, when the appearance will be exactly as at first. The boundary between the grey cylinder and the black fork will therefore appear wavy with fixed undulations, the distance from crest to crest being the distance between the lines on the cylinder. If the fork has slightly greater frequency, then a white line will not quite reach the next place while the fork is making its swing in and out, and the waves will travel against the motion of the cylinder. If the fork has slightly less frequency the waves will travel in the opposite direction, and it is easily seen that the frequency of the fork is the number of white lines passing a point in a second = the number of waves passing the point per second. This apparatus was used to find the temperature coefficient of the frequency of forks, the value obtained—0.00011 being the same as that found by Koenig. Another important result of the investigation was that the phase of vibration of the fork was not altered by bowing it, the amplitude alone changing. The method is easily adapted for the converse determination of speed of revolution when the frequency of a fork is known.

The phonic wheel, invented independently by Paul La Cour and Lord Rayleigh (see *Sound*, i. § 68 c), consists of a wheel carrying several soft-iron armatures fixed at equal distances round its circumference. The wheel rotates between the poles of an electro-magnet, which is fed by an intermittent current such as that which is working an electrically maintained tuning-fork (see *infra*). If the wheel be driven at such rate that the armatures move one place on in about the period of the current, then on putting on the current the electro-magnet controls the rate of the wheel so that the agreement of period is exact, and the wheel settles down to move so that the electric driving forces just supply the work taken out of the wheel.

Rayleigh's Phonic Wheel.

If the wheel has very little work to do it may not be necessary to apply driving power, and uniform rotation may be maintained by the electro-magnet. In an experiment described by Rayleigh such a wheel provided with four armatures was used to determine the exact frequency of a driving fork known to have a frequency near 32. Thus the wheel made about 8 revolutions per second. There was one opening in its disk, and through this was viewed the pendulum of a clock beating seconds. On the pendulum was fixed an illuminated silver bead which appeared as a bright point of light when seen for an instant. Suppose now an observer to be looking from a fixed point at the bead through the hole in the phonic wheel, he will see the bead as 8 bright points flashing out in each beat, and in succession at intervals of $\frac{1}{8}$ second. Let us suppose that he notes the positions of two of these next to each other in the beat of the pendulum one way. If the fork makes exactly 32 vibrations and the wheel 8 revolutions in one pendulum beat, then the positions will be fixed, and every two seconds, the time of a complete pendulum vibration, he will see the two positions looked at flash out in succession at an interval of $\frac{1}{8}$ second. But if the fork has, say, rather greater frequency, the hole in the wheel comes round at the end of the two seconds before the bead has quite come into position, and the two flashes appear gradually to move back in the opposite way to the pendulum. Suppose that in N beats of the clock the flashes have moved exactly one place back. Then the first flash in the new position is viewed by the 8Nth passage of the opening, and the second flash in the original position of the first is viewed when the pendulum has made exactly N beats and by the $(8N + 1)$ th passage of the hole. Then the wheel makes $8N + 1$ revolutions in N clock beats, and the fork makes $32N + 4$ vibrations in the same time. If the clock is going exactly right, this gives a frequency for the fork of $32 + 4/N$. If the fork has rather less frequency than 32 then the flashes appear to move forward and the frequency will be $32 - 4/N$. In Rayleigh's experiment the 32 fork was made to drive electrically one of frequency about 128, and somewhat as with the phonic wheel, the frequency was controlled so as to be exactly four times that of the 32 fork. A standard 128 fork could then be compared either optically or by beats with the electrically driven fork.

Scheibler's Tonometer.—When two tones are sounded together with frequencies not very different, "beats" or swellings-out of the sound are heard of frequency equal to the difference of frequencies of the two tones (see below). Johann Heinrich Scheibler (1777-1838) tuned two forks to an exact octave, and then prepared a number of others dividing the octave into such small steps that the beats between each and the next could be counted easily. Let the forks be numbered 0, 1, 2, . . . N. If the frequency of 0 is n, that of N is 2n. Suppose that No. 1 makes m_1 beats with No. 0, that No. 2 makes m_2 beats with No. 1, and so on, then the frequencies are

$$n, n + m_1, n + m_1 + m_2, \dots, n + m_1 + m_2 + \dots + m_N.$$

Since $n + m_1 + m_2 + \dots + m_N = 2n, n = m_1 + m_2 + \dots + m_N$, and it follows that when n is known, the frequency of every fork in the range may be determined.

Any other fork within this octave can then have its frequency determined by finding the two between which it lies. Suppose, for instance, it makes 3 beats with No. 10, it might have frequency either 3 above or below that of No. 10. But if it lies above No. 10 it will beat less often with No. 11 than with No. 9; if below No. 10 less often with No. 9 than with No. 11. Suppose it lies between No. 10 and No. 11 its frequency is that of No. 10 + 3.

Manometric Flames.—This is a device due to Koenig (*Phil. Mag.*, 1873, 45) and represented diagrammatically in fig. 19. f is a flame

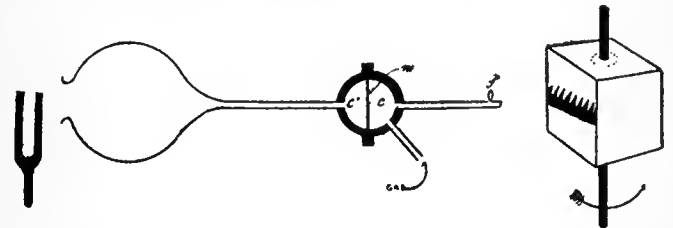

FIG. 19.

from a pinhole burner, fed through a cavity C, one side of which is closed by a membrane m; on the other side of the membrane is another cavity C', which is put into connexion with a source of sound, as, for instance, a Helmholtz resonator excited by a fork of the same frequency. The membrane vibrates, and alternately checks and increases the gas supply, and the flame jumps up and down with the frequency of the source. It then appears elongated. To show its intermittent character its reflection is viewed in a revolving mirror. For this purpose four vertical mirrors are arranged round the vertical sides of a cube which is rapidly revolved about a vertical axis. The flame then appears toothed as shown. If several notes are present the flame is jagged by each. Interesting results are obtained by singing the different vowels into a funnel substituted for the resonator in the figure.

If two such flames are placed one under the other they may be excited by different sources, and the ratio of the frequencies may be approximately determined by counting the number of teeth in each in the same space.

The Diatonic Scale.

It is not necessary here to deal generally with the various musical scales. We shall treat only of the diatonic scale, which is the basis of European music, and is approximated to as closely as is consistent with convenience of construction in key-board instruments, such as the piano, where the eight white notes beginning with C and ending with C an octave higher may be taken as representing the scale with C as the key-note.

All experiments in frequency show that two notes, forming a definite musical interval, have their frequencies always in the same ratio wherever in the musical scale the two notes are situated. In the scale of C the intervals from the key-note, the frequency ratios with the key-note, the successive frequency ratios and the successive intervals are as follows:—

Note	C	D	E	F	G	A	B	C
Interval with C		second	major third	fourth	fifth	major sixth	seventh	octave
Frequency	1	$\frac{9}{8}$	$\frac{5}{4}$	$\frac{4}{3}$	$\frac{3}{2}$	$\frac{5}{3}$	$\frac{15}{8}$	2
Successive frequency ratios		$\frac{9}{8}$	$\frac{10}{9}$	$\frac{12}{11}$	$\frac{8}{7}$	$\frac{10}{9}$	$\frac{8}{7}$	$\frac{16}{15}$
Successive intervals		major tone	minor tone	major semi-tone	major tone	minor tone	major tone	major semi-tone

If we pass through two intervals in succession, as, for instance, if we ascend through a fourth from C to F and then through a third from F to A, the frequency ratio of A to C is $\frac{4}{3}$, which is the product of the ratios for a fourth $\frac{4}{3}$, and a third $\frac{3}{2}$. That is, if we add intervals we must multiply frequency ratios to obtain the frequency ratio for the interval which is the sum of the two.

The frequency ratios in the diatonic scale are all expressible either as fractions, with 1, 2, 3 or 5 as numerator and denominator, or as products of such fractions; and it may be shown that for a given note the numerator and denominator are smaller than any other numbers which would give us a note in the immediate neighbourhood.

Thus the second $\frac{9}{8} = \frac{3}{2} \times \frac{3}{4}$, and we may regard it as an ascent through two fifths in succession and then a descent through an octave. The third $\frac{5}{4} = 5 \times \frac{1}{2} \times \frac{1}{2}$ or ascent through an interval $\frac{1}{2}$, which has no special name, and a descent through two octaves, and so on.

Now suppose we take G as the key-note and form its diatonic scale. If we write down the eight notes from G to g in the key of C, their frequency ratios to C, the frequency ratios required by the diatonic scale for G, we get the frequency ratios required in the last line:—

Notes on scale of C	G	A	B	c	d	e	f	g
Frequency ratios with C=1	$\frac{3}{2}$	$\frac{5}{4}$	$\frac{15}{8}$	2	$\frac{3}{2}$	$\frac{5}{4}$	$\frac{15}{8}$	3
Frequency ratios of diatonic scale with G=1	1	$\frac{4}{3}$	$\frac{5}{4}$	$\frac{4}{3}$	$\frac{3}{2}$	$\frac{5}{4}$	$\frac{4}{3}$	2
Frequency ratios with C=1, G= $\frac{3}{2}$	$\frac{3}{2}$	$\frac{5}{4}$	$\frac{15}{8}$	2	$\frac{3}{2}$	$\frac{5}{4}$	$\frac{15}{8}$	3

We see that all but two notes coincide with notes on the scale of C. But instead of A= $\frac{5}{4}$ we have $\frac{7}{4}$, and instead of f= $\frac{15}{8}$ we have $\frac{45}{8}$. The interval between $\frac{5}{4}$ and $\frac{7}{4} = \frac{2}{5} \div \frac{1}{5} = \frac{2}{5}$ is termed a "comma," and is so small that the same note on an instrument may serve for both. But the interval between $\frac{5}{4}$ and $\frac{45}{8} = \frac{45}{8} \div \frac{5}{4} = \frac{15}{2}$ is quite perceptible, and on the piano, for instance, a separate string must be provided above f. This note is f sharp, and the interval $\frac{15}{2}$ is termed a sharp.

Taking the successive key-notes D, A, E, B, it is found that besides small and negligible differences, each introduces a new sharp, and so we get the five sharps, C, D, F, G, A, represented nearly by the black keys.

If we start with F as key-note, besides a small difference at d, we have as the fourth from it $\frac{3}{4} \times \frac{4}{3} = \frac{1}{2}$, making with B = $\frac{1}{5}$ an interval $\frac{1}{2} \div \frac{1}{5} = \frac{5}{2}$, and requiring a new note, B flat. This does not coincide with A sharp which is the octave below the seventh from B or $\frac{1}{5} \times \frac{1}{5} \times \frac{1}{2} = \frac{2}{25}$. It makes with

it an interval = $\frac{1}{9} \div \frac{2}{25} = \frac{25}{18}$, rather less than a comma; so that the same string in the piano may serve for both. If we take the new note B flat as key-note, another note, E flat, is required. E flat as key-note introduces another flat, and so on, each flat not quite coinciding with a sharp but at a very small interval from it.

It is evident that for exact diatonic scales for even a limited number of key-notes, key-board instruments would have to be provided with a great number of separate strings or pipes, and the corresponding keys would be required. The construction would be complicated and the playing exceedingly difficult. The same string or pipe and the same key have therefore to serve for what should be slightly different notes. A compromise has to be made, and the note has to be tuned so as to make the compromise as little unsatisfactory as possible. At present twelve notes are used in the octave, and these are arranged at equal intervals $2^{1/12}$. This is termed the *equal temperament scale*, and it is obviously only an approach to the diatonic scale.

Helmholtz's Notation.—In works on sound it is usual to adopt Helmholtz's notation, in which the octave from bass to middle C is written *c d e f g a b c'*. The octave above is *c' d' e' f' g' a' b' c''*. The next octave above has two accents, and each succeeding octave another accent. The octave below bass C is written *C D E F G A B c*. The next octave below is *C₁ D₁ E₁ F₁ G₁ A₁ B₁ C*, and each preceding octave has another accent as suffix.

The standard frequency for laboratory work is *c*=128, so that middle *c'*=256 and treble *c''*=512.

The standard for musical instruments has varied (see PITCH, MUSICAL). Here it is sufficient to say that the French standard is *a'*=435 with *c'* practically 522, and that in England the pitch is somewhat higher.

The French notation is as under:—
C D E F G A B c
Ut₁ Re₁ Mi₁ Fa₁ Sol₁ La₁ Si₁ Ut₂.

The next higher octave has the suffix 2, the next higher the suffix 3, and so on. French forks are marked with double the true frequency, so that Ut₂ is marked 512.

Limiting Frequencies for Musical Sounds.—Until the vibrations of a source have a frequency in the neighbourhood of 30 per second the ear can hear the separate impulses, if strong enough, but does not hear a note. It is not easy to determine the exact point at which the impulses fuse into a continuous tone, for higher tones are usually present with the deepest of which the frequency is being counted, and these may be mistaken for it. Helmholtz (*Sensations of Tone*, ch. ix.) used a string loaded at the middle point so that the higher tones were several octaves above the fundamental, and so not likely to be mistaken for it; he found that with 37 vibrations per second a very weak sensation of tone was heard, but with 34 there was scarcely anything audible left. A determinate musical pitch is not perceived, he says, till about 40 vibrations per second. At the other end of the scale with increasing frequency there is another limiting frequency somewhere about 20,000 per second, beyond which no sound is heard. But this limit varies greatly with different individuals and with age for the same individual. Persons who when young could hear the squeaks of bats may be quite deaf to them when older. Koenig constructed a series of bars forming a harmonicon, the frequency of each bar being calculable, and he found the limit to be between 16,000 and 24,000.

The Number of Vibrations needed to give the Perception of Pitch.—Experiments have been made on this subject by various workers, the most extensive by W. Kohlrausch (*Wied. Ann.*, 1880, x. 1). He allowed a limited number of teeth on the arc of a circle to strike against a card. With sixteen teeth the pitch was well defined; with nine teeth it was fairly determinate; and even with two teeth it could be assigned with no great error. His remarkable result that two waves give some sense of pitch, in fact a tone with wavelength equal to the interval between the waves, has been confirmed by other observers.

Alteration of Pitch with Motion of Source or Hearer: Doppler's Principle.—A very noticeable illustration of the alteration of pitch by motion occurs when a whistling locomotive moves rapidly past an observer. As it passes, the pitch of the whistle falls quite appreciably. The explanation is simple. The engine follows up any wave that it has sent forward, and so crowds up the succeeding waves into a less distance than if it remained at rest. It draws off from any wave it has sent backward and so spreads the succeeding waves over a longer distance than if it had remained at rest. Hence the forward waves are shorter and the backward waves are longer. Since $U = n \lambda$ where U is the velocity of sound, λ the wave-length, and *n* the frequency, it follows that the forward frequency is greater than the backward frequency.

The more general case of motion of source, medium and receiver

may be treated very easily if the motions are all in the line joining source and receiver. Let S (fig. 20) be the source at a given instant, and let its frequency of vibration, or the number of waves it sends out per second, be n . Let S' be its position one second later, its velocity being u . Let R be the receiver at a given instant, R' its position a second later, its velocity being v . Let the velocity of the air from S to R be w , and let U be the velocity of sound in still air.

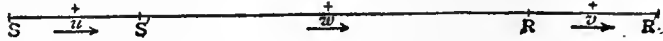

FIG. 20.

If all were still, the n waves emitted by S in one second would spread over a length U . But through the wind velocity the first wave is carried to a distance $U + w$ from S, while through the motion of the source the last wave is a distance u from S. Then the n waves occupy a space $U + w - u$. Now turning to the receiver, let us consider what length is occupied by the waves which pass him in one second. If he were at rest, it would be the waves in length $U + w$, for the wave passing him at the beginning of a second would be so far distant at the end of the second. But through his motion v in the second, he receives only the waves in distance $U + w - v$. Since there are n waves in distance $U + w - u$ the number he actually receives is $n(U + w - v)/(U + w - u)$. If the velocities of source and receiver are equal then the frequency is not affected by their motion or by the wind. But if their velocities are different, the frequency of the waves received is affected both by these velocities and by that of the wind.

The change in pitch through motion of the source may be illustrated by putting a pitch-pipe in one end of a few feet of rubber tubing and blowing through the other end while the tubing is whirled round the head. An observer in the plane of the motion can easily hear a change in the pitch as the pitch-pipe moves to and from him.

Musical Quality or Timbre.—Though a musical note has definite pitch or frequency, notes of the same pitch emitted by different instruments have quite different quality or timbre. The three characteristics of a longitudinal periodic disturbance are its amplitude, the length after which it repeats itself, and its form, which may be represented by the shape of the displacement curve. Now the amplitude evidently corresponds to the loudness, and the length of period corresponds to the pitch or frequency. Hence we must put down the quality or timbre as depending on the form.

The simplest form of wave, so far as our sensation goes—that is, the one giving rise to a pure tone—is, we have every reason to suppose, one in which the displacement is represented by a harmonic curve or a curve of sines, $y = a \sin m(x - e)$. If we put this in the form

$y = a \sin \frac{2\pi}{\lambda}(x - e)$, we see that $y = 0$, for $x = e, e + \frac{1}{2}\lambda, e + \frac{3}{2}\lambda, e + \frac{5}{2}\lambda$, and so on, that y is $+$ from $x = e$ to $x = e + \frac{1}{2}\lambda$, $-$ from $e + \frac{1}{2}\lambda$ to $e + \frac{3}{2}\lambda$, and so on, and that it alternates between the values $+a$ and $-a$.

The form of the curve is evidently as represented in fig. 21, and it may easily be drawn to exact scale from a table of sines.

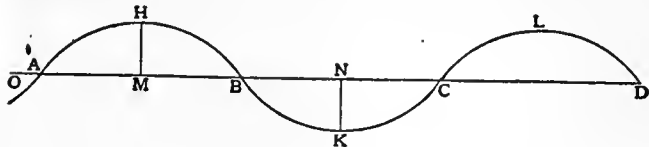

FIG. 21.

In this curve ABCD are nodes. $OA = e$ is termed the epoch, being the distance from O of the first ascending node. AC is the shortest distance after which the curve begins to repeat itself; this length λ is termed the wave-length. The maximum height of the curve $HM = a$ is the amplitude. If we transfer O to A, $e = 0$, and the curve may be represented by $y = a \sin \frac{2\pi}{\lambda}x$.

If now the curve moves along unchanged in form in the direction ABC with uniform velocity U , the epoch $e = OA$ at any time t will be Ut , so that the value of y may be represented as

$$y = a \sin \frac{2\pi}{\lambda}(x - Ut). \tag{16}$$

The velocity perpendicular to the axis of any point on the curve at a fixed distance x from O is

$$\frac{dy}{dt} = -\frac{2\pi Ua}{\lambda} \cos \frac{2\pi}{\lambda}(x - Ut). \tag{17}$$

The acceleration perpendicular to the axis is

$$\begin{aligned} \frac{d^2y}{dt^2} &= -\frac{4\pi^2 U^2 a}{\lambda^2} \sin \frac{2\pi}{\lambda}(x - Ut) \\ &= -\frac{4\pi^2 U^2}{\lambda^2} y \end{aligned} \tag{18}$$

which is an equation characteristic of simple harmonic motion.

The maximum velocity of a particle in the wave-train is the amplitude of dy/dt . It is, therefore,

$$u_m = 2\pi Ua/\lambda = 2\pi na. \tag{19}$$

The maximum pressure excess is the amplitude of $\hat{\omega} = Eu/U = (E/U)dy/dt$. It is therefore

$$\hat{\omega}_m = (E/U)2\pi Ua/\lambda = 2\pi n\rho Ua. \tag{20}$$

We have already found the energy density in the train and the energy stream in equations (13) and (14).

The chief experimental basis for supposing that a train of longitudinal waves with displacement curve of this kind arouses the sensation of a pure tone is that the more nearly a source is made to vibrate with a single simple harmonic motion, and therefore, presumably, the more nearly it sends out such a harmonic train, the more nearly does the note heard approximate to a single pure tone.

Any periodic curve may be resolved into sine or harmonic curves by Fourier's theorem.

Suppose that any periodic sound disturbance, consisting of plane waves, is being propagated in the direction ABCD (fig. 22). Let it be represented by a displacement curve AHBKC. Its periodicity implies that after a certain distance the displacement curve exactly repeats itself. Let AC be the

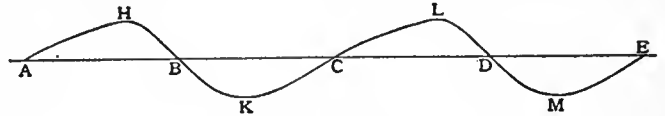

FIG. 22.

shortest distance after which the repetition occurs, so that CLDME is merely AHBKC moved on a distance AC. Then $AC = \lambda$ is the wave-length or period of the curve. Let ABCD be drawn at such level that the areas above and below it are equal; then ABCD is the axis of the curve. Since the curve represents a longitudinal disturbance in air it is always continuous, at a finite distance from the axis, and with only one ordinate for each abscissa.

Fourier's theorem asserts that such a curve may be built up by the superposition, or addition of ordinates, of a series of sine curves of wave-lengths $\lambda, \frac{1}{2}\lambda, \frac{1}{3}\lambda, \frac{1}{4}\lambda, \dots$ if the amplitudes a, b, c, \dots and the epochs e, f, g, \dots are suitably adjusted, and the proof of the theorem gives rules for finding these quantities when the original curve is known. We may therefore put

$$y = a \sin \frac{2\pi}{\lambda}(x - e) + b \sin \frac{4\pi}{\lambda}(x - f) + c \sin \frac{6\pi}{\lambda}(x - g) + \&c. \tag{21}$$

where the terms may be infinite in number, but always have wave-lengths submultiples of the original or fundamental wave-length λ . Only one such resolution of a given periodic curve is possible, and each of the constituents repeats itself not only after a distance equal to its own wave-length λ/n , but evidently also after a distance equal to the fundamental wave-length λ . The successive terms of (21) are called the *harmonics of the first term*.

It follows from this that any periodic disturbance in air can be resolved into a definite series of simple harmonic disturbances of wave-lengths equal to the original wave-length and its successive submultiples, and each of these would separately give the sensation of a pure tone. If the series were complete we should have terms which separately would correspond to the fundamental, its octave, its twelfth, its double octave, and so on. Now we can see that two notes of the same pitch, but of different quality, or different form of displacement curve, will, when thus analysed, break up into a series having the same harmonic wave-lengths; but they may differ as regards the members of the series present and their amplitudes and epochs. We may regard quality, then, as determined by the members of the harmonic series present and their amplitudes and epochs. It may, however, be stated here that certain experiments of Helmholtz appear to show that the epoch of the harmonics has not much effect on the quality.

Fourier's theorem can also be usefully applied to the disturbance of a source of sound under certain conditions. The nature of these conditions will be best realized by considering the case of a stretched string. It is shown below how the vibrations of a string may be deduced from stationary waves. Let us here suppose that the string AB is displaced into the form AHB (fig. 23) and is then let go.

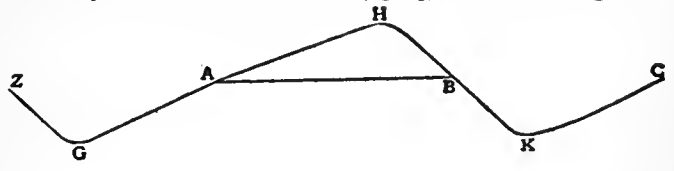

FIG. 23.

us imagine it to form half a wave-length of the extended train ZGAHBKC, on an indefinitely extended stretched string, the values of y at equal distances from A (or from B) being equal and opposite. Then, as we shall prove later, the vibrations of the string may be represented by the travelling of two trains in opposite directions each with velocity

$$\sqrt{\text{tension} \div \text{mass per unit length}}$$

each half the height of the train represented in fig. 23. For the superposition of these trains will give a stationary wave between A

and B. Now we may resolve these trains by Fourier's theorem into harmonics of wave-lengths $\lambda, \frac{1}{2}\lambda, \frac{1}{3}\lambda, \&c.$, where $\lambda=2AB$ and the conditions as to the values of y can be shown to require that the harmonics shall all have nodes, coinciding with the nodes of the fundamental curve. Since the velocity is the same for all disturbances they all travel at the same speed, and the two trains will always remain of the same form. If then we resolve AHBKC into harmonics by Fourier's theorem, we may follow the motion of the separate harmonics, and their superposition will give the form of the string at any instant. Further, the same harmonics with the same amplitude will always be present.

We see, then, that the conditions for the application of Fourier's theorem are equivalent to saying that all disturbances will travel along the system with the same velocity. In many vibrating systems this does not hold, and then Fourier's theorem is no longer an appropriate resolution. But where it is appropriate, the disturbance sent out into the air contains the same harmonic series as the source.

The question now arises whether the sensation produced by a periodic disturbance can be analysed in correspondence with this geometrical analysis. Using the term "note" for the sound produced by a periodic disturbance, there is no doubt that a well-trained ear can resolve a note into pure tones of frequencies equal to those of the fundamental and its harmonics. If, for instance, a note is struck and held down on a piano, a little practice enables us to hear both the octave and the twelfth with the

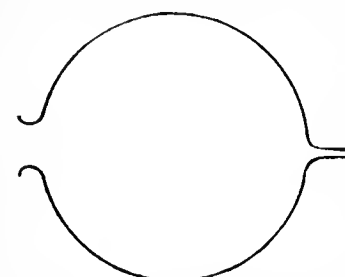

FIG. 24.—Helmholtz Resonator.

fundamental, especially if we have previously directed our attention to these tones by sounding them. But the harmonics are most readily heard if we fortify the ear by an air cavity with a natural period equal to that of the harmonic to be sought. The form used by Helmholtz is a glove of thin brass (fig. 24) with a large hole at one end of a diameter, at the other end of which the brass is drawn out into a short, narrow tube that can be put close to the ear. But a cardboard tube closed at one end, with the open end near the ear, will often suffice, and it may be tuned by more or less covering up the open end. If the harmonic corresponding to the resonator is present its tone swells out loudly.

This resonance is a particular example of the general principle that a vibrating system will be set in vibration by any periodic force applied to it, and ultimately in the period of the force, its own natural vibrations gradually dying down. Vibrations thus excited are termed *forced vibrations*, and their amplitude is greater the more nearly the period of the applied force approaches that of the system when vibrating freely. The mathematical investigation of forced vibrations (Rayleigh, *Sound*, i. § 46) shows that, if there were no dissipation of energy, the vibration would increase indefinitely when the periods coincided. But there is always leakage of energy either through friction or through wave-emission, so that the vibration only increases up to the point at which the leakage of energy balances the energy put in by the applied force. Further, the greater the dissipation of energy the less is the prominence of the amplitude of vibration for exact coincidence over the amplitude when the periods are not quite the same, though it is still the greatest for coincidence.

The principle of forced vibration may be illustrated by a simple case. Suppose that a mass M is controlled by some sort of spring, so that moving freely it executes harmonic vibrations given by $M\ddot{x} = -\mu x$, where μx is the restoring force to the centre of vibration. Putting $\mu/M = n^2$ the equation becomes $\ddot{x} + n^2 x = 0$, whence $x = A \sin nt$, and the period is $2\pi/n$.

Now suppose that in addition to the internal force represented by $-\mu x$, an external harmonic force of period $2\pi/p$ is applied. Representing it by $-P \sin pt$, the equation of motion is now

$$\ddot{x} + n^2 x + \frac{P}{M} \sin pt = 0. \tag{22}$$

Let us assume that the body makes vibrations in the new period $2\pi/p$, and let us put $x = B \sin pt$; substituting in (22) we have $-p^2 B + n^2 B + P/M = 0$, whence

$$B = \frac{P}{M} \cdot \frac{1}{p^2 - n^2},$$

and the "forced" oscillation due to $-P \sin pt$ is

$$x = \frac{P}{M} \cdot \frac{\sin pt}{p^2 - n^2}. \tag{23}$$

If $p > n$ the motion agrees in phase with that which the applied force alone would produce, obtained by putting $n=0$. If $p < n$ the phases are opposite. If $p = n$ the amplitude becomes infinite. This is the case of "resonance." The amplitude does not, of course, become infinite in practice. There is always loss of energy by dissi-

ipation in the vibrating machinery and by radiation into the medium, and the amplitude only increases until this loss is balanced by the gain from the work done by the applied force.

According to Helmholtz, the ear probably contains within it a series of resonators, with small intervals between the periods of the successive members, while the series extends over the whole range of audible pitch. We need not here enter into the question of the structure constituting these resonators. Each of them is supposed to have its own natural frequency, and to be set into vibration when the ear receives a train of waves of that frequency. The vibration in some way arouses the sensation of the corresponding tone. But the same resonator will be appreciably though less affected by waves of frequency differing slightly from its own. Thus Helmholtz from certain observations (*Sound*, ii. § 388) thought that if the intensity of response by a given resonator in the ear to its own tone is taken as 1, then its response to an equally loud tone a semitone different may be taken as about $\frac{1}{10}$. According to this theory, then, when a pure tone is received the auditory apparatus corresponding to that tone is most excited, but the apparatus on each side of it is also excited, though by a rapidly diminishing amount, as the interval increases. If the sensations corresponding to these neighbouring elements are thus aroused, we have no such perception as a pure tone, and what we regard as a pure tone is the mean of a group of sensations. The sensitiveness of the ear in judging of a given tone must then correspond to the accuracy with which it can judge of the mean.

The Ear as a Fourier Analyser.

Measurements of Intensity of Sound or Loudness.—Various devices have been successfully employed for making sounds of determinate loudness in order to test the hearing of partially deaf people. But the converse, the measurement of the loudness of a sound not produced at our will, is by no means so easy. If we compare the problem with that of measuring the illumination due to a source of light, we see at once how different it is. In sound sensation we have nothing corresponding to white light. A noise such as the roar due to traffic in a town may correspond physically in that it could probably be resolved into a nearly continuous series of wave-lengths, but psychically it is of no interest. We do not use such noise, but rather seek to avoid it. We certainly do not wish to measure its loudness, and even if we did it might be difficult to fix on any unit of noisiness. Probably we should be driven to a purely physical unit, the stream of energy proceeding in any direction, and if the noise were great enough we might measure it possibly by the pressure against a surface.

The intensity of the stream of energy passing per second through a square centimetre when a given pure tone is sounded is more definite and can be measured. There are two practical methods. In the one, the energy of vibration of the source is measured, and the rate at which that energy decreases is observed. The amount radiated out in the form of sound waves is deduced, and hence the energy of the stream at any distance is known. In the other, the waves produce a measurable effect on a vibrating system of the same frequency, and the amplitude in the waves can be deduced.

The first may be illustrated by Lord Rayleigh's experiments to determine the amplitude of vibration in waves only just audible (*Sound*, ii. § 384). He used two kinds of experiment, but it will be sufficient here to indicate the second. A fork of frequency 256 was used as the source. The energy of this fork with a given amplitude of vibration could be calculated from its dimensions and elasticity, and the amplitude was observed by measuring with a microscope the line into which the image of a starch grain on the prong was drawn by the vibration. The rate of loss of energy was calculated from the rate of dying down of the vibration. This rate of loss for each amplitude was determined (1) when the fork was vibrating alone, and (2) when a resonator was placed with its mouth under the free ends of the fork. The difference in loss in the two cases measured the energy given up to and sent out by the resonator as sound. The amplitude of the fork was observed when the sound just ceased to be audible at 27.4 metres away, and the rate of energy emission from the resonator was calculated to be 42.1 ergs / second. Assuming this energy to be propagated in hemispherical waves, it is easy to find the quantity per second going through 1 sq. cm. at the distance of the listener, and thence from the energy in a wave found above, to determine the amplitude. The result was an amplitude of 1.27×10^{-7} cm. Other forks gave results not very different.

Minimum Amplitude of Audible Sounds.

In a later series of experiments Lord Rayleigh (*Phil. Mag.*, 1907, 14, p. 596) found that the least energy stream required to excite sensation did not vary greatly between frequencies of 512 and 256.

but that the stream required increased rapidly as the frequency was reduced below 256.

The second method may be illustrated by the experiments of M. Wien (*Wied. Ann.*, 1889, xxxvi. 834). He used a spherical Helmholtz resonator responding to the tone to be measured. The orifice which is usually placed to the ear was enlarged and closed by a corrugated plate like that of an aneroid barometer, and the motion of this plate was indicated by means of a mirror which had one edge fixed, while the other was attached to a style fixed to the centre of the plate. When the plate vibrated the mirror was vibrated about the fixed edge, and the image of a reflected slit was broadened out into a band, the broadening giving the amplitude of vibration of the plate. From subsidiary experiments (for which the original memoir must be consulted) the pressure variations within the resonator could be calculated from the movements of the plate. The open orifice of the resonator was then exposed to the waves from a source of its own frequency. Helmholtz's theory of the resonator (Rayleigh, *Sound*, ii. § 311) gives the pressure variations in the incident waves in terms of those in the resonator, and so the pressure variation and the amplitude of vibration in the waves to be measured were determined.

For minimum audible sounds Wien found a somewhat smaller value of the amplitude than Rayleigh. It is remarkable that, as Lord Rayleigh says, "the streams of energy required to influence the eye and the ear are of the same order of magnitude." Wien also used the apparatus to find the decrease of intensity with increase of distance, and found that it was somewhat more rapid than the inverse square law would give.

In a later series of experiments (*Science Abst.* vi. 301) Wien used a telephone plate, of which the amplitude could be determined from the value of the exciting current, and he found that the smallest amplitude audible was 6.3×10^{-10} cm.

W. Zernov (*Ann. d. Physik*, 1906, 21, p. 131) compared the indications of Wien's resonator manometer with those of V. Altberg's sound pressure apparatus and found very satisfactory agreement.

Stationary Waves.—As a preliminary to the investigation of the modes of vibration of certain sources of sound we shall consider the formation of "stationary waves." These are not really waves in the ordinary sense, but the disturbance arising from the passage through the medium in opposite directions of two equal trains. The medium is divided up into sections between fixed points, and these sections vibrate. We can form stationary waves with ease by fixing one end of a rope—say 20 ft. long—and holding the other end in the hand. When the hand is moved to and fro *transversely* waves are sent along the rope and reflected at the fixed end. The direct and reflected systems are practically equal, and by suitably timing the vibrations of the hand for each case the rope may be made to vibrate as a whole, as two halves, as three-thirds and so on. When it vibrates in several sections, each section moves in the opposite way to its neighbours.

Let us suppose that two trains of sine waves of length λ and amplitude a are travelling in opposite directions with velocity U . We may represent the displacement due to one of the trains by

$$y_1 = a \sin \frac{2\pi}{\lambda}(x - Ut). \tag{24}$$

where x is measured as in equation (16) from an ascending node as A in fig. 21. If we measure t from an instant at which the two trains exactly coincide, then as U for the other train has the opposite sign, its displacement is represented by

$$y_2 = a \sin \frac{2\pi}{\lambda}(x + Ut). \tag{25}$$

The sum of the disturbance is obtained by adding (24) and (25)

$$y = y_1 + y_2 = 2a \cos \frac{2\pi}{\lambda}Ut \sin \frac{2\pi}{\lambda}x, \tag{26}$$

At any given instant t this is a sine curve of amplitude $2a \cos (2\pi/\lambda)Ut$, and of wave-length λ , and with nodes at $x=0, \frac{1}{2}\lambda, \lambda, \dots$, that is, there is no displacement at these nodes whatever the value of t , and between them the displacement is always a sine curve, but of amplitude varying between $+2a$ and $-2a$. The ordinate of the curve changes sign as we pass through a node, so that successive sections are moving always in opposite directions and have opposite displacements. Each section then vibrates, and its amplitude goes through all its values in time given by $2\pi UT/\lambda = 2\pi$, or $T = \lambda/U$, and the frequency is U/λ . We may represent such a train of "stationary waves" by fig. 25, where the curves give the



FIG. 25.

two extreme amplitudes. The points A, B, C, D are termed "nodes," and the points half-way between them "loops."

The general character of these results may be obtained by a graphic construction. Let fig. 26 (1) represent a wave-length of each train when they are coincident. It is sufficient to take a single wave-length. The dotted curve represents the superposition, which simply doubles each ordinate. Divide the wave-length into,

say, eight equal parts as marked. Then move one train marked (I) $\frac{1}{8}\lambda$ to the right, and the other train (II) $\frac{1}{8}\lambda$ to the left, introducing new parts of each train at one end, and sending out old parts at the other. Then we get fig. 26 (2), the dotted curve representing

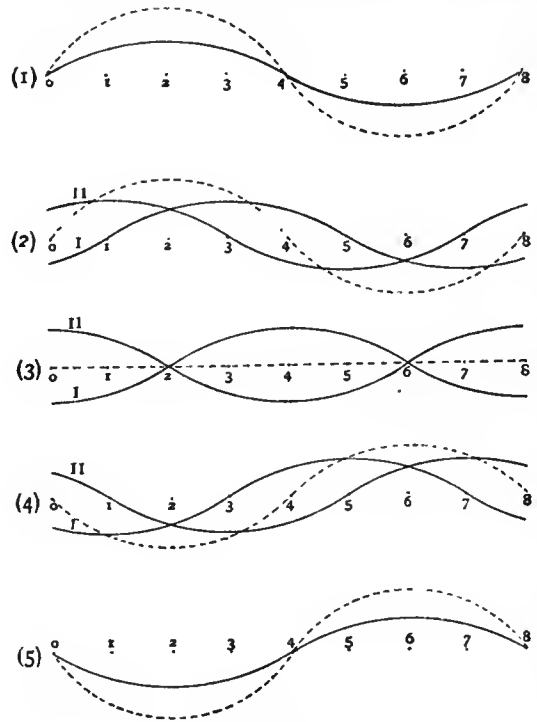

FIG. 26.

the resultant with amplitude $1/\sqrt{2}$ that of (1). Another movement of $\frac{1}{4}\lambda$ in each direction gives (3) with resultant a straight line, and so on for (4) and (5). In (5) the displacement is evidently equal and opposite to that in (1). Further displacement will give the figures (4), (3), (2), (1) again, but with (I) and (II) interchanged. When we get back to (1) each train has been displaced through λ and the period is λ/U . Further, the original nodes are always at rest, and the intervening sections vibrate to and fro.

The vibrations of certain sources of sound may be represented, at least as a first approximation, as consisting of stationary waves, and from a consideration of the rate of propagation of waves along these sources we can deduce their frequency when we know their length.

Sources of Sound.

Elementary Theory of Pipes.—The longitudinal vibration of air in cylindrical pipes is made use of in various wind instruments. We shall deduce the modes of vibration of the air column in a cylindrical pipe from the consideration that the air in motion within the pipe forms some part of a system of stationary waves, one train being formed by the exciter of the disturbance, and the other being formed by the reflection of the train at the end of the pipe.

In order to justify the use of stationary waves we must show that two such trains can move in opposite directions over the same ground without modifying each other so long as the displacement in either is small. For this it is necessary that the total force on an element due to the sum of the displacements should be equal to the sum of the forces due to the two displacements considered separately. The medium then acts for the second train just as if it were undisturbed by the first. It is sufficient then to show that the excess of pressure at any point is the sum of the excesses due to either train separately.

If ω is the total pressure excess, and if y is the total displacement at x , then $\omega = E \times \text{change of volume} \div \text{original volume} = -E dy/dx$. If y_1 and y_2 are the two separate displacements and if $y = y_1 + y_2$, then $\omega = -E (dy_1/dx + dy_2/dx) = \omega_1 + \omega_2$. This proves the proposition. It is a case of the principle of superposition of small disturbances.

Let us suppose that a system of stationary waves is formed in the air in a pipe of indefinite length, and let fig. 27 represent a part of the system. At the nodes A, B, C, D, E there is no displacement, but there are maximum volume and pressure changes. Consider, for instance, the point B. When the displacement is represented by AHBKC the particles on each side of B are displaced towards it

giving a compression, and since the slope is steepest there, or $-dy/dx$ a maximum, the compression is also a maximum there. When the displacement is represented by AH'BK'C the particles on each side of B are displaced from it, giving an extension, and since the slope is again the steepest, the extension is a maximum.

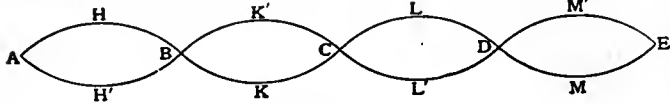

FIG. 27.

At the loops, for instance at H, the displacement is a maximum. The tangent to the displacement curve is always parallel to the axis, that is, for a small distance the successive particles are always equally displaced, and therefore always occupy the same volume. This means that at the loops while the motion is greatest there are no pressure changes.

We have now to select such portion of this system as will suit the conditions imposed by any actual pipe. There are three distinct types, which we will consider in succession.

1. *Pipe Closed at One End, Open at the Other.*—At the closed end there is no motion, for the pressure always constrains the air to remain in contact with the end. The closed end is therefore a node. At the open end, as a first approximation to be corrected later, there are no pressure changes, for any tendency to excess can be relieved by immediate expansion into the outer air, and any tendency to defect can be filled up by an inrush from the outer air. The open end is therefore a loop. It is to be noted that the exciter of the vibrations is in general at the open end, and that the two trains forming the stationary system consist of the direct waves from the exciter travelling into the tube, and the waves reflected back from the closed end.

In fig. 27 we may have the length AH occupying the tube. In this case $AH = \frac{1}{2}\lambda_1 = l$, the length of the tube, and the frequency $n_1 = U/\lambda_1 = U/4l$. But we may also have a shorter wave-length λ_2 such that the length AK occupies the tube. In this case $AK = \frac{3}{4}\lambda_2 = l$, and the frequency $n_2 = U/\lambda_2 = 3U/4l$. With a still shorter wave-length λ_3 we may have the length AL occupying the tube and $AL = \frac{5}{4}\lambda_3 = l$, and the frequency $n_3 = U/\lambda_3 = 5U/4l$, and so on, as we take succeeding loops for the open end.

In fig. 28 are represented the stationary wave systems of the first four modes, and any of the succeeding ones are easily drawn.

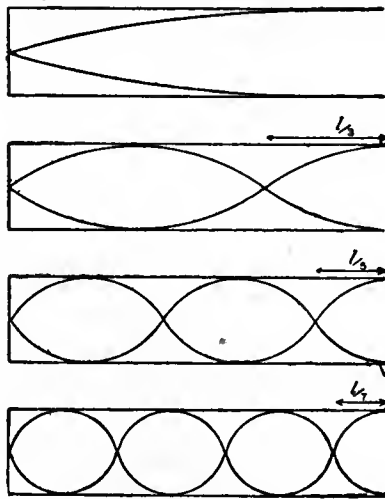

FIG. 28.

The reader will be able to make out the simultaneous motions and pressures at various points. It is obvious that the nodes are alternately in compression and extension, or vice versa, and that for $\frac{1}{2}\lambda$ on each side of a node the motion is either to it on both sides or from it on both sides.

The first mode of vibration gives the "fundamental tone," and the succeeding modes are termed "overtones." The whole series forms the series of odd harmonics. A "stopped pipe" in an organ is a pipe of this type, and both the fundamental and the overtones may occur simultaneously when it is blown.

We may illustrate the successive modes of vibration by using as pipe a tall cylindrical jar, and as exciter a vibrating tuning-fork held over the mouth. The length of the pipe may be varied by pouring in water, and this is done until we get maximum resonance of the pipe to the fork. Thus if a fork $U_1 = 256$ is used, the length of pipe for the fundamental at 0°C . is about $33,000/4 \times 256 = 33$ cms. If a fork $U_2 = 768$ is used the pipe resonates to it according to the mode of the first overtone. If the temperature is t° the length for given frequency must be increased by the factor $1 + 0.00184t$.

Correction to Length at the Open End.—The approximate theory of pipes due to Bernoulli assumes a loop at the open end, but the

condition for a loop at the open end, that of no pressure variation, cannot be exactly fulfilled. This would require that the air outside should have no mass in order that it should at once move out and relieve the air at the end of the pipe from any excess of pressure, or at once move in and fill up any defect. There are variations, therefore, at the open end, and these are such that the loop may be regarded as situated a short distance outside the end of the pipe. It may be noted that in practice there is another reason for pressure variation at the end of the pipe. The stationary wave method regards the vibration in the pipe as due to a series of waves travelling to the end and being there reflected back down the pipe. But the reflection is not complete, for some of the energy comes out as waves; hence the direct and reflected trains are quite equal, and cannot neutralize each other at the loop.

The position of the loop has not yet been calculated for an ordinary open pipe, but Lord Rayleigh has shown (*Sound*, ii. § 307) that for a cylindrical tube of radius R, provided with a flat extended flange, the loop may be regarded as about $0.82 R$, in advance of the end. That is, the length of the pipe must be increased by $0.82 R$ before applying Bernoulli's theory. This is termed the "end correction."

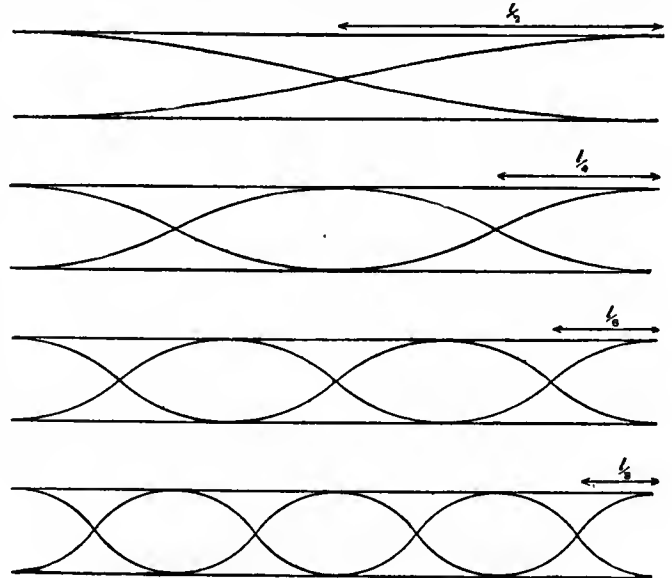

FIG. 29.

Using this result Rayleigh found the correction for an unflanged open end by sounding two pipes nearly in unison, each provided with a flange, and counting the beats. Then the flange was removed from one and the beats were again counted. The change in virtual length by removal of the flange was thus found, and the open end correction for the unflanged pipe was $0.6 R$. This correction has also been found by David James Blaikley by direct experiment (*Phil. Mag.*, 1879, 7, p. 339). He used a tube of variable length and determined the length resonating to a given fork, (1) when the closed end was the first node, (2) when it was the second node. If these lengths are l_1 and l_2 , then $l_2 - l_1 = \frac{1}{2}\lambda$ and $\frac{1}{2}(l_2 - l_1) - l_1$ is the correction for the open end. The mean value found was $0.576 R$.

2. *Pipe Open at Both Ends.*—Each end is a loop. We must therefore select a length of fig. 27 between two loops. The fundamental mode is that in which H and K represent the ends of the pipe. In this case $HK = \frac{1}{2}\lambda_1 = l$, and the frequency is $n_1 = U/\lambda_1 = U/2l$. There is a node in the middle. In the next mode H and L represent the ends and $HL = \lambda_2 = l$ and $n_2 = U/\lambda_2 = 2U/2l$. In the third mode $HM = \frac{3}{2}\lambda_3 = l$ and $n_3 = U/\lambda_3 = 3U/2l$, and so on.

In fig. 29 are represented the stationary wave systems of the first four modes. The whole series of fundamental and overtones gives the complete set of harmonics of frequencies proportional to 1, 2, 3, 4, . . . , and wave-lengths proportional to $1, \frac{1}{2}, \frac{1}{3}, \frac{1}{4}, \dots$

A metal or brass tube will serve as such a pipe, and may be excited by a suitable tuning-fork held at one end. To obtain the virtual length we must add the correction for each open end, probably about 1.2 radius. If the frequency is 256 the corrected length for the fundamental is about $(33,000/2 \times 256) (1 + 0.00184t)$ at t° . The pipe will also resonate to forks of frequencies 512, 768, 1024 and so on.

An open "flue" organ pipe is of this type. The wind rushing through the slit S (fig. 30) maintains the vibration in a way to be discussed later, and the opening O makes the lower end a loop.

The modes of vibration in an open organ pipe may be exhibited by means of Koenig's manometric flames (*Phil. Mag.*, 1873, vol. 45). The pipe is provided with manometric flames at its middle point, and at one-quarter and three-quarters of its length. When the pipe is blown softly the fundamental is very predominant, and there is a node at the middle point. The flame there is much

affected by the nodal pressure changes, while the other two vibrate only slightly. If, however, the pipe is blown strongly, the fundamental dies away, and the first overtone is predominant. Then the middle point is a loop, and the middle flame is only slightly affected, while the other two, now being at nodes, vibrate strongly.

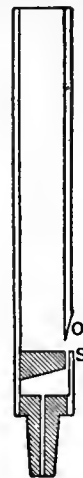

FIG. 30.

3. *Pipe Closed at Both Ends.*—The two ends in such a pipe are nodes. It is evident that the overtones will follow the same rule as for a pipe opened at both ends. This case is not exactly realized in practice, but it is closely approximated to in *Kundt's dust-tube*. A glass tube, the "dust-tube," 3 ft. or more in length, and perhaps 1 in. in diameter, has a little lycopodium powder introduced, and the powder is allowed to run all along the tube, which is then fixed horizontally. A closely-fitting adjustable piston is provided at one end. A glass or metal rod, the "sounder," is clamped at its middle point, and fixed along the prolongation of the axis of the dust-tube as in fig. 31, a loosely-fitting cork or card piston being fixed on one end of the sounder, which is inserted within the dust-tube. The other end of the sounder is stroked outwards with a damp cloth so as to make it sound its fundamental. Stationary waves are formed in the air in the dust-tube if the length is rightly adjusted by the closely-fitting piston, and the lycopodium dust collects at the nodes in little heaps, the first being at the fixed

end and the last just in front of the piston on the sounder. The stationary wave system adjusts itself so that its motion agrees with that of the sounder, which is therefore not exactly at a node. If U_s is the velocity of longitudinal waves along the sounder, and l the length of the sounder, the frequency of vibration is $U_s/2l$. If L is the distance between successive dust-heaps, *i.e.* half a wavelength, the frequency in the air is $U/2L$, where U is the velocity of sound in the pipe. Then, since the frequencies are the same, $U/2L = U_s/2l$ or $L/l = U/U_s$.



FIG. 31.

The velocities in different gases may be compared by this apparatus by filling the dust-tube with the gases in place of air. If L_1 is the internodal distance and U_1 the velocity in a gas, L and U being the corresponding values for air, we have $U_1/U = L_1/L$.

Kundt's dust-tube may also be employed for the determination of the ratio of the specific heats of a gas or vapour. If U is the velocity of sound in a gas at pressure P with density ρ , and if waves of length λ and frequency N are propagated through it, then the distance between the dust-heaps is

$$d = \frac{\lambda}{2} = \frac{U}{2N} = \frac{1}{2N} \sqrt{\frac{\gamma P}{\rho}}$$

where γ is the ratio of the two specific heats. If d is measured for two gases in succession for the same frequency N , we have

$$\frac{\gamma_2}{\gamma_1} = \frac{\rho_2 P_1}{\rho_1 P_2} \frac{d_2^2}{d_1^2}$$

where the suffixes denote the gases to which the quantities relate. If γ_1 is known this gives γ_2 . Kundt and Warburg applied the method to find γ for mercury vapour (*Pogg. Ann.*, 1876, 157, p. 356), using a double form of the apparatus in which there are two dust-tubes worked by the same sounding rod. This rod is supported at $\frac{1}{2}$ and $\frac{3}{4}$ of its length where it enters the two dust-tubes, as represented diagrammatically in fig. 32. It is stroked in the middle so as to



FIG. 32.

excite its second mode of vibration. The method ensures that the two frequencies shall be exactly the same. In the mercury experiment the sounding rod was sealed into the dust-tube, which was exhausted of air, and contained only some mercury and some quartz dust to give the heaps. It was placed in a high temperature oven, where the mercury was evaporated. The second tube containing air was outside. When a known temperature was attained the sounder was excited, and d_2 and d_1 could be measured. From the temperature, P_2/ρ_2 was known, and γ_2/γ_1 could then be found. Taking $\gamma_1 = 1.41$, γ_2 was determined to be 1.66. Lord Rayleigh and Sir William Ramsay (*Phil. Trans. A.* 1895, pt. i. p. 187) also used a single dust-tube with a sounder to find γ for argon, and again the value was 1.66.

Determinations of Pressure Changes and Amplitude of Vibrations in Pipes.—If the maximum pressure change is determined, the amplitude is given by equation (20), viz.

$$\omega_m = 2\pi n a \rho U,$$

for in the stationary wave system the pressure change and the

amplitude are both double those in either train, so that the same relation holds.

Determinations of the pressure changes, or extent of excursion of the air, in sounding organ pipes have been made by A. Kundt (*Pogg. Ann.*, 1868, 134, p. 163), A. J. I. Töppler and L. Boltzmann (*Pogg. Ann.*, vol. 141, or Rayleigh, *Amplitude of Vibration*, *Vibration*, vol. ii. § 422a), and E. Mach (*Optisch-akustischen Versuche*, 1873). Mach's method is perhaps the most direct. The pipe was fixed in a horizontal position, and along the top wall ran a platinum wire wetted with sulphuric acid. When the wire was heated by an electric current a fine line of vapour descended from each drop. The pipe was closed at the centre by a membrane which prevented a through draught, yet permitted the vibrations, as it was at a node. The vapour line, therefore, merely vibrated to and fro when the pipe was sounded. The extent of vibration at different parts of the pipe was studied through a glass side wall, a stroboscopic method being used to get the position of the vapour line at a definite part of the vibration. Mach found an excursion of 0.4 cm. at the end of an open pipe 123 cm. long. The amplitude found by the other observers was of the same order. For the vibration of air in other cavities than long cylindrical pipes we refer to Rayleigh's *Sound*, vol. ii. chs. 12 and 16.

Propagation of Waves in Pipes of Circular Section.—Helmholtz investigated the velocity of propagation of sound in pipes, taking into account the viscosity of the air (Rayleigh, *Sound*, ii. § 347), and Kirchhoff investigated it, taking into account both the viscosity and the heat communication between the air and the walls of the pipe (*loc. cit.* ii. § 350). Both obtained the value for the velocity

$$U \left(1 - \frac{C}{R \sqrt{2\pi N \rho}} \right),$$

where U is the velocity in free air, R is the radius of the pipe, N the frequency, and ρ the air density. C is a constant, equal to the coefficient of viscosity in Helmholtz's theory, but less simple in Kirchhoff's theory. Experiments on the velocity in pipes were carried out by H. Schneebeli (*Pogg. Ann.*, 1869, 136, p. 296) and by T. J. Seebeck (*Pogg. Ann.*, 1870, 139, p. 104) which accorded with this result as far as R is concerned, but the diminution of velocity was found to be more nearly proportional to $N^{-\frac{3}{2}}$. Kundt also obtained results in general agreement with the formula (Rayleigh, *Sound*, ii. § 260). He used his dust-tube method.

Elementary Theory of the Transverse Vibration of Musical Strings.

We shall first investigate the velocity with which a disturbance travels along a string of mass m per unit length when it is stretched with a constant tension T , the same at all points. We shall then show that on certain limitations two trains of disturbance may be superposed so that stationary waves may be formed, and thence we shall deduce the modes of vibration as with pipes.



FIG. 33.

Let AB (fig. 33) represent the string with the ends AB fixed. Let a disturbance once set going travel along unchanged in form from A to B with velocity U . Then move AB from right to left with this velocity, and the disturbance remains fixed in space. Take a point P in the disturbed part, and a point Q which the disturbance has not yet reached. Since the conditions in the region PQ remain always the same, the momentum perpendicular to AB entering the region at Q is equal to the momentum perpendicular to AB leaving the region at P . But, since the motion at Q is along AB , there is no momentum there perpendicular to AB . So also there is on the whole none in that direction leaving at P . Let the tangent at P make angle ϕ with AB . The velocity of the string at P parallel to PM is $U \sin \phi$, and the mass of string passing P is mU per second, so that $mU^2 \sin \phi$ is carried out per second. But the tension at P is T , parallel to the tangent, and $T \sin \phi$ parallel to PM , and through this $-T \sin \phi$ is the momentum passing out at P per second. Since the resultant is zero, $mU^2 \sin \phi - T \sin \phi = 0$, or $U^2 = T/m$.

Now keep AB fixed, and the disturbance travels with velocity U . We might make this investigation more general by introducing a force X as in the investigation for air, but it hardly appears necessary.

To form stationary waves two equal trains must be able to travel in opposite directions with equal velocities, and to be superposed. We must show then that the force called out by the sum of the disturbances is equal to the sum of the forces called out by each train separately.

In order that the velocity shall remain unchanged the tension T must remain the same. This implies that the disturbance is so small that the length is not appreciably altered. The component of T

acting parallel to the axis or straight string is Tdx/ds , and when the disturbance is sufficiently small the curve of displacement is so nearly parallel to the axis that $dx/ds=1$, and this component is T . The component of T perpendicular to the axis is $Tdy/ds=Tdy/dx$. Now if y_1 and y_2 are the displacements due to the two trains separately, and $y=y_1+y_2$, the two separate forces are Tdy_1/dx and Tdy_2/dx , while that due to y is Tdy/dx . But since $y=y_1+y_2$, $Tdy/dx=Tdy_1/dx+Tdy_2/dx$, or the condition for superposition holds when the displacement is so small that we may put $dx/ds=1$. Evidently this comes to neglecting ϕ^3 . Let two trains of equal waves moving in opposite directions along such a string of indefinite length form the stationary system of fig. 27. Since the nodes are always at rest we may represent the vibration of a given string by the length between any two nodes. The fundamental mode is that in which A and B represent the ends of the string. In this case $AB=\frac{1}{2}\lambda_1=l$ the length, and the frequency $n_1=U/\lambda_1=U/2l=(1/2l)\sqrt{T/m}$. The middle of the string is a loop. In the next mode A and C represent the ends and $AC=\lambda_2=l$ and $n_2=U/\lambda_2=2U/2l=(2/2l)\sqrt{T/m}$. In the third mode A and D represent the ends and $AD=\frac{3}{2}\lambda_3=l$ and $n_3=U/\lambda_3=3U/2l=(3/2l)\sqrt{T/m}$ and so on. In fig. 34 the stationary wave systems of the first four modes are represented.

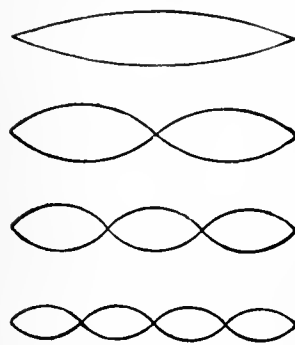

FIG. 34.

The complete series of harmonics are possible modes. The experimental demonstration of these results is easily made by the sonometer or monochord (fig. 35). A string is fixed at C on the top of a hollow box, and

passes over two edges AB, which serve as the fixed ends, and then over a pulley P, being stretched by a weight W. Between A and B a "bridge" D, i.e. another edge slightly higher than A or B, can be inserted in any position, which is determined by a graduated scale. The effective length of the string is then AD. Keeping the same tension, it may be shown that n is constant by finding n for various lengths. Keeping AD constant and varying W it may be shown that $n \propto \sqrt{W}$. Lastly, by using different strings, it may be shown that, with the same T and l, $n \propto \sqrt{1/m}$.

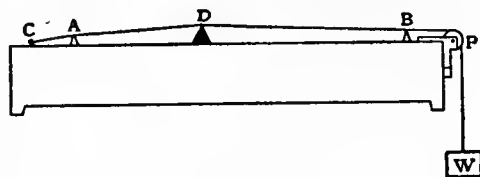

FIG. 35.

The various modes of vibration may also be exhibited. If D is removed and the string is bowed in the middle, the fundamental is brought out. If it is touched in the middle with a feather, the edge of a card, or the finger nail, and bowed a quarter of the way along the octave, the first overtone comes out. Each of the first few harmonics may be easily obtained by touching the string at the first node of the harmonic required, and bowing at the first loop, and the presence of the nodes and loops may be verified by putting light paper riders of shape \wedge on the string at the nodes and loops. When the harmonic is sounded the riders at the loops are thrown off, while those at the nodes remain seated.

Not only may the fundamental and its harmonics be obtained separately, but they are also to be heard simultaneously, particularly the earlier ones, which are usually more prominent than those higher in the series. A practised ear easily discerns the coexistence of these various tones when a pianoforte or violin string is thrown into vibration. It is evident that, in such case, the string, while vibrating as a whole between its fixed extremities, is at the same time executing subsidiary oscillations about its middle point, its points

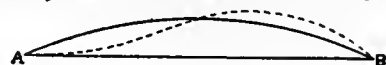

FIG. 36.

of trisection, &c., as shown in fig. 36, for the fundamental and the first harmonic. When a string is struck or bowed at a point, any harmonic with a node at that point is absent. Since the quality of the note sounded depends on the mixture of harmonics, the quality therefore is to some extent dependent on the point of excitation.

A highly ingenious and instructive method for illustrating the laws of musical strings was contrived by F. E. Melde. It consists in attaching to the loop or ventral segment of a vibrating body, e.g. a tuning-fork or a bell-glass, a silk or cotton thread, the other extremity being either fixed or passing over a pulley and supporting weights by which the thread may be stretched to any degree required. The vibrations of the larger mass are communicated to the thread, which

by proper adjustment of its length and tension vibrates in unison and divides itself into one or more loops or ventral segments easily discernible by a spectator. If the length of the thread be kept invariable, a certain tension will give but one ventral segment; the fundamental note of the thread is then of the same pitch as the note of the body to which it is attached. By reducing the tension to one quarter of its previous amount, the number of ventral segments will be seen to be increased to two, indicating that the first harmonic of the thread is now in unison with the solid, and consequently that its fundamental is an octave lower than it was with the former tension; thus confirming the law that n varies as \sqrt{T} . In like manner, on further lowering the tension to one ninth, three ventral segments will be formed, and so on.

The law that, *caeteris paribus*, n varies inversely as the thickness may be tested by forming a string of four lengths of the single thread used before, and consequently of double the thickness of the latter, when, for the same length and tension, the compound thread will exhibit double the number of ventral segments presented by the single thread.

The other laws admit of similar illustration.

Longitudinal Vibrations of Wires and Rods.

Subject to a limitation which we shall examine later, the velocity of a longitudinal disturbance along a wire or rod depends only on the material of the rod, and not upon the cross-section. Since the forces called into play by an extension or compression of the material are proportional to the cross-section, it follows that if we consider any case and then another case in which, with the same longitudinal disturbance, the cross-section is doubled, the force in the second case is doubled as well as the mass to be moved. The acceleration therefore remains the same, and the velocity is unaltered. We shall find the velocity of propagation, just as in previous cases, from the consideration of transfer of momentum.

Suppose that a disturbance is travelling with velocity U unchanged in form along a rod from left to right. Let us move the rod from right to left, so that the undisturbed parts move with velocity U. Then the disturbance remains fixed in space. Let A be a point in

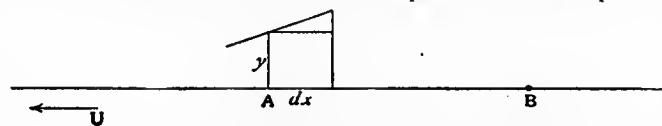

FIG. 37.

the disturbance, and B a point in the undisturbed part. The material between A and B, though continually changing, is always in the same condition, and therefore the momentum within AB is constant. Hence the amount carried out at A is equal to that carried in at B.

Now momentum is transferred in two ways, viz. by the force acting between contiguous portions of a body and by the transfer of moving matter. At B there is only the latter kind, and since the transfer of matter is $\rho\omega\omega_0U$, where ρ_0 is the undisturbed density and ω_0 is the undisturbed cross-section, since its velocity is U the passage of momentum per second is $\rho_0\omega_0U^2$. At A, if the velocity of the disturbance relative to undisturbed parts of the rod is u from left to right, the velocity relative to A is $U-u$. If ρ is the density at A, and ω the cross-section, then the momentum carried past A is $\rho\omega(U-u)^2$. But if y is the displacement at A, dy/dx is the extension at A, and the force acting is a pull across A equal to $Y\omega dy/dx$, where Y is Young's modulus of elasticity. Then we have

$$Y\omega dy/dx + \rho\omega(U-u)^2 = \rho_0\omega_0U^2 \tag{27}$$

$$\text{Now } u/U = -dy/dx, \tag{28}$$

for the particle at A moves over dy backwards, while the disturbance moves over U. Also since dx has been stretched to $dx+dy$

$$\begin{aligned} \rho\omega(dx+dy) &= \rho_0\omega_0dx \\ \rho\omega(1+dy/dx) &= \rho_0\omega_0 \end{aligned} \tag{29}$$

Substituting from (28) in (27)

$$Y\omega \frac{dy}{dx} + \rho\omega U^2 \left(1 + \frac{dy}{dx}\right)^2 = \rho_0\omega_0U^2, \tag{30}$$

and substituting from (29) in (30)

$$Y\omega \frac{dy}{dx} + \rho_0\omega_0U^2 \left(1 + \frac{dy}{dx}\right) = \rho_0\omega_0U^2, \tag{31}$$

$$\text{whence } Y\omega_0 = \rho_0\omega_0U^2, \tag{32}$$

or $U^2 = Y/\rho$, where now ρ is the normal density of the rod. The velocity with which the rod must travel in order that the disturbance may be fixed in space is therefore $U = \sqrt{Y/\rho}$, or, if the rod is kept fixed, this is the velocity with which the disturbance travels.

This investigation is subject to the limitation that the diameter of the cross-section must be small compared with the wave-length. When the rod extends or contracts longitudinally it contracts or

extends radially and in the ratio σ , known as Poisson's ratio, which in metals is not far from $\frac{1}{4}$. Let us suppose that the rod is circular, of radius r , and that the radial displacement of the surface is η . The longitudinal extension is dy/dx , and therefore the radial contraction

$$\text{is } \eta/r = \sigma dy/dx. \text{ If then } y = a \sin \frac{2\pi}{\lambda}(x-Ut), \eta = \frac{2\pi\sigma a}{\lambda} \cos \frac{2\pi}{\lambda}(x-Ut).$$

If r is of the order of λ , η is of the order of y ; and the kinetic energy of the radial motion is of the same order as that of the longitudinal motion. But our investigation entirely leaves this out of account, and is therefore faulty. In fact, the forces are then no longer parallel to the axis. There are shears of the order $d\eta/dx$ and the simple Young's modulus system can no longer be taken to represent the actual condition (see Rayleigh, *Sound*, i. § 157). But keeping r/λ small we may as before form stationary waves, and it is evident that the series of fundamental and overtones will be just as with the air in pipes, and we shall have the same three types—fixed at one end, free at both ends, fixed at both ends—with fundamental frequencies respectively

$$\frac{1}{4l}\sqrt{\frac{Y}{\rho}}, \frac{1}{2l}\sqrt{\frac{Y}{\rho}}, \text{ and } \frac{1}{l}\sqrt{\frac{Y}{\rho}}.$$

The overtones will be obvious.

For an iron wire Y/ρ is about $10^{10}/4$, so that for a frequency of 500 in a wire fixed at both ends a length about 5 metres is required. If the wire is stretched across a room and stroked in the middle with a damp cloth the fundamental is easily obtained, and the first harmonic can be brought out by stroking it at a quarter the length from one end. A glass or brass rod free at both ends may be held by the hand in the middle and excited by stroking one end outwards with a damp cloth. If it is clamped at one-quarter and three-quarters of the length from the ends, and is stroked in the middle, the first harmonic sounds.

Young's modulus may be obtained for the material of a rod by clamping it in the middle and obtaining the frequency of the fundamental when $Y = 4l^2 n^2 \rho$.

The value thus obtained is generally appreciably greater than that obtained by a statical method in which the rod is pulled out by an applied tension.

Rods of different materials may be used as sounders in a Kundt's dust tube, and their Young's moduli may be compared, since:—

$$\text{velocity in rod} = \text{velocity in air} \times \frac{\text{length of rod}}{\text{distance between dust-heaps.}}$$

Torsional Vibrations of Rods and Wires.—The velocity of propagation of a torsional disturbance along a wire of circular section may be found by the transfer of momentum method, remembering that we must now replace linear momentum by angular momentum. Let the disturbance be supposed to travel unchanged in form from left to right with velocity U . Now suppose that the wire or rod is moved from right to left with velocity U . The disturbance is then fixed in space. Let A be a point in the disturbance and B a point in the undisturbed portion. The condition of the matter between A and B remains constant, though fresh matter keeps coming in at B and an equal quantity leaves at A. Hence the angular momentum of the part between A and B remains constant, or as much enters at B as leaves at A. But at B there is no torsion, and no torsion couple of one part of the wire on the next. So that no angular momentum enters at B, and therefore on the whole none leaves at A. The transfer of angular momentum through A is of two kinds—first, that due to the passage of rotating matter, and, secondly, that due to the couple with which matter to the right of A acts upon matter to the left of A. The mass of matter moving through A per second is $\rho \pi a^2 U$, where a is the radius of the wire and ρ is its density. If θ is the angle of twist, the angular velocity is $d\theta/dt$. The radius of gyration of the section is $\frac{3}{8}a^2$. Hence the angular momentum conveyed per second outwards is $\frac{3}{8}\rho \pi a^4 U d\theta/dt$. The couple due to the twist of a wire of length l through ϕ is $G = \frac{1}{2} n \pi a^4 \phi/l$, and we may put $\phi/l = d\theta/dx$. Since no angular momentum goes out on the whole

$$\frac{3}{8} n \pi a^4 d\theta/dx + \frac{1}{2} \rho \pi a^4 U d\theta/dt = 0. \tag{33}$$

But the condition of unchanged form requires that the matter shall twist through $(d\theta/dx)dx$ while it is travelling over dx , i.e. in time dx/U .

$$\text{Then } \frac{d\theta}{dt} \frac{dx}{U} = -\frac{d\theta}{dx} dx \text{ or } \frac{d\theta}{dt} = -U \frac{d\theta}{dx}.$$

Substituting in (33) we get

$$U^2 = n/\rho. \tag{34}$$

If we now keep the wire at rest the disturbance travels along it with velocity $U = \sqrt{n/\rho}$, and it depends on the rigidity and density of the wire and not upon its radius.

It is easy to deduce the modes of vibration from stationary waves as in the previous cases. If a rod is clamped at one end and free at the other, the fundamental frequency is $(1/4l)\sqrt{n/\rho}$. For iron n/ρ is of the order 10^{11} , so that the frequency for a rod 1 metre long is about 3000. When a cart wheel is ungreased it produces a very high note, probably due to torsional vibrations of the axle.

The torsional vibrations of a wire are excited when it is bowed. If small paper rings are put on a monochord wire they rotate through these vibrations when the wire is bowed.

Transverse Vibrations of Bars or Rods.—When a bar or rod is of considerable cross-section, a transversal disturbance calls into play forces due to the strain of the material much more important than the forces due to any tension which is ordinarily applied. The velocity of a disturbance along such a bar, and its modes of vibration, depend therefore on the elastic properties of the material and the dimensions of the bar. We cannot investigate the vibrations in an elementary manner. A full discussion will be found in Rayleigh's *Sound*, vol. i. ch. 8. We shall only give a few results.

The cases interesting in sound are those in which (1) the bar is free at both ends, and (2) it is clamped at one end and free at the other.

For a bar free at both ends the fundamental mode of vibration has two nodes, each 0.224 of the length from the end. The next mode has a node in the middle and two others each 0.132 from the end. The third mode has four nodes 0.094 and 0.357 from each end, and so on. The frequencies are nearly in the ratios $3^2:5^2:7^2 \dots$. Such bars are used in the harmonicon.

When one end is clamped and the other is free the clamped end is always a node. The fundamental mode has that node only. The next mode has a second node 0.226 from the free end; the next, nodes at 0.132 and 0.5 from the free end, and so on. The frequencies are nearly in the ratios $1:6.25:17.5$. Such bars are used in musical boxes and as free reeds in organ pipes.

The most important example of this type is the tuning-fork, which may be regarded as consisting of two parallel bars clamped together at the base. The first overtone has frequency 6.25 that of the fundamental, and is not in the harmonic series. If the fork be mounted on a resonance box or held in front of a cavity resounding to the fundamental and not to the first overtone, the fundamental is brought out in great purity.

Vibrations of Plates.—These are for the most part interesting rather from the point of view of elasticity than of sound. We shall not attempt to deal with the theory here but shall describe only the beautiful mode of exhibiting the regions of vibration and of rest devised by E. F. F. Chladni (1756–1827). As usually arranged, a thin metal plate is screwed on to the top of a firm upright post at the centre of the plate, which is horizontal. White sand is lightly scattered by a pepper-box over the plate. The plate is then bowed at the edge and is thrown into vibration between nodal lines or curves and the sand is thrown from the moving parts or ventral segments into these lines, forming "Chladni's figures." The development of these figures by a skilful bow is very fascinating. As in the case of a musical string, so here we find that the pitch of the note is higher for a given plate the greater the number of ventral segments into which it is divided; but the converse of this does not hold good, two different notes being obtainable with the same number of such segments, the position of the nodal lines being, however, different.

The upper line of annexed figures shows how the sand arranges itself in three cases, when the plate is square. The lower line gives the same in a sort of idealized form. Fig. 38, 1, corresponds to the

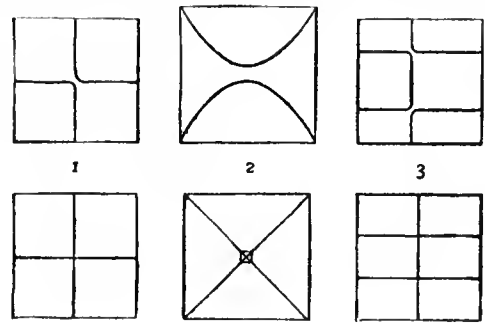

FIG. 38.

lowest possible note of the particular plate used; fig. 38, 2, to the fifth higher; fig. 38, 3, to the tenth or octave of the third, the numbers of vibration in the same time being as 2 to 3 to 5.

If the plate be small, it is sufficient, in order to bring out the simpler sand-figures, to hold the plate firmly between two fingers of the same hand placed at any point where at least two nodal lines meet, for instance the centre in (1) and (2), and to draw a violin bow downwards across the edge near the middle of a ventral segment. But with larger plates, which alone will furnish the more complicated figures, a clamp-screw must be used for fixing the plate, and, at the same time, one or more other nodal points ought to be touched with the fingers while the bow is being applied. In this way, any of the possible configurations may be easily produced.

By similar methods, a circular plate may be made to exhibit nodal lines dividing the surface by diametral lines into four or a greater, but always even, number of sectors, an odd number being incompatible with the general law of stationary waves that the parts of a body adjoining a nodal line on either side must always vibrate oppositely to each other.

Another class of figures consists of circular nodal lines along with diametral lines (fig. 39).

Circular nodal lines unaccompanied by intersecting lines cannot be produced in the manner described; but may be got either by drilling

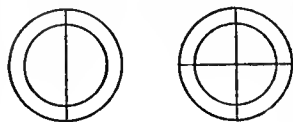

FIG. 39.

a small hole through the centre, and drawing a horse-hair along its edge to bring out the note, or by attaching a long thin elastic rod to the centre of the plate, at right angles to it, holding the rod by the middle and rubbing it lengthwise with a bit of cloth powdered with resin, till the rod gives a distinct note; the vibrations are communicated to the plate, which consequently vibrates transversely, and causes the sand to heap itself into one or more concentric rings.

Paper, parchment, or any other thin membrane stretched over a square, circular, &c., frame, when in the vicinity of a sufficiently powerful vibrating body, will, through the medium of the air, be itself made to vibrate in unison, and, by using sand, as in previous instances, the nodal lines will be depicted to the eye, and seen to vary in form, number and position with the tension of the plate and the pitch of the originating sound. The membrana tympani or drum of the ear, has, in like manner and on the same principles, the property of repeating the vibrations of the external air which it communicates to the internal parts of the ear.

Bells may be regarded as somewhat like circular plates vibrating with radial nodes, and with the edges turned down. Lord Rayleigh has shown that there is a tangential motion as well as a motion in and out. Ordinarily when a bell is struck the impulse primarily excites the radial motion, and the tangential motion follows as a matter of course. When a finger-glass (an inverted bell), is excited by passing the finger round the circumference, the tangential motion is primarily excited and the radial follows it. Some discussion of the vibrations of bells will be found in Rayleigh, *Sound*, vol. i. ch. 10 (see also BELLS).

Singing Flames.—A "jet tube," i.e. a tube a few inches long with a fine nozzle at the top, is mounted as in fig. 40, so as to rise out

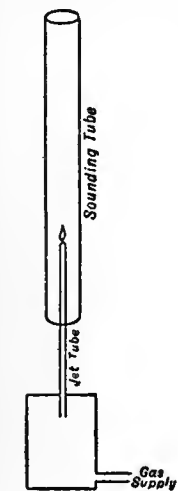

FIG. 40.—Singing Flame.

of a vessel to which coal-gas, or, better, hydrogen, is supplied. The supply is regulated so that when the gas is lighted the flame is half or three-quarters of an inch high. A "sounding tube," say an inch in diameter, and somewhat more than twice the length of the jet tube, is then lowered over the flame, as in the figure. When the flame is at a certain distance within the tube the air is set in vibration, and the sounding tube gives out its fundamental note continuously. The flame appears to lengthen, but if the reflection is viewed in a vertical mirror revolving about a vertical axis or in Koenig's cube of mirrors, it is seen that the flame is really intermittent, jumping up and down once with each vibration, sometimes apparently going within the jet tube at its lowest point. For a given jet tube there is a position of maximum efficiency easily obtained by trial. The jet tube, for a reason which will be given when we consider the maintenance of vibrations, must be less than half the length of the sounding tube.

A series of pipes of lengths to give any desired series of notes may be arranged. If two tubes in unison are employed, a pretty example of resonance may be obtained. One is adjusted so as just not to sing. The other is then made to sing and frequently the first will be set singing also.

Sensitive Flames and Jets.—When a flame is just not flaring, any one of a certain range of notes sounded near it may make it flare while the note is sounding. This was first noticed by John Le Conte (*Phil. Mag.*, 1858, 15, p. 235), and later by W. F. Barrett (*Phil. Mag.*, 1867, 33, p. 216). Barrett found that the best form of burner for ordinary gas pressure might be made of glass tubing about $\frac{3}{8}$ in. in diameter contracted to an orifice $\frac{1}{8}$ inch in diameter, the orifice being nicked by a pair of scissors into a V-shape. The flame rises up from the burner in a long thin column, but when an appropriate note is sounded it suddenly drops down and thickens. Barrett further showed by using smoke jets that the flame is not essential. John Tyndall (*Sound*, lecture vi. § 7 seq.) describes a number of beautiful experiments with jets at higher pressure than ordinary, say 10 in. of water, issuing from a pinhole steatite burner. The flame may be 16 in. high, and on receiving a suitably high sound it suddenly drops down and roars. The sensitive point is at the orifice. Lord Rayleigh (*Sound*, ii. § 370), using as a source a "bird-call," a whistle of high frequency, formed a series of stationary waves by reflection at a flat surface. Placing the sensitive flame at different parts of this train, he found that it was excited, not at the nodes where the pressure varied, but at the loops where the motion was the greatest and where there was little pressure change. In his *Sound* (ii. ch. 21) he has given a theory of the sensitiveness. When the velocity of the jet is gradually increased there is a certain range of velocity for which the jet is unstable,

so that any deviation from the straight rush-out tends to increase as the jet moves up. If then the jet is just on the point of instability, and is subjected as its base to alternations of motion, the sinuosities impressed on the jet become larger and larger as it flows out, and the flame is as it were folded on itself. Another form of sensitive jet is very easily made by putting a piece of fine wire gauze 2 or 3 in. above a pinhole burner and igniting the gas above the gauze. On adjusting the gas so that it burns in a thin column, just not roaring, it is extraordinarily sensitive to some particular range of notes, going down and roaring when a note is sounded. If a tube be placed over such a flame it makes an excellent singing tube. The flame of an incandescent gas mantle if turned low is frequently sensitive to a certain range of notes. Such a flame may jump down, for instance, to each tick of a neighbouring clock.

Savart's Liquid Jets.—If a jet of water issues at an angle to the horizontal from a round pinhole orifice under a few inches pressure, it travels out as an apparently smooth cylinder for a short distance, and then breaks up into drops which travel at different rates, collide, and scatter. But if a tuning-fork of appropriate frequency be set vibrating with its stalk in contact with the holder of the pipe from which the jet issues, the jet appears to go over in one continuous thread. Intermittent illumination, however, with frequency equal to that of the fork shows at once that the jet is really broken up into drops, one for each vibration, and that these move over in a steady procession. The cylindrical form of jet is unstable if its length is more than π times its diameter, and usually the irregular disturbances it receives at the orifice go on growing, and ultimately break it up irregularly into drops which go out at different rates. But, if quite regular disturbances are impressed on the jet at intervals of time which depend on the diameter and speed of outflow (they must be somewhat more than π times its diameter apart), these disturbances go on growing and break the stream up into equal drops, which all move with the same velocity one after the other. An excellent account of these and other jets is given in C. V. Boys' *Soap Bubbles*, lecture iii.

Maintenance of Vibrations.—When a system is set vibrating and left to itself, the vibration gradually dies away as the energy leaks out either in the waves formed or through friction. In order that the vibration may be maintained, a periodic force must be applied either to aid the internal restoring force on the return journey, or weaken it on the outgoing journey, or both. Thus if a pendulum always receives a slight impulse in the direction of motion just about the lowest point, this is equivalent to an increase of the restoring force if received before passage through the lowest point, and to a decrease if received after that passage, and in either case it tends to maintain the swing. If the bob of the pendulum is iron, and if a coil is placed just below the centre of swing, then, if a current passes through the coil, while and only while the bob is moving towards it, the vibration is maintained. If the current is on while the bob is receding the vibration is checked. If it is always on it only acts as if the value of gravity were increased, and does not help to maintain or check the vibration, but merely to shorten the period.

In a common form of electrically maintained fork, the fork is set horizontal with its prongs in a vertical plane, and a small electro-magnet is fixed between them. The circuit of the electro-magnet is made and broken by the vibration of the fork in different ways—say, by a wire bridge attached to the lower prong which dips into and lifts out of two mercury cups. The mercury level is so adjusted that the circuit is just not made when the fork is at rest. When it is set vibrating contact lasts during some part of the outward and some part of the inward swing. But partly owing to the delay in making contact through the carriage down of air on the contact piece, and partly owing to the delay in establishing full current through self-induction, the attracting force does not rise at once to its full value in the outgoing journey, whereas in the return journey the mercury tends to follow up the contact piece, and the full current continues up to the instant of break. Hence the attracting force does more work in the return journey than is done against it in the outgoing, and the balance is available to increase the vibration.

In the organ pipe—as in the common whistle—a thin sheet of air is forced through a narrow slit at the bottom of the embouchure and impinges against the top edge, which is made very sharp. The disturbance made at the commencement of the blowing will no doubt set the air in the pipe vibrating in its own natural period, just as any irregular air disturbance will set a suspended body swinging in its natural period, but we are to consider how the vibration is maintained when once set going. When the motion due to the vibration is up along the pipe from the embouchure, the air moves into the pipe from the outside, and carries the sheet-like stream in with it to the inside of the sharp edge. This stream does work on the air, aiding the motion. When the motion is reversed and the air moves out of the pipe at the embouchure, the sheet is deflected on to the outer side of the sharp edge, and no work is done against it by the air in the pipe. Hence the stream of air does work during half the vibration and this is not abstracted during the other half, and so it goes on increasing the motion until the supply of energy in blowing is equal to the loss by friction and sound.

Electrically Maintained Fork.

Organ Pipe.

The maintenance of the vibration of the air in the singing tube has been explained by Lord Rayleigh (*Sound*, vol. ii. § 322 *h*) as due to the way in which the heat is communicated to the vibrating air. When the air in a pipe open at both ends is vibrating in its simplest mode, the air is alternately moving into and out from the centre. During the quarter swing ending with greatest nodal pressure, the kinetic energy is changed to potential energy manifested in the increase of pressure. This becomes again kinetic in the second quarter swing, then in the third quarter it is changed to potential energy again, but now manifested in the decrease of pressure. In the last quarter it is again turned to the kinetic form. Now suppose that at the end of the first quarter swing, at the instant of greatest pressure, heat is suddenly given to the air. The pressure is further increased and the potential energy is also increased. There will be more kinetic energy formed in the return journey and the vibration tends to grow. But if the heat is given at the instant of greatest rarefaction, the increase of pressure lessens the difference from the undisturbed pressure, and lessens the potential energy, so that during the return less kinetic energy is formed and the vibration tends to die away. And what is true for the extreme points is true for the half periods of which they are the middle points; that is, heat given during the compression half aids the vibration, and during the extension half damps it. Now let us apply this to the singing tube. Let the gas jet tube be of somewhat less than half the length of the singing tube, and let the lower end of the jet tube be in a wider tube or cavity so that it may be regarded as an "open end." When the air in the singing tube is singing, it forces the gas in the jet tube to vibrate in the same period and in such phase that at the nozzle the pressure in both tubes shall be the same. The lower end of the jet tube, being open, is a loop, and the node may be regarded as in an imaginary prolongation of the jet tube above the nozzle. It is evident that the pressure condition will be fulfilled only if the motions in the two tubes are in the same direction at the same time, closing into and opening out from the nodes together. When the motion is upwards gas is emitted; when the motion is downwards it is checked. The gas enters in the half period from least to greatest pressure. But there is a slight delay in ignition, partly due to expulsion of incombustible gas drawn into the jet tube in the previous half period, so that the most copious supply of gas and heat is thrown into the quarter period just preceding greatest pressure, and the vibration is maintained. If the jet tube is somewhat longer than half the sounding tube there will be a node in it, and now the condition of equality of pressure requires opposite motions in the two at the nozzle, for their nodes are situated on opposite sides of that point. The heat communication is then chiefly in the quarter vibration just preceding greatest rarefaction, and the vibration is not maintained.

Interference of Sound.

When two trains of sound waves travel through the same medium, each particle of the air, being simultaneously affected by the disturbances due to the different waves, moves in a different manner than it would if only acted on by each wave singly. The waves are said mutually to interfere. We shall exemplify this subject by considering the case of two waves travelling in the same direction through the air. We shall then obviously be led to the following results:—

If the two waves are of equal length λ , and are in the same phase (that is, each producing at any given moment the same state of motion in the air particles), their combined effect is equivalent to that of a wave of the same length λ , but by which the excursions of the particles are increased, being the sum of those due to the two component waves respectively, as in fig. 41, 1.

If the two interfering waves, being still of same length λ , be in opposite phases, or so that one is in advance of the other by $\frac{1}{2}\lambda$, and consequently one produces in the air the opposite state of motion to the other, then the resultant wave is one of the same length λ , but the excursions of the particles are decreased, being the difference between those due to the component waves as in fig. 41, 2. If the amplitudes of vibration which thus mutually interfere are moreover equal, the effect is the total mutual destruction of the vibratory motion.

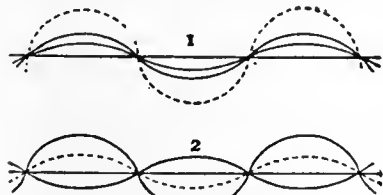

FIG. 41.

Thus we learn that two musical notes, of the same pitch, conveyed to the ear through the air, will produce the effect of a single note of the same pitch, but of increased loudness, if they are in the same phase, but may affect the ear very slightly, if at all, when in opposite phases. If the difference of phase

be varied gradually from zero to $\frac{1}{2}\lambda$, the resulting sound will gradually decrease from a maximum to a minimum.

Among the many experimental confirmations which may be adduced of these proportions we will mention the following:—

Take a circular plate, such as is available for the production of Chladni's figures, and cut out of a sheet of pasteboard a piece of the shape ABCD (fig. 42), consisting of two circular quadrants of the same diameter as the plate. Let, now, the plate be made in the usual manner to vibrate so as to exhibit two nodal lines coinciding with two rectangular diameters. If the ear be placed right above the centre of the plate, the sound will be scarcely audible. But, if the pasteboard be interposed so as to intercept the vibrating segments AOB, DOC, the note becomes much more distinct. The reason of this is, that the segments of the plate AOD, BOC always vibrate in the same direction, but oppositely to the segments AOB, DOC. Hence, when the pasteboard is in its place, there are two waves of same phase starting from the two former segments, and reaching the ear after equal distances of transmission through the air, are again in the same phase, and produce on the ear a conjunct impression. But when the pasteboard is removed, then there is at the ear opposition of phase between the first and the second pair of waves, and consequently a minimum of sound.

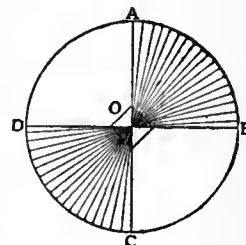

FIG. 42.

A tubular piece of wood shaped as in fig. 43, and having a piece of thin membrane stretched over the opening at the top C, some dry sand being strewn over the membrane, is so placed over a circular or rectangular vibrating plate that the ends A, B lie over the segments of the plate, such as AOD, COB in the previous figure, which are in the same state of motion. The sand at C will be set in violent movement. But if the same ends A, B be placed over oppositely vibrating segments (such as AOD, COD), the sand will be scarcely, if at all, affected.



FIG. 43.

If a tuning-fork in vibration be turned round before the ear, four positions will be found in which it will be inaudible, owing to the mutual interference of the oppositely vibrating prongs of the fork. On interposing the hand between the ear and either prong of the fork when in one of those positions, the sound becomes audible, because then one of the two interfering waves is cut off from the ear. This experiment may be varied by holding the fork over a glass jar into which water is poured to such a depth that the air-column within reinforces the note of the fork when suitably placed, and then turning the fork round.

Helmholtz's double siren is well calculated for the investigation of the laws of interference of sound. For this purpose a simple mechanism is found in the instrument, by means of which the fixed upper plate can be turned round and placed in any position relatively to the lower one. If, now, the apparatus be so set that the notes from the upper and lower chest are in unison, the upper fixed plate may be placed in four positions, such as to cause the air-current to be cut off in the one chest at the exact instant when it is freely passing through the other, and vice versa. The two waves, therefore, being in opposite phases, neutralize one another, and the result is a faint sound. On turning round the upper chest into any intermediate position, the intensity of the sound will increase up to a maximum, which occurs when the air in both chests is being admitted and cut off contemporaneously.

If two organ pipes in unison are mounted side by side on a wind-chest with their ends close together, and are blown for a very short time, they sound. But if the blowing is continued, usually in less than a second the sound dies away to a small fraction of that due to either alone. Yet the air within the pipes is vibrating more vigorously than ever, but in opposite phases in the two pipes. This may be shown by furnishing the pipes with manometric flames placed in the same vertical line. When the flames are viewed in a revolving mirror and the pipes are blown, each image of one flame lies between two images of the other. The essential fact, as pointed out by Lord Rayleigh (*Scientific Papers*, i. 409), is not the common wind chest, but the nearness of the open ends, so that the outrush from one pipe can supply the inrush to the other, and the converse. If, the two pipes are slightly out of tune when sounded separately together they sound a common note which may be higher than that due to either alone. Lord Rayleigh (*loc. cit.*) points out that this

is due to reduction of the end correction. When the air rushes out from one pipe, it has not to force its way into the open air, but finds a cavity being prepared for it close at hand in the other pipe, and so the extensions and compressions at the ends are more easily reduced. Even the longer pipe may be effectively shorter than the corrected shorter pipe when sounding alone.

Beats.

When two notes are not quite in unison the resulting sound is found to alternate between a maximum and minimum of loudness recurring periodically. To these periodical alternations has been given the name of *Beats*. Their origin is easily explicable. Suppose the two notes to correspond to 200 and 203 vibrations per second; at some instant of time, the air particles, through which the waves are passing, will be similarly displaced by both, and consequently the joint effect will be a sound of some intensity. But, after this, the first or less rapidly vibrating note will fall behind the other, and cause a diminution in the joint displacements of the particles, till, after the lapse of one-sixth of a second, it will have fallen behind the other by half a vibration. At this moment, therefore, opposite displacements will be produced of the air particles by the two notes, and the sound due to them will be at a minimum. This will be followed by an increase of intensity until the lapse of another sixth of a second, when the less rapidly vibrating note will have lost another half-vibration relatively to the other, or one vibration reckoning from the original period of time, and the two component vibrations will again conspire and reproduce a maximum effect. Thus, an interval of one-third of a second elapses between two successive maxima or beats, and there are produced three beats per second. By similar reasoning it may be shown that the number of beats per second is always equal to the difference between the numbers of vibrations in the same time corresponding to the two interfering notes. The more, therefore, these are out of tune the more rapidly will the beats follow each other.

The formation of beats may be illustrated by considering the disturbance at any point due to two trains of waves of equal amplitude a and of nearly equal frequencies n_1, n_2 . If we measure the time from an instant at which the two are in the same phase the resulting disturbance is

$$y = a \sin 2\pi n_1 t + a \sin 2\pi n_2 t \\ = 2a \cos \pi(n_1 - n_2)t \sin \pi(n_1 + n_2)t,$$

which may be regarded as a harmonic disturbance of frequency $(n_1 + n_2)/2$ but with amplitude $2a \cos \pi(n_1 - n_2)t$ slowly varying with the time. Taking the squares of the amplitude to represent the intensity or loudness of the sound which would be heard by an ear at the point, this is

$$4a^2 \cos^2 \pi(n_1 - n_2)t \\ = 2a^2 \{1 + \cos 2\pi(n_1 - n_2)t\},$$

a value which ranges between 0 and $4a^2$ with frequency $n_1 - n_2$. The sound swells out and dies down $n_1 - n_2$ times per second, or there are $n_1 - n_2$ beats per second. If, instead of considering one point in a succession of instants, we consider a succession of points along the line of propagation at the same instant, we evidently have waves of amplitude varying from $2a$ down to 0, and then up to $2a$ again in distance $U/(n_1 - n_2)$.

The phenomena of beats may be easily observed with two organ-pipes put slightly out of tune by placing the hand near the open end of one of them, with two musical strings on a resonant chest, or with two tuning-forks of the same pitch mounted on their resonance boxes, or held over a resonant cavity (such as a glass jar), one of the forks being put out of tune by loading one prong with a small lump of beeswax. In the last instance, if the forks are fixed on one solid piece of wood which can be grasped with the hand, the beat will be actually felt by the hand. If one prong of each fork be furnished with a small plain mirror, and a beam of light from a luminous point be reflected successively by the two mirrors, so as to form an image on a distinct screen, when one fork alone is put in vibration, the image will move on the screen and be seen as a line of a certain length. If both forks are in vibration, and are perfectly in tune, this line may either be increased or diminished permanently in length according to the difference of phase between the two sets of vibrations. But if the forks be not quite in tune then the length of the image will be found to fluctuate between a maximum and a minimum, thus making the beats sensible to the eye. The vibro-graph is also well suited for the same purpose, and so in an especial manner is Helmholtz's double siren, in which, by continually turning round the upper box, a note is produced by it more or less out of tune with the note formed by the lower chest, according as the handle is moved more or less rapidly, and most audible beats ensue. We

have already explained how beats are used on Scheibler's tonometer to give a series of forks of known frequencies. Beats also afford an excellent practical guide in the tuning of instruments, but more so for the higher notes of the register, inasmuch as the same number of beats are given by a smaller deviation from unison by two notes of high pitch than by two notes of low pitch. Thus, two low notes of 32 and 30 vibrations respectively, whose interval is therefore $\frac{8}{15}$ or $\frac{1}{1\frac{3}{4}}$, i.e. a semitone, give two beats per second, while the same number of beats are given by notes of 32×16 (four octaves higher than the first of the preceding) or 512, and 514 vibrations, which are only slightly out of tune.

Beats and Dissonance.—As the interval between two tones, and consequently the number of beats, increases the effect on the ear becomes more and more unpleasant. The sound is jarring and harsh, and we term it a "dissonance" or "discord." In the middle notes of the musical register the maximum harshness occurs when the beats are about 30. Thus the interval $b'c''$ with frequencies 495 and 528, giving 33 beats in a second, is very dissonant. But the interval $b'bc''$ gives nearly twice as many beats and is not nearly so dissonant. The minor third $a'c''$ with 88 beats per second shows scarcely any roughness, and when the beats rise to 132 per second the result is no longer unpleasant.

We are then led to conclude that beats are the physical foundation for dissonance. The frequency of beats giving maximum dissonance rises as we rise higher in the musical scale, and falls as we descend. Thus $b''c'''$ and $b'bc''$ have each 66 beats per second, yet the former is more dissonant than the latter. Again $b'c''$ and CG have each 33 beats per second, yet the latter interval is practically smooth and consonant. This beat theory of dissonance was first put forward by Joseph Sauveur (1653-1716) in 1700. Robert Smith (*Harmonics*, 2nd ed., 1759, p. 95) states that Sauveur "inferred that octaves and other simple concords, whose vibrations coincide very often, are agreeable and pleasant because their beats are too quick to be distinguished, be the pitch of the sounds ever so low; and on the contrary, that the more complex consonances whose vibrations coincide seldom are disagreeable because we can distinguish their slow beats; which displease the ear, says he, by reason of the inequality of the sound. And in pursuing this thought he found that those consonances which beat faster than six times in a second are the very same that musicians treat as concords; and that others which beat slower are the discords; and he adds that when a consonance is a discord at a low pitch and a concord at a high one, it beats sensibly at the former pitch but not at the latter." But Sauveur fixed the limiting number of beats for the discord far too low, and again he gave no account of dissonances such as the seventh, where the frequency of the beats between the fundamentals is far beyond the number which is unpleasant. Smith, though recognizing the unpleasantness of beats, could not accept Sauveur's theory, and, indeed, it received no acceptance till it was rediscovered by Helmholtz, to whose investigations, recorded in his *Sensations of Tone*, we owe its satisfactory establishment.

Suppose that we start with two simple tones in unison; there is perfect consonance. If one is gradually raised in pitch beating begins, at first easily countable. But as the pitch of the one rises the beats become a jar too frequent to count, and only perhaps to a trained ear recognizable as beats. The two tones are now dissonant, and, as we have seen, about the middle of the scale the maximum dissonance is when there are between 30 and 40 beats per second. If the pitch is raised still further the dissonance lessens, and when there are about 130 beats per second the interval is consonant. If all tones were pure, dissonance at this part of the scale would not occur if the interval were more than a third. But we have to remember that with strings, pipes and instruments generally the fundamental tone is accompanied by overtones, called also "upper partials," and beating within the dissonance range may occur between these overtones.

Thus, suppose a fundamental 256 has present with it overtone harmonics 512, 768, 1024, 1280, &c., and that we sound with it the major seventh with fundamental 480, and having harmonics 960, 1440, &c. The two sets may be arranged thus

c	256	512	768	1024	1280
b	480		960		1440,

and we see that the fundamental of the second will beat 32 times per second with the first overtone of the first, giving dissonance. The first overtone of the second will beat 64 times per second with the third of the first, and at such height in the scale this frequency will be unpleasant. The very marked dissonance of the major seventh is thus explained. We can see, too, at once how the octave is such a smooth consonance. Let the two tones with their harmonic overtones be

256	512	768	1024	1280	1536
	512		1024		1536.

The fundamental and overtones of the second all coincide with overtones of the first.

Take as a further example the fifth with harmonic overtones as under

256	512	768	1024	1280	1536
384		768	1152		1536.

The fundamental and overtones of the second either coincide with or fall midway between overtones in the first, and there is no approach to a dissonant frequency of beats, and the concord is perfect.

But obviously in either the octave or the fifth, if the tuning is imperfect, beats occur all along the line wherever the tones should coincide with perfect tuning. Thus it is easy to detect a want of tuning in these intervals.

The harshness of deep notes on instruments rich in overtones may be explained as arising from beats between successive overtones. Thus, if a note of frequency 64 is sounded, and if all the successive overtones are present, the difference of frequency will be 64, and this is an unpleasant interval when we get to the middle of the scale, say to overtones 256 and 320 or to 512 and 576. Thus Helmholtz explains the jarring and braying which are sometimes heard in bass voices. These cases must serve to illustrate the theory. For a full discussion see his *Sensations of Tone*, ch. 10.

Dissonance between Pure Tones.—When two sources emit only pure tones we might expect that we should have no dissonance when, as in the major seventh, the beat frequency is greater than the range of harshness. But the interval is still dissonant, and this is to be explained by the fact that the two tones unite to give a third tone of the frequency of the beats, easily heard when the two primary tones are loud. This tone may be within dissonance range of one of the primaries. Thus, take the major seventh with frequencies 256 and 480. There will be a tone frequency $480 - 256 = 224$, and this will be very dissonant with 256.

The tone of the frequency of the beats was discovered by Georg Andreas Sorge in 1740, and independently a few years later by Giuseppe Tartini, after whom it is named. It may easily be heard when a double whistle with notes of different pitch is blown strongly, or when two gongs are loudly sounded close to the hearer. It is heard, too, when two notes on the harmonium are loudly sounded. Formerly it was generally supposed that the Tartini tone was due to the beats themselves, that the mere variation in the amplitude was equivalent, as far as the ear is concerned, to a superposition on the two original tones of a smooth sine displacement of the same periodicity as that variation. This view has still some supporters, and among its recent advocates are Koenig and Hermann. But it is very difficult to suppose that the same sensation would be aroused by a truly periodic displacement represented by a smooth curve, and a displacement in which the period is only in the amplitude of the to-and-fro motion, and which is represented by a jagged curve. No explanation is given by the supposition; it is merely a statement which can hardly be accepted unless all other explanations fail.

Combination Tones.—Helmholtz has given a theory which certainly accounts for the production of a tone of the frequency of the beats and for other tones all grouped under the name of "combination tones"; and in his *Sensations of Tone* (ch. 11) he examines the beats due to these combination tones and their effects in producing dissonance. The example we have given above of the major seventh must serve here. The reader is referred to the full discussion by Helmholtz. We shall conclude by a brief account of the ways in which combination tones may be produced. There appears to be no doubt that they are produced, and the only question is whether the theory accounts sufficiently for the intensity of the tones actually heard.

Combination tones may be produced in three ways: (1) In the neighbourhood of the source; (2) in the receiving mechanism of the ear; (3) in the medium conveying the waves.

1. We may illustrate the first method by taking a case discussed by Helmholtz (*Sensations of Tone*, app. xvi.) where the two sources are reeds or pipes blown from the same wind-chest. Let us suppose that with constant excess of pressure, p , in the wind-chest, the amplitude produced is proportional to the pressure, so that the two tones issuing may be represented by $pa \sin 2\pi n_1 t$ and $pb \sin 2\pi n_2 t$. Now as each source lets out the wind periodically it affects the pressure in the chest so that we cannot regard this as constant, but may take it as better represented by $p + \lambda a \sin (2\pi n_1 t + e) + \mu b \sin (2\pi n_2 t + f)$. Then the issuing disturbance will be

$$\begin{aligned} & \{p + \lambda a \sin (2\pi n_1 t + e) + \mu b \sin (2\pi n_2 t + f)\} \{a \sin 2\pi n_1 t + b \sin 2\pi n_2 t\} \\ &= pa \sin 2\pi n_1 t + pb \sin 2\pi n_2 t \\ &+ \frac{a^2 \lambda}{2} \cos e - \frac{a^2 \lambda}{2} \cos (4\pi n_1 t + e) \\ &+ \frac{b^2 \mu}{2} \cos f - \frac{b^2 \mu}{2} \cos (4\pi n_2 t + f) \\ &+ \frac{ab \lambda}{2} \cos \{2\pi (n_1 - n_2)t + e\} - \frac{ab \lambda}{2} \cos \{2\pi (n_1 + n_2)t + e\} \\ &+ \frac{ab \mu}{2} \cos \{2\pi (n_1 - n_2)t - f\} - \frac{ab \mu}{2} \cos \{2\pi (n_1 + n_2)t + f\} \end{aligned} \quad (35)$$

Thus, accompanying the two original pure tones there are (1) the octave of each; (2) a tone of frequency $(n_1 - n_2)$; (3) a tone of frequency $(n_1 + n_2)$. The second is termed by Helmholtz the *difference tone*, and the third the *summation tone*. The amplitudes of

these tones are proportional to the products of a and b multiplied by λ or μ . These combination tones will in turn react on the pressure and produce new combination tones with the original tones, or with each other, and such tones may be termed of the second, third, &c., order. It is evident that we may have tones of frequency

$$hn_1 \quad kn_2 \quad hn_1 - kn_2 \quad hn_1 + kn_2,$$

where h and k are any integers. But inasmuch as the successive orders are proportional to $\lambda \lambda^2 \lambda^3$, or $\mu \mu^2 \mu^3$, and λ and μ are small, they are of rapidly decreasing importance, and it is not certain that any beyond those in equation (35) correspond to our actual sensations. The combination tones thus produced in the source should have a physical existence in the air, and the amplitudes of those represented in (35) should be of the same order. The conditions assumed in this investigation are probably nearly realized in a harmonium and in a double siren of the form used by Helmholtz, and in these cases there can be no doubt that actual objective tones are produced, for they may be detected by the aid of resonators of the frequency of the tone sought for. If the tones had no existence outside the ear then resonators would not increase their loudness. There is not much difficulty in detecting the difference tone by a resonator if it is held, say, close to the reeds of a harmonium, and Helmholtz succeeded in detecting the summation tone by the aid of a resonator. Further, Rücker and Edser, using a siren as source, have succeeded in making a fork of the appropriate pitch respond to both difference and summation tones (*Phil. Mag.*, 1895, 39, p. 341). But there is no doubt that it is very difficult to detect the summation tone by the ear, and many workers have doubted the possibility, notwithstanding the evidence of such an observer as Helmholtz. Probably the fact noted by Mayer (*Phil. Mag.*, 1878, 2, p. 500, or Rayleigh, *Sound*, § 386) that sounds of considerable intensity when heard by themselves are liable to be completely obliterated by graver sounds of sufficient force goes far to explain this, for the summation tones are of course always accompanied by such graver sounds.

2. The second mode of production of combination tones, by the mechanism of the receiver, is discussed by Helmholtz (*Sensations of Tone*, App. xii.) and Rayleigh (*Sound*, i. § 68). It depends on the restoring force due to the displacement of the receiver not being accurately proportional to the displacement. This want of proportionality will have a periodicity, that of the impinging waves, and so will produce vibrations just as does the variation of pressure in the case last investigated. We may see how this occurs by supposing that the restoring force of the receiving mechanism is represented by $\lambda x + \mu x^2$, where x is the displacement and μx^2 is very small. Let an external force F act on the system, and for simplicity suppose its period is so great compared with that of the mechanism that we may take it as practically in equilibrium with the restoring force. Then $F = \lambda x + \mu x^2$. Now μx^2 is very small compared with λx , so that x is nearly equal to F/λ , and as an approximation, $F = \lambda x + \mu F^2/\lambda^2$, or $x = F/\lambda - \mu F^2/\lambda^3$. Suppose now that $F = a \sin 2\pi n_1 t + b \sin 2\pi n_2 t$, the second term will evidently produce a series of combination tones of periodicities $2n_1$, $2n_2$, $n_1 - n_2$, and $n_1 + n_2$, as in the first method. There can be no doubt that the ear is an unsymmetrical vibrator, and that it makes combination tones, in some such way as is here indicated, out of two pure tones. Probably in most cases the combination tones which we hear are thus made, and possibly, too, the tones detected by Koenig, and by him named "beat-tones." He found that if two tones of frequencies p and q are sounded, and if q lies between Np and $(N+1)p$, then a tone of frequency either $(N+1)p - q$, or of frequency $q - Np$, is heard. The difficulty in Helmholtz's theory is to account for the audibility of such beat tones when they are of a higher order than the first. Rücker and Edser quite failed to detect their external existence, so that apparently they are not produced in the source. If we are to assume that the tones received by the ear are pure and free from partials, the loudness of the beat-tones would appear to show that Helmholtz's theory is not a complete account.

3. The third mode of production of combination tones, the production in the medium itself, follows from the varying velocity of different parts of the wave, as investigated at the beginning of this article. It is easily shown that after a time we shall have to superpose on the original displacement a displacement proportional to the square of the particle velocity, and this will introduce just the same set of combination tones. But probably in practice there is not a sufficient interval between source and hearer for these tones to grow into any importance, and they can at most be only a small addition to those formed in the source or the ear.

BIBLIOGRAPHY.—For the history of experimental and theoretical acoustics see F. Rosenberger, *Geschichte der Physik* (1882-1890); J. C. Poggendorff, *Geschichte der Physik* (1879); and E. Gerland and F. Traummüller, *Geschichte der physikalischen Experimentierkunst* (1899). The standard treatise on the mathematical theory is Lord Rayleigh's *Theory of Sound* (2nd ed., 1894); this work also contains an account of experimental verifications. The same author's *Scientific Papers* contains many experimental and mathematical contributions to the science. H. von Helmholtz treats the theoretical aspects of sound in his *Vorlesungen über die mathematischen*

Principien der Akustik (1898), and the physiological and psychical aspects in his *Die Lehre von den Tonempfindungen* (1st ed., 1863; 5th ed., 1896), English translation by A. J. Ellis, *On the Sensations of Tone* (1885). Sedley Taylor, *Sound and Music* (1882), contains a simple and excellent account of Helmholtz's theory of consonance and dissonance. R. Koenig, *Quelques expériences d'acoustique* (1882) describes apparatus and experiments, intended to show, in opposition to Helmholtz, that beats coalesce into tones, and also that the quality of a note is affected by alteration of phase of one of its component overtones relative to the phase of the fundamental. Lamb, *The Dynamical Theory of Sound* (1910), is intended as a stepping-stone to the study of the writings of Helmholtz and Rayleigh. Barton, *A Text-Book on Sound* (1908), aims to provide students with a text-book on sound, embracing both its experimental and theoretical aspects. J. H. Poynting and J. J. Thomson, *Sound* (5th ed., 1909), contains a descriptive account of the chief phenomena, and an elementary mathematical treatment. John Tyndall, *Sound* (5th ed., 1893), originally delivered as lectures, treats the subject descriptively, and is illustrated by a large number of excellent experiments. Good general accounts are given in J. L. G. Violle, *Cours de physique*, tome ii., "Acoustique"; A. Winkelmann, *Handbuch der Physik*, Band ii., "Akustik"; Müller-Pouillet, *Lehrbuch der Physik* (1907), ii. 1; L. A. Zellner, *Vorträge über Akustik* (1892), pt. 1, physical; pt. 2, physiological; R. Klimpert, *Lehrbuch der Akustik* (1904-1907); A. Wüllner, *Lehrbuch der Experimentalphysik* (1907), 6th ed., vol. i.; and C. L. Barnes, *Practical Acoustics* (1898), treats the subject experimentally. (J. H. P.)

SOUND, THE (Danish *Oresund*), the easternmost of the straits giving entrance to the Baltic Sea from the Cattegat, between the Danish island of Zealand and Sweden. Its extreme length reckoned from the promontory of Kullen to that of Falsterbo, both on the Swedish shore, is 70 m. Its narrowest point is between Helsingör in Denmark and Helsingborg in Sweden, which are 3 m. apart. Its extreme width, 30 m., is towards the south, where Kjöge Bay indents the coast of Zealand. Three islands lie in it—Hven, belonging to Sweden, and Saltholm and Amager (which is separated from Zealand by a narrow channel at Copenhagen), belonging to Denmark. The strait between Amager and Saltholm is called Drogden, and is followed by the larger vessels passing through the Sound. The extreme depth of the Sound is about 14 fathoms. Navigation is open in winter, though three instances are recorded of the Sound being frozen completely over: in 1306, 1830 and 1836. From the 15th century Denmark levied "Sound dues" on foreign vessels passing through the strait, the Hanse traders and certain others being exempt. In the 17th century quarrels arose on this matter between Denmark and the Netherlands and Sweden, while in modern times the powers found the dues irksome, and in 1843 and 1853 protests were made by the representatives of the United States of America, but Denmark based her right on immemorial custom, and adhered to it. In 1856 the matter came up in connexion with the renewal of the treaty of 1826 between the two countries; considerable tension resulted, and the possibility of reprisals by the United States against the Danish possessions in the West Indies was discussed. But the treaty was provisionally extended to the following year, and a conference in Copenhagen, at which most of the affected powers were represented, resulted in the remission of the dues from the 1st of April 1857, Denmark receiving a united compensation of 30,476,325 rix-dollars (equalling about £4,000,000), out of which the amount paid by the British government was £1,125,000. The annual income accruing to Denmark from the dues during the ten previous years had been about 2,500,000 rix-dollars.

SOUNDING (for derivation see **SOUND** above), the term used for measuring the depth of water (and so, figuratively, of anything). The process of ascertaining the depth of the sea has been practised from very early times for purposes of navigation, but it is only since the introduction of submarine telegraphy that extensive efforts have been made to obtain a complete knowledge of the contour of the ocean-bed (see **OCEAN**).

The operation of sounding is readily performed in shallow water by letting down a weight or "lead" attached to a cord, which is marked off into fathoms by pieces of leather, rag and twine. The bottom of the weight usually presents a hollow, which is filled with tallow, so that a portion of the material from the bottom may be brought up and give an indication of its nature as well as an assurance that it has really been touched.

For depths over 20 fathoms sounding machines are often employed, and for deep soundings they are practically indispensable. In them wire, the use of which for this purpose was introduced by Sir William Thomson (Lord Kelvin), has entirely superseded hemp gear. Its smooth surface and minute section, reducing friction to a minimum, give a rapidity of descent of about 100 fathoms per minute, and this velocity is not materially diminished even at great depths. Reeling in may be accomplished at nearly the same rate. Soundings are thus obtained with a degree of accuracy not formerly possible. The apparatus is light, compact and automatic in its action. Soundings with wire can be carried out at night with the same facility as in daytime, and in almost any circumstances of wind and weather short of a strong gale, against which the ship could not steam or face the sea. A sounding of 1000 fathoms may be obtained in twenty-five minutes from the time the weight is lowered to the time the order is given to put the ship on her course, or in half that time if sounding from astern and going ahead on getting bottom; 2000 fathoms will require forty-five minutes and 3000 fathoms seventy-five minutes. Beyond that depth, much greater caution being required, the time occupied is correspondingly increased, and reeling in must then be done very deliberately. A sounding of 5260 fathoms was obtained near the island of Guam by the U.S. cable-surveying ship "Nero." Soundings at such depths may occupy as long as five or six hours.

Among the sounding machines in general use the Lucas carries nearly 6000 fathoms of 20-gauge wire, and is fitted with two brakes—one a screw brake for holding the reel when required, the other an automatic brake for stopping the reel when the weights strike the bottom. A guider for the purpose of winding the wire uniformly on to the reel is also attached, and is worked by a small handle. After leaving the reel the wire passes over a registering wheel, the dial of which indicates the amount of wire run out. Similar machines of smaller size are supplied for use in boats. The large machine is represented in fig. 1.

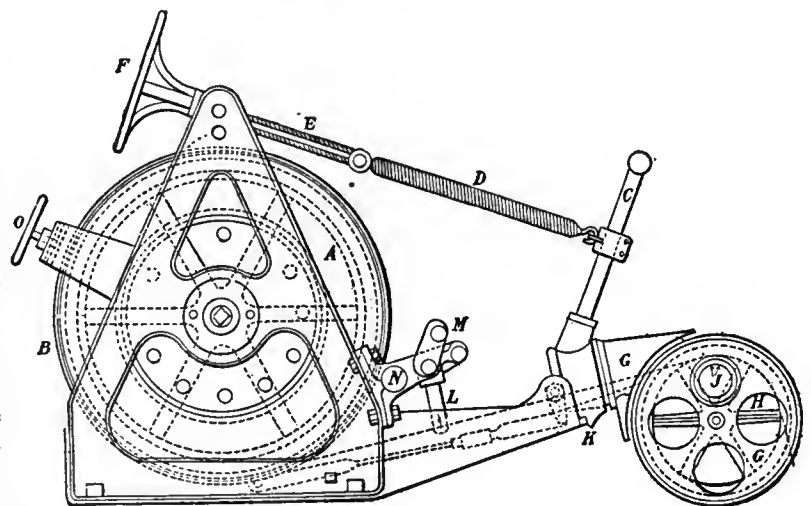

(From Wharton's *Hydrographic Survey*.)

FIG. 1.—Lucas Machine.

- | | |
|----------------------|-------------------------------|
| A, Reel or drum. | H, Measuring wheel. |
| B, Brake. | J, Indicator. |
| C, Brake lever. | K, Stop. |
| D, Springs. | L, Wire guiding roller. |
| E, Regulating screw. | M, Handle for working roller. |
| F, Hand wheel. | N, Bolt. |
| G, Swivelling frame. | O, Screw Brake. |

Heaving in is accomplished by means of a hemp "swifter" or driving belt, which conveys the motion of the drum of a donkey engine to the drum carrying the wire of the sounding machine. It being impracticable to regulate the speed of the engine by hand according to the heave of the ship, in order to obviate the sudden and excessive strains on the wire so caused, an ingenious mechanical arrangement has been fitted by which frictional disks, geared by cog-wheels and capable of adjustment are interposed on the axle connecting the grooved wheel actuated by the hemp swifter and the revolving drum carrying the wire. By this arrangement the latter can be controlled as desired, both in speed and direction of motion, by means of a lever regulating the strap on the frictional disks, which may be set by experiment to act at any given tension of the wire. As the tension approaches this limit, the velocity of revolution of the drum is automatically checked; and if the tension further increases, the motion of the drum is actually reversed, thus causing the wire to run out, until the tension is relieved sufficiently to allow the frictional disks again to act in the direction of heaving in. The drum may be stopped instantly by moving the lever in the proper direction to throw the apparatus out of gear.

Galvanized-steel wire of 20-gauge and 21-gauge is supplied on drums in lengths of 5000 fathoms. The 20-gauge wire when new has a breaking strain of 240 lb, and the smaller wire 190 lb. The large machines will hold sufficient quantity of the larger wire for the deepest soundings; there is therefore no longer any necessity for the smaller wire, and its use is not recommended. The zinc wears off to a considerable extent with constant use; it is necessary to pass the wire through an oily wad whenever soundings are suspended for a time, and the surface layers on the drum should be kept well coated with oil and covered over with oily waste. A fortnight's continuous use is about the limit to the trustworthiness of any piece of wire; no amount of care will prevent it from becoming brittle; and directly it can be snapped by twisting in the hand, it should be condemned and passed on to the boats' machines. A magnifying glass will assist in examining its condition. Taut and even winding on the reel from the drum is most important; otherwise, when heaving up after a sounding, the strain forces each layer as it comes in to sink down amongst the previous layers loosely reeled on, with the result that at the next sounding slack turns will suddenly develop on running out, to the great risk of the wire. The wire is liable to cut grooves in the interior of the swivelling frame; a file must constantly be applied to smooth these down, or they will rip the splices. A roller of hard steel, underneath which wire passes, and which placed in rear of the swivelling frame, obviates this to a great extent.

Splices are made about 5 ft. in length, one wire being laid round the other in a long spiral of about one turn per inch. A seizing of fine wire is laid over each end and for 2 or 3 in. up the splice, no end being allowed to project, and solder is then applied the whole length of the splice. Three more seizings should be placed at intervals. Splices are the weakest parts of the wire, and their multiplication is to be avoided. They should be frequently examined and their position noted, so that in heaving in they may be eased round the wheel with the guider nearly in the centre, to avoid tearing.

Under 1000 fathoms a lead of 30 to 40 lb weight can be recovered, and no detaching rod is necessary. At a little less **Sounding** to the wire, when sounding from astern up to that **Rods and** depth, the ship may go ahead directly bottom is **Sinkers.** struck, increasing speed as the wire comes in; the great saving in time thus effected will often justify the increased risk of parting the wire. For greater depths the "Driver rod" is the best detaching apparatus for slipping the sinkers; its construction is easier than that of the "Baillie rod," and with a piece of gas piping cut to the proper length the ship's blacksmith can make one in a day. Both rods are fitted with tubes to bring up a specimen of the bottom, and the same sinkers fit them both.

The "Driver rod" is shown in fig. 2. ABC is a tube about 2 ft. in length, fitted at the top with a flap valve D, working on a hinge at E. The lower part of the tube C screws on and off, and contains a double flap valve to retain the bottom specimen. The sinkers WW, each 25 lb in weight, conical in form, and pierced with a cylindrical hole through which the Driver rod passes loosely, are slung by wire or cod line secured to a flat ring or grummet shown at L and passing over the stud G. A stud K on each side of the tube fits loosely into the slot H in the lower part of the slipping lever MH. The weight of the apparatus being taken by the sounding wire, the sinkers remain suspended; but on striking the bottom, the wire slackens, and the weight of the sinkers drags the slipping lever down till the stud K bears against the upper part of the slot H. By this action the point M of the slipping lever is brought to bear against the upper end of the standard EF, being thereby forced outward sufficiently to ensure that the weight

acting at the point G will tilt the slipping lever right over, and thus disengage the sling. The tube being then drawn up, the sinkers are left behind. In descending, the valves at top and bottom, opening upwards, allow the water to pass through freely; but on drawing up they are closed, thus retaining the plug of mud with which the tube is filled. For water under 2000 fathoms two conical weights are sufficient. In deeper water a third cylindrical weight of 20 lb should be put between them. It is important to interpose a piece of hemp line, some 10 fathoms long, between the end of the wire (into which a thimble is seized) and the lead or rod. This tends to prevent the wire from kinking on the lead striking the bottom. A piece of sheet lead, about 2 lb in weight, wrapped round the hemp just below the junction, keeps the wire taut while the hemp slacks. Small brass screw stoppers, fitted with a hempen tail to secure to a cleat, hold the wire during the sounding if necessary to repair splices or clear slack turns. In heaving in the springs are replaced with a spring balance, by which the amount of strain is seen and the deck engine worked accordingly. A system of signals is required by day and by night, by which the officer superintending the sounding can control the helm, main engines and deck engine.

Method of Sounding.—The machine is placed on a projecting platform on the forecastle. An endless hemp swifter, led through blocks with large sheaves, connects the sounding machine and deck engine, and when heaving in is kept taut by a snatch block set up with a jigger. As the wire runs out, the regulating screw of the brake must be gradually screwed up, so as to increase the power of the brake in proportion to the amount of wire out. The regulating screw is marked for each 500 fathoms. In fairly smooth water the brake will at once act when the weight strikes the bottom and the reel stops. Under 3000 fathoms one spring only is sufficient, but beyond that depth two springs are required. If the ship is pitching heavily, the automatic brake must be assisted by the screw brake to ensure the reel not overrunning. The marks on the regulating screw are only intended as a guide; the real test is that the brake is just on the balance, so as to act when the strain lessens, which may be known by the swivelling frame being just lifted off the stop. As the wire weighs $7\frac{1}{2}$ lb for each 500 fathoms, the 500-fathoms mark on the screw should be at the position in which the screw has to sustain a weight of $7\frac{1}{2}$ lb; the 1000-fathoms mark, 15 lb; and so on. This can be tested and the marks verified.

Handling the Ship.—Sounding from forward enables the ship to be handled with greater ease to keep the wire up and down, and especially so in a tide-way; but in very heavy weather soundings may be obtained from a machine mounted over the stern, when it would be quite impossible to work on the forecastle. The spanker must be set with the sheet to windward, unless a strong weather tide renders it undesirable; the ship's head must be kept in a direction which is the resultant of the direction and force of the wind and current; and this is arrived at by altering the course while sounding, point by point, until the wire can be kept up and down by moving the engines slowly ahead as necessary. It should seldom, or never, be necessary to move the engines astern.

The temperature of the water is usually taken at intervals of 100 fathoms down to a depth of 1000 fathoms, and at closer intervals in the first 100 fathoms. If a second wire machine is available; the observations may be made from aft **Observations of** whilst the sounding is being taken forward. A 30-lb **Temperature.** sinker is attached to the end of the wire, and the registering thermometers are secured to the wire by the metal clips at the back of the cases, at the required intervals. To avoid heavy loss, not more than four thermometers should be on the wire at one time. When sounding a thermometer is usually attached to the line a short distance above the lead.

The primary object of the machine called the "submarine sentry" is to supply an automatic warning of the approach of a ship to shallow water: it has been instrumental in discovering many unsuspected banks in imperfectly surveyed waters. By means of a

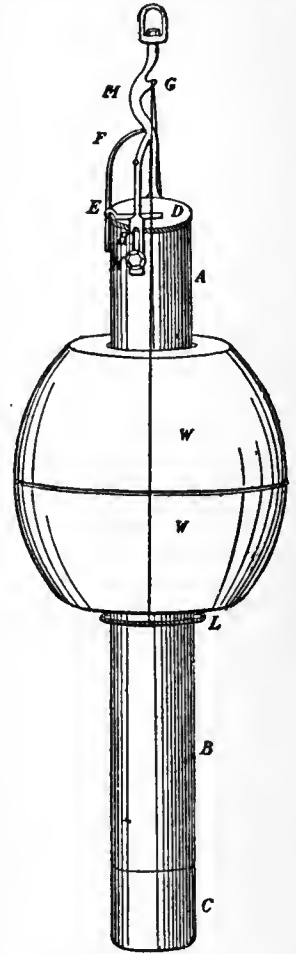

FIG. 2.—Driver Rod.

single stout wire the sinker, an inverted kite, called the "sentry," can be towed steadily for any length of time, at any required vertical depth down to 40 fathoms with the red kite and 30 fathoms with the black kite; should it strike the bottom, through the water shallowing to less than the set depth, it will at once free itself and rise to the surface, simultaneously sounding an alarm on board, and thus giving instant

Submarine Sentry.

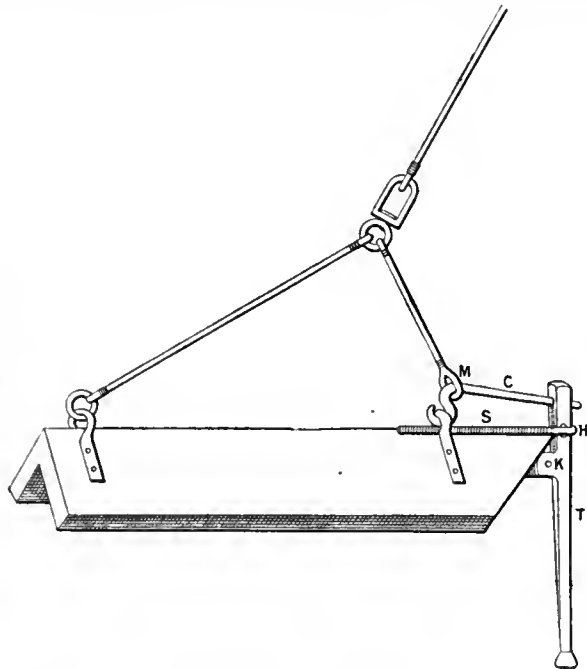

FIG. 3.—The Submarine Sentry.

warning. The vertical depth at which the sentry sets itself when a given length of wire is paid out is not changed by any variation of speed between 5 and 13 knots, and is read off on the graduated dial-plate on the winch. One set of graduations on the dial indicates the amount of wire out; the other two sets refer to the red and black kites respectively, and show the depth at which the sentry is towing. By this machine single soundings down to 40 fathoms can be taken at any time while the ship is under way. The sentry being let down slowly, the gong will indicate when the bottom is touched, and the dial corresponding to the kite used will show at once the vertical depth at the place where the sentry struck.

By removing the kite and substituting a lead, with atmospheric sounder or other automatic depth gauge, flying single soundings up to 100 fathoms can be obtained in the ordinary manner without stopping the ship. The winch is secured to the deck a short distance from the stern; the towing wire passes from the drum under a roller fairlead at the foot of the winch, thence through an iron block with sheave of large diameter, suspended from a short davit on the stern rail and secured to the sling of the sentry. The dial being set to zero with the sentry at the water's edge, the ship's speed is reduced to 8 or 9 knots, and the wire paid out freely until the kite is fairly in the water, when the brake should be applied steadily and without jerking, veering slowly until the required depth is attained, when the pawl is put on the ratchet wheel and the speed increased to 12 knots if desired when using the black kite or 10 knots with the red kite.

The kite in its position when being towed is indicated in fig. 3. The point of the catch C, passing through a thimble M in the short leg of the sling, is slipped into the hole at the top of trigger T, which is hinged at K and kept in its place by the spring S attached to the hook H. On the trigger striking the bottom the catch is released, the short leg of the sling slips off, and the sentry, which then rises to the surface, is left towing by the long leg. The winch is fitted with two handles for heaving in the wire; one gives great power and slow speed, and the other, acting on the drum spindle direct, winds in quickly. The wire supplied with the machine has a steady breaking strain of about 1000 lb. Using the black kite at a speed of 7 knots, the strain on the wire is about 150 lb, and at 10 knots about 300 lb. The red kite increases the strain largely. (A. M. F.*)

SOUSA, LUIZ DE [MANOEL DE SOUSA COUTINHO] (1555-1632), Portuguese monk and prose-writer, was born at Santarem, a member of the noble family of Sousa Coutinho. In 1576 he broke off his studies at Coimbra University to join the order of Malta, and shortly afterwards was captured at sea by Moorish pirates and taken prisoner to Argel, where he met Cervantes. A year later Manoel de Sousa Coutinho was ransomed, and landing

on the coast of Aragon passed through Valencia, where he made the acquaintance of the poet Jaime Falcão, who seems to have inspired him with a taste for study and a quiet life. The national disasters and family troubles increased this desire, which was confirmed when he returned to Portugal after the battle of Alcacer and had the sorrow of witnessing the Spanish invasion and the loss of his country's independence. Between 1584 and 1586 he married a noble lady, D. Magdalena de Vilhena, widow of D. John of Portugal, the son of the poet D. Manoel of Portugal, to whom Camoens had dedicated his seventh ode. Settling at Almada, on the Tagus opposite Lisbon, he divided his time between domestic affairs, literary studies and his military duties as colonel of a regiment. His patriotic dislike of an alien rule grew stronger as he saw Portugal exploited by her powerful partner, and it was ultimately brought to a head in 1599. In that year, to escape the pest that devastated Lisbon, the governors of the kingdom for Philip II. decided to move their quarters to his residence; thereupon, finding his protest against this arbitrary resolution unheeded, he set fire to his house, and to escape the consequences of his courageous act had to leave Portugal. Going to Madrid, he not only escaped any penalty, owing no doubt to his position and influence at the Spanish court, but was able to pursue his literary studies in peace and to publish the works of his friend Jaime Falcão (Madrid, 1600). Nothing is known of how he passed the next thirteen years, though there is a tradition that, at the instance of a brother resident in Panama, who held out the prospect of large commercial gains, he spent some time in America. It is said that fortune was unpropitious, and that this, together with the news of the death of his only child, D. Anna de Noronha, caused his return home about 1604. In 1613 he and his wife agreed to a separation, and he took the Dominican habit in the convent of Bemfica, while D. Magdalena entered the convent of the Sacramento at Alcantara. According to an old writer, the motive for their act was the news, brought by a pilgrim from Palestine that D. Magdalena's first husband had survived the battle of Alcacer, in which he was supposed to have fallen, and still lived; Garrett has immortalized the legend in his play *Frei Luiz de Sousa*. The story, however, deserves no credit, and a more natural explanation is that the pair took their resolution to leave the world for the cloister from motives of piety, though in the case of Manoel the captivity of his country and the loss of his daughter may have been contributory causes. He made his profession on the 8th of September 1614, and took the name by which he is known as a writer, Frei Luiz de Sousa. In 1616, on the death of Frei Luiz Cacegas, another notable Dominican who had collected materials for a history of the order and for a life of the famous archbishop of Braga, D. Frei Bartholomew of the Martyrs, the task of writing these books was confided to Frei Luiz. The *Life of the Archbishop* appeared in 1619, and the first part of the *Chronicle of St Dominic* in 1623, while the second and third parts appeared posthumously in 1662 and 1678; in addition he wrote, by order of the government, the *Annals of D. John III.*, which were published by Herculano in 1846. After a life of about nineteen years spent in religion, he died in 1632, leaving behind him a memory of strict observance and personal holiness.

The *Chronicle of St Dominic* and the *Life of the Archbishop* have the defect of most monastic writings—they relate for the most part only the good, and exaggerate it without scruple, and they admit all sorts of prodigies, so long as these tend to increase devotion. Briefly, these books are panegyrics, written for edification, and are not histories at all in the critical sense of the word. Their order and arrangement, however, are admirable, and the lucid, polished style, purity of diction, and simple, vivid descriptions, entitle Frei Luiz de Sousa to rank as a great prose-writer. His metaphors are well chosen, and he employs on appropriate occasions familiar terms and locutions, and makes full use of those charming diminutives in which the Portuguese language is rich. His prose is characterized by elegance, sweetness and strength, and is remarkably free from the affectations and false rhetoric that characterized the age. In addition to his other gifts, Frei Luiz de Sousa was a good Latin poet. There are many editions of the *Life of the Archbishop*, and it appeared in French (Paris, 1663, 1679 and 1825), in Italian (Rome, 1727-1728), in Spanish (Madrid, 1645 and 1727) and in English

(London, 1890). The *Historia de S. Domingos* may be read in a modern edition (6 vols., Lisbon, 1866).

AUTHORITIES.—*Obras de D. Francisco Alexandre Lobo*, ii. 61–171; Innocencio da Silva, *Diccionario bibliographico portuguez*, v. 327, xvi. 72; Dr Sousa Viterbo, *Manoel de Sousa Coutinho* (Lisbon, 1902). (E. PR.)

SOUSLIK, or **SUSLIK**, the vernacular name of a European burrowing rodent mammal, nearly allied to the marmots, but of much smaller size and of more slender and squirrel-like build (see **RODENTIA**). The species, *Spermophilus* (or *Citillus*) *citillus*, is rather smaller than an ordinary squirrel, with minute ears, and the tail reduced to a stump of less than an inch in length. The general colour of the upper parts is yellowish grey, with or without a rusty tinge, which is, however, always noticeable on the head; while the underparts are lighter. The range of this species embraces south-east Europe, from southern Germany, Austria and Hungary to the south of Russia. Farther east it is replaced by more or less nearly allied species; while other species extend the range of the genus across central and northern Asia, and thence, on the other side of Bering Strait, all through North America, where these rodents are commonly known as gophers. Many of the species have medium or even long tails, while some are nearly double the size of the typical representative of the group. All, however, have large cheek-pouches, whence the name of pouched marmots, by which they are sometimes called; and they have the first front-toe rudimentary, as in marmots. They are divided into several subgeneric groups. One of the most striking American species is the striped gopher, *S. (Ictidomys) tridecemlineatus*, which is marked on each side with seven yellow stripes, between which are rows of yellow spots on a dark ground. The common souslik lives in dry, treeless plains, especially on sandy or clayey soil, and is never found either in forests or on swampy ground. It forms burrows, often 6 or 8 ft. deep, in which food is stored up and the winter sleep takes place. Each burrow has but one entrance, which is closed up when winter approaches; a second hole, however, being previously driven from the sleeping place to within a short distance of the surface of the ground. This second hole is opened the next year, and used as the ordinary entrance, so that the number of closed up holes round a burrow gives an indication of the length of time that it has been occupied. Sousliks feed on roots, seeds and berries, and occasionally on animal food, preying on eggs, small birds and mice. They bring forth in the spring from four to eight young ones, which, if taken early, may be easily tamed. Sousliks are eaten by the inhabitants of the Russian steppes, who consider their flesh an especial delicacy. (R. L. *)

SOUTANE, the French term adopted into English for a cassock especially used for the general daily dress worn by the secular Roman clergy in France, Italy, Spain and Portugal. The Med. Lat. *subtaneus*, adapted in O. Fr. as *sotane*, in Span. and Ital. as *solana*, and Port. as *sotaina*, meant an under-skirt, and is formed from *subtus*, beneath, *sub*, under. (See **CASSOCK**.)

SOUTH, ROBERT (1634–1716), English divine, was born at Hackney, Middlesex, in September 1634. He was educated at Westminster school and at Christ Church, Oxford. Before taking orders in 1658 he was in the habit of preaching as the champion of Calvinism against Socinianism and Arminianism. He also at this time showed a leaning to Presbyterianism, but on the approach of the Restoration his views on church government underwent a change; indeed, he was always regarded as a time-server, though by no means a self-seeker. On the 10th of August 1660 he was chosen public orator of the university, and in 1661 domestic chaplain to Lord Clarendon. In March 1663 he was made prebendary of Westminster, and shortly afterwards he received from his university the degree of D.D. In 1667 he became chaplain to the duke of York. He was a zealous advocate of the doctrine of passive obedience, and strongly opposed the Toleration Act, declaiming in unmeasured terms against the various Nonconformist sects. In 1676 he was appointed chaplain to Lawrence Hyde (afterwards earl of Rochester), ambassador-extraordinary to the king of Poland, and of his visit he sent an interesting account to Edward Pocke

in a letter, dated Dantzic, 16th December, 1677, which was printed along with South's *Posthumous Works* in 1717. In 1678 he was presented to the rectory of Islip, Oxfordshire. Owing, it is said, to a personal grudge, South in 1693 published with transparent anonymity *Animadversions on Dr Sherlock's Book, entitled a Vindication of the Holy and Ever Blessed Trinity*, in which the views of William Sherlock (*q.v.*) were attacked with much sarcastic bitterness. Sherlock, in answer, published a *Defence* in 1694, to which South replied in *Tritheism Charged upon Dr Sherlock's New Notion of the Trinity, and the Charge Made Good*. The controversy was carried by the rival parties into the pulpit, and occasioned such keen feeling that the king interposed to stop it. During the greater part of the reign of Anne South remained comparatively quiet, but in 1710 he ranked himself among the partisans of Sacheverell. He declined the see of Rochester and the deanery of Westminster in 1713. He died on the 8th of July 1716, and was buried in Westminster Abbey.

South had a vigorous style and his sermons were marked by homely and humorous appeal. His wit generally inclines towards sarcasm, and it was probably the knowledge of his quarrelsome temperament that prevented his promotion to a bishopric. He was noted for the extent of his charities. He published a large number of single sermons, and they appeared in a collected form in 1692 in six volumes, reaching a second edition in his lifetime in 1715. There have been several later issues; one in two volumes, with a memoir (Bohn, 1845). His *Opera posthuma latina*, including his will, his Latin poems, and his orations while public orator, with memoirs of his life, appeared in 1717. An edition of his works in 7 vols. was published at Oxford in 1823, another in 5 vols. in 1842. See also W. C. Lake, *Classic Preachers of the English Church* (1st series, 1877). The contemporary notice of South by Anthony Wood in his *Athenae* is strongly hostile, said to be due to a jest made by South at Wood's expense.

SOUTH AFRICA. As a geographical unit South Africa is usually held to be that part of the continent south of the middle course of the Zambezi. The present article (1) deals with that part of Africa as a whole, (2) outlines the constitution of the British possessions forming the Union of South Africa, and (3) summarizes the history of the country from the time of its discovery by Europeans.

I.—GENERAL FEATURES

In the geographical sense stated South Africa lies between 16° and 35° S. and 12° and 36° E., narrows from 1600 m. from west to east along its northern border to some 600 m. of coast facing south. Its greatest length south-west to north-east is also about 1600 m. It has an area of about 1,333,000 sq. m. It comprises the Union of South Africa (*i.e.* the provinces of the Cape of Good Hope, Natal, with Zululand, the Orange Free State and the Transvaal); Basutoland, Bechuanaland, Swaziland and Southern Rhodesia, all British possessions; German South-West Africa, and the southern part of Portuguese East Africa. By some writers Northern Rhodesia is included in South Africa, but that district belongs more accurately to the central portion of the continent. Other writers confine the term to the British possessions south of the Zambezi, but in this case British South Africa is the proper designation. South African standard time, adopted in 1903, is that of 30° E., or two hours in advance of Greenwich.

Physical Features.—There is a marked uniformity in physical features throughout South Africa. The coast line, from the mouth of the Kunene on the west to the delta of the Zambezi on the east, is little indented and contains only two sheltered natural harbours of any size—Saldanha Bay on the west and Delagoa Bay on the east. At Port Natal, however, the removal of the sand bar at its entrance has made available a third magnificent harbour, while at Table Bay (Cape Town) and at other places ports have been constructed. South Africa presents, however, a solid land mass without peninsulas of any size or any large islands off its coasts. Moreover, behind the low-lying coastlands, which extend in general from 50 to 250 m. inland, rise ramparts of hills shutting off the interior. This conformation of the country has been a powerful influence in determining its history and development. Here and there the mountains,

which run in lines parallel to the coast, approach close to the sea, as at Table Bay. In the south-east, in the Drakensberg, they attain heights of 10,000 to 11,000 ft., elsewhere the highest points are between 8000 and 9000 ft. They form terrace-like steps leading to a vast tableland (covering about 900,000 sq. m.) with a mean elevation of 4000 ft., the highest part of the plateau—the High Veld of the Transvaal—being fully 6000 ft. above the sea. In its southern part the plateau has a general tilt to the west, in the north it tilts eastward. This tilt determines the hydrographical system. In the south the drainage is to the Atlantic, chiefly through the Orange River, in the north to the Indian Ocean through the Zambezi, Limpopo and other streams. A large number of smaller rivers rise on the outer slopes of the mountain ramparts and flow direct to the sea. In consequence of their great slope and the intermittent supply of water the rivers—except the Zambezi—are unnavigable save for a few miles from their mouths. The central part of the interior plateau, covering some 120,000 sq. m., is arid and is known as the Kalahari Desert. The western region, both plateau and coastlands, specially that part north of the Orange, is largely semi or wholly desert, while in the Cape province the terrace lands below the interior plateau are likewise arid, as is signified by their Hottentot name *karusa* (Karoo). The southern and eastern coastlands, owing to different climatic conditions (see *infra*) are very fertile.

The geological structure is remarkably uniform, the plateau consisting mainly of sedimentary deposits resting on crystalline rocks. The Karroo system (sandstones and marls) covers immense areas (see AFRICA, § *Geology*). Intrusive dikes—locally known as ironstone—by preventing erosion are often the cause of the flat-topped hills which are a common feature of the landscape. The Witwatersrand series of the Transvaal includes auriferous conglomerates which have been worked since 1886 and constitute the richest gold-mines in the world. The diamondiferous areas at Kimberley and in the Pretoria district are likewise the richest known. Coal beds are widely distributed in the eastern districts while there are large copper deposits in the west, both at the Cape and in German territory.

Climate.—The general characteristics of the climate are determined more by the physical conformation of the land than its proximity to the equator. The eastern escarpments (the Drakensberg, &c.) of the plateau intercept the rain-bearing winds from the Indian Ocean, so that over the greater part of the interior the rainfall is slight (5 to 24 in.). This, added to the elevation of the land, makes the climate in general dry, bracing and suitable for Europeans, notwithstanding that the northern part is within the tropics. Temperature is high, the mean yearly average lying between 60° and 70° F. Only along the south-eastern coast and in some of the river valleys is the climate of a markedly tropical character; here the rainfall rises to 50 in. a year and the coast is washed by the warm Mozambique current. The Cape peninsula and the western coast receive the cold currents from the Antarctic regions. Except in southern and western Cape Colony and along the Atlantic coast, summer is the rainy season.

Flora and Fauna.—In consequence of the deficient rainfall over the greater part of the country the flora is not luxuriant and there are no large forests. Coarse grasses are the characteristic vegetation of the tableland. On the plains where grasses cannot find sufficient moisture their place is taken by "bush," composed mainly of stunted mimosas, acacias, euphorbia, wild pomegranate, bitter aloes and herbaceous plants. Forest patches are found in the kloofs and seaward sides of the mountains; willows often border the water-courses; heaths and bulbous plants are common in some areas. In the semi-tropical regions south-east of the Drakensberg, *i.e.* the coastlands of Natal and Portuguese East Africa, the vegetation is abundant, and mangroves, palms, baobab and bombax trees flourish. Here, and also in the upper Limpopo valley, cotton, tobacco, and rubber vines are found. Among the timber trees are species of pine, cedar, ebony, ironwood, stinkwood and sneezewood. Flowering plants include numerous species of terrestrial orchids, the so-called arum lily (*Richardia Africana*), common in low-lying moist land, and the white everlasting flower, found abundantly in some regions of Cape Colony. Of non-indigenous flora are the oak, poplar, bluegum, the Australian wattle, the vine, and almost every variety of fruit tree and European vegetables. In suitable regions tea, coffee, sugar and rice, as well as tobacco and cotton, are cultivated. In the western districts of the Cape viticulture is largely followed. The cereal most grown is maize (known in South Africa as mealies); kaffir corn, wheat, barley and oats are also largely cultivated. The

soil is everywhere rich, but the lack of perennial water and the absence of irrigation works on a large scale retards agriculture. Most of the veld is divided into huge farms devoted to the rearing of cattle, sheep, goats and horses. On the Karroo are numerous ostrich farms. Lucerne is very largely grown as fodder for the cattle.

The native fauna was formerly very rich in big game, a fact sufficiently testified by the names given by the early European settlers to mountains and streams. The lion, elephant, rhinoceros, hippopotamus, giraffe, buffalo, quagga, zebra and other large animals were, however, during the 18th and 19th centuries driven out of the more southern regions (though a few elephants and buffaloes, now carefully preserved, are still found at the Cape), the quagga being totally exterminated. In the Kalahari and in the eastern lowlands (from Zululand to the Zambezi delta) most of these animals are still found, as well as the eland, wildebeest and gemsbok. The leopard (called a tiger in South Africa) is still fairly common in all mountainous regions. Spotted hyenas and jackals are also numerous. The kudu is now the most common of the larger antelopes, the duiker and klipspringer are among the smaller antelopes still existing in large numbers. Baboons are common in some districts. Birds include the ostrich, great kori bustard, the eagle, vulture, hawk and crane, francolin, golden cuckoo, lorie, scarlet and yellow finches, kingfishers, parrots (in the eastern regions), pelicans and flamingoes. There are thirty varieties of snakes. Locusts are conspicuous among the common plagues of the country. In Rhodesia and on the east coast the tsetse fly is found and termites are widely distributed.

Inhabitants.—The aborigines of South Africa are represented by the Bushmen and Hottentots, now found in any racial purity only in the Kalahari and in the southern part of German South-West Africa. All the other natives, popularly called Kaffirs, are members of the Bantu-negroid family, of whom they here form three distinct branches: (1) the *Zulu-Xosas*, originally confined to the south-east seaboard between Delagoa Bay and the Great Fish River, but later (19th century) spread by conquest over Gazaland, parts of the Transvaal, and Rhodesia (Matabeleland), (2) the *Bechuanas*, with the kindred *Basutos*, on the continental plateau from the Orange to the Zambezi, and ranging westwards over the Kalahari desert and the Lake Ngami region; (3) the *Ova-Herero* and *Ova-Mpo*, confined to German South-West Africa between Walfish Bay and the Kunene River.

All these mixed Bantu peoples are immigrants at various periods from beyond the Zambezi. The Bechuanas, who occupy by far the largest domain, and preserve the totemic tribal system, were probably the first arrivals from the north or the north-sea coastlands. As early, probably, as the 8th century A.D. Arabs had formed a settlement on the coast at Sofala, 130 m. south of the mouth of the Zambezi, but they got no further south nor do they appear to have penetrated inland, though they traded for gold and other articles with the inhabitants of the northern part of the plateau—the builders of the zimbabwes and other ruins in what is now Rhodesia (*q.v.*) The Asiatic inhabitants of South Africa of the present day are mainly Indian

Population (1904).

	Area in sq. m.	White.	Coloured.	Total.
British South Africa:				
Union of South Africa:				
Cape of Good Hope	276,995	579,741	1,830,063	2,409,804
Natal (with Zululand)	35,371	97,109	1,011,645	1,108,754
Orange Free State	50,392	142,679	244,636	387,315
Transvaal	111,196	297,277	972,674	1,269,951
Southern Rhodesia	148,575	12,623	600,000 ¹	612,623
Basutoland	10,293	895	347,953	348,848
Bechuanaland Protectorate	225,000 ¹	1,004	119,772	120,776
Swaziland	6,536	898	84,586	85,484
Total British	864,358	1,132,226	5,211,329	6,343,555
German S.W. Africa	322,450	7,110 ²	200,000 ¹	207,110
Portuguese East Africa (southern part of)	145,000 ¹	10,000 ¹	1,700,000 ¹	1,710,000
Total South Africa	1,331,808	1,149,336	7,111,329	8,260,665

¹ Estimates.

² 1907.

coolies brought to Natal since 1860. The white races represented are mainly Dutch and British; colonization by European races dating from the 17th century. There are a few thousand Germans and Portuguese, chiefly in the territories belonging to their respective countries. The table on p. 464 shows the inhabitants, white and coloured, in the different territories into which South Africa is divided, and also the area of these territories.

It will be seen that the population is sparse, less than 6½ persons per square mile. (Excluding the Bechuanaland Protectorate and German South-West Africa, which contain very large desert areas, the population is slightly over 7 per square mile.) In British South Africa the coloured races are nearly five times as numerous as the whites. The great majority of the coloured inhabitants are Bantus of pure blood, but the total coloured population includes in the Cape province 298,334 persons of mixed blood (chiefly white and Hottentot) and in Natal 100,918 Asiatics. Save in the German colony the official returns do not discriminate between the nationality of the white inhabitants. Those of British and Dutch origin are probably about equal in numbers, but a very large proportion of the British inhabitants live in the towns, the country population being in most districts predominantly Dutch. The chief cities are Cape Town (pop. 1904, 77,668), Port Elizabeth (32,959), East London (25,220) and Kimberley (34,331) in the Cape province; Durban (67,847) in Natal; Johannesburg (155,642) and Pretoria (36,839) in the Transvaal; and Bloemfontein (33,883) in the Orange Free State. Salisbury and Bulawayo are the chief towns in Southern Rhodesia. The only town of any size outside the British possession is Lourenço Marques (Pop. 1907, 9849) in Delagoa Bay.

Economic Condition.—Originally regarded by Europeans merely as a convenient dépôt for ships on their way to India, the wealth of South Africa for long consisted in its agricultural and pastoral resources. Mealies and wheat were the principal crops. Wool, mohair and ostrich feathers were the chief exports, the only mineral exported being copper (from the Namaqualand mines). The opening up of the diamond mines at Kimberley (1870) followed (1886) by the discovery of the Witwatersrand goldfields completely revolutionized the economic situation and profoundly modified the history of the country. They led, among other things, to the improvement of ports and the building of railways, so that by the close of the first decade of the 20th century the reproach of inaccessibility from which South Africa had suffered was no longer true. From the seaports of Cape Town, Port Elizabeth, East London, Durban, Lourenço Marques and Beira railway lines run to Kimberley, Bloemfontein, Johannesburg and Pretoria, while a trunk line extends north from Kimberley through Rhodesia (in which gold mining began on an extensive scale in 1898) and across the Zambezi below the Victoria Falls into the Congo basin, where it serves the Katanga mineral area. The distance from Cape Town to Katanga is over 2100 miles. The German territory is also provided with railways, intended eventually to link with the British systems. The standard gauge is 3 ft. 6 in. and in 1910 some 12,000 m. of railway were open. In nearly every instance the railways are state owned. While gold and diamond mining continue the greatest of South African industries other sources of wealth have been added. In the Cape, Natal and the Transvaal coal mining is largely developed; in the Transvaal and the Cape tobacco is grown extensively; sugar, tea and other tropical and sub-tropical produce are largely cultivated in Natal and the Portuguese territory, and, since 1905, mealies have become an important article of export. There are few manufactures; among the chief are the making of wine and brandy in the Cape province, and flour-milling. Cattle and mealies constitute the most valuable possessions of the natives. The imports are of a general nature, textiles and food-stuffs being the most important.

Irrigation.—The scanty rainfall in many parts of South Africa and its unequal distribution necessitates a system of artificial irrigation unless much of the land be allowed to remain uncultivated. But in many regions the soil is deficient in phosphates and nitrates, and large irrigation works can be profitable only in districts where the soil is exceptionally fertile. Before 1877 little was done to make use of the water resources of the country. In that year the Cape legislature provided for the constitution of irrigation boards. Later boring operations were undertaken by the government, and the advice of engineers acquainted with Egyptian and Indian irrigation works sought. A report was drawn up by Sir (then Mr) Wm. Willcocks in 1901 in which he estimated that there were in the Cape, Orange Free State and the Transvaal, 3,000,000 acres which could be brought under irrigation at a cost of about £30,000,000. The value of the land, in its arid condition almost nil, when irrigated he placed at some £100,000,000. None of the South African governments was, however, then in a position to undertake large works. At the Cape the census of 1904 gave 415,688 acres as the area under irrigation, an increase of 105,827 acres since 1891. In the Robertson district a canal (completed in 1904) 21 m. long took off from the Breede River and fertilized a large area, with the result that Robertson ranks as the second richest district in the province. Over the

Karoo and other arid regions some 10,000 boreholes had been sunk to depths varying from 50 to 500 ft., their yield being 60,000,000 gallons a year. The value of land under artesian well irrigation (e.g. in the Graaff Reinet district) has increased from 20s. to £200 per morgen. More important, however, are the supplies to be derived from the control of flood water, millions of cubic feet of the best soil being annually washed into the sea. The Boer governments had done little to promote irrigation, but during 1905-1907 a strong intercolonial commission investigated the subject as it affected the Transvaal and Orange Free State, and their final report, issued at Pretoria in 1908, contains full particulars as to the irrigation possibilities in those provinces. At least 350,000 acres in the Transvaal could be remuneratively irrigated, and a proportionally large area in the Orange province. In Natal an act of 1904 gave power to the government to forward irrigation schemes. Under that act the Winterton Irrigation Settlement (18,000 acres) was formed on the upper Tugela. In 1909 an irrigation congress representative of all the governments of British South Africa was held at Robertson, in the Cape province.

Commerce.—All the British states and territories are members of postal, telegraphic and customs unions. The customs are of a protective character, while there is a rebate on goods from Great Britain and British possessions¹ (see below, *History*). There is internal free trade throughout the Union of South Africa. The customs tariff in the Portuguese possessions is of a highly protective nature; goods coming from Portugal pay one-tenth of the dues levied on foreign goods. In German South-West Africa no discrimination is made as to the country of origin of imports.

A South African Customs Statistical Bureau, which deals with the external trade of British South Africa,² was established in July 1905. The statistics issued by the bureau showed a total volume of trade in 1905 of £72,910,000 made up as follows: Imports £29,859,000 (including £4,208,000 received through Portuguese ports); exports £43,050,000. Of this amount £25,644,000 was put as the value of raw gold exported, and £9,257,000 as the value of the diamonds shipped. Only £414,000 worth of goods was exported via Portuguese ports. For 1907 the figures were: Value of total trade £74,153,000; imports £25,920,000, exports £48,233,000. Goods valued at £4,036,377 received through Portuguese ports are included in the imports, and goods valued at £507,000 shipped at Portuguese ports in the exports. The value of raw gold exported in 1907 was £29,510,000, of diamonds £8,973,000. In 1908 the figures were: Total trade £70,093,000; imports £24,438,000 (including £4,641,000 via Portuguese ports); exports £45,655,000 (including £513,000 from Portuguese ports). The raw gold exported was worth £32,047,000 but the export of diamonds fell to £4,796,000. In 1909 the value of the imports into British South Africa was returned at £29,842,000; the value of the exports at £51,151,000.³ Of the imports over £16,850,000 came from the United Kingdom, over £2,240,000 from Australia, £2,450,000 from Germany, and £2,195,000 from the United States. Of the exports raw gold was valued at £33,303,000, diamonds at £6,370,000, wool at £3,728,000 and ostrich feathers at £2,091,000. The value of the imports through Delagoa Bay and other Portuguese ports was £6,795,000, the exports from Portuguese ports were valued at slightly over £500,000. In the four years the imports from the United Kingdom were about 58%, from other parts of the empire 13%. Of the exports the United Kingdom took some 95%; a considerable quantity of South African produce, especially wool, shipped to England ultimately however finds its way to other countries. Next to Great Britain the countries doing most trade with South Africa are Australia and New Zealand, Germany, the United States, Canada, Brazil, India, Belgium, Holland and France.

Religion.—The great majority of the white inhabitants are Protestants. Most of those of Dutch descent are members of the Dutch Reformed Church (*Nederduitsch Hervormde Kerk*), the state church of the early Cape colonists, or of churches formed by dissentient members of the original church such as the *Gereformeerde Kerk* (the "Dopper" Church), a branch (introduced in 1858) of the Separatist Reformed Church of Holland. These churches are Calvinistic in doctrine and Presbyterian in organization. Until 1843 the Cape synod was controlled by government commissioners; it was then given power to regulate its own internal affairs. There are separate synods with independent authority for the congregations of the Dutch Reformed Churches in the Cape, Orange Free State and Transvaal provinces. The Doppers ("roundheads") and other dissentient bodies have also separate synods. Besides these churches there are a number of Lutheran congregations among the Dutch speaking population.

The South Africans of British descent are divided, mainly, into Anglicans, Wesleyans and Presbyterians. The Baptists and Congregationalists are smaller bodies. All form independent churches in communion with the mother churches in Great Britain. The oldest established is that of the Presbyterians. The Anglican

¹ The total amount rebated in 1908 was £430,017.

² Including North-West Rhodesia.

³ For the six months January to June 1910 the figures were: imports £14,770,000; exports £24,442,000.

organization dates from 1847. Being declared by judicial decision in 1863 a voluntary body, the Anglicans formed "The Church of the Province of South Africa." It is divided into the dioceses of Cape Town, Graham's Town, Maritzburg (Natal), Kaffraria, Bloemfontein, Pretoria, Zululand, Mashonaland and Lebombo. The last-named diocese is that part of Portuguese East Africa south of the Sabi river; the Mashonaland diocese includes the Portuguese territory between the Sabi and the Zambezi. German South-West Africa is not included in the Anglican organization. The metropolitan is the archbishop of Cape Town. The constitution of the church was drawn up at a provincial synod in 1870. It accepts the doctrines of the Church of England, but acknowledges none save its own ecclesiastical tribunals, or such other tribunal as may be accepted by the provincial synod—in other words it rejects the authority of the English privy council. Bishop Colenso of Natal and other Anglicans did not accept the authority of the provincial synod, regarding themselves as in all respects members of the Church of England. This was, especially in Natal, the cause of prolonged controversy among the members of the Anglican community. By 1901, however, the majority of the "Church of England party" were represented in the provincial synod. Nevertheless the temporalities of this party remained in the hands of curators and not in the possession of the provincial church. In 1910 the practical amalgamation of the two bodies was effected (see further NATAL).

The Roman Catholics are a comparatively small body; the majority of their adherents are found in the Cape and Natal. At the head of their organizations are vicars-apostolic for the Cape (eastern district), the Cape (western district), Natal, Orange River, Kimberley and the Transvaal, and prefects-apostolic for Basutoland and Zambezi (or Rhodesia).

All the churches maintain missions to the natives. The first to enter the field were the Jesuits and Dominicans, who laboured on the south-east coast and among the subjects of the monomotapa (see PORTUGUESE EAST AFRICA). Their work lasted from about

1560 to 1760, but it has left little trace. The early modern missions were all Protestant. A Moravian mission to the Hottentots was begun in 1737, continued to 1744 and was re-established—against the wishes of the colonists—in 1792. Before the close of the century the London Missionary Society entered the field. The work of this society's agents has had a greater influence on the history of South Africa than that of any other religious body save the Dutch Reformed Church. Next in order came the Wesleyans and the Glasgow Missionary Society (Presbyterian), the last-named society founding in 1824 the station of Lovedale—now the most important institution in South Africa in connexion with native missions. In 1829 the Paris Evangelical Society (whose agents have laboured chiefly in Basuto and Barotse lands) sent out their first missionaries, who were closely followed by the agents of other societies (see MISSIONS). The Roman Catholics entered the field later on. By the end of the 19th century fully 5% of the total native population professed Christianity.

The Jews form a small but influential community. There are some thousands of Mahomedans in the Cape (chiefly Malays) and larger numbers in Natal, where there is also a large Hindu population. At Lourenço Marques the Chinese colony has its own temple and religious services.

*Law.*¹—The basis of the common law of British South Africa is the Roman-Dutch law as it existed in Holland at the end of the 18th century. This was simply the old Roman jurisprudence embodied in the legislation of Justinian, modified by custom and legislative decrees during the course of the centuries which witnessed the growth of civilization in Europe; and it is to all intents and purposes the jurisprudence which was the foundation of the Code Napoléon. It was in part closely akin to the "modern Roman law" which is practised widely over the continent of Europe, and even in Scotland, at the present day. The authorities upon the common law in South Africa are: the Dutch commentators upon the civil law, the statute law of Holland, the decisions of the Dutch courts, and, failing these, the *corpus juris civilis* itself.

In the period which has elapsed since the establishment of British rule at the Cape the law has been considerably modified and altered, both by legislation and by judicial decisions, and it is not too much to say that at the present time there exists hardly any material difference in principle over the greater part of the field of jurisprudence between the law of England and the law of South Africa. The law of contracts, the law of torts, the mercantile law, the law relating to shipping and insurance, not to mention other subjects, are practically identical with those of England; and even the criminal law is virtually the

same, though the greater elasticity of the civil jurisprudence allows fewer opportunities for the escape of malefactors, notably in cases of fraud or falsity in any form, than exist under the law of England. The constitution of the courts is based on the example of the English judiciary, and the rules of evidence and procedure are practically the same in both criminal and civil cases as in England. All serious cases of crime are tried before a judge and jury, with the same formalities and safeguards as in England, while minor offences are dealt with by stipendiary magistrates possessing a limited statutory jurisdiction. In criminal cases it is necessary for the jury to find a unanimous verdict. In civil cases either party may demand a jury, a privilege which is seldom exercised; but in a civil case the verdict of the majority of jurors prevails.

The most marked difference between the English and South African systems of law is, as might be expected, to be found in the law relating to real property. In South Africa there is a rigid and universal application of the principle of registration. The title to land is registered, in all cases; and so, with a few exceptions, is every servitude or easement, mortgage or charge, upon land. With regard to the devolution of property upon death, it may be remarked that the law of intestate succession applies equally to real and personal estate, there being no law of primogeniture. The rules of distribution in intestacy differ, however, very considerably from those established in England. There is absolute freedom of testamentary disposition in the Cape province and in some other parts of South Africa. The effect of marriage upon the property of the spouses is, by the Roman-Dutch law and in the absence of any ante-nuptial contract to the contrary, to bring about a complete community of property, virtually a universal partnership between husband and wife, subject to the sole and absolute control of the husband while the marriage lasts. The courts have, however, the right to interfere for the protection of the wife in case of any flagrant abuse of the power thus vested in the husband. Ante-nuptial agreements may be of any nature the parties may choose. Such agreements must in all cases be publicly registered. Upon the dissolution of a marriage in community of property, or in the event of a judicial separation *a communione bonorum*, the property of the spouses is divided as upon the liquidation of a partnership. It is not necessary here to refer particularly to certain exceptions to this general rule in cases of divorce.

By the common law gifts between husband and wife during marriage are void as against creditors. This rule cannot be evaded even by ante-nuptial agreement. By the statute law of Natal post-nuptial agreements between spouses are permitted under certain conditions, to which it is not possible now to refer at length. Divorce is granted to either spouse for either adultery or malicious desertion, the distinctions established by the English law between husband and wife in respect of divorce being disregarded.

Language.—The languages spoken in South Africa by the inhabitants of European descent are English and Dutch, the latter chiefly in the form of a patois colloquially known as the Taal. (German and Portuguese are spoken in the possessions of those countries, but a knowledge of English or Dutch is frequent even in those territories.) The history of the Dutch language in South Africa is intimately bound up with the history of the South African Dutch people. The basis of the language as spoken to-day is that 17th-century Dutch of Holland which the first settlers brought to the country; and although the Dutch of Holland and the Dutch of South Africa differ very widely to-day, Cape Dutch differs less widely from the Dutch language of the 17th century than from the modern Dutch of Holland. The tongue of the vast majority of the Dutch-speaking inhabitants may thus be said to be a degenerate dialect of the 17th-century Dutch of Holland, with a very limited vocabulary. The limiting of the vocabulary is due to two reasons. In the first place, the early settlers were drawn principally from the peasant class, being chiefly discharged soldiers and sailors; and, further, when once settled, the necessity for making the language intelligible to the natives by whom the settlers were surrounded led

¹ For the sections here incorporated on South African law and language we are indebted to the late J. W. Leonard, K.C. (d. 1909), twice attorney-general of Cape Colony.



to a still further simplification of speech structure and curtailment of the vocabulary. There thus grew up an ungrammatical dialect of Dutch, suited only to the most ordinary requirements of the everyday life of a rural population. It became a language with neither a syntax nor a literature. At the same time it remained in character almost entirely Dutch, no French—in spite of the incorporation into the population of the Huguenot emigrants—and only a few Malay words finding a place in the Taal. But side by side with this language of everyday life a purer form of Dutch has continued to exist and find its uses under certain conditions. It must be borne in mind that the Boers of every grade have always been more or less sedulously instructed in religious subjects, at all events to the extent required to fit them for formal membership of their church, and in all their wanderings they have usually been attended by their pastors. The Dutch Bible and Catechism are written in pure Dutch. The language of the Dutch Bible is as majestic as that of the English version. Moreover, the services of the Church have always been conducted in grammatical though simple Dutch; and the clergy, in their intercourse with the people, have as a general rule abstained from conversing in the ordinary dialect. The Boer thus has but slight difficulty in reading and understanding pure Dutch. Under the influence of Afrikaner nationalism strenuous efforts have been made to teach the language in the schools throughout the greater part of South Africa. In the Transvaal and Orange Free State education was imparted almost exclusively in Dutch. All public business in the government offices and law courts was conducted in the language, and the Transvaal at the time of its annexation by Great Britain was being gradually inundated by officials, railway servants and others introduced from Holland, who spoke modern Dutch. Officially throughout the Union of South Africa both languages are now on a footing of equality.

Throughout South Africa a number of words, mainly Dutch, are in general use by the English-speaking inhabitants and also, to a considerable extent, among the natives. The most common of these words, with their English meanings, are here set forth. When not otherwise stated the words are of Dutch origin:—

- Assegai a spear used by the Kaffir tribes; a word adopted from the Portuguese, but of Berber origin.
- Boschveld a plain or open stretch of country covered with thin wood or bush. Often written bushveld.
- Bywoners (literally witnesses) "poor whites," the name given by the Boers to the landless whites, hangers-on at farms, &c.
- Daal valley.
- Dorp village.
- Driit ford (a "Taal" word).
- Ervan (sing. erf) plots of land.
- Fontein fountain, spring.
- Hoek corner, angle, hook. Common in place-names.
- Inspan to harness.
- Kaffir (Arabic for unbeliever [in Islam]) a native of Bantu stock; more loosely any native.
- Karoo any arid district; now the name of definite regions (from the Hottentot).
- Kloof fissure or crevice, hence a ravine or narrow valley.
- Kop (literally head) a hill, generally rounded. Flat-topped hills are usually called tafel (table) or plat (flat) bergs.
- Kopje a little hill; the name given to the isolated pointed hills which are a characteristic feature of the plains of South Africa.
- Kraal an enclosure, hence a native village. Probably from the Portuguese.
- Krantz (or Kranz) an overhanging wall of rock, hence a steep cliff, a precipice. A "Taal" word derived from the Dutch *kranz*, a wreath, chaplet or cornice.
- Nek literally neck } mountain passes or passes
- Poort literally gate } between mountains.
- Rand border, edge, hence a low and usually round range of hills.
- Ruggens ridges, applied to undulating slopes or un-irrigated hilly country.
- Slim cunning, clever, adroit.
- Sluit (Dutch *sloot*) ditch, gutter, small stream.

- Spruit (literally shoot, *spruiten*, to spring up), stream, small rivcr. The name given to intermittent streams liable to sudden freshets.
- Stoep (literally a step), the name given to the platform or veranda of a house. The stoep is shaded by a roof and is a favourite rendezvous for the household and for visitors. Formerly all South African houses had stoeps, but in the central parts of the larger towns the buildings are now without verandas.
- Trek (literally, pull, tug, *trekken*, to draw or pull), to leave a place, to take a journey; also the distance covered in a journey.
- Veld field. The name given to open plains and to the grass-covered plateaus of the interior.
- Vlei a hollow filled with water during rainy weather.
- Uitspan to unharness.
- Uitlander outlander, *i.e.* a foreigner.

Among other Dutch words frequently used in place-names may be instanced: rhenoster (rhinoceros) olifant (elephant), mooi (pretty), modder (mud), klip (cliff), berg (mountain), burg or stad (town), zwart (black), klein (little), groote (great), breede (broad), nieuw (new), zuur (sour), bokke (buck).

A number of Dutch weights and measures are also in general use. They include: muid = 3 bushels; morgen = 2.11654 acres. A Cape rood equals 12.396 English feet, and a Cape ton contains 2000 lb.

II.—CONSTITUTION OF THE UNION OF SOUTH AFRICA

In accordance with the provisions of an act of the British Parliament (South Africa Act 1909) Cape Colony, Natal, the Transvaal and Orange River colonies were united under one government in a legislative union under the British crown. The Union of South Africa, as the new state is named, was established on the 31st of May 1910. Upon its formation the colonies named became provinces of the Union. In the case of the Orange River colony its title was changed to Orange Free State province. The colonial legislatures were abolished, provincial councils, with strictly subordinate and delegated powers, were set up, and provincial administrators (local men) replaced the various governors. The history of the movement which led to unification is given in the following section. The main provisions of the constitution¹ are as follows:—

The executive government of the Union is vested in the king and may be exercised by the sovereign in person. It is, however, administered by a governor-general, who holds office during the king's pleasure. The governor-general can dismiss ministers and dissolve parliament. He is empowered to dissolve both houses of the legislature simultaneously or the House of Assembly alone. He can perform no official act when beyond the territorial limits of the Union, but he can appoint a deputy to act for him during temporary absences. The governor-general is paid £10,000 a year out of the consolidated funds of the Union. He is advised by an executive council, whose members he nominates. The council must include the ministers of state; ministers administering departments of state may not exceed ten in number. Ministers cannot hold office for a longer period than three months unless they are or become members of either house of parliament. The control and administration of native affairs (which before the Union was, except at the Cape, largely in the hands of the colonial governors personally) is vested exclusively in the governor in council and to the same authority is entrusted all matters specially or differentially affecting Asiatics throughout the Union.

The legislative power is vested in a parliament consisting of the Sovereign, a Senate, and a House of Assembly. The Senate consists of 40 members, 8 representatives from each province, and 8 members nominated by the governor-general in council. Four of the nominated members are selected on the ground mainly of their thorough acquaintance with "the reasonable wants and wishes" of the coloured races in South Africa. The presence of both nominated and elected members in the Senate is a novel provision in the constitution of the upper chambers of British colonial legislatures. The senators chosen in 1910 hold office for ten years. After 1920 the Union parliament may make any alteration it sees fit in the constitution of the senate. A senator must be a British subject of European descent, must be thirty years old, be a parliamentary voter in one of the provinces, have lived for five years in the Union, and if an elected member be possessed of immovable property within the Union of the clear value of £500.

¹ For a detailed examination of the constitution and a comparison of it with the federal constitutions of Canada and Australia see "South African Union," by A. Berriedale Keith, in the *Journ. Soc. Comp. Legislation* for October 1909.

The House of Assembly consists (as originally constituted) of 121 members, elected by single-membered constituencies, each constituency containing as nearly as possible the same number of voters. Of these members the Cape Province returns 51, the Transvaal 36, and Natal and Orange Free State 17 each. As population increases the total number of members may be raised to 150. The seats allotted to each province are determined by its number of European male adults as ascertained by a quinquennial census, the quota for a constituency being obtained by dividing the total number of such adults in the Union as ascertained at the 1904 census by the number of members at the establishment of the Union. The commission charged with the delimitation of constituencies is permitted to vary the quota as much as 15% either way. Members of the House of Assembly must, like senators, be British subjects of European descent, they must be qualified to be registered as voters and have lived for five years within the Union. A general election must take place every five years, and all polls must be taken on the same day. There must be a session of parliament every year, so arranged that twelve months shall not elapse between the last day of one session and the first sitting of the next session.

The qualifications of parliamentary voters are those which existed in the several colonies at the establishment of the Union, save that "no member of His Majesty's regular forces on full pay" can be registered as a voter. As the franchise laws in the several colonies differed the qualifications of voters in the provinces differ also. In the Transvaal and Orange Free State provinces the franchise is restricted to white adult male British subjects. In neither province is there any property qualification, but a six months' residence before registration is required. In Natal (*q.v.*) there is a low property qualification. In that province coloured persons are not by name debarred from the franchise, but they are in practice excluded. In the Cape province, where there is also a low property qualification, no colour bar exists and there are a large number of Kaffir voters (see *CAPE COLONY: Constitution*). Parliament may alter the qualifications for the vote, but no law which would deprive coloured persons in the Cape province of the franchise can be effective "unless the bill be passed by both houses of parliament sitting together and at the third reading be agreed to by not less than two-thirds of the total number of members of both houses."

Save as subject, ultimately, to the British parliament the Union parliament is a sovereign body. The provinces have no original authority, possessing only such powers as are delegated to them by the parliament. In certain cases the governor-general must reserve the royal assent to bills, *e.g.* any bill abolishing the coloured vote in the Cape province. The king is given the power to disallow any law within a year of it having received the assent of the governor-general.

With regard to bills the two houses are not in a position of equality. Bills appropriating revenue or moneys, or imposing taxation, must originate in the House of Assembly and may not be amended by the Senate. If a bill passed by the Assembly has been twice rejected by the Senate, provision is made for a joint sitting of both houses, when members vote and decide upon the measure concerned as one body. In the case of a money bill rejected by the Senate a joint sitting to decide its fate may be held in the same session in which the Senate has failed to pass the bill. Every minister of state may sit and speak in either house, but can vote only in the house of which he is a member. Re-election is not necessary on the appointment of a member as a minister of state. Members of parliament are paid £400 a year, £3 being deducted from this allowance for every day's absence during the session.

A Supreme Court of Judicature for South Africa was created at the establishment of the Union. The former Supreme, High and Circuit Courts of the several colonies then became provincial and local divisions of the Supreme Court of South Africa, which consists of two divisions, namely the Supreme Court and the Appellate Division. Appeals from the decisions of the provincial and local divisions of the court and from those of the High Court of southern Rhodesia, must be made to the appellate division of the Supreme Court. Unless special leave of the privy council be obtained there can be no appeal from the decisions of the Appellate Division, save in admiralty cases. This restriction of the power of appeal to the privy council is much greater than are the restrictions upon appeals from the Commonwealth of Australia, where appeals to the privy council lie by right from the several state Supreme Courts. The difference arises from the fact that the Commonwealth is a federation of states; whereas the Union of South Africa is but one state with but one Supreme Court. One result of this unification of the courts of South Africa is that any provincial or local division of the Supreme Court in which an action is begun can order its transference to another division if that course be deemed more convenient. Moreover the judgments of each provincial division can be registered and enforced in any other division. The administration of justice throughout the Union is vested in a minister of state who has all the powers of the attorney-generals of the several colonies at the time of the Union, save that power as to the prosecution of crimes is vested in each province in an official appointed by the governor-general in council and styled the attorney-general of the province.

Among the general provisions of the constitution the most im-

portant is that both the English and Dutch languages are official languages of the Union and are treated on a footing of equality; all records of parliament, and all notices of general public importance or interest issued by the government of the Union must be in both languages. (Persons in the public service at the establishment of the Union cannot, however, be dispensed with because of lack of knowledge of either English or Dutch.) Other general provisions enact free trade throughout the Union, but the customs and excise leviable under the laws existing in any of the colonies at the establishment of the Union remain in force unless parliament otherwise provides. All persons who had been naturalized in any of the colonies are naturalized throughout the Union. All rights and obligations under conventions and agreements which were binding on any of the colonies have devolved upon the Union.

The harbours of Cape Town, Port Elizabeth, East London and Durban are state owned, as are also nearly all the railways in the Union. All revenues derived from these services are paid into a separate fund. The administration of the railways, ports and harbours is entrusted to a board of not more than three commissioners (appointed by the governor-general in council) presided over by a minister of state. Each commissioner holds office for five years and may be reappointed. The board is directed to administer its service on business principles, due regard being had to agricultural and industrial development, &c., within the Union. So far as may be the total earnings are not to be more than are sufficient to meet necessary outlays.

Provincial Administration.—While the Union parliament has full power to make laws for the whole of the Union, to provincial councils have been delegated the immediate control of affairs relating solely to the provinces. The subjects delegated to the councils include direct taxation within the provinces for local revenue purposes, the borrowing of money (on the sole credit of the provinces) with the consent of the ministry; agriculture (within the limits defined by parliament) and municipal institutions, divisional councils, and other local institutions. The control of elementary education was also guaranteed to the provincial councils up to 1915, and thereafter until parliament otherwise provides.

The councils consist of not fewer than 25 members and not more than the number of members returned by the province to the House of Assembly. Each councillor represents a separate constituency, these constituencies, as far as possible, to be the same as the parliamentary constituencies. (In the Cape and Transvaal provinces they were the same in 1910; Natal and Orange Free State returning only 17 members to the House of Assembly, the parliamentary constituencies have been rearranged.) The qualifications for electors are the same as for parliament, and any person qualified to vote is qualified to be a member of the council. As in the Cape province coloured persons are qualified to vote, they are thus also qualified to be members of the provincial council. Any member of the provincial council who becomes a member of either House of Parliament thereupon ceases to be a member of such provincial council. Each provincial council continues for three years from the date of its first meeting and is not subject to dissolution save by effluxion of time.

The executive power in each province is invested in an officer appointed by the government and styled provincial administrator. He holds office for five years. The administrator is assisted by an executive committee of four persons elected from among its own members, or otherwise, by the provincial council on the proportional representation principle. The administrator and any other member of the executive committee, not being a member of the council, has the right to take part in the proceedings of the council, but has not the right to vote. The provincial councils have not the right to make laws, but ordinances, which must receive the assent of the governor-general in council before becoming valid. (F. R. C.)

III.—HISTORY

The history of South Africa is, almost entirely, that of its colonization by European races, of their conflicts with, and influence over, its native inhabitants, and of the struggle for supremacy between the British and Dutch settlers. The little that is known concerning the doings of the natives before the appearance of the white man belongs to the domain of ethnology rather than of history. When the Portuguese first reached the southern part of Africa there was but one place in it where a civilized race held sway. This was at Sofala, the most southerly post of the East African Arabs. From that port the Arabs traded for ivory, slaves and (principally) gold with Bantu peoples of the far interior—the Rhodesia of to-day. These natives, whose earliest existing buildings may go back to the time of the Norman Conquest, were in a higher state of

development than the Bushmen and Hottentots living farther south. The part played by the various native races in modifying the character of the European colonization will be best considered as they successively came into contact with the white settlers. At this point it is only necessary to state that at the same time as the Europeans were slowly extending northward from the south-western point of the continent, a conquering race of Bantu negro stock, originating from somewhere beyond the Zambezi, was spreading southward along the western side of the country.

A. *From the Discovery of the Cape to the Great Trek.*—What led to the discovery of America led also to the discovery, exploitation and colonization of South Africa. In the 15th century the great Eastern trade with Europe was carried on by the Venetian Republic—Venice was the gate from West to East, and her fleets, richly laden with goods brought down to the shores of the Mediterranean in caravans, supplied Europe with the luxuries of the Orient. It was in that century that Portugal rose to prominence as a maritime power; and being anxious to enjoy at first hand some of the commerce which had brought such prosperity to Venice, Portugal determined to seek out an ocean pathway to the Indies. It was with this intention that Bartholomew Diaz, sailing southwards, discovered the Cape of Good Hope in 1488.¹ Nine years after the discovery of the Cape by Diaz another Portuguese expedition was fitted out under Vasco da Gama. Da Gama entered Table Bay, but did not land. Thence he pushed on round the coast, landed in Mossel Bay, then sailing up the south-east coast he sighted land again on the 25th of December 1497, and named it in honour of the day, Natal. Still proceeding northwards he entered the Quilimane River and eventually reached India.

For many years subsequent to this date South Africa represented merely an inconvenient promontory to be rounded on the voyage to the Indies. Ships stopped at different ports, or rather at such few natural harbours as the inhospitable coast offered, from time to time, but no attempt was made by the Portuguese to colonize the southern end of the continent. On the west coast their southernmost settlement for a long period was Benguella, and the history of Angola (*q.v.*) had not until the last quarter of the 19th century any close connexion with that of South Africa. On the east coast the Portuguese were masters of Sofala by 1506, and a trading-post was first established in Delagoa Bay in 1545. Here alone Portugal obtained an important foothold in South Africa. But between Benguella on the west and Lourenço Marques on the east the Portuguese made no attempt to form permanent settlements or trading stations along the coast. It was too barren a shore to prove attractive when the riches of East Africa and India were available.

The first Europeans to follow in the wake of the Portuguese voyagers were the English. In 1601 the English East India Company fitted out a fleet of five vessels, which sailed from Torbay. After four months at sea they dropped their anchors in Table Bay, where they remained for seven weeks before proceeding eastwards. From that time forward Table Bay was used as an occasional port of call for British ships, and in 1620 two English captains formally took possession of the Cape in the name of James I. This patriotic act was not, however, sufficiently appreciated by either King James I. or the English East India Company to evoke any official confirmation on their part. Meanwhile the Dutch East India Company had been formed in Holland, and the Dutch had entered keenly into the competition for the glittering prizes of Eastern commerce. In 1648 one of their ships was stranded in Table Bay, and the shipwrecked crew were left to forage for themselves on shore for several months. They were so pleased with the resources of the country that on their return to Holland they represented to the directors of the company the great advantages that would accrue to the Dutch Eastern trade from a properly provided and fortified station of call at the Cape. The result was that in 1652 a fort and vegetable

¹ The date usually assigned (1486), on the authority of De Barros, has been shown to be incorrect (see DIAZ).

gardens were laid out at Table Bay by a Dutch expedition sent for the purpose under a surgeon named Jan van Riebeeck.

In 1657 a few soldiers and sailors, discharged by the Dutch East India Company, had farms allotted them, and these men constituted the first so-called "free burghers." By this step the station became a plantation or settlement. More settlers were landed from time to time, including a number of orphan girls from Amsterdam, and during 1688-1689 the colony was greatly strengthened by the arrival of some three hundred Huguenots (men, women and children), who were located at Stellenbosch, Drakenstein, Frenchhoek and Paarl. In process of time the French settlers were absorbed in the Dutch population, but they have had an enduring influence on the character of the people. The little settlement gradually spread eastwards, and in 1754 the country as far as Algoa Bay was included in the colony. At this time the white colonists numbered eight to ten thousand. They possessed numerous slaves, grew wheat in sufficient quantity to make it an article of export, and were famed for the good quality of their wines. But their chief wealth was in cattle. Such prosperity as they enjoyed was in despite of the system of government prevailing. All through the latter half of the 17th and the whole of the 18th century troubles arose from time to time between the colonists and the government. The administration of the Dutch East India Company was of an extremely despotic character. The most complete account of the company's tenure and government of the Cape was written in 1857 by E. B. Watermeyer, a Cape colonist of Dutch descent residing in Cape Town. He points out that it was after failing to find a route by the north-east to China and Japan that the Dutch turned their eyes to the Cape route. The Cape of Good Hope subsequently "became not a colony of the Republic of the United Provinces, but a dependency of the 'Netherlands Chartered General East India Company' for mercantile purposes; and to this fact principally can be traced the slow progress, in all but extension of territory, of a country which was settled by Europeans within thirty years of the time when the Pilgrim Fathers, the founders of a mighty empire, landed at Plymouth to plant democratic institutions and European civilization in the West."

On the settlement under van Riebeeck, and the position in it which the so-called "free burghers" enjoyed, this candid Dutch writer throws an interesting light.

"The people," he says, "who came here with Riebeeck himself were not colonists intending permanently to settle at the Cape. . . . The proposition that any freemen or burghers not in the pay of the company should be encouraged to cultivate the ground was first made about three years after Riebeeck's arrival. Accordingly, some discharged sailors and soldiers, who received on certain conditions plots of ground extending from the Fresh River to the Liesbeek, were the first free burghers of the colony. . . . Here it is sufficient to say that, generally, the term 'free burgher' was a complete misnomer. The first burghers were, in truth, a mere change from paid to unpaid servants of the company. They thought, in obtaining their discharge, that they had much improved their condition, but they soon discovered the reverse to be the fact. And henceforward, to the end of the last [18th] century, we find the constantly repeated and well-founded complaint, that the company and its officers possessed every advantage, while the freemen were not allowed even the fruit of their own toil. . . . The natural effect of this narrow and tyrannous rule was discontent, amounting often to disaffection. After a time every endeavour was made to escape beyond the immediate control of the authorities. Thus the 'trekking' system, with its attendant evils, the bane of South Africa, was born. By their illiberal spirit, which sought but temporary commercial advantage in connexion with the Eastern trade, the Dutch authorities themselves, although generally humanely disposed towards the natives, created the system which caused their oppression and extermination."

When it is borne in mind that the Dutch at the Cape were for one hundred and forty-three years under the rule of the Dutch East India Company, the importance of a correct appreciation of the nature of that rule to any student of South African history is obvious. No modern writer approaches Watermeyer either in the completeness of his facts or the severity of his indictment. Referring to the policy of the company, Watermeyer says:—

The Dutch colonial system as exemplified at the Cape of Good Hope, or rather the system of the Dutch East India Company (for the nation should not wholly suffer under the condemnation justly incurred by a trading association that sought only pecuniary profit), was almost without one redeeming feature, and was a dishonour to the Netherlands' national name. In all things political it was purely despotic; in all things commercial, it was purely monopolist. The Dutch East India Company cared nought for the progress of the colony—provided only that they had a refreshment station for their richly laden fleets, and that the English, French, Danes and Portuguese had not. Whatever tended to infringe in the slightest degree on their darling monopoly was visited with the severest penalties, whether the culprit chanced to be high in rank or low. An instance of this, ludicrous while grossly tyrannical, is preserved in the records. Commander van Quaelbergen, the third of the Dutch governors of the colony, was dismissed from the government in 1667, and expelled the service of the company, because he had interchanged civilities with a French governor bound eastwards, the United Provinces being then at peace with France.¹

Of this nature was the foreign policy of the Dutch company at the Cape of Good Hope; modified, indeed, in some degree from time to time, but governed by principles of jealous, stringent monopoly until the surrender of the colony by Commissioner Sluysken in 1795. The internal government of the colonists for the entire duration of the East India Company's rule was always tyrannical, often oppressive in the extreme. With proclamations, placats and statutes abundantly filling huge tomes, the caprice of the governor was in truth the law. A mockery of popular institutions, under the name of a burgher council, indeed existed; but this was a mere delusion, and must not be confounded with the system of local government by means of district burgher councils which that most able man, Commissioner de Mist, sought to establish during the brief government of the Batavian Republic from 1803 to 1806, when the Dutch nation, convinced and ashamed of the false policy by which they had permitted a mere money-making association to disgrace the Batavian name, and to entail degradation on what might have been a free and prosperous colony, sought to redeem their error by making this country a national colonial possession, instead of a slavish property, to be neglected, oppressed or ruined, as the caprice or avarice of its merchant owners might dictate.

From time to time servants in the direct employment of the company were endowed with the right of "freeburghers,"

The Trek Boers.

but the company retained the power to compel them to return into its service whenever they deemed it necessary. This right to enforce into servitude those who might incur the displeasure of the governor or other high officers was not only exercised with reference to the individuals themselves who had received this conditional freedom; it was, adds Watermeyer, claimed by the government to be applicable likewise to the children of all such. The effect of this tyranny was inevitable: it drove men to desperation. They fled from oppression; and thus trekking began, not in 1835, as is generally stated, but before 1700. From 1720 to 1780 trekking had gone steadily forwards. In 1780 van Plettenberg, the governor, proclaimed the Sneeuwbergen the northern boundary of the colony, expressing "the anxious hope that no more extension should take place, and with heavy penalties forbidding the rambling peasants to wander beyond." In 1789 so strong had feeling amongst the burghers become that delegates were sent from the Cape to interview the authorities at Amsterdam. After this deputation some nominal reforms were granted; but in 1795 a number of burghers settled in the Swellendam and Graaf Reinet districts drove out the officials of the company and established independent governments. The rebellion was accompanied by an assertion of rights on the part of the burghers or freemen, which contained the following clause, the spirit of which animated many of the Trek Boers:—

That every Bushman or Hottentot, male or female, whether made prisoner by commanders or caught by individuals, as well in time past as in future, shall for life be the lawful property of such burghers as may possess them, and serve in bondage from generation to generation. And if such Hottentots should escape, the owner shall be entitled to follow them up and to punish them, according to their merits in his discretion.

¹ It was not until the time of Ryk Tulbagh (governor of the colony, 1751–1771) that the Chamber of Seventeen permitted foreign ships to provision at Table Bay. Tulbagh was the most popular of the governors under the East India Company. During his governorship no new taxes were levied on the burghers. He was succeeded by van Plettenberg.

And as to the ordinary Hottentot, already in service, brought up at the places of Christians, the children of these shall be compelled to serve until their twenty-fifth year, and may not go into the service of any other save with their master's consent; that no Hottentot, in future deserting his service shall be entitled to refuge or protection in any part of the colony, but that the authorities throughout the country shall immediately, whatever be the alleged cause of desertion, send back the fugitive to his master.

After one hundred and forty-three years the rule of the Dutch East India Company came to an end at the Cape. What its principles were we already have seen. Watermeyer recapitulates its effects as follows:—

The effects of this pseudo-colonization were that the Dutch, as a commercial nation, destroyed commerce. The most industrious race of Europe, they repressed industry. One of the freest states in the world, they encouraged a despotic misrule in which falsely-called free citizens were enslaved. These men, in their turn, became tyrants. Utter anarchy was the result. Some national feeling may have lingered, but, substantially, every man in the country, of every hue, was benefited when the incubus of the tyranny of the Dutch East India Company was removed.

To this one further note must be added. The Trek Boers of the 19th century were the lineal descendants of the Trek Boers of the 18th. What they had learnt of government from the Dutch East India Company they carried into the wilderness with them. The end of the 19th century saw a revival of this same tyrannical monopolist policy in the Transvaal. If Watermeyer's formula, "In all things political, purely despotic; in all things commercial, purely monopolist," was true of the government of the Dutch East India Company in the 18th century, it was equally true of Kruger's government in the latter part of the 19th.

The rule of the Dutch East India Company was extinguished (September 1795) by the occupation of the colony by the British, who acted on behalf of the prince of Orange, Holland having fallen under the control of the revolutionary government of France. Following the peace of Amiens the colony was handed over (February 1803) by Great Britain to a commissioner of the Batavian Republic. During the eight years the British held the Cape notable reforms in the government were effected, but the country remained essentially Dutch, and few British settlers were attracted to it. Its cost to the British exchequer during this period was £16,000,000. The Batavian Republic entertained very liberal views as to the administration of the country, but they had little opportunity for giving them effect. In less than three years (January 1806) the Cape was reconquered by the British, who were at war both with France and Holland. The occupation was at first of a provisional character, but by the third additional article to the convention with the Netherlands of the 13th of August 1814 the country was definitely ceded to Great Britain. In consideration of retaining the Cape and the Dutch settlements now constituting British Guiana, Great Britain paid £6,000,000. The British title to Cape Colony is thus based upon conquest, treaty and purchase. The wishes of the inhabitants were not consulted, and among them resentment was felt at the way in which their future was thus disposed of. The Europeans at the Cape at that time numbered about 27,000.

The British at the Cape.

Before tracing the history of South Africa during the 19th century, the early relations of the white settlers with the natives may be briefly reviewed. The natives first encountered at the Cape were the Hottentots (*q.v.*). They at that time occupied the Cape peninsula and surrounding country, and in the early days of the settlement caused the colonists a considerable amount of trouble. An extract from the diary of van Riebeeck in 1659 will best illustrate the nature of the relations existing between colonists and natives at that time:—

Early Relations with the Native Races.

3rd June.—Wet weather as before, to the prevention of our operations. Our people who are out against the plundering Hottentots, can effect nothing, neither can they effect anything against us; thus during the whole week they have been vainly trying to get at our cattle, and we have been trying vainly to get at their persons; but we will hope that we may once fall in with them in fine weather, and that the Lord God will be with us.

Next to the Hottentots the white settlers encountered the Bushmen (*q.v.*). When first known to the early colonists they were inveterate stock thieves, and were treated as wild animals, to be shot whenever an opportunity occurred.¹ Such opposition as Hottentots and Bushmen were able to offer to European colonization was not difficult to overcome (see CAPE COLONY: *History*). The expansion of the colony was little retarded by native opposition until the Dutch encountered the Bantu negro tribes. As already stated, the Bantus, like the Europeans, were invaders of South Africa, and the meeting of these rival invaders was the cause of many bloody conflicts. At first the Cape government endeavoured to come to an amicable arrangement with the new power threatening its eastern border, and in 1780 it was agreed that the Great Fish River should be the permanent boundary between the colonial and Bantu territories. The Bantus or Kaffirs (*q.v.*), as they were universally called, then held all the coast-lands between Delagoa Bay and the Great Fish River, and for many years they were strong enough to bar the further progress eastward of the white races. But the agreement of 1780 was impossible of fulfilment. The peace was broken in 1789 by an invasion of the colonial territory by the Kaffirs, and this conflict proved to be but the first of a series of Kaffir wars which lasted for a century. In 1811 it was deemed necessary to expel the Kaffirs from the Zuurveld, and the British headquarters in that campaign became the site of Graham's Town. In 1817-1819 the Kaffirs returned and laid waste a large area. They were driven back and the country up to the Keiskama River annexed to the colony; but the disaster which nearly overwhelmed the eastern province convinced Lord Charles Somerset, then governor of the colony, of the necessity for a line of frontier forts and a more numerous settlement of British colonists. Representations on the matter in England, coupled with assurances from Somerset as to the fertility of the district, induced the British government to vote £50,000 for the purpose of sending out a number of emigrants. Applications were called for, and no fewer than 90,000 were received. Of these, only 4000 were selected and shipped to South Africa. They were landed in 1820, in Algoa Bay, where they founded Port Elizabeth and the Albany settlement. Among these settlers were a number of married men with families. They were recruited from England, Ireland and Scotland, and came from all grades of society. Among them were cadets of old families, retired officers, professional men, farmers, tradesmen, mechanics and labourers. They encountered many difficulties and some suffering in their early days, but on the whole they thrived and prospered. Their descendants, the Atherstones, Bowkers, Barbers, Woods, Whites, Turveys, and a number of other well-known frontier families, are to-day the backbone of the eastern district of the Cape, and furnish the largest portion of the progressive element in that province. Among them was a gifted Scotsman named Thomas Pringle (1789-1834). His poems, including "Afar in the desert I love to ride," depict the scenes of those early days in glowing lines. The vast spaces of the veld, the silence of the solitudes, the marvellous, varied and abundant animal life, the savage, half-weird character of the natives and the wild adventure of the early colonists have been caught with a true spirit of genius. Since his day no one, unless it be Olive Schreiner in *The Story of an African Farm*, has so vividly painted the life and the atmosphere of that vast continent lying to the south of the Zambezi.

Various Protestant missions had sent agents among the natives during the closing years of the 18th century, and after the definite acquisition of the Cape by Great Britain the number of missionaries in the country greatly increased. Many became pioneers, settling in regions beyond the limits of British jurisdiction. Others remained within Cape Colony, while several were stationed among the Kaffirs along the colonial border. The missionaries from the first often found themselves at variance

with the Dutch and also the British settlers, whose methods of dealing with the natives often deserved condemnation. At this period Dr John Philip (*q.v.*), of the London Missionary Society, was the most prominent of the missionaries in the colony, and his influence was powerful with the home government. The publication in 1828 of his book *Researches in South Africa* had an important effect on the future of the country. The British government adopted his negrophil attitude and made its agents at the Cape conform to it. The equality of all free Hottentots and other free persons of colour with the white colonists was decreed in that year (1820). Philip's action lacked discrimination, and his faith in the natives was excessive. His charges greatly embittered the Boers, who were further aggrieved by the emancipation of the slaves. The Slave Emancipation Act, freeing all slaves throughout the British Empire, *Emancipation of Slaves*, came into force in December 1834.² The slaves in Cape Colony, who consisted of negroes from Mozambique, natives of Madagascar, and of Hottentots and Malays were estimated at the time at 36,000. The Cape governments—both Dutch and British—had been consistently averse from the importation of slaves in large numbers, and the great majority of the slaves were therefore Hottentots. The sum voted by the British government to slave-owners in Cape Colony, out of a total compensation paid of £20,000,000, was £1,250,000 (the official estimate of their value being £3,000,000). This money was only made payable in London, and the farmers were compelled to sell their claims for compensation to agents, who frequently paid a merely nominal price for them. In many instances farmers were unable to obtain native labour for a considerable time after the emancipation, and in several cases ruin was the result. A very bitter feeling was thus created among the Dutch colonists.

The championship of the natives by the missionaries led to attacks, in part justified, upon the policy of the missions not only by the Dutch, but by the British colonists. The zeal of the missionaries frequently outran their discretion. This was especially the case in early days. They not only endeavoured to protect and guide the natives beyond the colonial border, but among the Hottentots within the colony they instilled notions of antipathy to the white farmers, and withdrew large numbers of them from agricultural pursuits. Their general attitude may be explained as a reaction against the abuses which they saw going on around them, and to a misconception of the character of the Hottentot and Bantu races. A longer experience of all the African negroid races has led to a considerable modification in the views originally held in regard to them. The black man is not simply a morally and intellectually undeveloped European, and education, except in rare instances, does not put him on an equality with the European. But, admitting all that may be justly urged against the extreme attitude of some of the missionaries, no unprejudiced man will deny that their work on the whole has been a good one. The fair fame of Great Britain has more than once been upheld in South Africa at the instigation and by the conduct of these intrepid pioneers. Robert Moffat and David Livingstone among the Bechuanas, E. Cassalis among the Basutos, François Coillard among the Barotse, James Stewart in Cape Colony, to name but a few of the great missionaries, have all had an excellent influence upon the natives. They have (besides their purely spiritual work) opposed the sale of alcohol, denounced inhumanity from the farmers, encouraged the natives to labour and taught them mechanical arts. Technical education, begun about 1840, now occupies a position little, if at all, inferior to that of doctrinal teaching, and the effect is an excellent one. Strong testimony to the beneficial result of their labours was borne by a thoroughly impartial commission, presided over by Sir Godfrey Lagden, which in 1903-1905 investigated the status and condition of the natives of South Africa.

To return to the period of Dr Philip's activity.³ Largely upon

² The slaves, after passing four years in a species of apprenticeship, were finally freed on the 1st of December 1838.

³ At this time (*c.* 1815-1840) numbers of persons brought discredit on the missionary cause by their illiteracy, narrow-minded prejudices

¹ It appears that the first persons to treat the Bushmen other than as animals to be destroyed were two missionaries, Messrs J. J. Kicherer and Edwards, who in the early years of the 19th century devoted themselves to ameliorating the lot of these aborigines.

his advice it was decided to create a band of native states on the northern and eastern frontiers of the colony. These treaty states, as they were called, were intended to serve a double purpose; they would be a barrier protecting the colony from the inroads of hostile tribes, and they would enable native civilized nations to grow up (under the tutelage of the missionaries) strong enough to protect themselves from the encroachments of the whites. In fact, neither of these results followed. With one exception, that of Moshesh, the chief of the Basutos, none of the chiefs with whom treaties were made were men powerful enough to found kingdoms, nor had they, in most cases, any better right than their neighbours to the territory recognized as theirs by the British government. Moreover, to treat these men as independent or semi-independent princes was a complete mistake; the failure of the treaty state system is now seen to have been inevitable. The first treaty of this kind was concluded on the 11th of December 1834 with a Griqua chief named Andries Waterboer. This chieftain lived north of the Orange river in the district now known as Griqualand West, and ruled over some 4000 people, a bastard race sprung from the intercourse between Boers and native women. In 1843 two more of these treaty states were established, one under Adam Kok (the third of that name) and the other under Moshesh. Adam Kok had under him a small number of Grikwas, who dwelt in the country east of that occupied by Waterboer (see GRIQUALAND). And east of this country, again, was a tract of territory occupied by Basutos under Moshesh. In the same way Pondoland was established as a treaty state in 1844. The distinction between these states must be remembered to understand ariht subsequent developments. Moshesh ruled over a region largely mountainous and over a people numerous and virile; Pondoland was somewhat remote and was densely inhabited by warlike Kaffirs; the two Griqua states were, however, missionary creations; they were thinly inhabited and occupied open plains easy of access—hence their ultimate collapse.

The year which witnessed the emancipation of the slaves and the creation of the first treaty state also saw the beginning of another disastrous Kaffir war. Fighting began in December 1834, and lasted nearly a year. The Kaffirs wrought great havoc, and Sir Benjamin D'Urban (*q.v.*), the governor, in order to secure peace, extended the boundary of the colony to the Kei river. The Kaffirs had suffered much injustice, especially from the commando-reprisal system, but they had also committed many injustices, and for the disturbed state of the border the vacillating policy of the Cape government was largely to blame. Sir Benjamin's policy—which had the cordial approval both of the Dutch and the British colonists—was one of close settlement by whites in certain districts and military control of the Kaffirs in other regions, and it would have done much to ensure peace. Lord Glenelg, secretary for the colonies in Lord Melbourne's second administration, held that the Kaffirs were in the right in the quarrel, and he compelled D'Urban to abandon the conquered territory, a mistaken decision adopted largely on the advice of Dr Philip and his supporters. Thus at this time (1836) a critical state had arisen in South Africa. The colonists had lost their slaves, the eastern frontier was in a state of insecurity, native interests appeared to be preferred to those of the whites.

The British immigrants of 1820 were still struggling against heavy odds; the Dutch colonists were in a state of great indignation. In these circumstances what is known as the Great Trek occurred. It lasted from 1836 to 1840. During that period no fewer than 7000 Boers (including women and children), impatient of British rule, emigrated from Cape Colony into the great plains beyond the Orange river, and across them again into Natal and into the fastnesses of the Zoutspanberg, in the northern part of the Transvaal.

In view of the vast consequences ensuing from this exodus of Dutch families from the Cape a somewhat detailed consideration

and in some cases lax sexual morality. These persons "assumed to themselves the important office of teachers in the missionary schools within the colony." See H. Cloete's *The Great Boer Trek*, lecture II.

of its causes is necessary. Material for forming a judgment will be found chiefly in the correspondence of Sir Benjamin D'Urban with the Colonial Office, in the statements made by the voortrekkers, and in a series of lectures delivered in Pietermaritzburg in 1852-1855 by the Hon. Henry Cloete, whose statements as to the causes of the trek were founded on intimate knowledge and are impartially set forth. Piet Retief, the ablest of the leaders of the exodus, on the eve of leaving the colony published a declaration at Graham's Town, dated January 22nd 1837, in which he declared the chief reasons animating the emigrants to be:—

1. We despair of saving the colony from those evils which threaten it by the turbulent and dishonest conduct of vagrants, who are allowed to infest the country in every part; nor do we see any prospect of peace or happiness for our children in a country thus distracted by internal commotions.

2. We complain of the severe losses which we have been forced to sustain by the emancipation of our slaves, and the vexatious laws which have been enacted respecting them.

3. We complain of the continual system of plunder which we have ever endured from the Kaffirs and other colored classes, and particularly by the last invasion of the colony, which has desolated the frontier districts and ruined most of the inhabitants.

4. We complain of the unjustifiable odium which has been cast upon us by interested and dishonest persons, under the cloak of religion, whose testimony is believed in England to the exclusion of all evidence in our favour; and we can foresee, as the result of this prejudice, nothing but the total ruin of the country.¹

These four points correspond to the "three great grievances" under which the farmers suffered, enumerated by Cloete as (1) The Hottentot Question (*i.e.* the first and fourth points of Retief's manifesto combined); (2) The Slave Question; (3) The Kaffir Question. Enough has already been said as to the relations between the missionaries, the Boer farmers and the Hottentots; this grievance, however, "proved quite secondary to the intensity of feeling with which the colonists saw the steps taken by the government to deprive them of that labour (slave labour) over which they claimed an unquestionable right of property."² Then came the Kaffir War of 1834-1835, the reversal by the home government of the statesmanlike settlement of Sir Benjamin D'Urban, and the refusal of any compensation to the sufferers from the war, whose losses amounted to some £500,000. These, then, were the direct causes of the voluntary expatriation of the majority of the first trekkers, who included some of the best families in the colony, but they fail to explain the profound hostility to Great Britain which thereafter animated many, but not all, of the emigrants, nor do they account for the easy abandonment of their homes by numbers of the trekkers. The underlying fact which made the trek possible is that the Dutch-descended colonists in the eastern and north-eastern parts of the colony were not cultivators of the soil, but of purely pastoral and nomad habits, ever ready to seek new pastures for their flocks and herds, and possessing no special affection for any particular locality. In the next place these people, thinly scattered over a wide extent of territory, had lived for long under little restraint from the laws, and when in 1815, by the institution of "Commissions of Circuit," justice was brought nearer to their homes, various offences were brought to light, the remedying of which caused much resentment. An effort to bring a man named Frederick Bezuidenhout to justice led to armed resistance and finally to the hanging of five men at Slachter's Nek in circumstances that made an indelible impression throughout the frontier (see CAPE COLONY: *History*). It intensified in the minds of many Boers the feeling of hostility towards the British already existing; some of the trekkers in 1836-1840 had taken part in and others had passively aided the rebellion of 1815—"the most insane attempt ever made by a set of men to wage war against their sovereign" (Cloete, *op. cit.* p. 28). What, however, was probably the most powerful motive of the Great Trek was the equality established by the British between the black and white races. In the eyes of the Boers the possibility of equality between the whites and the natives was not

¹ See F. R. Cana, *South Africa from the Great Trek to the Union* (London, 1909), pp. 295-297 for the full text of Retief's manifesto.

² See H. Cloete, *The History of the Great Boer Trek* (London, 1899), p. 44.

admitted. This sentiment, which found formal recognition later on in the constitution of the South African Republic, was held in fullest force by the voortrekkers. Summing up, it may be said that the exasperation caused by just grievances unremedied was no stronger a motive with the trekkers than the desire to be free from the restraints imposed on British subjects and the wish to be able to deal with the natives after their own fashion.

The departure of so large a number of persons caused serious misgiving both to the Cape and the home governments. The trekkers had been told by the lieutenant-governor of the eastern province (Sir Andries Stockenström) that he was not aware of any law which prevented any British subject from settling in another country, and in the words of Piet Retief's declaration they quitted the colony "under the full assurance that the English government has nothing more to require of us, and will allow us to govern ourselves without its interference in future." The British government thought otherwise; they held that the trekkers could not divest themselves of their allegiance to the Crown. Moreover, though the farmers might leave British territory they were still held to be liable to the jurisdiction of British courts. An act passed in 1836 (the Cape of Good Hope Punishment Act) empowered the colonial courts to deal with offences committed by British subjects in any part of South Africa up to the 25th degree of south latitude. Intended by its authors to protect the native tribes from aggression on the part of white men and to check the exploration by Europeans of the lands of the Kaffirs, Bechuanas, &c., the act led in fact to the assertion of British authority in regions beyond the Cape frontier.

B. From the Foundation of the Republics to Majuba.—While the home government was seeking to prevent the expansion of the white races the first steps had been taken by a body of Englishmen to found a new colony at Natal. Since 1824 a few traders had been settled at Port Natal, and in 1834 formal petition was made that their settlement should be recognized as a British colony. The request was refused, and not long afterwards (1837) some of the Dutch emigrant farmers under Retief entered the country by way of the Drakensberg. Retief, like his English predecessors at Port Natal (known also since 1835 as Durban), sought a formal grant of territory from the chief of the Zulu nation, the Zulus being the acknowledged overlords of the tribes living in Natal. Retief and his party were, however, treacherously murdered by Dingaan, the Zulu king (February 1838). Other trekkers followed in the wake of Retief, and attacking Dingaan avenged the massacre.

The Boers then established a republican government at Maritzburg. Though most anxious to avoid any extension of responsibility in South Africa, Great Britain recognized the potential danger arising from the creation of an independent state on the coast. The Boers at first rejected offers of accommodation. Troops were then sent to the country, and finally a settlement was made by Henry Cloete, the British commissioner, with the Boer leaders, and Natal constituted a British colony in 1843. Many Boers, dissatisfied with this arrangement, withdrew beyond the Drakensberg. Natal shortly afterwards received a considerable number of emigrants from England, and the white inhabitants have since been predominantly British. At first Natal was dependent on Cape Colony. In 1856 it was constituted a separate colony, but it did not possess self-government until 1893. A notable departure from the labour policy of the other states was made by Natal in 1860, when Indian coolies were introduced. At the time the matter attracted little attention, but the Asiatic inhabitants speedily increased, and forty years later they outnumbered the whites (see NATAL).

It had taken the British government nearly ten years to decide on the annexation of Natal; its policy towards the Boers settled north of the Orange was marked by the same hesitation (see ORANGE FREE STATE). By 1847, when Sir Harry Smith became high commissioner, the failure of the treaty state policy was evident. Sir Harry, deeming no other course open to him, proclaimed (February 1848) the country between the Orange and Vaal

rivers British territory, under the name of the Orange River Sovereignty. Sir Harry had, in the previous December, extended the northern frontier of Cape Colony to the Orange, and had reoccupied the territory on the Kaffir border which D'Urban had been forced to abandon.¹ The

extension of British rule north of the Orange was opposed by Andries Pretorius, who, being defeated at Boomplaats, withdrew north of the Vaal, where, though not interfered with by the British, the Boers split up into several rival parties. In the Sovereignty difficulties arose in defining the reserves of the native chiefs, and with the Basutos there were armed conflicts. The home government (the first Russell administration), which had reluctantly consented to confirm Sir Harry Smith's annexation of the Orange River territory, on learning of these difficulties, and also that many of the burghers remained dissatisfied, changed their policy, and in 1851 the governor was informed that the ultimate abandonment of the Sovereignty was a settled point.² In fulfilment of their settled policy to keep the British South African dominions within the smallest possible limits, the cabinet decided to recognize the independence of the Boers living beyond the Vaal. This recognition, the necessary preliminary to the abandonment of the Orange River Sovereignty, was made

in the Sand River Convention on the 17th of January 1852. The Transvaal thus became an independent state, or rather it formed a number of mutually jealous communities, and it was not until 1864 that

Independence of the Transvaal Recognized.

they were all united. Despite their distracted condition the Transvaal Boers had no sooner obtained their independence than they began to make claims to authority in Bechuanaland. But the championship of the Bechuanas by Moffat, Livingstone and other missionaries, and their determination that the road to the interior should not be closed by the Boers, had its effect, and the Boers did not succeed in making themselves masters of the country (see TRANSVAAL: *History*, and BECHUANALAND). The British government meantime pursued its policy of abandonment, and in February 1854, by the Bloemfontein Convention, forced independence upon the people of the Sovereignty, which now became the Orange Free State. A clause was inserted in the Bloemfontein Convention stating that Great Britain had no alliance with any native chiefs or tribes to the north of the Orange, with the exception

Orange Free State.

of the Griqua chief Adam Kok. Numerous protests were made by many of the inhabitants of the Orange River Sovereignty against the abandonment of it by the British government, but the duke of Newcastle, who was then colonial secretary in Lord Aberdeen's administration, replied that the decision was inevitable (see ORANGE FREE STATE).

The abandonment of the Orange River Sovereignty marked the close of the eventful period in South African history which began eighteen years before with the Great Trek. At the beginning of that time there was but one civilized government in South Africa—Cape Colony; at its close there were five separate states or provinces, three, the Cape, Natal and British Kaffraria, owing allegiance to Great Britain, and two forming Boer republics—the Transvaal and Orange Free State. While vast additional territories had been occupied by British

Results of a Policy of Vacillation.

white races in South Africa, had been lost. Whether or not a wiser policy on the part of Great Britain would have secured the continued allegiance of all the Boers it is impossible to say; the fact that numbers of Boers remained in Natal under British rule, and that the majority of the Boers who settled between the Orange and the Vaal desired to remain British subjects, points to that conclusion. With justice the Boers complained of the course actually adopted by the British authorities. They might at the outset either have let the trek Boers go, and given them their blessing and liberty, or they might have controlled the trek and

¹ Part of the territory thus reannexed was added to Cape Colony while the region between the Keiskamma and Kei was created a separate territory under the name of British Kaffraria.

² Despatch of Earl Grey, dated October 21st, 1851, printed in *Correspondence Relative to the State of the Kaffir Tribes* (C. Feb. 1853).

made effective their contention that the trekkers were still British subjects. As has been demonstrated the action taken was one of vacillation between these two courses, and was complicated by a native policy which, though well intentioned and intelligible, needlessly irritated the white colonists (British and Dutch) and did not prevent bloodshed. In the words of Mr Paul Botha, a Boer writer, England first blew hot and then blew cold. But in 1854 a definite standpoint appeared to have been reached—Great Britain would confine her energies to the Cape and Natal, leaving the republics to work out their own destinies undisturbed. It was at this juncture that Sir George Grey was sent to the Cape as governor. A gifted and far-seeing man, he had no sooner arrived than he addressed himself with energy and diligence to the great problems awaiting him. His first care was to ameliorate the condition of Cape Colony. He resolved that in dealing with the natives on the eastern frontier an attempt should be made to civilize them and thus do away with the necessity of periodical warfare. Grey's efforts to promote good government in Kaffraria received unexpected help in consequence of the extraordinary delusion among the Ama-Xosa in 1856, which resulted in the death of many thousands of natives (see CAPE COLONY: *History*). Land left derelict was occupied by colonial farmers, and over 2000 German immigrants were introduced by Sir George and settled along the frontier (1858–1859). By this time the colonists of British descent predominated in the eastern provinces—a circumstance which had important bearings on the future of the colony.

Sir George Grey found it impossible to maintain a policy of total abstention from the affairs of the republics. The party in the Free State which had objected to independence being forced upon it was still strong and made overtures for union with the Cape; attempts were also made to unite the Free State and the Transvaal. In the conflicts between the Free Staters and the Basutos Grey's intervention was sought. All the evidence before Sir George, and the study he made of the Boer character, convinced him that the barriers separating the various white communities were largely artificial. He sought to remedy the mistake which had been made, and in 1858 he submitted a scheme of federation between the various South African states. In a memorable despatch to Sir E. Bulwer Lytton, then colonial secretary in the second Derby administration, he wrote (November 19, 1858):—

When the policy was adopted of dividing South Africa into many states, bound together by no ties of union, it was thought that the mother country derived no real benefit from the possession of this part of the African continent, except in holding the seaport of Simon's Bay. . . . It was further thought that the occupation by Great Britain of the country beyond the Orange River had been a bubble and a farce, in which the Cape colonists were all interested; for that it was to them a great gaming table and out of the reach of the police. . . . Although these European countries lying beyond our colonies are treated as separate nations, their inhabitants bear the same family names as the inhabitants of this colony, and maintain with them ties of the closest intimacy and relationship. . . . I think there can be no doubt that in any great public, or popular, or national question and movement the mere fact of calling these people different nations would not make them so, nor would the fact of a mere fordable stream running between them sever their sympathies or prevent them from acting in unison. . . . Experience has shown that the views which led to the dismemberment of South Africa were mistaken ones. . . . What therefore I would recommend would be that . . . measures should be taken which would permit of the several states and legislatures of this country forming among themselves a federal union.

When he penned this despatch Grey was well aware of the distraught condition of the Free State and the agitation for a change in its government. He held that the federation of that state with Cape Colony was preferable to its union or federation with the Transvaal, and it was with considerable satisfaction that he learned that on the 7th of December of the same year (1858) the Volksraad of the Free State had passed a resolution in favour of "a union or alliance with the Cape Colony" and sought to ascertain the views of the Cape legislature on the subject. In bringing the matter before the Cape parliament in March 1859 Grey stated that in his opinion it would confer a lasting

benefit upon Great Britain and upon the inhabitants of South Africa if it could succeed in devising a form of federal union. Unfortunately, Grey's views did not meet with the approval of the British government.¹ Had they been supported it is highly probable that federation would have been effected. But the golden opportunity was lost. When Grey attempted to persevere with his scheme he was recalled. He left Cape Town in August 1859, but on his arrival in England he found that there had been a change of ministry. The new colonial secretary, the duke of Newcastle, reinstated him, but with instructions not again to raise the federation issue. The first project for reunion thus came to naught, but from that time forward it was recognized in South Africa that federation would afford the best solution of most of the difficulties that beset the country. The Transvaal was perhaps the greatest sufferer through Grey's failure, that country continuing for years in a distracted condition. The Free State, under the guidance of Sir John Brand, who became president in 1864, attained a considerable measure of prosperity. Its difficulties with the Basutos were at last composed, and Moshesh and his people were in 1868 definitely taken under British protection. The policy of non-interference proclaimed in 1854 had proved impracticable, and the annexation of Basutoland was an open confession of the fact. In 1871 the country was annexed to Cape Colony, but its pacification proved a task of great difficulty.

Up to the year 1870 the Dutch considerably outnumbered the British inhabitants; indeed, save in Natal, in the eastern province and in Cape Town, the British inhabitants were comparatively few. The industries were almost entirely pastoral, and remained chiefly in the hands of the Dutch. The continual feuds with the Kaffirs, and also the continual desire to trek into new countries, all tended to keep back farming, and the country in the years 1867 to 1870 was in a generally very depressed condition. But in 1870 the era of commercial expansion began. In that year, following smaller finds of diamonds on the banks of the Vaal and Orange rivers, the diamond mines of Du Toits Pan and Bultfontein were opened up. In 1869 gold had been found in the Lydenburg and Zoutpansberg districts in the Transvaal, and diggers had resorted there from different parts of the world; moreover, in the far interior, in the territories of Mashonaland, Thomas Baines had reported discoveries of gold. Among the purely pastoral population ostrich-farming became a new industry and added a considerable asset to the wealth of Cape Colony. The revenue derived from the export of ostrich feathers in 1899 was recorded at half a million. It was, however, the discoveries of diamonds and gold that chiefly determined the development of the country. A large population grew up, first at Kimberley, afterwards at Barberton, and finally at Johannesburg—a population modern in its ideas, energetic, educated, cosmopolitan, appreciating all the resources that modern civilization had to offer them, and with a strong partiality for the life of the town or the camp rather than that of the farm and the veld. The majority of the Boers remained very much what they had been in the 17th century. Their life of continual strife with natives, continual trekking to fresh pastures, had not been conducive to education or the enlargement of intellectual outlook. In religion they were Calvinistic, fanatic, and their old traditions of Dutch East India government, together with their relation to the natives, developed a spirit of caste and even tyranny.

It was at this stage of affairs that responsible government was granted to Cape Colony (1872). From that time down to the annexation of the Transvaal in 1877, to quote the once more the homely phrase of Paul Botha, Great Britain "blew hot" in South Africa. A great change in public sentiment towards the colonies generally began to make itself felt in Great Britain in the late sixties and early seventies of the 19th century. The constitution of the Dominion of Canada (1867–1873) was an evidence of that feeling.

¹ Sir E. Bulwer Lytton wrote (Feb. 11, 1859): "H.M. Government are not prepared to depart from the settled policy of their predecessors by advising the resumption of British sovereignty in any shape over the Orange Free State."

*First Union
federation
Proposal.*

*Sir George
Grey.*

*Economic
Development.*

*The Carnar-
von Con-
federation
Scheme.*

With the advent to power of the Disraeli ministry in 1874 the nascent Imperial spirit grew in strength. Lord Carnarvon (the 4th earl), when under-secretary for the colonies in 1858-1859, had regarded Grey's federation proposal with disfavour, but later, as secretary of state, he had introduced the bill for the federation of the Canadian provinces. He now returned to the Colonial Office filled with the idea of doing for South Africa what had been done in British North America.¹ Recent events in South Africa had appeared for a brief period to favour a union of its various colonies and states. The intimation of the impending grant of self-government to Cape Colony was regarded by both Boer republics as bringing nearer the prospect of their union with the British colonies. But just at that time differences arose between Great Britain and the republics as to the ownership of the Kimberley diamond fields which estranged the Boers (see GRIQUALAND and TRANSVAAL). In the Transvaal Pretorius was succeeded by T. F. Burgers, a man totally unfitted to govern a country distracted by factions, harassed by wars with natives, and with an almost depleted exchequer. Yet in the condition of the Transvaal Lord Carnarvon found another argument in favour of federation. Union with the neighbouring states would, he thought, cure its ills and promote the general welfare of South Africa. As a preliminary step he accepted an offer from J. A. Froude to visit South Africa unofficially, and by travelling through its different states find out what were the obstacles to confederation and the means by which such obstacles could be removed. Froude landed at Cape Town on the 21st of September 1874, and having visited Natal, the Free State and Pretoria as well as Cape Colony, sailed for England on the 10th of January 1875. In the three and a half months he had spent in the country he had reached the conclusion expressed by the duke of Newcastle nearly twenty years previously, namely, that all England needed there was Table Bay—or the Cape peninsula—as a naval and military station. The South African states, he believed, might be left in internal affairs to work out their own future. These views coincided with those of Lord Carnarvon, who looked to federation as a means of relieving the Imperial government of some of the heavy responsibilities pressing upon it in South Africa, and he asked Froude to return to the Cape to take part in a conference in South Africa on the federation scheme. The offer was accepted, and Froude reached Cape Town again in June 1875. Lord Carnarvon's despatch (May 4, 1875), indicating his views, had preceded the arrival of Froude, and had incensed J. C. Molteno, the Cape premier, by its disregard of the colony's self-governing powers. A motion was carried in the Cape parliament affirming that any movement for federation should originate in South Africa and not in England. Froude on his arrival was much chagrined at the attitude taken by the Cape parliament, and conducted an oratorical campaign throughout the country in favour of federation. His speeches were lacking in judgment and tact, and created an unfavourable impression. The conference was not held, and Froude returned to England in the autumn.²

Lord Carnarvon was far from abandoning his plan. The Transvaal was now in a condition bordering on anarchy, and numbers of its inhabitants were supposed to be looking to Great Britain for help. Another party in the Transvaal was seeking alliances with Germany and Portugal, and this danger of foreign interference was a further cause for action. In August 1876 the colonial secretary assembled a conference on South African affairs in London, nominating Froude as representative of Griqualand West. President Brand represented the Free State. Another member of the conference was Sir Theophilus Shepstone, (*q.v.*) Neither Cape Colony nor the Transvaal was represented,

¹ At Sir Henry Barkly's request Lord Carnarvon's predecessor, Lord Kimberley, had in November 1871 given him (Sir Henry) authority to summon a meeting of representatives of the states and colonies to consider the "conditions of union," but the annexation of the diamond fields had occurred meantime and Sir Henry thought the occasion inopportune for such a conference.

² For Froude's views and actions, see especially the blue book C. 1399 (1876), containing his report to Lord Carnarvon.

and the conference was abortive, President Brand having no permission from his state to consider federation. That subject was, in fact, not discussed by the delegates. In view of the troubles in the Transvaal, and in furtherance of Carnarvon's federation scheme, Shepstone was, on the 5th of October following, given a dormant commission to annex the republic "if it was desired by the inhabitants and in his judgment necessary." The secretary of state sought the aid of Sir Bartle Frere as his chief agent in carrying through confederation, the then governor of Cape Colony and high commissioner for South Africa, Sir Henry Barkly, sharing the views of the Cape ministry that the time was inopportune to force such a step upon South Africa. In a letter dated the 13th of October, offering Frere the post Barkly was about to vacate, Lord Carnarvon wrote:—

... The war between the Transvaal republic and the natives has had this further effect, it rapidly ripened all South African policy. . . . It brings us near to the object and end for which I have now for two years been steadily labouring—the union of the South African colonies and states. I am indeed now considering the details of a bill for their confederation, which I desire to introduce next session, and I propose to press, by all means in my power, my confederation policy in South Africa.

The time required for the work of confederating and of consolidating the confederated states Lord Carnarvon estimated at not more than two years, and he was sanguine enough *First* to hope that Frere would stay on at the Cape for *Annexation* two or three years "as the first governor-general *of the* of the South African dominion." Frere accepted *Transvaal* the offer, but did not leave England until March 1877. Shepstone preceded him, and in January 1877 had gone to Pretoria. His conferences with the leading men in the Transvaal and a consideration of the dangers which threatened it and the grave disorders within its borders satisfied Shepstone that he had no choice except to act upon his commission, and on the 12th of April he issued a proclamation annexing the country to the British Crown. During the interval between Shepstone's arrival in the country and the annexation the Volksraad had rejected the proposals for confederation laid before them in accordance with Lord Carnarvon's permissive bill, and had made no real attempt at reform. The annexation was acquiesced in by a considerable number of the white inhabitants. Shepstone was convinced that it was the only step which could save the country from ruin. The subject is discussed at greater length under TRANSVAAL. Frere, who had reached Cape Town on the 31st of March, learnt on the 16th of April that the annexation had taken place. He was inclined to regard Shepstone's act as premature, and he realized that it stirred very deeply Dutch national feeling throughout South Africa. Though anxious to promote Carnarvon's policy, Frere found that native affairs called for immediate attention. The Basuto and Kaffir tribes were giving trouble, and the 40,000 trained Zulu warriors under Cetywayo threatened the peace both of Natal and the Transvaal. In the same month (Aug. 1877) in which the British parliament passed the act, foreshadowed by the secretary of state, "for the union under one government of such of the South African colonies and states as may agree thereto," another war with the Kaffirs broke out. This conflict lasted until May 1878, and largely absorbed the energies of Sir Bartle Frere.³ In the meantime a scheme of unification, as opposed to federation, put forward by the Molteno ministry—a scheme which in its essence anticipated the form of government established in 1910—had met with no support from Frere or the home ministry. In January 1878 Lord Carnarvon resigned, and the driving force of the federation scheme thus disappeared. It was not, however, finally dropped until 1880. In July of that year proposals for a confederation conference were submitted to the Cape parliament. At that time Paul Kruger and Piet Joubert, delegates from the Transvaal Boers, were in Cape Town, and they used their influence to prevent the acceptance of the proposals, which were shelved by the ministry accepting "the

³ Serious troubles with the Basutos which began in 1879 reacted on the situation in the Transvaal and Natal. These troubles were finally ended in 1884, when the country was given up by the Cape and became a crown colony (see BASUTOLAND).

previous question" (June 29). Thus ended an attempt which lacked the element essential to success—spontaneity.

Confederation had, for the time being, ceased to be a living issue some time before its formal shelving by the Cape parliament. The Kaffir War of 1878 was followed by war with the Zulus. Frere, believing that the Zulu power was a standing menace to the peace of South Africa, and that delay in dealing with Cetywayo would only increase the danger, sent an ultimatum to the chief in November 1878. The invasion of Zululand began in January 1879, and was speedily followed by the disaster at Isandhlwana and by the defence of Rorke's Drift and of Eshowe. But at the battle of Ulundi in July the Zulu power was crushed, and a little later Cetywayo was taken prisoner (see ZULULAND: *History*). The removal of the Zulu danger did not, however, restore harmony between the British and the Boers in the Transvaal. The malcontent Boers became a powerful element in the country. They were largely influenced by an important section of the Dutch community in western Cape Colony, which carried on a campaign against annexation, seeing in it a blow to the ideal they had begun to entertain of a united South Africa of a Dutch republican type. Sir Garnet Wolseley, at this period (June 1879–May 1880) high commissioner of South-East Africa, gave the Transvaal a legislative council, but the members were all nominated. This could not be regarded as a redemption of the promise of a liberal constitution, and it had an injurious, though limited, effect on the Boer community.¹ After the receipt in December 1879 of the reports of Mr Gladstone's speeches during his Midlothian campaign—in which he denounced annexation as obtained by means dishonourable to Great Britain—the Boers expected nothing less than the retrocession of the country.

There was one strong reason against retrocession, concerning which the Boers—if they gave it thought—would naturally be silent. To the British mind in general it was apparently non-existent. It had, however, been seen and its strength recognized by Sir Garnet Wolseley during his brief governorship of the Transvaal. Wolseley, in a despatch dated the 13th of November 1879 said:—

The Transvaal is rich in minerals; gold has already been found in quantities, and there can be little doubt that larger and still more valuable goldfields will sooner or later be discovered. Any such discovery would soon bring a large British population here. The time must eventually arrive when the Boers will be in a small minority, as the country is very sparsely peopled; and would it not therefore be a very near-sighted policy to recede now from the position we have taken up here, simply because for some years to come the retention of 2000 or 3000 troops may be necessary to reconsolidate our power.

As Lord Morley in his *Life of Gladstone* says, "this pregnant and far-sighted warning seems to have been little considered by English statesmen of either party at this critical time or afterwards, though it proved a vital element in any far-sighted decision."

The result of the general election of 1880 was to place Mr Gladstone in power. The new administration, notwithstanding Mr Gladstone's public utterances, declared their intention of retaining British sovereignty in the Transvaal, coupling with that decision a pious hope for the speedy accomplishment of confederation so as to allow of free institutions being given to Natal and the Transvaal.² The disillusionment occasioned by this decision caused the Boer delegates then at the Cape to help to wreck the federation proposals (see *supra*). But if unwilling at the time to undo the work of Sir T. Shepstone, the Liberal cabinet were prepared to get rid of the chief British representative in South Africa—partly to please the extreme Radicals among their followers. Accordingly on the 2nd of August 1880 Frere received a telegraphic despatch from Lord

¹ Had Shepstone's promise been redeemed at an early date, it might well have extinguished the agitation for independence.

² It is remarkable that the Liberal government, despite this aspiration, and despite stronger language used by Mr Gladstone, did nothing to give the Boers any real self-government. Sir Bartle Frere pressed the new administration, as he had the Conservative government, on this point without effect.

Kimberley (the new secretary of state for the colonies) announcing his recall.³ Frere's task was one of extreme delicacy; he chose to face difficulties rather than evade them, and had he been unfettered in his action might have accomplished much more than he was able to do; in its main lines his policy was sound. (See FRERE, SIR HENRY BARTLE.)

Finding that the Gladstone administration would not give up the Transvaal voluntarily, the Boers now determined on rebellion. Hostilities began in December 1880, and eventually a series of engagements ended in the rout (Feb. 27, 1881) of a small British force which had occupied Majuba Hill the previous evening. The killed included the general in command, Sir George Colley. Meanwhile the resolution of Mr Gladstone and his colleagues to keep the Transvaal had been shaken by the Boer declaration of independence. After the first engagements this resolution was further weakened; and when, after a British reverse at Ingogo (Feb. 8), overtures were made by Mr Kruger on behalf of the Boers, the cabinet was strongly inclined to come to terms. The news of Majuba did not turn it from its purpose. Opinions will always differ as to the course adopted by the Liberal government. "We could not," wrote Mr Gladstone, "because we had failed on Sunday last, insist on shedding more blood." It is at all events abundantly clear that had the Boers not resorted to arms they would not have gained the support of the cabinet.⁴

Sir Evelyn Wood, who had succeeded Colley as general in command and governor of Natal, under instructions from home, concluded a treaty of peace on the 22nd of March. The terms agreed upon were elaborated in a convention signed at Pretoria in August following. By this instrument the Transvaal was granted self-government subject to British suzerainty and the control of the foreign relations of the state. In 1884 the Gladstone administration made further concessions by the London convention of that year. This last document still, however, reserved for Great Britain certain rights, including the power of veto over treaties concluded by the Transvaal with any power other than the Orange Free State. But the success of the Transvaal Boers both in war and diplomacy had quickened the sense of racial unity among the Dutch throughout the country, and there arose a spirit of antagonism between the Dutch and the British which affected the whole future of South Africa.

Before, however, dealing with the relations between the British and the Boers subsequent to 1881 brief reference may be made to affairs in which other powers were concerned; affairs which were the prelude to the era of expansion associated with the career of Cecil Rhodes. In 1868 the Europeans in Great Namaqualand and Damaraland petitioned for annexation to Great Britain. Eventually (1878) only Walfish Bay and a small strip of adjacent territory were annexed. In 1883 Germany entered the field and during 1884–1885, owing to the procrastinating policy of the Cape and British governments, all the coast between the Orange and the Portuguese frontier, save Walfish Bay, was placed under German protection (see AFRICA, §5). The eastern boundary of German South-West Africa was fixed in 1890, the frontier running through the Kalahari Desert. Bechuanaland, the region between the German colony and the Transvaal, was secured for Great Britain. It was not on the west coast only that Germany made efforts to secure a footing in South Africa. In September 1884 an attempt was made to secure St Lucia Bay, on the coast of Zululand. Here, however, Great Britain stood firm. St Lucia Bay had been ceded to the British by the Zulu king Panda in 1843, and this cession has always been regarded as valid. Eventually Germany agreed to make no annexation on the east coast of Africa south of Delagoa Bay. With the proclamation of a British protectorate over the coast of Pondoland in January 1885 the coast-line from the

³ Frere sailed for England on the 15th of September. His successor, Sir Hercules Robinson, reached the Cape at the end of January 1881.

⁴ Morley's *Life of Gladstone*, bk. viii. ch. 3, "Majuba."

mouth of the Orange to Delagoa Bay (save for the small stretch of Amatonga shore-line) became definitely British.

To Delagoa Bay, or rather to the southern part of the bay, Great Britain had laid unsuccessful claim. On the northern

Delagoa Bay. bank of the chief estuary of the bay the Portuguese had from the 16th century onward maintained a precarious foothold; it was their most southerly station on the east coast of Africa. In 1823 treaties had been concluded by the British with tribes inhabiting the southern shores of the bay. Neither the Portuguese nor the British claims seemed of much importance until the rise of the South African republic. Anxious for a seaport, the Transvaal Boers in turn laid claim to Delagoa Bay. This brought the dispute between Great Britain and Portugal to a head, the matter being referred in 1872 to the president of the French republic for arbitration. In 1875 an award was given by Marshal MacMahon entirely in favour of the Portuguese (see DELAGOA BAY). As a port outside British control Delagoa Bay was a source of strength to the Boers, especially as the railway¹ was under their control. In the war which began in 1899 munitions of war and recruits for the Boers were freely passed through Delagoa Bay.

C. The Struggle for Supremacy between British and Dutch.—Bechuanaland, through which territory runs the route to the **Bechuana-land** far interior—the countries now known as Rhodesia **Annexed.**—was acquired, despite the strong desire of the Gladstone administration to avoid further annexations in South Africa. At first the encroachments on Bechuana territory by Boers from the Transvaal were looked upon with comparative indifference. The Boers respected neither the frontier laid down by the Pretoria convention nor that (modified in their favour) drawn in the London convention. But missionary influence was strong; it was reinforced by the growing strength of the imperialistic spirit and by the fears excited by Germany's intrusion on the south-west coast. An expedition was sent out in October 1884 under Sir Charles Warren; the Boers, who had set up the "republics" of Goshen and Stellaland, were obliged to give way, and the country was annexed (see BECHUANALAND). It was in connexion with this affair that Cecil Rhodes first came into prominence as a politician. As a member of the Cape parliament he undertook a mission, before the arrival of Warren, to the Goshen and Stellaland Boers, endeavouring, unsuccessfully, to obtain from them a recognition of British sovereignty. The acquisition of Bechuanaland by Great Britain was the essential preliminary to the development of the schemes which Rhodes entertained for the extension of British rule into Central Africa. In his endeavours to realize this aim he had to contend with the new spirit of national consciousness animating the Boers, which found expression in the formation of the Afrikaner Bond.

In its external, as in most of its internal policy, the Transvaal was controlled from 1881 onward by Paul Kruger, who was elected president of the state in 1883. Yet **The Afrikaner Bond.** Kruger was scarcely the real leader in the nationalist movement to which the successful revolt of 1880-81 gave strength. The support given by the Cape Colony Dutch to the malcontent Transvaal Boers has already been mentioned. During the 1880-81 revolt many Free State burghers, despite the moderating influence of President Brand, joined the Transvaal commandoes. Now a definite effort was made to build up a united South Africa on anti-British lines. In the latter part of 1881 a Dutch pastor at the Paarl, a town in western Cape Colony named Du Toit, in a paper called *De Patriot*, suggested the organization of an Afrikaner Bond; in the same year Carl Borckenhagen, a German resident in the Free State, advocated such a bond in his paper, the *Bloemfontein Express*. The Bond was formed, its work being almost confined to Cape Colony. It held its first congress at Graaf Reinet in 1882. In the "programme of principles" upon which its constitution was modelled it was set forth that:

¹For the international difficulties connected with the building of the railway from Delagoa Bay to Pretoria see LOURENÇO-MARQUES.

While in itself acknowledging no single form of government as the only suitable form, and whilst acknowledging the form of government existing at present [the Bond] means that the aim of our national development must be a united South Africa under its own flag.

In the following year the Farmers' Protection Association was amalgamated with the Bond, and the joint organization fell under the control of J. H. Hofmeyr, the leader of the Dutch party in Cape Colony. Under Hofmeyr's politic control all declarations inconsistent with allegiance to the British Crown were omitted from the Bond's constitution. It remained, however, a strong nationalist organization, which in practice was inimical not so much to the British connexion as to the British section of the population and to the development of the country on enlightened lines. (For the Afrikaner Bond see further CAPE COLONY: *History*, and HOFMEYR.)

Not long after the Warren expedition the valuable gold fields which Sir Garnet Wolseley had foreseen would be discovered in the Transvaal were actually found. By 1886, the year in which Johannesburg was founded, the wealth of the Witwatersrand fields was demonstrated. The revenue which these discoveries brought into the Transvaal treasury increased the importance of that state. The new industrial situation created had its effect on all parties in South Africa, and in some measure drew together the British and Dutch sections outside the Transvaal. A customs union between Cape Colony and the Free State was concluded in 1889, to which later on all the other South African states, save the Transvaal, became parties. But Kruger remained implacable, bigoted, avaricious, determined on a policy of isolation. In 1887 he made proposals for an alliance with the Free State. Brand refused to be ensnared in Kruger's policy, and the negotiations led to no agreement. (For details of this episode see ORANGE FREE STATE: *History*.) Not many months afterwards (July 1888) the Free State lost by death the wise, moderating guidance of Sir John Brand. The new president, F. W. Reitz, one of the founders of the Bond, in 1889 committed the Free State to an offensive and defensive alliance with the Transvaal. Kruger thus achieved one of the objects of his policy. Within the Transvaal a great change was coming over the population. There flocked to the Rand many thousands of British and other Europeans, together with a considerable number of Americans. This influx was looked upon with disfavour by Kruger and his supporters, and, while the new comers were heavily taxed, steps were speedily taken to revise the franchise laws **Kruger's Hostility to the Uitlanders.** so that the immigrants should have little chance of becoming burghers of the republic. This exclusion policy was even applied to immigrants from the other South African countries. A system of oppressive trade monopolies was also introduced. The situation with which the Boers were called upon to deal was one of great difficulty. They could not keep back the waves of the new civilization, they feared being swamped, and they sought vainly to maintain intact their old organization while reaping the financial benefit resulting from the working of the gold mines. The wider outlook which would have sought to win the Uitlanders (as they were called) to the side of the republic was entirely lacking. The policy actually followed was not even stationary; it was retrogressive.

Meanwhile, and partly through distrust of the Kruger policy, there was growing up in Cape Colony a party of South African Imperialists, or, as they have been called, Afrikaner Imperialists, who came to a large extent under the influence of Cecil Rhodes. Among these were **Afrikaner Imperialists.** W. P. Schreiner (afterwards premier of the colony) and J. W. Leonard (sometime attorney-general) and, to some extent, Hofmeyr. From the time of his entrance into politics Rhodes endeavoured to induce the leading men in the country to realize that a development of the whole country could and should be accomplished by South Africans for South Africans. He fully admitted that the cry which had become so popular since 1881 of "Africa for the Afrikaners" expressed a reasonable aspiration, but he constantly pointed out that its fulfilment could most

advantageously be sought, not, as the Kruger party and extremists of the Bond believed, by working for an independent South Africa, but by working for the development of South Africa as a whole on democratic, self-reliant, self-governing lines, under the shelter of the British flag. Hofmeyr was among those whom Kruger's attitude drove into a loose alliance with Rhodes. In 1884, having the power in his hands when the Scanlen ministry fell, Hofmeyr had put into office a ministry dependent upon the Bond, and had talked of a possible Dutch rebellion in Cape Colony if the Boer freebooters in Bechuanaland were ejected; in 1890 Rhodes became premier with Hofmeyr's approval and support. Rhodes remained in office as prime minister until January 1896. During these six years the part he played in the development and public life of South Africa was greater than that of any other man. He used his period of power to put into execution his plans for the extension of British dominion over the country up to the Zambezi.

In 1888 Rhodes had succeeded in inducing Sir Hercules Robynson, the high commissioner, to allow J. S. Moffat, the **British South Africa Company**, British resident at Bulawayo, to enter into a treaty with Lobengula, the Matabele chief. Under this treaty Lobengula bound himself not to make a treaty with any other foreign power, nor to sell or in any other way dispose of any portion of his country without the sanction of the high commissioner. This step prevented the country from falling into the hands of Germany, Portugal or the Boers. The treaty was followed by the formation of the British South Africa Company, which obtained a royal charter in 1889, and by the occupation of Mashonaland in 1890. Difficulties with the Portuguese followed, but the Salisbury administration firmly upheld British claims, with the result that the British sphere of influence was extended not only to the Zambezi but beyond to the shores of Lake Tanganyika (see AFRICA: § 5). In 1893 a war was fought with the Matabele by Dr L. S. Jameson, then administrator of Mashonaland, and Bulawayo was occupied. The name Rhodesia was conferred upon the country in 1894 (see RHODESIA). Living in Cape Town and at the head of the government, Rhodes used every effort to demonstrate to the Cape Colonists that the work he was doing in the north must eventually be to the advantage of Cape Colonists and their descendants. On the whole, Hofmeyr and his friends were well pleased at having secured the co-operation of the "big Englishman" Rhodes, or, as he was at one time called by Mr J. X. Merriman,¹ an old parliamentary hand and treasurer-general during part of Rhodes's premiership, the "young burgher."

In 1891 the Bond Congress was held at Kimberley, and harmony appeared to reign supreme. During his term of office Mr Rhodes addressed himself to bringing together all interests, as far as it was practicable to do so. He showed that his views of the situation were broad and statesmanlike. His handling of the native question in Cape Colony gave general satisfaction. Rhodes was also a firm believer in the federation of the South African states and colonies, and he sought to promote this end by the development of inter-state and inter-colonial railway systems, and the establishment of common customs, tariffs, and inter-colonial free trade under a customs union.² The persistent opponent to both these measures was the Transvaal. In matters of domestic legislation, such as taxation and excise, Rhodes fell in to a considerable extent with Dutch prejudices.

While in the rest of South Africa there was a growing feeling of trust between the Dutch and British, accompanied by increasing trade and the development of agriculture, the condition of the Transvaal was becoming serious. At first the new-comers to the Rand had submitted to the economic and political burdens to which they were subjected, but as they grew in numbers and found their

burdens increased they began to agitate for reforms. In 1892 (the year in which the railway from Cape Town reached the Rand), the National Union was founded at Johannesburg by ex-Cape Colonists of the Imperial progressive party. For three years petitions and deputations, public meetings and newspaper articles, the efforts of the enlightened South African party at Johannesburg and Pretoria, were all addressed to the endeavour to induce President Kruger and his government to give some measure of recognition to the steadily increasing Uitlander population. Urgent representations were also made by the British government. President Kruger remained as impenetrable as adamant. Nine-tenths of the state revenue was contributed by the Uitlanders, yet they had not even any municipal power. By a law of 1882 aliens could be naturalized and enfranchised after a residence in the country of five years, but between 1890 and 1894 the franchise laws were so altered as to render it practically impossible for any foreigner to become a burgher. By the law of 1894 the immigrant must have been at least 14 years in the country and be 40 years old before in the most favourable circumstances he could be admitted to the franchise. The Uitlanders once more petitioned, over 34,000 persons signing a memorial to the Raad for the extension of the franchise. The appeal was refused (August 1895). Up to this period a section of the Uitlanders had believed that Kruger and his following would listen to reason; now all realized that such an expectation was vain. Rhodes, who had large interests in the Rand mines, had consistently endeavoured to conciliate the extreme Boer section in the Transvaal and win it over (as had happened in the case of the Cape Dutch) to a policy which should benefit the whole of South Africa. He was even willing to see the Transvaal obtain a seaport (at Kosi Bay, in Amatongaland) if in return it would join the customs union. This opportunity Kruger let slip; and in May 1895, on the representation of Sir H. Loch, the Rosebery administration annexed Amatongaland, thus making the British and Portuguese frontier continuous. This action, finally blocking the Boer road to the sea, taken by a Liberal government, was clear indication that Great Britain was determined to maintain her supremacy in South Africa.

The situation in August 1895 was thus one of extreme tension. There had been a change of ministry in Great Britain and Joseph Chamberlain had become colonial secretary. Sir Hercules Robynson, who was regarded sympathetically by the Dutch population of South Africa, had succeeded Loch as high commissioner. Both high commissioner and the imperial government were hopeful that Kruger might even yet be induced to modify his policy; the Uitlanders now entertained no such hope and they prepared to appeal to arms to obtain redress of their grievances. The first proposals for an armed rising came from Rhodes in June, but it was not until November that the Uitlander leaders came to a definite understanding with the Cape premier as to the course to be pursued. To lay before South Africa the true position of affairs in the Transvaal Charles Leonard issued a manifesto as chairman of the National Union. It concluded with a list of demands (see TRANSVAAL), their gist being "the establishment of this republic as a true republic" with equitable franchise laws, an independent judiciary and free trade in South African products.

This manifesto, issued on the 26th of December, called a public meeting for the night of Monday the 6th of January 1896, "not with the intention of holding the meeting, but as a blind to cover the simultaneous rising in Johannesburg and seizing of the arsenal in Pretoria on the night of Saturday the 4th of January" (Fitzpatrick, *The Transvaal from Within*, ch. iii.). Had the Transvaal government given way, even at the last hour, the reformers would have been satisfied. Of this, however, there was no expectation. The arrangement with Rhodes included the use of an armed force belonging to the Chartered Company, and led by Dr Jameson. Accordingly some troops were brought from Rhodesia and stationed near Mafeking, a few miles from the Transvaal frontier. For some weeks the plot appeared to progress

¹ Mr Merriman (b. 1841) was a son of N. J. Merriman (1810-1882), bishop of Graham's Town. He was a member of various Cape ministries from 1875 onwards.

² For Rhodes's scheme of commercial federation see further CAPE COLONY: *History*.

favourably. It might have succeeded but for a vital difference which arose between the Uitlanders in Johannesburg and Rhodes. As Charles Leonard's manifesto stated, the reformers as a body, desired to maintain the autonomy of the Transvaal and the republican form of government; Rhodes wished the revolution to be accomplished under the British flag.¹ "I was not going to risk my position," he stated subsequently, "to change President Kruger for President J. B. Robinson" (the only prominent Uitlander who stood aloof from the reform movement). This divergence of views manifested itself on Christmas Day 1895, and although, under pressure, Rhodes did not insist on the British flag, it was determined to postpone the rising. Jameson was so informed, nevertheless he precipitated the crisis by invading the Transvaal on the evening of December the 29th. The Transvaal government, meantime, had obtained some knowledge of what was being projected, and the Raid ended in a forced surrender (January 2, 1896) to a superior force of Boers. The Reform Committee, *i.e.* the Uitlander leaders, after holding Johannesburg for over a week, also surrendered, and by the 9th of January the plot had ended in complete failure. Mr Chamberlain still desired Kruger to grant immediate reforms and propounded a scheme of "Home Rule" for the Rand. The time was inopportune, however, for pressing the Transvaal on the subject, and nothing was done.²

The Jameson raid had a profound effect on the history of South Africa. It greatly embittered racial feeling throughout the country; it threw the Free State Boers completely on to the side of the Transvaal; it destroyed the alliance between the Dutch in Cape Colony and the Imperialists led by Rhodes. It did more, it divided British opinion, sympathy for the Boer republics leading in some cases to a disregard for the real grievances of the Uitlanders. It also gave a much desired opportunity for the intrusion of other powers in the affairs of the Transvaal;³ and it led Kruger to revive the scheme for a united South Africa under a Dutch republican flag. This scheme found many supporters in Cape Colony. A suspicion that the Colonial Office in London was cognizant of Rhodes's plans further excited Dutch national feeling, and the Bond once more became actively anti-British. Rhodes had resigned the premiership of the Cape a few days after the Raid, and during the greater part of 1896 was in Rhodesia, where he was able to bring to an end, in September, a formidable rebellion of the Matabele which had broken out six months previously.

A section of the Dutch population was not however disposed to sacrifice the development of industries and commerce for racial considerations; while sharing the political aspirations of Kruger and Steyn the wiser among them wished for such a measure of reform in the Transvaal as would remove all justification for outside interference. Nevertheless the cleavage at the Cape between the Dutch and British grew. Sir Gordon Sprigg, who had become Premier of Cape Colony in succession to Rhodes, found his position untenable, and in October 1898 he was succeeded by a Bond ministry under Mr W. P. Schreiner. The term "Progressive" was now formally adopted by the British mercantile communities in the large towns and among the sturdy farmers of British descent in the eastern province. On returning to South Africa after the Raid inquiry at Westminster in 1897,

¹ In his evidence before the House of Commons Select Committee which inquired into the Raid, Rhodes did not object to the continued existence of the republic "for local matters," but desired a federal South Africa under the British flag; see Blue Book (165) 1897 p. 21; also Sir Lewis Michell's *Life of Rhodes*, vol. ii. ch. xxx.

² Jameson and the other raiders were handed over to the British government for punishment. Four of the Reform leaders were condemned to death on the 27th of April, but the sentence was commuted to a fine of £25,000 each. For details of the Reform movement and Jameson Raid see *TRANSVAAL: History*.

³ Rhodes informed the House of Commons Select Committee that the belief that the Boers intended to introduce the influence of another foreign power in the already complicated system of South Africa "greatly influenced" him in promoting the revolt. Germany at the time of the Raid was prepared to intervene, and on the 3rd of January 1896 the German Emperor, by telegram, congratulated Kruger that "without appealing to the help of friendly powers" the Boers had overcome Jameson.

Rhodes had intended to withdraw from Cape politics and devote his energies for a time entirely to Rhodesia, but the pressure put upon him by a section of the British colonists was so strong that he determined to throw in his lot with them.

In the Transvaal, meantime, the situation of the Uitlanders grew worse. The monopoly and concessions regime continued unchecked, the naturalization laws were not amended, while the judicature was rendered subservient to the executive (see *TRANSVAAL: History*). The gold mining industry was fostered only so far as it served to provide revenue for the state, and large sums from that revenue were used in fortifying Pretoria and in the purchase of arms and ammunition. This process of arming the republic had begun before the Raid; after that event it was carried on with great energy and was directed against Great Britain. Kruger also sought (unsuccessfully) to have the London Convention of 1884 annulled, and he entered into a closer union with the Free State. Great Britain watched the development of Kruger's plans with misgiving, but except on points of detail it was felt for some time to be impossible to bring pressure upon the Transvaal. The retirement of Lord Rosemead (Sir Hercules Robinson) from the post of high commissioner was, however, taken advantage of by the British government to appoint an administrator who should at the fitting opportunity insist on the redress of the Uitlanders' grievances.

Sir Alfred Milner (see *MILNER, VISCOUNT*), the new high commissioner, took up his duties at the Cape in May 1897. He realized that one of the most potent factors in the situation was the attitude of the Cape Dutch, and in March 1898 at Graaff Reinet Milner called upon the Dutch citizens of the Cape, "especially those who had gone so far in the expression of their sympathy for the Transvaal as to expose themselves to charges of disloyalty to their own flag" to use all their influence, not in confirming the Transvaal in unjustified suspicions, not in encouraging its government in obstinate resistance to all reform, but in inducing it gradually to assimilate its institutions, and the temper and spirit of its administration, to those of the free communities of South Africa, such as Cape Colony or the Orange Free State. Moreover the Graaff Reinet speech showed that Milner was aware of the dangerous policy being followed by the Bond. The Dutch party at the Cape was shown to be incurring a heavy responsibility, especially as its leaders were aware, in the words of Mr J. X. Merriman, of "the inherent rottenness" of the Kruger régime. That party soon afterwards had it in its power to bring pressure officially upon President Kruger, for it was a few months after the delivery of the speech that Mr Schreiner became premier. To some extent this was done—but in a manner which led the Transvaal Boers to count in any event on the support of the Cape Dutchmen. In the Transvaal, as has been said, affairs were steadily going from bad to worse. An Industrial Commission, appointed (under pressure) by President Kruger in 1897 to inquire into a number of grievances affecting the gold industry, had reported in favour of reforms. The recommendations of the commission, if adopted, would have done something towards relieving the tension, but President Kruger and his executive refused to be guided by them. Once more the Uitlanders determined to make a further attempt to obtain redress by constitutional means, and the second organized movement for reform began by the formation in 1897 of a branch of the South African League.

At the end of 1898 the feelings of the Uitlanders were wrought up to fever pitch. The police service, which was violent where it should have been reasonable, and blind where it should have been vigilant, had long been a source of great irritation. On the 18th of December a Boer policeman, in pursuit of an Englishman named Edgar, whom he wished to arrest for an alleged assault on another man, entered his house and shot him dead. The deepest indignation was aroused by this incident, and was still further increased by the trivial way in which the case was dealt with by the court. The killing of Edgar was followed by

Milner
appointed
High Commissioner.

Second Transvaal Reform Movement.

the breaking up of a public meeting at Johannesburg, and in March the Uitlanders handed to the high commissioner a petition for intervention with 21,684 signatures attached to it (see TRANSVAAL: *History*).

On the 4th of May 1899 Sir Alfred Milner felt it his duty to report at some length by cable to Mr Chamberlain. The concluding passages of this message, which summed up the whole South African situation in a masterly manner, were as follows:—

The case for intervention is overwhelming. The only attempted answer is that things will right themselves if left alone. But, in fact, the policy of leaving things alone has been tried for years, and it has led to their going from bad to worse. It is not true that this is owing to the Raid. They were going from bad to worse before the Raid. We were on the verge of war before the Raid, and the Transvaal was on the verge of revolution. The effect of the Raid has been to give the policy of leaving things alone a new lease of life, and with the old consequences.

The spectacle of thousands of British subjects kept permanently in the position of helots, constantly chafing under undoubted grievances, and calling vainly to Her Majesty's government for redress, does steadily undermine the influence and reputation of Great Britain, and the respect for British government within the queen's dominions. A certain section of the press, not in the Transvaal only, preaches openly and constantly the doctrine of a republic embracing all South Africa, and supports it by menacing references to the armaments of the Transvaal, its alliance with the Orange Free State, and the active sympathy which, in case of war, it would receive from a section of Her Majesty's subjects. I regret to say that this doctrine, supported as it is by a ceaseless stream of malignant lies about the intentions of the British government, is producing a great effect upon a large number of our Dutch fellow-colonists. Language is frequently used which seems to imply that the Dutch have some superior right even in this colony to their fellow-citizens of British birth. Thousands of men peaceably disposed and, if left alone, perfectly satisfied with their position as British subjects, are being drawn into disaffection, and there is a corresponding exasperation on the side of the British.

I can see nothing which will put a stop to this mischievous propaganda but some striking proof of the intention of Her Majesty's government not to be ousted from its position in South Africa. And the best proofs alike of its power and its justice would be to obtain for the Uitlanders in the Transvaal a fair share in the government of the country which owes everything to their exertions. It could be made perfectly clear that our action was not directed against the existence of the republic. We should only be demanding the re-establishment of rights which now exist in the Orange Free State, and which existed in the Transvaal itself at the time of, and long after, the withdrawal of British sovereignty. It would be no selfish demand, as other Uitlanders besides those of British birth would benefit by it. It is asking for nothing from others which we do not give ourselves. And it would certainly go to the root of the political unrest in South Africa; and though temporarily it might aggravate, it would ultimately extinguish the race feud, which is the great bane of the country.

In view of the critical situation Milner and Kruger met in conference at Bloemfontein on the 31st of May. Milner practically confined his demands to a five years' franchise, which he hoped would enable the Uitlanders to work out their own salvation. On his side Kruger put forward inadmissible demands (see TRANSVAAL), and the conference broke up on the 5th of June without any result. A new franchise law, on a seven years' naturalization basis, was passed in July by the Transvaal volksraad, but the law was hedged about with many restrictions. Messrs Hofmeyr and Herholdt, the one the leader of the Bond and the other the Cape minister of agriculture, visited Pretoria to reason with Kruger. They found him deaf to all arguments. The fact is that the Boers had made up their minds to a trial of strength with Great Britain for supremacy in South Africa. At the time which from a military standpoint they thought most opportune (October 9) an ultimatum was handed to the British agent at Pretoria, and a war was at once precipitated, which was not to close for over two and a half years.

(A.P.H.; F.R.C.)

D. *From the Annexation of the Dutch Republics to the Union.*—An account of the Anglo-Boer War of 1899-1902 will be found under TRANSVAAL. After the surrender of Cronje at Paardeberg (February 1900) to Lord Roberts, Presidents Kruger and Steyn offered to make peace, but on terms which should include the acknowledgment of "the incontestable independence of

both republics as sovereign international states"; the Boers also sought, unavailingly, the intervention of foreign powers. The British government had decided that the continued existence of either republic was inadmissible; ^{*Last Efforts*} on the 28th of May 1900 the annexation of the ^{*to Preserve the Boer Republics.*} Free State was formally proclaimed, and on the 1st of September the Transvaal was also annexed to the British Empire. A few days later ex-President Kruger sailed from Lourenço Marques for Europe. The refusal of the German Emperor to receive him extinguished alike his political influence and all hopes that the Boers might still have entertained of help from foreign governments. At that time all the chief towns in both of the late republics were held by the British, and the Boers still in the field were reduced to guerilla warfare. Most of the men on their side who had come to the front in the war, such as General Louis Botha in the Transvaal, had been opponents of the Kruger régime; they now decided to continue the struggle, largely because they trusted that the Cape Dutch, and their sympathizers in Great Britain, would be able to obtain for them a re-grant of independence. The Cape Dutch all through 1901 and the first part of 1902 conducted a strong agitation in favour of the former republics, the border line between constitutional action and treason being in many cases scarcely distinguishable. The Cape Afrikaners also formed what was styled a "conciliation committee" to help the party in Great Britain which still supported the Boer side. Messrs Merriman and Sauer went to England as delegates to plead the cause, but it was noted that Hofmeyr refused to join, and the appeal to the British public was a complete failure. The war had indeed stirred every part of the empire in support of the policy of the government, and from Australia, Canada, New Zealand and India, contingents were sent to the front. No terms could be granted which did not include the explicit recognition of British sovereignty. At last the Boer commandos gave up the struggle and on the 31st of May 1902 their leaders signed articles of peace at Pretoria. Henceforth, save for the German and Portuguese possessions, on the west and east coasts respectively, there was but one flag and one allegiance throughout South Africa. With the elimination of the republics one great obstacle to federation was removed; while the establishment of self-government in the new colonies, promised (after a probationary period of "representative institutions") in No. VII. of the peace articles, would give them an opportunity to enter into federal union on equal terms.

The task of founding new and better administrative machinery in the new colonies was left to Lord Milner, and was begun even before the war had ended. The two new colonies ^{*The Work of Reconstruction.*} were for the time governed on crown colony lines. But the co-operation of the people was at once sought by nominating non-official members to the legislative councils, and seats on the Transvaal council were offered to Louis Botha, C. J. Smuts and J. H. Delarey. The Boer leaders declined the offer—they preferred the position of untrammelled critics, and the opportunity to work to regain power on constitutional lines when the grant of self-government should be made. Milner had thus an additional difficulty in his reconstruction work. The first necessity was to restart the gold mining industry on the Rand. The Uitlanders, who had fled from Johannesburg just before the war opened, began to return in May 1901, and by the time the war ended most of the refugees were back on the Rand and mining was resumed. A tax of 10% on their annual net produce, imposed in 1902, was the main available source of revenue. The repatriation of some 200,000 Boers followed, and the departments of justice, education and agriculture were remodelled.¹ In all that he did Milner had endeavoured to promote closer union. Thus the railway and constabulary of both the ex-republics were under a single management. In this

¹ To aid him Milner had the services of some of the best men in the British service, e.g. Sir Godfrey Lagden, Sir Arthur Lawley, Sir J. Rose-Innes, Sir Richard Solomon. He also secured the help of a considerable number of young Oxford men who became known as "the Milner Kindergarten."

work the high commissioner had the support of Mr Chamberlain, who paid a visit to South Africa which extended from Christmas 1902 to the end of February 1903. He sanctioned the calling of an inter-colonial conference, which led to a customs convention including all the British possessions in South Africa, and to united action regarding railway rates and native questions.¹

The great expenditure incurred during the war had led to much deception as to the growth of trade, while the large sums spent on repatriation and other temporary work maintained this deception for some time after the war had ceased. But before 1903 had ended it was manifest that this had been a spurious activity, and a period of marked commercial depression, lasting until 1909, ensued. This depression was in considerable measure due to, and was largely aggravated by, the comparative inactivity of the Rand mines, and that inactivity was due in turn to the insufficiency of native labour—Kaffirs being employed to do all the unskilled work on the mines. At the close of 1903 the mine-owners, to meet the deficiency, asked for permission to import Chinese. The consent of the high commissioner and of the home government was obtained, and in June 1904 the first batch of coolies reached the Rand. They came on three-years' indentures, over 50,000 Chinese being eventually brought over. This introduction of Chinese labour met with considerable opposition. The South African objections were economic and racial, based on the results which had followed the introduction of Indian coolies into Natal. In Natal these coolies had been allowed to remain after the completion of their indentures, and had succeeded in practically monopolizing the petty trade of the country. They had also rapidly multiplied, so that by 1904 they were more numerous than the whites in the colony. The introduction of this large alien element, leading from 1895 onwards to the passing of restrictive measures in Natal, was a mistake which South Africans elsewhere had no desire to repeat. But these objections were overcome by regulations which made repatriation compulsory, and which definitely restricted the coolies to unskilled labour in the mines. These regulations also met the objections voiced by Australians and New Zealanders that the country won for Great Britain at such cost had been thrown open to hordes of Asiatics. In Great Britain, however, the restrictive regulations were precisely those which aroused criticism, the objection taken being that the conditions imposed were of a servile character, if they did not actually make the coolies "slaves." In the attacks made upon the Unionist government this cry was loudly voiced by the Liberal party in England, and in the political campaign which followed, the "Chinese Slavery" issue undoubtedly helped to swell the majority obtained by Sir H. Campbell-Bannerman in January 1906. Milner's own object in assenting to the introduction of the Chinese was—besides aiding to put the gold mining industry on a more stable basis—to obtain revenue for the great task he had on hand, "the re-starting of the colonies on a higher plane of civilization than they had ever previously attained"; and in respect of the working of the mines and consequently in providing revenue the introduction of the Chinese proved eminently successful; but in February 1906 the Campbell-Bannerman administration felt it incumbent to announce that no ordinance imposing "servile conditions" would be sanctioned. The point as to whether the original conditions were or were not servile was never legally tested, for eventually on the grant of self-government to the Transvaal the Botha cabinet decided (June 1907) not to renew the indentures nor to permit any new importation of coolies. The economic situation had in the meantime considerably altered, and the Transvaal was able to bring pressure upon Portugal to permit the recruiting of many thousands more Kaffirs from Mozambique province. By February 1910 the last of the coolies had been repatriated.

By the middle of 1904 the high commissioner and Mr Alfred Lyttelton, who had become secretary for the colonies, agreed that the work of reconstruction had so far progressed that steps

¹ This action was on the lines of the commercial federation scheme of Cecil Rhodes, who had died in March 1902.

should be taken to give the Transvaal "representative government." This decision was made public in July of that year, and was followed by marked political activity. The Boers in the Transvaal, headed by Louis Botha, formed an association which was called *Het Volk* (the people), and in the Orange Colony a similar organization, the *Oranje Unie*, was formed. On the 31st of March 1905 the text of the new constitution was issued by letters patent. Short of granting full self-government it was of a liberal character. It provided that the legislative council was to consist of not fewer than six or more than nine official members, and, provisionally, of not fewer than thirty or more than thirty-five elected members. Seats were to be allotted on a voters' (not population) basis, and there was to be an automatic redistribution of seats as voters increased or decreased in given localities. These provisions—subsequently adopted in the electoral law of the Union of South Africa—were made to secure equal rights for the British and Dutch sections of the community. The promulgation of the Lyttelton constitution was quickly followed by the retirement of Lord Milner. He left South Africa in April 1905, and was succeeded as high commissioner and governor of the Transvaal and Orange River colonies by Lord Selborne. But before the new constitution could be established a change of ministry in Great Britain put the Liberals in office, with Sir Henry Campbell-Bannerman as premier (Dec. 1906).

A sudden change was now made. Sir H. Campbell-Bannerman, with several of his colleagues in the ministry, held that the annexation of the republics had not been justified, but there was no question now, as there had been in 1881, of a restoration of independence; that matter the Boers themselves had settled by their acceptance of British sovereignty. The Liberal leader held, however, that the Boers should be given self-government at once. Experience, he declared² had proved, unfavourable to the working of representative institutions, and it was safer and better to begin with responsible government. Moreover, the cabinet looked forward, without forcing it in any way, to the federation of South Africa. In the Transvaal the burghers of British origin were about equal in number with those of Dutch origin, and the fairly even balance of parties might be held to be a guarantee against retrogression; in the Orange River Colony it was notorious that the grant of self-government meant handing over the control of the country not simply to the Boers, but to that section of them which since the war had exhibited the greatest racial bitterness. In these circumstances the decision of the Liberal cabinet, however generous, was fraught with peril. But the policy of complete trust in the Boers was a bold one, which was justified by success.

The new letters patent instituting self-government in the Transvaal were issued on the 12th of December 1906; the elections were held in February 1907, and gave the *Het Volk* party a clear majority of seven (in a house numbering 69 members) over all other parties. General Botha became premier, with Mr Smuts as colonial secretary. In the Orange River Colony the first elections under the self-government constitution were held in November 1907, and out of 38 seats in the House of Assembly *Oranje Unie* candidates secured 29. A ministry was formed with Mr A. Fischer as premier and Generals Hertzog and de Wet as prominent colleagues. These triumphs of the Dutch section of South Africans were followed in the general election in Cape Colony early in 1908 by a sweeping victory of the Bond, helped by the suffrages of re-enfranchised rebels. Dr Jameson—who had been premier of the colony since the Progressive victory at the election of 1904—was succeeded as premier by Mr J. X. Merriman, who was regarded as a Bond nominee. Thus, working within constitutional lines, the Dutch Afrikaners had attained in three out of the four self-governing colonies, political supremacy. The situation in 1908 was, however, radically different from that which existed before the war of 1899-1902. Then half the white population of the Transvaal were as "helots"; now the

² In a speech in the House of Commons, February 19, 1906.

ex-Uitlanders held 26 seats in the Transvaal parliament, and were able to exercise an effective influence over legislation.

Both the war of 1899-1902 and the grant of self-government to the new colonies were necessary preliminaries to the success of any unification scheme, but the causes which now led to the question of closer union being raised were not political but

**The Move-
ment for
Closer
Union.**

economic. Since the development of the diamond and gold mining industries the coast colonies had unduly neglected their own resources and had relied chiefly on the forwarding trade. Hence there was jealousy and competition between the Cape and Natal and a tendency to use the railways (which were state owned), by means of rebates, to counteract the effects of common customs dues. Then, too, an increasingly important factor was the competition of Lourenço Marques for the Rand trade. In a time of acute trade depression this commercial rivalry was disastrous to the welfare of South Africa. In March 1906 the customs convention was provisionally renewed (on a strongly protective basis, and with preference for British goods) but there was a distinct prospect of a tariff war when the convention expired in 1908. Again it was known that the Transvaal and Orange River colonies on their attainment of self-government would each demand full control of their own resources, to the detriment of the unitary services which Lord Milner had established. There were, moreover, dangerous differences on such questions as Asiatic immigration, the status of natives, mining, agriculture, &c. Thus the antagonism between the various states on economic lines was at the end of 1906 greater than any racial divisions. The leading South African statesmen realized that unless an effort to remedy this condition was made without delay affairs would go from bad to worse. In these circumstances Dr Jameson, as premier of Cape Colony, took the first overt step to reopening the question of federation.¹ In a minute dated the 28th of November 1906 the Cape ministry declared its belief that the questions which were causing so much friction should be capable of solution "by some duly constituted South African authority responsible to all parties in the country," and it appealed to Lord Selborne, as high commissioner, to review the situation in such a manner that the people of South Africa might form a competent judgment on the question. In answer to this appeal, which was backed by the Natal ministry, Lord Selborne drew up a despatch (dated Jan. 7, 1907) in which the whole case for closer union was set forth in a masterly manner. For insight and breadth of view the despatch ranks with that which Sir George Grey drew up in 1858. In the fifty years that had elapsed the case for closer union had become overwhelming and the dangers of isolation much greater. Four or five administrations, the despatch pointed out, were pursuing rival interests, whereas the country had but one interest. Reviewing one by one the questions on which rivalry existed, Lord Selborne showed that the internal self-government which each colony enjoyed accentuated the difficulty of dealing with these questions as a whole.² Stability—the thing which South Africa required above everything else—was unattainable so long as there were five separate governments developing different systems in all branches of public life, but no national government with power to harmonize the whole. "The people of South Africa . . . are not self-governing in respect to South African affairs because they have no South African government with which to govern." Only by the creation of a central government could South Africa be wisely and successfully governed.³

The opportunity for testing the strength of the movement for closer union came with the meeting of an inter-colonial conference in May 1908 to consider the thorny questions of tariff and railway rates. In the meantime the Jameson ministry

¹ A number of members of the Transvaal administration during the Crown Colony period had worked steadily, in private, to promote closer union. Prominent among these men was Mr Lionel Curtis, at that time (1906) assistant colonial secretary.

² Lord Selborne wrote in anticipation of the establishment, a few months subsequently, of self-government in the new colonies.

³ For the text of the despatch and memorandums going into details see the Blue Book (Cd. 3564) July, 1907.

had given place to the Bond nominee ministry with Mr Merriman as premier (see CAPE COLONY: *History*), but the movement initiated by Jameson had received the support of the Bond as well as that of the Botha administration. The delegates at the conference were all representative of the parties in power; that is, with the exception of the Natal delegates, they all represented Dutch ideals in politics. Nevertheless they unanimously resolved "that the best interests and the permanent prosperity of South Africa can only be secured by an early union, under the crown of Great Britain, of the several self-governing colonies," and they recommended the calling of a national convention entrusted with the task of drawing up a draft constitution. Thus for the first time for two generations both the chief white races of South Africa were found working in cordial co-operation. No appeal was made to the electorate, but the colonial parliaments rightly interpreted public opinion in endorsing the recommendations of the conference. Delegates representative of all parties were appointed, and the national convention to consider the question of union met at Durban in October 1908.

The most prominent members of the convention were Sir Henry de Villiers,⁴ chief justice of Cape Colony (president), ex-President Steyn (vice-president), Generals Botha, The de Wet and Delarey, Messrs Smuts, Schalk Burger, *The National Merriman and F. R. Moor* (premier of Natal), Dr *Convention.* Jameson, Sir George Farrar and Sir Percy Fitzpatrick, the last two the leading representatives of the Transvaal Progressives (*i.e.* the ex-Uitlanders). The greatness of the opportunity was rightly stated by the governor of Natal (Sir Matthew Nathan), who declared that the convention might create a commonwealth which should add to and not draw upon the strength of the empire—a commonwealth which in culture as in power would be among the foremost nations of the world. After sitting at Durban for a month, the convention adjourned to Cape Town and concluded its elaboration of a draft constitution by February 1909. The fundamental points which the delegates had to settle concerned (a) the basis of parliamentary representation, (b) the status of the natives with respect to the franchise, (c) the position of the Dutch language, (d) the form of government.

The adjustment of tariff and railway rates gave little trouble when once it was agreed to consider the country as a unit. Points (a) and (b) both concerned the franchise, but each had its separate issue (a) raising the question of representation as it concerned the white population only. Suspicions had been raised that the attempt would be made to force union on a Dutch Afrikaner basis, which might have resulted had the basis of representation adopted been the total European population. To this the Progressive party would not agree, and they gained support from Botha, Smuts and other prominent Dutch delegates for their contention that "equal rights" could only be secured by making the basis of representation the number of voters as distinct from the number of European inhabitants of any given area. As finally settled, the number of European male adults was chosen as the basis of representation. As the Transvaal and Orange colonies already possessed manhood suffrage, and as the property qualifications in the coast colonies were low, this alteration made little difference. Point (b) raised a graver issue still. The Cape delegates found themselves in isolation in advocating the extension of the electoral system which prevailed in their colony, where there was no colour bar to the exercise of the franchise. The merits of the Cape system—to minimize the differences between the white and native races, typified in the declaration of "equal rights to all civilized men"—or that of the opposite system (as warmly advocated by the Natal delegates as by those from the ex-Boer republics), which would keep the native races in permanent inferiority, cannot here be discussed; it may be stated, however, that the admittance of Kaffirs to the franchise in the Cape had not been attended with the evil consequences feared. At the convention a way out of the difficulty—for a time at least—was found in a compromise, namely, that in the state about to be created the franchise in each constituent part should be that which existed before union was effected. Thus in the Cape the Kaffir would have a right to the franchise, but not in the other divisions of the country. Point (c) was decided by placing, for all official purposes, the English and Dutch languages on a footing of perfect equality. As to point (d) the

⁴ Sir Henry de Villiers (b. 1842), chief justice of Cape Colony since 1874, was created a peer of the United Kingdom in 1910 under the title of Baron de Villiers of Wynburg. He became in the same year chief justice of South Africa.

issue was between a federal and a unitary form of government. Federation was supposed to afford protection to the smaller communities—Natal and the Orange River Colony—and in Natal there was much anxiety lest its interests should be overborne. Nevertheless the advocates of unification gained a complete victory and a form of government was agreed to which made the union of South Africa as close as that of the United Kingdom.

Among the other decisions of the convention were: the choice of Pretoria as the seat of administration and of Cape Town as the seat of the legislature, the renaming the Orange River Colony, Orange Free State Province; the provision of three membered constituencies and of proportional representation and the safe-guarding of the smaller communities by giving Natal and the Orange River colonies more members of parliament than they were entitled to on the voters basis.

The draft constitution was made public on the 9th of February 1909, and was adopted by the Transvaal parliament in its entirety. The Orange River parliament also approved with only slight alterations; the Natal parliament made some amendments, but they were of a minor character. The opposition to union among an influential number of old Natalians—intensely zealous for local independence—was however so marked that it was decided that before Natal was committed to union a referendum on the subject should be taken. Apart from this doubtful attitude of Natal, the chief danger to the draft constitution came from the Cape Dutch. The draft act, with its "one vote one value" principle, its three-membered constituencies and its scheme for proportional representation, threatened Dutch supremacy in the rural districts, and aroused the opposition of Hofmeyr, who secured the passage of amendments through the Cape parliament which destroyed the principle of equal rights. Such was the position when the convention reassembled in May at Bloemfontein to consider the amendment of the various legislatures. Through the firmness of the Transvaal delegates, supported by the Progressives, the principle of equal rights was retained; the concession made to the Cape was the abandonment of proportional representation, while one-membered constituencies were substituted for three-membered constituencies. The document embodying the alterations in the draft act was signed on the 11th of May and the convention dissolved. In June the referendum on union was taken in Natal, and resulted in a complete rout of the separatists. There voted, for the draft act 11,121, against it 3701—majority for union 7420.

South Africans had thus after seventy years of discord agreed upon union. It was a momentous step, the essential preliminary to that fusion of the white races of South Africa upon which the prosperity of the country depends; and a step rendering easier the ultimate attainment of imperial union. A delegation carried the draft act to England, and, recast in the form of an imperial bill, it was submitted to the parliament at Westminster. The imperial government made but one alteration of consequence—that explicitly placing the control and administration of matters "specially or differentially affecting Asiatics" in the sole control of the union parliament. The bill passed through parliament unaltered, the only jarring note in the debates in either house concerning the exclusion of natives from the franchise (save in the Cape province). This decision was deplored by all parties in the British parliament, but it was recognized that to alter a decision deliberately come to by South African statesmen would wreck the union. The measure, known as the South Africa Act 1909 received the Royal Assent on the 20th of September, and subsequently the 31st of May 1910—the eighth anniversary of the signing of the articles of peace at Pretoria—was fixed as the date for the formal establishment of the Union.

The interval between the passing of the South Africa Act and the establishment of union was employed by the various colonies in putting their houses in order. This task, on the economic side, was rendered easier by the gradual return of commercial prosperity. An agreement between the Transvaal and the Portuguese governments, concluded in April 1909, while the fate of the draft constitution was still in doubt, assigned to Lourenço Marques 50 to 55% of the import trade to the Rand, and (with certain exceptions) provided for free trade in native products between the Mozambique province and the Transvaal. The

Portuguese further agreed to facilitate the recruitment of natives in their territory for work in the Rand mines, and in consequence Kaffirs were obtained in sufficient numbers to replace the Chinese coolies as they were repatriated. The agreement was to last ten years, and provision was made for its recognition by the government of the Union. The native protectorates, Basutoland, Swaziland and Bechuanaland had been left by the South Africa Act under direct imperial control. As to Natal and Zululand, there was a disposition to leave to the new government the task of dealing with the natives there but both the Transvaal and Natal adopted an Asiatic exclusion policy which gave rise to much friction. In the Orange River Colony, General Hertzog aroused much opposition by administering the education act in a way which forced the teaching of Dutch in a rather arbitrary fashion. This was a point of importance, inasmuch as, by the Act of Union, elementary education was left (for five years) in the hands of the provinces. The divergence of views was so great that shortly after the union had been established private schools were opened in opposition to those of the provincial administration.

In the autumn of 1909 it became known that Lord Selborne, whose services in bringing about the union were generally recognized, would not remain to represent the Crown in inaugurating the new form of government, and the choice of the British government fell on the home secretary, Mr Herbert Gladstone (who was in March 1910 created Viscount Gladstone of Lanark) as first governor-general of the Union. Lord Gladstone had the responsibility of summoning the first prime minister of the Union—a task rendered more difficult as the decision had to be taken before the first election to the Union parliament was held. There had been a strong agitation for a coalition cabinet, and negotiations took place to this end between General Botha and Dr Jameson. These efforts ended in failure. They had met with the determined opposition of Mr Merriman (the Cape premier), of the Orange Free State Boers, and of the Bond, which had lost the counsel of Hofmeyr. That typical leader of the Cape Afrikaners had died in London, whither he had gone as one of the delegates to lay the draft constitution before the British parliament. Towards the end of May, Lord Gladstone called upon General Botha to form a ministry, which was constituted from the ranks of the existing cabinets and included Natal ministers as well as strong Boer partisans like Mr Fischer and General Hertzog. Mr Merriman declined to serve under General Botha. The formal proclamation of the Union took place on the 31st of May.

The first general election, held on the 15th of September, was, perhaps inevitably, fought to a large extent on racial lines. The Dutch Afrikaner candidates stood as "Nationalists," while their opponents took the name of Unionists. In Natal the British section of the electorate (four-fifths of the whole) preferred to maintain an independent attitude. The elections, which resulted in a Nationalist majority of 13 over all other parties, showed that the Unionists were stronger than had been thought. They secured 37 seats, while 13 were held by Natal Independents. The polls were remarkable for the defeat of three ministers—General Botha (by Sir Percy Fitzpatrick) at Pretoria East, Mr Hull (by Sir George Farrar) on the Rand, and Mr Moor in Natal. General Botha decided to retain office, and seats for him and Mr Hull were found by means of by-elections. Mr Moor was nominated to the senate, as were, among others, Mr W. P. Schreiner and ex-President Reitz (who became president of that body). On the 4th of November the first session of the Union Parliament was opened by the duke of Connaught.

BIBLIOGRAPHY.¹—I. General descriptions, travel and exploration. Besides the works of De la Caille, Le Vaillant, Thunberg, Barrow, Lichtenstein, Burchell and others quoted in CAPE COLONY, § Bibliography, see Sir J. E. Alexander, *An Expedition of Discovery into the Interior of Africa* (2 vols., 1838); R. Moffat, *Missionary Labours and Scenes in S. Africa* (1842); Sir F. Galton, *The Narrative of an Explorer in Tropical South Africa* (1853); C. J. Anderson, *Lake Ngami . . . Wanderings in the Wilds of South-Western Africa* (1856); David

¹ Unless otherwise stated the place of publication is London.

Livingstone, *Missionary Travels and Researches in South Africa* (1857); W. E. Oswell, *William Cotton Oswell, Hunter and Explorer* (2 vols., 1900); T. Baines, *Explorations in South-West Africa* (1864); K. Mauch, *Reisen im Inneren von Süd-Afrika, 1805-1872* (Gotha, 1874); E. Holub (Eng. trans. E. E. Frewer), *Seven Years in South Africa, Travels . . . between the Diamond-fields and the Zambesi, 1872-1879* (1881); E. Manheimer, *Du Cap au Zambèse* (Geneva, 1884); G. Fritsch, *Südafrika bis zum Zambesi* (1885); H. Blink, *Aardrijksunde van Zuid-Afrika* (2 vols., Amsterdam, 1889); F. C. Selous, *Travel and Adventure in South East Africa* (1893); E. & O. Reclus, *L'Afrique australe* (Paris, 1901); A. H. Keane, *Africa*, vol. ii.; *South Africa* (new ed., 1904); W. Kultz, *Deutsch-Südafrika im 25ten Jahre deutscher Schutzherrschaft* (Berlin, 1909); A. S. & G. G. Brown, *The Guide to South Africa* (yearly).

II. Geography (physical), geology, climate, flora and fauna.—Sir C. P. Lucas and H. E. Egerton, *Geography of South and East Africa* (Oxford, 1904); W. P. Greswell, *Geography of Africa South of the Zambesi* (Oxford, 1892); P. Passarge, *Südafrika, eine Landes-Volks- und Wirtschaftskunde* (Leipzig, 1908); J. C. Brown, *The Water Supply of South Africa* (Edinburgh, 1877); Sir W. Willcocks, *Report on Irrigation in South Africa* (1901); *Proceedings 1st South African Irrigation Congress* (Cape Town, 1909); R. Marloth, *Das Kapland, insonderheit das Reich der Kapflora, das Waldgebiet und die Karoo, pflanzengeographisch dargestellt* (Jena, 1908); F. H. Hatch & G. S. Corstorphine, *The Geology of South Africa* (2nd ed., 1909); *Trans. Geol. Soc. S. Africa* (Cape Town); W. Flint and J. D. F. Gilchrist (eds.), *Science in South Africa* (Cape Town, 1905); *Reports of the S. A. Assoc. for Advancement of Science* (Johannesburg); J. D. F. Gilchrist (ed.), *Marine Investigations in S. Africa* (3 vols., Cape Town, 1902-1905); Sir David Gill, *Report on the Geodetic Survey of South Africa* (3 vols., Cape Town, 1896-1905); W. C. Scholtz, *The South African Climate . . . the Country as a Health Resort* (1897); W. T. Thiselton-Dyer (ed.), *Flora Capensis*, vols. i.-vii. (1896-1900); H. Harvey, *The Genera of South African Plants*, 2nd ed., edited by Sir J. D. Hooker (Cape Town, 1868); G. Henslow, *South African Flowering Plants* (1903); W. L. Slater, *The Fauna of South Africa* (4 vols., 1900-1901); F. Le Valliant, *Histoire naturelle des oiseaux d'Afrique* (6 vols., Paris, 1805-1808); F. L. Layard and R. Bowdler Sharpe, *The Birds of South Africa* (1875-1884); R. Trimen, *Rhopalocera Africæ australis; a Catalogue of South African Butterflies* (Cape Town, 1862); R. Trimen and J. H. Bowker, *South African Butterflies, a Monograph of the Extra-Tropical Species* (3 vols., 1887-1889); G. B. Sowerby, *Marine Shells of S. Africa* (1892-1897); R. Trimen, *Insect Life in South Africa* (Cape Town, 1869); E. E. Austen, *A Monograph of the Tsetse Flies* (1903); J. A. Nicolls and W. Eglinton, *The Sportsman in South Africa* (1892). The following books are specially noteworthy for their accounts of the larger wild animals: Sir W. C. Harris, *The Wild Sports of Southern Africa . . . Narrative of an Expedition . . . during 1836 and 1837 from the Cape . . . to the Tropic of Capricorn* (Bombay, 1838; 5th ed., London, 1857); R. Gordon-Cumming, *Five Years of a Hunter's Life in the Far Interior of South Africa* (2 vols., 1855); F. C. Selous, *A Hunter's Wanderings in Africa* (1st ed., 1881; 5th ed., 1907), and *African Nature Notes and Reminiscences* (1908); H. A. Bryden, *Nature and Sport in South Africa* (1897); P. Selous and H. A. Bryden, *Travel and Big Game* (1897).

III. Ethnology, archaeology, art and languages (see also works cited under racial headings and BANTU LANGUAGES). G. Fritsch, *Die Eingeborenen Südafrikas* (Breslau, 1872); G. W. Stow, *The Native Races of South Africa* (1905); W. H. Bleek, *A Brief Account of Bushman Folk-lore and other Texts* (1875); D. Kidd, *The Essential Kafir* (1904); *Savage Childhood* (1906), and *Kafir Socialism and the Dawn of Individualism* (1908); J. P. Johnson, *Stone Implements of S. Africa* (1907); *Pre-historic Period in S. Africa* (1910); A. P. Hillier, *Antiquity of Man in S. Africa* (1898); *Bushman Paintings*, copied by M. Helen Tongue, preface by Henry Balfour (Oxford, 1909), reproductions in colours; D. Randall-MacIver, *Medieval Rhodesia* (1906); R. N. Hall, *Prehistoric Rhodesia* (1909); A. H. Keane, *The Gold of Ophir* (1901); C. Peters, *The Eldorado of the Ancients* (1902); W. H. Bleek, *Comparative Grammar of the South African Languages* (1862-1869); J. Torrend, *A Comparative Grammar of the South African Bantu Languages* (1891); A. C. Madan, *An Outline Dictionary intended as an Aid to the Study of the Languages of the Bantu and other Uncivilized Races* (1905); C. Meinhof, *Die Sprache der Herero*, a grammar and vocabulary (Berlin, 1909); G. M. G. Hunt, *English-Afrikaner: Afrikaner-Englisch* (1901); W. J. Viljoen, *Beiträge zur Geschichte der cap-holländischen Sprache* (Strassburg, 1896); D. C. Hesselings, *Bijdrage tot de geschiedenis der nederlandsche taal in Zuid-Afrika* (Leiden, 1899); H. Elffers, *Practische hollandsche Spraakkunst* (Cape Town, 1894), and *Elementary Grammar of the Dutch Language* (Cape Town, 1898).

IV. History and Politics. (i.) Sources.—The Cape archives are full and complete from 1652 onward. Selections from them have been published by H. C. V. Leibbrandt and G. McCall Theal; the last named has also published records of the Cape from MSS. in the Record Office, London (see CAPE COLONY: § Bibliography). See Theal's *Records of South East Africa*, (9 vols., 1897-1904); *The Record . . . Official Papers Relative to the Condition and Treatment of the Native Tribes of South Africa*, parts 1 to 5 (1649-1809), edited by Donald Moodie, late Protector of Slaves (Cape Town, 1838), the same writer's *The Evidence of the Motives and Objects of the Bushman Wars,*

1769-77, &c. (Cape Town, 1841); also *Treaties with Native Chiefs . . . entered into by . . . British Authorities . . . between 1803 and 1854* (Cape Blue Book, 1857); *Engagements subsisting between (Great Britain) and any States or Native Tribes in S. Africa* (British Parliamentary Paper, 1884); A. N. Macfayden, *South African Treaties . . . subsisting on the 1st of Sept. 1808* (Cape Blue Book, 1808) and Hertslet's *Map of Africa by Treaty* (1909 ed.). Lists of the British Parliamentary papers concerning South Africa will be found in the *Colonial Office List* (yearly). The Natal, Transvaal and Orange Free State official publications should also be consulted. (ii.) Histories.—G. McCall Theal, *History and Ethnography of Africa south of the Zambesi from . . . 1505 to . . . 1795* (3 vols., 1907-1910) and *History of South Africa since Sept. 1795* (5 vols., 1908); these two series represent the final form of Dr Theal's history (valuable bibliographies), but the main narrative is not carried beyond 1872; Sir C. P. Lucas, *The History of South Africa to the Jameson Raid* (Oxford, 1899); Frank R. Cana, *South Africa from the Great Trek to the Union* (1909), a political history covering the period 1836-1909, with bibliography; P. Wlast, *Südafrika; Entwicklungsgeschichte und Gegenwartsbilder* (Berlin, 1900); *De Geskiedenis van ons Land* (Paarl, 1895); W. Greswell, *Our South African Empire* (2 vols., 1885). For special studies see: H. P. Retief, *Datums van Gebeurtenissen uit de Geschiedenis van Zuid Afrika van 1486 to 1805* (Paarl, 1895); H. Dehérain, *Cap de Bonne Espérance au XVII^e siècle* (Paris, 1909), and *L'Expansion des Boers au XIX^e siècle* (Paris, 1905); J. Bird, *Annals of Natal, 1495-1845* (2 vols., Maritzburg, 1888); C. de Mello, *Os Ingleses na Africa austral* (Lisbon, 1890); E. B. Watermeyer, *Three Lectures on the Cape of Good Hope under the Government of the Dutch East India Co.* (Cape Town, 1857); *Selections from the Writings of Watermeyer* (Cape Town, 1877); H. Cloëté, *Five Lectures on the Emigration of the Dutch Farmers to Natal* (Cape Town, 1856), republished in London (1899), as *The Great Boer Trek*; J. Noble, *A Short History of the European Settlements at the Cape* (1877); G. E. Cory, *The Rise of South Africa . . . to 1857*, deals with eastern Cape Colony (4 vols., 1910 sqq.); J. C. Voight, *Fifty Years of the History of the Republic in South Africa [1795-1845]* (2 vols., 1899); J. Cappon, *Britain's Title in S. Africa* (1901); J. Nixon, *The Complete Story of the Transvaal* (1885); H. Rider Haggard, *Cetywayo and his White Neighbours* (1882); W. J. Leyds, *The First Annexation of the Transvaal* (1906); Sir Percy Fitzpatrick, *The Transvaal from Within* (1899); F. E. Garrett and E. J. Edwards, *The Story of an African Crisis [the Jameson Raid]* (1897); A. Wilmot, *The History of Our Own Times in South Africa [1872-1898]* (3 vols., 1897-1899); P. F. Hone, *Southern Rhodesia* (1909); Rev. J. Philip, *Researches in S. Africa, illustrating . . . the condition of the Native Tribes* (2 vols., 1828); *South African Native Affairs Commission, 1903-1905, Reports and minutes of evidence* (5 vols., Cape Town, 1904-1905); Sir Godfrey Lagden, *The Basutos* (1909); "The Times" *History of the War [of 1899-1902] in South Africa* (7 vols., 1900-1909); British Official *History of the War in South Africa* (4 vols., 1906-1910). (iii.) Lives.—Valuable historical information will be found in the *Lives* of W. E. Gladstone, the 2nd Earl Granville, Sir Harry Smith, Sir George Grey, Sir Bartle Frere, Sir G. Pomeroy-Colley, Cecil Rhodes, Paul Kruger and Lord Milner. See also P. A. Molteno, *Life and Times of Sir J. C. Molteno* (2 vols., 1900); A. Wilmot, *The Life and Times of Sir Richard Southey* (1904); Sir J. Robinson, *A Life Time in South Africa* (1900); W. D. Mackenzie, *John Mackenzie* (1902); *Coillard of the Zambesi* (1907).

(iv.) Miscellaneous.—E. A. Pratt, *Leading Points in South African History 1436 to March 30th 1900* (1900); J. A. Froude, *Two Lectures on South Africa* (new ed., 1900); J. Bryce, *Impressions of South Africa* (2nd ed., 1899); A. R. Colquhoun, *The Afrikaner Land* (1906); A. P. Hillier, *Raid and Reform* (1898) and *South African Studies* (1900); Lionel Phillips, *Transvaal Problems* (1905); Paul Botha, *From Boer to Boer and Englishman* (Cape Town, 1900); Sir Bartle Frere, *The Union of British South Africa* (1881); P. A. Molteno, *A Federal South Africa* (1896); *The Government of South Africa* (2 vols., Cape Town, 1908); *The Framework of Union* (Cape Town, 1908); R. H. Brand, *The Union of South Africa* (Oxford, 1909).

V. Economics and Commerce.—*Statistical Year Books or Registers; Census Reports; Reports of the Statistical Bureau* (since 1905); *Annual Trade Returns* and other official publications, especially those on native affairs, mining, agriculture and railways; *Argus Annual and South African Directory* (Cape Town); L. V. Praagh (ed.), *The Transvaal and its Mines* (1907); S. J. Truscott, *The Witwatersrand Goldfields* (2nd ed., 1902); A. Wilmot, *Book of South African Industries* (Cape Town, 1892); F. Blerch, *Handbook of Agriculture* (Cape Town, 1906); S. Ransome, *The Engineer in South Africa* (1903); Gardner F. Williams, *The Diamond Mines of South Africa* (revised ed., New York, 1905); A. R. E. Burton, *Cape Colony for the Settler* (1903); (account of urban and rural industries—their probable future development). "Indicus," *Labour and other Questions in South Africa* (1904); (designed to bring to light "the disabilities under which the coloured races . . . suffer," &c.). W. Bleloch, *The New South Africa* (1902).

VI. Church, Law, &c.—Bishop A. H. Baynes, *Handbooks of English Church Expansion: South Africa* (1908); Sir G. W. Cox's *Life of Bishop Colenso* (1888); *Church of the Province of South Africa; Constitution and Canons* (Cape Town, 1899 ed.); J. Stewart, *Lovedale* (1884) and *Dawn in the Dark Continent* (1903); the Reports on the

synods of the Dutch Reformed Church, those of the London Missionary Society and of other missionary bodies. J. W. Wessels, *History of the Roman-Dutch Law*, (Grahamstown 1908); G. T. Morice, *English and Roman-Dutch Law* (Grahamstown, 1903); W. H. S. Bell and M. Nathan, *The Legal Hand Book of Practical Laws . . . in British South Africa* (Grahamstown, 1905); C. H. van Zyl, *The Judicial Practice of . . . South Africa generally* (Cape Town, 1893); A. F. S. Maasdoorp, *The Institutes of Cape Law* (Cape Town, 1903); E. H. Crouch, *A Treasury of South African Poetry and Verse* (2nd ed., 1909).

VII. Bibliographies.—H. C. Schunke Hollway, "Bibliography of South Africa . . . with special reference to geography. From the time of Vasco da Gama to . . . 1888," *Trans. S.A. Phil. Soc.*, vol. v. pt. 2 (Cape Town, 1898); *Catalogue of the Books relative to Philology in the Library of Sir George Grey*, vol. i. pt. i. *The Dialects of South Africa* (Cape Town, 1858); *Books, Pamphlets and Articles on British South Africa* (Birmingham Free Library, 1901), *Mendelssohn's South African Bibliography* (2 vols. 1910). See also AFRICA: *Bibliography*. (F. R. C.)

SOUTHALL NORWOOD, an urban district in the Brentford parliamentary division of Middlesex, England, suburban to London, 12 m. W. of St Paul's Cathedral, on the Great Western railway. Pop. (1891), 7896; (1901), 13,200. Brickfields, flour-mills and chemical works are established in the district, which is also largely residential. The Grand Junction Canal serves Southall. Cattle markets are held weekly under a grant of William III. The Elizabethan manor-house of Southall remains, and the parish church of Norwood, though greatly restored, has Early English and Decorated portions, a canopied tomb dated 1547 and brasses of the 17th century.

SOUTH AMBOY, a city of Middlesex county, New Jersey, U.S.A., on Raritan Bay at the mouth of the Raritan river, about 27 m. S.W. of New York City. Pop. (1900) 6349 (1700 foreign-born); (1910) 7007. It is served by the Pennsylvania, the Central of New Jersey, and the Raritan River railways. A railway drawbridge and a traffic bridge across the river connect the city with Perth Amboy. South Amboy is an important point for shipments of coal from the Pennsylvania mines. The Pennsylvania Railroad Company and the Susquehanna Coal Company have coal docks here and the latter has great storage yards. Among the city's industries are the mining of clay and sand, and the manufacture of terra cotta. South Amboy, originally a part of South Amboy township (incorporated in 1798), was laid out in 1835, was incorporated as a borough in 1888, and became a city under a general state law in 1908.

SOUTH AMERICA. The early physical history of the South American continent as recorded in the rocks has been extensively obliterated or greatly obscured by the events of its later history. The early land areas are supposed to be only approximately suggested by the present exposures of granite and gneisses. The largest of these old land areas is along the east of the continent, extending with a few interruptions from the mouth of the Rio de la Plata to within a short distance of the mouth of the Amazon river. North of the present Amazon valley and occupying the present highlands of Guiana, north-east Brazil, and south-east Venezuela was another one of these old land areas—a large island or a group of islands. A chain of islands extended from the Falkland Islands along what is now the entire west side of the continent. Upon these ancient shores were laid down the sedimentary beds of the Cambrian seas. At the close of the Cambrian period the continent was elevated, many of the former islands were joined together, and the continental land area was considerably enlarged. The Silurian seas, however, still covered the basin of the Paraguay, extending from the Serra do Mar on the Brazilian coast to the axis of the Andes on the west, and covering at the same time a considerable part of the basin of the Rio São Francisco, filling the straits between the Andes and the Matto Grosso highlands and opening east through the region now occupied by the lower Amazon valley.

During the Devonian period there was a still further enlargement of the continent through elevation and the joining of islands, and the disappearance of the old Silurian sea in the basin of the Rio São Francisco on the east of the continent. In early Carboniferous times the sea still covered a narrow belt through

the lower part of the Amazon valley, and part of what is now the Andes lying south of the equator. During Permian times the basin of the Paraguay and the south-east coast of Brazil was covered with lagoons and swamps in which here and there coal beds were laid down. At the close of this period molten lavas broke through the earth's crust and flowed over and buried large areas in what is now Paraguay and south Brazil.

There was a general depression of the continent during the Cretaceous period and the ocean covered most of the continent as we now know it. The Serra do Espinhaço along the east coast of Brazil was above water and the coast line between the Rio de la Plata and Cape St Roque was little different from what it is at present. But through the highlands of Brazil from near Pernambuco west there was a broad sound containing many islands extending to the base of the Andes and possibly connecting with the Pacific Ocean. In the extreme north there were also many islands, bays and sounds, while a continental mass occupied the region of the Antilles. To the south the Atlantic Ocean filled most of the lower Paraguay basin and washed the eastern bases of the Andes. There was shallow-water connexion during this period between South America and southern India, through the Antarctic regions, probably by way of Australia.

In Early Tertiary times great changes took place in the geography of South America. The continent rose much higher than its present elevation, the coast-lines were extended oceanward, and the continent was considerably larger than it is at present. The Abrolhos Islands on the east coast of Brazil were then a part of the mainland and the seashore was some 200 m. further east. The Falkland Islands were also at that time a part of the continent, and South America had land connexion through the Antarctic regions or through the south Pacific Ocean with New Zealand and Australia, and through the West Indies region with Cuba and North America. Toward the close of Tertiary times the continent sank again beneath the ocean and salt water flowed into the Amazon and Orinoco valleys, turning the Guiana highlands again into an island or group of islands, and again separating the continent from land connexion with other continents. The valleys of Rio Magdalena, Rio Cauca and Lake Maracaibo were bays that covered large areas of adjacent territory.

It was during the Tertiary period that the continent took on its most characteristic features. Volcanic activity culminated; the Andes rose from low ridges and islands near sea-level to be one of the greatest mountain systems of the globe. This elevation was partly due to the uplifting of the continent *en masse*, partly to faulting and folding of the rocks, and partly to the pouring out of lavas and the accumulations upon the surface about vents of other volcanic ejections. This volcanic activity was not confined to the main range of the Andes, but extended into Venezuela and the islands along the north coast, to the plains of Patagonia, the highlands of the Paraná basin and as far east as the islands of Fernando de Noronha. In recent times volcanic activity has greatly diminished over the continent and has entirely ceased along its eastern and north-eastern parts. The great elevation and depression of the continent deeply affected the climate over certain large areas. For example, along the east coast, where winds blew on-shore, the rainfall was greatly increased during the elevation, while the later depression brought about a corresponding diminution of the rainfall. In Pleistocene times the south of the continent stood somewhat lower than it does at present, so that the ocean covered the plains of Patagonia and La Plata. During the glacial epoch the south of the continent and as far north as latitude 27° on the west coast was covered with glaciers that flowed down from the high mountain ranges. On the east side of the mountains the glaciers did not extend so far north as they did on the west side. The glaciers through the high Andes were also larger and longer than they are at present; there were no glaciers in the eastern or Brazilian portion of the continent.

Physical Geography.—The South American continent rises abruptly from the ocean floor along nearly all of its coast, but the steepness of the continental margin is more marked on the

western than on the eastern side. From Valparaiso to the Isthmus of Panama, a distance of 3000 m., the great Andes themselves are but the upper or subaerial portions of mountains whose **Submarine Relief.** bases are 10,000 ft. below the surface of the Pacific Ocean. South of Valparaiso the 10,000-foot contour lies well out from the coast, but opposite the Straits of Magellan it approaches within 150 m. of the coast-line. On the east side of the continent the 1000-foot contour passes to the east of the Falkland Islands showing that this group stands upon a submerged shelf or shoulder of the continent. From the mouth of the Rio de la Plata northward the 1000-foot submarine contour keeps at a distance of from 50 to 150 m. off the shore nearly to Bahia, Brazil; from Bahia northward and around Cape St Roque this same contour is close inshore, and the ocean-floor sinks abruptly to a depth of 5000 ft. North-west of Cape St Roque the continental shelf of shallow waters widens until opposite the mouth of the Amazon the 1000-foot contour is 300 m. off the coast. The broad shelf follows along this part of the coast as far as the island of Trinidad, west of which it narrows, though the islands along the northern shores of Venezuela all stand upon and form parts of this shallow continental shelf.

many islands along this part of the coast, including Chiloe, Wellington and the Tierra del Fuego group itself are but the high portions of these mountains that have remained above water, while Smyth Channel and the other sounds on the west coast and the Straits of Magellan 400 m. long and 4 to 20 m. wide, are the submerged valleys. In Smyth Channel at many places the glaciers flow nearly or quite down to sea-level. Some of the islands are steep-sided, barren and uninhabited peaks rising to an elevation of 4000 ft. above sea-level. North of 41° S. the west coast is but little indented, and there are but few good ports. Along the northern part of the continent from Guayaquil to Panama the coastal belt is covered with tropical vegetation; but from a little south of Guayaquil to 30° S. much of the coast is a sandy, arid and barren alkali desert. Across this arid belt flow the streams that descend from the high mountains, and along these are fertile valleys. Many of the smaller streams, however, do not reach the sea but dry up on their way across the arid coastal plain.

The Cordillera is a broad ridge upon which rise many great isolated peaks. Near its northern end the range divides: one branch, the Western Cordillera, continuing northward near the coast; the Merida branch swings eastward and ends with the northern side of the island of Trinidad, while a third division, the Sierra de Perija, runs northward between the valley of the Magdalena and Lake Maracaibo. The western slope of the main Cordillera is steep, and is scored by narrow steep-sided valleys; the eastern slope is usually more gentle, and the valleys are less precipitous. Upon the Cordilleran ridge rise many of the highest peaks in the world. The following are some of the most noted, with their elevations.¹

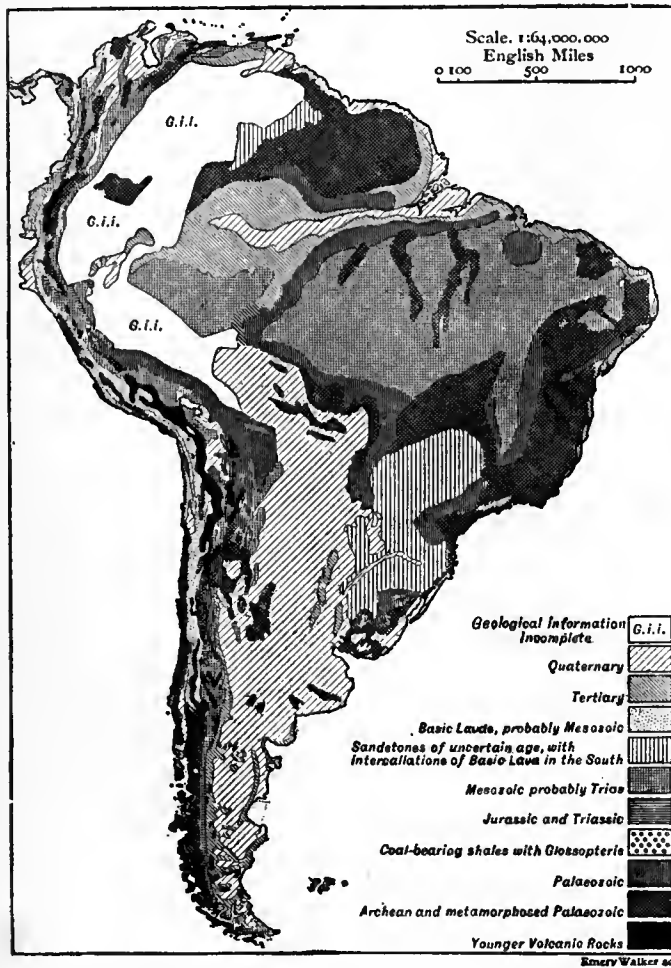

Peak.	Country.	Elevation.	Snow-line (approximate).
		ft.	ft.
Aconcagua	Argentina	23,080	17,500
Mercedario	Argentina	22,315	—
Tupungato	Argentina	21,550	—
Illampu (Sorata)	Bolivia	21,500	—
Illimani	Bolivia	21,030	—
Chimborazo	Ecuador	20,545	16,700
Juncal	Chile	20,180	—
Cotopaxi	Ecuador	19,613	15,500
Antisana	Ecuador	19,335	16,000
Cayambe	Ecuador	19,186	15,000
Tolima	Colombia	18,300	—
Misti	Peru	17,934	—
Maipo	Argentina	17,670	—
Sierra de Santa Marta	Colombia	16,640	—
Pichincha	Ecuador	15,918	—

The snow-line of the mountains is generally lower on the east than on the west side. Of the Andean peaks those of Cotopaxi, Tunguragua, Maipo and Sangai are the highest active volcanoes in the world. There are many glaciers in the Andes even beneath the equator itself; and though these glaciers are small and mostly confined to the highest peaks, toward its southern end along Smyth Channel and in the Straits of Magellan, they are large and flow far down the slopes, and at several places enter the sea.

The eastern side of the continent is in strong physical contrast with the western. North of the Strait of Magellan the coast is flat as far as the northern part of Rio Grande do Sul. From latitude 29° 30' to 19° 30' the Serra do Mar makes this the most picturesque portion of the east coast of South America. The mountains rise in many places directly from the seashore to an elevation of 2000 ft. In places these form bare granite walls, while in others they are covered from base to summit with the most luxuriant tropical vegetation. On this part of the coast are some of the finest and most beautiful harbours in the world, notably those of Rio de Janeiro, Santos and Victoria, formed by a depression that submerged the coastal valleys.

The range or group of mountain ranges known under the general name of Serra do Mar falls away toward the north and west in a gently sloping plateau commonly called the Brazilian highlands. On this Brazilian plateau the highest points of which the elevations are known are as follows:—

Peak.	Brazilian State.	Elevation.
		ft.
Itatiáya	Rio de Janeiro	9823
Itajúba or Tembê	São Paulo	7800
Organ Mountains	Rio de Janeiro	7321
Frade	Espirito Santo	6770
Caraçá	Minas Geraes	6412
Itambê	Minas Geraes	5959
Itacolomí	Minas Geraes	5748
Pyreneos	Goyaz	4536

North of latitude 20° the high mountains swing inland and the coast is low as far as latitude 17° 25'; north of this the coast is

¹ Various authorities differ in their estimates of these elevations.

The striking features of the land relief of South America are: (1) The great Andean mountain chain with its accompanying narrow plain lying between it and the Pacific Ocean. (2) The Brazilian plateau with the Serra do Mar and Serra do Espinhaço near the Atlantic and spreading westward and northward to the heart of the continent. (3) The highlands of Guiana and Venezuela between the Orinoco and the mouth of the Amazon. (4) The lowlands that spread out along the three main lines of continental drainage, namely the Orinoco, the Amazon and the Paraguay basins.

The physical features of the west coast are bold, and, in many parts, extremely picturesque. From Cape Horn, where the peaks of the submerged southern end of the Andes form the islands of Tierra del Fuego to the Isthmus of Panama, the great Cordillera follows the coast-line closely and at an even distance from it. The low coastal belt between the ocean and the mountains has an average width of about 40 m., and on rare occasions, when the weather is favourable, the mountains are visible from the sea nearly all the way from the Straits of Magellan to Panama. South of 41° S. the coast is characterized by a vast system of fjords and islands, probably produced by the recent submergence of a mountain system and the consequent invasion of its steep-sided valleys by the ocean. The

SOUTH AMERICA

Scale 1:25000000



Sea under 550 fathoms deep, tinted light, over 550 fathoms dark.

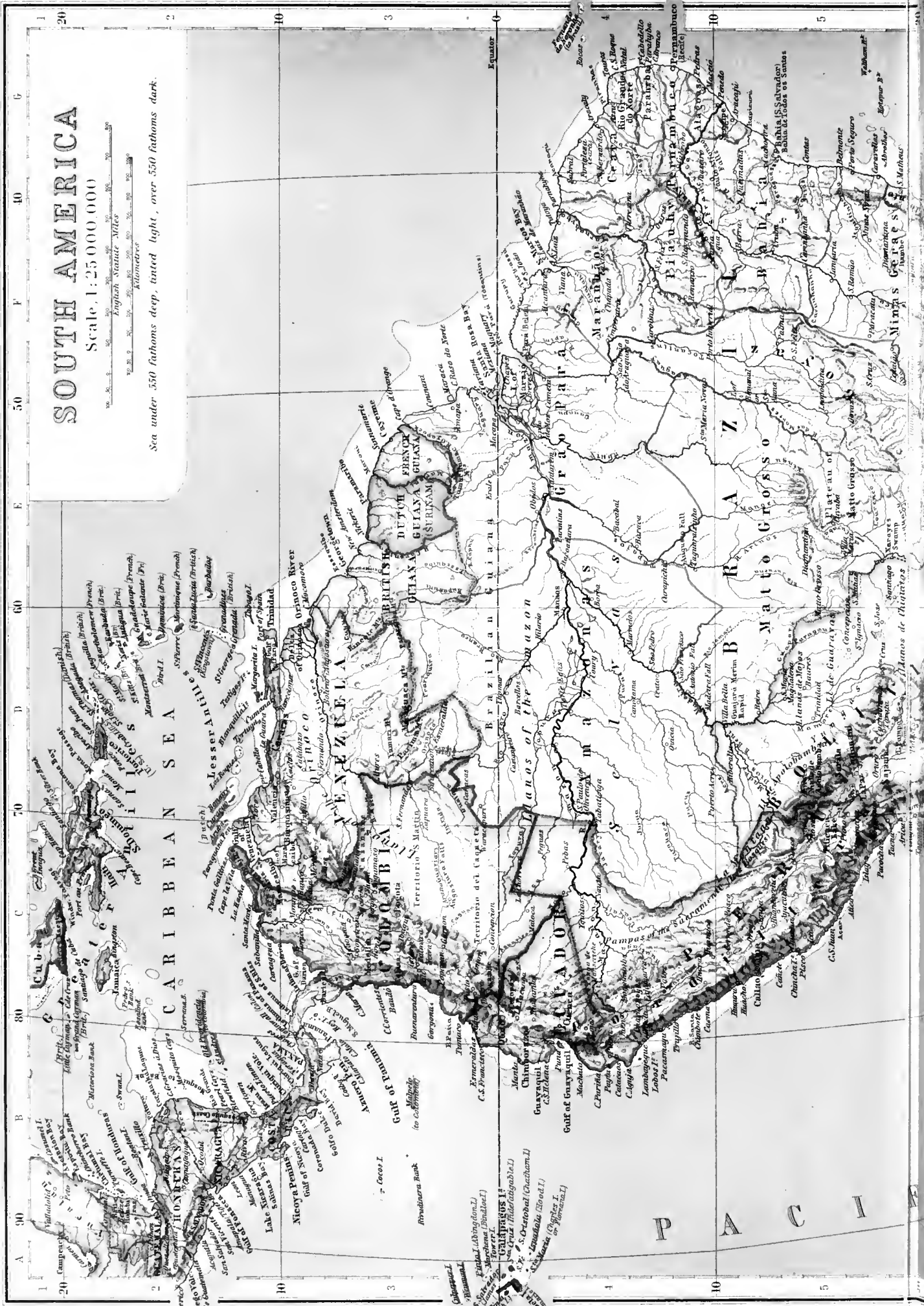

bordered by a wall of brightly coloured bluffs from 50 to 250 ft. high which continue with occasional interruptions to the mouth of the Amazon. About Cape St Roque the coast is covered with sand dunes. From the Abrolhos Islands northward to longitude 37° west of Cape St Roque, there are many coral reefs, some of them several miles off shore and many miles in length and breadth, while in other places they follow the coast-line for a hundred miles or more with a few interruptions, now touching the shore, and now standing out two or three miles from the land. Along the parts of the coast where the coral reefs occur are also reefs of hard sandstone that are often mistaken for coral reefs. These stone reefs stand like artificial walls or breakwaters across the mouths of the smaller rivers and the choked up valleys, and thus form several important ports on the north-east coast; such are the ports of Pernambuco, Natal, Porto Seguro, and others of minor importance. North of the mouth of the Amazon the coast is low, much of it is swampy, and all of it is forest-covered as seen from the ocean. This low coast extends as far north and west as the headland north of the Gulf of Paria where the Merida or Venezuelan branch of the Andes reaches the sea.

In southern Venezuela and Guiana and northern Brazil is a plateau commonly known as the Guiana highlands, above which rise several peaks.

Peaks.	Elevation. ft.
Roraima	8740
Ouida	8500
Maraguaca	8230
Turagua	6000

This highland region is mostly forest-covered, but it contains also large areas of open grass-covered plains.

Earthquakes occur throughout the entire length of the Andes; the shocks are sometimes of sufficient violence to do serious damage to cities and towns and to destroy many lives. Such disturbances are almost unknown along the Brazilian side of the continent.

The eastern coast of South America has remarkably few islands, and these are mostly small, except Trinidad off the coast of Venezuela

Islands. and the islands of the Marajó group in the mouth of the Amazon. Trinidad (area 1755 sq. m.) is separated from the continent by the Gulf of Paria. Along the northern edge of the island is a range of mountains about 3000 ft. high, which are geologically the eastern end of the Cumana range of the Venezuelan mainland. On the south side of this island is the famous pitch lake—the most extensive deposit of asphalt known. West and north of Trinidad, and lying farther off the coast, are several small islands of historical interest and commercial importance: Tobago, Margarita, Blanquilla and the Curaçao group. Off Cape St Roque (230 m.) is the small Fernando de Noronha group of volcanic islands. The main island has an area of only 12 sq. m. Though this island is separated from the mainland by a channel 13,000 ft. deep, it really stands upon the submerged corner of the South American continent. The Rocas is a small island 80 m. west of Fernando de Noronha. The Falkland Islands in lat. 51° cover an area of 6500 sq. m.; their shores are indented by long tortuous channels that have the appearance of having been made by the depression of a hilly land surface. One of these channels separates the two main islands. Mt Adams, the highest peak on the group, has an elevation of 2300 ft. The group stands upon the submerged edge of the continent, from which it is separated by a shallow sea. Its flora and fauna show that it was formerly a part of the mainland. The Tierra del Fuego group of islands, as well as the many islands both large and small that border the west coast as far north as latitude 42°, are all the higher portions of the continental margin left above water when this part of the continent was depressed. The islands of Juan Fernandez in the same latitude as Valparaiso, and the Galapagos group immediately under the equator are the only others on the west coast worthy of mention.

The Amazon, the Orinoco and the Paraguay or La Plata river systems jointly drain an area of 3,686,400 sq. m. Less imposing

Rivers. but yet large and important streams are the Magdalena in Colombia, the Essequibo in British Guiana and the São Francisco in Brazil. The Amazon (properly the Rio das Amazonas or river of the Amazons) and its tributaries is not only the largest of the South American rivers, but it is the largest in the world. The total navigable length of the main stream from Pará to the head of navigation on the Huallaga in Peru is 3000 m.; and this does not include the hundreds of navigable parallel side channels that accompany the main stream from its mouth almost to the mouth of the Javary. Above the falls again these streams are all navigable for long distances. Except at Obidos the Amazon is nowhere confined to a single channel, but it spreads over a vast flood-plain and flows with a sluggish current through thousands of side channels that anastomose with each other, so that one unfamiliar with the stream cannot distinguish the main channel. At several places the river is so wide that one looking across it sees a water horizon as if at sea. Much of the region is more like a great fresh-water sea filled with islands than an ordinary valley with a river running through it. For the most part the land along the stream is low, flat, marshy and at times under water. At a few places, however, notably at Ereré,

Obidos, Velha Pobre, Parú, Paraua-quára and Almeirim table-topped hills are visible from the river. The banks of the stream and of its side channels are everywhere covered with a dense forest. The valley, however, is not all forest-covered. From near the Oyapok on the Guyana frontier a series of open grassy campos, interrupted only by the wooded banks of streams, follow along the north side of the Amazon for about 500 m. and extend into British Guiana and the region of the headwaters of Rio Branco. The upper Amazon basin opens broadly northward connecting with the Orinoco drainage across a low watershed, while on the south it is separated by a low divide from the Paraguay basin. The Orinoco rises in the highlands between Venezuela and Brazil, flows westward and northward around this elevated region and then flows eastward into the Atlantic. Along its lower course the banks of the stream are covered with dense forests; in its upper course the mountainous highlands are visible along its right bank, while on its left are vast stretches of flat, treeless, grass-covered plains that extend to the foot-hills of the Cordillera de Merida. The main stream is navigable during a part of the year for a distance of 1000 m. or more.

Under the name of Rio de la Plata may be included the Uruguay and the Paraguay, which enter the ocean through the La Plata estuary, and the Paraná which is the most important branch of the Paraguay. It is a noteworthy feature of the streams entering the Paraguay or La Plata basin that many of those flowing from the arid regions on the west are more or less brackish, while those from the rainy forest-covered regions of Brazil are all fresh-water streams. The upper Paraguay is a sluggish stream winding through grass-covered plains dotted over with palm trees. Above rise a few isolated peaks like so many islands in a great lake. The Gran Chaco is a vast plain, almost perfectly flat, covered with rank vegetation and much of it with water, lying along the west side of the Rio Paraguay in northern Argentina and in Paraguay.

The São Francisco, the largest river that lies wholly in Brazil, rises in the highlands of Minas Geraes in latitude 21° and flows north-eastward parallel with the coast until it reaches latitude 9° 30' where it bends sharply to the right and enters the Atlantic. It flows entirely through a hilly or mountainous country. It is navigable along its lower course nearly to the falls of Paulo Affonso, 140 m. from its mouth, and also above the falls. In Colombia the Magdalena is a crooked muddy stream about 2000 m. long and navigable as far as Honda.

Most of the lakes of South America are mountain lakes in the Andes or along its base. Lake Titicaca in Bolivia is, in respect of elevation and position, the most remarkable of its size **Lakes.** in the world. Its surface is 12,545 ft. above sea-level, it has an area of nearly 5000 sq. m. and a maximum depth of 700 ft., and never freezes over. This lake discharges into a marsh that is supposed to have no outlet. Lake Junin or Chinchicocha on the plateau east of Lima has an altitude of 13,380 ft., and covers an area of 200 sq. m. Along the eastern base of the Andes in southern Argentina is a series of lakes whose basins were probably made by the glaciers that formerly flowed down from the mountains on the west. There are many lakes, both large and small, scattered over the flood-plains of the great rivers of South America, but these are mostly phases of river development. Along the coast-lines there are also occasional lakes of brackish water produced by the depression of the coast and the closing of the open mouths of estuaries thus formed, or by sand barrier beaches thrown up by the sea. Such is Lagoa dos Patos in southern Brazil and many smaller ones on the Brazilian coast. Lake Maracaibo on the coast of Venezuela is a large narrow-necked bay like those of Rio de Janeiro and Bahia, rather than a true lake.

Flora.—The warm, wet, tropical portions of South America are especially favourable to the development of plant life. This continent has therefore furnished an unusually large number of the world's useful plants. Among these are several valuable woods, rubber-producing plants, cotton, potato, tomato, mandioca, pineapple, maize, cinchona, ipecac, vegetable ivory, coca, the chocolate plant and Paraguayan tea. Other tropical and sub-tropical plants such as coffee, sugar-cane, oranges and bananas have been introduced and are extensively cultivated. The flora of the continent embraces a large number of peculiar types that originated either in the highlands of Brazil or in the Andes.

The flora of the Amazon valley may be taken as the type of that of the moist tropical valleys. The forests are so dense, rank and matted with undergrowth as to be almost impenetrable. Palms are the most characteristic and beautiful trees, and reach their greatest development in the Amazon region. They take on a great variety of forms: some have trunks 100 ft. and more in height while others have no trunks at all, but spring like tufts from the ground; some are two feet or more in diameter, while others are as slender as a lead pencil. Bamboos grow to an enormous size and form dense thickets along certain streams. The shaded portions of the forests frequently abound in beautiful ferns, some of which are so small as to be almost microscopic, while others reach the dimensions of trees. For the most part the plants of the open campos have a stunted appearance and the grasses are wiry and tough.

A noteworthy feature of these tropical forests is that they are seldom made up of trees of a single species or of but few species. In

the high table-lands of southern Brazil, however, the araucarian pine grows in beautiful forests as far north as Barbacena in the highlands near the headwaters of Rio São Francisco. In the north-west of the continent the western slopes of the Andes are covered with a dense tropical vegetation, while on the east the slopes are comparatively bare. In the high mountains the flora is scanty and bears a general resemblance to that of the temperate regions; 60% of the genera are like those of the temperate zones, but the species are peculiar to the Andes. In the south of the continent plant life is necessarily less tropical.

Fauna.—The fauna of South America includes a large number of species but relatively a small number of individuals. With local exceptions this seems to be true of all the forms of life within the tropical portions of that continent. The land mammals are nearly all small; the tapir is the largest of them, and is found only in the northern two-thirds of the continent. There are many species of monkeys, all of them arboreal in their habits. The only reptiles that are at all abundant are lizards, and in some places alligators. The alligators do not extend south of the La Plata region. Of snakes only the boa constrictor and the water boa are large, and these, like all other kinds, are not abundant. Certain ruminants having long woolly hair are found only in the high Andes; these are the llamas, alpacas and vicuñas. The llama has been domesticated and is used for carrying small burdens. The condor, the largest living bird of flight, inhabits the lofty Andes. The insects of the highest mountains are related generically, but not specifically, to those of the temperate latitudes of North America—a fact understood by biologists to mean that there has been no migration across the intermediate region since the glacial epoch. Owing to temperature and climatic conditions the life forms of the high Andes, whether animal or plant, are more nearly related to those of the lower regions to the south than to those of the lower regions to the north.

The fresh-water fish fauna of the Amazon region is the richest in the world. The distribution of species shows that there has long been direct communication between the drainage of the three great river systems, namely, the Orinoco, the Amazon and the Paraguay.

Inhabitants.—At the time of the discovery of the South American continent by Europeans, the races inhabiting it differed greatly among themselves in customs, languages and civilization. They had then generally developed the arts of spinning, weaving and the manufacture of pottery, and locally were skilled in certain kinds of metallurgy, sculpture, architecture and agriculture. These aboriginal peoples have necessarily been profoundly affected by the invasion of European races and the importation of African races, but in some localities their descendants still form the bulk of the population, and the native American languages are still spoken.

Immediately after the discovery of South America the western and northern portions of the continent and the region of the Rio de la Plata began to be colonized by Spaniards, while the eastern portion was colonized by the Portuguese. To these races were added Africans, for many years imported as slaves, especially into Portuguese territory. Of late there has also been a large immigration of Italians into Argentina and southern Brazil. In Argentina about 18% of the population is foreign-born, and of these 56% are Italian, 22% Spanish and 11% French. In Chile only 2.3% of the population is of foreign birth.

Spanish is the language of the country from the eastern end of Venezuela through all the northern and western parts of the continent and over a large part of the Paraguay basin. Throughout Brazil, which covers little less than half of the entire continent, the language is Portuguese. South America is therefore pre-eminently a Latin continent; its few British, Dutch and German colonies count for less in the great ensemble of its population than do the depleted aboriginal races themselves.

Political Geography.—The continent was first visited by Europeans in 1498, when Columbus upon his third voyage touched at the mouth of the Orinoco. Other navigators **Discovery.** shortly followed and sailed along the northern and eastern coasts, and by 1509 the coast had been visited as far south as the Rio de la Plata. In 1513 Balboa discovered the Pacific Ocean in the Gulf of Panama, and in 1520 Magellan (properly Magalhães) passed through the straits of Magellan and crossed the Pacific Ocean. Inland the earliest explorations followed the Amazon river, but aside from the discovery of the size, course, and character of the river and its immediate shores, they were of but little importance. Great impulse to exploration and development was given by the silver mines of Peru and later by the discovery of gold and diamonds in the highlands of Brazil.

The early settlement of South America by Europeans began shortly after the discovery of the continent. These settlements were originally colonies under the control of Spain and of Portugal, and they remained for some time dependencies of the mother countries. Eventually, however, they became indepen-

dent. For many years most of these countries were more or less disturbed by internal dissensions and revolutions, but in process of time, and as industries and commerce have become better established, the governments have become more stable.

The political divisions of the continent are best seen upon an ordinary map, and verbal descriptions of them are therefore omitted. Brazil is the largest and most important single country. The bulk of the remainder is divided into several Spanish-speaking republics that border the continent from Venezuela on the north to Patagonia on the south, while between Venezuela and the Brazilian frontier on the north-east are three comparatively small countries known as British Guiana, Dutch Guiana and French Guiana. These Guianas are the only places at which colonies under European control are established on the mainland of South America. There are, however, a few islands that belong to European countries, such as Trinidad, Tobago and the Falkland Islands to Great Britain, and Curaçao, Buen Ayre and Oruba to Holland.

Industries and Commerce.—The industry that gave the first great impetus to the settlement of South America by Europeans was mining. The silver deposits of the Andes awakened the cupidity of adventurers shortly after the discovery **Mining.** of the continent, and large numbers of Spaniards poured into that region. The mining of silver that had begun in that part of the world in prehistoric times has continued down to the present day. The Potosi mines of Bolivia are supposed to have yielded in all over a billion and five hundred million dollars' worth of silver. The guano of the coast of Peru and the nitre beds of Chile are now, and have long been, among the most important and valuable natural deposits of the kind in the world. In the world's production of borax Chile ranks third; in the production of tin Bolivia ranks third.

In 1693 gold was found in the highlands of Brazil, and within a few years Minas Geraes ("General Mines"), as the mining district was called, came to be the leading gold-producing region of the world. The mines reached their greatest productiveness between 1752 and 1761, when the annual yield was worth about six million dollars. During the early period most of the gold came from placer washings. Many mines in the hard rocks have been opened, some have been worked out and exhausted, and some are still in operation. The total gold production of all South America for the year 1895 was estimated at about \$13,000,000.

In 1729 or possibly a little earlier diamonds were also discovered in the gold districts of Brazil, and a fresh impetus was given to European immigration and to the importation of African slaves to work the mines. From that time down to the discovery of diamonds in South Africa Brazil was the leading producer of diamonds in the world. The diamonds are found in three widely separate districts: in the state of Minas Geraes in the vicinity of Diamantina, in the state of Bahia in the vicinity of Lenções, and on the headwaters of the Paraguay river in the state of Matto Grosso. The Bahia region also produces carbonados, or the black diamonds used in the manufacture of diamond drills. The best estimate possible places the market value of the diamond production of Brazil from 1729 to 1885 at \$100,000,000. Of late years Brazil has led the world in the production of monazite, which occurs on the coast of Bahia in the form of beach sands. In 1905 the output of manganese by Brazil was second only to that of Russia. There are enormous deposits of iron ore in Minas and São Paulo, though but little developed at present. The agates of southern Brazil are famous.

The forest industries are chiefly such as depend upon the natural products of tropical forests. They include the gathering of rubber, cacáo, coca, ipecac, balsam copaiva, cinchona bark, palm fibre (piassába), brazil-nuts and Paraguay tea. **Forests and Agriculture.** The bulk of the world's supply of cacáo comes from Ecuador, Brazil, Venezuela and Colombia. There is much wood suited for fine cabinet work, but the facilities for supplying such woods are limited. The agricultural industries are chiefly those suited to tropical countries. Those that have reached the greatest development are the growing of sugar cane and the manufacture of sugar, and the growing and preparation for market of cotton, coffee and tobacco. Sugar is made mostly near the sea-coast from near Rio de Janeiro northward along the eastern side of the continent. Cotton is grown in the interior from Bahia northward, while the chief coffee-producing region is in the Brazilian states of São Paulo, Rio de Janeiro, Minas, Espírito Santo and Bahia. Wheat is one of the chief agricultural products of the Argentine Republic. The most important pastoral industries are in the region about the Rio de la Plata, where wool growing and stock-raising have reached a marvellous development.

The manufacturing industries are necessarily not so well developed as those of older countries. In the early history of the South American colonies the home countries were **Manufactures.** interested in the building up of an export trade, and manufacturing in the colonies was therefore discouraged, even by

direct legislation, while trade with other than the parent countries was prohibited. For some time after the independence of the new countries, facilities for manufacture and transport were poor, while the lack of established commercial relations and facilities retarded their growth. The development of manufacturing industries has been more marked of late years, though internal development is still retarded by the lack of highways.

The exterior commercial relations of South America were at first naturally and necessarily with Spain and Portugal. In time other European countries established relations with the rising South American cities, the relative importance of Spain and Portugal in South American commerce has greatly diminished, and the bulk of trade is now with other countries.

EXPORTS AND IMPORTS OF THREE SOUTH AMERICAN COUNTRIES
(In millions sterling, annually c. 1906-1910.)

	Imports from	Exports to
Argentina	United Kingdom 20	United Kingdom 15
	Germany 9	Belgium 8
	United States 9	Germany 8
Chile	United Kingdom 6	United Kingdom 11
	Germany 5	Germany 5
	United States 2	United States 3
Uruguay	United Kingdom 2	France 1.5
	Germany 1.1	Argentina 1.4
	France 1	Germany 1

CHIEF EXPORTS OF THREE AMERICAN COUNTRIES
(In millions sterling.)

Argentina	Animals and products	48
	Agricultural products	23
Brazil	Coffee	33
	Rubber	19
Chile	Nitrates	17
	Copper	2

Settlement.—The continent as a whole is but sparsely settled. The total population in 1905 was reckoned to be 38,482,000. About half of it, including all the most inaccessible portions, had a population probably not much exceeding what it had at the period of the discovery. It averaged five persons to the square mile, while in North America it was 13 and in Europe 104 to the square mile. The most thickly populated parts are on and near the sea-coast. On the east seaboard a more densely populated narrow belt follows the coast from near Natal just south of Cape St Roque to and south of Buenos Aires. About the cities of Pernambuco, Bahia, Rio de Janeiro, São Paulo, Rio Grande do Sul, Montevideo and Buenos Aires the areas of greater density widen, and, in some instances (notably near Rio de Janeiro, São Paulo and Buenos Aires) extend inland for several hundred miles. The considerably populated belt begins on the west coast about latitude 42° and follows northward and eastward to the island of Trinidad on the Venezuelan coast, though there are stretches of coast almost entirely uninhabited. Several of the largest cities of South America compare favourably with the finest cities of Europe. The best streets of Rio de Janeiro, Montevideo, Buenos Aires and Valparaiso are among the most attractive in any part of the world. The large cities are all well supplied with water, lighted with electricity, possess facilities for transport and are supplied with public libraries, museums of science and arts and educational institutions.

Communications.—The commercial relations of South America with the outside world are maintained by a large number of regular and well-equipped lines of steamers running between its ports and European ports. There is also a large freight business done by steamers sailing at irregular periods, and by sailing vessels. Connexions with the interior of the continent were for a long time confined to navigation along the principal streams and to tedious overland travel on horseback along almost impassable trails. Since 1858, however, when the first 30-m. section of the Dom Pedro II railway from Rio de Janeiro to Queimados was opened, railways have extended far inland and even across the Andes. The boring of the tunnel completing railway connexion between Buenos Aires and Valparaiso was completed in November 1909. Railway building has been especially active in Brazil and in the Argentine Republic. From Rio de Janeiro and São Paulo lines now penetrate the highlands of Minas Geraes, while from Buenos Aires they cover the most productive portions of the Argentine Republic, and bring some portions of the interiors of these countries into close communication with all parts of the world. In the meanwhile river and coastwise navigation has greatly developed.

The railway mileage of the various countries was approximately as follows in 1906:—

	Miles of Railway.
Argentine Republic	11,460
Bolivia	700
Brazil	10,408
Chile	2,800

Miles of Railway.

Colombia	411
Ecuador	125
Paraguay	156
Peru	1,146
Uruguay	1,210
Venezuela	529

BIBLIOGRAPHY.—Anonymous, *The History of South America from its Discovery to the Present Time . . .* By an American. Translated from the Spanish by Adnah D. Jones (London, 1899); A. H. Keane, *Central and South America*, i. 611, ill.; ii. 410-478 (London, 1901), vol. ii. relates chiefly to Central America, but Trinidad and the Guianas are included in this volume; Hugh Robert Mill, *The International Geography*, "South America," pp. 813-888 (New York, 1900); E. Réclus, *Nouvelle géographie universelle. Amérique du Sud*. (Paris, 1893), a monumental work; Wilhelm Sievers, *Süd und Mittelamerika*, 2^{te} Aufl. (Leipzig and Vienna, 1903), this work contains a valuable bibliography at the end of the volume; Robert Grant Watson, *Spanish and Portuguese South America during the Colonial Period* (London, 1884), Travels.—Frank G. Carpenter, *South America; Social, Industrial and Political* (New York, 1900); Francis de Castelnau, *Expédition dans les parties centrales de l'Amérique du Sud, de Rio de Janeiro à Lima, et de Lima au Pará* (1843-1847); *Histoire du voyage* (Paris, 1850-1851); G. Earl Church, "South America: An Outline of its Physical Geography," *The Geographical Journal*, xvii. 333-409 (London, 1901). Sir Martin Conway, *Aconcagua and Tierra del Fuego* (London, 1902). William E. Curtis, *Between the Andes and the Ocean . . . from the Isthmus of Panama to the Straits of Magellan* (Chicago, 1900); Charles Darwin, *Journal of Researches into the Natural History, &c. of the Countries Visited during the Voyage of H.M.S. Beagle* (New York, 1878; other editions); A. Gallenga, *South America* (London, 1880; a good general description of conditions at the time). William Hadfield, *Brazil, the River Plate, and the Falkland Islands, &c.* (London, 1854); Captain Basil Hall, *Extracts from a Journal Written on the Coasts of Chile, Peru, and Mexico, in the years 1820-1822* (Edinburgh, 1824); Alexander Humboldt and Aimé Bonpland, *Personal Narrative of Travels to the Equinoctial Regions of the New Continent During the Years 1799-1804* (3rd ed., London, 1819-1829); C. B. Mansfield, *Paraguay, Brazil and the Plate. Letters written in 1852-1853* (Cambridge, 1856); Edward D. Mathews, *Up the Amazon and Madeira Rivers, Through Bolivia and Peru* (London, 1879); Alcide d'Orbigny, *Voyage dans l'Amérique méridionale (le Brésil, la République orientale de l'Uruguay &c.) exécuté pendant les années 1826-1833* (Paris, 1835-1849); James Orton, *The Andes and the Amazon, or Across the Continent of South America* (3rd ed., New York, 1876); Charles M. Pepper, *Panama to Patagonia* (Chicago, 1906); W. Reiss and A. Stübel, *Reisen in Südamerika* (Berlin, 1889); W. Smyth and F. Lowe, *Narrative of a Journey from Lima to Pará, &c.* (London, 1836); G. Steinmann, "Sketch of the Geology of South America," in *Amer. Nat.* xxv. 855 (1891); J. J. von Tschudi, *Reisen durch Südamerika* (Leipzig, 1866-1869); Frank Vincent, *Around and About South America* (5th ed., New York, 1895). See further AMAZON, ANDES, and the articles on the separate countries. (J. C. BR.)

SOUTHAMPTON, EARL OF, an English title borne by the families of Fitzwilliam and Wriothlesley. In 1537 Sir William Fitzwilliam (c. 1490-1542), lord high admiral of England, was created earl of Southampton. A son of Sir William Fitzwilliam of Aldwarke, near Rotherham, Fitzwilliam was a companion in boyhood of Henry VIII., and was knighted for his services at the siege of Tournai in 1513. Later he was treasurer of Cardinal Wolsey's household, and was sent several times to France on diplomatic business. As vice-admiral he commanded a fleet when England and France were at war in 1523. He was comptroller of the royal household, chancellor of the duchy of Lancaster, and keeper of the privy seal. He went to Calais to conduct Anne of Cleves to England and wrote in flattering terms to Henry about his bride. While marching with the English army into Scotland he died at Newcastle in October 1542. He left no sons and his titles became extinct.

In 1547 Thomas Wriothlesley (1505-1550) was created earl of Southampton. Entering the service of Henry VIII. at an early age, Wriothlesley soon made himself very useful to his royal master, and he was richly rewarded when the monasteries were dissolved, obtaining extensive lands between Southampton and Winchester. Having been on errands abroad, he was made one of the king's principal secretaries in 1540, and was knighted in the same year; in spite of the fall of his patron, Thomas Cromwell, he rose higher and higher in the royal favour, and in 1542 it was said that he almost governed everything in England. He sought to bring about an alliance between England and

Spain in 1543, and was created Baron Wriothesley of Titchfield in 1544. Having been lord keeper of the privy seal for a few months, he became lord high chancellor in 1544, in which capacity he became notorious by his proceedings against Anne Askew. He was one of the executors of Henry's will, and in accordance with the dead king's wishes he was created earl of Southampton in February 1547. However, he had committed an offence in appointing four persons to relieve him of his duties as lord chancellor and advantage was taken of this to deprive him of his office in March, when he also ceased to be a member of the privy council. Again in the council Southampton took a leading part in bringing about the fall of Somerset, but he had not regained his former position when he died on the 30th of July 1550. His successor was his son, Henry (1545-1581), the 2nd earl, one of the Roman Catholic nobles who conspired for the release of Mary Queen of Scots. He died on the 4th of October 1581 and was succeeded by his son, Henry, the 3rd earl (see below).

For the career of the 1st earl see Lord Campbell, *Lives of the Lord Chancellors; E. Foss, Judges of England*; and the various state papers and letters of the reign of Henry VIII.

The 3rd earl was succeeded by his son Thomas (1607-1667) as 4th earl. When the dispute began between the king and the parliament he took the side of the latter, but soon the violence of its leaders drove him into the arms of Charles, one of whose most loyal advisers he remained thenceforward. He was however very anxious for peace, and treated on behalf of the king with the representatives of the parliament in 1643, and again at Uxbridge in 1645. Having paid over £6000 to the state, Southampton was allowed to live unmolested in England during the Commonwealth period, and on the restoration of Charles II. he was made lord high treasurer. As treasurer he was remarkable for his freedom from any taint of corruption and for his efforts in the interests of economy and financial order. He died without sons on the 16th of May 1667, when his titles became extinct. Much of his property passed to his eldest daughter Elizabeth (d. 1693), wife of Edward Noel, 1st earl of Gainsborough (1641-1689). The name of the earl is perpetuated in London in Southampton Row and Southampton Street, Holborn, where his London residence stood. After the death of Lady Gainsborough the London property of the earl passed to her sister Rachel, wife of William, Lord Russell, the patriot, and later to the dukés of Bedford.

In 1670 the mistress of Charles II., Barbara, countess of Castlemaine, was created duchess of Cleveland and countess of Southampton. Her son, Charles Fitzroy (1662-1730), was created duke of Southampton in 1675, this title becoming extinct when his son William died in May 1774.

The barony of Southampton was created in 1780 in favour of Charles Fitzroy (1737-1797), a grandson of Charles Fitzroy, 2nd duke of Grafton, he being thus, like the holders of the dukedom of Southampton, descended from Charles II. and the duchess of Cleveland. The title is still held by his descendants.

SOUTHAMPTON, HENRY WRIOTHESLEY, 3RD EARL OF (1573-1624), one of Shakespeare's patrons, was the second son of Henry Wriothesley, 2nd earl of Southampton, and his wife Mary Browne, daughter of the 1st Viscount Montague. He was born at Cowdray House, near Midhurst, on the 6th of October 1573, and succeeded to the title in 1581, when he became a royal ward, under the immediate care of Lord Burghley. He entered St John's College, Cambridge, in 1585, graduating M.A. in 1589; and his name was entered at Gray's Inn before he left the university. At the age of seventeen he was presented at court, where he was soon counted among the friends of the earl of Essex, and was distinguished by extraordinary marks of the queen's favour. He became a munificent patron of poets. Nashe dedicated his romance of *Jack Wilton* to him, and Gervase Markham his poem on Sir Richard Grenville's last fight. His name is also associated with Barnabe Barnes's *Parthenophil and Parthenope*, and with the *Worlde of Wordes* of John Florio, who was for some years in his personal service as teacher of Italian. But it is as a patron of the drama and especially of Shakespeare

that he is best known. "My Lord Southampton and Lord Rutland,"¹ writes Rowland White to Sir Robert Sydney in 1599, "come not to the court . . . They pass away the time in London merely in going to plays every day" (*Sydney Papers*, ed. Collins, ii. 132). *Venus and Adonis* (1593) is dedicated to Southampton in terms expressing respect, but no special intimacy; but in the dedication of *Lucrece* (1594) the tone is very different. "The love I dedicate to your lordship is without end . . . What I have done is yours; what I have to do is yours; being part in all I have, devoted yours." Nicholas Rowe, on the authority of Sir William Davenant, stated in his *Life of Shakespeare* that Southampton on one occasion gave Shakespeare a present of £1000 to complete a purchase.

Nathan Drake in his *Shakespeare and his Times* (1819; vol. ii. pp. 62 seq.) first suggested that Lord Southampton was the person to whom the sonnets of Shakespeare were addressed. He set aside Thomas Thorpe's dedication to the "onlie begetter" of the sonnets, "Mr W. H.," by adopting the very unusual significance given by George Chalmers to the word "begetter," which he takes as equivalent to "procurer." "Mr W. H." was thus to be considered only as the bookseller who obtained the MS. Other adherents of the Southampton theory suggest that the initials H. W. (Henry Wriothesley) were simply reversed for the sake of concealment by the publisher. It is possible in any case that too much stress has been laid on Thomas Thorpe's mystification. The chief arguments in favour of the Southampton theory are the agreement of the sonnets with the tone of the dedication of *Lucrece*, the friendly relations known to have existed between Southampton and the poet, and the correspondence, at best slight, between the energetic character of the earl and that of the young man of the sonnets. Mr Arthur Acheson (*Shakespeare and the Rival Poet*, 1903) brings much evidence in favour of the theory, first propounded by William Minto, that George Chapman, whose style is parodied by Shakespeare in the 21st sonnet and in *Love's Labour's Lost*, was the rival poet of the 78th and following sonnets. Mr Acheson goes on to suppose that Chapman's erotic poems were written with a view to gaining Southampton's patronage, and that that nobleman had refused the dedication as the result of Shakespeare's expostulations. The obscurity surrounding the subject is hardly lightened by the dialogue between H. W. and W. S. in *Willobie his Avis*, a poem printed in 1549 as the work of Henry Willobie (*q.v.*) If the sonnets were indeed addressed to Southampton, the earlier ones urging marriage upon him must have been written before the beginning (1595) of his intrigue with Elizabeth Vernon, cousin of the Earl of Essex, which ended in 1598 with a hasty marriage that brought down Queen Elizabeth's anger on both the contracting parties, who spent some time in the Fleet prison in consequence. The "Southampton" theory of the sonnets cannot be regarded as proved, and must in any case be considered in relation to other interpretations (see SHAKESPEARE).

Meanwhile in 1596 and 1597 Southampton had been actively employed, having accompanied Essex on his two expeditions to Cadiz and to the Azores, in the latter of which he distinguished himself by his daring tactics. In 1598 he had a brawl at court with Ambrose Willoughby, and later in the same year he attended Sir Robert Cecil on an embassy to Paris. In 1599 he went to Ireland with Essex, who made him general of his horse, but the queen insisted that the appointment should be cancelled, and Southampton returned to London. He was deeply involved in Essex's conspiracy against the queen, and in February 1601 was sentenced to death. Sir Robert Cecil obtained the commutation of the penalty to imprisonment for life.

On the accession of James I. Southampton resumed his place at court and received numerous honours from the new king. On the eve of the abortive rebellion of Essex he had induced the players at the Globe theatre to revive *Richard II.*, and on his release from prison in 1603 he resumed his connexion with the stage. In 1603 he entertained Queen Anne with a performance

Roger Manners, 5th earl of Rutland, a close ally and friend of Southampton.

of *Love's Labour's Lost* by Burbage and his company, to which Shakespeare belonged, at Southampton House.

Southampton took a considerable share in promoting the colonial enterprises of the time, and was an active member of the Virginia company's council. He seems to have been a born fighter, and engaged in more than one serious quarrel at court, being imprisoned for a short time in 1603. He was in more serious disgrace in 1621 for his determined opposition to Buckingham. He was a volunteer on the Protestant side in Germany in 1614, and in 1617 he proposed to fit out an expedition against the Barbary pirates. In 1624 he and his elder son enrolled themselves as volunteers for the United Provinces of the Netherlands against Spain. Immediately on landing they were attacked with fever, to which both succumbed, the father surviving until the 10th of November 1624.

There exist numerous portraits of Southampton, in which he is depicted with dark auburn hair and blue eyes, compatible with Shakespeare's description of a "man right fair." Sir John Beaumont (1583-1627) wrote a well-known elegy in his praise, and Gervase Markham wrote of him in a tract entitled *Honour in his Perfection, or a Treatise in Commendation of . . . Henry, Earl of Oxenford, Henry, Earle of Southampton, Robert, Earl of Essex* (1624).

For further information see "Memoirs of Henry Wriothesley, the third Earl of Southampton," in Boswell's *Shakespeare* (1821), xx. 427 sqq., where many of the elegies on Southampton are printed; also Nathan Drake, *Shakespeare and his Times* (1817), ii. 1-20; Sidney Lee, *Life of William Shakespeare* (1898); Gerald Massey, *The Secret Drama of Shakespeare's Sonnets* (1888); Samuel Butler, *Shakespeare's Sonnets Reconsidered* (1899), where there is some distinctive criticism of the Southampton theory (ch. v.-vii.); an article by William Archer, "Shakespeare's Sonnets. The Case against Southampton," in the *Fortnightly Review* (Dec. 1897); and Sidney Lee's article on Southampton in the *Dict. Nat. Biog.*, arguing in favour of his identity with the hero of the sonnets. P. Alvor, in *Das neue Shakespeare Evangelium* (Munich, 1906), brings forward a theory that Southampton and Rutland were the authors of the Shakespeare tragedies and comedies respectively, and borrowed William Shakespeare's name to secure themselves from Elizabeth's suspicion.

SOUTHAMPTON, a municipal, county, and parliamentary borough of Hampshire, England, a seaport, and county in itself, 79 m. S.W. by S. from London by the London & South-Western railway. Pop. (1901), 104,824. It is finely situated near the head of Southampton Water, an inlet of the English Channel which forms the estuary of the river Test; on a peninsula bounded east by the river Itchen. There are considerable remains of the old town walls, dating from Norman times, but strengthened on various later occasions. The most remarkable portion occurs on the western side, where for a distance of nearly 100 yds. the wall is arcaded on its exterior face. The wall was strengthened by towers at intervals, such as the Arundel Tower at the north-western corner. The site of the castle, on the western side near the water, is built over, but the wall is well seen here. The castle was originally a Saxon fortress, and was rebuilt on the erection of the walls. It was partly demolished in 1650, and in 1805 its reconstruction was begun by the marquess of Lansdowne, but was not completed. Near the site there are some very ancient houses, one of which, known as King John's Palace, is of the highest interest, as it is considered to be earlier than any example of the 12th century in England, and is well preserved. Of the ancient town gates the Bar or North Gate, South Gate, West Gate, and Blue Anchor Gate remain. The first three are important; the South and West gates date from the early 14th century, while Bar Gate, as it stands, is later, and retains excellent Decorated work. Numerous early vaults remain below the houses within the walls. The two old churches, St Michael's, the central tower and lofty spire of which rise from Norman arches, and Holy Rood, partly Decorated, are greatly modernized. St Michael's contains a Norman font of black marble, comparable with that in Winchester Cathedral. All Saints' Church dates from 1795, and among numerous modern churches St Mary's, erected from designs by G. E. Street, is noteworthy, and occupies the site of a Saxon church. The

chapel of St Julian, where French Anglican services are held, is of transitional Norman architecture, greatly altered by restoration. It was originally attached to the hospital of God's House, founded in the time of Henry III. for eight poor persons, the existing buildings of which are modern. In the chapel are buried the earl of Cambridge, Lord Scrope, and Sir Thomas Grey, who were executed in 1415 outside the Bar Gate for conspiracy against Henry V. The chapel was allocated as a place of worship by Queen Elizabeth to certain Protestant Walloon refugees. The priory of St Denys, an Augustinian foundation of 1124, gives name to a suburb by the Itchen, and has left only fragmentary ruins.

In the municipal offices interesting ancient regalia and records are kept. The Gildhall, used as a court-house, is in the upper part of Bar Gate. Noteworthy modern buildings are the public library, corn exchange, custom-house, and assembly rooms. The Hartley Institution, founded under the will of Mr H. R. Hartley, contains a library, museum, art gallery, lecture hall, laboratories, and school of science and art associated with that of South Kensington, London; the foundation was created for

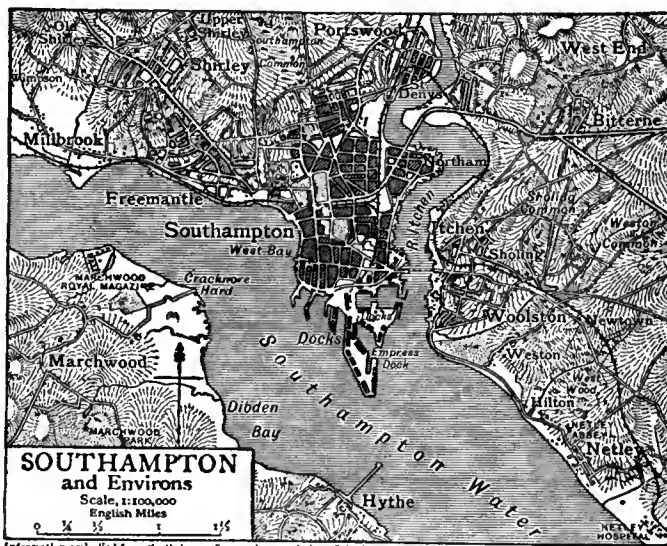

the advancement of natural history, astronomy, antiquities, and classical and Oriental literature. The Edward VI. grammar school was founded in 1550 and reorganized in 1875, and occupies modern buildings. Alderman Taunton's trade school was founded in 1752, and includes a technical department. The ordnance survey office is the headquarters of the ordnance survey department of Great Britain and Ireland. The Royal South Hampshire Infirmary is the principal of numerous benevolent and charitable institutions. To the north of the old town are the East and West Parks and the Hampshire county cricket ground, and to the south the small Queen's Park. Southampton Common, with its fine avenue, north of the town, was formerly part of the manor of Shirley. There is a statue in the parks of Dr Isaac Watts, the theologian (1674-1748), a native of the town, in whose memory the Watts Memorial Hall was erected in 1875. The headquarters of the Royal Southampton and the Royal Southern Yacht Clubs are in the town.

The history of the modern importance of Southampton as a port begins with the creation of a pier and harbour commission in 1803, and the erection of the Royal Victoria Pier (opened by Princess, afterwards Queen, Victoria) in 1831. But its present prosperity really dates from the opening of railway communication with London in 1840. The harbour is one of the finest natural harbours in the kingdom, and has the advantage of a double tide, the tide of the English channel giving it high water first by way of the Solent and two hours later by way of Spithead. In 1892 the docks, which lie at the southern end of the peninsula, became the property of the London & South-Western Railway Company. They measure about 300 acres; comprising extensive quays in both the Test and the Itchen

rivers, with 28 ft. and upwards of water at low water of ordinary spring tides, and over 15,000 lineal feet of accommodation; the Empress dock, 18½ acres, with a depth of 26 ft. at low water spring tide; the outer dock, 16 acres, with 18 ft. at low water spring tide; and the inner dock, 10 acres. In 1907 the construction of a new dock was undertaken, to cover 16 acres, with a depth of 40 ft. below low water. There are also two coal barge docks capable of floating 10,000 tons of coal at one time. There are five dry docks, having from 29 ft. to 12 ft. depth of water over blocks at neaps. The Prince of Wales, or No. 5 dry dock, opened in 1895, was at that time the largest single dock in the world; it is 750 ft. long by 87½ ft. wide at sill, and 112 ft. at cope level. In 1905 a sixth graving dock was opened, having a length of 875½ ft., and a width of 90 ft. at sill and 125 ft. at cope level. The principal passenger steamers sailing from the port are those of the Royal Mail Steam Packet Company for the West Indies and the Pacific (via Panama) and for Brazil and the River Plate, &c., and the Union-Castle line for the Cape of Good Hope, Natal, East Africa, &c., both of which companies have their headquarters here. New York is served by the American line, the North German Lloyd line, &c. Regular steamers serve the Channel Islands, Cherbourg and Havre, the principal English ports, Dublin, Belfast and Glasgow; and local steamers serve Cowes (Isle of Wight) and other neighbouring ports. The South-Western Company owns the local railway stations (Town and Dock and Southampton West, besides suburban stations), but through connexions are made with the north by way of the Great Western and Great Central and the Midland and South-Western Junction railways. Among the principal imports are cocoa, coffee, grain (including Indian corn), fruit, provisions (including butter, eggs and potatoes from France and the Channel Islands), wines and spirits, sugar, wool, and other foreign and colonial produce. Exports are all kinds of manufactured goods, such as cotton, linen, woollen, worsted and leather goods, machinery and hardware.

Southampton gives name to a suffragan bishopric in the diocese of Winchester. The parliamentary borough returns two members. The county borough was created in 1888. The town is governed by a mayor, sheriff, senior and junior bailiffs, 13 aldermen, and 39 councillors. The area, which includes the suburbs of Shirley, Freemantle and others, is 4501 acres.

History.—There was a Roman settlement of some importance on the site of the suburb of Bitterne on the E. bank of the Itchen. It was walled, and inscribed stones, coins, pottery, &c., have been found. It is probable that after the Danish invasions of the 11th century the modern Southampton (*Hantune, Suhampton*) gradually superseded the Saxon *Hantune* as the latter did the Roman settlement, the site being chosen for its stronger position and greater facilities for trade. It was a royal borough before 1086, and a charter of Henry II. (1154-5) declares that the men of Southampton shall hold their gild liberties and customs as in the time of Henry I. Richard I. in 1189 freed the burgesses from tolls and all secular customs. In 1199 John repeated the grant and gave them the farm of the customs of their own port and those of Portsmouth at a yearly rent of £200. Henry III. in 1256 granted all the liberties and customs enjoyed by Winchester. Grants and confirmations were made from the reign of Henry III. to Henry VI., that of 1401 (2 Henry IV.) granting further to the mayor and bailiffs cognisance of all pleas to be held in the Gildhall (*guyhalda*). The charter of incorporation was given by Henry VI. in 1445, under which the town was governed by a mayor, 2 bailiffs and burgesses, while by charter of 1447 the neighbouring district was amalgamated with the new borough as a distinct county under the title of "the town and county of the town of Southampton." Further privileges were granted by successive kings, and a charter was finally given by Charles I. in 1640. Southampton has returned two members to parliament since 1295. The inhabitants appear to have had a prescriptive right to hold a cattle-market, which was confirmed by Henry IV. in 1400, and later by Elizabeth. Markets on Wednesday for cattle and Friday for corn are now held. Trinity fair, dating from the year 1443, is now a pleasure fair. In

medieval times Southampton owed its importance to the fact that it was the chief port of Winchester. It had a large import and export trade, and in the 13th century was the second wine port in England. Wool was very largely exported, and the fact that it was brought to this port to be shipped probably led to the first establishment of the woollen trade in the W. of England. The rise of London as a port, the prohibition of the export of wool, the loss of the Winchester market after the suppression of the monastic institutions, and the withdrawal of the court led to the gradual decline of trade from the 16th century onwards until railway facilities and the opening of new dockyards gave Southampton the position it holds to-day.

See *Victoria County History: Hampshire*, iii. 490 seq.; B. B. Woodward, *History of Hampshire* (London, 1861-9); Rev. Silvester Davies, *History of Southampton* (London, 1883).

SOUTHAMPTON, a township of Suffolk county, New York, occupying the western part (W. of Easthampton) of the south-eastern peninsula of Long Island, S. of the Peconic Bay and N. of the Atlantic Ocean. Pop. (1900), 10,371; (1910), 11,240. Separated from the ocean by a narrow beach only, in the south-western part of the township are the nearly landlocked East Bay and Shinnecock Bay, and farther east are Mecox Bay (landlocked) and other ponds near the ocean. At Canoe Place, an old portage, Shinnecock Bay and Peconic Bay are less than 3 m. apart. On the northern shore of the township are the small settlements called Flanders, Southport, Sebonac, North Haven and North Sea. Nearer the south shore and served by the Long Island railway are Speonk, Westhampton, Quogue, Good Ground, Shinnecock Hills, Southampton (pop. in 1910, 2509), Water Mill and Bridgehampton, from which there is a branch line of the Long Island railway to Sag Harbor. Good sailing and sea-bathing are obtained at several places; and the golf links of the Shinnecock Golf Club, at Shinnecock Hills, is one of the best in the country. The first "summer cottages" were built near the village of Southampton in the latter part of the decade 1870-1880, and the summer colony was long called the "New York Annex" or the "Annex." The village of Southampton has been called the Newport of Long Island; in it is the Rogers Memorial Library (1893). The whale fishery was formerly important; it began here about 1660. The Shinnecock Indians long took part in it and many of the men of the tribe were lost in the wreck of the "Circassian" here on the 31st of December 1876. The Indians now on the reservation are mostly mixed bloods with a large proportion of negro blood. Southampton was settled in 1640, probably before Southold, by a "company of undertakers" formed in March 1639 at Lynn, Massachusetts, who received from James Forrett, agent of the proprietor, William Alexander, Lord Stirling, a patent dated the 17th of April 1640 for 8 m. square of land and whose deed from the Indians is dated the 13th of December 1640. Their first attempt to settle was broken up by the Dutch. The name may have been taken in honour of Henry Wriothsley, earl of Southampton. The settlement was a commercial scheme, and in spite of the rigid Puritanism of Abraham Pierson, their first pastor and a sympathizer with New Haven, the people voted to attach themselves to Connecticut (1645). The Mosaic law was adopted for the government of the township. In 1678 Governor Edmund Andros, in a note to the home government, said: "Our principal places of trade are New York and Southampton, except Albany for the Indjans." The village of Southampton was incorporated in 1894.

See Geo. R. Howell, *Early History of Southampton, L.I.* (2nd ed., Albany, 1887), and the *Town Records* (4 vols., Sag Harbor, 1874-1879), with notes by W. S. Pelletreau.

SOUTH AUSTRALIA, a British colonial state, forming part of the Commonwealth of Australia. (For map, see AUSTRALIA). It lies between 129° and 141° E. long., has Queensland, New South Wales and Victoria on the E., Western Australia on the W., and the Southern Ocean on the S. Originally its northern line was 26° S. lat.; by the addition of the Northern Territory the area was extended from 380,070 sq. m. to 903,690, and the northern border carried to the Indian Ocean;

but by acts of 1910 this territory was made over to the federal government. It is, however, described below.

The southern coast-line shows two large gulfs, Spencer and St Vincent—the first 180 m. long, the other 100. Spencer Gulf is open to the ocean, while St Vincent Gulf is partly shielded by Kangaroo Island, with Investigator Straits as its western and Backstairs Passage as its eastern entrance. Yorke Peninsula separates the two gulfs. Eyre's Peninsula is to the west of Spencer Gulf, and at its southern extremity are Port Lincoln, Sleaford Bay and Coffin's Bay, of which the first is the most important. Along the Great Australian Bight are several small bays, and the junction of South and Western Australia is on the Bight. Going eastward from the Gulf of St Vincent is Encounter Bay, through which there is an entrance to Lake Alexandrina, the mouth of the Murray river. The Coorong is the name given to the narrow sheet of water, nearly 200 m. long, formed by the Murray and separated from the ocean by a very narrow strip of land. Lacedpede and Rivoli Bays are the only other important indentations of this coast. In Northern Territory are several important indentations, Melville, Adam, Arnheim and Raffles Bays, Van Diemen's Gulf, Port Essington and Port Darwin (lat. 12° S.). The Gulf of Carpentaria divides the territory from Cape Yorke Peninsula of Queensland, the more important inlets on the shore of the gulf in Northern Territory being Caledon Bay and Limmen Bight. The principal island belonging to South Australia is Kangaroo Island, situated at the mouth of the Gulf of St Vincent; it is also the longest Australian island, measuring 210 m. by 85 m. at its widest part. Off the north coast of Northern Territory are Melville and Bathurst Islands, the Wessel group, and Grootte Eylandt in the Gulf of Carpentaria.

Mountain ranges are not an important feature of the country, which, on the whole, is level where not slightly undulating. In the south of the state the principal ranges run north and south; the Mount Lofty range, beginning at Cape Jervis, runs parallel with St Vincent's Gulf and at one or two points touches 3000 ft., Mount Lofty, near Adelaide, having an elevation of 2330 ft. The Flinders range rises on the eastern shores of Spencer Gulf and extends north for several hundred miles, terminating near the so-called Lake Blanche; there are in this range several isolated peaks which attain 3000 ft., the most prominent being Mt Remarkable, 3100 ft., Mt Brown, about the same height, and Mts Arden and Serle, about 3000 ft. The Gawler range, running across Eyre's Peninsula, south of the lakes, attains an elevation of about 2000 ft. at several points. Beyond Lake Torrens the ranges tend in the direction of north-west and afterwards east and westerly; and occasional summits reach 5000 ft. Northern Territory is traversed by several minor ranges, but the country has not been thoroughly explored and the heights and direction of the ranges have not been in all cases determined; no elevation above 2000 ft. has, however, been discovered.

South Australia is by no means a well-watered country, but there are some fine streams in the north of Northern Territory. In South Australia proper the Murray enters the sea at Lake Alexandrina, after having received the drainage of three states. The Torrens, Wakefield, Hindmarsh, Tuman and Gawler are unimportant streams; on the banks of the first named is situated the city of Adelaide. From Queensland flows the Barcoo, or Cooper's Creek, into Lake Eyre, which also receives the Macumba, with its tributary the Alberga, and several other rivers. These are rivers only when they are filled with the torrential rains of the interior, and for the most part are depressions destitute of water. Northern Territory is marked by an absence of water except at the extreme north, where there are several fine rivers, some of which are navigable for over 100 m.; the most noteworthy are: the Roper, flowing into Limmen Bight in the Gulf of Carpentaria, the Liverpool, the South Alligator, the Adelaide, the Daly and the Victoria. There are numerous lakes shown on the maps of South Australia, but none are permanent; they are depressions filled by the rivers in times of flood, but otherwise waterless or containing shallow pools of salt water. (T. A. C.)

Geology.—South Australia may be divided geologically into four parts, the geology of each of which is so distinct that they may be

conveniently considered apart. These divisions are (1) the Great Valley of South Australia and the adjacent highlands that border it, (2) the Lake Eyre Basin, (3) the Western Plateau, (4) the basin of the Lower Murray, with (5) the Northern Territory.

The western division consists of a plateau of Archean gneisses, granites and schists, which extend across Australia from the Eyre Peninsula on the south to the northern coasts on Port Darwin. In the south-western corner of the state the Archean plateau is separated from the Southern Ocean by the Cainozoic limestones of the Nullarbor plains, which extend from the shore of the Great Australian Bight to the foot of the great Victorian desert. Thence northward, the Archean rocks form the whole foundation of the country, until they end in a scarp, the "so-called coastal range," to the south of the Gulf of Carpentaria, and in the exposures near Palmerston, on Port Darwin. This plateau bears occasional deposits of later age. The chief of these are the Ordovician rocks of the Macdonnell Chain; they there trend approximately west-north-west to east-south-east, and represent part of the old Lower Palaeozoic mountain chain, which appears to have once extended across Australia from Kimberley to Adelaide and Tasmania. To the north-east of the Ordovician rocks of the Macdonnell Chain are the Cambrian deposits of Tempe Downs and the head of the Herbert river. Some Jurassic fresh-water deposits occur in basins on the plateau, having been proved by a bore, now being put down, in the hope of forming a flowing well at Lake Phillipson.

In contrast to the striking uniformity of the Western Plateau is the geological complexity of the part of South Australia known as "the Counties," including the settled districts in the south of the state around Spencer Gulf. The country is underlain by Archean and granitic rocks; they are exposed in the Gawler Range to the west, in the Archean outcrops near the New South Wales frontier, on the railway to Broken Hill, and at the foot of the highlands, along the western edge of the Murray basin. The highlands of South Australia consist mainly of contorted Lower Palaeozoic rocks, including the best representative in Australia of the Cambrian system. These Cambrian deposits, in addition to yielding a rich Cambrian fauna, contain a long belt of glacial deposits, the discovery of which is due to W. Howchin. These highlands form the whole of the mountainous country to the east of Lake Torrens; they extend southward to the highlands behind Adelaide, and form the axis of Kangaroo Island, while a branch from them forms the backbone of Yorke Peninsula. The highlands end to the north along a line running approximately east and west through Mt Babbage and the Willouran and Hergott ranges, to the south of Lake Eyre. The country to the west of Lake Torrens is a plateau, capped by the Lake Torrens Quartzites, which are apparently of Upper Palaeozoic age. This plateau has been separated from the South Australian highlands by the formation of the rift valley, in which lie Lake Torrens and Spencer Gulf. St Vincent Gulf occupies a faulted area between the Mount Lofty ranges, the Yorke Peninsula and Kangaroo Island. The south-eastern corner of South Australia is occupied by the basin of the Lower Murray, which in middle Cainozoic times was occupied by a sea, in which was laid down a thick series of marine sands and limestones. These rocks have yielded a rich fossil fauna from the cliffs beside the Murray. In the southern part of this district there is a western continuation of the basaltic sheets so conspicuous in Victoria. Some of them have been ejected from volcanoes, of which the vents are still well marked. The best extinct crater known is Mt Gambier.

The Lake Eyre basin occupies a vast depression to the north of the South Australian highlands; it is bounded to the west by a line of ridges and mountains of Archean and Lower Palaeozoic rocks, which connect the north-western end of the South Australian highlands with the mountains on the Archean plateau at the head of the Macumba and the Finke rivers. The Lake Eyre basin was occupied in Lower Cretaceous times by a sea, which extended southward from the Gulf of Carpentaria; and it appears to have been bounded to the south by the northern edge of the South Australian highlands. In this sea were laid down sheets of clays, known as the Rolling Downs formation. After the retreat of this sea the clays were covered by the Desert Sandstone, which has been cut up by denudation into isolated plateaux and tent-shaped hills. On the margin of the Desert Sandstone in Queensland there are some marine beds interstratified with the Desert Sandstone, and the fossils fix its age as Upper Cretaceous. The origin of the Desert Sandstone has given rise to considerable discussion; but it is no doubt in the main a terrestrial formation including some lake deposits. The surface is often converted into a vitreous quartzite by deposition of an efflorescent chert. Obsidian buttons are scattered over the central deserts, and have been regarded as of meteoric origin; they have also been considered proof of local volcanic action, but they have probably been scattered by the aborigines. Extensive estuarine deposits of Pliocene or early Pleistocene age, with a rich fauna of extinct marsupials and birds, occur on the plains to the east of Lake Eyre.

The Northern Territory includes the mountains of the Macdonnell Chain, and all the country thence to the northern coast. It consists of an Archean plateau, covered in places by Cambrian and Ordovician deposits. To the north of the Victoria river and the Roper

River, the country rises into a high, dissected table-land of Archean rocks; but round the coast there is a coastal plain including Permian, Carboniferous, Cretaceous and Cainozoic deposits. The Cretaceous deposits include ammonites of the *varians* type and a species of *Aucella*.

The chief mineral product of South Australia is copper, the mines of which occur in Cambrian limestones along the western edge of the South Australian highlands at Moonta, Wallaroo and Burra Burra. Gold occurs in numerous small mines in the South Australian highlands; and also in the Western Plateau, as in the Tarcoola goldfield; and in the Northern Territory, in the Arltunga goldfield, at the eastern end of the Macdonnell chain. Gold and tin are scattered in the Arnhem Peninsula of the Northern Territory; but hitherto the gold-mines of South Australia have been less important than those of any other of the Australian states. The only coal deposits are those formed in lacustrine deposits of Jurassic age, as at Leigh's Creek, east of Lake Torrens, where they have been mined.

Most of the geological information regarding South Australia is scattered in a series of reports, mainly by H. Y. L. Brown, published in the parliamentary papers of South Australia. There are also numerous reports by R. Tate, W. Howchin, &c. in the *Trans. R. Soc. S. Austral.* The geology of the Macdonnell range is described in the reports of the Horn Expedition, and the fauna of Lake Callabonna in *Memoirs* issued by Stirling and Zeitz, published by the Royal Society of South Australia. The literature is catalogued in Gill's *Bibliography of South Australia* (Adelaide, 1885), and that of the Lake Eyre basin and its adjacent islands in J. W. Gregory, *The Dead Heart of Australia* (1906). The Miocene marine fauna has been catalogued last by Dennant and Kitson, *Records Geol. Survey, Victoria* (1905), No. II. (J. W. G.)

Fauna.—South Australia is not separated from the neighbouring colonies by any natural boundaries; hence the fauna includes many animals which are also to be found in the land lying to the east and west. The northern half of the colony lies within the tropics, and possesses a tropical fauna, which is, however, practically identical with that of Northern Queensland. In spite of its immense extent north and south, and a corresponding diversity in climate, the colony is poorer in animal life than its neighbours. It possesses thirty-five genera of mammals. These include both genera of the order *Monotremata*—the *Echidna*, or spiny ant-eater, and the *Ornithorhynchus*, or duck-billed platypus, both of which are found also in Eastern Australia and Tasmania. The other order of *Mammalia* associated with Australia, the *Marsupialia*, is well represented in South Australia. It contains seven genera of *Macropodidae* or kangaroos, including the wallaby and kangaroo rat, four genera of *Phalangistidae*, or opossums, and five species of *Dasyuridae*, or "native cats." Two genera of this family are peculiar to the region—the *Chaetocercus* and the *Antichinomys*; the latter is found in the interior. It is a mouse-like animal with large ears, and is remarkable for the elongation of its fore-arm and hind-foot and for the complete absence of the hallux. The *Phascologomys*, or wombat, one of the largest of the marsupials, is also found in South Australia, and the curious *Myrmecobius*, or ant-eater of Western Australia. This remarkable animal is about the size of a squirrel; it possesses fifty-two teeth (a greater number than any known quadruped), and, unlike the other members of its order, the female has no pouch, the young hanging from nipples concealed amongst the hair of her abdomen. The *Choeropus*, with peculiarly slender limbs and a pouch opening backwards, is found in the interior. The remaining *Mammalia* consist of the dingo, or native dog, and a few species of *Muridae*, the mouse family, and *Cheiroptera*, or bats. There are about 700 species of birds, including 60 species of parrots. Of the 9 families peculiar to the Australian region, 5 are well represented, including the *Meliphagidae* (honey-suckers), *Cacatuidae* (cockatoos), *Platycercidae* (broad-tailed and grass parakeets), *Megapodidae* (mound-makers) and *Casuaridae* (cassowaries). The last-named family is represented by the *Dromaeus*, or emu, which is hunted in some parts of the colony. Reptiles are fairly represented: there are fifteen species of poisonous snakes. The lizards are very peculiar; South and Western Australia contain twelve peculiar genera. No tailed *Amphibia* exist in the continent, but frogs and toads are plentiful.

Flora.—The plant species resemble those of the eastern colonies and Western Australia, but are more limited in variety. The colony, from its dryness, lacks a number known elsewhere. Enormous areas are almost destitute of forests or of timber trees. The *Eucalyptus* family, so valuable for timber and gum as well as for sanitary reasons, are fairly represented. Acacias are abundant, the bark of some being an article of commerce. Flinders range has much of the valuable sugar-gum, *Eucalyptus Corynocalyx*, which is being now preserved in forest reserves. Its timber is very hard and strong, not warping, resisting damp and ants. The head-flowered stringybark, *Euc. capitellata*, has a persistent bark. A sort of stringybark, *Euc. tetradonta*, is found in Northern Territory. The gouty-stem tree (*Adansonia*) or monkey-bread of the north is a sort of baobab. About 500 northern plants are Indian. The *Tamarindus indica* occurs in Arnhem land, with native rice, rattans and wild nutmeg. The cedar is of the Indian variety. Pines are

numerous in the south, palms in the north; among the most beautiful is the *Kentia acuminata*. Banksias are very common in sandy districts. Flowering shrubs are common in the south. There are 130 known grasses in Northern Territory.

Fisheries.—Whaling was formerly an important industry about Encounter Bay, as sealing was in Kangaroo Island. The whales have migrated and the seals are exterminated. On the northern side trepang or bêche-de-mer fishery is carried on, and pearl fisheries have been established. Of fish within colonial waters there are forty-two peculiar genera. The tropical north has similar fish to those of north Queensland, while those of southern bays resemble many of the species of Victoria, Tasmania and New South Wales. There are the barracouta, bonito, bream, carp, catfish, rock cod and Murray cod, conger, crayfish, cuttle, dogfish, eel, flatfish, flat-head, flounder, flying-fish, gadfish, grayling, gurnard, hake, John Dory, ray, salmon (so-called), schnapper, seahorse, shark, sole, squid, swordfish, whiting, &c. Though called by English names, the fish do not always correspond to those in Europe. The Murray cod is a noble fresh-water fish.

Climate.—The climate of South Australia proper is, on the whole, extremely healthy, and in many respects resembles that of southern Europe. In the south-eastern corner of the state the spring and winter seasons are most pleasant, and although the thermometer occasionally registers high in summer, the heat is dry and much more endurable than a much lesser heat in a moist climate. In the interior districts, however, the heat is sometimes very trying to Europeans. In Northern Territory the climate is of a tropical character, except on the table-lands where it is comparatively cool. Observation has determined the area of the state adapted by reason of seasonal rains to the growth of wheat, and in this area crops are almost certain; agriculture outside this area is, however, purely speculative. The average rainfall at Adelaide taken for a period of 52 years was 21.204 in. As the rain falls at seasonable times the quantity is sufficient for cereal cultivation. The maximum shade temperature recorded at Adelaide Observatory in 1905 was 109.7—the highest for any Australian city; the minimum was 34.8 and the mean temperature 61.1.

Population.—The population of South Australia in 1860 was 124,112, and the province was third in importance among the states forming the Australasian group. In 1870 the population stood at 183,797, and in 1880 at 267,573; in 1890 it was 319,414; in 1901, 362,604; and at the end of 1905, 378,208. These figures are inclusive of the population of Northern Territory, the province of South Australia, properly so-called, containing 374,398 inhabitants, and Northern Territory, 3810, the respective density of the two divisions being one person per square mile and one per 128 sq. m. The estimated population of Adelaide in 1905 was 175,000. The number of males in 1905 was 197,487, and the females 180,721. The births in the same year were 8868 and the deaths 3804, representing 23.44 and 10.05 per 1000 of population respectively. The birth-rate has declined greatly.

Dividing the years from 1861 to 1905 into five-yearly groups the following were the average birth-rates:—

Period.	Births per 1000 of Population.	Period.	Births per 1000 of Population.
1861-1865	44.14	1886-1890	34.48
1866-1870	40.60	1891-1895	31.24
1871-1875	37.24	1896-1900	26.59
1876-1880	38.28	1901-1905	24.46
1881-1885	38.52		

Illegitimate births are less frequent in South Australia than elsewhere in Australia; in 1905 the proportion of illegitimate to total births was 4.37%.

The death-rate has always been remarkably light, not having exceeded 13 per 1000 in any year since 1886. The averages for each quinquennial period from 1861 were as follows:—

Period.	Deaths per 1000 of Population.	Period.	Deaths per 1000 of Population.
1861-1865	15.70	1886-1890	12.55
1866-1870	15.01	1891-1895	12.08
1871-1875	15.83	1896-1900	11.93
1876-1880	14.90	1901-1905	10.78
1881-1885	14.71		

The excess of births over deaths in 1905 was 5071 or 13.48 per 1000 of population. The number of marriages celebrated during 1905 was 2599; this represents a marriage-rate of 6.87 per 1000. The number of divorces and judicial separations during the ten years closing with 1905 was 72.

The people are mainly of British race; out of 362,604 persons whose birthplace was ascertained at the census of 1901, 348,352 were of British or Australian parentage, the number born in the Commonwealth being 289,440, and in South Australia itself 271,671; 9396 were born on the continent of Europe, of whom 6664 were Germans, and 931 Scandinavians and 3253 were Chinese. The total foreign-born element of the population numbered only 3.73%.

The census showed the number of breadwinners in the state to be 153,296—120,328 males and 32,968 females. Agriculture, the main industry, provided employment for 34,186 persons, of whom 33,039 were males and 1147 females. Pastoral pursuits employed 4193, dairying 2868 and mining 6301. The industrial class may be divided into (a) persons engaged in manufacturing industries, 18,163 males, 6761 females; (b) persons engaged in the construction of buildings, railways, roads, &c., numbering 8652; and (c) persons engaged in other industrial pursuits, 7657—these are chiefly persons whose census description is merely labourer. The commercial class, including trades of all kinds as well as persons engaged in finance, numbered 20,165, namely 17,080 males and 3085 females. The professional class comprised 5372 males and 3485 females, or a total of 8857; while the domestic class—comprising persons engaged in providing board and lodging, hotel and restaurant keepers, as well as servants—numbered 17,981, namely 3452 males and 14,529 females. The foregoing classes show the distribution of employment amongst the 153,296 breadwinners; the remainder of the population, comprising 209,308 persons (64,094 males and 145,214 females) were dependent on the breadwinners.

Administration.—South Australia, as one of the states of the Commonwealth, returns six senators and seven representatives to the Federal parliament. The local parliament consists of a Legislative Council and a House of Assembly. The former has eighteen members, elected by the districts into which the state is divided for that purpose, the franchise being limited to persons with freehold or leasehold estate, and to occupiers of dwellings of £25 annual value; while the Assembly contains 42 members, elected by 13 districts; the electoral qualifications for the Assembly are the attainment of the age of 21 years, and having been upon the electoral roll not less than six months. Women have the right to vote.

Local Government.—Adelaide was the first Australian city to acquire the right of self-government; on the 31st of October 1840 the first municipal elections in Australia were held in that city. There are 33 municipal councils and 142 district councils in the settled parts of the state, the area under local government being about 43,000 sq. m. Local rates are assessed upon the assumed annual value of the properties liable to be rated; and the amount of such assessed annual value was, in 1905, £2,739,808, and the capital value 55 millions. The revenue of the various local bodies in 1905 was £294,723, of which £170,235 was obtained from rates, £30,618 from government endowment and £93,870 from other sources; £130,489 was spent on public works. The total debt of the local bodies in that year was £102,261.

Education.—The South Australian system of popular education in its present form dates from 1878. It is compulsory, secular and free. The compulsory ages are over seven and under thirteen years, but children who have attained a certain standard of education are exempt from compulsory attendance. Religious instruction is not allowed to be given in state schools except out of ordinary school hours. Secondary instruction is in the hands of private and denominational establishments, and the university of Adelaide is well endowed and efficient. The state maintained in 1905 722 schools, with a gross enrolment of 59,026 pupils, and the average attendance was about 41,807. The sum expended in that year on public instruction was £181,583, and of that amount £150,000 was on account of primary instruction. Although education is free, the instruction department has a small revenue; this in 1905 amounted to £12,783, of which £6131 was derived from rents, £3630 from the sale of books and school material, and £682 from fees; the greater portion of the fees comes from the advanced school for girls, the remainder being paid by pupils attending classes in agriculture held in the public schools. The average cost of primary instruction to the state, including cost of school premises and maintenance, is about £3.11s. 4½d. per scholar in average attendance. The revenue of the Adelaide University in 1905 was £21,462, 15s. 7d., of which £6639 was obtained from the government, £9845 from fees and £4979 from other sources. The number of students attending lectures during the same year was 595, of whom 366 had matriculated. Technical education is well advanced; the School of Mines and Industries, founded in 1899, had in 1905 an enrolment of 1600 students. Private schools numbered 213, with 725 teachers and 10,206 scholars. Of the teachers 559 were engaged in general instruction, while 166 were specially engaged in particular subjects.

The peculiarity of religion is the strength of the non-Episcopal churches. The Church of England, which includes over 40% of the population of the other Australian states, claims only 27% in South Australia; and the Roman Catholic Church, whose adherents number 22% in the other colonies, numbers about 14% in South Australia. The Presbyterian churches have also fewer supporters, for only 5.5% of the population belong to such churches, compared with 13% in the other colonies. To the Wesleyan churches 19% of the population belong, to the Congregational churches 3.7%, Baptists 5.5%, Lutherans 7.5%, and other Protestants about 8%.

Finance.—For the year ending June 1905 the state had a public revenue of £2,798,849, which is equal to £7, 10s. 2d. per inhabitant. This amount includes revenue received by the Commonwealth government on behalf of the state. The principal sources of public revenue were: customs duties (balance of amount collected by the Commonwealth government), £555,692; land, income and other taxes, £442,030; railways, £1,279,481; public lands, £192,337; other revenue, £527,843. In 1871 the revenue of the province was £778,000, or £4, 4s. 3d. per inhabitant; from that year it rose rapidly until in 1881 it stood at £2,172,000, or £7, 16s. 10d. per head; in 1891 it was £2,732,000, or £8, 11s. 1d. per head. The expenditure for the year ended the 30th of June 1905 was as follows: railway working expenses, £746,636; public instruction, £181,583; interest and charges of public debt, £1,049,643; other services, £915,261. The debt charges amount to £2, 11s. 8d. per head, and absorb 36.28% of the total revenue of the state. Against this must be placed the net return from services upon which the loan moneys were expended; this amounts to about £746,459, so that the real burden of the state's debt is reduced to £303,184 per annum. On the 30th of June 1905 the public debt of the state stood at £28,727,895, which is equal to £78, 1s. 1d. per head; and the purposes for which the debt was incurred were: railway construction and equipment, £13,732,567; water supply and sewerage, £4,993,638; telegraphs and telephones, £1,010,738; and other works and services not producing direct revenue, £8,990,952. These figures include the debt of the Northern Territory. The amount of the debt at certain periods beginning with 1861 was:—

Year.	Total Debt.	Debt per Head.		
	£	£	s.	d.
1861	866,500	6	16	8
1871	2,167,700	11	13	7
1881	11,196,800	39	2	1
1891	20,347,125	62	9	2
1901	26,423,805	73	2	6
1905	28,727,895	78	1	1

Defence.—As part of the Commonwealth the defence of South Australia is undertaken by the Federal government. On the 31st of December 1905 the defence force of the state totalled 5066 men, comprising 1262 partially paid troops, a paid staff of 37 and 3178 riflemen. In addition to the land force there is a corps of 127 men capable of being employed on local war vessels, or as a light artillery land force.

Minerals.—South Australia, though without coal, was the first Australian colony to have a metallic mine, and the first to possess a gold-mine. In 1841 the wheel of a dray, going over a hill near Adelaide, disclosed to view silver-lead ore. In the midst of the bad times in 1843 the Kapunda copper-mine was found. In 1845 the wonderful Burra Burra copper was first wrought. The land, 10,000 acres, cost £10,000; and for several years the dividends to shareholders were 800% per annum. The first colonial mineral export was 30 tons of lead ore, value £128, in 1843. The copper declined as prices fell. It was £322,983 in 1885, when rates were £50 a ton, but £762,386 ten years before with over £90. In 1886 most of the mines were closed. Between 250 and 400 m. north of Adelaide a very rich copper district exists. Lead is very abundant. Manganese, nickel, bismuth, antimony and silver have been mined. Tin is seen in granitic places. Iron occurs in almost all formations and in all conditions. There is abundance of haematite, micaceous, bog and other ores rich in the metal. Talisker and other mines paid in silver. The wonderful Silverton, of Barrier Ranges, in a desert, is just outside the boundary, though 300 m. only from Adelaide while 600 from Sydney. Gold was got from a quartz vein at the Victoria mine, near Adelaide, as early as 1846, but did not pay the company. Partial gold working has been conducted at Echunga, &c., in southern hills. There are rich alluvial and quartz gold mines in Northern Territory, at from 100 to 150 m. south of Port Darwin. For the year 1884 the yield was £77,935. Of 1349 miners 1205 were Chinese. Gold is now worked at Waukarina, 225 m. north of Adelaide. Copper, tin and silver are found in Northern Territory. Among other minerals asbestos, roofing slates and fine marbles may be named. Some forty years ago precious stones, especially garnets and sapphires, were gathered in the Barossa Hills. Carbonaceous material is found at the Coorong, &c., yielding 50% of oil. Lake Eyre has a rude coal. Kapunda marble quarry is a success. The great copper mines at Moonta and

Walleroo are still worked, but the production has greatly fallen off. In 1900 the value of copper raised in the province was £386,015, and the gross production to the end of that year amounted to £22,321,969. The production of copper in 1905 was £470,324. Gold to the value of £85,555 was won in 1905, being chiefly obtained in Northern Territory; the total production of gold prior to that year was £2,764,336. The value of minerals other than gold and copper won during 1905 was £96,672. In 1871 the mineral production of the state was valued at £725,000, in 1881 at £421,000, in 1891 at £365,000 and in 1905 at £652,551.

Land System.—The aggregate area of South Australia, exclusive of the Northern Territory, is computed to be 380,070 sq. m., or 243,244,800 acres. About 136,828 sq. m., or a little more than one-third, represent the limits within which the country is at present occupied. The 46 counties proclaimed to date embrace an area of 80,453 sq. m. or 51,489,920 acres, of which 7,955,305 acres are purchased, 365,526 acres are partly purchased and 121,735 acres have been granted for public purposes, making the total area alienated, wholly or conditionally, 8,442,566 acres; 176,537 acres are set apart, but not granted, for forest purposes, and 42,870,817 acres are still in possession of the Crown but occupied under various kinds of tenure, chiefly for pastoral purposes. In addition to the land alienated, there are 17,104,062 acres held direct from the Crown by 19,511 lessees for farming or grazing purposes. Outside the counties are 299,617 sq. m. or 191,754,880 acres, of which 1105 acres are purchased, 23 granted for public purposes, 76,570,750 held by 497 lessees as sheep or cattle runs, leaving 115,184,130 acres open for pastoral settlement, if suitable.

Agriculture.—South Australia is essentially an agricultural state. In its first establishment the land was cut up for sale into eighty-acre lots with the view of settling the people on arrival, and concentrating them, instead of having them scattered as in the neighbouring colonies, in which pastoral pursuits completely dwarfed the farming industry. This wise provision made the colony for years the supplier of breadstuffs to Sydney, Melbourne, Brisbane, Perth and Auckland. As neighbours became wheat-producers, Adelaide merchants had to seek markets in Natal, Mauritius, the Cape, or even Europe. At all times the state has lent every assistance to agriculture. As the colony suffers more from drought than anything else, public reservoirs are constructed and artesian wells are sunk. Forest culture has especially attracted government attention. Reforestation and the establishment of nurseries for the trees, fruits and vegetables of other lands go hand in hand. Hundreds of thousands of trees are planted annually.

The chief industry is wheat-growing; out of 3,342,626 acres under cultivation in 1905, 1,757,036 acres were under wheat for grain and 317,924 under wheat for hay. In some parts of South Australia fine yields are obtained; but taking it as a whole, the yield of the province is light. During the ten years 1891–1900 the return per acre varied from a minimum of 1.7 bushels in 1897 to a maximum of 6.1 bushels in 1893. South Australian wheat is of excellent quality and strength, and well known in European markets, to which the province has sent wheat since 1850. There has been little expansion of wheat cultivation since 1880; nor, indeed, has there been any material expansion in the total area under crop. Up to the year mentioned, every season showed an additional area devoted to cultivation; but repeated failure of crops, due to want of seasonable rain, have disheartened farmers, and much land that was formerly cultivated now lies fallow; 1,087,057 acres were fallow in 1905. The following is a statement of the area of wheat harvested for grain at specified intervals from 1861:—

Year.	Acreage under Wheat.	Production.	Average Yield per Acre.
	Acres.	Bushels.	Bushels.
1861	310,636	3,410,756	11.0
1871	692,508	3,967,079	5.7
1881	1,768,781	8,087,032	4.6
1891	1,552,423	6,436,488	5.6
1899	1,778,770	8,778,900	4.9
1900	1,821,137	8,453,135	4.6
1901	1,913,247	11,253,148	5.9
1905	1,757,036	20,143,798	11.46

The total area under crop during the same period was: 1861, 400,717 acres; 1871, 837,730 acres; 1881, 2,156,407 acres; 1891, 1,927,689 acres; 1901, 2,369,680 acres. In 1905 other leading crops grown with this acreage were: oats, 56,950 acres; barley, 26,250 acres; potatoes, 9540 acres; vines, 23,603 acres; other crops, 30,532 acres.

In viticulture the province has made considerable progress, and many Germans are employed in the industry. The production of wine for the year 1905 amounted to 2,845,853 gallons, while 16,714 cwt. of currants and 8697 cwt. of raisins were also made. The wine made is of excellent quality, and 718,660 gallons, of a total production of 2,845,853 gallons, were exported in 1905, principally to London.

The production of wool has been one of the chief industries since the foundation of the state, but of late years it has been much affected

by droughts and low prices, so that the export of locally-grown wool in 1901 was considerably less in quantity than in 1880, and little more than half as valuable. In 1861 the colony carried 3,038,000 sheep; in 1871, 4,412,000; in 1881, 6,811,000; in 1891, 7,745,000; in 1900, 5,283,247; and in 1905, 6,202,330. The quantity of wool exported in the year last named was equal to 45,214,766 lb, valued at £1,668,214. As a cattle-breeding country South Australia does not take a prominent place beside the three eastern states of Australia. The province depastured, in 1905, 647,631 cattle as against 520,379 in 1904, 347,666 being in Northern Territory. In 1891 the number was 677,000, and 1881, 315,000. It was between 1881 and 1891 that Northern Territory was stocked. The horses in South Australia number about 216,350; the number in 1881 was 159,678.

Although there are some 30,000 persons engaged in one form or other of manufacturing, only 18,664 are accounted for in the annual statistics of the state; these hands are employed in 1339 establishments. The horse-power employed in the manufactories is 11,756, the value of the plant being estimated at £1,730,000.

Commerce.—The tonnage of shipping entering the ports in 1905 was 2,625,997, which is equal to upwards of 6 tons per inhabitant, a very considerable ratio compared with most countries; but this tonnage is quite beyond the requirements of the province, whose trade represents only about 750,000 tons per annum, and is due to the fact that Adelaide is a place of call for all the great lines of steamships trading between Europe and Australia; but when every allowance is made, it will be found that Adelaide is a great shipping centre and the third port of Australasia. The tonnage entering at Adelaide during 1905 was 2,106,854; at Port Pirie, 269,903; at Wallaroo, 105,228; and at Port Darwin, 116,981. The value of the total imports was £8,439,609, and the total exports £9,490,667. The ports command the greater part of the trade of the Broken Hill and trans-Darling districts of New South Wales, and this trade is very valuable both to the merchants and the railways of the province. The trade at the periods specified was:—

Year.	Imports.	Exports.	Total Trade.	Exports of Domestic Produce.
	£	£	£	£
1861	1,976,018	2,032,311	4,008,329	1,838,639
1871	2,158,022	3,582,397	5,740,419	3,289,861
1881	5,320,549	4,508,754	9,829,303	3,755,781
1891	10,051,123	10,642,416	20,693,539	4,810,512
1899	6,884,358	8,388,396	15,272,754	3,945,045
1900	8,131,782	8,122,100	16,253,882	3,770,983
1905	8,439,609	9,490,667	17,930,276	6,031,619

The great expansion following 1881 was due to the opening up of trade with the western districts of New South Wales. The exports of domestic produce, the value of which is given in the last column, when compared with the other figures in the table, show how greatly the province depends upon its re-export trade. The chief items of trade are breadstuffs, wool and minerals; the export of breadstuffs is very variable, depending so largely upon the rainfall, which in South Australia is extremely uncertain. In 1884 the value of wheat and flour exported was £2,491,896, falling to £633,426 in 1886, and rising again to £2,197,735 in 1888. Since the year last named there have been great fluctuations; in 1898 the export fell to £261,898; in 1899 it was £785,341; in 1900, £837,642; in 1901, £1,329,059; in 1904, £1,649,414; and in 1905, £1,877,318.

Railways.—The first railway was opened in 1856, and connected Adelaide with its port, and the following year saw a line connected to Gawler, 25 m. from Adelaide. The inability of the government to borrow money at reasonable rates greatly retarded the construction of railways in the province, and in 1875 there were less than 200 m. of line: in the next ten years 800 m. were opened for traffic, and in 1905 there were 1746 m. in the state proper and 146 m. in Northern Territory. There were, in addition, 34 m. of privately owned lines. The cost of constructing and equipping the state lines stood at £14,766,465 and the net earnings at £538,890; this represents 3.64% on the capital invested. The actual interest paid by the state upon its outstanding loans was in the same year 3.79%; there was therefore a loss of 0.15% upon the working of the lines; but the state claims that the indirect benefits of railway construction far more than compensate for the direct loss. The gross earnings for the year 1905 were £1,318,521, and the working expenses £756,403; the net profit per average mile open being £297, and per train mile 34.68 pence. In 1905 the number of passengers carried was 9,870,821, and the goods tonnage 1,684,793. South Australia has two gauges, namely 508 m. of 5 ft. 3 in., and 1384 m. of 3 ft. 6 in. line. The line joining Adelaide with the Victorian border, as well as several of the trunk lines, is on the wider gauge.

Posts and Telegraphs.—In 1905 there were 711 post-offices in the state of which 299 were also telegraph stations. The business transacted was: letters and postcards transmitted, 26,230,337; newspapers, 6,717,787; packets, 1,659,775; and telegrams, 1,244,126. The total revenue from these services for the year 1905 was £274,892, and the expenditure £259,656; in these sums are included the

*telephone revenue and expenditure, the former amounting to £25,815. These sums are exclusive of revenue received by the Commonwealth government. The use of telephones in Adelaide is rapidly extending; in 1905 there were eleven exchanges and 2284 telephones in actual use. There were 6092 m. of telegraph line in operation in that year; the state owns the principal overland line by which communication with Europe and the East is maintained.

Banking.—The assets of all the banks of issue trading in South Australia at the end of December 1905 amounted to £7,425,775, and the liabilities to £7,623,060; these latter comprised deposits at call and at interest, £6,866,281; notes and bills in circulation, £381,573; and other liabilities £52,929. Among the assets were coin and bullion £1,861,691. The South Australian people are very thrifty, and thirty-one in every hundred have accounts with the savings banks. On the 30th of June 1905 the depositors numbered 126,821, the amount of their credit being £4,380,358, a sum equal to £34, 10s. 9d. per depositor. Taking deposits in banks of issue and in savings banks together, the total was £11,186,639, which is equal to £29, 12s. 4d. per inhabitant.

AUTHORITIES.—E. G. Blackmore, *The Law of the Constitution of South Australia* (Adelaide, 1894); H. Y. L. Brown, *A Record of the Mines of South Australia* (Adelaide, 1890); John Ednie Brown, *A Practical Treatise on Tree Culture in South Australia* (Adelaide, 1881); J. F. Conigrave, *South Australia: A Sketch of its History and Resources. A Handbook compiled for the Colonial and Indian Exhibition in London, 1886* (Adelaide, 1886); B. T. Finnis, *The Constitutional History of South Australia, 1836-1857* (London, 1886); R. Gouger, *The Founding of South Australia*, edited by E. Hodder (London, 1898); William Marcus, *South Australia: Its History, Resources, Productions and Statistics* (London, 1876); Edwin Hodder, *The History of South Australia*, with maps (2 vols. 8vo., London, 1893); S. Newland, *The Far North Country* (Adelaide, 1887); *South Australian Year Book* (1904-1905); T. A. Coghlan, *Australia and New Zealand* (1903-1904). (T. A. C.)

History.—Though the coast of Northern Territory was well known to Portuguese and Spanish navigators as early as perhaps 1530, being called Great Java, it was not surveyed till 1644, when Tasman laid down the line of shore pretty accurately. The western part of the southern coast had been seen and named Nuyt's Land in 1627. But Flinders, by his discovery of the two great gulfs, Kangaroo Island and Encounter Bay, in 1802, was the first to reveal South Australia proper. Captain Sturt descended the Murray in 1830, and looked over the hills near Adelaide. The first to direct attention to a settlement there was Major Baron, who communicated with the colonial office in February 1831. His suggestion was to establish, at no charge to the British government, a private company, that should settle a party on Yorke Peninsula. He believed a large river entered Spencer Gulf. In August Colonel Torrens and others proposed to purchase land between 132° and 141°—500,000 acres at 5s. an acre. Some were in favour of Spencer Gulf, others of Kangaroo Island, and a few for the mainland towards the Murray. Memorialists in 1832 sought a charter for the South Australian Association, giving extensive powers of self-government. Land sales were to pay the passages of free labour, chiefly young married people, and no convicts were ever to be sent thither. Lord Goderich did not favour the scheme, and thought a colony with free institutions might prejudice the interests of New South Wales, while free trade would interfere with the English navigation laws. After much negotiation, the English authorities regarded the scheme more favourably, but would not consent to give the company the powers they sought. The company receded in their demands, and offered security for the proper observance of law and order, while depositing cash for the purchase of land. Captain Sturt in 1834 informed the colonial secretary that Spencer Gulf and Kangaroo Island were objectionable, but that the eastern side of St Vincent Gulf was the best locality. In 1835 the ministry got an act passed for the erection of a colony under commissioners appointed by the Crown, who would be responsible for their acts to the British government. It was arranged that a local government should be established when the settlement had 50,000 people. Mr George Fife Angas advanced a large sum as security to the state. Though the first settlers were sent to Kangaroo Island, all were afterwards gathered on the Adelaide plains. The colony was proclaimed under a gum tree on the 28th of December, 1836. Great delay took place in the survey of land. The South Australian Company purchased large tracts from

the commissioners at 12s. per acre and sold at 20s. A general speculative spirit arrested progress. Governor Gawler went into extravagant outlay on public buildings, &c., and drew against orders upon the English treasury. Such difficulties arose that the British rulers had to suspend the charter in 1841 and make South Australia a Crown colony. A revival of prosperity took place when the farms were tilled and poverty had taught prudence. Copper and lead mines were subsequently discovered. Kapunda in 1843, and the Burra Burra copper-mine in 1845, greatly aided in the restoration of commercial credit. The gold fever in Victoria drew off numbers in 1852; but the good prices then realized for breadstuffs gave a great impetus to farming.

In 1856 the colony was given its own constitution and self-government. On the attainment of autonomy Governor MacDonnell, in closing the last session of the then partially nominated legislature, made use of the following words: "I confidently expect that the extended political power entrusted to the people of this country, and the universal suffrage conceded by the new constitution, will prove in reality a safe and conservative measure; and whilst conferring the utmost possible power of self-government, will render stronger and more enduring than ever the cherished ties of affection and loyalty which link this province to the throne of our respected and beloved sovereign." This prediction appears to have been amply verified: South Australia enjoys the reputation of being one of the most progressive and at the same time one of the most stable of existing communities. From its origin as the venture of private enterprise the state has passed through orderly stages of evolution up to the zenith of democratic government. Such alterations as have been made in the constitution have been in the direction of a still further enlargement of the franchise. Payment of members proved to be the corollary of manhood suffrage. In 1887 a temporary act was passed for the payment of £200 a year to each member of both houses, and in 1890 the law was made permanent. Thus was rendered possible the direct representation of all classes. Soon afterwards the parliamentary Labour party came into existence; this forms a considerable proportion of the membership of both houses, and includes in its ranks men of the highest intelligence, industry and eloquence. In 1894 the principle of "one man one vote" was extended to that of "one adult one vote" by the inclusion of women as voters on terms of absolute equality with men. There is no bar to the election of women to parliament whenever the electors think fit to be so represented. The delegates to the Federal convention and to the Commonwealth parliament were in South Australia elected by the combined vote of men and women. Elections were formerly held in successive batches, but since 1893 they have taken place simultaneously in all the districts. Electoral expenses are rigidly limited, both as to objects and amount, and a declaration of money thus expended has to be filed by every candidate. Experience has demonstrated that, owing to the intrusion of the personal element, general elections have often failed to afford conclusive evidence of the state of the popular will. Attention was therefore directed towards the referendum as a means of obtaining an unquestionable verdict on important public issues, although no general statute was formulated on the subject. In 1896, at the general elections, the following questions were submitted to the electors: "Do you favour (1) the continuance of the present system of education in the state schools? (2) the introduction of scriptural instruction in the state schools during school hours? (3) the payment of a capitation grant to denominational schools for secular results?" An overwhelming majority pronounced in favour of (1) and against (2) and (3). Again, in 1899, a direct vote was similarly taken on the question of household franchise for the legislative council. Undoubtedly the practical application of the referendum in South Australia facilitated the adoption of this principle in the ratification and in the method of amendment of the Commonwealth constitution. The right of the Second Chamber to suggest amendments to bills which it has not power to amend was borrowed by the Commonwealth from the constitution of South Australia, as

also was the idea of a simultaneous dissolution of both houses as a means of overcoming possible deadlocks between the chambers. As one among many improvements in parliamentary procedure may be mentioned the practice of permitting bills lapsed owing to prorogation to be replaced on the notice paper in the ensuing session by motion without debate.

In partially settled countries such as South Australia the Crown lands policy rivals finance in engrossing the attention of the legislature, but as time goes on the relative importance of these subjects varies in inverse ratio. The earlier budgets, compared with those of later years, when the country had become more fully developed, might be said to resemble the finances of the nursery, whereas the initial alienations of land, comprising the most central and most valuable blocks, necessarily surpassed later transactions in significance. Many phases of public opinion as to the method of disposing of the Crown lands have been witnessed. A general review indicates clearly that the change has been uniformly in the direction of removing impediments and increasing facilities for the settlement of the people, either as freeholders or as state tenants, on the land. Under the auction system the land was allotted to the highest bidder, with the result that the payment of the purchase-money frequently exhausted the resources of the settler, and subsequent relief had to be afforded by relaxation of the conditions of the agreement to purchase. Eventually land boards were created to allot selections to applicants at low rates and deferred purchase. Perpetual leases are now taking the place of absolute alienation. The tenure is equally good for all purposes of the bona-fide settler, and capital which would otherwise be sunk in acquiring the freehold is set free for making improvements, purchasing machinery and the manifold requirements of efficient husbandry. Small blocks of 20 acres, or not exceeding £100 of unimproved value, can be obtained by working men in the vicinity of towns, thus on the one hand affording the necessary supply of agricultural labour during the busy seasons, and on the other hand providing a homestead which the holder can with advantage cultivate at slack times when unemployed. Provision was made, under the Closer Settlement Act of 1897, for the repurchase of large estates for agricultural purposes; these lands are leased to farmers at an average rent of about 4½% on the value. The industry of wheat-growing has received an impetus through the system of drilling in a small quantity of phosphatic manure with the seed. By this means exhausted lands have been restored almost to primitive fertility. Vine-growing has now become one of the staple industries, and, owing to stringent precautions, the state remains free from the scourge of phylloxera. The great bulk of

Agriculture and Water. the unalienated land of South Australia is held in huge areas by Crown tenants, known as squatters, under pastoral leases, which now have a currency of 42 years, with security of tenure. In 1893, when the unemployed were very numerous, the government established co-operative village settlements on tracts of land adjoining the river Murray. Seven of these are now in existence as irrigation colonies. The water is raised from the river by rotary pumps, and distributed by means of channels, after the plan adopted at Renmark. By the application of water to the adjacent sun-steeped soil miles of worthless mallee scrub have been converted into vistas of vineyards, orange groves and orchards. The paramount importance of water-supply and conservation has received ever-increasing recognition. The Beetaloo reservoir has a capacity of 800,000,000 gallons, and from its 695 m. of trunk mains a district of over 1,000,000 acres is reticulated. The supply of Adelaide and its vicinity has been reinforced by a reservoir at Happy Valley, having a contour of about 7½ m. at high-water mark, and containing 2,950,000,000 gallons. The reservoir was formed by the construction of an earthen embankment 2645 ft. long and 72 ft. high; this is filled from the Onkaparinga river through half a mile of steel main, 6 ft. in diameter, and 3½ m. of tunnel. Works on a large scale have also been constructed at Bundaleer and Barossa. The custom for many years past has been to construct these and other great public works departmentally instead of by contract. Many artesian wells have been sunk on the routes for travelling stock in the interior. The bores of some of these exceed 3000 ft. in depth, and the supply varies from 200,000 to 1,000,000 gallons a day. Around some of these wells in the far north plantations of date-palms have yielded excellent results.

South Australia was founded when the tide of the *laissez-faire* régime was running high, and a patriotic bias in the customs tariff was regarded as an unwarrantable restriction; it is therefore not surprising that free trade should at the outset have received many adherents. There were not wanting, however, some who saw clearly that a country almost entirely occupied in primary production would prove but a barren field for the cultivation of the many-sided activity necessary to a complete national life. It was also maintained that if inducements were given to capital to embark in home industries, a cheapening of the product, due to approximation of supply and demand, would ensue. In accordance with these views, a protective tariff was adopted in 1885. Two years later the duties were increased and extended. The establishment of manufactures

and new industries opened a career for youths of inventive and mechanical aptitude, and in several instances the predicted reduction in price of the protected article has been strikingly manifested.

One of the most notable developments in public policy consisted in the extension of the sphere of the state so as to embrace activities formerly considered to be solely within the province of private enterprise. Railways from the outset have been government undertakings, so also have been waterworks of any degree of magnitude; telegraphs and telephones, taken over by the Commonwealth, have always been regarded as state monopolies. A public trustee undertakes, when desired, the administration of estates. In 1895 a state bank was established to provide farmers with the necessary working capital at lowest current rates of interest. A state produce dépôt was also organized at the same time to assist farmers in placing their produce to the best advantage on the world's markets. Produce is received by the department of agriculture, prepared for shipment, certified as to quality, and graded. Small parcels from a number of producers are grouped together in one consignment and shipped at the lowest rates. The government of South Australia also undertakes, if so desired, to act as agent in London for the consignor, and to arrange for the sale of his produce; so that a farmer who has no representative at the port of destination, but is desirous of ascertaining whether a profitable trade can be established in any class of produce, has only to send the goods to the dépôt, and await the arrival of a cheque when the sales accounts come to hand. An advance amounting to three-fifths of the value of the produce at 5% is made if desired. Wine shipped through the produce dépôt is analysed and examined in bulk by government experts, and if found to be both sound and pure is sent to the bonded dépôt in London with a certificate to that effect: this is recorded on the label of the bottles in which it is retailed, under the name of the "Orion" brand. Cyanide works have been erected in various centres for treating ore raised by miners working in the neighbourhood. State smelters for copper ore have been built at Port Augusta, but are not now in operation. There is a Factory Act permitting the establishment of wages boards, and also legislation providing for a weekly half-holiday and the early closing of shops. A compulsory Conciliation Act deals with the prevention and settlement of industrial disputes. The Right Hon. C. C. Kingston was the pioneer in Australasia of legislation of this description. These measures were at first denounced by some as Socialistic, and were regarded by many as an undue interference with private enterprise. Some of the state aids were, however, speedily recognized as affording additional incentives to industry, and by enabling producers and workers to obtain a better return for their labour may fairly be held to have assisted rather than to have retarded private enterprise. In 1893 a bonus on butter exported to the world's markets was successful in bringing into existence a fully equipped export trade. Public opinion in South Australia has little tolerance with laxity. Children are prevented from selling articles in the streets after 8 p.m., and are not allowed to fetch beer from public-houses. The age of consent has been raised to 17 years. The notification by medical men of cases of pulmonary tuberculosis to the local authorities is compulsory.

No pains have been spared to keep pace with modern improvements in popular education as an indispensable feature in democracy. South Australia holds in reverent and loving memory the name of John Anderson Hartley, the originator of the state school system, who died in 1896, and to whose character as a man and genius as an organizer the schools of South Australia will remain as a perennial monument. School fees for children under the compulsory age of 13 were abolished in 1891, and in 1898 the older children were also admitted free. Students in training have now the advantage of a two-years' course at the university. Technical education has received much attention. A foundation was long ago laid in the primary schools by the inclusion of drawing as a compulsory subject, and by affording facilities for manual training. In 1889 the South Australian School of Mines and Industries was established, and under the presidency of Sir Langdon Bonython proved a most valuable institution. Other technical schools are in operation in industrial and mining centres. A reserve of 2 acres is attached to all new country schools, and systematic lessons in practical agriculture are given by many teachers. In order to encourage tree-planting, a yearly school holiday devoted to this purpose, and known as Arbor Day, was established in 1886. With a similar object the state has distributed, free of charge, 5,000,000 forest trees to 21,000 persons. Over 1,250,000 vines have also been given away. The boys' field club (1887), with the motto "The Naturalist loves Life," under the direction of Mr W. C. Grasby, was one of the pioneers of Nature-study. A state secondary school for girls has been for many years self-supporting, and in 1897 secondary agricultural schools for boys were organized in Adelaide and other centres. Half the school hours of each day are spent in the class-room, the remainder being devoted to workshop, field and laboratory practice. An agricultural college at Roseworthy, 25 m. north of Adelaide, imparts a high-class theoretical and practical training in the various branches of agriculture, including viticulture and wine-making. The fee charged is £30 a year, including board and lodging. Information

as to practical and scientific husbandry is disseminated among the farmers by means of an agricultural bureau, with numerous branches throughout the country. A journal is published conjointly by the departments of agriculture and industry, containing reports of the proceedings of the bureaus and articles by government experts, together with industrial topics and matters of interest to artisans, and also particulars furnished by the labour bureau as to prospects of employment in various districts. (J. A. Co.)

SOUTH BEND, a city and the county-seat of St Joseph county, Indiana, U.S.A., at the head of navigation and on the southern bend (hence the name) of the St Joseph river of Michigan, and (by rail) 86 m. E. by S. of Chicago. Pop. (1900), 35,999, of whom 8601 were foreign-born (including 3053 Poles and 2402 Germans); (1910, census), 53,684. Land area (1906), 6.2 sq. m. It is served by the Grand Trunk, the Lake Shore & Michigan Southern, the Michigan Central, the New Jersey Indiana & Illinois, the Chicago, Indiana & Southern, and the Vandalia railways, and by four inter-urban electric lines. Among the principal buildings are the city-hall, the county court-house, the public library, and the Oliver Hotel. In Notre Dame, a suburb, are St Mary's College and Academy (Roman Catholic, chartered 1855) for girls, and the university of Notre Dame du Lac (Roman Catholic, first opened in 1842, and chartered in 1844). In 1910 the university had 87 instructors, 1005 students, and a library of 60,000 volumes. It is the headquarters of the order of the Holy Cross, whose sisters have charge of St Mary's College and Academy. South Bend ranked fourth among the manufacturing cities of the state in 1905. Its industrial establishments include carriage and wagon works (those of the Studebaker Bros. Manufacturing Company being the largest in the world), plough and agricultural machine works—the Oliver Chilled Plow Works, founded by James Oliver (1823–1909), being particularly well known—the wood-working department of the Singer Sewing Machine Company, iron and steel foundries, flour-mills, and paper and pulp mills. The water-supply is obtained from 122 artesian wells, with a daily capacity of about 24,000,000 gallons. South Bend was the site of an Indian village and of a French trading post. It was settled about 1820, laid out about 1831 (when it became the county-seat of St Joseph county), incorporated as a village in 1835, and chartered as a city in 1865.

SOUTH BETHLEHEM, a borough of Northampton county, Pennsylvania, U.S.A., on the Lehigh river, about 57 m. N.W. of Philadelphia, and opposite Bethlehem, with which it is connected by bridges. Pop. (1900), 13,241, of whom 3322 were foreign-born and 115 were negroes; (1910 census), 19,973. It is served by the Lehigh Valley, the Philadelphia & Reading, the Central of New Jersey and the Lehigh & New England railways. The borough is the seat of Lehigh University. This institution was founded in 1865 by Asa Packer, who then gave \$500,000 and 60 acres (afterwards increased to 115 acres) of land in the borough, and by his will left to the university library \$500,000, and to the university an endowment of \$1,500,000 and a large interest (about one-third) in his estate. The university was chartered in 1866; it embraces a school of technology, with courses in civil, mechanical, metallurgical, mining, electrical and chemical engineering, electrometallurgy and chemistry, and a school of general literature (1878), with classical and Latin-scientific courses. In 1908–1909 it had 68 instructors, 1720 students, and a library of 127,000 volumes. The principal buildings of the university are Packer Hall (1869), largely taken up by the department of civil engineering, the chemical and metallurgical laboratory, the physical and electrical engineering laboratory, the steam engineering laboratory, Williams Hall for mechanical engineering, &c., Saucon Hall for the English department, Christmas Hall, with drawing-rooms and the offices of the Y.M.C.A., the Sayre astronomical observatory, the Packer Memorial Church, the university library (1897), dormitories (1907) given by Andrew Carnegie, Drown Memorial Hall, a students' club, the college commons, and a gymnasium.

South Bethlehem is the see of a Protestant Episcopal bishop. The Bethlehem Steel Company manufactures here iron and steel, including Bessemer steels, armour plate, steel rails,

government ordnance, drop forgings, iron and steel castings, stationary engines, gas engines, hydraulic pumps, projectiles, steel shaft and pig iron; zinc is smelted and refined; and there are large hosiery and knitting mills, and silk mills and cigar factories. The total value of the borough's factory products increased from \$9,964,054 in 1900 to \$15,275,411 in 1905, or 53.3%.

In 1846 a water-cure was established where St Luke's hospital now stands, in the adjoining borough of Fountain Hill (pop. in 1900, 1214), and for a few years this attracted a considerable number of visitors during the summer season. In 1853 works were established for the manufacture of white oxide of zinc from a calamine found here, in the next year metallic zinc was produced, and in 1865 the first sheet zinc made in America was rolled here. The borough was incorporated in 1865.

SOUTHBRIDGE, a township of Worcester county, Massachusetts, U.S.A., on the Quinabaug river (which here falls 165 ft.), about 20 m. S.S.W. of Worcester. Pop. (1900), 10,025, of whom 3468 were foreign-born; (1910 census), 12,592. Area, about 20 sq. m. The township is served by the New York, New Haven & Hartford railway, and by inter-urban (electric) lines to Worcester and Springfield. The Southbridge public library (1870) contained 22,000 volumes in 1910. Optical goods, cotton, woollen and print goods, cutlery and shuttles are the principal manufactures; in 1905 the value of the total factory product was \$4,201,853. The factory of the American Optical Company here is probably the largest of its kind in the world.

In 1801 a poll parish, named the Second Religious Society of Charlton, and popularly called Honest Town, was formed from the west part of Dudley, the south-west part of Charlton and the south-east part of Sturbridge; and in 1816 this parish became the township of Southbridge.

See the *Leaflets* published (1901 sqq.) by the Quinabaug Historical Society of Southbridge.

SOUTH CAROLINA, a South Atlantic state of the United States of America, and one of the original thirteen, lying between latitudes 32° 2' and 35° 17' N. and between longitudes 78° 30' and 83° 20' W. It is bounded N. by North Carolina, E. by North Carolina and the Atlantic Ocean, S.E. by the Atlantic Ocean, S.W. and W. by the Savannah, Tugaloo and Chattooga rivers, which separate it from Georgia. Its total area is 30,989 sq. m., and of this 494 sq. m. are water surface.

Surface Features.—South Carolina is mainly in the Coastal Plain and Piedmont Plateau regions, but in the north-west it extends slightly into the Appalachian Mountain region. Locally the Coastal Plain region is known as the low country, and the Piedmont Plateau and Appalachian Mountain regions are known as the up-country. The coast, about 200 m. in length, is generally low. For 60 m. south-west of the North Carolina border it is unbroken and lined with a smooth, hard beach of light-coloured sand, but below this it becomes increasingly broken by estuaries and is lined with flat and low sea-islands that increase in size and number toward the Georgia border. For about 10 m. back from the coast the Coastal Plain region is occupied very largely by salt marshes. Then, although still continuing flat, the surface rises at the rate of about 2½ ft. per mile for 40 m. or more; beyond this it rises more rapidly, reaches a maximum elevation in Lexington county of about 700 ft. above the sea, and becomes increasingly broken into rolling plateaus and deep valleys to the Fall Line, which marks the boundary between the Coastal Plain and the Piedmont Plateau. This line, at which the south-east flowing rivers fall from higher levels in the crystalline rocks of the Piedmont Plateau down to somewhat lower levels in the softer rocks of the Coastal Plain, passes in a general south-west direction from the North Carolina border north-east of Cheraw through Camden and Columbia to the Savannah river opposite Augusta, Georgia. The Piedmont Plateau region, rising gradually from an elevation of about 500 ft. along the Fall Line to 1000 ft. or more in the north-west, is a plateau broken into undulating ridges and deeply cut valleys. In the small section of South Carolina which is traversed by the Appalachian Mountain region a few mountains of the Blue Ridge rise abruptly from the foot-hills to 3413 ft. in Mt Pinnacle, 3218 ft. in Caesars Head, and 3157 ft. in Table Rock. The highest point in the state is Sassafras Mountain (3548 ft.) in the Blue Ridge and on the North Carolina state line. The mean elevation of the entire state is about 350 ft. The principal rivers rise in the Appalachian Mountains

and flow south-east into the Atlantic Ocean. In the middle section the Santee river is formed by the confluence of the Wateree, which is known in North Carolina as the Catawba, and the Congaree, which is in turn formed by the Broad and the Saluda, and the basin of this system embraces about one-half the area of the state. In the north-east the Great Pedee and its tributaries—the Little Pedee, Waccamaw and Lynch—were wholly within the Coastal Plain, but the main stream is a continuation below the Fall Line of the Yadkin river, which rises in the mountains of North Carolina. On the Georgia border the Chattooga river, rising in the Blue Ridge, becomes tributary to the Tugaloo, which in turn becomes tributary to the Savannah. The Combahee and the Edisto, in the south-east, and the Black, north of the Santee, are the principal rivers that rise within the Coastal Plain and flow direct to the ocean. In the Piedmont Plateau region the current of the rivers is usually swift, and not infrequently there are falls or rapids; but in the Coastal Plain region the current becomes sluggish, and in times of high water the rivers spread over wide areas.

Fauna.—The principal animals and birds in South Carolina are deer, rabbits, squirrels, opossums, musk-rats, raccoons, minks, geese, ducks, wild turkeys, "partridge" (quail or bobwhite), woodcock and snipe. Foxes, bears, wolves, lynx (wild cats) and otters are very rare, and pumas (panthers) and beavers long ago disappeared. Common among birds of prey are owls, hawks and kites, and there are many turkey buzzards. Song birds are numerous and of many varieties; among them are thrushes, mocking birds, blue birds, robins, wrens, chickadees, warblers, vireos, sparrows, bobolinks (reed birds or rice birds), meadow larks and orioles. In the bays and lower courses of the rivers are porpoises, whiting, sea bass, channel bass, shad, sturgeon, mullet, drum, bluefish, snappers, sheepshead, weakfish or squeteague, groupers, and several other kinds of fish. Oysters, crabs, shrimp and terrapins are also abundant here, and in the inland streams are some pike, perch, trout and catfish.

Flora.—From the number of palmettoes along the coast South Carolina has become popularly known as the Palmetto state. Scarcely less conspicuous for some distance from the ocean are the magnolias, the live oaks draped with long gray moss, and the reed-covered marshes. In the swamps there are cypresses and some gum and bay trees. In most of the uplands of the Coastal Plain region the long-leaf pine is predominant, but large water-oaks and undergrowths of several other oaks and of hickories are not uncommon. On the Piedmont Plateau and in some of the more hilly and heavy-soil sections below the Fall Line there is some short-leaf pine, but most of the trees in these sections are of the hardwood varieties: deciduous oaks are most common, but beech, birch, ash, maple, black walnut, chestnut, sycamore and tulip trees also abound. On the mountains are the cucumber tree, laurel, white pine and hemlock. Among indigenous trees, shrubs and vines that bear edible fruits or nuts the state has the blackberry, grape, pawpaw, persimmon, plum, crabapple, hickory, chestnut and hazel nut. The English walnut, pecan, apple, apricot, pear and cherry are also cultivated. Both medicinal and flowering plants are exceptionally abundant; a few of the former are ginseng, snakeroot, bloodroot, horehound, thoroughwort, redroot (*Ceanothus Americanus*), horse mint and wild flax, and prominent among the latter are jessamines, azaleas, lilies, roses, violets, honey-suckle and golden-rod. Venus's flytrap is found along the coast.

Climate.—Along the coast the climate is comparatively mild and equable. At Charleston, for example, the mean winter temperature is 51° F., the mean summer temperature 81° F., the mean annual temperature 66° F., and the range of extremes from 104° F. to 7° F. or 97° F. Toward the north-west the mean winter temperature decreases to 47° F. at Columbia and to 40° F. at Greenville; the mean summer temperature decreases only to 80° F. as far as Columbia, but from there to Greenville decreases to 75° F.; and the mean annual temperature decreases to 62° F., at Columbia and to 58° F. at Greenville. The range of extremes increases to 108° F. (106° to -2°) at Columbia, and then decreases to 102° F. (97° to -5°) at Greenville. The greatest range of extremes in the state is from 11° F. at Santuck, Union county, in February 1899, to 106° F. at Columbia in August 1900. For the whole state the mean annual temperature is about 63° F., the mean summer temperature 79° F., and the mean winter temperature 44° F. In nearly all sections January is the coldest month and July the warmest. The mean annual rainfall for the state is about 49 in., and its distribution is excellent. Extremes for the various sections range only from 53.4 in. at Charleston to 44.4 in. at Stateburg, in Sumter county. Seventeen inches, or more than one-third, falls during the summer, and for the other seasons the range is only from 10.1 in. for autumn to 11.6 in. for winter. Snow is uncommon in the south-east of the state, and whenever there is a snow-storm the snow usually melts as it falls; but in the centre and north-west occasionally covers the ground to a depth of several inches. The prevailing winds are from the south-west along the coast, from the north-east in the north-central section, and from the west in the west section. Tornado winds sometimes occur in the west section, and the east section occasionally suffers from West Indian hurricanes.

Soils.—In general the soils of the Piedmont Plateau region

are such as have been formed by the disintegration of the underlying rocks. These consist mostly of granite and gneiss, but in the north-central section there is trap-rock, and in the south-east section some slate. On the more level areas of the Piedmont Plateau the granitic soil is a grey mixture of sand and clay, but on the hillsides of the river basins it is a heavy clay of reddish colour, the sand having been washed down to form the soils of the Coastal Plain. In all sections of the Piedmont Plateau the subsoil is a reddish or yellowish clay. In the upper section of the Coastal Plain region the soil is for the most part a loose sand, but lower down it becomes finer, more tenacious, and consequently more fertile.

Agriculture.—The number of farms in South Carolina was 93,864 in 1880, 115,008 in 1890 and 154,166 in 1900—the number for the two last named years not including farms of less than 3 acres and of relatively small productivity. The total acreage in farms in 1880 was 13,457,613 acres, of which 4132 acres were improved; in 1890, 13,184,652 acres, of which 5,255,237 acres were improved; and in 1900, 13,985,014 acres, of which 5,755,741 acres were improved. The total value of farm property, with improvements, machinery and livestock, was \$84,079,702 in 1880; \$119,849,272 (average value per farm, \$1042) in 1890; and \$153,591,159 (average value, \$989) in 1900; while the average value per acre of farm-land increased from \$9.09 in 1890, to \$10.98 in 1900. Of farms of 1000 acres and more there were 1635 in 1880 and 1010 in 1900; of between 500 acres and 1000 acres there were 3693 in 1880 and 2314 in 1900; of 50 acres and less than 100 acres there were 13,612 in 1880 and 29,944 in 1900; of 20 acres and less than 50 acres there were 3688 in 1880 and 5261 in 1900. Farms worked by owners numbered 46,645 in 1880 and 60,471 in 1900; by cash tenants, 21,974 in 1880 and 57,046 in 1900; by share tenants, 25,245 in 1880 and 37,838 in 1900. Of the 155,355 farms in the state in 1900, 85,381 were worked by negroes of whom 22.2% were owners of their farms, 49.7% cash tenants and 27.9% share tenants.

The state long out-ranked all other states in the growing of rice, but this industry has declined, and South Carolina is now surpassed by both Louisiana and Texas. Cotton is the state's most valuable crop. The cotton product of the state in 1889 was 747,190 bales, in 1899 it was 881,422 bales, and in 1909, 1,095,000 bales. The principal cereals, with the amounts and values of the crops in 1899 and 1909 are: Indian corn, 17,429,610 bush. (\$9,149,808) in 1899 and 37,041,000 bush. (\$33,337,000) in 1909; wheat, 1,017,319 bush. (\$958,158) in 1899 and 3,810,000 bush. (\$5,563,000) in 1909. Oats, 2,661,670 bush. (\$1,226,575) in 1899 and 4,431,000 bush. (\$3,190,000) in 1909. Rice, 47,360,128 lb (\$1,366,528) in 1899, on 23,726 farms, nearly half of the total number (48,155) of rice farms in the United States, which, however, decreased to 476,000 bush. (\$433,000) in 1909. The rye crop was 19,372 bush. (\$18,405) in 1899, and 39,000 bush. (\$55,000) in 1909. Other important crops are: tobacco 19,895,970 lb (\$1,297,293) in 1899, and 32,000,000 lb (\$2,336,000) in 1909; hay and forage, 213,249 tons (\$2,304,734) in 1899, and of hay alone 81,000 tons (\$1,256,000) in 1909; potatoes, 3,369,957 bush. (\$1,538,205) in 1899 and 765,000 bush. (\$880,000) in 1909.

Mining.—The value of the mineral product of the state was \$1,834,134 in 1902, \$2,305,203 in 1907 and \$2,081,001 in 1908. The total value of the products of manufacturing industries based on mining was \$18,565,682 in 1900, or 17.2% of the total value of the product of all manufacturing industries. The most valuable single mineral is phosphate rock, which is found in a belt 70 m. long by 30 m. wide, extending from the mouth of the Broad river near Port Royal in the south-east to the headwaters of the Wando river in the north-east. The chief deposits are found in Berkeley, Dorchester, Charleston, Colleton and Beaufort counties, at the bottom of rivers, 20 to 30 ft. in depth, and on land at an elevation but little above mean tide. Its commercial value for the manufacture of fertilizer was established in 1867, and the mining of it began soon afterwards in the Ashley River region. The amount mined in 1868 was 12,262 long tons; in 1902, 313,365 long tons; and in 1908, 225,495 long tons, valued at \$989,881. The value of other minerals produced in 1908 was as follows: Granite, \$297,874; clay, \$110,636; and monazite, \$13,494. The product and value of mineral waters was 786,754 gals. (\$195,182) in 1907 and 271,572 gals. (\$70,937) in 1908. Minerals which were not mined commercially in 1902 include asbestos, which occurs in Spartanburg and Pickens counties; fullers'-earth; graphite in Spartanburg and Greenville counties; iron ores in the north and north-west portions of the state; iron pyrites in Spartanburg and York counties; talc, bismuth, ochre, pyrites, galena, brown coal, malachite, phosphate of lead and barytes.

Manufactures.—The number of factories in South Carolina in 1900 was 1369, in 1905, 1399¹; the amount of capital invested in such establishments was \$62,750,027 in 1900, and in 1905 \$113,422,224; the value of products in 1900 was \$53,335,811; in 1905, \$79,376,262; and the average number of wage earners in

¹The special census of 1905 was confined to manufactures under the factory system, and the statistics above for 1900 have been reduced to the same standard to make them comparable with the statistics for 1905.

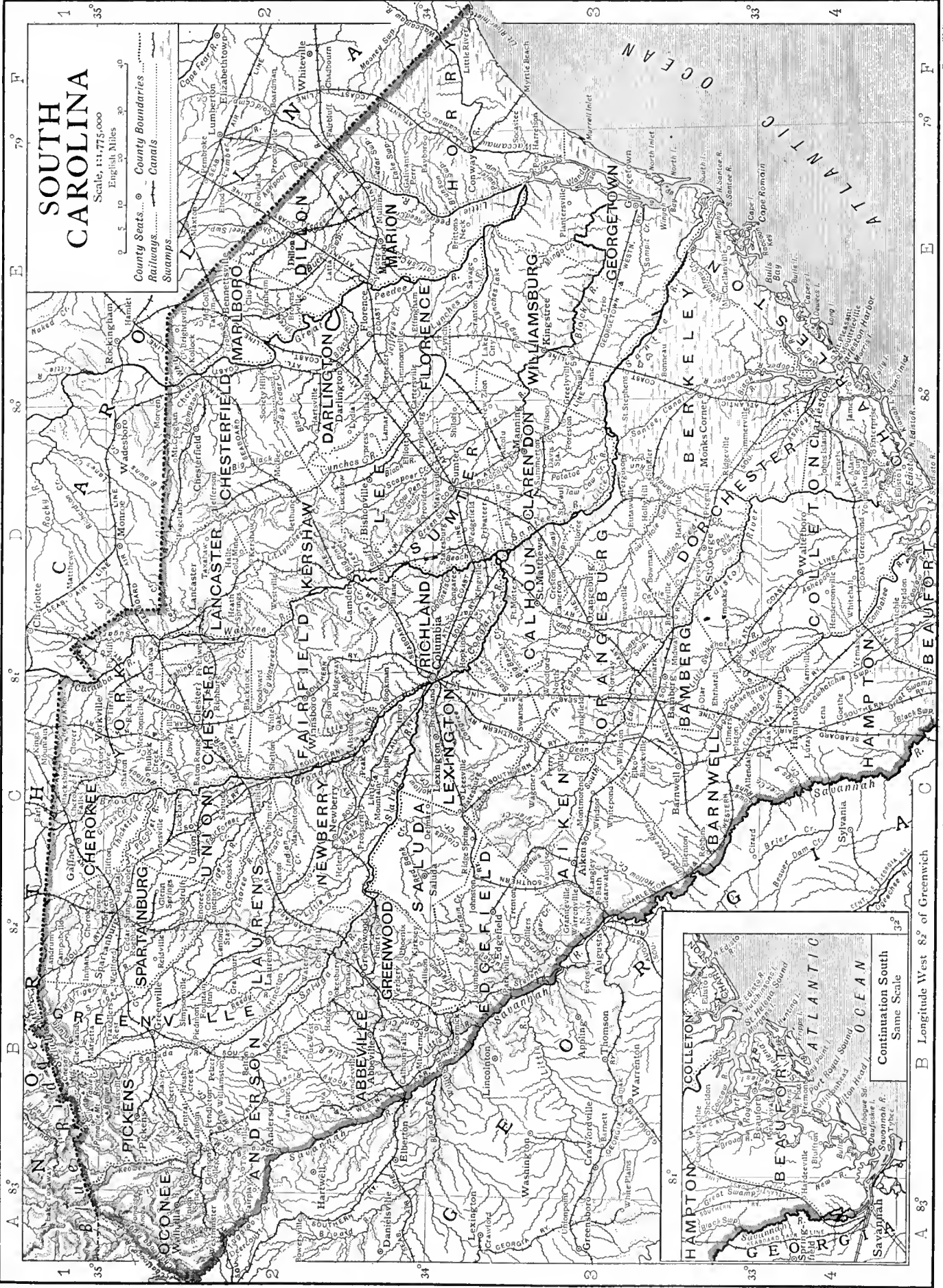

SOUTH CAROLINA

Scale, 1:1,775,000
English Miles

County Seats...
 County Boundaries...
 Railways...
 Canals...
 Swamps...

Continuation South
Same Scale

A 83° 30' E 79° 30' F
 B Longitude West 82° of Greenwich
 C
 D
 E
 F
 G
 H
 I
 J
 K
 L
 M
 N
 O
 P
 Q
 R
 S
 T
 U
 V
 W
 X
 Y
 Z
 1
 2
 3
 4
 33°
 34°
 35°
 ATLANTIC OCEAN
 SAVANNAH R.
 GEORGIA
 HAMPTON
 COLLETON
 BEAUFORT
 HAMPTON
 SAVANNAH

1900, 47,025, and in 1905, 59,441. Except in number, the rural establishments showed greater increases than the urban.¹ The number of rural establishments in 1900 was 1174; in 1905, 1179; and the number of urban establishments in 1900, 195; in 1905, 220; but the capitalization of the rural establishments increased from \$50,057,922 in 1900 to \$97,942,185 in 1905; while that of the urban increased from \$12,692,105 to \$15,480,039; the value of the products of the rural establishments increased from \$41,930,816 to \$64,887,748; while that of the urban establishments increased from \$11,404,995 to \$14,488,514; and the number of employes in rural establishments increased from 36,616 to 50,744, while those in urban establishments increased from 7409 to 8697. More than half of the manufacturing establishments were engaged in the manufacture of cotton goods, of lumber and timber, of fertilizers, of cotton-seed oil and cake, of lumber and planing-mill products, of cars and general shop construction, and of hosiery and knit goods.

The manufacture of cotton goods was much the most important industry in 1900 and 1905, and showed a remarkable growth. The capital invested in this industry was \$39,258,946 in 1900 and \$82,337,429 in 1905; the value of the products was \$29,723,919 in 1900 and \$49,437,644 in 1905; the average number of wage-earners was 30,201 in 1900 and 37,271 in 1905; and the amount of wages, \$5,066,840 in 1900 and \$7,701,689 in 1905. The number of establishments in 1900 was 80, and in 1905, 127; the number of producing spindles in 1900 was 1,431,349, and in 1905, 2,864,092; and the number of looms in 1900, 42,663, and in 1905, 72,702. The use of domestic cotton increased from 485,024 bales in 1900 to 555,467 bales in 1905, and the amount paid for this cotton increased from \$14,909,520 to \$30,451,159. In the same period the amount of foreign cotton used increased from 210 bales in 1900 to 2633 bales in 1905, and the amount paid for it from \$20,026 in 1900 to \$318,020 in 1905. The principal product of the mills was plain cloths for printing or converting, of a quality finer than No. 28 warp, of which there were produced 322,850,981 sq. yds., valued at \$14,007,496 in 1905, as compared with 97,343,526 sq. yds., valued at \$3,171,198 in 1900. Other products and their values in 1900 and 1905 were as follows: brown or bleached sheetings and shirtings, 283,105,383 sq. yds. (\$11,553,073) in 1900 and 248,777,474 sq. yds. (\$12,035,854) in 1905; yarns for sale, 24,859,616 lb (\$3,461,090) in 1900 and 31,645,397 lb (\$6,217,795) in 1905; drills, 116,467,224 sq. yds. (\$5,375,017) in 1900 and 88,551,799 sq. yds. (\$5,344,146) in 1905; twills and sateens, 11,379,712 sq. yds. (\$485,484) in 1900 and 45,220,488 sq. yds. (\$2,175,651) in 1905.

The value of the products of other industries in 1900 and 1905 were as follows: Lumber and timber, \$4,942,362 in 1900 and \$6,791,451 in 1905; cotton-seed oil and cake, \$3,103,425 in 1900 and \$5,462,818 in 1905; fertilizers, \$4,882,506 in 1900 and \$3,637,576 in 1905; lumber and planing-mill products, including sash, doors and blinds, \$1,016,328 in 1900 and \$1,478,581 in 1905; hosiery and knit goods, \$392,237 in 1900 and \$1,078,682 in 1905; cars and general shop construction and repairs by steam railway companies, \$691,361 in 1900 and \$1,080,990 in 1905.

Forests.—The principal lumber resource of South Carolina is yellow (or "southern") pine, and there is also a small quantity of cypress. The stand of yellow pine in the state in 1880 was estimated at 5316 million ft.; and in 1905 it was estimated at 3363 million ft. The value of the lumber product increased from \$1,108,880 in 1850 to \$5,207,184 in 1900. Some use is also made of the forest resources of the state in the manufacture of veneer, paper pulp, turpentine and other chemicals.

Fisheries.—The total yield of the state's fisheries in 1902 was 8,174,463 lb, valued to the fishermen at \$263,023, which is an increase over that of 1897 of 2,894,017 lb and of \$52,567 in value. The number of persons employed in 1902 was 3713, an increase over 1897 of 1574; the amount of capital invested in 1902 was \$320,723, an increase over 1897 of \$146,369. The oyster fishery represented in 1902 about 45% of the entire value of the state's fisheries, the catch in that year being 689,700 bush., valued at \$118,460, an increase over 1897 of 474,800 bush. and \$73,100. The amount and value of other catches in 1902 were as follows: whiting, 606,300 lb (\$30,118); sea bass, 709,545 lb (\$27,364); shad, 434,133 lb (\$20,782); clam, 28,133 bush. (\$12,940); shrimp, 306,500 lb (\$12,452); terrapin, 27,521 lb (\$5,580); mullet, 138,000 lb (\$3782); jessfish, 79,500 lb (\$3738); channel bass, 102,000 lb (\$3550); squeteague, 85,700 lb (\$3059); shark, 90,000 lb (\$1800). Other fish taken include the sheepshead, drum, grouper, striped bass and croaker.

Transportation.—The chief railway systems of South Carolina are the Southern, the Seaboard Air line and the Atlantic Coast line. The railway mileage of the state was 3335.48 m. on the 1st of January 1909. Inland water communication is furnished by several navigable rivers. Between 1816 and 1826 the state expended upon internal improvements \$1,712,626, a large part of which was appropriated for building canals round the rapids of five rivers;

between 1878 and 1900 the United States government expended \$6,063,692 upon seven rivers and three harbours. The Savannah River is navigable from Savannah to Augusta, Georgia (202 m.), where its mean low water depth is 3 ft., and from Augusta to Petersburg, Georgia, for flatboats. Other navigable streams are the Waccamaw, to Bucksville (50 m.); the Great Pedee to Smith's Mills (52 m.); the Cooper, to Strawberry Ferry (30 m.); the Ashley, to Lambs (13 m.); the Edisto, to Guignard Landing (260 m.); the South Edisto, to the North Edisto (11 m.); the Beaufort, to the Coosaw River (11 m.); and the Santee, to the confluence of the Congaree and Wateree rivers, which are navigable for flatboats. The ports of entry are Charleston, Beaufort and Georgetown.

Population.—The population in 1880 was 995,577; in 1890, 1,151,149; in 1900, 1,340,316; and in 1910, 1,515,400.² In only one other state, Mississippi, in 1900 the negroes exceeded the whites; in South Carolina 58.4% of the total, or 782,321, were negroes or of negro descent, and 41.6% were whites; but there was a slight falling-off in the percentage of negroes, this having been 59.9% in 1890. Of the total population, 99.6% were native-born. There were, in 1900, 552,436 native whites; 5,528 persons of foreign birth, 121 Indians and 67 Chinese. Of the inhabitants born in the United States, 29,521 were natives of North Carolina, and 13,544 were natives of Georgia, and of the foreign-born 2075 were Germans, and 1131 were natives of Ireland. Of the total population, 17,628 were of foreign parentage—*i.e.* either one or both parents were foreign-born—and 2503 were of German and 1607 of Irish parentage on both the father's and the mother's side. In 1906 there were in the state 655,933 members of different religious denominations, of whom the Baptist bodies were the strongest with 341,456 communicants; the Methodist bodies had 249,169 members; 35,533 were Presbyterians; 12,652 were Lutherans; 10,317 were Roman Catholics; and 8557 were Protestant Episcopalians. From 1890 to 1900 the urban population (*i.e.* in places with 4000 inhabitants) increased from 84,459 to 157,111; the semi-urban population (*i.e.* population of incorporated places), or the approximate equivalent, having less than 4000 inhabitants) increased from 93,551 to 104,352; while the rural population (*i.e.* population outside of incorporated places) increased from 973,139 to 1,078,853. The principal cities are Charleston, Columbia (the capital), Spartanburg, Greenville, Sumter, Anderson and Rock Hill.

Administration.—South Carolina was governed from 1670 to 1719 under the Carolina provincial charter of 1665, from 1719 to 1776 under commissions and instructions from the Crown, and after 1776 under the constitutions of 1776, 1778, 1790, 1865, 1868 and 1895. An amendment to the constitution may be proposed by either house of the legislature; if it is approved by two-thirds of the members elected to each it must then be submitted to the people to be voted on at the next general election for members of the state house of representatives, and if it receives a favourable vote of a majority and subsequently a majority vote in each house of the next general assembly it becomes part of the constitution. A constitutional convention to revise the constitution may be called by a two-thirds vote in each house, subsequently ratified by a majority vote of the electors of the state.

Effective protection against a possible restoration of negro rule seems to have been aimed at in the suffrage provisions of the new constitution. Two plans of registration were provided, one temporary, the other permanent. Up to the 1st of January 1898 all persons otherwise qualified could register, provided they could read any section of the constitution or understand and explain it when read to them by the registration officer, and all persons so registered were qualified voters for life. The obvious intention was to disfranchise illiterate negroes, but not illiterate whites. Under the permanent plan, however, this distinction will gradually disappear. Those who should apply for registration after the 1st of January 1898 must be able to read and write any section of the constitution submitted to them by the registration officer, or must show that they have paid all taxes for the previous year on property worth \$300 or more. Other requirements for voters

¹ In this class are included the manufactures of only four cities, Charleston, Columbia, Greenville and Spartanburg, which in 1900 had populations of 8000 or more.

² According to previous censuses the population was as follows: 1790, 249,073; 1800, 345,591; 1810, 415,115; 1820, 502,741; 1830, 581,185; 1840, 594,398; 1850, 668,507; 1860, 703,708; 1870, 705,606.

are: residence in the state for two years (except that ministers in charge of organized churches and teachers of public schools need have a residence in the state of six months only), in the county for one year, and in the polling precinct for four months, and the payment six months before election-time of a poll-tax. Idiots, insane persons, paupers, convicts and persons convicted of certain crimes (enumerated in the constitution) and not pardoned by the governor are disqualified from registering or voting.

Under the constitution of 1895 the governor holds office for two years and is eligible for re-election. The governor and the lieutenant-governor must be thirty years old and must have been citizens of the United States and citizens and residents of the state for five years. The governor has a veto power, extending to the separate items in appropriation bills, which may be overcome by a two-thirds majority in each house of the General Assembly; three days (excluding Sunday) are allowed to the governor for vetoing bills or joint resolutions passed by the General Assembly, or only two days if the General Assembly adjourn before three days have elapsed. The lieutenant-governor is the presiding officer of the senate, and succeeds the governor if the governor is removed from office by impeachment, death, resignation or otherwise. Other administrative officers of the state, each elected for two years, are a secretary of state, a comptroller-general, an attorney-general, a treasurer, an adjutant and inspector-general, and a superintendent of education.

The state legislature is officially styled the General Assembly, and is composed of a Senate and a House of Representatives. The House of Representatives is composed of 124 members elected every two years and apportioned among the counties according to population; the Senate of one member from each county, elected for a term of four years, the term of one-half of the senators ending every two years. Annual sessions of the General Assembly are held, beginning on the second Tuesday in January. In 1904 the legislature submitted an amendment providing for biennial sessions and it was ratified by a popular vote, but inasmuch as the constitution requires a subsequent ratification by the legislature, the question came up again in the session of 1905. Attention was then called to the fact that the new amendment would make other changes in the constitution necessary, and the matter was referred to a legal commission.

The judicial power is vested in a Supreme Court and two circuit courts, a court of common pleas having civil jurisdiction, and a court of general sessions having criminal jurisdiction. The supreme court consists of a chief justice and three associates, elected by a joint viva voce vote of the General Assembly for a term of eight years. In each of the eight circuits is a circuit judge elected in a similar manner for four years. The magistrates or justices of the peace are appointed by the governor—a wise provision, because under the constitution of 1868 negroes were frequently elected who could neither read nor write.

Local Government.—The unit of local government in South Carolina is the county, which, the state constitution provides, "shall be a body politic and corporate." The constitution also provides for the establishment of a new county, "whenever one-third of the qualified electors within the area of each section of an old county proposed to be cut off to form a new county shall petition the governor for the creation of a new county," whereupon the governor "shall order an election within a reasonable time thereafter," and if two-thirds of the voters vote "yes," the General Assembly at the next session shall establish the new county, provided that no section of a county shall be cut off without the consent of two-thirds of those voting in such section; that no new county "shall contain less than one one hundred and twenty-fourth part of the whole number of inhabitants of the state, nor shall it have less assessed taxable property than one and one-half millions of dollars, nor shall it contain an area of less than four hundred square miles"; and that "no old county shall be reduced to less area than five hundred square miles, to less assessed taxable property than two million dollars, nor to a smaller population than fifteen thousand inhabitants." The General Assembly may alter county lines at any time, provided the proposed change is sanctioned by two-thirds of the voters in the section proposed to be cut off. The General Assembly may also provide for the consolidation of two or more counties if a majority of the voters concerned approve, "but such election shall not be held oftener than once in four years in the same counties." Counties are divided into townships and

under the constitution each "shall constitute a body politic and corporate," but in 1910 there were no separate township governments, the existing division of counties into townships being for the purpose of convenience in adjusting taxes. Municipal government machinery is prescribed by a general state law which provides for the acquirement by municipalities of waterworks and lighting-plants, the levying and collection of taxes and the issuing of licences, and regulates bonded debts. Cities and towns are permitted to exempt, by ordinance, certain classes of manufactories from all taxes except for school purposes, provided such ordinances are ratified by a majority of the electors.

Miscellaneous Laws.—The elaborate precautions taken to prevent lynching are a peculiarity of the constitution of 1895. Any officer—state, county or municipal—who, through negligence or connivance, permits a prisoner to be seized and lynched, forfeits his office and becomes ineligible to hold any office of trust or profit in the state unless pardoned by the governor. The county in which the crime occurs is, without regard to the conduct of the officers, liable in damages of not less than \$2000 to the legal representative of the person lynched; the county is authorized, however, to recover this amount from the persons engaged in the lynching. A fourth unusual feature is that South Carolina has applied the principle of direct primary nominations to all elective officials from governor down. United States senators are in practice elected by the people, for the legislature merely registers the result of the primary. Since an absolute majority of the votes cast is required, it is often necessary to hold a second primary in which only the two leading candidates are considered (see act of the 22nd of December 1888, and *ex parte Sanders*, 53 S.C. 478). South Carolina is the only state in which divorce is not allowed in any circumstances; this is a constitutional provision. Divorces were not permitted before 1868 and the provisions of the constitution of that year and of an act of 1872, permitting divorce (for adultery or for wilful desertions for two years) were repealed in 1878. A married woman may hold, acquire and dispose of property as if she were single, and the descent of the estate of a husband dying intestate is the same as that of a wife dying intestate, the survivor being entitled to one-third of the estate if there are one or more children, and to one-half of the estate if there are no children or other lineal descendants. Tenancy by courtesy was abolished in 1883, but the right of dower still obtains; the widow's acceptance of a distributive share in her husband's estate, however, bars her dower. A homestead in lands to the value of \$1000, the products of the same, and personal property to the value of \$500 which belong to the head of a family or to the husband and wife jointly are exempt from attachment, levy or sale except for taxes, purchase money or debts contracted in making improvements or repairs. The exemption of the homestead continues for the benefit of the widow or for the children alone, whether minors or not, provided it is occupied by some of them, and it may be partitioned among the children regardless of debts. The number of hours' labour for operatives and employés in cotton and woollen mills is limited to sixty a week and must not exceed eleven in any one day, except for making up lost time to the extent of sixty hours in any one year. A prohibition bill introduced in the legislature of 1892 was, through the influence of the Tillman Reform faction, replaced by a substitute measure, which established a dispensary system, based upon the Gothenburg plan. This system went into effect in July 1893 and was in force for thirteen years. Under it the state bought liquors, graded them in accordance with a chemical analysis, and sold them to consumers in packages of not less than one half-pint; the dispensaries were open from sunrise to sunset, no sales were made to minors or drunkards, and no liquor was drunk on the premises; there was a state dispensary commissioner and a state board of control; and the profits were divided between the state, the counties and the municipalities, the share of the state being devoted to educational purposes. The state dispensary was opposed by the old conservative faction, by the saloon keepers, and by the radical prohibitionists. The Supreme Court of the state by a vote of two to one decided in April 1894 that the law was unconstitutional, but in October a change in the personnel of the court brought about a reversal. The Supreme Court of the United States held on the 18th of January 1897 that the provisions of the statute forbidding the importation of liquor by anyone except certain state officials were in violation of the interstate commerce clause of the constitution (*Scott v. Donald*, 165 U.S. 58). Under the Brice bill, passed in 1904 and amended in 1905, which gave the people of each county the choice between dispensary and prohibition, with the proviso that if they adopt the latter they must pay the extra taxes necessary to enforce it, several counties adopted prohibition; and in 1907 the state dispensary system was abolished, all impure liquors were declared contraband, each county was required to vote to prohibit the sale of liquors or to establish a dispensary, the sale of intoxicating liquors was forbidden outside of cities and towns, and sales may be made only through county dispensaries, which may not sell at night or on Sunday, or to inebriates or minors. The constitution of 1895 forbade a restoration of the saloon system in its original form. An act of 1909 made it a misdemeanour to solicit orders for liquor in the state.

Education.—As early as 1710 public school education was provided for indigent children. The present free-school system was established in 1868. The educational system is under the supervision of the state superintendent of education, with the assistance of a board composed of the governor and not exceeding seven other persons appointed by the governor. The constitution of 1895 ordered a three-mills levy. The present high-school system dates from an act of 1907; and in 1909-1910 there were 131 high schools, six of which required a full four-years' course. The per capita expenditure according to enrolment was \$4.98 for each white pupil and \$1.42 for each negro pupil in 1899; in 1909 it was \$10.34 for each white pupil and \$1.70 for each negro. The schools are supported by taxation; they formerly received the profits from the dispensary. The maximum local tax levy is eight-mills for elementary schools and two-mills for high schools. In 1908-1909 the total expenditures for 5066 public schools (2712 for whites, 2354 for negroes) in the state was \$1,898,886, of which \$1,590,733 was for whites. The average yearly salary in 1908-1909 in white schools was \$479.79 for men and \$249.13 for women teachers; in negro schools the corresponding salaries were \$118.17 and \$91.45. The state supports wholly or in part, the university of South Carolina (before 1906 South Carolina College), established at Columbia in 1801; the South Carolina Military Academy (locally called "The Citadel") established at Charleston in 1845, Clemson Agricultural College (1889), at Clemson, Oconee county, with departments of agriculture, chemistry, mechanics and electricity, textiles and military, and academic and preparatory courses; Winthrop Normal and Industrial College for Girls (1895) at Rock Hill, and the Coloured Normal, Industrial, Agricultural and Mechanical College (1896) at Orangeburg. Among the other higher institutions of learning are the college of Charleston (1790, non-sectarian), Newberry College (1858, Lutheran) at Newberry, the Presbyterian College of South Carolina (1880) at Clinton, Erskine College (1839, Associate Reformed Presbyterian) at Due West, Furman University (1852, Baptist) at Greenville, and Wofford College (1854, Methodist Episcopal South) at Spartanburg; for women, Converse College (1890, non-sectarian) at Spartanburg, the College for Women (1890, Presbyterian) at Columbia, Columbia College (1859, non-sectarian) near Columbia, Greenville Female College (1854, Baptist) at Greenville, Lander Female College (1872, until 1903 at Williams- ton, and until 1904 the Williamston Female College, Methodist Episcopal South) at Greenwood, and the Due West Female College (1859, Associate Reformed Presbyterian) at Due West; and for negroes, Claflin University (1869, Methodist Episcopal) at Orangeburg, Allen University (1881, African Methodist Episcopal) at Columbia, and several normal and industrial schools. There are theological seminaries at Columbia (1828, Presbyterian), at Due West (1837, Associate Reformed Presbyterian), and at Mount Pleasant (1898, Lutheran).

Charities, &c.—The state has no board of public charities, and under the present constitution the county commissioners are overseers of the poor, except in Charleston and Columbia whose poor are provided for by the municipal authorities. The county commissioners of each county have charge of the poor-house of the county, appoint its superintendent, physician and other officials, and report annually to the judge of the Court of General Sessions, who submits this report to the grand jury. Each poor-house must have sufficient tillable land to give employment to all paupers who are able to work. There is an institution for the deaf, dumb and blind (1849, since 1857 a state institution) at Cedar Springs, and a state hospital for the insane, founded in 1821 at Columbia by Samuel Farrow (1760-1824) and opened in 1828. The state penitentiary is also at Columbia.

Finance.—The revenues of the state are derived mainly from the general property tax, fees, licences, dispensary profits and phosphate royalties. At the beginning of the Civil War the public debt was \$3,814,862.91 and the credit of the state was sound. The obligations contracted in support of the war, amounting to about \$3,000,000 were of course nullified by the Fourteenth Amendment. There were so many irregularities and so much corruption connected with the bond issues of reconstruction days that it is impossible to discover their exact amount. Estimates of the total debt in 1872 vary from \$28,000,000 to \$33,000,000. The first step towards repudiation was taken by the "carpet-bag" legislature of 1873, when it provided for the issue of consolidated bonds to replace the outstanding obligations at the rate of fifty cents on the dollar. Nearly six million dollars worth were declared null and void because issued without authority of law. After the return of the Democrats to power in 1877 a further investigation was made and the government finally assumed responsibility for \$6,406,606. The greater part of this was funded under an act of October 1892, and provision was made for a sinking fund, derived mainly from the royalty on phosphate beds. In 1909 the funded debt amounted to \$6,526,885. The legislature is forbidden to create any further debt except for the ordinary current business of the state, unless the proposition be submitted to the voters of the state and approved by a two-thirds majority. After the abolition of the state dispensary system in 1907 a State Dispensary Commission was created

for winding up the business of the dispensary and distributing about \$900,000 (of which \$100,000 was still due) of dispensary funds. Two companies brought suit for moneys owed for liquor sold to the state dispensary; the commission resisted the suit on the ground that as a court and as a representative of the state it could not be sued; the circuit court and the circuit court of appeals overruled this plea and put the funds into the hands of a receiver; but in April 1909 this famous cause was closed by the decision of the Federal Supreme Court, upholding the commission and restoring to it the fund. Banks are subject to the supervision of an examiner and in addition are required to make weekly reports to the comptroller-general.

History.—The history of South Carolina may be divided into four main periods: the period of discovery and exploration (1520-1663); the period of proprietary rule (1663-1719); the period of royal rule (1719-1776); and the period of statehood (from 1776). The first Europeans to visit the coast were a party of Spaniards from Cuba in 1520. In 1562 some French Protestants under Jean Ribaut made an unsuccessful attempt to establish a colony near the mouth of the Broad river (see PORT ROYAL). In 1629, Charles I. granted to his attorney-general, Sir Robert Heath, all the territory lying between the 31st and the 36th parallels and extending through from sea to sea, but no settlement was made, and in 1663 the same territory was granted to the earl of Clarendon (1609-1674), and six other favourites of Charles II. A second charter in 1665 extended the limits to 29° and 36° 30'. The proprietors were to legislate for the colony "by and with the advice, assent and approbation of the freemen." They were empowered, though not required, to grant religious freedom to Dissenters. Land was held in free and common socage, and the statute *quia emptores* was suspended, thus allowing subinfeudation. Concessions or immigration circulars were issued in 1663 and 1665 offering most liberal terms to prospective colonists. This policy was soon abandoned. In the Fundamental Constitution, adopted by the proprietary board in 1669 John Locke and Lord Ashley (1621-1683) prepared for the colony an elaborate feudal system of government which would have been obsolete even in Europe (see NORTH CAROLINA). Subsequent issues in 1670, 1682 (Jan. 12), 1682 (Aug. 17), and 1698 modified the original plan to some extent. The constitutions possess more than a mere antiquarian interest. They helped to arouse that feeling of discontent among the colonists which culminated in the overthrow of proprietary rule, and they encouraged the large plantation system which constituted the foundation of the slave-holding aristocracy.

The first permanent English settlement was made in April 1670 at Albemarle Point, on the west bank of the Ashley river, but as the situation proved unfavourable the government and most of the people moved over in 1680 to the neck between the Ashley and the Cooper rivers, the site of the present city of Charleston. The area of settlement was gradually extended along the coast in both directions, but did not penetrate far into the interior. The province was soon divided into three coast counties: Berkeley, extending from the Stono river to the Sewee and including Charleston; Craven to the north of the Sewee; and Colleton to the south of the Stono. In addition to those settlers who came direct from England there were many Englishmen from Barbadoes and French Protestants, both of which classes exercised considerable influence upon the history of the colony. It was largely due to the Barbadian connexion that South Carolina was for many years more closely associated with the island than with the continental colonies. Her political history during the colonial era is the story of a struggle between popular and prerogative interests, first between the people and the lords proprietors, later between the people and the Crown. From 1670 to 1700 the principal questions at issue were the refusal of the settlers to subscribe to the numerous editions of the Fundamental Constitutions and disputes over the collection of quit-rents. Concessions were finally made which brought the government more directly under popular control. In 1692 the legislature was divided into two houses, and in 1693 the commons house, elected by the people, secured the privilege of initiating legislation. The truce was followed by a controversy

between Churchmen and Dissenters. A test act requiring members of the assembly to conform to the Church of England and to take the sacrament of the Eucharist according to the rites and usages of that Church (1704) was defeated only through the intervention of the Whig House of Lords in England. By an act of the 30th of November 1706, which remained in force until the War of American Independence, the Church of England was made the established religion. After a few years of peace and prosperity there came another attack upon the proprietors which culminated in the revolution of 1719 and the downfall of proprietary rule. Acting on the advice of Chief Justice Nicholas Trott (1663-1740) the proprietors adopted a reactionary policy, vetoed several popular laws, and refused to afford protection from the attacks of the Indians. The people rebelled, overthrew the existing government and elected their leader James Moore (1667-1723) as governor. The result of the revolution was accepted in England, and the colony at once came under royal control, although the rights of the proprietors were not extinguished by purchase until 1729. Theoretically South Carolina and North Carolina constituted a single province, but, as the settlements were far apart, there were always separate local governments. Until 1691 each had its own governors, from 1691 to 1712 there was usually a governor at Charleston and a deputy for the northern settlements, and after 1712 there were again separate governors. The first attempt to define the boundary was made in 1732, but the work was not completed until 1815.

The change from proprietary to royal government scarcely affected at all the constitutional development of the province. The popular branch of the assembly continued to encroach upon the powers of the governor and council. By 1760 the council had almost ceased to exercise any real control over legislation. They rarely initiated or amended a bill of any kind, never a revenue measure. Public officials chosen nominally by the General Assembly were really the nominees of the lower house. In the conduct of his executive functions the governor found himself constantly hampered by committees of the Assembly. In other words, whether they were conscious of the fact or not, the South Carolinians throughout the colonial era were tending towards independence. The demands of the British government after 1760 were not especially unreasonable or tyrannical, but they were made upon a people who were too long accustomed to having their own way. As the spirit of rebellion developed the sentiment in favour of colonial union gained in strength. Thomas Lynch (c. 1720-1776), Christopher Gadsden (1724-1805), and John Rutledge (1739-1800) attended the Stamp Act Congress of 1765, an intercolonial committee of correspondence was appointed in 1773, and delegates were sent to the Continental Congress in 1774 and 1775. A council of safety appointed by a Provincial Congress practically took charge of the government in June 1775. The Assembly was formally dissolved on the 15th of September, Governor William Campbell (d. 1778) fled from the town, and royal government came to an end. In the conflict with the mother country the people had the advantage of long experience in fighting. There had been wars with the Spanish in 1686, 1702-04, 1740, with the Spanish and French in 1706, with pirates in 1718, with the Yemassee Indians in 1715 and the Cherokees in 1760-61, and a slave uprising in 1739. The state suffered severely during the War of Independence, the numbers and influence of the Loyalists serving to embitter the conflict. In the summer of 1776 the British, under Sir Henry Clinton and Sir Peter Parker attempted to capture Charleston and summon the South Carolina Loyalists to their standard, but on the 28th of June the fleet was repulsed in an assault on Fort Moultrie. Clinton returned, however, early in 1780, and, as he surrounded the city on all sides with an overwhelming force, General Benjamin Lincoln, who was defending it with about 7000 men, surrendered (May 12) to avoid certain destruction. The British thereupon overran the whole state, and until near the close of the war a new American army, first under Horatio Gates and later under Nathanael Greene, was engaged in driving them out. The

principal engagements fought within the state were Camden (Aug. 16, 1780), King's Mountain (Oct. 7, 1780), Hobkirk's Hill (April 25, 1781), and Eutaw Springs (Sept. 8, 1781).

The most significant feature in the early history of the state was the struggle between the Low Country, which centred about Charleston, and the Up Country, which was settled largely by Scotch-Irish, who came down the mountain valleys from North Carolina, Virginia and Pennsylvania. The great planters of the low country had wealth, the small farmers of the up country had numbers. Under the first state constitution, adopted in March 1776, the low country element maintained the ascendancy which they had possessed during the colonial period. In 1786 they were forced to consent to the removal of the seat of government to Columbia (final removal, 1790) and in 1808 to a reapportionment of the representation, based partly on wealth and partly on numbers. There was to be one representative for every sixty-second part of the whole number of white inhabitants of the state and one for every sixty-second part of the taxes raised by the legislature. More harmonious relations were in time established, partly because of improvements in the methods of transport, but mainly as a result of outside pressure in the form of criticism of slavery and the adoption by the national government of an economic policy which favoured the manufacturers at the expense of the agricultural interests. In 1832 there was a majority from each section in favour of Nullification (*q.v.*), and the legislature called the famous Nullification Convention, which met at Charleston the 19th of November, and five days later passed the Ordinance of Nullification declaring that certain acts of Congress imposing import duties "are unauthorized by the Constitution of the United States and violate the true meaning and intent thereof, and are null and void and no law, nor binding upon this state, its officers or citizens." President Jackson was ready to use force against the state; and the tariff, over which the whole disagreement had arisen, was changed in such a way as to effect a compromise with the state. From about 1828 to 1861 South Carolina superseded Virginia as the leader of the South. She stood for states' rights and free trade. John C. Calhoun was her political philosopher and George McDuffie her political economist. Her secession, on the 29th of December 1860, was followed by the formation of the Southern Confederacy, the bombardment of Fort Sumter (April 12, 1861) and the Civil War (1861-65). Although few battles were fought within her limits, because of the distance from the frontier, South Carolina made many sacrifices in the interest of her section. With a white population of 291,300 at the beginning of the conflict, the state put into the field during the four years 62,838 effective men, with an enrolment, including reserves, of 71,083, of whom 22% were killed on the field or died in prison. General W. T. Sherman's march across the state (February-March, 1865) was accomplished by an enormous destruction of property by fire and pillage.

All the misfortunes of the war itself are insignificant when compared with the sufferings of the people during the era of Reconstruction (1865-1871). In accordance with the liberal views of President Andrew Johnson, the white people assumed control of affairs shortly after the close of hostilities, and James L. Orr (1822-1873) was chosen governor. Congress reversed this policy (1867), disfranchised the majority of the whites and transferred political power to negroes, Northern adventurers and disreputable native whites. There followed an orgy of crime and corruption. The Assembly Hall was furnished with clocks costing \$600 dollars each, sofas at \$200, and other articles in proportion. A restaurant and bar were kept in the State House at which the members of the legislature and their friends could procure refreshments free of cost. The debt of the state was increased from \$5,000,000 in 1868 to more than \$18,000,000 in 1872. Crime among the negroes became so frequent that the whites were compelled to form a secret organization for protection (see *KU KLUX KLAN*). In the spring of 1868 the state adopted a new constitution in conformity with the Reconstruction Acts of Congress, and elected state officers and congressmen, and on the 25th of June the state was readmitted

to the Union. The inauguration of General Wade Hampton (1818-1902) as governor, and the final withdrawal of United States troops in 1877, marked the downfall of negro rule.

The political history of the state since 1877 presents some interesting features. Practically the entire white population is Democratic, partly for historical reasons and partly because of a feeling that union is necessary to maintain white supremacy. The old warfare between the Up Country and the Low Country has been renewed in a modified form in the conflict between Reformers and Conservatives. The triumph of the Reformers culminated in the founding of Clemson Agricultural College (1889), the establishment of the state dispensary system for the sale of intoxicating liquors (1893), the election of Benjamin R. Tillman (b. 1847) to the United States Senate (1894) over M. C. Butler (1836-1909), and the work of the constitutional convention of 1895.

GOVERNORS OF SOUTH CAROLINA
Proprietary Period (1670-1719)

William Sayle	1670-1671
Joseph West (chosen by the council)	1671-1672
Sir John Yeamans	1672-1674
Joseph West	1674-1682
Joseph Morton	1682-1684
Richard Kyrle	1684
Robert Quarry (chosen by the council)	1684-1685
Joseph West	1685
Joseph Morton	1685-1686
James Colleton	1686-1690
Seth Sothell	1690-1692
Philip Ludwell	1692-1693
Thomas Smith	1693-1694
Joseph Blake (chosen by the council)	1694
John Archdale	1694-1696
Joseph Blake	1696-1700
James Moore (chosen by the council)	1700-1702
Sir Nathaniel Johnson	1702-1710
Edward Tynate	1710
Robert Gibbes (chosen by the council)	1710-1711
Charles Craven	1711-1716
Robert Daniel (deputy-governor)	1716-1717
Robert Johnson	1717-1719

Royal Period (1719-1776)

James Moore (elected by the people)	1719-1721
Sir Francis Nicholson	1721-1729
Arthur Middleton (president of the council and acting-governor)	1724-1729
Robert Johnson	1729-1735
Thomas Broughton (lieutenant-governor)	1735-1737
William Bull (president of the council, lieutenant-governor)	1737-1743
James Glen	1743-1756
William Henry Lyttleton	1756-1760
William Bull, the 2nd (lieutenant-governor)	1760-1761
Thomas Boone	1761-1764
William Bull, the 2nd (lieutenant-governor)	1764-1766
Lord Charles Greville Montague	1766-1768
William Bull, the 2nd (lieutenant-governor)	1768
Lord Charles Greville Montague	1768-1769
William Bull, the 2nd (lieutenant-governor)	1769-1771
Lord Charles Greville Montague	1771-1773
William Bull, the 2nd (lieutenant-governor)	1773-1775
Lord William Campbell	1775
Henry Laurens (president of the council of safety)	1775-1776

Statehood Period (1776-)

John Rutledge (president)	1776-1778
Rawlins Lowndes (president)	1778-1779
John Rutledge	1779-1782
John Matthewes	1782-1783
Benjamin Guerard	1783-1785
William Moultrie	1785-1787
Thomas Pinckney	1787-1789
Charles Pinckney Democrat-Republican	1789-1792
William Moultrie	1792-1794
Arnoldus Vanderhorst	1794-1796
Charles Pinckney	1796-1798
Edward Rutledge	1798-1800
John Drayton	1800-1802
James B. Richardson	1802-1804
Paul Hamilton	1804-1806
Charles Pinckney	1806-1808
John Drayton	1808-1810
Henry Middleton	1810-1812
Joseph Alston	1812-1814

David R. Williams	Democrat-Republican	1814-1816
Andrew Pickens	"	1816-1818
John Geddes	"	1818-1820
Thomas Bennett	"	1820-1822
John L. Wilson	"	1822-1824
Richard I. Manning	"	1824-1826
John Taylor	"	1826-1828
Stephen D. Miller	Democrat	1828-1830
James Hamilton, jun.	"	1830-1832
Robert Y. Hayne	"	1832-1834
George McDuffie	"	1834-1836
Pierce M. Butler	"	1836-1838
Patrick Noble	"	1838-1840
B. K. Henegan (acting)	"	1840
John P. Richardson	"	1840-1842
James H. Hammond	"	1842-1844
William Aiken	"	1844-1846
David Johnson	"	1846-1848
Whitemarsh B. Seabrook	"	1848-1850
John H. Means	"	1850-1852
John L. Manning	"	1852-1854
James H. Adams	"	1854-1856
Robert F. W. Allston	"	1856-1858
William H. Gist	"	1858-1860
Francis W. Pickens	"	1860-1862
Milledge L. Bonham	"	1862-1864
Andrew G. McGrath	"	1864-1865
Benjamin F. Perry	" (provisional)	1865
James L. Orr	Conservative	1865-1868
Gen. Edward R. S. Canby	(military governor)	1868-
Robert K. Scott	Republican	1868-1872
Franklin J. Moses, jun.	"	1872-1874
Daniel H. Chamberlain	"	1874-1876
Wade Hampton	Democrat	1876-1879
William D. Simpson	" (acting)	1879-1880
Thomas D. Jeter	" (acting)	1880
Johnson Hagood	"	1880-1882
Hugh S. Thompson	"	1882-1886
John C. Sheppard	" (acting)	1886
John P. Richardson	"	1886-1890
Benjamin R. Tillman	"	1890-1894
John G. Evans	"	1894-1897
William H. Ellerbe	"	1897-1899
Miles B. McSweeney	"	1899-1903
Duncan C. Heyward	"	1903-1907
Martin F. Ansel	"	1907-1911
Coleman L. Blease	"	1911-

BIBLIOGRAPHY—For general description see Michael Tuomey, *Report on the Geology of South Carolina* (Columbia, 1848); the *Handbook of South Carolina; Resources, Institutions, and Industries of the State*, published by the State Department of Agriculture, Commerce and Immigration (Columbia, 1907; 2nd ed., 1908); the *Annual Reports* (1904 seq.) of the same department and its other publications; and W. G. Simms, *Geography of South Carolina* (Charleston, 1843). For administration see D. D. Wallace, *The Civil Government of South Carolina* (Dallas, 1906); E. L. Whitney, *Government of the Colony of South Carolina*, in Johns Hopkins University Studies, vol. xiii. (Baltimore, 1895); B. J. Ramage, *Local Government and Free Schools in South Carolina*, in Johns Hopkins University Studies, vol. i. No. 12 (Baltimore, 1883); Colyer Meriwether, *History of Higher Education in South Carolina* (Washington, 1889), in Circulars of Information of the United States Bureau of Education, No. 3. There is no general history of South Carolina. The standard work for the colonial period is Edward McCrady's *The History of South Carolina under the Proprietary Government, 1670-1719* (New York, 1897) and his *History of South Carolina under the Royal Government, 1719-1776* (ibid. 1899), which are accurate and interesting, but neglect the manuscript sources at Columbia. Older histories are Alexander Hewatt, *Historical Account of the Rise and Progress of the Colonies of South Carolina and Georgia* (London, 1779), freely used by later writers; David Ramsay, *History of South Carolina* (2 vols., Charleston, 1809), little more than a reprint, without acknowledgments, of Hewatt; and William J. Rivers, *Sketch of the History of South Carolina to the Close of the Proprietary Government, 1719* (Charleston, 1856), which was utilized by McCrady in his first volume and was the first history of the colony based on the documents in the Public Records Office. See also E. L. Whitney, "Bibliography of the Colonial History of South Carolina," in *Annual Report of the American Historical Association for the Year 1894* (Washington, 1895). More distinctly legal and political in character are three doctors' monographs: Edson L. Whitney, *Government of the Colony of South Carolina* (Baltimore, 1895), based too exclusively on the statutes; D. D. Wallace, *Constitutional History of South Carolina from 1725 to 1775* (Abbeville, S. C., 1899; new ed., 1908), a very brief summary; and W. Roy Smith, *South Carolina as a Royal Province, 1710-1776* (New York, 1903), based on the manuscript sources at Columbia. The standard work for the War of Independence is Edward McCrady, *The History*

of South Carolina in the Revolution, 1776-1783 (2 vols., New York, 1901-1902). Older books on the subject are David Ramsay, *History of the Revolution of South Carolina from a British Colony to an Independent State* (2 vols., Trenton, 1785); William Moultrie, *Memoirs of the American Revolution, so far as it related to the States of North and South Carolina and Georgia* (2 vols., New York, 1802); John Drayton, *Memoirs of the American Revolution relating to the State of South Carolina* (2 vols., Charleston, 1821); and R. W. Gibbes, *Documentary History of the American Revolution* (3 vols., Columbia, 1853; New York, 1857). Very little has been written on the period since 1783. David F. Houston, *Critical Study of Nullification in South Carolina* (New York, 1896), is a concise, scholarly work. Hermann von Holst's *John C. Calhoun* (Boston, 1892), is written from the extreme nationalistic and anti-slavery point of view. For the Civil War and Reconstruction, see James Ford Rhodes, *History of the United States from the Compromise of 1850* (5 vols., New York, 1893-1904); James S. Pike, *The Prostrate State; or South Carolina under Negro Government* (New York, 1874); Carl Schurz, *Report on the States of South Carolina, Georgia, &c.* (Washington, 1865, being 39th Congress, 1st session, Sen. Ex. Doc. 2); Hilary A. Herbert and others, *Why the Solid South?* (Baltimore, 1890); and John P. Hollis, *The Early Period of Reconstruction in South Carolina* (Baltimore, 1905), containing an excellent discussion of the period from 1865 to 1868. For the religious history see Frederick Dalcho, *An Historical Account of the Protestant Episcopal Church in South Carolina from the first Settlement of the Province to the War of the Revolution* (Charleston, 1820); G. D. Bernheim, *History of the German Settlements and of the Lutheran Church in North and South Carolina* (Philadelphia, 1872). An excellent monograph on the controversy between the Up Country and the Low Country is William A. Schaper, *Sectionalism and Representation in South Carolina* (Washington, 1901). Among the chief printed sources are the *North Carolina Colonial Records* (10 vols., Raleigh, 1886-1890), useful for the early period; B. R. Carroll, *Historical Collections of South Carolina* (2 vols., New York, 1836); and the *South Carolina Historical Society Collections* (5 vols., Charleston, 1857, 1858, 1859, 1887 and 1897—vol. v. contains the Shaftesbury Papers).

SOUTHCOTT, JOANNA (1750-1814), English religious fanatic, was born at Gittisham in Devonshire. Her father was a farmer and she herself was for a considerable time a domestic servant. She was originally a Methodist, but about 1792, becoming persuaded that she possessed supernatural gifts, she wrote and dictated prophecies in rhyme, and then announced herself as the woman spoken of in Rev. xii. Coming to London at the request of William Sharp (1749-1824), the engraver, she began to "seal" the 144,000 elect at a charge varying from twelve shillings to a guinea. When over sixty she affirmed that she would be delivered of Shiloh on the 19th of October 1814, but Shiloh failed to appear, and it was given out that she was in a trance. She died of brain disease on the 29th of the same month. Her followers are said to have numbered over 100,000, and only became extinct at the end of the 19th century.

Among her sixty publications, all equally incoherent in thought and grammar, may be mentioned: *Strange Effects of Faith* (1801-1802), *Free Exposition of the Bible* (1804), *The Book of Wonders* (1813-1814), and *Prophecies announcing the Birth of the Prince of Peace* (1814). A lady named Essam left large sums of money for printing and publishing the *Sacred Writings of Joanna Southcott*. The will was disputed by a niece on the ground that the writings were blasphemous, but the court of chancery sustained it.

See D. Roberts, *Observations on the Divine Mission of Joanna Southcott* (1807); R. Reece, *Correct Statement of the Circumstances attending the Death of Joanna Southcott* (1815).

SOUTH DAKOTA, one of the North Central states of the American Union, lying between 42° 28' and 45° 57' N. Lat. and 96° 26' and 104° 3' W. long. It is bounded N. by North Dakota; E. by Minnesota and Iowa; S. by Nebraska; and W. by Wyoming and Montana. Lake Traverse and the Big Stone Lake separate the state in part from Minnesota; the Big Sioux River forms most of the boundary between South Dakota and Iowa; and the Missouri river separates the state in part from Nebraska. South Dakota has an extreme length, east and west, of 380 m., an extreme width, north and south, of 245 m., and a total area of 77,615 sq. m., of which 747 sq. m. are water-surface.

Topography.—With the exception of the Black Hills district in the south-west, the state is a wide rolling plain, with its eastern

portion a part of the Prairie Plains region, and its western portion a part of the Great Plains. The surface of this plain, however, ranges from level river valleys in the east to irregular plateaus broken by buttes and scored by cañons in the west. The lowest part of the state is the surface of Big Stone Lake, about 970 ft. above the sea; the highest point is Harney Peak in the Black Hills, which rises to a height of 7216 ft. The state as a whole has a mean elevation of 2200 ft., with 270 sq. m. below 1000 ft.; 42,300 sq. m. between 1000 and 2000 ft.; 23,000 sq. m. between 2000 and 3000 ft.; 10,700 sq. m. between 3000 and 5000 ft.; and 1380 sq. m. between 5000 and 8000 ft.

In the extreme north-east there is a range of low hills known as the Coteau des Prairies, which crosses the state in a S.S.E. direction through Marshall, Roberts, Grant and Deuel counties and maintains an almost constant altitude of from 1950 to 2050 ft. It forms the divide between the headwaters of the Minnesota river on the east and of the James river on the west. To the south and west of the Coteau des Prairies lie vast stretches of plains, including the valleys of the Big Sioux and James rivers. This region presents no striking topographic features except the numerous small lakes which occupy the hollows created by the continental ice-sheet. The greater part of the James River Valley lies in the bed of the extinct Lake Dakota, which was once a very narrow body of water extending northward from about the latitude of the present town of Mitchell for a short distance into what is now North Dakota. West of the James River Valley lies an elevated table-land, known as the Coteau du Missouri, which marks the water-parting between the James and the Missouri rivers, and has a general elevation of about 1800 ft. Along the west boundary of the state the general elevation of the Great Plains is about 3500 ft. As the part east of the river was once covered by the ice-sheet, its hills have been lowered and its valleys filled through the attrition of glaciers until the surface has a gently undulating appearance. West of the Missouri river the sheet of glacial drift is absent, and the lands everywhere show evidence of extensive stream erosion. The surface is broken by many clusters of small hills, such as the Fox Ridge in the central part of the state and the Cave Hills in the north-west, and in the vicinity of streams it is much cut up by deep ravines. In the south-west the results of this erosion are seen in an accentuated form in the region between the White river and the South Fork of the Cheyenne river, known as the Bad Lands or *terres mauvaises*. This area extends from the 101st meridian up the White river for about 120 m. and varies in width from 30 to 50 m. Here the land surface has been carved into forms in infinite variety. Many slender columns of clay, supporting masses of sandstone which have protected them from erosion, rise from the surface like gigantic toadstools. The sides of these ridges and pinnacles are bare of vegetation and display a variety of colours in buff, cream, pale green, grey and flesh. The most prominent features of the landscape rise from 150 to 300 ft. above the valleys; the latter and the flat tops of the mesas are sometimes covered with a scanty soil and a sparse growth of grass. These Bad Lands were once a fairly level plain, but intricate stream erosion produced the labyrinth of ravines and ridges for which the region is noted. The Bad Lands of the White river are also noted for their wealth of animal fossils, which have been found in such quantities as to cause geologists to believe that the vertebrates perished there in droves during a severe storm or flood. Other Bad Lands, on a less impressive scale, are found along the Grand and the Moreau or Owl rivers. North-west of the Bad Lands of the White river lie the Black Hills (*q.v.*), an irregular dome-shaped uplift, about 125 m. long and 60 m. wide, lying partly in Wyoming, and with the main axis trending almost north-west and south-east. The uplift is completely enclosed by a rim of hog-back ridges from 300 to 600 ft. above the plain, and between this rim and the hills proper lies the Red Valley, a tract about 3 m. wide and bordered on the inner side by the main mass of limestone and crystalline rocks which have in general a height of 4000 or 5000 ft. above the sea—some ridges and peaks rise higher still. Upon this limestone plateau there is a central area of high ridges, among them the rough crags of Harney, Custer and Dodge peaks. Between the ridges of the central area lie wide valleys and "parks." The streams flowing from the central area have cut deep gorges and cañons, and among the ridges the granitic rocks have assumed many strange forms. Though rising from a semi-arid plateau, these mountains have sufficient rainfall to support an abundant plant growth, and have derived their name from the fact that their slopes are dark with heavy forests. Cathedral Park in the southern portion, Spearfish Cañon in the north, and the extensive fossil forest at the foot of Mattie's Peak are noteworthy; while the Crystal Cave, near Piedmont, and the Wind Cave, near Hot Springs, are almost unrivalled.

With the exception of the extreme north-east, the state lies within the drainage system of the Missouri river. This stream enters the state near the centre of the northern boundary, pursues a winding south-easterly course, and from its intersection with the 43rd parallel of N. lat. to its junction with the Big Sioux river separates South Dakota from Nebraska. The Big Sioux river rises in the Coteau des Prairies in the north-east and flows almost directly south for nearly 200 m., in the lower part of its course forming

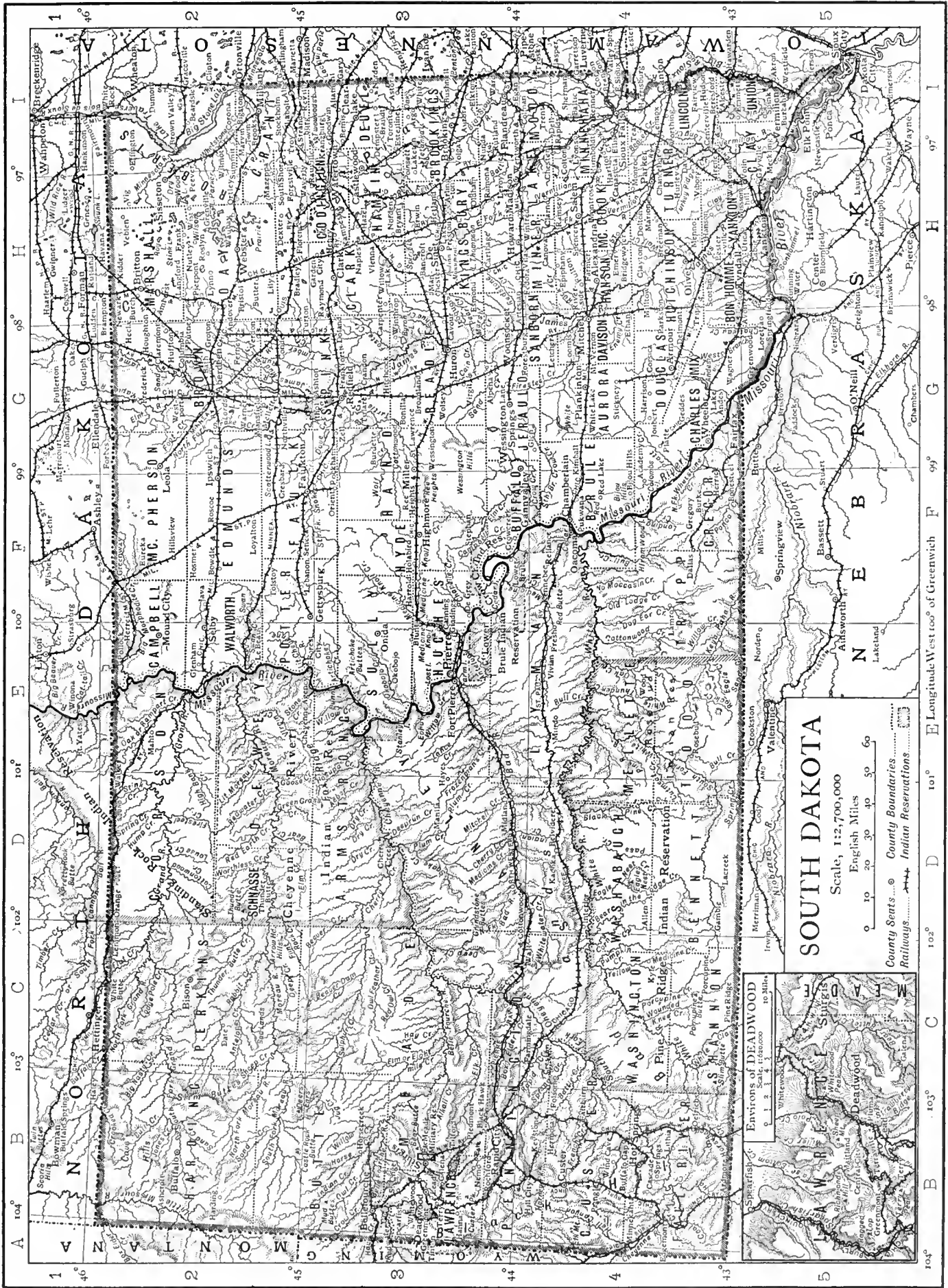

SOUTH DAKOTA

Scale, 1:2,700,000
English Miles

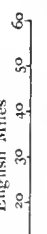

County Seats. County Boundaries. Indian Reservations.

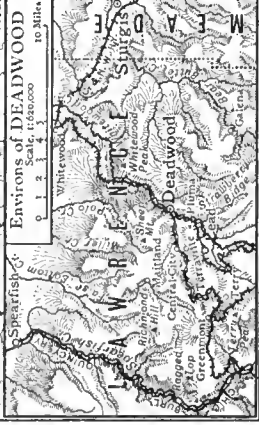

the boundary between South Dakota and Iowa. To the west of this stream and almost parallel with it is the James or Dakota river, which rises in North Dakota and follows a general course southward until it joins the Missouri river near Yankton. From the west the Missouri receives the Grand, Moreau or Owl, Cheyenne and White rivers. Of these the Cheyenne is the most important, being formed by two branches, the Belle Fourche and the South Fork, which, after almost completely encircling the Black Hills, unite at a point nearly 350 m. from their sources. Many of the smaller streams in the Black Hills lose their waters in their lower courses through seepage and evaporation. The Minnesota river has its source in the north-east, and the Big Stone Lake, a body of water about 25 m. long and 3 m. wide, forms a connecting link between its headwaters and the rest of the stream. North of this lake lies Lake Traverse, 27 m. long and 3 m. wide, whose waters flow north into the Bois de Sioux river, whence they flow into the Red River (of the North). The portion of South Dakota east of the Missouri river is dotted with numerous lakes, ranging from small ponds to bodies of water from 10 to 15 m. in diameter. The plains, except in the south-east corner, are underlain by sheets of water-bearing sandstone, which carry a volume of water under such pressure that in the valleys of the James river and the Missouri river and its western tributaries a strong surface flow may be obtained from artesian wells. In 1905 over a thousand wells had been sunk east of the Missouri, and the flow was estimated at 7,000,000 gallons per day.

Fauna and Flora.—Large game within the state is practically extinct. The herds of bison, antelope and elk that once roamed the prairies have vanished, but a few mountain sheep still graze on the grass-covered mesas in inaccessible portions of the Bad Lands. There, too, the grey (or timber) wolf and the coyote are found. The species of small animals do not differ from those found in other parts of the Middle West.

The total woodland area has been estimated at 2500 sq. m., about 3.25% of the land area, and of this amount 2000 sq. m. are in the Black Hills district. All the higher lands of this area are covered by forests; but the Red Valley, lying between the outer ridges and the main uplift, is treeless. Most of the forest consists of yellow pine, but the spruce, aspen, white birch, bur oak, box elder, red cedar, white elm and cottonwood are among the other varieties found. With the exception of narrow strips of woodland along the courses of the larger streams, the rest of the state consists of treeless prairie-lands, which are usually covered with valuable grasses. In the more arid regions the sage-brush and cactus make their appearance. Two national forests contained (1910) 2022 sq. m.

Climate.—The climate of South Dakota is of a continental type. Owing to the northern latitude, comparatively high altitudes, and the great distance from the ocean, there are great annual variations of temperature and a very small amount of rainfall. The state is coldest in the north-east and warmest in the region south of the Cheyenne and west of the Missouri river. The isothermal lines trend from south-east to north-west. The winters are long and marked by exceedingly low temperatures, but as they are the driest season of the year, the extremes are not so disagreeable as they would be in a more humid region. The mean winter temperature ranges from 13° F. at Aberdeen in the northern part of the James River Valley to 25° at Rapid City, in the Black Hills district. The absolute minima at these two places are respectively -46° and -29°; the absolute maxima, 111° and 106°, and the mean annual temperatures, 42° and 46°. At Brookings, in the extreme east, the mean annual temperature is 43°; the mean for the summer is 68° with an extreme recorded of 104°; the mean for the winter is 15° with an extreme recorded of -41°. At Ashcroft, in the extreme north-west, the mean annual temperature is 44°; the mean for the summer 68°; and for the winter 20°; while the highest and lowest temperatures ever recorded are respectively 114° and 44°.

The average annual amount of rainfall for the state is about 20 in., ranging from 13.9 in. at Ashcroft to 25.9 in. at Aberdeen. It is usually greatest in the valleys of the James and Big Sioux rivers and least in the extreme north-central and north-western parts of the state. The average amount of rainfall for the spring is 6 or 7 in.; for the summer, 8 or 9 in.; for the autumn, 3 or 4 in.; and for the winter, 1 or 2 in. The snows are generally light, and cattle may graze on the prairies during most of the winter; but there are occasional severe "blizzards," which are accompanied by intense cold and high winds.

Soils.—The glacial drift east of the Missouri river, unlike that of the New England states, is remarkably free from boulders and gravel, except in a few morainic belts. It is often locally enriched by vegetable mould, and is well adapted for wheat-growing. West of the Missouri river the drift gives place to a fine soil of sand and clay, with deposits of alluvium in the vicinity of streams. Though lacking in vegetable mould, these soils are generally capable of producing good crops where the water-supply is sufficient. The larger valleys of the Black Hills district contain fertile alluvial deposits washed from the neighbouring highlands, but in the plains adjoining these mountains the soils consist of a stiff gumbo suitable only for pasture land. There are throughout the state occasional tracts in which, owing to deficient drainage, an excess of alkali

has accumulated, and which require special treatment before they can be made again productive.

Irrigation.—South Dakota in 1889 had only 15,717 acres of irrigated land. Ten years later this area had increased to 43,676 acres. Of the total, 38,453 acres were irrigated by streams and 5,223 acres by wells. The area irrigated by streams was confined largely to the Black Hills region, the water being supplied by the North Fork and the South Fork rivers, which are tributaries of the Cheyenne. The artesian basin of the east part of the state is fairly well developed, several wells having a flow of from 2000 to 4350 gallons per minute and a pressure of 150 lb to the square inch. Under the Reclamation Act passed by Congress in 1902 the irrigation of 100,000 acres in the Belle Fourche Valley adjacent to the Black Hills region was provided for. It provides for a dam across Owl Creek 6500 ft. long and 20 ft. wide on top, and for two main canals from this distributing centre, one the north canal supplying water for the irrigation of 66,857 acres north of the Belle Fourche river and east of Owl Creek, and the other the south canal for the irrigation of 28,240 acres south of the Belle Fourche. Lateral canals are provided from the main canals to each farm.

Agriculture.—Agriculture is the leading industry in South Dakota; in 1900 out of 137,156 persons engaged in occupations, 82,857 followed agricultural pursuits. In 1890 the total acreage devoted to farming was 11,396,460, which in 1900 had increased to 19,070,616. The percentage of improved acreage, however, fell during the same period from 61.1% in 1890 to 59.2% in 1900. This was due largely to the opening up of land which had formerly not been utilized. The average size of farms (excluding farms under 3 acres with products valued at less than \$500) was 227.2 acres in 1890 and 364.1 acres in 1900. The value of all farm property increased from \$145,527,556 in 1890 to \$297,525,302 in 1900. The average farm value also rose during these ten years from \$2901 to \$5654, and the value per acre advanced from \$12.77 to \$15.60. Fewer farms were worked by owners in 1900 than in 1890, the percentage in the former year being 78.2 and in the latter year 86.6. In 1900 share tenants worked 18.4% of the farms and cash tenants, 3.4%. The total value of farm products in 1899 was \$66,082,419 as against \$22,047,279 in 1889. Of the total product value in 1899, 78.3% was represented by cereals, South Dakota ranking sixteenth among the states in cereal production. Wheat constituted 60.7% of the total for all cereals, Indian corn 21.1%, oats 11.9% and barley 5.8%. A considerable area was devoted to the cultivation of apples, plums and cherries. The total acreage of spring wheat, the state's leading crop, in 1909 was 3,375,000 with a yield of 47,588,000 bush. valued at \$42,829,000, South Dakota ranking third among the states. Next in importance in 1909 came Indian corn with an acreage of 2,059,000 and a product of 65,270,000 bush. (\$32,635,000). Oats had an acreage of 1,450,000 and a product of 49,600,000 bush. (\$14,790,000). Barley was cultivated on 1,021,000 acres, the product amounting to 19,910,000 bush. (\$8,960,000). In the quantity of barley produced the state ranked fifth. In its output of flax, grown almost entirely for the seed, the state held second rank with a product of 5,640,000 bush. (\$8,516,000). The hay acreage was 536,000 and the production, 804,000 tons. Wheat grows chiefly in the east and north-east parts of the state, especially in Brown, Spink, Roberts, Day and Grant counties, the largest crop in 1899 being that of Brown county, 3,320,570 bush., or about one-twelfth of the state's product. Corn grows throughout the western half of the state, and especially in the south-western parts, in Lincoln, Clay, Union, Yankton and Bonhomie counties, the largest crop in 1899 being that of Lincoln county, 3,914,840 bush., nearly one-eleventh of the state crop. Oats has a distribution similar to that of corn, the largest crop in 1899 being that of Minnehaha county, 1,666,110 bush., about one-nineteenth of the state crop. Barley grows principally in the eastern and southern parts of the state—Minnehaha, Moody, Lake and Brookings counties—the largest crop in 1899 being that of Minnehaha county, 932,860 bush., more than one-seventh of the state.

The state is especially well adapted for grazing, and during 1890-1900 there was a large increase in the number of farm animals. The gain was chiefly confined to cattle, but the number of horses, sheep and swine also showed substantial increases. The value of all livestock in 1890 was \$29,689,509 and in 1900, \$65,173,432. The number and value respectively of the various farm animals on the 1st of January 1910 were as follows: horses, 612,000 (\$64,260,000); dairy cows, 656,000 (\$21,648,000); other cattle, 1,341,000 (\$28,832,000); swine, 805,000 (\$8,936,000); and sheep, 829,000 (\$3,316,000).

Mining.—The minerals of South Dakota, of which gold is the most important, are chiefly found in the Black Hills region. This section covers about 3500 sq. m. in the south-east part of the state and includes the counties of Lawrence, Custer, Meade, Pennington and Fall River. Silver follows gold in importance, but the other minerals met with, including gypsum, mica, petroleum, natural gas, granite, marble and tin are not found in paying quantities.

Gold was first discovered in French Creek, Custer county, on the 27th of July 1874 by miners who were with Custer's expedition. Gold was also found later in Lawrence county north of Custer.

and the Homestake Belt in the former county has ever since been the chief producer in the state. For ten years after the Black Hills were thrown open little gold was mined because of the lack of railway facilities. Cement deposits were discovered in the Black Hills region in 1876 and in the same year the first quartz mill was set up in Deadwood. In 1889 a cement plant was built at Yankton, and it is still worked although the output is small. Micamining was also carried on for a time but was soon abandoned. The first natural gas-well in the state was drilled at Pierre in 1892.

The total value of all mineral products in 1902 was \$6,769,104, of which \$6,464,258 were represented by gold and silver, \$110,789 by sandstones and quartzites and \$86,605 by limestones and dolomites; in 1908 the total value was \$8,528,234, which was an increase of more than \$3,500,000 over the value in 1907. This increase was due almost entirely to the gain in the gold output which advanced in value from \$4,138,200 in 1907 to \$7,742,200 in 1908. The total amount of gold mined in 1908 was 374,529 fine ounces, the greater part coming from the Homestake Mine. In 1908, 197,300 oz. of silver were obtained, valued at \$105,500 as against \$70,400 in 1907 and \$101,086 in 1906.

Manufactures.—Manufacturing in South Dakota is of little importance and is confined chiefly to articles for home consumption. Between 1890 and 1900 the number of establishments increased from 499 to 1639, the capital invested from \$3,207,796 to \$7,578,895, and the value of products from \$5,682,748 to \$12,231,239. Under the factory system there were 624 establishments in 1900 and 686 in 1905; the capital invested in 1900 was \$6,051,288 and in 1905 \$7,585,142; and the value of the products was \$9,529,946 in 1900 and \$13,085,333 in 1905. Both in 1900 and 1905 flour and grist-mill products ranked first in value, the figures for 1900 being \$3,208,532 and for 1905 \$6,519,364. The second industry was the manufacture of cheese, butter and condensed milk, and the third, printing and publishing. Sioux Falls is the principal industrial centre.

Transportation.—The railway mileage of Dakota in 1870 (before the present states of South and North Dakota were erected) was only 75 m., and in 1880, 1225 m. In 1890 the mileage of South Dakota was 2610 m., in 1900, 2961 m., and in 1909, 3776 m. The principal systems are the Chicago, Milwaukee & St Paul, the Great Northern and the North-western. The principal waterway is the Missouri River, whose channel has an average depth at low water of about 2½ ft. between Sioux City and Fort Benton, Montana, but the constant shifting of the channel makes navigation uncertain.

Population.—The total population of South Dakota in 1890 (the date of the first Federal census taken since its separate existence as a state) was 328,808, and in 1900 it was 401,570; the increase from 1890 to 1900 being (exclusive of persons on Indian reservations) 16.8%. In 1910, according to the U.S. census, the total was 583,888. Of the population in 1900, 380,714 were whites, 88,508 were foreign-born, 465 were negroes, and 20,225 were Indians. Of the Indians 9293 were taxed. The population on Indian reservations in 1890 was 19,792; in 1900, 17,683. The Indians on reservations and in Indian schools include members of the Yankton, Yanktonai, Oglala, Brulé, Sisseton, Wahpeton, Flandreau, Sioux, Blackfeet, Miniconjou, Sans Arc and Ute tribes, on the Standing Rock and Cheyenne River reservations in the north of the state, the Lower Brulé and Crow Creek reservations in the central part, and the Pine Ridge and Rosebud reservations in the south. The figures for inhabitants born in the United States but not within the state show a preponderance of immigration from neighbouring states, there being, in 1900, 31,047 natives of Iowa, 24,995 natives of Wisconsin, 18,565 of Minnesota and 16,145 of Illinois, out of a total of 313,062. Of the total foreign-born population of 88,508, 19,788 were Norwegians, 17,873 Germans, 12,365 Russians, 5006 English Canadians, 5038 Danes, 3862 English and 3298 Irish. Of the total population 245,383 were of foreign parentage—*i.e.* either one or both parents foreign-born—and of those having both father and mother of foreign birth there were 44,516 of German parentage, 44,119 of Norwegian, 25,113 of Russian and 11,222 of Irish parentage. From 1890 to 1900, on the basis of places having 4000 inhabitants or more, the urban population increased from 10,177 in 1890 to 28,743 in 1900; so that there was the remarkable increase of 182.4% in urban population against an increase of 16.8% in the total population. In 1900 there were seven cities having 3000 or more inhabitants: Sioux Falls with 10,266; Lead, 6210; Yankton, 4125; Aberdeen, 4087; Mitchell, 4055; Deadwood, 3498; and Waterton, 3352.¹

¹ In 1905, according to a state census, there were nine cities with 3000 or more inhabitants, showing some changes in order of size:

In 1906 the total number of communicants of different religious denominations in the state was 161,951, of whom 61,014 were Roman Catholics, 45,018 Lutherans, 16,143 Methodists, 8599 Congregationalists, 7055 Protestant Episcopalians, 6990 Presbyterians and 6108 Baptists.

Administration.—The state is governed under its original constitution of 1889, with amendments of 1896, 1898, 1900, 1902, 1904 and 1909. The suffrage is granted to all males² resident in an election precinct for ten days, in the county for thirty days, in the state for six months, in the United States for one year, and 21 years of age, except those under guardianship or insane, and those convicted of treason or felony, unless restored to civil rights. The legislature may propose amendments to the constitution by a majority vote of all members elected to each of the two houses, or may issue a call for a constitutional convention by a two-thirds' majority. In either case the proposition must be ratified by popular vote at the next general election.

The chief administrative officers are a governor, secretary of state, auditor, treasurer (not eligible for more than two consecutive terms), superintendent of public instruction, attorney-general, and commissioner of school and public lands, all elected biennially by direct popular vote. The governor and lieutenant-governor must be citizens of the United States, qualified electors of the state, at least thirty years old, and residents of the state for two years preceding the election. The governor may remit fines and forfeitures, and grant reprieves, commutations and pardons, but in the more serious cases only on the recommendation of a board of pardons, composed of the presiding judge, the secretary of state, and the attorney-general. He has a veto power extending to items in appropriation bills, which may be overcome by a two-thirds' vote in each house. A lieutenant-governor, chosen biennially, presides over the senate.

The legislative department consists of a Senate (with not fewer than twenty-five and not more than forty-five members) and a House of Representatives (with not fewer than seventy-five and not more than 135 members) chosen biennially. Senators and representatives must be qualified electors, citizens of the United States, at least twenty-five years old, and residents of the state for two years next preceding election. The sessions of the legislature are biennial and are limited to sixty days. Bills may originate in either house, and either house may amend the bills of the other house. A constitutional amendment providing for minority representation in the House of Representatives was rejected in 1889 by a large popular vote. South Dakota was the first American state to adopt the initiative and referendum. Under a constitutional amendment, adopted by popular vote on the 8th of November 1898, 5% of the legal voters of the state may require the legislature to submit to popular vote at the next general election measures which they wish enacted into law, or measures already passed by the legislature which have not yet gone into force. Exceptions to the referendum are made in the case of laws necessary for the immediate preservation of the public peace, health, or safety, or the support of the state government or the various state institutions. In practice the legislature has interpreted these exceptions so freely that nearly all important laws are passed with emergency clauses. The governor's veto does not apply to measures passed by popular vote.

The judicial department consists of the supreme court, circuit courts, county courts, justices of the peace, and police

Sioux Falls, 12,283; Lead, 8052; Aberdeen, 5841; Mitchell, 5719; Watertown, 5164; Deadwood, 4364; Yankton, 4189; Huron, 3783; Brookings, 3265. Pierre, the capital, had a population of 2794.

² The constitution provided for the submission to the people in November 1890 of the question whether the word "male" in Article vii. of the constitution as adopted be omitted, but the popular vote in 1890 and again in 1898 did not favour this change. In the original constitution it was provided that any woman having the qualifications as to age, residence and citizenship might vote at any election held solely for school purposes and "hold any office in this state except as otherwise provided in this constitution."

magistrates. The supreme court consists of five judges chosen for six years—the term for the first judges elected under the constitution of 1889 was four years. The state is divided into five districts and one judge is chosen from each district, although the election is made by the voters of the state at large. The court has appellate jurisdiction only, except for the power to issue writs of *mandamus*, *quo warranto*, *certiorari*, injunction and other original and remedial writs. The state is divided into ten circuits, and one judge is elected by the voters of each circuit for a period of four years. The legislature may, by a two-thirds' vote of each house, increase the number of circuits or the number of judges. The circuit courts have original jurisdiction of all actions and causes, both at law and in equity and such appellate jurisdiction as may be conferred by law. In each county there is a county court with a county judge who is elected by popular vote for two years. The court has original jurisdiction in probate cases, in civil cases involving \$1000 or less, and in criminal cases below the grade of felony. Under an act of 1893 three-fourths of a jury may render a verdict in lesser civil cases in county and circuit courts. The jurisdiction of justices of the peace is determined by law, but it is restricted by the constitution to cases involving \$100 or less.

For the administration of local government the state is divided into counties (64 in 1910) and these in turn are subdivided into townships and municipal corporations. Although the township exists throughout the state, in many cases it is organized only for school purposes and in many others its jurisdiction is so restricted as not to extend to the villages and boroughs within its limits. The county authority is a board of commissioners elected on a general ticket, the township authority a board of supervisors or trustees. For each county there are a judge, clerk of the court, sheriff, auditor, registrar of deeds, treasurer, state's attorney, surveyor, coroner and superintendent of schools, all elected biennially.

Miscellaneous Laws.—A primary law enacted in 1905 authorizes the county convention of any party to provide for the nomination of candidates for county offices and the state legislature by direct vote. The state has had a varied experience in dealing with the liquor problem. A constitutional ordinance forbidding the manufacture, importation and sale of intoxicants was adopted on the 1st of October 1889 by a vote of 40,234 to 34,510. The decision of the United States Supreme Court in the case of *Leisy v. Hardin* in 1890 (see NORTH DAKOTA), and the lax enforcement of the ordinance in the larger towns soon resulted in an active movement for repeal. A state dispensary, similar to that of South Carolina (*q.v.*), was established in 1898 by a vote of 22,170 to 20,557, but it proved ineffective and was superseded in 1900 by the licence system. An attempt to introduce county local options was defeated in the election of 1908.

South Dakota long bore a notorious reputation for the laxity of its divorce laws. The grounds for action are still numerous. An act of 1907, ratified by popular vote in the election of 1908, raised the term of residence under which a person could apply for divorce from six months to one year, and provided that all cases should be tried openly at the regular term of court; and since the passage of this law Sioux Falls has ceased to be notorious for its divorce colony from other states. Neither husband nor wife has any interest in the separate property of the other and the wife may convey her real estate, other than a homestead, without her husband's consent, but the husband must support his wife out of his property or by his labour if he is able, and if he is unable the wife must support him so far as possible out of her property. The one may enter into contract with the other respecting property, and they may hold property as joint tenants. The descent of the estate of a husband dying intestate is the same as that of a wife dying intestate; if there is only one child, or the issue of only one child, the surviving spouse is entitled to one-half of the estate; if more than one child, to one-third of the estate; and if no children, father, mother, brother or sister, to the whole of the estate. The homestead of any family in the state is exempt from attachment, lien or forced sale, except for taxes or purchase money, provided it has been properly recorded; but it can embrace only one dwelling house, cannot include gold or silver mines, and is limited in value to \$5000 to one acre if within a town plat, to 40 acres if it is in the country and was acquired under the laws of the United States relating to mineral lands, and to 160 acres of other land in the country. If the owner is married the homestead cannot be sold or mortgaged without the concurrence of both husband and wife. Upon the death of either husband or wife the exemption may be continued for the benefit of the surviving spouse,

and upon the death of both husband and wife the exemption may be continued until the youngest child is of age.

Education.—At the head of the public-school system is a superintendent of public instruction chosen for two years. In each county there is a county superintendent, and in each school district a board of directors. When the state was admitted into the union two sections of land (1280 acres) in each township were set aside for educational purposes. The permanent school fund amounted to \$4,852,567 on the 1st of July 1907. In 1908 the total expenditures for public schools were \$3,152,006 (\$1,633,594 being for teachers' salaries) and the total receipts were \$3,853,695, of which \$2,283,038 was from district taxes. In 1910 the total permanent school fund was \$7,725,583 and the estimated value of the unsold lands held for the common schools and other educational endowments was \$3,068,172. The schools are open to all pupils between the ages of six and twenty-one, and attendance for twelve weeks each year, eight of which must be consecutive, is compulsory for those between the ages of eight and fourteen. In the school year 1907-1908 77% of all persons of school age were enrolled in the public schools. The educational institutions of the state are all under the management of a board of regents of five members, who are appointed by the governor, with the approval of the senate for terms of six years. The leading state institutions are the state university (1882) at Vermillion, the agricultural college (1884) and the agricultural experiment station at Brookings, the state school of mines (1886) at Rapid City, and normal schools at Spearfish, Madison, Aberdeen and Springfield. The state university is under the control of the board of regents, and is maintained by the state and is the beneficiary of 86,000 acres of land grants from the Federal government. The city of Vermillion and Clay county and private persons have contributed largely to its support. It has a geological and mineralogical museum and under its supervision is carried on the state geological and natural history survey, the state geologist being head of the department of geology and mineralogy of the university. The university includes a college of arts and sciences, a school of commerce, an art department and colleges of law, music and engineering. The university (1910) had 51 instructors and 385 students. Denominational colleges are Yankton College (1882) and Redfield College (1887), both Congregational; Huron College (1883, Presbyterian), and Dakota Wesleyan University (1885; Methodist Episcopal) at Mitchell. The Norwegian Lutherans have a normal school at Sioux Falls, and the Roman Catholics have schools of higher grade at Sioux Falls, Deadwood and Aberdeen.

Charitable Institutions, &c.—The state maintains a school for the blind at Gary, a school for deaf mutes at Sioux Falls, a tuberculosis sanatorium at Custer, a general hospital for the insane at Yankton, a school for the feeble-minded at Redfield, a soldiers' home at Hot Springs, a reform school at Plankinton, and a penitentiary at Sioux Falls. All penal and charitable institutions are subject to the control of a state board of charities and corrections composed of five members appointed by the governor. A children's home at Sioux Falls is partly under state control. There is a Federal hospital for insane Indians at Canton.

Finance.—The general property tax is the chief source of revenue for state, county and local purposes. There is a local board of assessment and equalization in each county and a general board for the state at large. Corporations are reached through the general property tax, but there is a small levy on fire insurance companies for the support of the local fire departments. An inheritance tax was adopted in 1905 which progresses in proportion to the distance of relationship and the amount of the inheritance.¹ Poll taxes are levied by the counties and townships for school and local purposes. The current revenues of the state for the year ending on the 1st of July 1909, including cash on hand at the beginning of the year, were \$4,148,734; for the same year the expenditures were \$3,358,847. There is a small nominal indebtedness, less than the cash surplus in the treasury. The constitution fixes the debt limit at \$100,000 over and above the share of the territorial debt assumed at the time of the formation of the state. The first national bank within the present limits of the state was organized at Yankton in 1872.

History.—The first authentic explorations in what is now South Dakota were made by the Lewis and Clark expedition in 1804 and 1806. The "Yellowstone," a steamboat sent out by the American Fur Company, ascended the Missouri to Fort Pierre in 1831 and to the mouth of the Yellowstone river in 1832. Among the passengers on the second trip was the well-known painter and ethnologist, George Catlin, who spent several weeks at Fort Pierre studying the manners and customs of the Indians. Explorations were also made by Prince Maximilian of Neuwied in 1832, by John C. Frémont in 1838, by Edward Harris and John J. Audubon in 1843, and by various others. Fort Pierre, which was founded by the American Fur Company about 1832, was sold to the United States government

¹ The rate for direct heirs and brothers and sisters is non-progressive.

in 1855, and was converted into a military post. A settlement was made at Sioux Falls in 1856, but was abandoned about six years afterwards. In the meantime several small colonies had been established east of the Missouri River, but growth was much hampered by the Civil War and by Indians. Although it was not the centre of operations, the south of the territory suffered considerably in the various uprisings under Spotted Tail, Red Cloud and Sitting Bull in 1863-65, 1867, and 1875-76 (see NORTH DAKOTA and CUSTER, GEORGE ARMSTRONG). A railway (part of the Chicago, Milwaukee & St Paul system) was built from Sioux City to Yankton in 1872-1873, and in 1874 General Custer led an exploring expedition into the Black Hills, which resulted in the discovery of gold and the rapid settlement of a considerable portion of the west of the territory. A movement was at once begun to break up the great Sioux reservation, partly because it cut off this region from the older settlements east of the Missouri and partly because it contained a large amount of land which was very valuable for farming and grazing purposes. In 1876 the Indians ceded their title to lands in the Black Hills. Under the Dawes Allotment Act of February 1887, and a special statute of March 1889, an agreement was made with some Indians, and about 11,000,000 acres, or about half of the reserve, was thrown open to settlement on the 10th of February 1890. This included, roughly speaking, all of the land between the Missouri River and the Black Hills and between the White River and the Big Cheyenne and a strip extending north from the Black Hills to the North Dakota line between the 102nd and 103rd meridians. The remainder was divided into six smaller reservations, Standing Rock, lying partly in North Dakota, and Cheyenne River, Lower Brulé, Crow Creek, Rosebud, and Pine Ridge in South Dakota. Angered by this sacrifice of their lands and excited by prophecies of the coming of the Messiah, a considerable number of the Indians went on the warpath, but after a short campaign they were defeated by General Nelson A. Miles in the battle of Wounded Knee on the 29th of December 1890, and were compelled to make their submission. Since that time the whites have steadily encroached on the reservations. About 56,560 acres of Lower Brulé lands were opened for settlement in 1889, about 1,600,000 acres of Sisseton and Wahpeton lands¹ in 1892, 168,000 acres of the Yankton Sioux lands in 1895, 416,000 acres of the Rosebud lands in 1904, and 800,000 acres in 1908.

The territory included within the present limits of the state was a part of the district of Louisiana from 1803 to 1805, of the territory of Louisiana from 1805 to 1812, and of the territory of Missouri from 1812 to 1820. After the formation of the state of Missouri in 1820 it remained unorganized, the section east of the Missouri River until 1834, and the section west until 1854. The eastern section was successively a part of the territories of Michigan 1834-1836, Wisconsin 1836-1838, Iowa 1838-1849 and Minnesota 1849-1858, and the western section a part of the territory of Nebraska 1854-1861. On the admission of Minnesota into the Union in 1858, the eastern section was again left unorganized until the 2nd of March 1861, when the territory of Dakota was created, including the present Dakotas and portions of Wyoming and Montana. With the organization of the territory of Idaho in 1863 and the settlement of the southern boundary in 1870 and 1882, the Dakotas acquired their present territorial limits (see NORTH DAKOTA). The inhabitants of the south of the territory held a convention at Sioux Falls in 1885, adopted a state constitution on the 3rd of November, and applied for admission into the Union. A proposition to divide the territory into two states at the forty-sixth parallel was sanctioned by popular vote in the election of November 1887. In accordance with the Enabling Act, which received the President's approval on the 22nd of February 1889, a convention met at Sioux Falls on the 4th of the following July and re-adopted, with some slight verbal changes, the constitution of 1885. This was ratified at the polls on the 1st of October, together with a separate prohibition clause, which was

¹ Part of this tract was situated in North Dakota.

carried by a vote of 40,234 to 34,510 (see *Administration*). On the 2nd of November 1889 President Harrison issued a proclamation declaring South Dakota a state. Subsequently, notwithstanding a temporary set-back due to the panic of 1893, there was a rapid increase of population and wealth. The immigrants came mainly from the northern states and from Scandinavia. In national politics South Dakota has been consistently Republican, except in the election of 1896, when, as a result of the hard times which followed the panic, the Populists and Democrats were able to form a coalition and carry the state for William J. Bryan.

GOVERNORS.

Arthur C. Mellette	Republican	1889-1893
Charles H. Sheldon	"	1893-1897
Andrew E. Lee	Populist	1897-1901
Charles N. Herreid	Republican	1901-1905
Samuel H. Elrod	"	1905-1907
Coe I. Crawford	"	1907-1909
Robert S. Vessey	"	1909-

BIBLIOGRAPHY.—For physical description see the *Bulletins of the South Dakota Geological Survey* (Vermilion, 1894 sqq.); N. H. Darton, *Geology and Underground Waters of South Dakota* (Washington, 1909), Water Supply Paper 227 of the U.S. Geological Survey; James Edward Todd, "The Hydrographic History of South Dakota" in vol. xiii. of the *Bulletin of the Geological Society of America* (Rochester, 1902). And for administration and history see Hagerty, *The Territory of Dakota* (Aberdeen, 1889); E. L. Grantham, (ed.) *Statutes of South Dakota* (2nd revised ed., 2 vols., 1901); Doane Robinson, *A Brief History of South Dakota* (New York, 1905); J. F. Kelly, *Manual of the Township and Road Laws of South Dakota 1907*; the state constitution, biennial reports of the auditor, secretary of state and superintendent of public instruction, and annual reports of the railway commissioners, insurance department and treasurer.

SOUTHEND-ON-SEA, a municipal borough and watering-place in the south-east parliamentary division of Essex, England, on the estuary of the Thames. Pop. (1901), 28,857. Area, 5172 acres. It is 36 m. E. from London by the London, Tilbury & Southend railway; and is served also by the Great Eastern railway, and during the summer by steamers from London. It first sprang into notice from a visit of Queen Caroline in 1804, and as it is the nearest seaside resort to London it is much frequented. The bathing is good, but the tide recedes with great rapidity and for nearly a mile. The pier, which is over 1¼ m. in length, permits the approach of steamers at all tides. Westcliff-on-Sea, a western suburb, has a station on the London and Tilbury line. Westward again is Leigh-on-Sea (an urban district, pop. 3667); its lofty Perpendicular church tower is visible from afar. At Hadleigh, 4m. west, there is a Salvation Army farm colony. The church of Hadleigh is Norman, with an eastern apse, and later additions. The castle was built in the 13th century, and two ruined towers and other fragments remain. Thorpe Bay is a residential suburb about midway between Southend and Shoeburyness. Eastwood, Great Wakering and Little Wakering are parishes in the neighbourhood. Southend was incorporated a municipal borough in 1894, under a mayor, 6 aldermen, and 18 councillors; in 1910 these numbers were increased to 8 aldermen and 24 councillors.

SOUTHERNE, THOMAS (1660-1746), English dramatist, was born at Oxmantown, near Dublin, in 1660, and entered Trinity College in 1676. Two years later he was entered at the Middle Temple, London. His first play, *The Persian Prince, or the Loyal Brother* (1682), was based on a contemporary novel. The real interest of the play lay not in the plot, but in the political significance of the personages. Thomas, the "loyal brother," is obviously a flattering portrait of James II., and the villain Ismael is generally taken to represent Shaftesbury. The poet received an ensign's commission in Princess Anne's regiment, and rapidly rose to the rank of captain, but his military career came to an end at the Revolution. He then gave himself up entirely to dramatic writing. In 1692 he revised and completed *Cleomenes* for Dryden; and two years later he scored a great success in the sentimental drama of *The Fatal Marriage, or the Innocent Adultery* (1694). The piece is based on Mrs Aphra Behn's *The Nun*, with the addition of a comic

underplot. It was frequently revived, and in 1757 was altered by David Garrick and produced at Drury Lane. It was known later as *Isabella, or The Fatal Marriage*. The general spirit of his comedies is well exemplified by a line from *Sir Anthony Love* (1691)—“every day a new mistress and a new quarrel.” This comedy, in which the part of the heroine, disguised as Sir Anthony Love, was excellently played by Mrs Mountfort, was his best. He scored another conspicuous success in *Oroonoko, or The Royal Slave* (1696). For the plot of this he was again indebted to the novel by Mrs Behn. In his later pieces “Honest Tom Southerne” did not secure any great successes, but he contrived to gain better returns from his plays than Dryden did, and he remained a favourite with his contemporaries and with the next literary generation. He died on the 22nd of May 1746.

His other plays are: *The Disappointment, or the Mother in Fashion* (1684), founded in part on the *Curioso Impertinente* in Don Quixote; *The Wives' Excuse, or Cuckolds make themselves* (1692); *The Maid's Last Prayer; or Any, rather than fail* (1692); *The Fate of Capua* (1700); *The Spartan Dame* (1719), taken from Plutarch's Life of Aegis; and *Money the Mistress* (1729).

See *Plays written by Thomas Southerne, with an Account of the Life and Writings of the Author* (1774).

SOUTHEY, ROBERT (1774–1843), English poet and man of letters, was born at Bristol on the 12th of August 1774. His father, Robert Southey, an unsuccessful linendraper, married a Miss Margaret Hill in 1772. When he was three, Southey passed into the care of Miss Elizabeth Tyler, his mother's half-sister, at Bath, where most of his childhood was spent. She was a whimsical and despotic person, of whose household he has left an amusing account in the fragment of autobiography written in a series of letters to his friend John May. Before Southey was eight years old he had read Shakespeare and Beaumont and Fletcher, while his love of romance was fostered by the reading of Hoole's translations of Tasso and Ariosto, and of the *Faerie Queene*. In 1788 he was entered at Westminster school. After four years there he was privately expelled by Dr William Vincent (1739–1815), for an essay against flogging which he contributed to a school magazine called *The Flagellant*. At Westminster he made friends with two boys who proved faithful and helpful to him through life; these were Charles Watkyn Williams Wynn and Grosvenor Bedford. Southey's uncle, the Rev. Herbert Hill, chaplain of the British factory at Lisbon, who had paid for his education at Westminster, determined to send him to Oxford with a view to his taking holy orders, but the news of his escapade at Westminster had preceded him, and he was refused at Christ Church. Finally he was admitted at Balliol, where he matriculated on the 3rd of November 1792, and took up his residence in the following January. His father had died soon after his matriculation.

At Oxford he lived a life apart, and gained little or nothing from the university, except a liking for swimming and a knowledge of Epictetus. In the vacation of 1793 Southey's enthusiasm for the French Revolution found vent in the writing of an epic poem, *Joan of Arc*, published in 1796 by Joseph Cottle, the Bristol bookseller. In 1794 Samuel Taylor Coleridge, then on a visit to Oxford, was introduced to Southey, and filled his head with dreams of an American Utopia on the banks of the Susquehanna. The members of the “pantisocracy” were to earn their living by tilling the soil, while their wives cared for the house and children. Coleridge and Southey soon met again at Bristol, and with Robert Lovell developed the emigration scheme. Lovell had married Mary Fricker, whose sister Sara married Coleridge, and Southey now became engaged to a third sister, Edith. Miss Tyler, however, would have none of “pantisocracy” and “aspheterism,” and drove Southey from her house. To raise the necessary funds for the enterprise Coleridge and he turned to lecturing and journalism. Cottle generously gave Southey £50 for *Joan of Arc*; and, with Coleridge and Lovell, Southey had dashed off the drama, printed as the work of Coleridge, on *The Fall of Robespierre*. A volume of *Poems* by R. Southey and R. Lovell was also published by Cottle in 1795. Southey's uncle, Mr Hill, now desired him to go with him to

Portugal. Before he started for Corunna he was married secretly, on the 14th of November 1795, to Edith Fricker. On his return to England his marriage was acknowledged, and he and his wife had lodgings for some time at Bristol. He was urged to undertake a profession, but the Church was closed to him by the Unitarian views he then held, and medicine was distasteful to him. He was entered at Gray's Inn in February 1797, and made a serious attempt at legal study, but with small results. At the end of 1797 his friend Wynn began an allowance of £160 a year, which was continued until 1806, when Southey relinquished it on Wynn's marriage. His *Letters written during a Short Residence in Spain and Portugal* were printed by Cottle in 1797, and in 1797–1799 appeared two volumes of *Minor Poems* from the same press. In 1798 he paid a visit to Norwich, where he met Frank Sayers and William Taylor, with whose translations from the German he was already acquainted. He then took a cottage for himself and his wife at Westbury near Bristol, and afterwards at Burton in Hampshire. At Burton he was seized with a nervous fever which had been threatening for some time. He moved to Bristol, and after preparing for the press his edition of the works of Thomas Chatterton, undertaken for the relief of the poet's sister and her child, he sailed in 1800 for Portugal, where he began to accumulate materials for his history of Portugal. He also had brought with him the first six books of *Thalaba the Destroyer* (1801), and the remaining six were completed at Cintra. The unrhymed, irregular metre of the poem was borrowed from Sayers.

In 1801 the Southneys returned to England, and at the invitation of Coleridge, who held out as an inducement the society of Wordsworth, they visited Keswick. After a short experience as private secretary to Isaac Corry, chancellor of the exchequer for Ireland, Southey in 1803 took up his residence at Greta Hall, Keswick, which he and his family shared thenceforward with the Coleridges and Mrs Lovell. His love of books filled Greta Hall with a library of over 14,000 volumes. He possessed many valuable MSS., and a collection of Portuguese authorities probably unique in England. After 1809, when Coleridge left his family, the whole household was dependent on Southey's exertions. His nervous temperament suffered under the strain, and he found relief in keeping different kinds of work on hand at the same time, in turning from the *History of Portugal* to poetry. *Madoc* and *Metrical Tales and Other Poems* appeared in 1805, *The Curse of Kehama* in 1810, *Roderick, the last of the Goths*, in 1814. This constant application was lightened by a happy family life. Southey was devoted to his children, and was hospitable to the many friends and even strangers who found their way to Keswick. His friendship for Coleridge was qualified by a natural appreciation of his failings, the results of which fell heavily on his own shoulders, and he had a great admiration for Wordsworth, although their relations were never intimate. He met Walter Savage Landor in 1808, and their mutual admiration and affection lasted until Southey's death.

From the establishment of the Tory *Quarterly Review* Southey, whose revolutionary opinions had changed, was one of its most regular and useful writers. He supported Church and State, opposed parliamentary reform, Roman Catholic emancipation, and free trade. He did not cease, however, to advocate measures for the immediate amelioration of the condition of the poor. With William Gifford, his editor, he was never on very good terms, and would have nothing to do with his harsh criticisms on living authors. His relations with Gifford's successors, Sir J. T. Coleridge and Lockhart, were not much better. In 1813 the laureateship became vacant on the death of Pye. The post was offered to Scott, who refused it and secured it for Southey. A government pension of some £160 had been secured for him, through Wynn, in 1807, increased to £300 in 1835. In 1817 the unauthorized publication of an early poem on *Wat Tyler*, full of his youthful republican enthusiasm, brought many attacks on Southey. He was also engaged in a bitter controversy with Byron, whose first attack on the “ballad-monger” Southey in *English Bards and Scotch Reviewers* nevertheless did not prevent them from meeting on friendly terms. Southey makes little reference

to Byron in his letters, but Byron asserts (*Letters and Journals*, ed. Prothero, iv. 271) that he was responsible for scandal spread about himself and Shelley. In this frame of mind, due as much to personal anger as to natural antipathy to Southey's principles, Byron dedicated *Don Juan* to the laureate, in what he himself called "good, simple, savage verse." In the introduction to his *Vision of Judgment* (1821) Southey inserted a homily on the "Satanic School" of poetry, unmistakably directed at Byron, who replied in the satire of the same name. The unfortunate controversy was renewed even after Byron's death, in consequence of a passage in Medwin's *Conversations of Lord Byron*.

Meanwhile the household at Greta Hall was growing smaller. Southey's eldest son, Herbert, died in 1816, and a favourite daughter in 1826; Sara Coleridge married in 1829; in 1834 his eldest daughter, Edith, also married; and in the same year Mrs Southey, whose health had long given cause for anxiety, became insane. She died in 1837, and Southey went abroad the next year with Henry Crabb Robinson and others. In 1839 he married his friend Caroline Bowles (see below). But his memory was failing, and his mental powers gradually left him. He died on the 21st of March 1843, and was buried in Crosthwaite churchyard. A monument to his memory was erected in the church, with an inscription by Wordsworth.

The amount of Southey's work in literature is enormous. His collected verse, with its explanatory notes, fills ten volumes, his prose occupies about forty. But his greatest enterprises, his history of Portugal and his account of the monastic orders, were left uncompleted, and this, in some sense, is typical of Southey's whole achievement in the world of letters; there is always something unsatisfying, disappointing, about him. This is most true of his efforts in verse. In his childhood Southey fell in with Tasso, Tasso led him to Ariosto, and Ariosto to Spenser. These luxuriantly imaginative poets captivated the boy; and Southey mistook his youthful enthusiasm for an abiding inspiration. His inspiration was not genuinely imaginative; he had too large an infusion of prosaic commonplace in his nature to be a true follower of Ariosto and Spenser. Southey, quite early in life, resolved to write a series of epics on the chief religions of the world; it is not surprising that the too ambitious poet failed. His failure is twofold: he was wanting in artistic power and in poetic sympathy. When his epics are not wildly impossible they are incurably dull; and a man is not fit to write epics on the religions of the world when he can say of the prophet who has satisfied the gravest races of mankind—Mahomet was "far more remarkable for audacious profligacy than for any intellectual endowments." Southey's age was bounded, and had little sympathy for anything beyond itself and its own narrow interests; it was violently Tory, narrowly Protestant, defiantly English. And in his verse Southey truthfully reflects the feeling of his age. In the shorter pieces Southey's commonplace asserts itself, and if that does not meet us we find his bondage to his generation. This bondage is quite abject in *The Vision of Judgment*; Southey's heavenly personages are British Philistines from Old Sarum, magnified but not transformed, engaged in endless placid adoration of an infinite George III. For this complaisance he was held up to ridicule by Byron, who wrote his own *Vision of Judgment* by way of parody.

Some of Southey's subjects, "The Poet's Pilgrimage" for instance, he would have treated delightfully in prose; others, like the "Botany Bay Eclogues," "Songs to American Indians," "The Pig," "The Dancing Bear," should never have been written. Of his ballads and metrical tales many have passed into familiar use as poems for the young. Among these are "The Inchcape Rock," "Lord William," "The Battle of Blenheim," the ballad on Bishop Hatto, and "The Well of St Keyne."

Southey was not in the highest sense of the word a poet; but if we turn from his verse to his prose we are in a different world; there Southey is a master in his art, who works at ease with grace and skill. "Southey's prose is perfect," said Byron; and, if we do not stretch the "perfect," or take it to mean the supreme perfection of the very greatest masters of style, Byron was right.

In prose the real Southey emerges from his conventionality. His interest and his curiosity are unbounded as his *Common-Place Book* will prove; his stores of learning are at his readers' service, as in *The Doctor*, a rambling miscellany, valued by many readers beyond his other work. For biography he had a real genius. The *Life of Nelson* (2 vols., 1813), which has become a model of the short life, arose out of an article contributed to the *Quarterly Review*; he contributed another excellent biography to his edition of the *Works of William Cowper* (15 vols., 1833-1837), and his *Life of Wesley; and the Rise and Progress of Methodism* (2 vols., 1820) is only less famous than his *Life of Nelson*. But the truest Southey is in his *Letters*: the loyal, gallant, tender-hearted, faithful man that he was is revealed in them. Southey's fame will not rest, as he supposed, on his verse; all his faults are in that—all his own weakness and all the false taste of his age. But his prose assures him a high place in English literature, though not a place in the first rank even of prose writers.

Southey's love of romance appears in various volumes: *Amadis of Gaul* (4 vols., 1803); *Palmerin of England* (1807); *Chronicle of the Cid* (1808), and *The byrth, lyf and actes of King Arthur . . . with an introduction and notes* (1817). His other works are: *Specimens of English Poets* (3 vols., 1807); *Letters from England by Don Manuel Espriella* (3 vols., 1807), purporting to be a Spaniard's impressions of England; an edition of the *Remains of Henry Kirke White* (2 vols., 1807); *Omniana or Horae Otiosiores* (2 vols., 1812); *Odes to . . . the Prince Regent . . .* (1814); *Carmen Triumphale . . . and Carmina Aulica . . .* (1814); *Minor Poems . . .* (1815); *Lay of the Laureate* (1816), an epithalamium for the Princess Charlotte; *The Poet's Pilgrimage to Waterloo* (1816); *Wat Tyler: a dramatic poem* (1817); *Letter to William Smith Esq., M.P.* (1817), on the occasion of strictures made in the House of Commons on Wat Tyler; *History of Brazil* (3 vols., 1810, 1817, 1819); *Expedition of Orsua and the Crimes of Aguirre* (1821); *A Book of the Church* (2 vols., 1824); *A Tale of Paraguay* (1825); *Vindiciae Ecclesiae Anglicanae, Letters to C. Butler, Esq., comprising essays on the Romish Religion and vindicating the Book of the Church* (1826); *History of the Peninsular War* (3 vols., 1823, 1824, 1832); "Lives of uneducated Poets," prefixed to verses by John Jones (1829); *All for Love and The Pilgrim to Compostella* (1829); *Sir Thomas More, or Colloquies on the Progress and Prospects of Society* (2 vols., 1829); *Life of John Bunyan*, prefixed to an edition (1830) of the *Pilgrim's Progress*; *Select Works of British Poets from Chaucer to Jonson, edited with biographical notices . . .* (1831); *Essays Moral and Political . . . now first collected* (2 vols., 1832); *Lives of the Admirals, with an introductory view of the Naval History of England*, forming 5 vols. (1833-1840) of *Lardner's Cabinet Cyclopaedia*; *The Doctor* (7 vols., 1834-1847), the last two volumes being edited by his son-in-law, the Rev. J. Wood Warter; *Common-Place Book* (4th series, 1849-1851), edited by the same; *Oliver Newman; a New England Tale* (unfinished), with other poetical remains (1845), edited by the Rev. H. Hill. A collected edition of his *Poetical Works* (10 vols., 1837-1838) was followed by a one volume edition in 1847. Southey's letters were edited by his son Charles Cuthbert Southey as *The Life and Correspondence of the late Robert Southey* (6 vols., 1849-1850); further selections were published in *Selections from the Letters of Robert Southey* (4 vols., 1856), edited by J. W. Warter; and *The Correspondence of Robert Southey with Caroline Bowles. To which are added: Correspondence with Shelley, and Southey's Dreams* (1881), was edited, with an introduction, by Professor E. Dowden. An excellent selection from his whole correspondence, edited by Mr John Dennis, as *Robert Southey, the story of his life written in his letters* (Boston, Massachusetts, 1887), was reprinted in Bohn's Standard Library (1894). See also *Southey* (1879) in the English Men of Letters Series, by Professor E. Dowden, who also made the selection of *Poems by Robert Southey* (1895) in the Golden Treasury Series. A full account of his relations with Byron is given in *The Letters and Journals of Lord Byron* (vol. vi., 1901, edited R. E. Prothero), in an appendix entitled "Quarrel between Byron and Southey," pp. 377-399. Southey figures in four of the *Imaginary Conversations* of W. S. Landor, two of which are between Southey and Porson, and two between Southey and Landor.

Southey's second wife, CAROLINE ANNE SOUTHEY (1786-1854), was the daughter of an East Indian captain, Charles Bowles. She was born at Lymington, Hants, on the 7th of October 1786. As a girl Caroline Anne Bowles showed a certain literary and artistic aptitude, the more remarkable perhaps from the loneliness of her early life and the morbidly delicate condition of her health—an aptitude however of no real distinction. When money difficulties came upon her in middle age she determined to turn her talents to account in literature. She sent anonymously to Southey a narrative poem called *Ellen Fitzarthur*, and this led to the acquaintanceship and long friendship, which, in 1839,

culminated in their marriage. *Ellen Fitzarthur* (1820) may be taken as typical, in its prosy simplicity, of the rest of its author's work. Mrs Southey's poems were published in a collected edition in 1867. Among her prose writings may be mentioned *Chapters on Churchyards* (1820), her best work; *Tales of the Moors* (1828); and *Selwyn in Search of a Daughter* (1835). It was soon after her marriage that her husband's mental state became hopeless, and from this time till his death in 1843, and indeed till her own, her life was one of much suffering. She was not on good terms with her stepchildren, and her share in Southey's life is hardly noticed in Charles Cuthbert Southey's *Life and Correspondence* of his father. But with Edith Southey (Mrs Warter) she was always in friendly relations, and she supplied the valuable additions to Southey's correspondence published by J. W. Warter. She is best remembered by her correspondence with Southey, which, neglected in the official biography, was edited by Professor Dowden in 1881. Mrs Southey died at Buckland Cottage, Lymington, on the 20th of July 1854, two years after the queen had granted her an annual pension of £200.

Besides the works already mentioned, Mrs Southey wrote *The Widow's Tale, and other Poems* (1822); *Solitary Hours* (prose and verse, 1826); *Tales of the Factories* (1833); *The Birthday* (1836); and *Robin Hood*, written in conjunction with Southey, at whose death this metrical production was incomplete.

SOUTHGATE, an urban district in the Enfield parliamentary division of Middlesex, England, 9 m. N. of St Paul's Cathedral, London, on the Great Northern railway. Pop. (1901), 14,993. It is pleasantly situated in a wooded district, and forms an outer residential suburb of the metropolis. Christ Church, in Early English style, is the work of Sir Gilbert Scott, and contains stained glass windows from the designs of Sir E. Burne-Jones and D. G. Rossetti. Close to New Southgate station is Colney Hatch Lunatic Asylum for the county of London, opened in 1851 and subsequently much enlarged.

SOUTH GEORGIA, an uninhabited British island in the South Atlantic Ocean, about 900 m. S. by E. of the Falklands, in 54°-55° S., 36°-38° W.; area 1600 sq. m. It is mountainous, with snowy peaks 6000 to 8000 ft. high, their slopes furrowed with deep gorges filled with glaciers. Its geological constitution—gneiss and argillaceous schists, with no trace of fossils—shows that the island is, like the Falklands, a surviving fragment of some greater land-mass now vanished, most probably indicating a former extension of the Andean system. At Royal Bay, on the south-east side, was stationed the German expedition sent out to observe the transit of Venus in 1882. The island would be well suited for cattle or sheep farming but for its damp, foggy climate. The flora is surprisingly rich, and the German naturalists were able to collect thirteen flowering plants, mostly common also to the Falklands, but one allied to a form found in distant New Zealand. South Georgia is politically attached to the Falklands.

SOUTH HADLEY, a township of Hampshire county, Massachusetts, U.S.A., on the Connecticut river, about 12 m. N. of Springfield. Pop. (1900), 4526, of whom 1119 were foreign-born; (1910 census), 4894. Area, 18.5 sq. m. There are no steam railways, but an electric line connects South Hadley and South Hadley Falls with the New York, New Haven & Hartford and the Boston & Maine railways at Holyoke. The village of South Hadley, or the Center, lies at the south base of Mount Holyoke, about 4 m. from Holyoke and about 3 m. from South Hadley Falls; it is the seat of Mount Holyoke College. South Hadley Falls are connected with Holyoke by a bridge across the Connecticut river. The falls of the river afford water-power for paper mills, cotton and woollen mills, and saw mills. South Hadley was originally a part of the township of Hadley, but in 1753 the district of South Hadley was established, and in 1775 incorporated as a separate township.

SOUTH HOLLAND, a province of Holland, bounded W. by the North Sea, N. by North Holland, E. by Utrecht and Gelderland, S.E. by North Brabant, and S. by Zeeland. It has an area of 1166 sq. m., and a population (1905) of 1,287,363. Its south-

eastern and southern boundaries are defined by the estuaries called the New Merwede, the Hollandsch Diep, the Volkerak, the Krammer, and Grevelingen, and the province includes the delta islands of Goeree (Goedereede) and Overflakkee, Voorne and Putten, Rozenburg, Yselmonde, Hoeksche Waard, and Dordrecht. The natural division into dunes, *geest* grounds, and clay and low fen holds for South as well as for North Holland. Noordwyk-on-Sea, Katwyk-on-sea, Scheveningen, and Ter Heide are watering-places and fishing villages. The Hook (Hoek) of Holland harbour, built at the mouth of the New Waterway (1866-1872) from Rotterdam, is the chief approach to Central Europe from Harwich on the east coast of England. At the foot of the dunes are the old towns and villages of Sassenheim, close to which are slight remains of the ancient castle of Teilingen (12th century), in which the countess Jacoba of Bavaria died in 1433. Among other places of interest are Rynsburg, the site of a convent for nobles founded in 1133 and destroyed in the time of Spanish rule; Voorschoten; Wassenaar, all of which were formerly minor lordships; Loosduinen, probably the Lugdunum of the Romans, and the seat of a Cistercian abbey destroyed in 1579; Naaldwyk, an ancient lordship; and 's Gravenzande, which possessed a palace of the counts of Holland in the 12th century, when it was a harbour on the Maas. The Hague, situated in the middle of this line of ancient villages, is the capital of the province. The market-gardening of the region called the Westland, between the Hague and the Hook of Holland, is remarkable, and large quantities of vegetables are exported to England. On the clay and low fen cattle-rearing and the making of the Gouda cheeses are the principal occupations. Flourishing centres of industry are found along the numerous river arms, including Maasluis, Vlaardingen, Schiedam, Rotterdam, Gorinchem, and Dordrecht. Here also are some of the oldest settlements, such as Vianen on the Lek, Leerdam on the Linge, and Woudrichem or Woerkum at the junction of the Maas and Merwede. Woudrichem guards the entrance to the Merwede in conjunction with Fort Loevestein on the opposite shore. Vianen is supposed to be the *Fanum Dianae* of Ptolemy, and was the seat of an independent lordship which passed to the family of Brederode in 1418, and later to the princes of Lippe-Detmold, from whom it was bought by the states in 1725. There is a fine tomb of Reinoud van Brederode (d. 1556) and his wife in the Reformed Church. The lordship of Leerdam arose out of a division of the lordship of van Arkel and descended to the house of Egmond. It was raised to a countship in 1492, and passed by marriage to the family of Orange-Nassau. The Reformed Church contains the tomb of John, last lord of van Arkel.

SOUTHINGTON, a township of Hartford county, Connecticut, U.S.A., about 15 m. S.W. of the city of Hartford. Within the township is the borough of Southington, served by the New York, New Haven & Hartford railroad. Pop. of the township (1910), 6516, which included that of the borough, 3714. The area of the township is 35 sq. m. The principal industry is the manufacture of hardware goods. Between 1809 and 1874 as many as 236 patents were granted to residents. Southington was originally a part of the township of Farmington. It was settled about 1697; in 1724 it became an independent parish under the name of Panthorn. The township was incorporated in 1779, the borough in 1889.

See H. R. Timlow's *Ecclesiastical and Other Sketches of Southington* (Hartford, 1875).

SOUTH MELBOURNE, a city of Bourke county, Victoria, Australia, separated from Melbourne in 1855, proclaimed a city in 1883, and formerly known as Emerald Hill. Pop. (1901), 40,637. It returns three members to parliament and contains the residence of the governor of the colony. The wharves on the river Yarra and its numerous manufactures contribute to the wealth and importance of the city.

SOUTH MOLTON, a market town and municipal borough in the South Molton parliamentary division of Devonshire, England, on the river Mole, 197 m. W. by S. of London, by the Great Western railway. Pop. (1901), 2848. Besides the parish church

of St Mary Magdalene, a fine and massive Perpendicular building with an ancient pulpit of carved stone, there are a guildhall and market house. Linen goods are manufactured; fairs are held twice yearly, and numerous flour mills are worked by the river. The town is governed by a mayor, 4 aldermen, and 12 councillors. Area, 5910 acres.

South Molton (*Sud Moutona*) was probably the site of a very early settlement, the remains of a British camp being visible 2 m. south of the town, but its authentic history begins with the Domesday survey, which relates that the manor had been royal demesne of Edward the Confessor and now paid £10 a year to the Conqueror. In the 13th century it was held by Nicholas Fitz Martin of the earl of Gloucester for the service of finding a bow with three arrows to attend the earl when he should hunt in Gower. In 1246 Nicholas obtained a grant of a Saturday market and a fair at the feast of the Assumption (both maintained up to the present day), and in 1275 South Molton appears for the first time as a mesne borough under his overlordship. The borough subsequently passed to the Audleys, the Hollands, and in 1487 was granted for life to Margaret, duchess of Richmond, who in 1490 obtained a grant of a fair (which is still held) at the nativity of St John the Baptist. It returned two members to parliament in 1302, but no charter of incorporation was issued until that of Elizabeth in 1590, instituting a common council of a mayor and eighteen burgesses, three of whom were to be elected capital burgesses, with a recorder, steward of the borough court, two sergeants-at-mace, and a court of record every three weeks on Monday. A fresh charter was issued by Charles II. in 1684. This remained in force until the Municipal Corporations Act of 1835. The town formerly had a considerable manufacture of serges and shalloons, or light woollen linings, so called from Châlons-sur-Marne, France.

SOUTH NORWALK, a city of Fairfield county, Connecticut, U.S.A., at the mouth of the Norwalk river, on Long Island Sound, in the township of Norwalk, and 42 m. by rail N.E. of New York. Pop. (1900) 6591, including 1528 foreign-born (many Hungarians) and 83 negroes; (1910) 8968. It is served by the main line and the Danbury division (of which it is a terminus) of the New York, New Haven & Hartford railway, by inter-urban electric lines, and by steamboats to New York. The business and manufacturing section is close to the river and only a few feet above it; behind this, along a ridge, is the residential district; along the Sound are summer cottages and pleasure resorts. West Avenue is a finely shaded drive. The city has a public library and a soldiers' monument. South Norwalk is chiefly a manufacturing and commercial city. It has a good harbour (in which there are three lighthouses), considerable coastwise trade, and important oyster fisheries. South Norwalk, long an unincorporated village called Old Well, was chartered as a city under its present name in 1870, and its charter was revised and amended in 1882, 1897 and 1909.

SOUTHOLD, a township of Suffolk county, New York, occupying the peninsula at the N.E. of Long Island, and including the islands E.N.E. of this peninsula, Plum Island, on which defences protect the eastern entrance to Long Island Sound, Little Gull Island, on which there is a lighthouse, Great Gull Island, and Fisher's Island. Pop. (1900), 8301; (1910, U.S. census), 10,577. Excluding the islands to the east, the township is about 25 m. long and its average width is 2 m.; the Sound shore is broken only by Mattituck and Goldsmith's inlets, but the southern shore is broken with bays and necks of land. The surface is hilly, with occasional glacial boulders. The Long Island railway serves the principal villages of the township, Mattituck, Cutchogue, Peconic, Southold and Greenport (pop. in 1905, 2667), and from Greenport steamers run to Shelter Island, Sag Harbor, New London and New York. Beyond Greenport are the villages of East Marion and Orient. Greenport has some shipping and some oyster fisheries, asparagus is grown at Mattituck, and Peconic Bay is noted for its scallops. Southold is a summer resort, and it is historically interesting as one of the first English settlements on Long Island. The first permanent settlement here was made in 1640; land was

bought from the Indians in August (a lease from the proprietor William Alexander, Lord Stirling, had been secured in 1639), and on the 21st of October 1640 a Presbyterian church was organized under John Youngs, who came from New Haven and had been connected with a St Margaret's church in Suffolk, England, probably at Reydon, near Southwold; and it is possible that the settlement was named from Southwold, though as it was commonly called "the South Hold" by early writers and a settlement on Wading River was called West Hold, the name was probably descriptive. A meeting-house was built in 1642, and biblical laws were enforced. Southold was originally one of the six towns under the New Haven jurisdiction, but in 1662 was placed under Connecticut; in 1664 it objected strongly to the transfer of Long Island to the duke of York; in 1670 refused to pay taxes imposed by Governor Francis Lovelace of New York; in 1672 petitioned the king to be under Connecticut or to be a free corporation; in 1673, when the Dutch got control of New York, withstood the Dutch commissioners, with the help of Connecticut; and, in 1674, after English supremacy was again established in New York, still hoped to be governed from Connecticut. The township was chartered by Governor Edmund Andros in 1676. Greenport was not settled until the first quarter of the 19th century, and was incorporated as a village in 1838.

See Epher Whitaker, *History of Southold, L.I.: Its First Century* (Southold, 1881); *Southold Town Records* (2 vols., Southold, 1882-1884), and an address by C. B. Moore in *Celebration of the 250th Anniversary of the Formation of the Town and the Church of Southold, L.I.* (Southold, 1890).

SOUTH OMAHA, a city of Douglas county, Nebraska, U.S.A., on the high western bluffs of the Missouri, immediately adjoining Omaha on the south. Pop. (1900), 26,001, of whom 5607 were foreign-born; (1910, census) 26,259. It is served by the Chicago, Burlington & Quincy, the Chicago Great Western, the Chicago, Milwaukee & St Paul, the Chicago, Rock Island & Pacific, the Illinois Central, the Missouri Pacific, the Union Pacific, the Chicago & North Western, and the short Omaha Bridge Terminal railways. The principal public buildings are the Federal building (housing the post office and the bureau of animal industry), the public library and the live-stock exchange. Next to Chicago and Kansas City it is the greatest slaughtering and meat-packing centre in the United States. In 1905 it produced 43.5% (\$67,415,177) of the total value of the factory product of the state, and of this output 97.2% represented the slaughtering and packing industry. South Omaha was chartered as a city of the second class in 1887, and in 1901 became a city of the first class. The present city dates from 1884, when the Union stockyards were established here.

SOUTH ORANGE, a township and a village of Essex county, New Jersey, U.S.A., in the N.E. of the state, about 15 m. W. of New York City. Pop. of the village (1900), 4608, of whom 1140 were foreign-born; (1905) 4932; (1910) 6014. Pop. of the township, excluding the village (1900), 1630; (1905, state census) 1946. The village is served by the Morris & Essex division of the Delaware, Lackawanna & Western railroad, and is connected with Orange and with Newark by electric lines. It is primarily a residential suburb of New York and Newark. On the Orange mountain is Essex county park, a wild tract with forest roads. The western part of the township is locally known as Maplewood, the eastern as Hilton. South Orange has a public library and a town hall, and is the seat of Seton Hall College (Roman Catholic), named in honour of Mother Elizabeth Seton, founded at Madison, N.J., in 1856, and removed to South Orange in 1860. Among the landmarks of South Orange are an old stone house of unknown date, but mentioned in legal documents describing the surrounding property as early as 1680; the Baldwin House (c. 1717); and the Timothy Ball House (1743). Settlements were made within the present limits of the township in the latter part of the 17th century by some of the founders of Newark. The township was created in 1861 from parts of the town of Orange and the township of Clinton. The citizens secured in 1869 a village charter providing a village president and a board of trustees; in 1904 the village was entirely

separated from the township, except as regards school government. In 1891 a tract of 150 acres, known as Montrose Park and containing many handsome residences, was annexed to the village.

See H. Whittemore, *The Founders and Builders of the Oranges*, (Newark, 1896).

SOUTHPORT, a municipal and county borough and seaside resort in the Southport parliamentary division of Lancashire, England, immediately S. of the embouchure of the Ribble into the Irish Sea, 18½ m. N. by W. of Liverpool. It is served by the Lancashire & Yorkshire and London & North-Western railways, and by the Southport & Cheshire Lines Extension system. Pop. (1901), 48,083. Its foreshore consists of a great expanse of firm, bright sands, and the mildness of its winter climate is attributed to the radiation of heat from them. Its proximity to Liverpool and Manchester has drawn to it a large resident population, and its visitors number many thousands annually. The promenade along the shore is 2 m. in length; in its centre is the pier, 1 m. long, down which tramcars are drawn by a stationary steam-engine. Other facilities for outdoor enjoyment are provided in Hesketh Park (presented to the town by the Rev. Charles Hesketh, formerly rector of North Meols, and one of the lords of the manor), the Botanic Gardens, Kew Gardens, South Marine Park, and the Winter Gardens. The last, laid out at a cost of £130,000, include a large conservatory, a fine enclosed promenade, a theatre and an aquarium. The principal public buildings are the town hall, the Cambridge Hall (used for concerts, &c.), and an extensive range of markets. There are several infirmaries and hospitals, and a sanatorium for children. Southport has also a free library and art gallery, a literary and philosophical institute, and a college (Trinity Hall) for the daughters of Wesleyan ministers; and a museum and schools of science and art. An extensive service of electric tramways is maintained. The first considerable house in Southport (an inn for the reception of sea-bathers) was built in 1791, and soon after other houses were erected on the site now known as Lord Street, but the population in 1809 was only 100. Birkdale is a residential district adjacent to Southport on the south. In 1867 Southport received a charter of incorporation. It became a county borough in 1905. The corporation consists of a mayor, 10 aldermen and 30 councillors. Area, 5144 acres.

SOUTH PORTLAND, a city of Cumberland county, Maine, U.S.A., on Casco Bay, an arm of which separates it from Portland, with which it is connected by a ferry and four bridges. Pop. (1900) 6287 (763 foreign-born); (1910) 7471. South Portland is served by the Boston & Maine railway. It is the seat of the State (Reform) School for Boys. At Spring Point is Fort Preble, established in 1808 and now a coast artillery station; and at Portland Head is Fort Williams. The city has steel-rolling mills, car shops of the Boston & Maine railway, and ship-building interests, and manufactures marine hardware and varnish. South Portland was part of the old town of Cape Elizabeth (pop. in 1900, 887) until March 1895; the legislature granted it a city charter in 1895, which was not accepted by the town until December 1898.

SOUTHSEA, a seaside resort of Hampshire, England, part of the municipal and parliamentary borough of Portsmouth, with a terminal station (East Southsea) on a branch of the London & South-Western and London, Brighton & South Coast railways. It forms the southern and residential quarter of Portsmouth, and overlooks Spithead, the inlet of the English Channel between the Isle of Wight and the mainland on the north-east. There are two piers, and a parade along the seawall; and the sea-bathing is good. Southsea Castle was built by Henry VIII. at the southern extremity of Portsea Island. (See PORTSMOUTH.)

SOUTH SEA BUBBLE, the name given to a series of financial projects which originated with the incorporation of the South Sea Company in 1711, and ended nine years later in general disaster.

The idea at the root of the parent scheme was that the state should sell certain trading monopolies to a company in return

for a sum of money to be devoted to the reduction of the national debt, and in the form which it took in 1711 it possibly owes its existence to Daniel Defoe, who discussed it frequently with Edward Harley (1664-1735), brother of Robert Harley, earl of Oxford. In 1711 the South Sea Company was formed, and was granted a monopoly of the British trade with South America and the Pacific Islands, the riches of which were popularly regarded as illimitable. Its promoters, mainly wealthy merchants, took over nearly £10,000,000 of the national debt, on which they were to receive interest at the rate of 6% in addition to £8000 a year for the expenses of arrangement. The £600,000 was secured on certain customs duties. The company prospered, and in 1713, when the Asiento treaty was signed with Spain, it received the lucrative monopoly of the slave trade with Spanish America. It was the special pride of the Tories, who regarded it as a rival to the Whig institution, the Bank of England. In 1716 it obtained further concessions under the new Asiento treaty, and in 1717 it advanced a further sum of £2,000,000 to the government, but its prospects were greatly darkened by the outbreak of war between England and Spain in 1718. Yet it continued to thrive, and early in 1718 the king became its governor.

Towards the end of 1719 the directors of the company put before the government, the head of which was Charles Spencer, 3rd earl of Sunderland, a more ambitious scheme. In return for further concessions the company offered to take over the whole of the national debt and to pay £3,500,000 for this privilege. At this time the amount of the debt was £51,300,000, the greater part of which consisted of terminable annuities, money lent to the state in return for a fixed income for life. The company would receive interest at the rate of 5% until 1727, when it would be reduced to 4%. The advantage which the government hoped to obtain from this bargain was obvious; it would rid itself of the unpopular and burdensome debt. The advantages hoped for by the company were much greater, although perhaps not equally obvious. The aim of the directors was to persuade the annuitants of the state to exchange their annuities for South Sea stock; the stock would be issued at a high premium and thus a large amount of annuities would be purchased and extinguished by the issue of a comparatively small amount of stock. Moreover, when this process had been carried out the company would still receive from the government a sum of something like £1,500,000 a year. Seriously alarmed at the proposals of the South Sea Company, the directors of the Bank of England offered the government £5,000,000 for the same privilege, but the company outbid them with an offer of £7,567,000. This was accepted, the necessary act of parliament being passed in April 1720. It is interesting to note that one of the most sturdy opponents of the scheme was Sir Robert Walpole.

The year 1719, when the South Sea scheme was projected, was remarkably favourable to an undertaking of the kind. It was the year when France went delirious over John Law and his Mississippi Company, and the infection spread to England. But before April 1720, when everything was ready, a terrible reaction had begun in France, confidence and prosperity giving way to ruin and disaster. Nevertheless, the directors proceeded with their plan, and in a few weeks they had persuaded over one-half of the government annuitants to become shareholders in the company. Meanwhile the stock of the company had been appreciating steadily in value, and when the new scheme was launched the public began to purchase it more eagerly than before. From 128½ at the beginning of the year the price rose to 330 in March, and in April the directors sold two and a quarter millions of stock at 300. In May the price rose to 550, in June to 890, and in July it touched 1000. At this tremendous premium the directors sold five millions of stock.

By this time the extraordinary success of the South Sea Company had produced a crowd of imitators, and the result was a wild mania of speculation, and its inevitable end—a crash. Hundreds of companies were formed, some of them being fortunate enough to secure the active support of royal and titled

personages; thus the prince of Wales, afterwards George II., became governor of the Welsh Copper Company. Some of these new companies, like the Royal Exchange and the London Assurance, were perfectly legitimate and honourable undertakings, but the great majority put forward the most audacious and chimerical proposals for extracting money from the public. One was "for a wheel for perpetual motion"; another was for a "design which will hereafter be promulgated," and it has been estimated that the total capital asked for by the promoters of these schemes amounted to £300,000,000. Profiting by the sad experience of France, the British government made an attempt to check this movement, and an act was passed for this purpose early in 1720. A proclamation of the 11th of June against the promoters of illegal companies followed, and the directors of the South Sea Company persuaded the lords justices, who were acting as regents during the absence of the king, to abolish 86 companies as illegal.

In August the fall in the price of South Sea stock began, and in September, just as the "insiders" had sold out, it became serious. Instead of being a buyer every one became a seller, and the result was that in a few days the stock of the South Sea Company fell to 175, while the stocks of many other companies were unsaleable. In November South Sea stock fell to 135, and in four months the stock of the Bank of England fell from 263 to 145. Thousands were ruined, and many who were committed to heavy payments fled from the country. The popular cry was for speedy and severe vengeance, both on the members of the government and on the directors of the unfortunate company.

Parliament was called together on the 8th of December 1720, and at once both houses proceeded to investigate the affairs of the company, the lower house soon entrusting this to a committee of secrecy. To stem the tide of disaster Sir Robert Walpole proposed that the Bank of England and the East India Company should each take over nine millions of South Sea stock, but although this received the assent of parliament it never came into force. More to the liking of the people was the act of January 1721 which restrained the directors from leaving the kingdom and compelled them to declare the value of their estates. The committee of secrecy reported in February 1721, and it proved that there had been fraud and corruption on a large scale. The company's books contained entries which were entirely fictitious, and the favours which the directors had secured from the state had been purchased by gifts to ministers, some of whom had also made large sums of money by speculating in the stock. The chief persons implicated were John Aislabie (1670-1742), chancellor of the exchequer; James Craggs, joint postmaster-general; his son James Craggs, secretary of state; and to a lesser degree the earl of Sunderland and Charles Stanhope, a commissioner of the treasury. Aislabie, who was perhaps the most deeply implicated, resigned his office in January, and in March he was found guilty by the House of Commons of the "most notorious, dangerous and infamous corruption"; he was expelled from the house and was imprisoned. Both the elder and the younger Craggs died in March, while owing to the efforts of Walpole both Sunderland and Stanhope were acquitted, the latter by the narrow majority of three. By act of parliament the estates of the directors were confiscated; these were valued at £2,014,123, of which £354,600 was returned to them for their maintenance, the balance being devoted to the relief of the sufferers.

Under the guidance of Walpole parliament then proceeded to deal with the wreck. £11,000,000 had been lent by the directors of the South Sea Company on the security of their own stock, the debtors of the company including 138 members of the House of Commons. This debt was remitted on payment of 10% of the sum borrowed, this being afterwards reduced to 5%, and the £7,567,000 due from the company to the government was also remitted. More serious, perhaps, was the case of those persons who had exchanged the substance of a government annuity for the shadow of a dividend on South Sea stock. They asked that the state should again guarantee to them their incomes, but in the end they only received something like one-half of what they had enjoyed before the bubble.

The South Sea Company with a capital of nearly £40,000,000 continued to exist, but not to flourish. Various changes were made in the nature of its capital, and in 1750 it received £100,000 from the Spanish government for the surrender of certain rights. Its commercial history then ended, but its exclusive privileges were not taken away until 1807. In 1853 the existing South Sea annuities were either redeemed or converted into government stock. The London headquarters of the company were the South Sea House in Threadneedle Street.

SOUTH SHETLAND, a chain of islands on the border of the Antarctic region, lying about 500 m. S.E. of Cape Horn, between 61° and 63° 10' S. and between 53° and 63° W., and separated by Bransfield Strait from the region composed of Danco Land, Palmer Land, Louis Philippe Land, &c. The more considerable islands from west to east are Smith (or James), Low (or Jameson), Snow, Deception, Livingstone, Greenwich, Robert, Nelson, King George I., Elephant, and Clarence. Deception Island is remarkable as of purely volcanic origin. On the south-east side an opening 600 ft. wide gives entrance to an internal crater-lake (Port Forster) nearly circular, with a diameter of about 5 m. and a depth of 97 fathoms. Voyagers in 1828 and 1842 reported that steam still issued from numerous vents, but Otto Nordenskjöld (*Antarctica*, London, 1905) found no exterior evidence of volcanic activity. Most of the islands are rocky and mountainous, and some of their peaks are between 6000 and 7000 ft. in height. Covered with snow for the greater part of the year, and growing nothing but lichens, mosses and some scanty grass, the South Shetlands are of interest almost solely as a haunt of seals, albatrosses, penguins and other sea-fowl. It has been supposed by many that the Dutch navigator Dirk Gerrits discovered the South Shetlands in 1598, but it appears probable that this story originated through confusion with another voyage in which Gerrits was not concerned (cf. H. R. Mill, *Siege of the South Pole*, p. 34 seq.). In 1819 William Smith of the English brig "Williams" observed the South Shetland coast on the 19th of February. Revisiting it in October, he landed on King George I. Island, taking possession for England; he also gave the whole chain the name it bears. In 1820 the naval lieutenant Edward Bransfield was sent in the "Williams" to survey the islands, which attracted the attention of American and British sealers, and became fairly well known through the visits of Antarctic explorers. A smaller group—Coronation Island, Laurie Island, &c.—lying 200 m. east of the South Shetlands, bears the name of South Orkney. It was discovered by the English captain, Powell, in 1821.

SOUTH SHIELDS, a seaport and municipal, county and parliamentary borough of Durham, England; at the mouth of the Tyne on its right bank, opposite North Shields, on a branch of the North-Eastern railway. Pop. (1901), 97,263. It is connected with North Shields and Tynemouth by steam ferries. The principal buildings are the church of St Hilda, with a picturesque old tower; the town hall in the market-place, exchange, custom-house, mercantile marine offices, public library and museum, grammar school, marine school, master-mariners' asylum and seamen's institute. There is a pleasant marine park. The principal industries are now the manufacture of glass and chemicals, and ship-building and ship refitting and repairing, for which there are docks capable of receiving the largest vessels. The Tyne dock has a water-area of 50 acres, the tidal basin of 10 acres, and the quays and yards about 300 acres. Coal from the collieries of the vicinity is largely exported. The trade returns of South Shields are included in the aggregate of the Tyne ports (see NEWCASTLE-UPON-TYNE). The South Pier at the mouth of the river is a massive structure about 1 m. in length, and the North Pier protects the river mouth from the Northumberland bank at North Shields. The parliamentary borough returns one member. The corporation consists of a mayor, 10 aldermen and 30 councillors. Area of municipal borough, 2044 acres.

On elevated ground near the harbour are the remains of a Roman fort guarding the entrance to the Tyne, where numerous coins, portions of an altar, and several sculptured memorial stones have been dug up, and testify to its occupation for a considerable

period. The site of the old station was afterwards occupied by a fort of considerable strength, which was captured by the Scots under Colonel Stewart on the 20th of March 1644. The town was founded by the convent of Durham about the middle of the 13th century, but on account of the complaints of the burgesses of Newcastle an order was made in 1258, stipulating that no ships should be laden or unladen at Shields, and that no "shoars" or quays should be built there. Until the 19th century it was little more than a fishing station. In 1832 it received the privilege of returning a member to parliament, and in 1850 a charter of incorporation.

SOUTHWARK, a central metropolitan borough of London, England, bounded N. by the river Thames, E. by Bermondsey, S.E. by Camberwell and W. by Lambeth. Pop. (1901), 206,180. It is a poor and crowded district, and a large industrial population is employed in the riverside wharves and in potteries, glassworks and other manufactures. There are also large breweries, and the Hop Exchange is a centre of the hop trade. The borough is connected with the City of London by Blackfriars, Southwark and London bridges; the thoroughfares leading from these and the other road-bridges as far up as Lambeth converge at St George's Circus; another important junction is the "Elephant and Castle." Southwark is a bishopric of the Church of England created by act of 1904 (previously a suffragan bishopric in the diocese of Rochester), and also of the Roman Catholic Church. The cathedral of St Saviour belonged to the Augustinian priory of St Mary Overy, or Overies (*i.e.* St Mary over the river), receiving its present name after the suppression of the monasteries. It is cruciform, with a central tower, and has been so restored as to preserve its ancient beauty. Its style is mainly Early English, and among those buried here are Gower, Fletcher and Massinger, the poets, and Edmund, brother of William Shakespeare. The Roman Catholic cathedral of St George is a Gothic building by A. W. Pugin, in St George's Road. Near the "Elephant and Castle" is the Metropolitan Tabernacle, the original building of which, burnt down in 1898, became famous under the Baptist preacher, Charles Spurgeon. The principal benevolent institutions are Guy's Hospital, St Thomas's Street, founded in 1721 by Thomas Guy, with an important medical school; and Bethlehem Royal Hospital for the Insane, commonly corrupted to Bedlam, the origin of which is found in a priory of the 13th century founded within the City, beside the modern Liverpool Street. Other institutions are the Evelina Children's Hospital, the Royal Eye Hospital and the Borough Polytechnic Institute. In Newington Causeway is the Sessions House for the county of London (south of the Thames). The Robert Browning Settlement was founded in York Street, Walworth Road, in 1895 and incorporated in 1903, and in Nelson Square is the Women's University Settlement. The municipal borough includes the western and part of the Bermondsey divisions of the parliamentary borough of Southwark, and the borough of Newington, divided into the western and Walworth divisions; each division returning one member. The borough council consists of a mayor, 10 aldermen and 60 councillors. Area, 1131.5 acres.

The history of Southwark is intimately connected with that of the City of London. At an early date it was incorporated, and its familiar title of "The Borough" still survives. It came, at least in part, under the jurisdiction of the City in 1327. The citizens of London having suffered from the depredations of thieves and felons who escaped into Southwark, petitioned parliament for protection. Accordingly, Edward III., by letters patent, granted them for ever the town and borough, a privilege confirmed by Edward IV. In this connexion was constituted the Bridge Ward Without, the alderman of which is elected not by the borough, but by the other aldermen from among themselves. The authority of the City over the borough is now merely nominal.

The junction in Southwark of the great roads from the south of England for the passage of the Thames sufficiently accounted for the early origin of Southwark. The name is taken from the southward works or fortifications of London. Numerous Roman remains have been found. Southwark witnessed various

episodes during the invasions of the Norsemen, and was fortified by the Danes against the City in the reign of Ethelred the Unready. Besides the priory of St Mary Overy, there was the hospital of St Thomas, founded in 1213 from the neighbouring priory of Bermondsey, and forming the origin of the great modern hospital of the same name in Lambeth (*q.v.*). The many historical associations of Southwark, contemporary memorials of which are almost wholly swept away, centre upon the district bordering the river, and formerly known as Bankside. In this locality was Winchester House, a seat of the bishops of Winchester for five centuries from 1107. At Bankside were the Bear and the Paris Gardens, used for the popular sport of bear and bull baiting; and the Globe theatre, the scene of the production of many of Shakespeare's plays for fifteen years after its erection in 1599. Southwark was further noted for its inns and its prisons. Among the first, the name of the "Tabard" is well known from its mention by Chaucer in detailing the company of pilgrims for Canterbury. Charles Dickens had an early acquaintance with Southwark, as his father was confined in the Marshalsea, one of several prisons here. The prison, no longer extant, and the church of St George the Martyr, where many prisoners, including Bishop Bonner (d. 1561), were buried, figure in the novel *Little Dorrit*. The existing church dates from 1736.

SOUTHWELL, ROBERT (c. 1561-1595), English Jesuit and poet, son of Richard Southwell of Horsham St Faith's, Norfolk, was born in 1560/61. The Southwells were affiliated with many noble English families, and Robert's grandmother, Elizabeth Shelley, figures in the genealogy of Shelley the poet. He was sent very young to the Roman Catholic college at Douai, and thence to Paris, where he was placed under a Jesuit father, Thomas Darbyshire. In 1580 he joined the Society of Jesus, after a two years' novitiate, passed mostly at Tournay. In spite of his youth he was made prefect of studies in the English college of the Jesuits at Rome, and was ordained priest in 1584. It was in that year that an act was passed, forbidding any English-born subject of the Queen who had entered into priest's orders in the Roman Catholic Church since her accession to remain in England longer than forty days on pain of death. But Southwell at his own request was sent to England in 1586 as a Jesuit missionary with Henry Garnett. He went from one Catholic family to another, administering the rites of his Church, and in 1589 became domestic chaplain to Ann Howard, whose husband, the first earl of Arundel, was in prison convicted of treason. It was to him that Southwell addressed his *Epistle of Comfort*. This and other of his religious tracts, *A Short Rule of Good Life, Triumphs over Death, Mary Magdalen's Tears* and a *Humble Supplication to Queen Elizabeth*, were widely circulated in manuscript. That they found favour outside Catholic circles is proved by Thomas Nash's imitation of *Mary Magdalen's Tears* in *Christ's Tears over Jerusalem*. After six years of successful labour Southwell was arrested. He was in the habit of visiting the house of Richard Bellamy, who lived near Harrow and was under suspicion on account of his connexion with Jerome Bellamy, who had been executed for sharing in Anthony Babington's plot. One of the daughters, Anne Bellamy, was arrested and imprisoned in the gatehouse of Holborn. She revealed Southwell's movements to Richard Topcliffe, who immediately arrested him. He was imprisoned at first in Topcliffe's house, where he was repeatedly put to the torture in the vain hope of extracting evidence about other priests. Transferred to the gatehouse at Westminster, he was so abominably treated that his father petitioned Elizabeth that he might either be brought to trial and put to death, if found guilty, or removed in any case from "that filthy hole." Southwell was then lodged in the Tower, but he was not brought to trial until February 1595. There is little doubt that much of his poetry, none of which was published during his lifetime, was written in prison. On the 20th of February 1595 he was tried before the court of King's Bench on the charge of treason, and was hanged at Tyburn on the following day. On the scaffold he denied any evil intentions towards the Queen or her government.

St Peter's Complaint with other Poems was published in April

1595 without the author's name, and was reprinted thirteen times during the next forty years. A supplementary volume entitled *Maeoniae* appeared later in 1595, and *A Foure fould Meditation of the foure last things* in 1606. This, which is not included in Dr A. B. Grosart's reprint (1872) in the Fuller Worthies Library, was published by Mr Charles Edmonds in his *Isham Reprints* (1895). *A Hundred Meditations of the Love of God*, in prose, was first printed from a MS. at Stonyhurst College in 1873. Southwell's poetry is euphuistic in manner. But his frequent use of antithesis and paradox, the varied and fanciful imagery by which he realizes religious emotion, though they are indeed in accordance with the poetical conventions of his time, are also the unconstrained expression of an ardent and concentrated imagination. Ben Jonson told Drummond of Hawthornden that he would willingly have destroyed many of his own poems to be able to claim as his own Southwell's "Burning Babe," an extreme but beautiful example of his fantastic treatment of sacred subjects. His poetry is not, however, all characterized by this elaboration. Immediately preceding this very piece in his collected works is a carol written in terms of the utmost simplicity.

See Dr Grosart's edition already mentioned. Southwell's poems were also edited by W. B. Turnbull in 1856. A memoir of him was drawn up soon after his death. Much of the material was incorporated by Bishop Challoner in his *Memoir of Missionary Priests* (1741), and the MS. is now in the Public Record Office in Brussels. See also Sidney Lee's account in the *Dict. Nat. Biog.*; Alexis Possoz, *Vie du Père R. Southwell* (1866); and a life in Henry Foley's *Records of the English Province of the Society of Jesus. Historic facts illustrative of the labours and sufferings of its members in the 16th and 17th centuries*, 1877 (i. 301-387). Foley's narrative includes copies of the most important documents connected with his trial, and gives full information of the original sources.

SOUTHWELL, a cathedral city in the Newark parliamentary division of Nottinghamshire, England, 16 m. N.E. of Nottingham by a branch of the Midland railway. Pop. (1901), 3161. The minster church of St Mary became a cathedral on the foundation of the episcopal see in 1884. The see covers the greater part of Nottinghamshire and Derbyshire, with small portions of Leicestershire, Lincolnshire and Staffordshire. The foundation of the earliest church here is attributed to the missionary Paulinus in the first half of the 7th century. Another followed, after the devastations of the Northmen, in 960, on the foundation of King Edgar. The building of the present church began in the reign of Henry I. Henry VIII., after the dissolution of the monasteries, contemplated the erection of the church into a cathedral. The cathedral is a magnificent cruciform building, 306 ft. in length, with massive Norman nave (61 ft. wide), transepts, central and two western towers; and Early English choir with transepts. There is an octagonal chapter house, resembling that at York, exhibiting the Decorated style in highest development. It is connected with the church by a cloister. The archbishops of York had a palace here dating from the 15th century. The "great chamber" was restored in 1882, and since 1904 the building has been converted into a residence for the bishops of Southwell.

The erection of the church at Southwell (*Sudwelle*, *Surwell*, *Suthwell*), probably the cause of the origin of the town, is attributed to the archbishop of York in the 7th century. In 958 land at Southwell was granted to the archbishop by Edwy. A detailed description of the great manor is given in Domesday. Southwell remained under the lordship of the see of York until it was taken over by the ecclesiastical commissioners. It was called a borough in the 13th century and down to the 17th, but no charter of incorporation is known. The town never returned representatives to parliament. In the reign of Edward I. the archbishop claimed by prescriptive right a five-days' fair at Pentecost, a three-days' fair at the translation of St Thomas and a Saturday market. Fairs are now held in April and December. The market was still held on Saturdays in 1894, but was then very small.

SOUTHWOLD, a municipal borough and watering-place in the Lowestoft parliamentary division of Suffolk, England, 12 m. S. by W. of Lowestoft, the terminus of the Southwold railway,

which connects with the Great Eastern at Halesworth. Pop. (1901), 2800. The church of St Edmund's is a Perpendicular flint structure. In 1900 a pier 270 yds. long was constructed, and serves as a calling-place for pleasure steamers. A fine common south of the town is used for golf, lawn-tennis, cricket, and other sports. The town is governed by a mayor, 4 aldermen and 12 councillors. Area, 612 acres.

Southwold (*Sudwold*, *Suwold*, *Suthwoud*) owes its origin and prosperity to its herring fisheries, which were considerable in 1086, while the importance of its harbour increased with the decay of Dunwich. In 1461 the men of the town, tenants of the manor which had been granted by the monks of Bury St Edmunds to Gilbert, earl of Clare, and had passed to the Crown with the honour of Clare, claimed exemption from toll, pontage and similar dues as their prescriptive right. An act of 1489 incorporated the bailiffs and commonalty of the town and exempted them from harbour dues. These liberties were confirmed in 1505 by Henry VII., who also granted the corporation the town and manor to hold at fee-farm with certain rights of jurisdiction. Confirmatory chapters were granted by Henry VIII., Edward VI., Elizabeth, James I. and Charles II., and the town was governed by a royal charter of 1689 until the Municipal Reform Act of 1835. The weekly market, now the property of the corporation, was granted to the abbot of St Edmunds as lord of the manor in 1227 together with a yearly fair on the vigil of the feast of St Philip and St James. A fair is still held on Trinity Monday. In 1672 Southwold Bay, usually abbreviated as Solebay, was the scene of a battle between the English fleet under the duke of York and the Dutch under Ruyter, the French fleet holding aloof. The English suffered much, but the Dutch withdrew.

See "*Victoria County History*": *Suffolk*; T. Gardner, *An Historical account of Dunwich, Blithburgh and Southwold* (ed. 1754).

SOUTHWORTH, EMMA DOROTHY ELIZA NEVITE (1819-1890), American novelist, was born in Washington, D.C., on the 26th of December 1819. She studied in a school kept by her stepfather, Joshua L. Henshaw, and in 1840 married Frederick H. Southworth, of Utica, N.Y. After 1843 she supported herself by teaching. Her first story, "The Irish Refugee," was published in the *Baltimore Saturday Visitor*. Her first novel, "Retribution," a serial for the *National Era*, published in book form in 1846, was so well received that she gave up teaching and became a regular contributor to various periodicals, especially the *New York Ledger*. She lived in Georgetown, D.C., until 1876, then in Yonkers, N.Y., and again in Georgetown, D.C., where she died on the 30th of June 1899.

Her novels numbered more than sixty; some of them were translated into German, French and Spanish; in 1872 an edition of thirty-five volumes was published in Philadelphia. They include *The Deserted Wife* (1850); *Mark Sutherland* (1853); *Hickory Hall* (1855); *Unknown* (1874); *Gloria* (1877); *The Trail of the Serpent* (1879); *Nearest and Dearest* (1881); *The Mother's Secret* (1883); *An Exile's Bride* (1887); *The Hidden Hand* (1888); and *Broken Pledges* (1891).

SOUVESTRE, ÉMILE (1806-1854), French novelist, was born on the 15th of April 1806. He was the son of a civil engineer, a native of Morlaix. He was by turns a bookseller's assistant, a private schoolmaster, a journalist, and master at the grammar schools of Brest and of Mülhausen. He settled in Paris in 1836, where he was made (1848) professor in a school for the instruction of civil servants. He began his literary career with a drama, played at the Théâtre français in 1828, the *Siège de Missolonghi*. In novel writing he did much better than for the stage, although he deliberately aimed at making the novel an engine of moral instruction. His best work is undoubtedly to be found in the charming *Derniers Bretons* (4 vols., 1835-1837) and *Foyer breton* (1844), where the folk-lore and natural features of his native province are worked up into story form, and in *Un Philosophe sous les toits*, which received in 1851 a well deserved academic prize. He also wrote a number of other works—novels, dramas, essays and miscellanies. He died in Paris on the 5th of July 1854.

SOUVRÉ, GILLES DE, MARQUIS DE COURTANVAUX, BARON DE LEZINES (c. 1540-1626), marshal of France, belonged to

an old family of the Perche. He accompanied the duke of Anjou to Poland in 1573, and was appointed master of the wardrobe and captain of Vincennes when Anjou became Henry III. He remained in favour, despite the opposition of the queen-mother, Catherine de Médicis, fought at Coutras, defended Tours against the Leaguers, was named chevalier de Saint Esprit and governor of Touraine (1585), and was one of the first to recognize Henry IV. (1589), who subsequently entrusted him with the education of the dauphin. Louis XIII. rewarded him with the title of marshal in 1613. He died in Paris in 1626.

SOUZA-BOTELHO, ADÉLAÏDE FILLEUL, MARQUISE DE (1761-1836), French writer, was born in Paris on the 14th of May 1761. Her mother, Marie Irène Catherine de Buisson, daughter of the seigneur of Longpré, near Falaise, married a bourgeois of that town named Filleul. It was reported, though no proof is forthcoming, that Mme Filleul had been the mistress of Louis XV. Her husband became one of the king's secretaries, and Mme Filleul made many friends, among them Marmontel. Their eldest daughter, Julie, married Abel François Poisson, marquis de Marigny (1727-1781); Adélaïde married in 1779 Alexandre Sébastien de Flahaut de la Billarderie, comte de Flahaut, a soldier of some reputation, who was many years her senior. In Paris she soon gathered round her a salon, in which the principal figure was Talleyrand. There are many allusions to their liaison in the diary of Gouverneur Morris. In 1785 was born her son Auguste Charles Joseph de Flahaut (*q.v.*), who was generally known to be Talleyrand's son. Mme de Flahaut fled from Paris in 1792 and joined the society of *émigrés* at Mickleham, Surrey, described in Mme d'Arbray's *Memoirs*. Her husband remained at Boulogne, where he was arrested on the 29th of January 1793 and guillotined. Mme de Flahaut now supported herself by writing novels, of which the first, *Adèle de Sénange* (London, 1794), which is partly autobiographical, was the most famous. She presently left London for Switzerland, where she met Louis Philippe, duke of Orleans. She travelled in his company to Hamburg, where she lived for two years, earning her living as a milliner. She returned to Paris in 1798, and on the 17th of October 1802 she married José Maria de Souza-Botelho Mourão e Vasconcellos (1758-1825), Portuguese minister plenipotentiary in Paris. Her husband was recalled in 1804, and was offered the St Petersburg embassy; but in the next year he resigned, to settle permanently in Paris, where he had many friends, among them the historian Sismondi. He spent his time chiefly in the preparation of a beautiful edition of the *Lusiads* of Camoens, which he completed in 1817. Mme de Souza lost her social power after the fall of the First Empire, and was deserted even by Talleyrand, although he continued his patronage of Charles de Flahaut. Her husband died in 1825, and after the accession of Louis Philippe she lived in comparative retirement till her death on the 19th of April 1836. She brought up her grandson, Charles, duc de Morny, her son's natural son by Queen Hortense. Among her later novels were *La Comtesse de Fargy* (1822) and *La Duchesse de Guise* (1831). Her complete works were published in 1811-1822.

See Baron A. de Maricourt, *Madame de Souza et sa famille* (1907); *Lettres inédites de J. C. L. de Sismondi . . . et de Madame de Souza* (Paris, 1863), ed. St René Taillandier; Sainte-Beuve, *Portraits de femmes* (1844); and for Mme de Filleul, MM. de Goncourt, *Les Maîtresses de Louis XV.* (1860) and J. F. Marmontel (1804).

SOVEREIGN, originally an adjective, meaning "supreme," especially having supreme or paramount power. The word in Middle English was *soverain* or *sovereyn*, and was taken through Old French from Low Latin *superanus*, chief, principal. The intrusive "g," which is due to a popular confusion of the termination of the word with "reign," dates, according to Skeat, from about 1570. The form "sovrán," borrowed by Milton from Italian *sovano*, *soprano*, is chiefly found as a poetical usage. As a substantive "sovereign" is applied to the supreme head of a state (see **SOVEREIGNTY**), and to the standard English gold coin, worth 20 shillings or £1 (see **POUND**). The gold sovereign was first struck in the reign of Henry VII. (1489); it was of gold of the standard fineness (994.8) and weighed 240 grains. It

bore the figure of the king crowned, in royal mantle, seated on the throne, and holding the sceptre and orb. The sovereign was coined in successive reigns until that of James I., when the name "unite" was given to the coin to mark the union of the two kingdoms. The gold coinage of the kingdom was, until 1816, a secondary part of the monetary system, but in that year the silver standard was discontinued and a gold standard adopted. The sovereign was chosen the new unit of the currency, and the first issue took place in 1817. Its weight was fixed at 123.274 grains; its fineness at 916.66 or twenty-two carats. These standards of weight and fineness are those still in force. At the same time was issued the half-sovereign, of weight in proportion. The weight of 934½ sovereigns is exactly equivalent to twenty Troy pounds, and the weight of each individual sovereign is calculated on this basis. The sovereign is eleven-twelfths pure gold and one-twelfth alloy, copper being usual. The light colour of early Australian sovereigns was due to the use of silver instead of copper. Five-pound pieces were coined in the reigns of Queen Victoria and Edward VII. They were also authorized in the reign of George III. (as were two-pound pieces), but the dies were not completed before the death of that sovereign. Specimens were, however, subsequently struck. There were also some pattern pieces struck in the reign of George IV. Two-pound pieces were issued in the reign of George IV.; they were struck in the reign of William IV., but not issued for circulation; they are current coins of the reigns of Victoria and Edward VII. (See also **MINT**; **MONEY**.)

SOVEREIGNTY. The word sovereignty (Fr. *souveraineté*) is said to be derived from the medieval Latin word *supremitas*, i.e. *suprema potestas*, supreme power. (See Skeat's *Etymological Dictionary* as to various forms of the word, and Meyer, *Lehrbuch des deutschen Staatsrechts*, 15, as to its derivation.)

Sovereignty may be viewed in three ways: there is the historical explanation of its origin and growth, its rude beginning in the savage horde, its completion in the modern state; there is the analytical or juridical explanation; there is also what (for want of a better phrase) may be called the organic explanation of sovereignty.

The following are some of the chief stages in the history of sovereignty: While society is in a rude state or only tribally organized there is no distinct sovereignty, no power which all persons habitually obey. Thus there is no sovereignty among wandering groups of Australian savages: each family is isolated, each horde is a loose and unstable collection. When the horde has become a tribe there may exist no definite sovereign. Distinct in time of war, the power of the chief may be fluctuating and faint in time of peace; even in time of war it may be subject to the authority of a council. Tribes of the same ethnic stock may form a sort of federation, permanent or temporary. "With the council of the confederacy," it has been said, "and, more generally, in the confederacy, sovereignty arises and the true political tradition is evolved" (F. H. Giddings, *Principles of Sociology*, p. 285). When the city and the state are contemporaneous the seat of sovereignty becomes defined. Such was the condition of things in Greece, as considered by Aristotle in his *Politics*. He discusses the question what is the supreme power in the state (3. 10), which he defines as an aggregate of citizen (3. 1), and he recognizes that it may be lodged in one, a few, or many. In his view the distinctive mark of the state is not so much sovereignty (7. 4) as self-sufficiency; a state is not a mere aggregate of persons; it is a union of them sufficient for the purposes of life (7. 8); sufficiency being "to have all things and to want nothing" (7. 5. 1). The Roman jurists say little, and only incidentally, as to sovereignty. But in the middle ages, under the influence of the Roman law, and with the belief in the existence of an empire entitled to universal sway, an absolutist theory of sovereignty was developed in the writings of the jurists who revived the study of that law: the emperor was sovereign; "quod principi placuit legis habet vigorem" (*Institutes*, i. 2. 6).

Those jurists often justified the *plenitudo potestatis* conceded to the emperor by the fact that he stood at the head of Christendom.

Among the theories prevalent in the middle ages was one that mankind formed a unity, with the pope and the emperor at the head of it: the universal Church and the universal emperor ruled the world (Rehm, *Geschichte der Rechtswissenschaft*, p. 198.) Even to Leibnitz, writing in the 17th century, it seemed that "totam Christianitatem unam velut Rempublicam componere, in qua Caesari auctoritas aliqua competit" (*Opera*, 4. 330). When the power of the emperor was weakened, and the idea of a universal ruler was gone, a new test of sovereignty was applied—that of external independence; the true sovereign states were *universitates superiorem non recognoscentes*. There were times and countries in the middle ages in which the collective power of the community was small: many of the great corporations were virtually autonomous; the central authority was weak; the matters as to which it could count upon universal obedience were few. In such circumstances the conception of sovereignty was imperfect. It has been suggested that the modern conception of it was evolved from the contest between three powers: the Church, the Roman Empire, of which the individual states in Europe were theoretically provinces, and the great landowners and corporations. Whatever may be the truth as to this, the modern theory is first clearly stated in Jean Bodin's book *On the Commonwealth* (French ed., 1576; Latin version, 1586), which was the first systematic study of sovereignty. Bodin defines the state thus: "Respublica est familiarum rerumque inter ipsas communium, summa potestate ac ratione moderata multitudo." His theory, which corresponded on the whole to the state of things in France in the time of Louis XI., was a theory of despotism. It may be also described as a type of the mechanical or juridical theory of sovereignty. According to Bodin, there is in the state unlimited one power: "Majestas est summa in cives ac subditos legibusque soluta potestas" (i. 8). There exists a central force from which are derived all the powers which make or give effect to laws; a power which he describes sometimes as "majestas summa potestas summum imperium." This was the conception expressed by Bossuet, "Tout l'état est en la personne du prince," or in Louis XIV.'s saying, "L'état c'est moi."

One favourite theory was that sovereignty originated in a social contract. It was assumed that the individual members of society, by express or implied pact, agree to obey some person or persons; sometimes it is described as an unqualified handing over; sometimes it is a transfer subject to qualifications, and with notice that in certain contingencies this will be withdrawn. Gierke, in his book *Johannes Althusius und die Entwicklung der naturrechtlichen Staatstheorie*, shows (p. 76) that the conception of a treaty or agreement as the basis of the state was in the middle ages a dogma which passed almost unchallenged, and that this theory was maintained up to a late period. It is to be found in the writings of Thomas Aquinas (*De Regimine principum*, 266), Marsilius of Padua, Buchanan, J. de Mariana, and F. Suarez. It is the kernel of the theories of Hobbes, Rousseau, Filmer and Locke. Among the clearest and most logical exponents of this theory was Hobbes, who in his *Leviathan* expounded his notion of an agreement by which absolute power was irrevocably transferred to the ruler. Pufendorf, with some variations, states the same theory. In his view there is a *pactum unionis*, followed by a *pactum subjectionis*. The best-known exponent of this theory of the source of sovereignty is Rousseau, who assumes the existence of a *pacte social*, the terms of which are: "Chacun de nous met en commun sa personne et toute sa puissance sous la suprême direction de la volonté générale; et nous recevons encore chaque membre comme partie indivisible de tout" (*Du Contrat social*, i. c. 6).

It is convenient for the jurist to assume that in every state is one determined or determinable authority in which is vested sovereignty, and from which all other authorities derive their power. The assumption is not true of some states; the legal authority is divided among several persons or bodies. It is at best an unfruitful assumption; and the tendency of students of sociology is to treat discussions as to sovereignty much as modern physiologists treat discussions as to "vital force" or "vital

principle." Comte, Spencer, Bagehot, Durkheim and Giddings, for example, refer to it, if at all, only briefly and incidentally; they conceive society as an organism, or at all events as a growing whole, no one part or force being the cause of all others, and all interacting; society is not the product of any agreement or of force alone, but of a vast variety of interests, desires and needs. Now the state or government comes at a certain stage of organization: small groups are drawn together; powerful corporations fall into line; a national feeling develops; eventually the state as we know it is formed. Sovereignty is a resultant of many forces. It may not exist as to some regions of conduct; as to others it may be weak and mutable; only in certain conditions is the sovereign power supreme as to all matters of conduct.

Among the different senses in which "sovereign" has been used are the following:—

a. "Sovereign" may mean titular sovereign—the king in the United Kingdom, the kaiser in Germany.

b. The legal sovereign: the person or persons who, according to the law of the land, legislate or administer the government.

c. The political or constitutional sovereign: the body of persons in whom the actual power at any moment or ultimately resides. Sometimes this is designated "the collective sovereignty."

d. Sovereignty is also used in a wider sense, as the equivalent of the power, actual or potential, of the whole nation or society (Gierke, 3. 568).

The distinction between real and nominal sovereignty was familiar to medieval writers, who recognized a double sovereignty, and distinguished between (1) the real or practical sovereignty resident in the people, and (2) the personal sovereignty of the ruler (Adolf Dock, *Der Souveränitätsbegriff*, &c., p. 13). By many writers sovereignty is regarded as resident not in any one organ, but in the *Gesamtperson* of the community (Maitland, *Political Theories of the Middle Ages*, xliii.).

Sometimes sovereignty is defined as the organized or general will of the community (Combotheca, *Conception juridique de l'état*, p. 96). "Sovereignty is the organized will of an organized independent community. . . . The kings and parliaments who serve, as its vehicles." "Sovereignty resides in the community" (Woodrow Wilson, p. 1448). The same theory is often expressed by saying that the majority in a community, or a particular group, in fact, rules (Guizot, *Representative Government*, i. 167). This was the doctrine of the French Revolution. "Sachez que vous êtes rois et plus des rois," said a revolutionary orator cited by Taine. It was the language of the founders of the American constitution and contemporary political writers; the language, for example, of Paine: "In republics such as there are established in America the sovereign power, or the power over which there is no control and which controls all others, remains where nature placed it—in the people" (*Dissertations on Government*, i. 6).

The same theory assumes a more subtle form, especially in the writings of Hegelians. Sovereignty is with them a term descriptive of the real will of the community, which is not necessarily that of the majority. "If the sovereign power is to be understood in this fuller, less abstract sense, if we mean by it the real determinant of the habitual obedience of the people, we must look for its sources much more widely and deeply than the analytical jurists do; it can no longer be said to reside in a determinate person or persons, but in that impalpable congeries of the hopes and fears of a people bound together by common interest and sympathy, which we call the common will" (Green's *Works*, 2. 404). "Though it may be misleading to speak of the general will as anywhere, either actually or properly, sovereign. . . . yet it is true that the institutions of political society are an expression of, and are maintained by, the general will" (2. 409).

Sovereignty is used in a further sense when Plato and Aristotle speak of the sovereignty of the laws (*Laws*, 4. 715; *Politics*, 4. 4; 3. 15). Thus Plato remarks: "I see that the state in which the law is above the rulers, and the rulers are the inferiors of the law, has salvation." (See also Gierke, *Genossenschaftsrecht*, 3. 8.) Even in medieval writers, such as Bracton, is found the notion

that the king is subject to the laws: "Bracton knows of no sovereign in the Austinian sense, and distinctly denies to the royal authority the attribute of being incapable of legal limitation" (J. N. Figgis, *The Divine Right of Kings*, p. 13). We find the same expressed by many German jurists, *i.e.* the idea of a state which exists only in the law and for the law, and whose life is but by a legal order regulating public and private relationship (Gierke iii., x.).

Among the definitions of sovereignty may be quoted these: "That which decides in questions of war and peace, and of **Definitions** making or dissolving alliances, and about laws and of **Sovereignty.** capital punishment, and exiles and fines, and audit of accounts and examinations of administrators after their term of office" (Aristotle, *Politics*, 4. 4. 3). "Suprematum illi tribuo qui non tantum domi subditos manu militari regit, sed et qui exercitum extra fines ducere et armis, foederibus, legationibus, ac caeteris juris gentium functionibus aliquid momenti ad rerum Europae generalium summam conferre potest" (Leibnitz, *Opera*, 4. 333). "La souveraineté est celle qui sert à exprimer l'indépendance d'un état aussi bien à l'intérieur qu'à l'extérieur" (F. de Martens, *Traité du droit international*, translated by A. Léo, 1883, i. 378). "L'indépendance complète qui peut se manifester à deux points de vue; l'un extérieur, l'autre intérieur" (Frentz Despagnet, *Droit international public*, 1894, p. 80). "Sovereignty as applied to states imports the supreme, absolute, uncontrollable power by which any state is governed" (T. M. Cooley, *Constitutional Limitations*, p. 1). "Social control, manifesting itself in the authoritative organization of society as the state, and acting through the organs of government, is sovereignty" (Giddings, *Elements of Sociology*, p. 217). The sovereign is "Absolut unabhängig und nur durch sich selbst beschränkt und beschränkbar" (Zorn, *Völkerrecht*, p. 4. See the collection of definitions in *Der Souveränitätsbegriff im Bodin*, &c., by Dr Adolf Dock (1897), p. 6, and in *La Conception juridique de l'état*, by Comtohecrea, p. 90). Many of these definitions describe an ideal state of things rather than realities. Some of the definitions would apply to the authority of powerful religious bodies in certain periods of history, or of illegal associations, such as the Mafia, which have terrorized the community.

Territorial sovereignty is used in a variety of senses. Often the phrase is the equivalent of sovereignty. It may mean a state of things such as existed in the middle ages, in which ownership and sovereignty were not clearly separated: when he who was owner had sovereign rights incident thereto, or, as it was sometimes phrased, when sovereignty inhered in the territory, when the king was the supreme landowner (Maine, *Ancient Law*, p. 106; Figgis, pp. 11, 14); when all political power exhibited proprietary traits, and was incident to the ownership of land (Maitland, *Township and Borough*, p. 31). Territorial sovereignty is thus defined by Leibnitz: "Superioritatem territorialem in summo subditos coercendi jure consistere" (*Opera*, 4. 358. See Laband, i. c. 8).

Certain propositions are often stated with respect to sovereignty. One of them, stated by Rousseau (*Du Contrat social*, 2. c. 2), is that it is indivisible: a proposition true in the sense that in regard to the same matters at the same time there cannot be two sovereigns, but not true in the sense in which it has often been employed, namely, that in the last analysis of society there are some persons or person who control all conduct and are habitually obeyed as to all matters. Rather we may say with Maine, "Sovereignty is divisible, but independence is not." To hold sovereignty not to be divisible is for juridical purposes not a working theory; states part, permanently or temporarily, with few or many of the rights and powers comprehended in sovereignty; to speak of it as undivided in the case of Crete, Egypt or Tibet is to do violence to facts.

A frequent deduction from the theory of the indivisibility of sovereignty is that there cannot be double allegiance; in other words, no one can be the subject of two states. This deduction is not in fact true. With the existing differences in the laws of

modern states as to nationality, persons may be, and are, subjects of two or more states. In the native states in India there may be said to be double allegiance. C. L. Tupper, in his *Our Indian Protectorate*, refers to "the double allegiance of the subjects of native states" in India; and he explains that the native rulers are themselves subject to the Indian government. "For all purposes of our relation with powers the subjects of Indian native states must be regarded as subjects of Her Majesty" (*Our Indian Protectorate*, 1893, p. 353). Such double allegiance is apt to exist in times of transition from one sovereignty to another; for example, in the 18th century, in the British possessions in India, the Mogul was said to exercise a personal sovereignty. As Sir William Scott remarked in the *Indian Chief*, 3 C. Rob. 22, it hardly existed otherwise than as a phantom: the actual authority to be obeyed was exercised by the East India Company. The natives of protected states owe not only allegiance to them, but also certain duties, ill defined, to the protecting state.

Another deduction from the same proposition is that any corporation or private body which appears to exercise sovereign powers together with the state does so only by delegation. This theory is thus stated by Burke (*Works*, 7. 289) with reference to the East India Company: "The East India Company itself acts under two very dissimilar sorts of power, derived from two sources very remote from each other. The first source of its power is under charters which the Crown of Great Britain was authorized by act of parliament to grant, the other is from several charters derived from the emperor of the Moguls. . . . As to those of the first description, it is from the British charters that they derive a capacity by which they are considered as a public body, or at all capable of any public function. . . . This being the root and origin of their power, renders them responsible to the party from whom all their immediate or consequential powers are derived."

A further proposition often stated with respect to sovereignty is that it is unlimited: a proposition which is not true of the legal or political sovereign. In all states are limits, more or less definite, to such powers, according to the character of the subjects and the relations of the state to foreign powers. Even despotism is tempered by assassination and the liability of revolution (Dicey, *Law of the Constitution*, 6th ed., p. 75). A third proposition, often expressed with respect to sovereignty, is that it cannot be alienated: a proposition thus stated by Rousseau: "Je dis que la souveraineté, n'étant que l'exercice de la volonté générale, ne peut jamais s'aliéner" (*Du Contrat social*, 2. 1; Figgis, p. 89).

According to one view, sovereignty is not the distinctive note of a state. Many communities usually regarded as true states do not possess it. There are sovereign and non-sovereign states; international law recognizing both. In the view of many writers sovereignty is not a necessary attribute of a state (Laband, *Das Staatsrecht des deutschen Reiches*, 1. 87; Jellinek, *Die Lehre von den Staatenverbindungen*, p. 37; Meyer, *Lehrbuch des deutschen Staatsrechtes*, p. 5; Ullmann, *Völkerrecht*, 29. See the contrary view presented by Professor Burgess, *Political Science or Constitutional Law*, i. 52; *Political Science Quarterly*, 3. 123; Georges Streit, *Revue de droit international*, 1900, p. 14). Any division or classification of states must be imperfect. The fact is that there may be an indefinite number of what Merignhac (i. 204) terms political "*collectivités secondaires*"; that the attributes summed up in sovereignty may be separated and divided in many ways; that there may be new forms of combinations between states or parts of states; and that their morphology is subject to no hard and fast rules.

The phrase *half sovereign states* was invented by J. J. Moser to describe states possessing some of the attributes of sovereignty. Under this class are grouped very diverse communities. There are states which possess some attributes of sovereignty, but no others; states possessing internal autonomy, but not externally independent; states which are more or less under the influence of others. There are also states which have certain of the attributes of sovereignty, but are subject to servitudes or burthens imposed by treaty, usage,

**Half
Sovereign
States.**

or force. Feudalism had a phraseology to express the varieties of fiefs which existed under it; modern international law has no generally-accepted terminology for the still greater variety of states which now exist. These varieties tend to multiply, and it is difficult to reduce them all to a few types. The theory that states are equal, and possess all the attributes of sovereignty, was never true. It is still more at variance with the facts in these days when a few great states predominate, and when the contact of western states with African and Asiatic states or communities gives rise to relations of dependence falling short of conquest. The division into federations, confederations and alliances is not complete. Jellinek has suggested this classification (*Die Lehre von den Staatenverbindungen*, p. 58): (a) Unorganized associations, including—(1) treaties; (2) occupation of the territory of one state and administration by another, as in Bosnia and Cyprus; (3) alliances; (4) protectorates, guarantees, perpetual neutrality; (5) *Der Staatenstaat*, the feudal state, of which Jellinek gives the Turkish Empire and the old Holy Roman Empire as examples. (b) Organized associations, including—(1) international commissions (*internationale Verwaltungsvereine*, such as international postal and telegraph unions, &c.); (2) the *Staatenbund* or confederation of states; (3) real unions of states as distinguished from personal; (4) the *Bundesstaat* or federal state.¹ Most of the existing varieties may be conveniently ranged in the following classes:—

1. States which have complete independence, complete autonomy, external and internal, and which are recognized in international law as sovereign states.

2. States which have complete external independence, but are more or less subject permanently to other states as to their internal affairs. Of this class there are now few examples. Perhaps, however, such states as permit, permanently or normally, of interference by others on behalf of certain classes of subjects may be so described. The general principle is that a treaty does not detract from sovereignty. As Jellinek expresses it. "Der Staatenvertrag bindet, aber er unterwirft nicht" (*Gesetz und Verordnung*, p. 205); or as Grotius (i. ch. 3, 22, 2) expresses it, "Nec regi aut populo jus demit summi imperii."

3. States which enjoy complete autonomy as to internal affairs, but which are more or less subject to other states as to foreign relations. Some writers would place in this category all states forming part of a true confederacy. It includes states which are united temporarily—cases of inorganic unity, to use Jellinek's expression. It includes also permanent alliances or organic unions. These are some examples:—

a. *Protectorates and Suzerainties*.—The status of certain states, such as Bulgaria and Rumania and the late South African Republic, were peculiar. Even before the independence of the two first-named states, they undoubtedly were for many purposes sovereign.

b. The unions between a superior and inferior state, e.g. the relations of the various states to the old Holy Roman Empire; the relations of the Ottoman Porte to its Christian provinces. In the middle ages the question was often mooted whether states subject to feudal superiors, or the states forming the empire, were sovereign. According to one common definition they were not: a true sovereign state was *universitas quae non superiorem recognoscit*. "Celui est absolument souverain qui ne rien tient après Dieu que de l'espée. S'il tient d'autrui il n'est plus souverain." The prevalent opinion, however, was that sovereignty was compatible with rights such as were possessed by the *Reich* over the princes of Germany; that there might be fiefs held in full sovereignty; and that vassal states, when subject only to "nude vassalage," were sovereign. That was the view of Grotius (i. r. ch. 3, 23, 2), who holds that the *nexus feudalis* is consistent with *summum imperium*.

4. States which have, by treaty or otherwise, parted with some portion of their sovereignty and formed new political units: what Herbert Spencer calls "compound political heads," or, to use Austin's expression, "composite states." The most important examples of this class consist of federal or composite states which by treaty or otherwise have surrendered certain of their powers, or which have created a new state (*Staatenbund*). For many years one of the burning questions in the politics of

the United States was the question whether the individual states of the Union remained sovereign. According to the theory of J. C. Calhoun, the states had entered into an agreement from which they might withdraw if its terms were broken, and they were sovereign. According to the theory expounded in the *Federalist*, the individual states did not, after the formation of the constitution, remain completely sovereign: they were left in possession of certain attributes of sovereignty, while others were lodged in the Federal government; while there existed many states, there was but one sovereign. Even if the origin was a compact or contract, after the "United States" were formed by a "constitutional act" there no longer existed a mere contractual relation: there existed a state to which all were subject, and which all must obey (von Stengel, *Staatenbund und Bundesstaat; Jahrbuch für Gesetzgebung*, 1898, p. 754; Cooley, *Principles of Constitutional Law*, pp. 21, 102). According to Austin: "In the case of a composite state or a supreme federal government, the several united governments of the several united societies together with a government common to these several societies, are jointly sovereign in each of these several societies and also in the larger society arising from the federal union, the several governments of the several united societies are jointly sovereign in each and all" (5th ed., vol. i. p. 258). In point of fact, there are fields of action in which A is sovereign, others in which B is sovereign, and certain others in which A and B are jointly or alternately sovereign. To take the American constitution, for example, the states are sovereign as to some matters, the Federal government as to others.

5. Another division includes anomalous cases, such as Cyprus or Bosnia, in which one government administers a country as to which another state retains certain powers, theoretically large.

6. The territories governed or administered by chartered companies form a class by themselves. Nominally such companies are the delegates of some states; in reality they act as if they were true sovereigns.

7. Two other classes may be mentioned: (a) cases of real union between states, e.g. that between Austria and Hungary; (b) personal unions, distinguished from the above-named forms—for example, the union of Great Britain and Hanover.

8. A small group consists of instances of *condominium* or arrangements similar thereto; for example, the arrangements as to the Samoa Islands from 1889 to 1899.

According to modern usage the appellation "sovereign state" belongs only to states of considerable size and population exercising without control the usual powers of a state, e.g. able to declare peace or war. Leibnitz, discussing this subject in his *Tractatus de jure suprematus* (*Opera*, 4. 362), says: "Itaque valde etiam dubito, an possit Reipublicae illi Italiae, quam vocant Sancti Marini oppidum, concedi suprematus, ^{State of} tametsi jure liberam esse nemo negat," a remark ^{State.} which would apply also to the republic of Andorra: "Illi tantum vocantur souverains ou potentats, qui territorium majus habent, exercitumque educere possunt; atque hoc demum illud est, quod ego voco suprematum, et Gallos quoque arbitror, cum de rebus ad jus gentium spectantibus, pace, bello, foederibus sermo est, et ipsi aliquos vocant souverains, eos non de urbibus liberis loqui, nec exiguorum territoriorum dominis, quae facile dives Mercator sibi emere potest, sed de majoribus illis potestatibus, quae bellum inferre, bellum sustinere, propria quodammodo vi stare, foedera pangere, rebus aliarum gentium cum auctoritate intervenire possunt" (4. 359).

With this view may be compared that of a writer in the *Law Magazine* (1899) xxv. 30, who argues that the republic of San Marino is a state in the full sense.

It is sometimes suggested that self-governing colonies are to be regarded as true states. Undoubtedly some of them can no longer be regarded as colonies in the old sense. The self-governing colonies forming part of the "multi-^{Colonies.}cellular British state," as F. W. Maitland describes it (*Political Theories of the Middle Ages*, p. x.), have an essentially "state-like character." If Liberia is a state, the same may surely be

¹ The distinction between the *Staatenbund* and the *Bundesstaat* is discussed in the articles CONFEDERATION and FEDERAL GOVERNMENT.

said of Canada. It is true the British colonies have not the power of declaring war or peace, or regulating the foreign policy of the empire; and the Crown may disallow a measure passed by the dominion parliament (J. G. Bourinot, *Constitution of Canada*, 1888, p. 75; A. H. F. Lefroy, *Legislative Power in Canada*, 244). Colonial legislatures are said to have delegated powers. It is more accurate to say that as to certain matters the legislature of the Canadian Dominion is sovereign, and as to certain others that it is not (Lefroy, 244; Quick and Garran, *Australian Commonwealth*, 328; Dicey, 106); and as to some matters they are in fact, if not in form, *universitates superiores non recognoscentes* (Quick and Garran, 319); or that they are states in process of making. Occasionally the expression "subject of a colony" is now used (Low v. *Roulledge*, L.R. 1 Ch. 42; Lefroy, *Legislative Power in Canada*, 329). It has been decided by the judicial committee of the Privy Council that the colonial legislatures are not mere delegates of the Imperial parliament (A. B. Keith, *Responsible Government in the Colonies*, p. 81). At all events, the self-governing colonies may be classed as "half sovereign states" or "quasi-sovereign."

Many attempts have been made to enumerate the attributes of sovereignty, *i.e.* the regalia, prerogatives, &c., as they were called. For example, Bodin gives a list of the properties of *majestas* or sovereignty: (a) "Legem universis, &c., singulis civibus dare posse; (b) bellum indicere aut pacem inire; (c) to appoint and change magistrates; (d) power of final appeal; (e) power of pardon; (f) raising revenue; (g) coining money" (*De republica*, vol. i. ch. 10). Leibnitz, with the middle ages in view, divides the attributes or faculties into two classes: *regalia majora* and *regalia minora*. Hobbes (*Leviathan*), analysing these attributes, enumerates twelve attributes. "These," he says, "are the marks which make the essence of sovereignty, and which are the marks whereby a man may discover in what man, or assembly of men, the sovereign power is placed or resideth." He also describes them as "inseparable rights." Bluntschli (*Allgemeine Staatslehre*, i. 575) enumerates these attributes: (a) right of recognition of *majestas*; (b) independence; (c) power to determine constitution; (d) right of legislation; (e) action through deposed organs; (f) irresponsibility. All of these enumerations are open to the objection that they merely describe the action of the state at a particular time, or indicate a theory of what an ideal state should be.

AUTHORITIES.—The literature of the subject is immense; every book on political science, from *Republic* of Plato and the *Politics* of Aristotle, has dealt with or touched sovereignty. A few of the chief modern works are: J. C. Bluntschli, *Allgemeine Staatslehre* (Munich, 1852); Otto Gierke, *Das deutsche Genossenschaftsrecht* (Berlin, 1863–1881); J. Austin, *Lectures on Jurisprudence* (3rd ed., London, 1869); Sir H. Maine, "Minute on the Kāthiāwār States" (1864; printed in *Life and Speeches*, p. 320) and *Early History of Institutions* (1875); P. Laband, *Staatsrecht des deutschen Reiches* (Freiburg-im-Breisgau and Tübingen, 1876); R. von Mohl, *Encyclopädie der Staatswissenschaften* (2nd ed., Tübingen, 1872); O. Gierke, *Johannes Althusius* (Breslau, 1880); G. Jellinek, *Die Lehre von den Staatsverbindungen* (Vienna, 1882); G. Meyer, *Lehrbuch des deutschen Staatsrechts* (Leipzig, 1878); H. Rosin, *Souveränitätsstaat* (1883); K. Gareis, *Allgemeines Staatsrecht* (1882); T. M. Cooley, *Constitutional Limitations* (6th ed., 1890); Jellinek, *Ueber Staatsfragmente* (1896); J. B. Westerkamp, *Staatenbund und Bundesstaat* (Leipzig, 1892); J. R. Green's *Works* (London, 1892); W. W. Fowler, *City State of the Greeks and Romans* (London, 1893); Salomon, *L'Occupation des territoires sans maîtres* (Paris, 1896); A. V. Dicey, *Law of the Constitution* (6th ed., 1902); X. Combotheca, *La Conception juridique de l'état* (1899); H. Rehm, *Allgemeine Staatslehre* (1899); Franklin H. Giddings, *Principles of Sociology* (3rd ed., New York, 1899); J. W. Burgess, *Political Science and Constitutional Law* (Boston, 1899); C. E. Merriam, *History of the Theory of Sovereignty since Rousseau* (New York, 1900); J. Bryce, *Studies in History and Jurisprudence* (2. Essay x. 1901); K. Bornhak, *Einseitige Abhängigkeitsverhältnisse unter den modernen Staaten* (1896); W. W. Willoughby, *The Nature of the State* (New York, 1896); Claus, *Die Lehre von den Staatsdienstbarkeiten* (1894); Bosanquet, *The Philosophical Theory of the State* (1899); J. B. Moore, *Digest of International Law* (Washington, 1906), i. 18 seq.; "Notes on Sovereignty," *American Journal of International Law* (1907), i. 105; W. B. Keith, *Responsible Government in the Colonies* (1909); T. Baty, *International Law* (1909). (J. M.)

SOWAR (Hind. and Pers. *suwar*, a horseman), the name in Anglo-Indian usage for a horse-soldier belonging to the cavalry troops of the native armies of British India and the feudatory states. It is also used more specifically of a mounted orderly, escort or guard.

SOWERBY, JAMES (1757–1822), English natural-history artist, was born in London on the 21st of March 1757. He became a student at the Royal Academy, and subsequently taught drawing, but soon applied his art to the illustration of botanical and conchological works, and became distinguished by the publication of his *English Botany* (36 vols., 1790–1814), and *British Mineralogy* (5 vols., 1804–1817). He likewise planned and carried out for a number of years the classic geological work intended to describe and illustrate the British fossils, and entitled *The Mineral Conchology of Great Britain* (7 vols., 1812–1846). This was issued in parts, with the assistance first of his elder son, J. de C. Sowerby, and, after J. Sowerby's death (Oct. 25, 1822), of his second son, G. B. Sowerby, both the sons being themselves expert palaeontologists. The Sowerby collection, consisting of about 5000 fossils, was purchased by the British Museum in 1860.

The elder son, JAMES DE CARLE SOWERBY (1787–1871), was in 1838 one of the founders of the Royal Botanic Society, and was its secretary for thirty years. He supplied the plates and part of the text to the *Supplement to English Botany* (4 vols., 1831–1849); but his most important work related to palaeontology, as he identified and in many cases described the invertebrate fossils for papers by Buckland, Sedgwick, Fitton, Murchison and others in the *Transactions of the Geological Society of London*.

The younger son, GEORGE BRETtingham SOWERBY (1788–1854) was author of *The Genera of Recent and Fossil Shells* (1820–1825), and one of the editors of the *Zoological Journal* (1825–1826). His son, G. B. SOWERBY (1812–1884), author of the *Conchological Manual* (1839; 4th ed., 1852), and grandson G. B. SOWERBY (b. 1843), a distinguished student of the Mollusca, inherited the family talent for natural history.

SOWERBY BRIDGE, an urban district in the Sowerby parliamentary division of the West Riding of Yorkshire, England, 3 m. S.W. of Halifax by the Lancashire & Yorkshire railway. It is situated on both sides of the river Calder, at the termination of the Rochdale canal. Christ Church, dating from 1526, was rebuilt in 1819. The town is almost entirely a growth of the second half of the 19th century. It possesses worsted and cotton mills, iron works, dye works and chemical works. The separate urban district of Sowerby adjoins to the south-west. Pop. (1901), Sowerby Bridge, 11,477; Sowerby, 3653.

SOWING (from "to sow," O. Eng. *sāwan*, cf. Du. *zaaijen*, Ger. *säen*, &c.; the root is seen in Lat. *serere*, cf. "seed"), in agriculture, the planting of seed for the raising of crops. The scattering of seed by hand is the simplest and oldest method of delivering seed to the earth, and is still preferred by some farmers and in certain circumstances. The sower carries the receptacle for the seed, a zinc "seed-lip," seed-sheet or basket, slung over his shoulder, and walking up and down the ridges of the field scatters handfuls of grain with a semicircular sweep of the arm across the body. The "casts" must not overlap too much, the seed must not fall more thickly at one point of the cast than at another, and the standard of seeding per acre must be rigidly adhered to; hence manual-sowing demands considerable skill and experience. It is still preferred in some districts for the sowing of corn crops; and in some cases the plough is followed by a furrow-presser, the seed falling into the hollows made by it, though under ordinary circumstances the face of the field as left in "seams" by the furrow-slices from the plough is in a suitable condition for broadcasting. So well, indeed, is the ploughing done in many countries that broadcasting gives perfectly good results, and broadcasting machines reaching up to 15 ft. wide are in common use in place of hand-sowing, as these get over the ground more quickly and deposit the seed more regularly than an ordinary workman does by hand.

It was long recognized that the precision which is of the essence of good sowing could be better attained by mechanical means, and as early as 1662 a sowing-machine was invented by Joseph Locatelli in Carinthia. In England the early history of mechanical sowing is chiefly connected with the name of Jethro Tull, who about 1730 invented the corn-drill.¹ Cooke's drill brought out in 1783 was the definite precursor of the modern drill. The drill, besides depositing the seed at a uniform depth, sows it in parallel rows at equal distances from one another and thus makes possible the use of the horse hoe and facilitates the suppression of weeds amongst growing crops, the latter advantage being specially marked in the case of root crops. The "cup-feed" and the "force-feed" are the commonest and most generally useful types. The cup-drill consists of a long box carried upon wheels and divided diagonally into two sections by a partition. The forward section contains the seed which drops through apertures, the size of which can be regulated by slides, to the bottom section. A spindle geared to the ground-wheels by cogs passes longitudinally through the centre of this section and carries disks, round the rims of which are fitted small cups. As the horses pull the drill forward, the spindle and disks revolve and the cups scoop up the seed and pour it into the funnels; thence it proceeds down a series of tubes or "spouts" and drops into shallow furrows traced by small coulters travelling immediately in front of the streams of seed. The coulters can be raised or lowered by levers and are kept down to their work by weights or pressers, which can be regulated according as deep or shallow sowing is required.

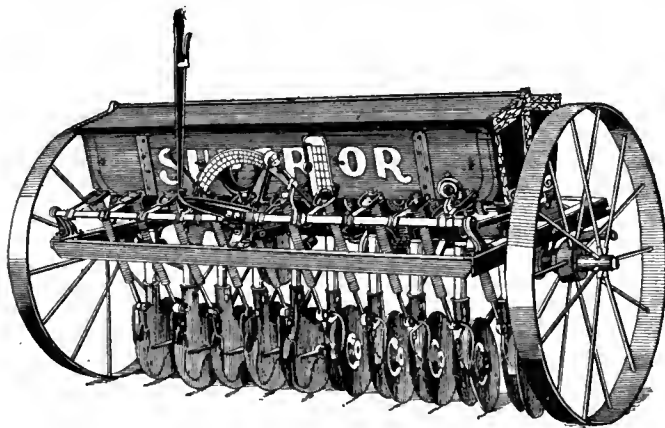

FIG. 1.—Rear view of Corn and Fertilizer Single Disk Drill.

In the force-feed type of drill the seed falls through apertures in the bottom of the seed-hopper into funnels, through which extends a shaft carrying bowl-shaped wheels, one for each (fig. 1). These

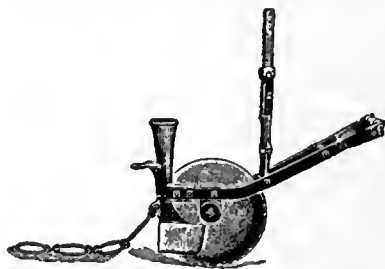

FIG. 2.—Disk Coulter.

hopper and the kind of crop being sown.

Liquid-manure drills distribute chemical manure mixed with water and are often fitted with a seed-box for root seeds, the manure and the seed being deposited through the same spout. Drills are also made in which dry fertilizers may be deposited with the seed in a similar manner.

The wheelbarrow seeder, a long box pierced with openings and carried transversely on a skeleton wheelbarrow, is used for sowing grass seed.

¹The machine devised by Josiah Worlidge about 1669 was ineffective in practice and differed totally in structure from that of Tull.

In the United States the maize or Indian-corn crop exceeds all others in value, and machines used in planting and handling this crop are of great importance. Corn (maize) is sometimes listed or planted in a continuous row like wheat, and for this purpose a machine known as a lister is employed.

In its general construction this machine is a sulky plough, having a double mould-board, which turns the furrow in both directions. Immediately behind the plough is a sub-soiler for deepening the furrow and penetrating to the moist soil below the surface. A seed-box is mounted on the plough beam, and is provided with a feed-plate operated by a shaft geared to one of the wheels. The seed is

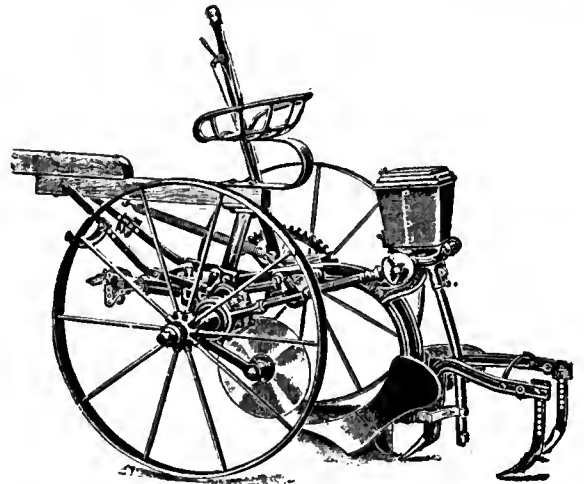

FIG. 3.—Maize Lister.

delivered to the furrow in rear of the mould-boards and covered by two shovels fixed behind which turn the soil back into the furrow.

It is, however, more common to plant maize in hills, which are spaced equally from each other and form rows in both directions, so that a cultivator may be driven between them. This work is done by a machine called a check-row corn planter.

In using the corn planter, a wire, having buttons attached thereto, at intervals corresponding to the distance between the hills, is first stretched across the field and anchored at its ends. This wire is then placed upon the guide rollers at the side of the machine and passes between the jaws of a forked lever, which is connected at its other end with a rock-shaft passing across the machine and serving to oscillate a feed-plate in the bottom of each seed-hopper. As the buttons on the check-wire strike the forked lever, the latter is drawn to the rear and causes the feed-plate to drop the seed through the tubes into the open space between the plates of the furrowing shoe. A reel at the rear of the machine is used to take up the check-wire as the planter progresses.

In another corn planter the check-wire is dispensed with, and the machine is provided with a shaft carrying two reels, the blades of which are at a distance apart equal to the distance between the hills of corn, and thus measure the intervals at which the corn is to be dropped. A rod, extending from the side of the machine, and carrying a small wheel, marks the next row and serves as a guide to the driver.

See J. B. Davidson and L. W. Chase, *Farm Machinery and Farm Motors*, p. 132 (New York, 1908).

SOYER, ALEXIS BENOÎT (1809-1858), French culinary artist, was born at Meaux-en-Brie, France, in October 1809. After five years' apprenticeship as a cook near Versailles, he was engaged by a well-known Paris restaurateur, and soon became chief cook. Leaving France at the revolution of 1830, he went to London and joined his brother in the kitchen of the duke of Cambridge. Subsequently he was cook in several noblemen's kitchens, and in 1837 was made chef to the Reform Club, London. In 1847, having written several letters to the press on the famine in Ireland, he was commissioned by the government to establish kitchens in Dublin. In 1850 he resigned his position at the Reform Club, and the following year opened Gore House, Kensington, as a restaurant, but this venture did not prove a success. In 1855 he offered, through the medium of *The Times*, to proceed at his own expense to the Crimea and advise on the cooking for the British army there. His services were accepted by the government. On returning from the front he lectured at the United Service Institution on cooking for the services, and reformed the dietary of the military hospitals, and of the emigration commissioners. He

died in London on the 5th of August 1858. Soyer was the inventor of an army cooking wagon, and the author of a variety of cookery books. His wife, Elizabeth Emma Soyer, achieved considerable popularity as a painter, chiefly of portraits.

SOZOMEN, the name of a famous 5th-century church historian. Hermias Salamanes (Salaminus) Sozomenus (c. 400–443) came of a wealthy family of Palestine, and it is exceedingly probable that he himself was born and brought up there—in Gaza or the neighbourhood. What he has to tell us of the history of South Palestine was derived from oral tradition. His grandfather, he tells us, lived at Bethel, near Gaza, and became a Christian, probably under Constantius, through the influence of Hilarion, who had miraculously healed an acquaintance of the grandfather, one Alaphion. Both men with their families became zealous Christians. The historian's grandfather became within his own circle a highly esteemed interpreter of Scripture, and held fast his profession even in the time of Julian. The descendants of the wealthy Alaphion founded churches and convents in the district, and were particularly active in promoting monasticism. Sozomen himself had conversed with one of these, a very old man. He tells us that he was brought up under monkish influences and his history bears him out. As a man he retained the impressions of his youth, and his great work was to be also a monument of his reverence for the monks in general and for the disciples of Hilarion in particular. After studying law in Beirut he settled down as an advocate in Constantinople, where he wrote his *Εκκλησιαστικὴ Ἱστορία* about the year 440. The nine books of which it is composed begin with Constantine (323) and come down to the death of Honorius (423); but according to his own statement he intended to continue it as far as the year 439 (see the Dedication of the work). From Sozomen himself (iv. 17), and statements of his exceptors Nicephorus and Theophanes, it can be made out that the work did actually come down to that year, and that consequently it has reached us only in a mutilated condition, at least half a book being wanting (Güldenpenning, *Theodoros von Kyrrhos*, p. 12 seq., holds that Sozomen himself suppressed the end of his work). A flattering and bombastic dedication to Theodosius II. is prefixed. When compared with the history of the ecclesiastical historian Socrates (*q.v.*), it is plainly seen to be a plagiarism from that work, and that on a large scale. Some three-fourths of the materials, essentially in the same arrangement, have been appropriated from his predecessor without his being named, the other sources to which Sozomen was indebted being expressly cited. But it is to his credit that he has been himself at the trouble to refer to the principal sources used by Socrates (Rufinus, Eusebius, Athanasius, Sabinus, the collections of epistles, Palladius), and has not unfrequently supplemented Socrates from them; and also that he has used some new authorities, in particular sources relating to Christianity in Persia and to the history of Arianism, monkish histories, the *Vita Martini* of Sulpicius, and works of Hilarius. The whole of the ninth book is drawn from Olympiodorus.

It is probable that Sozomen did not approve of Socrates's freer attitude towards Greek science, and that he wished to present a picture in which the clergy should be still further glorified and monasticism brought into still stronger prominence. In Sozomen everything is a shade more ecclesiastical—but only a shade—than in Socrates. Perhaps also he wrote for the monks in Palestine, and could be sure that the work of his predecessor would not be known.

Sozomen is an inferior Socrates. What in Socrates still betrays some vestiges of historical sense, his moderation, his reserve in questions of dogma, his impartiality—all this is wanting in Sozomen. In many cases he has repeated the exact words of Socrates, but with him they have passed almost into mere phrases. The chronological scrupulosity of the earlier writer has made no impression on his follower; he has either wholly omitted or inaccurately repeated the chronological data. He writes more wordily and diffusely. In his characterizations of persons, borrowed from Socrates, he is more dull and colourless. After Socrates he has indeed repeated the caution not to be too rash in discerning the finger of God; but his way of looking at things is throughout mean and rustic. Two

souls inhabit his book; one, the better, is borrowed from Socrates; another, the worse, is his own. Evidence of a boundless credulity with regard to all sorts of monkish fables is to be met with everywhere. It must, however, be noted that for the period from Theodosius I. onward he has emancipated himself more fully from Socrates and has followed Olympiodorus in part, partly also oral tradition; and here his statements possess greater value.

Sozomen also wrote an *Epitome of History* from the Ascension of Christ to the defeat of Licinius (323) which is not now extant (see his *History*, i. 1).

For bibliography see the article on the church historian, **SOCRATES**. Most of the editions and discussions named there cover Sozomen as well (the volume of Hussey's edition containing Sozomen appeared in 1860). The latest English translation, revised by Hartranft, is published in the Nicene and Post-Nicene Fathers, 2nd series, vol. ii. In addition see Nolte in the *Tübing. Quartalschr.* (1861), p. 417 sqq.; C. de Boor, "Zur Kenntniss der Handschriften der Griech. Kirchengeschichte," in *Zeitschrift für Kirchengeschichte*, vi. 478 sqq.; Sarrazin, "De Sozomeni historia num integra sit," in the *Commentationes philologae jenenses*, i. 165 sqq.; Rosenstein, "Krit. Untersuchungen über d. Verhältniss zwischen Olympiodor, Zosimus und Sozomen," in *Forsch. z. deutschen Gesch.*, vol. i.; Batiffol, "Sozomène et Sabinos," in *Byzant. Zeitschr.* vii. 265 sqq. (A. HA.; A. C. MCG.)

SPA, a town of Belgium, lying less than 20 m. S.E. of Liège and in the same province, famous for its mineral springs, which are reputed to be the oldest known in Europe, having been first discovered in 1326. They are supposed to have given the common name of "spa" to such resorts. The town is situated 850 ft. above sea-level and the heights above the valley reach 1100 ft. In the 18th century it was the most fashionable resort in Europe for the medicinal use of such waters, being visited by Peter the Great of Russia, Gustavus III. of Sweden, and Joseph II. of Austria. In 1807 much of the town was burned down, while the principal buildings, the Casino and the Pouhon, are quite modern. Spa has not held its own with its many French and German rivals, but it still attracts about 20,000 visitors annually. Pop. (1904), 7759.

SPACE AND TIME, in philosophy. The metaphysical problems connected with Space and Time are so similar and have been so closely conjoined in the history of thought that they may well be treated together. They are clearly distinguishable from the psychological, which relate to the modes whereby our spatial and temporal conceptions have been formed and to the analysis of the materials of which they are composed (see **PSYCHOLOGY**). In an exhaustive treatment of Space and Time by far the largest share of the work rests with the psychologist. The business of the metaphysician is to determine what reality outside our minds corresponds to our temporal and spatial conceptions.

The first tendency of thought is to treat Space and Time as having objective existence in the same way as the ordinary things that compose our world, and this we may call the *objective* method. Simple as it appears to be, it discloses formidable difficulties, which may be illustrated by a consideration of Newton's famous account of "absolute, true and mathematical time" as something which "in itself and from its own nature flows equally" and with no liability to change. Now, if mathematical time as thus described is merely an abstraction used to facilitate mathematical calculations, no objection can be taken to it. But if Newton meant to assert that Time is a flowing stream no less actual than the Thames, his assertion is open to fatal objections. All admittedly real streams, such as the Thames, have a definite beginning and an ending. But where is the source of Time and where is its outlet? Every real stream has boundaries at its sides. What are the boundaries of Time? Every real stream has certain definite qualities: water is rather heavy and translucent, and produces certain effects upon bodies plunged into it. What are the specific qualities of Time? How are things in time affected by their immersion in time so as to be different from things not in time? And if it be asserted that time has such specific qualities, by what senses do we perceive them? We may fairly assume that none of these questions can be answered intelligibly by one who holds the Newtonian position. And thus we are justified in the conclusion that time is not a real

stream at all, but something which is said to behave like a stream only in some metaphorical sense. Similar difficulties arise if we try to attribute a like objective reality to Space. We can imagine no boundaries to Space; it seems to have no active specific qualities and we have no sense-organ for perceiving it.

The thinkers of antiquity saw these difficulties without solving them. Their whole treatment of philosophic problems was objective; and, so long as Space and Time are treated objectively, not much can be done with them. Plato has great difficulty in explaining the relation between Space and his Ideas: Aristotle contents himself with defining space as "the first unmoved limit of the containing body," a definition which helps us very little: nor do we get more light from later Greek philosophy. As to Time, there was always a tendency in Greek thought to treat it as in some sense unreal. Time was seen to be intimately connected with change, and it was just their liability to change that made ordinary mundane things unreal, as contrasted with the unchanging steadfastness of the Platonic Ideas. And the pantheistic One-and-All of Plotinus is plainly incompatible with the reality of Time. In all pantheistic systems Time belongs to mundane existence and Eternity to the transcendent Reality.

Modern philosophy is distinguished from ancient mainly by its greater subjectivity; and thus it was not long after the rise of modern philosophy that thinkers began to turn to the *subjective* method of explaining Space and Time, that is, to regard them as real only to our minds. Its use begins effectively with Berkeley, though prepared for to some extent by earlier writers such as Hobbes. Berkeley's treatment is most definitely clear in the case of Space; for his attack upon materialism made it necessary for him to affirm the ideality of Space as well as of Matter. But he takes a similar line of argument with Time, declaring it to be nothing but the succession of ideas. The merit of the subjective method was that it made men see the importance of psychology. If Space and Time exist only in the human mind we must analyse the human mind to explain them. The work of the English psychologists such as the Mills and Bain attaches itself to subjectivist principles.

A distinct epoch in the history of the subject was made by the work of Kant, whose solution of the problems may be classed as *transcendental*. He argued that Space and Time are not given by experience, but are rather conditions of all our experience, being in his terminology *a priori*, that is, supplied by the mind from its own inward resources. They do not belong to things-in-themselves, but to things-as-we-know-them, or phenomena. Their validity consists in the fact that all men have them and that they are absolutely necessary conditions of human intelligence. As he expresses it from his peculiar point of view, Space is the form of outer sense, Time of inner sense.

The prevalence of German philosophy in Great Britain during the last quarter of the 19th century has given these Kantian principles a great currency, interrupting the more truly characteristic psychological tendency of British thought. That prevalence is now passing away. No one now holds the full Kantian position; which, in the case of Space, is refuted by the simple consideration that our spatial conceptions depend upon our sensuous perceptive powers; and that, consequently, the spatial conceptions of the blind, for example, are quite different from those of ordinary men. If Kant is right, and Space is a pure form unaffected by all specific differences of content, it would follow that a man born with one sense only, say that of taste, would have the same space-conception as the rest of us; a conclusion too plainly absurd to need refutation. What an *a priori* can still maintain is that in our conception of Space and Time there are elements which cannot be explained by the psychologist as having developed out of anything else, and must therefore be regarded as innate endowments of the mind. This is a position not unreasonable in itself, and one, at least, which does not interfere with the detailed work of the psychologist.

The way with these problems which commends itself to the

present writer and seems fully in harmony with the general tone of contemporary thinking may, if a distinctive catchword be desired, be termed the *humanist* method. By this is meant that the study of the human mind comes first; that we put no metaphysical questions till we have learnt what the psychologist has to teach us; and that in our explanations of metaphysical realities we should be as anthropomorphic as possible. In the case of Space this leads to a result which is largely negative. When we ask what objective reality corresponds to our conception of Space, the answer must be analogous to that which we give respecting the various sensible qualities of the external world. We cannot suppose that Colour, for example, exists objectively as we experience it; evidently it is altogether relative to the organs of vision which we happen to possess. But we must believe that the objective world has a quality in some way correspondent to the quality of Colour. So with Space. Space as we know it is altogether relative to our tactual, muscular and visual powers of perception. But the fact that our spatial perceptions and conceptions enable us to deal successfully with objects requires us to believe that the objective world has an arrangement of its own corresponding in some way to spatial arrangement, though we are unable to imagine what it can be. Space cannot be objectively real, because of the difficulties disclosed above in the criticism of the "objective" method, and we are unable to put anything definite in its place. With Time the case is somewhat different. Our conception of Time is based on our experience of Change, combined with memory and anticipation. Now Change is an experience which we feel directly in our personal consciousness: consciousness is not spatial, but it is mutable. This direct experience is a guarantee of the realness of Change, and justifies us in attributing it in some degree to ultimate objective reality.

See S. H. Hodgson, *Space and Time*; H. Bergson, *Essai sur les données immédiates de la conscience*; J. E. MacTaggart, *Studies in the Hegelian Dialectic*. (H. ST.)

SPADE, a tool for digging and loosening the soil; together with the fork it forms one of the chief implements wielded by the hand in agriculture and horticulture. Its typical shape is a broad flat blade of iron with a sharp lower edge, straight or curved, the upper edge on either side of the handle affording space for the foot of the digger, which drives it into the ground; the wooden handle terminates in a cross-piece, usually forming a kind of loop for the hand. The word in O.Eng. is *spædu*, cognate forms being Du. and Dan. *spade*, Ger. *Spaten*; it is derived from the Gr. *σπάθη*, a broad blade of wood or metal, and so used of the blade of an oar or sword. This was latinized as *spatha*, and used of a broad paddle for stirring liquid, of a piece of wood used by weavers for driving home the woof, and particularly of a broad two-edged sword without a point. The Spanish playing cards had "swords" for the suit which we know as "spades," and the suit was called *espada* (see CARDS, PLAYING).

SPAGNA, LO (d. -c. 1529), the usual designation (due to his Spanish origin) of the Italian painter Giovanni di Pietro, one of the chief followers of Perugino. The famous "Sposalizio"—marriage of Joseph and Mary—in the Caen museum, formerly attributed to Perugino (*q.v.*), is now credited to Lo Spagna. Nothing whatever is known of his early life, or how he became a member of the Perugian school. There is a marked absence of individuality about his style, which seems like an imitation of the earliest manner of Raphael and that of Pinturicchio in a weaker and less virile form. The chief of his numerous panel paintings are the "Nativity," in the Vatican, and the "Adoration of the Magi," at Berlin. In 1510 Lo Spagna executed many frescoes at Todi, and in 1512 several other mural paintings in and near Trevi. His most important works were frescoes at Assisi and Spoleto, of which some exist in good preservation. He received the freedom of the city of Spoleto in 1516, as a reward for his work there. Lo Spagna's frescoes reach a much higher standard of merit than his panel pictures. The museum of the Capitol in Rome now possesses a very beautiful series of life-sized fresco figures by him, representing Apollo and the:

Nine Muses. Lo Spagna was alive in 1528, but he appears to have died before 1530, as in that year a pupil of his named Doni completed a fresco in S. Jacopo, near Spoleto, which Lo Spagna had begun.

SPAHIS (in Persian *Sipari*, meaning warriors, and synonymous with *Sepoy*) originally the holders of fiefs in Central Asia who yielded personal military service to their superior chief. In time the term came to be applied to the soldiery furnished in their own stead. A similar institution existed in Turkey, and the "Spahis" were the light irregular cavalry which from the time of Sultan Amurath I. (1326) down to the beginning of the 19th century formed the flower of the Turkish army; at one period they are estimated to have numbered 130,000. "Spahis" is the term now applied to certain native cavalry regiments in Algiers and Tunis, officered by Frenchmen.

SPAIN (*España*), a kingdom in the extreme south-west of Europe, comprising about eleven-thirteenths of the Iberian Peninsula, in addition to the Balearic Islands, the Canary Islands, and the fortified station of Ceuta, on the Moroccan coast opposite to Gibraltar. Each of the two island groups forms one of the forty-nine provinces of the kingdom, although only the first named belongs geographically to Spain. Ceuta is included in the province of Cadiz. In 1900 the kingdom (exclusive of its colonies) had a population of 18,607,674, and a total area of 194,700 sq. m. It is thus rather more than twice the size of Great Britain, nearly 50,000 sq. m. larger than Japan, and nearly 85,000 sq. m. larger than Italy and Sicily. Exclusive of the Canaries its area is 101,893 sq. m. On all sides except that of Portugal the boundaries of continental Spain are natural, the Peninsula being separated from France by the Pyrenees and on every other side being surrounded by the sea. On the side of Portugal a tract of inhospitable country led originally to the separation between the two kingdoms, inasmuch as it caused the reconquest of the comparatively populous maritime tracts from the Moors to be carried out independently of that of the eastern kingdoms, which were also well peopled. The absence of any such means of intercommunication as navigable rivers afford has favoured the continuance of this isolation. The precise line of the western frontier is formed for a considerable length by portions of the chief rivers or by small tributaries, and on the north (between Portugal and Galicia) it is determined to a large extent by small mountain ranges. The British rock of Gibraltar, in the extreme south of the peninsula, is separated from Spain by a low isthmus known as the Neutral Ground.

By the relinquishment of Cuba and the cession of Porto Rico, the Philippine and Sulu Islands, and Guam, the largest of the **Colonial Possessions** of the war of 1898, and of the remaining Ladrone or Marianne Islands, together with the Caroline and Pelew Islands, to Germany by a treaty of the 8th of February 1899, the colonial possessions of Spain were greatly reduced. Apart from Ceuta, Spain possesses on the Moroccan seaboard Melilla, Alhucemas, Peñon de la Gomera, Ifni, and the Chaffarinas islets. Besides these isolated posts Spain holds Rio de Oro, a stretch of the Saharan coast, and its hinterland lying between Morocco and French West Africa; the Muni River Settlements or Spanish Guinea, situated between French Congo and the German colony of Cameroon; Fernando Po, Annobon, Corisco and other islands in the Gulf of Guinea. Spain has given to France the right of pre-emption over any of her West African colonies.

I.—GENERAL SURVEY OF THE SPANISH KINGDOM

Physical Features.—The coast-line on the north and north-west is everywhere steep and rocky. On the north there are numerous small indentations, many of which form convenient harbours, although the current flowing along the coast from the west often leaves in the stiller water at their mouths obstruction bars. The best harbours are to be found on the *rias* or fjord-like indentations in the W. and N. of Galicia, where high tides keep the inlets well scoured;

here occur the fine natural harbours of Pontevedra and Vigo, Corunna and Ferrol. Less varied in outline but more varied in character are the Spanish coasts on the south and east. The seaboard is generally flat from the frontier of Portugal to the Straits of Gibraltar. Between the mouth of the Rio Tinto and that of the Guadalquivir the shore is lined by a series of sand-dunes, known as the Arenas Gordas. Next follows a marshy tract at the mouth of the Guadalquivir known as Las Marismas, after which the coast-line becomes more varied, and includes the fine Bay of Cadiz. From the Straits of Gibraltar a bold and rocky coast continues almost to Cape Palos, a little beyond the fine natural harbour of Cartagena. North of Cape Palos a line of flat coast, beginning with the narrow strip which cuts off the lagoon called the Mar Menor from the Mediterranean, bounds half of the province of Alicante, but in its northern half this province, becoming mountainous, runs out to the lofty headland of Cape de la Nao. The whole coast of the Bay of Valencia is low and ill provided with harbours; and along the east of Catalonia stretches of steep and rocky coast alternate with others of an opposite character.

The surface of Spain is remarkable at once for its striking contrasts and its vast expanses of dreary uniformity. There are mountains rising with alpine grandeur above the snow-line, but often sheltering rich and magnificent valleys at their base. Naked walls of white limestone tower above dark woods of cork-oak and olive. In other parts, as in the Basque country, in Galicia, in the Serrania de Cuenca (between the headwaters of the Tagus and those of the Júcar), in the Sierra de Albarracin (between the headwaters of the Tagus and those of the Guadalquivir), there are extensive tracts of undulating forest-clad hill country, and almost contiguous to these there are apparently boundless plains, or tracts of level table-land, some almost uninhabitable, and some streaked with irrigation canals and richly cultivated—like the Requena of Valencia. While, again, continuous mountain ranges and broad plains and table-lands give the prevailing character to the scenery, there are, on the one hand, lofty isolated peaks, such as Monseny, Montserrat (*q.v.*) and Mont Sant in Catalonia, the Peña Golosa in Valencia, Moncayo on the borders of Aragon and Old Castile, and, on the other hand, small secluded valleys, such as those of Vich and Olot among the Catalanian Pyrenees.

The greater part of the interior of Spain is composed of a table-land bounded by the Cantabrian Mountains in the north and the Sierra Morena in the south, and divided into two by a series of mountain ranges stretching on the whole from east to west. The northern half of the table-land, made up of the provinces of Leon and Old Castile, has an average elevation estimated at about 2700 ft., while the southern half, made up of Estremadura and New Castile, is slightly lower—about 2600 ft. On all sides the table-land as a whole is remarkably isolated, and hence the passes on its boundary and the river valleys that lead down from it to the surrounding plains are geographical features of peculiar importance. The isolation on the side of Portugal has already been mentioned. On the north-west the valley of the Sil and a series of valleys farther south, along both of which military roads have been carried from an early period, open up communication between Leon and the hill country of Galicia, which explains why this province was united to Leon even before the conquest of Portugal from the Moors. The passes across the Cantabrian Mountains in the north are tolerably numerous, and several of them are crossed by railways. The two most remarkable are the Pass of Pájares, across which winds the railway from Leon to Oviedo and the seaport of Gijón, and that of Reinosa leading down to the deep valley of the Besaya, and crossed by the railway from Valladolid to Santander. In its eastern section the chain is crossed by the railways from Burgos to Bilbao and San Sebastian; the last-named line winds through the wild and romantic gorge of Pancorbo (in the north-east of the province of Burgos) before it traverses the Cantabrian chain at Idiazabal.

On the north-east and east, where the edge of the table-land sweeps round in a wide curve, the surface sinks in broad terraces to the valley of the Ebro and the Bay of Valencia, and is crowned by more or less isolated mountains, some of which have been already mentioned. On the north-east, by far the most important communication with the Ebro valley is formed by the valley of the Jalon, which has thus always formed a military route of the highest consequence, and is now traversed by the railway from Madrid to Saragossa. Farther south the mountains clustered on the east of the table-land (Sierra de Albarracin, Serrania de Cuenca) long rendered direct communication between Valencia and Madrid extremely difficult, and the principal communications with the east and south-east are effected where the southern table-land of La Mancha (*q.v.*) merges in the hill country which connects the interior of Spain with the Sierra Nevada.

In the south the descent from the table-land to the valley of the Guadalquivir is again comparatively gradual, but even here in the eastern half of the Sierra Morena the passes are few, the most

important being the Puerto de Despeñaperros, where the Rio Magaña, a sub-tributary of the Guadalimar, has cut for itself a deep gorge through which the railway ascends from Andalusia to Madrid. Between Andalusia and Estremadura farther west the communication is freer, the Sierra Morena being broken up into series of small chains.

Of the mountains belonging to the table-land the most continuous are those of the Cantabrian chain, which stretches for the most part from east to west, parallel to the Bay of Biscay, but ultimately bends round towards the south between Leon and Galicia (see CANTABRIAN MOUNTAINS). A peculiar feature of this chain, and of the neighbouring parts of the table-land, is the number of the *parameras* or isolated plateaus, surrounded by steep rocky mountains, or even by walls of sheer cliff. The bleak districts of Sigüenza and Soria, round the headwaters of the Douro, separate the mountains of the so-called Iberian system on the north-east of the table-land from the eastern portion of the central mountain chains of the peninsula. Of these chains, to which Spanish geographers give the name Carpetano-Vetonica, the most easterly is the Sierra de Guadarrama, the general trend of which is from south-west to north-east. It is the Montes Carpetani of the ancients, and a portion of it (due north of Madrid) still bears the name of Carpetanos. Composed almost entirely of granite, it has an aspect when seen from a distance highly characteristic of the mountains of the Iberian Peninsula in general, presenting the appearance of a saw-like ridge (*sierra*) broken up into numerous sections. Its mean height is about 5250 ft., and near its centre it has three summits, the highest (named the Pico de Peñalara) rising to a height of 6910 ft. The chief passes across the Sierra are those of Somosierra (4692 ft.) in the north-east, Navacerrada (5837 ft.), near Peñalara, and Guadarrama (5010 ft.), a few miles farther south and west; these are crossed by carriage roads. The railway from Madrid to Segovia passes through a tunnel close to the Guadarrama Pass; and the railway from Madrid to Ávila traverses the south-western portion of the range through a remarkable series of tunnels and cuttings.

A region with a highly irregular surface, filled with hills and *parameras*, separates the Sierra de Guadarrama from the Sierra de Gredos farther west. This is the loftiest and grandest sierra in the whole series. Its culminating point, the Plaza de Almanzor, attains the height of 8730 ft., not far short of that of the highest Cantabrian summits. Its general trend is east and west; towards the south it sinks precipitously, and on the north it descends with a somewhat more gentle slope towards the longitudinal valleys of the Tormes and Alberche which separate it from another rugged mountain range, forming the southern boundary of the *paramera* of Ávila. On the west another rough and hilly tract, similar to that which divides it from the Sierra de Guadarrama in the east, separates it from the Sierra de Gata, the westernmost and the lowest of the Spanish sierras belonging to the series. These hilly intervals between the more continuous sierras greatly facilitate the communication between the northern and southern halves of the Spanish table-land. The Sierra de Gredos has a road across it connecting Ávila with Talavera de la Reina by the Puerto del Pico; but for the most part there are only bridle-paths across the Gredos and Gata ranges, and no railway crosses either of them, although the line from Plasencia to Salamanca skirts the Sierra de Gredos on the west. The Serra da Estrela, in Portugal, is usually regarded as a fourth section in the Carpetano-Vetonica chain.

On the southern half of the table-land a shorter series of sierras, consisting of the Montes de Toledo in the east (highest elevation Tejadillas, 4567 ft.) and the sierras of San Pedro, Montánchez and Guadalupe in the west (highest elevation Cabeza del Moro, 5100 ft.), separates the basins of the Tagus and Guadiana. The southern system of mountains bounding the Iberian table-land—the Sierra Morena (*q.v.*)—is even less of a continuous chain than the two systems last described. As already intimated, its least continuous portion is in the west. In the east and middle portion it is composed of a countless number of irregularly-disposed undulating mountains all nearly equal in height.

Even more important than the mountains bounding or crossing the table-land are those which are connected with it only at their extremities; viz. the Pyrenees (*q.v.*) in the north-east, the Sierra Nevada (*q.v.*) and the coast ranges in the south. The transverse valleys of the Sierra Nevada open southwards into the mountainous longitudinal valleys of the Alpujarras (*q.v.*), into which open also on the other side the transverse valleys from the most easterly of the coast sierras, the Sierra Contraviesa and the Sierra de Almirajá. These ranges are continued farther west by the Sierra de Alhama and Sierra de Abdalajiz. Immediately to the west of the last-named sierra is the gorge of the Guadalhorca, which affords a passage for the railway from Malaga to Cordova; and beyond that gorge, to the west and south-west, the Serrania de Ronda, a mountain group difficult of access, stretches out its sierras in all directions. To Spanish geographers the coast ranges just mentioned are known collectively as the Sierra Penibética. Although not comparable in altitude with the Pyrenees (highest summit Aneto, 11,168 ft.) or the Sierra Nevada (highest summit Mulhacen, 11,421 ft.), the coast ranges frequently attain an elevation of over 5000 ft., and in some cases of over 6000 ft. North-east of the Sierra Nevada two small

ranges, Alcaraz and La Sagra, rise with remarkable abruptness from the plateau of Murcia, where it merges in that of the interior.

The only two important lowland valleys of Spain are those of the Ebro and the Guadalquivir. The Ebro valley occupies the angle in the north-east between the Pyrenees and the central table-land, and is divided by ranges of heights proceeding on the one side from the Pyrenees, on the other from the base of the Moncayo, into two portions. The uppermost of these, a plateau of between 1000 and 1300 ft. above sea-level, is only about one-fourth of the size of the remaining portion, which is chiefly lowland, but is cut off from the coast by a highland tract connecting the interior table-land with spurs from the Pyrenees. The Guadalquivir basin is likewise divided by the configuration of the ground into a small upper portion of considerable elevation and a much larger lower portion mainly lowland, the latter composed from Seville downwards of a perfectly level and to a large extent unhealthy alluvium (*Las Marismas*). The division between these two sections is indicated by the change in the course of the main stream from a due westerly to a more south-westerly direction.

The main water-parting of the Peninsula is everywhere near the edge of the table-land on the north, east and south, and hence describes a semicircle with the convexity to the east. There are five great rivers in the Peninsula, the Tagus (*Rivers and Lakes.* Spanish *Tajo*, Portuguese *Tejo*), Douro (Spanish *Duero*), Ebro, Guadiana and Guadalquivir, all of which rise in Spain. The Ebro alone flows into the Mediterranean, and the Ebro and Guadalquivir alone belong wholly to Spain; the lower courses of the Tagus and Douro are bounded by Portuguese territory; and the lower Guadiana flows partly through Portugal, partly along the frontier. The Tagus rises in the Montes Universales on the borders of Teruel, and flows in a westerly direction until it enters the Atlantic below Lisbon, after a total course of 565 m. The Douro (485 m.) and the Ebro (466 m.) flow respectively south-west to the Atlantic at Oporto, and south-east to the Mediterranean at Cape Tortosa, from their sources in the great northern watershed. The Guadiana (510 m.) passes west and south through La Mancha and Andalusia to fall into Cadiz Bay at Ayamonte; and the Guadalquivir (360 m.) takes a similar direction from its headwaters in Jaen to Sanlúcar de Barrameda, where it also enters Cadiz Bay farther south. These five rivers, as also the smaller Júcar and Segura, which enter the Mediterranean, are fully described in separate articles. With the exception of the Guadalquivir, none of them is of great service for inland navigation, so far as they lie within the Spanish frontier. On the other hand, those of the east and south are of great value for irrigation, and the Júcar and Segura are employed in floating timber from the Serrania de Cuenca. The only considerable lakes in Spain are three coast lagoons—the Albufera (*q.v.*) de Valencia, the Mar Menor in Murcia and the Laguna de la Janda in Cadiz behind Cape Trafalgar (see MURCIA and CADIZ). Small alpine and other lakes are numerous, and small salt lakes are to be found in every steppe region.

Geology.—Geologically the Spanish Peninsula consists of a great massif of ancient rock, bordered upon the north, east and south by zones of folding in which the Mesozoic and early Tertiary beds are involved. The massif is composed of Archean, Palaeozoic and eruptive rocks, partly concealed by a covering of Tertiary strata, but characterized by the absence, excepting on its margins, of any marine deposits of Mesozoic age. It stretches from Galicia and Asturias on the north to the valley of the Guadalquivir on the south, and includes the mountains of Castile, the Sierra de Toledo and the Sierra Morena. The rocks which form it are often strongly folded, but the folding is of ancient date and strikes obliquely across the massif and has had no influence in determining its outline. The massif is in fact merely a fragment of the great Hercynian mountain system which was formed across Europe at the close of the Carboniferous period. During the Mesozoic era this mountain chain was shattered and large portions of it sank beneath the sea and were covered by Mesozoic and Tertiary strata. But other fragments still rose above the waves, and of these the great massif of Portugal and western Spain was one. Around it the deposits of the Jurassic and Cretaceous seas were laid down; and during the Tertiary era they were crushed, together with the earlier Tertiary beds, against the ancient rocks, and thus formed the folded zones of the Cordillera Bética on the south, the hills of southern Aragon on the east and the Pyrenees on the north. The intervening plains and plateaus are now for the most part covered by Tertiary deposits, which also spread over much of the ancient massif.

Archean rocks are exposed in the north of the Peninsula, particularly along the great Pyrenean axis, in Galicia, Estremadura, the Sierra Morena, the Sierra Nevada and Serrania de Ronda. They consist of granites, gneisses and mica-schists, with talc-schists, amphibolites and crystalline limestones. The oldest Palaeozoic strata are referred, from their included fossils, to the Cambrian, Ordovician and Silurian systems. They range through a vast region of Andalusia, Estremadura, Castile, Salamanca, Leon and Asturias, and along the flanks of the Pyrenean and Cantabrian chain. They consist of slates, greywackes, quartzites and diabases. Grits, quartzites, shales and limestones referable to the Devonian system are found in a few scattered areas, the largest and most

fossiliferous of these occurring in Asturias. The Lower Carboniferous rocks of Spain consist partly of limestones, and partly of shales, sandstones and conglomerates like the culm of Devonshire. It is in the culm of the province of Huelva that the celebrated copper mines of Rio Tinto are worked. The Upper Carboniferous is formed to a large extent of sandstones and shales, with seams of coal; but beds of massive limestones are often intercalated, and some of these contain *Fusulina* and other fossils like those of the Russian *Fusulina* limestone. The system is most extensively developed in the north, covering a considerable space in Asturias, whence it stretches more or less continuously through the provinces of Leon, Palencia and Santander. Another tract, about 500 sq. kilometres in extent, runs

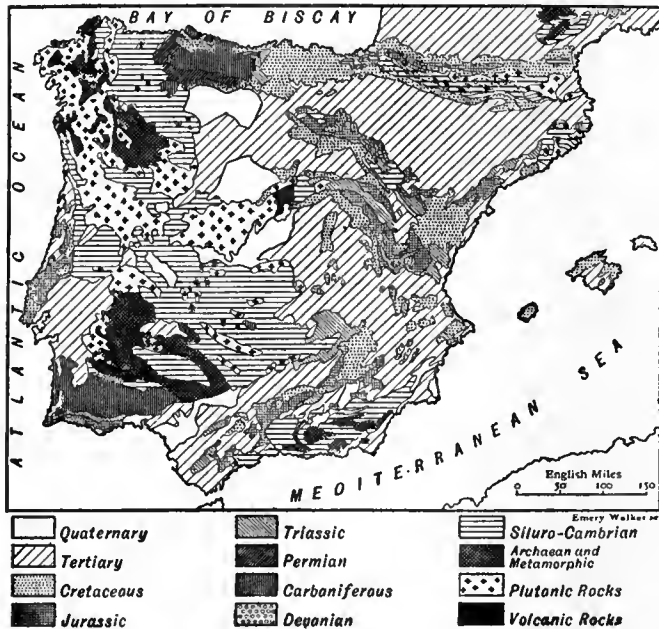

from the province of Cordova into that of Badajoz. It is in this area that the important coal deposits of Penarroja are found. There are other smaller areas containing little or no coal, but showing by the included plant-remains that the strata undoubtedly belong to the Carboniferous system.

The Permian is probably represented by some of the red sandstones, conglomerates and shales in the Pyrenees, in the Serrania de Cuenca, and in Andalusia. The Triassic system is well developed in the north of the peninsula along the Cantabrian chain and eastwards to the Mediterranean. It is composed of red and variegated sandstones, dolomites and marls, traversed in some places by ophitic rocks, and containing deposits of gypsum, aragonite and rock-salt. It thus resembles the Trias of England and Germany. In the south-east, however, and at the mouth of the Ebro, limestones are found containing a fauna similar to that of the alpine Trias. These strata are overlain by members of the Jurassic series, which are especially conspicuous in the eastern part of the peninsula between Castile and Aragon, along the Mediterranean border, in Andalusia, and likewise along the flanks of the Pyrenees. The Jurassic of Andalusia belongs to the Mediterranean facies of the system; the Jurassic of the rest of Spain is more nearly allied to that of north-western Europe. The Cretaceous system is distributed in four great districts: the largest of these extends through the kingdoms of Murcia and Valencia; a second stretches between the two Castiles; a third is found in the Basque Provinces and in Asturias; and a fourth spreads out along the southern slopes of the Pyrenees from Navarre to the Mediterranean. The lower members of the Cretaceous series include an important fresh-water formation (sandstones and clays), which extends from the Cantabrian coast through the provinces of Santander, Burgos, Soria and Logroño, and is supposed to represent the English Wealden series. The higher members comprise massive hippurite limestones, and in the Pyrenean district representatives of the upper subdivisions of the system, including the Danian.

Deposits of Tertiary age cover rather more than a third of Spain. They are divisible into two great series, according to their mode of origin in the sea or in fresh-water. The marine Tertiary accumulations commence with those that are referable to the Eocene series, consisting of nummulitic limestones, marls and siliceous sandstones. These strata are developed in the basin of the Ebro, and in a belt which extends from Valencia through Murcia and Andalusia to Cadiz. Marine Miocene deposits occupy some small tracts, especially on the coast of Valencia. But most of the sandy Tertiary rocks of that district are Pliocene. The Tertiary strata of Andalusia are specially noteworthy for containing the native silver of Herrerias, which is found in a Pliocene bed in the form of flukes, needles and

crystals. But the most extensive and interesting Tertiary accumulations are those of the great lakes which in Oligocene and Miocene time spread over so large an expanse of the table-land. These sheets of fresh-water covered the centre of the country, including the basins of the Ebro, Júcar, Guadalaviar, Guadalquivir and Tagus. They have left behind them thick deposits of clays, marls, gypsum and limestone, in which numerous remains of the land-animals of the time have been preserved.

Quaternary deposits spread over about a tenth of the area of the country. The largest tract of them is to be seen to the south of the Cantabrian chain; but another, of hardly inferior extent, flanks the Sierra de Guadarrama, and spreads out over the great plain from Madrid to Cáceres. Some of these alluvial accumulations indicate a former greater extension of the snowfields that are now so restricted in the Spanish sierras. Remains of the reindeer are found in caves in the Pyrenees.

Eruptive rocks of many different ages occur in different parts of Spain. The most important tract covered by them is that which stretches from Cape Ortelal to Coria in Estremadura and spreads over a large area of Portugal. They likewise appear in Castile, forming the sierras of Gredos and Guadarrama; farther south they rise in the mountains of Toledo, in the Sierra Morena, and across the provinces of Cordova, Seville, Huelva and Badajoz as far as Evora in Portugal. Among the minor areas occupied by them may be especially mentioned those which occur in the Trinsic districts. Of rocks included in the eruptive series the most abundant is granite. There occur also quartz-porphry (Sierra Morena, Pyrenees, &c.), diorite, porphyrite, diabase (well developed in the north of Andalusia, where it plays a great part in the structure of the Sierra Morena), ophite (Pyrenees, Cadiz), serpentine (forming an enormous mass in the Serrania de Ronda), trachyte, liparite, andesite, basalt. The last four rocks occur as a volcanic series distributed in three chief districts—that of Cape Gata, including the south-east of Andalusia and the south of Murcia, that of Catalonia, and that of La Mancha.

Climate.—In accordance with its southerly position and the variety in its superficial configuration, Spain presents within its borders examples of every kind of climate to be found on the northern hemisphere, with the sole exception of that of the torrid zone. As regards temperature, the heart of the table-land is characterized by extremes as great as are to be met in almost any part of central Europe. The northern and north-western maritime provinces, on the other hand, have a climate as equable, and as moist, as that of the west of England or Scotland.

Four zones of climate are distinguished. The first zone is that of the table-land, with the greater part of the Ebro basin. This is the zone of the greatest extremes of temperature. Even in summer the nights are often decidedly cold, and on the high parameras it is not a rare thing to see hoar-frost in the morning. In spring cold, wetting mists occasionally envelop the land for entire days, while in summer the sky is often perfectly clear for weeks together. At all seasons of the year sudden changes of temperature, to the extent of from 30° to 50° F., are not infrequent. The air is extremely dry, which is all the more keenly felt from the fact that it is almost constantly in motion. At Madrid (2150 ft. above sea-level) it freezes so hard in December and January that skating is carried on on the sheet of water in the Buen Retiro; and, as winter throughout Spain, except in the maritime provinces of the north and north-west, is the season of greatest atmospheric precipitation, snowfalls are frequent, though the snow seldom lies long except at high elevations. The summers, on the other hand, are not only extremely warm but almost rainless, the sea-winds being deprived of their moisture on the edge of the plateau. In July and August the plains of New Castile and Estremadura are sunburnt wastes; the roads are several inches deep with dust; the leaves of the few trees are withered and discoloured; the atmosphere is filled with a fine dust, producing a haze known as *calina*, which converts the blue of the sky into a dull grey. In the greater part of the Ebro basin the heat of summer is even more intense. The treeless mostly steppe-like valley with a bright-coloured soil acts like a concave mirror in reflecting the sun's rays and, moreover, the mountains and highlands by which the valley is enclosed prevent to a large extent the access of winds.

The second zone is that of the Mediterranean provinces, exclusive of those of the extreme south. In this zone the extremes of temperature are less, though the summers here also are warm, and the winters decidedly cool, especially in the north-east.

The southern zone, to which the name of African has been given, embraces the whole of Andalusia as far as the Sierra Morena, the southern half of Murcia and the province of Alicante. In this zone there prevails a genuine sub-tropical climate, with extremely warm and almost rainless summers and mild winters, the temperature hardly ever sinking below freezing-point. The hottest part of the region is not the most southerly district but the bright-coloured steppes of the coast of Granada, and the plains and hill terraces of the south-east coast from Almeria to Alicante. Snow and frost are here hardly known. It is said that at Malaga snow falls only about once in twenty-five years. The winter, in fact, is the season of the brightest vegetation: after the long drought of summer the surface gets covered once more in late autumn with a fresh green varied with bright-coloured flowers, and so it remains the

whole winter through. On the other hand, the eastern part of this zone is the part of Spain which is liable to be visited from time to time by the scorching *leveche*, the name given in Spain to the sirocco, as well as by the *solano*, a moist and less noxious east wind.

The fourth zone, that of the north and north-west maritime provinces, presents a marked contrast to all the others. The temperature is mild and equable; the rains are abundant all the year round, but fall chiefly in autumn, as in the west of Europe generally. Roses bloom in the gardens at Christmas as plentifully as in summer. The chief drawback of the climate is an excess of rain in some parts, especially in the west. Santiago de Compostela, for example, has one of the highest rainfalls on the mainland of Europe (see table below).

The figures given in the following table,¹ although based only on data of short periods (from 3½ to 20 years), will help to illustrate the preceding general remarks. Greenwich is added for the sake of comparison.

Station.	Height in feet.	Mean Temperature, F.			Rain-fall in inches.	
		Jan.	July.	Year.		
		o	o	o		
Table-land zone	Leon . . .	2600	37	73	53	19
	Madrid . . .	2150	41	76	56	15
Southern zone	San Fernando	90	52	75	63	30
	Malaga . . .	75	54	79	70	—
Mediterranean zone	Murcia . . .	140	49	79	63	14
	Mahon . . .	—	52	77	64	27
Northern maritime zone	Bilbao . . .	50	46	70	58	46
	Oviedo . . .	750	43	66	54	36
	Santiago . . .	750	45.5	66	55	66
Greenwich	—	39	63	50	25	

Flora.—The vegetation of Spain exhibits a variety in keeping with the differences of climate just described. The number of endemic species is exceptionally large, the number of monotypic genera in the Peninsula greater than in any other part of the Mediterranean domain. The endemic species are naturally most numerous in the mountains, and above all in the loftiest ranges, the Pyrenees and the Sierra Nevada; but it is a peculiarity of the Spanish table-land, as compared with the plains and table-lands of central Europe, that it also possesses a considerable number of endemic plants and plants of extremely restricted range. This fact, however, is also in harmony with the physical conditions above described, being explained by the local varieties, not only of climate, but also of soil. Altogether no other country in Europe of equal extent has so great a wealth of species as Spain. According to the *Prodromus florae hispanicae* of Willkomm and Lange (completed in 1880), the number of species of vascular plants then ascertained to exist in the country was 5096.

Spain may be divided botanically into four provinces, corresponding to the four climatic zones.

In the table-land province (including the greater part of the Ebro valley) the flora is composed chiefly of species characteristic of the Mediterranean region, and largely of species confined to the Peninsula. A peculiar character is imparted to the vegetation of this province by the growth over large tracts of evergreen shrubs and large herbaceous plants belonging to the Cistaceae and Labiatae. Areas covered by the Cistaceae are known to the Spaniards as *jarales*, and are particularly extensive in the Mancha Alta and on the slopes of the Sierra Morena, where the ladanum bush (*Cistus ladaniferus*) is specially abundant; those covered by the Labiatae are known as *tomillares* (from *tomillo*, thyme), and occur chiefly in the south, south-west and east of the table-land of New Castile. In the central parts of the same table-land huge thistles (such as the *Onopordum nervosum*), centaureas, artemisias and other Compositae are scattered in great profusion. From the level parts of these table-lands trees are almost entirely absent. On the lofty parameras of Soria and other parts of Old Castile the vegetation has an almost alpine character.

The southern or African province is distinguished chiefly by the abundance of plants which have their true home in North Africa (a fact explained by the geologically recent land connexion of Spain with that continent), but is also remarkable for the occurrence within it of numerous Eastern plants (natives of Syria and Asia Minor), and plants belonging to South Africa and the Canaries, as well as natives of tropical America which have become naturalized here (see *Agriculture*). In the maritime parts of Malaga and Granada the vegetation is of almost tropical richness and beauty, while in Murcia, Alicante and Almeria the aspect is truly African, fertile oases appearing in the midst of rocky deserts or barren steppes. A peculiar vegetation, consisting mainly of low shrubs with fleshy glaucous leaves (*Inula crithmoides*, &c.), covers the swamps of the Guadalquivir and the salt-marshes of the south-west coast. Everywhere on moist sandy ground are to be seen tall thickets of *Arundo donax*.

The Mediterranean province is that in which the vegetation agrees most closely with that of southern France and the lowlands

of the Mediterranean region generally. On the lower slopes of the mountains and on all the parts left uncultivated the prevailing form of vegetation consists of a dense growth of shrubs with thick leathery leaves, such as are known to the French as *maquis*, to the Italians as *macchie*, and to the Spaniards as *monte bajo*,² shrubs which, however much they resemble each other in external appearance, belong botanically to a great variety of families.

The northern maritime province, in accordance with its climate, has a vegetation resembling that of central Europe. Here only are to be found rich grassy meadows covered with flowers such as are seen in English fields, and here only do forests of oak, beech and chestnut cover a large proportion of the area. The extraordinary abundance of ferns (as in western France) is likewise characteristic.

The forest area of Spain is relatively small. The whole extent of forests is estimated at little more than 7½ million acres, or less than 6% of the area of the kingdom. Evergreen oaks, chestnuts and conifers are the prevailing trees. The cork oaks of the southern provinces and of Catalonia are of immense value, but the groves have suffered greatly from the reckless way in which the produce is collected. Among other characteristic trees are the Spanish pine (*Pinus hispanica*), the Corsican pine (*P. Laricio*), the Pinsapo fir (*Abies Pinsapo*), and the *Quercus Tozza*, the last belonging to the slopes of the Sierra Nevada. Besides the date-palm the dwarf-palm grows spontaneously in some parts of the south, but it nowhere makes up a large element of the vegetation.

The Spanish steppes deserve a special notice, since they are not confined to one of the four botanical provinces, but are found in all of them except the last. Six considerable steppe regions are counted: (1) that of Old Castile, situated to the south of Valladolid, and composed chiefly of hills of gypsum; (2) that of New Castile, in the south-east (including parts of La Mancha); (3) the Aragonese, occupying the upper part of the basin of the Ebro; (4) the littoral, stretching along the south-east coast from Alicante to the neighbourhood of Almeria; (5) the Granadine, in the east of Upper Andalusia (the former kingdom of Granada); and (6) the Bactic, in Lower Andalusia, on both sides of the valley of the Jenil or Genil. All of these were originally salt-steppes, and, where the soil is still highly impregnated with salt, have only a sparse covering of shrubs, mostly members of the Salsolaceae, with thick, greyish green, often downy leaves. A different aspect is presented by the grass steppes of Murcia, La Mancha, the plateaus of Guadix and Huescar in the province of Granada, &c., all of which are covered chiefly with the valuable esparto grass (*Macrochloa tenacissima*).

Fauna.—The Iberian Peninsula belongs to the Mediterranean sub-region of the Palaeartic region of the animal kingdom. The forms that betray African affinities are naturally to be found chiefly in the south. Among the mammals that fall under this head are the common genet (*Genetta vulgaris*), which extends, however, pretty far north, and is found also in the south of France, the fallow-deer, the porcupine (very rare), and a species of ichneumon (*Herpestes Widdringtonii*), which is confined to the Peninsula, and is the only European species of this African genus. The magot or Barbary ape (*Inuus caudatus*), the sole species of monkey still found wild in Europe, is also a native of Spain, but only survives on the rock of Gibraltar (*q.v.*). Of the mammals in which Spain shows more affinity to the fauna of central and northern Europe, some of the most characteristic are the Spanish lynx (*Lynx pardinus*), a species confined to the Peninsula, the Spanish hare (*Lepus madritensis*), and the species mentioned in the article PYRENEES. The birds of Spain are very numerous, partly because the Peninsula lies in the route of those birds of passage which cross from Africa to Europe or Europe to Africa by way of the Straits of Gibraltar. Many species belonging to central Europe winter in Spain, especially on the south-eastern coasts and in the valley of the Guadalquivir. Innumerable snipe are killed in the Guadalquivir valley and brought to the market of Seville. Among the birds of prey may be mentioned, besides the cinereous and bearded vultures, the Spanish vulture (*Gyps occidentalis*), the African or Egyptian vulture (*Neophron percnopterus*), which is found among all the mountains of the Peninsula, the Spanish imperial eagle (*Aquila Adalberti*), the short-toed eagle (*Circus gallicus*), the southern eagle-owl (*Bubo atheniensis*), and various kites and falcons. Among gallinaceous birds besides the red-legged partridge, which is met with everywhere on the steppes, there are found also the *Pterocles alchita* and *P. arenarius*; and among the birds of other orders are the southern shrike (*Lanius meridionalis*), the Spanish sparrow (*Passer cyaneus*), and the blue magpie (*Cyanopica cooki*). The last is highly remarkable on account of its distribution, it being confined to Spain while the species most closely allied to it (*Cyanopica cyanea*) belongs to the east of Asia. The flamingo is found native in the Balearic Islands and on the southern coasts, and a stray specimen is occasionally seen on the table-land of New Castile. Other birds peculiar to the south are two species of quails, the Andalusian hemipode (*Turnix sylvatica*), confined to the plains of Andalusia, the southern shearwater (*Puffinus cinereus*), and other water-birds. Amphibians and reptiles are particularly numerous in the southern provinces, and among these the most remarkable are the large southern or eyed lizard (*Lacerta*

² As distinguished from *monte alto*, the collective name for forest trees.

¹ By conversion from Th. Fischer's *Klima der Mittelmeerlande*.

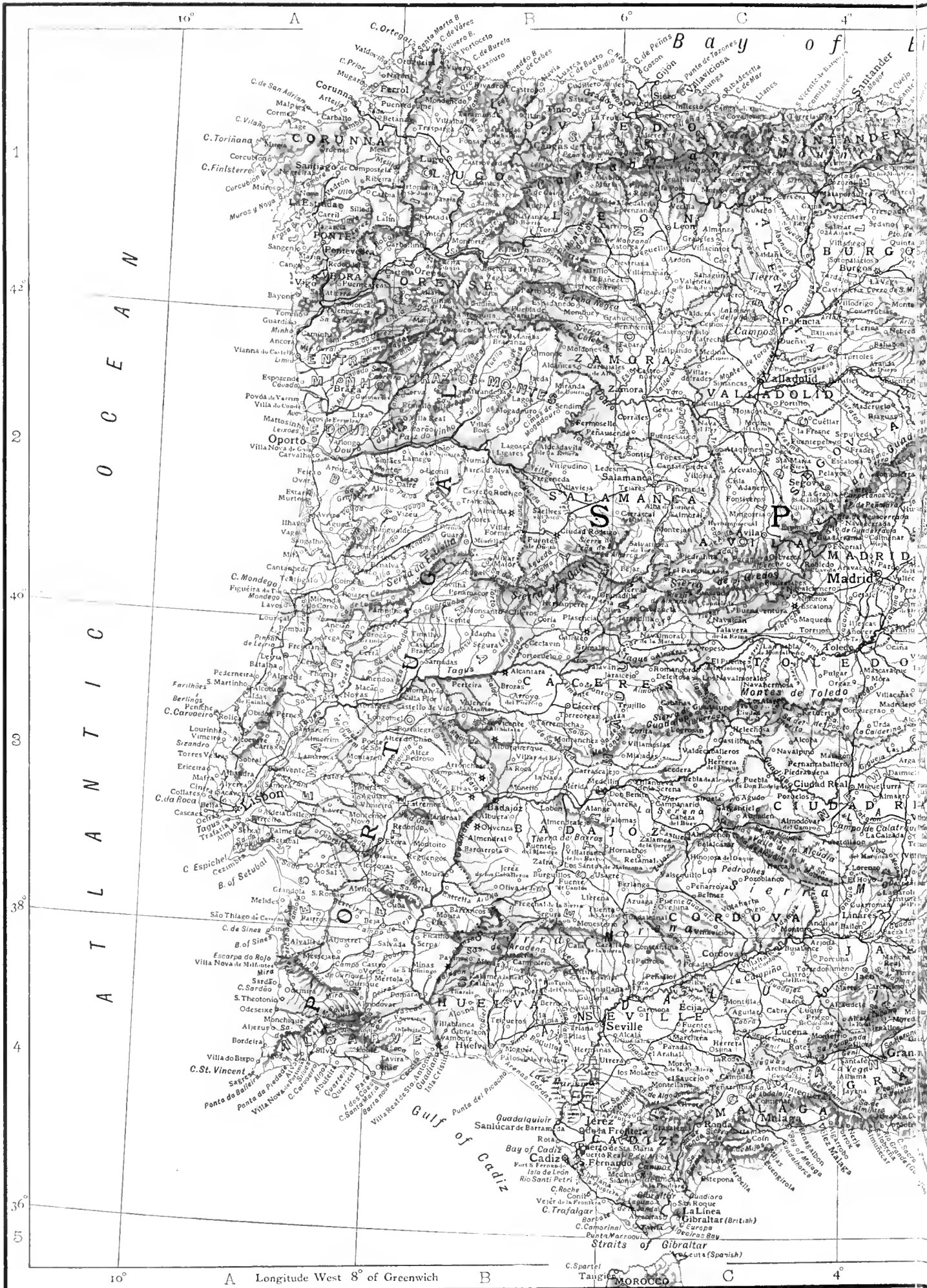

ATLANTIC OCEAN

BAY OF

10° 8° 6° 4°

1
2
3
4
5

A Longitude West 8° of Greenwich B C

MOROCCO



SPAIN AND PORTUGAL

Scale, 1:3,500,000

0 10 20 40 80 120 English Miles

- Boundaries of Provinces (Spain) and Districts (Portugal). ————
- Capitals of Provinces and Districts. ○
- Districts in Portugal have the same name as the Capital town
- Boundaries of former Provinces. - - - - -
- Railways — Canals — Passes = Fortifications. *
- Co. = Cerro; P. = Pico, Mountain peak; Pto. = Puerto, Pass;
- Sa. = Serra, Sierra, Mountains Swamps. ~~~~~

Meridian 0° of Greenwich Longitude East 2° of Greenwich

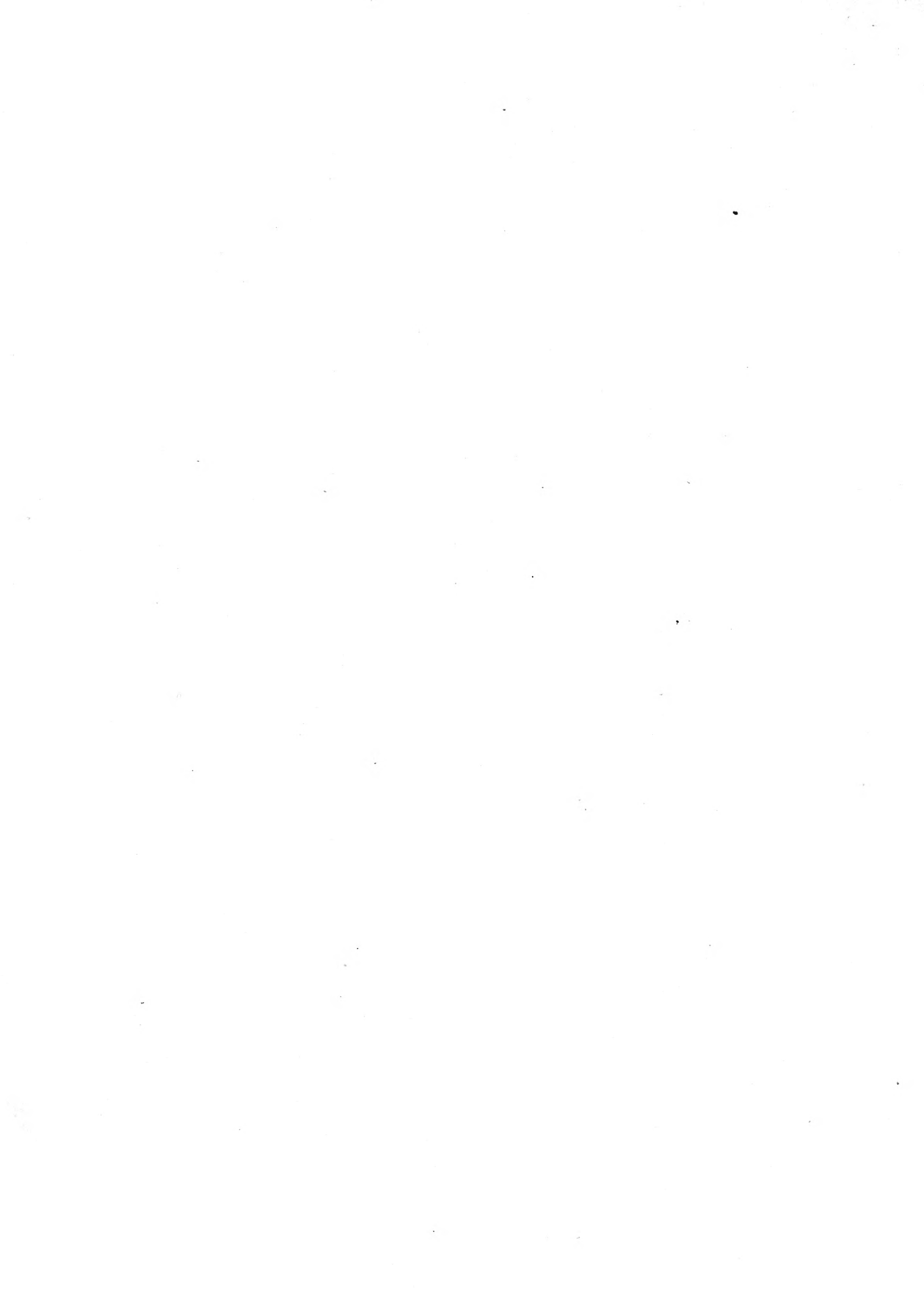

ocellata), which sometimes attains 3 ft. in length and is very abundant: the *Platydictylus saccicularis*, the grey amphibaena (*Bianus cinereus*), the European pond-tortoise (*Emys europaea*), and another species, *Emys Siegrizii*. Insect life is remarkably abundant and varied. More than 350 species of butterflies, many of them endemic, have been counted in the province of Madrid alone. Besides the ordinary European scorpion, which is general in southern Europe, there is another species, the sting of which is said to be still more severe, found chiefly in the basin of the Ebro. Trout abound in the mountain streams and lakes, barbel and many other species of *Cyprinidae* in the rivers of the plains. For the sea fauna, see under *Fisheries* below.

Territorial Divisions and Population.—For administrative purposes the kingdom of Spain has since 1833 been divided into forty-nine provinces, forty-seven of which belong to the mainland. Before 1833 the mainland was divided into thirteen provinces, also enumerated below, which took their names from the ancient kingdoms and principalities out of which the modern kingdom was built up. All the continental provinces, ancient and modern, as also the Balearic Islands, Canary Islands, Annobon, Ceuta, Corisco, the Chaffarinas, Fernando Po, the Muni River Settlements and Rio de Oro are described in separate articles.

It is probable that the population of Spain attained its height during the early Roman Empire, when it has been estimated, though of course on imperfect data, to have numbered forty or fifty millions. The best evidence of a dense population in those days is that afforded by the specific estimates of ancient writers for some of the larger cities. The population of Tarraco (Tarragona) was estimated at 2½ millions, and those of Nova Carthago (Cartagena), Italica (Sevilla la Vieja), and other cities at several hundreds of thousands. Emerita Augusta (Mérida) had a Roman garrison of 90,000 men, which also implies a large population.

The first Spanish census was made in 1594, but some of the provinces now included in the kingdom were not embraced in the enumeration, so that the total population assigned to Spain within its present limits for that date is obtained by adding the results of enumerations at different dates in the provinces then excluded. The total thus arrived at is 8,206,791. No other census took place till 1787, when the total was found to be 10,268,150; and this census was followed by another in 1797, when the population was returned as 10,541,221. Various estimates were made within the next sixty years, but the census of 1857 proved that some of these estimates must have been greatly below the truth. The total population then ascertained to exist in Spain was 15,464,340, an increase of not much less than 50% since the census of 1797. Between 1857 and 1877 the population increased to 16,631,869; and by 1897 it had risen to 18,132,475. The annual rate of increase during this period of forty years was less than 45%, or lower than that of any other European state, except France in the later years of the 19th century. The census of 1900, however, showed that the annual rate of increase had risen, between 1897 and 1900, to 89%, or nearly double its former amount. This fact may be explained partly by the growth of mining and certain other industries, partly, perhaps, by the recuperative power which the Spanish people has always exhibited after war—the most notable instance

of which is the above-mentioned net increase of nearly 50% between 1797 and 1857, despite the Napoleonic invasion and other disastrous wars. A similar though much smaller acceleration in the annual rate of increase after the Carlist Wars of 1874-76 is largely attributable to the prosperity caused by railway development between 1877 and 1887. It would be unjustifiable to assume from the inadequate data available that the Spanish people retains the vitality which characterized it from 1797 to 1857. It is, however, clear from the census returns that at the beginning of the 20th century

Area and Population of the Former and Present Provinces.

Provinces.	Area in sq. m.	Pop., 1857.	Pop., 1887.	Pop., 1900.	Pop. per sq. m., 1900.
New Castile.	27,935	1,477,915	1,778,155	1,923,310	60.8
Madrid	3,084	475,785	683,484	775,034	251.3
Guadalajara	4,676	199,088	205,040	200,186	42.8
Toledo	5,919	328,755	356,398	376,814	63.6
Cuenca	6,636	229,959	246,091	249,696	37.6
Ciudad Real	7,620	244,328	287,142	321,580	42.2
Old Castile	25,372	1,609,948	1,744,301	1,785,403	70.3
Burgos	5,480	333,356	342,988	338,828	61.8
Logroño	1,946	173,812	183,430	189,376	97.3
Santander	2,108	214,441	249,116	276,003	130.9
Ávila	3,042	164,039	195,321	200,457	65.9
Segovia	2,635	146,839	155,927	159,243	60.4
Soria	3,983	147,468	157,008	150,462	37.7
Palencia	3,256	185,970	189,349	192,473	59.1
Valladolid	2,922	244,023	271,162	278,561	95.3
Asturias	4,205	524,529	615,844	627,069	149.1
Oviedo	4,205	524,529	615,844	627,069	149.1
Leon	14,862	861,434	984,711	982,393	66.1
Salamanca	4,829	263,516	320,588	320,765	66.4
Zamora	4,097	249,162	274,890	275,545	67.2
León	5,936	348,756	389,233	386,083	65.0
Extremadura	16,118	707,115	808,685	882,410	54.7
Badajoz	8,451	404,981	476,273	520,246	61.6
Cáceres	7,667	302,134	332,412	362,164	47.2
Galicia	11,254	1,776,879	1,967,239	1,980,515	175.8
Corunna (Coruña)	3,051	551,989	635,327	653,556	214.2
Lugo	3,814	424,186	438,076	463,386	122.0
Orense	2,694	371,818	415,237	404,311	150.1
Pontevedra	1,695	428,886	478,599	457,262	269.8
Andalusia (Andaluçia)	33,777	2,937,183	3,393,681	3,562,606	105.4
Almería	3,360	315,664	345,929	359,013	106.8
Granada	4,928	444,629	482,787	492,460	99.9
Malaga	2,812	451,406	523,915	511,989	182.1
Cordova	5,299	351,536	413,883	455,859	85.8
Jaen	5,203	345,879	428,152	474,490	91.2
Cadiz (with Ceuta)	2,834	390,192	423,261	452,659	159.7
Seville	5,428	463,486	535,687	555,256	100.4
Huelva	3,913	174,391	240,067	260,880	66.6
Valencia	8,830	1,246,485	1,461,453	1,587,533	179.7
Castellon de la Plana	2,495	260,919	292,952	310,828	124.5
Valencia	4,150	606,608	730,916	806,556	194.3
Alicante	2,185	378,958	437,685	470,149	215.1
Murcia	10,190	582,087	720,843	815,864	80.0
Albacete	5,737	201,118	231,073	237,877	41.3
Murcia	4,453	380,969	489,770	577,987	129.8
Catalonia	12,427	1,652,291	1,836,139	1,966,382	158.2
Lérida	4,690	306,994	296,609	274,590	58.5
Gerona	2,264	310,970	311,153	299,287	132.2
Barcelona	2,968	713,734	879,771	1,054,541	355.3
Tarragona	2,505	320,593	348,606	337,964	134.9
Aragon	18,294	880,643	922,554	912,711	49.8
Huesca	5,848	257,839	260,585	244,867	41.8
Saragossa	6,726	384,176	415,152	421,843	62.7
Teruel	5,720	238,628	246,817	246,001	43.0
Navarre (Navarra)	4,055	297,422	307,994	307,669	75.8
Navarre	4,055	297,422	307,994	307,669	75.8
Basque Provinces	2,739	413,470	510,194	603,596	220.3
Biscay (Vizcaya)	836	160,579	234,880	311,361	372.4
Guipúzcoa	728	156,493	181,149	195,850	269.0
Alava	1,175	96,398	94,165	96,385	82.0
Balearic Islands	1,935	262,893	313,480	311,649	161.1
Canary Islands	2,807	234,046	301,963	358,564	127.5
Total	194,700	15,464,340	17,667,256	18,618,086	95.6

the nation was well able to make good the numerical losses involved by a serious war; that its numbers tend to increase steadily; and that the rate of increase has hitherto shown a marked acceleration in periods of commercial expansion.

The estimated area and population of the Spanish possessions in Africa, exclusive of Ceuta, are shown below:—

	Area in sq. m.	Pop.
Rio de Oro	70,000	130,000
Muni River Settlements	9,800	140,000
Fernando Po, Annobon, Corisco, &c.	800	22,000
Melilla, Ifni, &c.	40	15,000
Totals	80,640	307,000

Its extraordinary lack of population differentiates Spain from every other country possessed of equal natural advantages and an historic civilization. Spain occupies an unsurpassed geographical position; its resources are rich, varied and to some extent unexploited; its inhabitants include the Basques and Catalans, noted for their commercial enterprise, and the Galicians, noted for their industry. Nevertheless this country, which appears, more than 2000 years ago, to have supported a population nearly thrice as numerous as its present inhabitants and larger than that of the United Kingdom in 1901, is almost as thinly peopled as the most deserted province of Ireland (Connaught 94.5 inhabitants per sq. m.). The depopulation of Spain dates certainly from the Moorish conquest, possibly from the earlier Visigothic invasion. The Moors decimated the native population; when they in turn were expelled, the country lost not only a numerically large section of its inhabitants, but the section best able to develop its natural wealth. The wars of the 16th, 17th and 18th centuries, and the vast potentialities of fortune which drew men to the Spanish colonies in America, caused a further serious drain upon the population.

As regards the distribution of population between town and country, Spain contrasts in a marked manner with Italy, Spain having but few large towns and a relatively large country population.

Communications.—The communications in Spain were greatly improved during the 19th century. In 1808 there were little more than 500 m. of carriage roads; in 1908 the aggregate length of the state, provincial and municipal roads was about 40,000 m. But there are still many parts of the country where trade—and especially mining—is retarded by the want of good roads. In the mountainous districts, where there are only narrow paths, frequently rather steep, it is still not uncommon to meet long trains of pack-mules, which, with ox-carts for heavier goods, constitute the sole means of transport in such regions.

Railways have made great advance since the middle of the 19th century. The oldest line is that from Barcelona to Mataró, 17½ m., which was opened on the 28th of October 1848. From 1850 onwards the rate of construction increased apace, and during the last decade of the 19th century about 205 m. were opened to traffic every year. In January 1910, 9020 m. had been completed, and the whole kingdom was covered by a network of railways which linked together all the principal towns. The Spanish railway system at this time communicated with the French at Irun and Portbou, west and east respectively of the Pyrenees; and with the Portuguese at or near Tuy on the northern frontier of Portugal, and near La Fregeneda, Ciudad Rodrigo, Valencia de Alcántara and Badajoz on the E. All the Spanish railways belong to private companies, most of which have received state subventions, and they will fall in to the government mostly at the end of 99 years. In granting a concession for a new railway the practice is to give it to the company that offers to construct it with the lowest subvention. For strategical reasons the Spanish gauge was made different from that of France; and military considerations long postponed the construction of any railway across the Pyrenees. The roads which wind through the Pyrenees in northern Aragon, Navarre and Catalonia had long been the channels of an important traffic, although great inconvenience was caused by the snow which blocks the passes in winter. In 1882 the French and Spanish governments proposed to overcome this obstacle by constructing two railways: one from Huesca to Oloron, through the Canfranc Pass, and through an international tunnel which was to be built at Somport; the other from the Ariège railway system to the Spanish northern system in the province of Lérida. The first line was completed on the Spanish side as far as Jaca, the second was only surveyed; both were opposed by the ministries of war in the two countries concerned. The matter was taken up at the beginning of the 20th century by M. Delcassé, the French minister for foreign affairs, and on the 18th of August 1904 a convention was signed providing for the construction of (1) the Huesca-Oloron line, (2) a line from Ax les Thermes in the Ariège to Ripoll in Catalonia, (3) a line from St Giron in the Ariège to Sort, and thence to Lérida. The Spanish government agreed to finish the Lérida-Sort section by 1915, and the Noguera Pallaresa valley was chosen as the route from Sort to the frontier, where junction with the French railways would be effected through the Port de Salau. All three schemes were ratified in 1904 by the Cortes

and the French Chambers. Seventy per cent. of the railways of Spain, and an even larger proportion of the tramways and narrow-gauge railways, especially in mining districts, have been constructed and worked with foreign capital. The postal and telegraphic services have been placed on the same footing as in other civilized countries. In 1907 the number of letters and post-cards carried in the inland service was 133,201,000, in the international service 44,219,000. The length of state telegraph lines increased from 6665 m. in 1883 to 20,575 m. in 1903. In 1907 there were 84 urban telephone systems and 71 inter-urban circuits.

Agriculture.—Agriculture is by far the most important Spanish industry. In general it is in a backward condition, and is now much less productive than in the time of the Romans and again under the Moors. The expulsion of the latter people in many places inflicted upon agriculture a blow from which it has not recovered to this day. Aragon and Estremadura, the two most thinly peopled of all the old provinces, and the eastern half of Andalusia (above Seville), have all suffered particularly in this manner, later occupiers never having been able to rival the Moors in overcoming the sterility of nature, as in Aragon, or in taking advantage of its fertility, as in Andalusia and the Tierra de Barros. In some districts the implements used are still of the rudest description. The plough is merely a pointed stick shod with iron, crossed by another stick which serves as a share, scratching the ground to the depth of a few inches. But the regular importation of agricultural implements betokens an improvement in this respect. In general there has been considerable improvement in the condition of agriculture since the introduction of railways, and in every province there is a royal commissioner entrusted with the duty of supervising and encouraging this branch of industry. Among other institutions for the promotion of agriculture the royal central school at Aranjuez, to which is attached a model farm, is of special importance. Of the soil of Spain 79.65% is classed as productive; 33.8% being devoted to agriculture and gardens, 20.8 to fruit, 19.7 to grass, 3.7 to vineyards and 1.6 to olives. The land is subdivided among a very large number of proprietors; over 3,400,000 farms or estates were assessed for taxation in 1905.

The provinces in which agriculture is most advanced are those of Valencia and Catalonia, in both of which the river valleys are thickly seamed with irrigation canals and the hill-slopes carefully terraced for cultivation. In neither province is the soil naturally fertile, and nothing but the untiring industry of the inhabitants, favoured by the rivers which traverse the province from the table-land of New Castile and the numerous small streams (*nacimientos*) that issue from the base of the limestone mountains and by the numerous torrents from the Pyrenees, has converted them into two of the most productive regions in Spain. In the Basque Provinces and in Galicia the cultivable area is quite as fully utilized, but in these the difficulties are not so great. The least productive tracts, apart from Aragon and Estremadura, are situated in the south and east of New Castile, in Murcia, and in Lower Andalusia—the marshes or *marismas* of the lower Guadalquivir and the *arenas gordas* between that river and the Rio Tinto. By far the greater part of the table-land, however, is anything but fertile, the principal exceptions being the Tierra de Campos, said to be the chief corn-growing district in Spain, occupying the greater part of Palencia in the north-west of Old Castile, and the Tierra de Barros, in the portion of Badajoz lying to the south of the Guadiana in Estremadura.

Except in Leon and the provinces bordering on the Bay of Biscay and the Atlantic, irrigation is almost everywhere necessary for cultivation, at least in the case of certain crops. Almost all kinds of vegetables and garden-fruits, oranges, rice, hemp and other products are generally grown solely or mainly on irrigated land, whereas most kinds of grain, vines and olives are cultivated chiefly on dry soil. The water used for irrigation is sometimes derived from springs and rivers in mountain valleys, whence it is conveyed by long canals (*acequias*) along the mountain sides and sometimes by lofty aqueducts to the fields on which it is to be used. Sometimes the water of entire rivers or vast artificial reservoirs (*pántanos*) is used in feeding a dense network of canals distributed over plains many square miles in extent. Such plains in Valencia and Murcia are known by the Spanish name of *huertas* (gardens), in Andalusia by the Arabic name of *vegas*, which has the same meaning. Many of the old irrigation works—such as those of the plain of Tarragona—date from the time of the Romans, and many others from the Moorish period, while new ones are still being laid out at the present day. Where no running water is available for irrigation, water is often obtained from wells by means of waterwheels (*norias*) of simple construction. In most cases such wheels merely have earthenware pitchers attached to their circumference by means of wisps of esparto, and are turned by a horse harnessed to a long arm fitted to a revolving shaft. In recent years many artesian wells have been sunk for irrigation. In all, about 9% of the entire surface of Spain is artificially watered, but in 1900 the government adopted plans for the construction of new canals and reservoirs on a vast scale. The system was designed to bring a greatly increased area of arid or semi-arid land under irrigation. The irrigated portions of the Ebro and Tagus valleys yield twelve times as large a crop per acre as the unirrigated.

Cereals constitute the principal object of cultivation, and among these wheat ranks first, the next in importance being barley, the

chief fodder of horses and mules. Both of these grains are cultivated in all parts, but chiefly on the more level districts of the two Castiles and Leon, and on the plains of the Guadalquivir basin. Oats and rye are cultivated only in the higher parts of the mountains, the former as a substitute for barley in feeding horses and mules, the latter as a breadstuff. Maize also is cultivated in all the provinces; nevertheless, its cultivation is limited, since, being a summer crop, it requires irrigation except in the Atlantic provinces, and other products generally yield a more profitable return where irrigation is pursued. Rice is cultivated on a large scale only in the swampy lowlands of Valencia. Among cereals of less importance are buckwheat (in the mountainous regions of the north), millets, including both the common millet (*Panicum miliaceum*) and the so-called Indian millet (*Sorghum vulgare*, the *joñri* of India, the *durrah* of Africa), and even (in La Mancha) guinea-corn (*Penicillaria spicata*).

Among the natural products of the soil of Spain, in regard to quantity, wines come next to cereals, but the only wines which have a world-wide reputation are those of the south, those of Alicante, of Malaga, and more particularly those which take the name of "sherry," from the town of Jerez, in the neighbourhood of which they are grown (see WINE). From 1880 to 1890 when the French vineyards suffered so much from various plagues, and when Spain gave a great impetus to her foreign trade by numerous treaties of commerce, none of her products showed such an increase in exports as her wines. The vine-growing districts had formerly been mostly in the provinces of Cadiz, Malaga, Barcelona, Aragon and Navarre. Then the vineyards spread all along the Ebro valley and in the Mediterranean seaboard provinces, as well as in New and Old Castile and Estremadura to such an extent that wine is now produced in all the 49 provinces of the kingdom. The average result of the vintage was estimated between 440 and 500 million gallons in 1880 to 1884, and it rose to more than double that amount towards 1890, and amounted in 1898 to 880 million gallons. In that year the total area under the vine was 3,546,375 acres, in 1908 it was 3,136,470 acres. In the hey-day of the cultivation of the vine Spain sent the bulk of her wine exports to France. The imposition of high duties in France on foreign wines in 1891 dealt a severe blow to the export trade in common Spanish wines. The export of wines of the south—Jerez, Malaga and other full-bodied wines styled *generoso*—did not suffer so much, and England and France continued to take much the same quantities of such wines. There is also a large export of grapes and raisins, especially from Malaga, Valencia, Almería and Alicante. The Spanish vines have suffered, like those of France, from mildew and phylloxera. The latter has done most damage in the provinces of Malaga and Alicante, in Catalonia, and in some parts of the Ebro valley in Navarre and Aragon. The vines whose fruit is intended for table use as grapes or raisins are trained on espaliers or on trees, especially the nettle-tree (*Celtis australis*).

Among fruit-trees the first place belongs to the olive. Its range in Spain embraces the whole of the southern half of the table-land, the greater part of the Ebro valley, and a small strip on the west coast of Galicia. Along the base of the Sierra Morena from Andújar to the vicinity of Cordova there run regular forests of olives, embracing hundreds of square miles. Cordova is the headquarters of the oil industry, Seville of the cultivation of olives for table use. In 1908 the yield of oil amounted to 36,337,893 gallons. Oranges and lemons, excluded from the plateau by the severity of the winter cold, are grown in great quantities on the plains of Andalusia and all round the Mediterranean coast; the peel of the bigarade or bitter orange is exported to Holland for the manufacture of curaçao; and figs, almonds, pomegranates, carobs and other southern fruits are also grown abundantly in all the warmer parts, the first two even in central Spain and the more sheltered parts of the northern maritime provinces. In these last, however, the prevailing fruit-trees are those of central Europe, and above all the apple, which is very extensively cultivated in Asturias, the Basque Provinces and Navarre. In these provinces large quantities of cider are brewed. The date-palm is very general in the south-eastern half of the kingdom, but is cultivated for its fruit only in the province of Alicante, in which is the celebrated date-grove of Elche (*q.v.*). In the southern provinces flourish also various subtropical exotics, such as the banana, the West Indian cherimoya, and the prickly pear or Indian fig (*Opuntia vulgaris*), the last frequently grown as a hedge-plant, as in other Mediterranean countries, and extending even to the southern part of the table-land. It is specially abundant on the Balearic Islands. The agave or American aloe is cultivated in a similar manner throughout Andalusia.

Cotton is now cultivated only here and there in the south; but sugar-cane is, with sugar-beet, becoming more and more of a staple in the provinces of Granada, Malaga and Almería. Its cultivation was introduced by the Arabs in the 12th century or later, and was of great importance in the kingdom of Granada at the time of the expulsion of the Moors (1489), but has since undergone great vicissitudes, first in consequence of the introduction of the cane into America, and afterwards because of the great development of beet-sugar in central Europe. The industry received a powerful stimulus from the loss of the Spanish colonies in 1808, which freed the Spanish growers from the rivalry of their

most successful competitors in the home market. In 1901 the official statistics showed 22 cane-sugar factories and 47 beet-sugar factories with an annual output of about 100,000 tons.

In the production of pod-fruits and kitchen vegetables Spain is ahead of many other countries. The chick-pea forms part of the daily food of all classes of the inhabitants; and among other pod-fruits largely cultivated are various kinds of beans and peas, lentils (*Ervum lens*), Spanish lentils (*Lathyrus sativus*) and other species of *Lathyrus*, lupines, &c. The principal fodder-crops are lucerne (*Medicago sativa*) and esparcette (a variety of sainfoin). Clover, particularly crimson clover (*Trifolium incarnatum*), is grown in the northern provinces. Among vegetables garlic and onions take the chief place, and form an indispensable part of the diet of all Spaniards; besides these, tomatoes and Spanish pepper are the principal garden crops. Among the vegetable products not yet mentioned the most important are the mulberry, grown in almost all provinces, but principally in those bordering on the Mediterranean, and above all in Valencia, the chief seat of the Spanish silk production and manufacture; tobacco, which is also imported, hemp and flax, grown chiefly in Galicia and other northern provinces; among dye-plants, madder, saffron, woad (*Isatis tinctoria*), and wild woad or dyer's weed (*Reseda luteola*); ground-nuts (*Arachis hypogaea*), grown for their oil, for the preparation of which the nuts are exported in considerable quantity to France; liquorice, cummin, colocynth, &c. Esparto, chiefly from the arid lands of the south-east, is largely exported to Great Britain.

Despite all the efforts of the breeders and of the government, a decline has gone on not only in horse-rearing, but also in other classes of livestock since 1865. Among the causes assigned for this decay is the fact that horse, sheep, goat and swine rearing is becoming less remunerative. Heavy taxation, aggravated by unequal distribution of the burden, owing to insufficient survey of the assessable property, has also contributed to the decline of this and other branches of Spanish farming.

The only animals belonging to Spain still noted for their excellence are mules and asses, which are recognized as among the best to be found anywhere. Goats are mostly bred in the mountainous districts all along the Spanish side of the Pyrenees from Biscay to Catalonia, and in Badajoz, Cáceres, Ciudad Real, Granada and Leon; swine in Badajoz, Lugo, Oviedo, Cáceres and Corunna. The pork and hams of Estremadura are famous; goats' milk and cheese are important articles of diet. In some districts a single peasant often owns as many as 3000 head of goats. Besides the cattle reared for field-labour and (in the northern provinces) for regular dairy farming, bulls for bull-fighting are specially reared in many parts of the country, particularly in the forests of Navarre, the mountains separating the two Castiles, the Sierra Morena, and the Serrania de Ronda in Granada, and also in separate enclosures on the islands of the Guadalquivir. Spanish sheep, which once formed so important a part of the national wealth, are far from having the same importance at the present day. The most famous breeds of Spanish sheep are the merinos or migrating sheep, which once brought immense revenues to the state as well as to the large proprietors to whom they mostly belonged (see MERINO). These sheep are pastured in different districts in summer and winter. Their winter quarters are in the lower parts of Leon and Estremadura, La Mancha, and the lowlands of Andalusia, their summer quarters the more mountainous districts to the east and north (Plasencia in the province of Cáceres, Ávila, Segovia, Cuenca, Valencia), which are not so much affected by the summer droughts of the Peninsula. The mode of the migration and the routes to be followed are prescribed by law. Each flock consists of about 10,000 sheep, under the command of a *mayoral*, and is divided into sections containing about 1000 each, each section under the charge of an overseer (*capataz*), who is assisted by a number of shepherds (*pastores*) attended by dogs. The shepherds, rudely clad in a sleeveless sheepskin jacket, the wool outside, and leather breeches, and loosely wrapped in a woollen mantle or blanket, are among the most striking objects in a Spanish landscape, especially on the table-land. The migration to the summer quarters takes place at the beginning of April, the return at the end of September. At one time the owners of merino flocks enjoyed the right of pasturing their sheep during their migrations on a strip of ground about 100 yds. in breadth bordering the routes along which the migrations took place, but this right (the *mesta*, as it was called) was abolished in 1836 as prejudicial to cultivation. The numbers of the merinos have been greatly reduced, and they have been replaced by coarse-wooled breeds.

Fisheries.—The catching of tunnies, sardines, anchovies and salmon on the coasts employs large numbers of fishermen (about 67,000 in 1910), and the salting, smoking and packing of the first three give employment to many others. In 1910 there were about 400 sardine-curing establishments in the kingdom.

Minerals.—The mineral resources of Spain are as yet far from being adequately turned to account. No European country produces so great a variety of minerals in large amount, and in the production of copper ore, lead ore and mercury Spain heads the list. In the production of salt and silver it is excelled only by Austria-Hungary, and, as regards silver, not always even by it. Iron ore is chiefly obtained in Biscay and Murcia, the former yielding by far the greater quantity, but the latter yielding the better quality.

All except a small fraction of the copper ore is obtained from the province of Huelva, in which lie the well-known mines of Tharsis and Rio Tinto (*q.v.*). The lead ore is obtained chiefly in Murcia and Jaen. The famous mines of Lináres belong to the latter province. Argentiferous lead is chiefly produced in Almería, which also produces most of the silver ore of other kinds except argentiferous copper ore, which is entirely obtained from Ciudad Real. The still more celebrated mercury mines of Almaden (*q.v.*), the richest in the world till the discovery of the Californian mines of New Almaden, belong to Ciudad Real, and this province, together with that of Oviedo, furnishes the whole of the Spanish production of this mineral. Spanish salt is partly marine, partly derived from brine-springs and partly from rock-salt, of which last there is an entire mountain at Cardona (*q.v.*) in Barcelona. Coal is chiefly obtained in Oviedo, Palencia and Cordova. The production is quite insignificant compared with the extent of the coal-bearing beds, which are estimated to cover an area of about 3500 sq. m., of which nearly a third belongs to Oviedo. Among the less important Spanish minerals are manganese (chiefly in Ciudad Real), antimony, gold, cobalt, sodic sulphate, sulphate of barium (barytes), phosphorite (found in Cáceres), alum, sulphur, kaolin, lignite, asphalt, besides a variety of building and ornamental stones. In 1905 the workmen employed on mines in Spain numbered 105,000, and the total value of the output was estimated at £7,734,805. By the law of the 6th of July 1859, a large number of important mines, including all the salt-works and rock-salt mines, were reserved as state property, but financial necessities compelled the government to surrender one mine after another, so that at present the state possesses only the mercury mines and some salt-works. Many of the mines have been granted to foreign (principally British) companies.

Manufactures.—The maritime provinces, being those most favourably situated for the import of coal, and, where necessary, of raw material, are the chief seats of Spanish manufactures. The principal manufacture is that of cotton. The exports of Spanish cotton goods were, until the close of the 19th century, hardly worth mentioning outside the colonial markets, which took an average of two millions sterling in the decade 1888–1898. This outlet is now almost closed, as the new masters of Cuba, Porto Rico and the Philippines no longer protect Spanish imports against European and American competitors. But this loss has been to a great extent compensated by the expansion of the home market for cotton, and the Spanish manufacturers are unable to meet the wants of the population, large quantities of cotton goods being imported every year. The cotton industry was long principally centred in Catalonia, and mainly in the province and town of Barcelona, famed also for their manufactures of lace, woollen and linen goods. The northern provinces, especially Guipúzcoa and Biscay, Navarre and Oviedo, have followed in the wake of Catalonia for linen and cotton industries and for paper-mills. Flax-spinning is confined to Galicia. The silk industry, though inadequate to meet the home demands, is active in Valencia, Murcia and Seville. Metal industries, at first limited to the Basque Provinces, particularly around Bilbao, have spread to Asturias, Almería, Galicia, near the great ore beds and in the vicinity of many coal mines. In the same Asturian districts the government has its foundries and factories for making arms at La Trubia and Oviedo, Toledo being only now famous for its blades and decorative work, while the foundries at Seville and Segovia are unimportant compared with those of Asturias. The manufacture of leather, another Spanish industry of old renown, is still extensively carried on in Catalonia and elsewhere, but the making of *cordwain* has long ceased to be a speciality of Cordova, from which it takes its name. Gloves are made in Seville and Madrid, shoes in the Balearic Isles, chiefly for Cuba and Porto Rico. The esparto is twisted into cords and ropes and the staple matting so common on the floors of Spanish houses of all classes, the *estera*. Soap, chocolate and cork manufactures are among the prosperous industries. The same may be said of charcoal, both for heating and mechanical purposes. The large furnaces for the distillation of mercury at Almaden were at one time heated solely with charcoal obtained from the *Cistus ladaniferus*. The making of porcelain is chiefly carried on at Seville. The war of tariffs between France and Spain after 1891 was an inducement for an extraordinary development in the making of brandy and liqueurs of every kind, of fruit preserves, potted meats, etc., in Navarre, the Basque Provinces, Catalonia, and even in Valladolid and Andalusia. Special mention must be made of the manufacture of tobacco, a royal monopoly, farmed out to a company, which increased the factories from seven to twelve and began by paying the treasury £3,400,000 annually.

The decade following the Spanish-American War (1898–1908), which may be regarded as a period of industrial and commercial reconstruction, was marked by a very rapid increase in the use of electricity for lighting, traction and other purposes. Owing to the abundance of water-power to be obtained in the mountainous regions, these new undertakings proved very successful. Spain is, on the whole, a country whose production falls far short of her own requirements. With a protected home market, cheap power and cheap labour available, there is room for much industrial development. It is, however, noteworthy that Spanish capitalists are, as a class, though exclusive of the Catalans, unduly conservative. Hence the capital for the establishment of electrical industries was

almost exclusively subscribed in Germany, France, Belgium, Switzerland and the United States, just as, in the 19th century, the railways and mining industries had been mainly financed by British investors, and the Valencian silk industry by French. Another feature of the period of reconstruction was the formation of numerous trusts or combinations of producing companies designed to take advantage of the high tariff, and to restrict competition, lower expenses and raise prices. The paper, sugar, salt petroleum and metallurgical industries were subjected to this process, but in no case was it possible to secure a complete monopoly.

Commerce.—Possessing varied resources and being favourably situated for commerce, Spain might be expected to take a leading place among the trading communities of Europe. This it did at one time hold, when the treasure acquired by the discovery of America and the conquest of Mexico and Peru was squandered in the purchase of various commodities from England, the Netherlands and other countries. This period of outward prosperity, however, was also that in which the seeds of decline were planted. The expulsion of the Moors from Granada was contemporaneous with the discovery of the New World. Hundreds of thousands of Moors were driven out from the country on subsequent occasions, and in the act Spain lost the best of her agriculturists and handicraftsmen. The Spaniards of that day, excited by the hope of rapidly acquired wealth and the love of adventure, embarked upon a career of discovery, and agriculture and manufacturing industry fell into contempt. The loss of all her possessions on the American mainland in the early part of the 19th century dealt a severe blow to the foreign commerce of Spain, from which it only recovered about 1850, when imports and exports began to increase. After the restoration of the Bourbons in 1875, the first cabinet of Alphonso XII.'s reign stopped the operation of the tariff law of the Revolution and reverted to protection. In 1882 a Liberal cabinet revived the system of a gradual reduction of import duties to a fixed maximum, and made commercial treaties with France and several other nations, which were followed by a treaty with Great Britain in 1886. The foreign commerce of Spain rapidly developed in the decade 1882–1892, Great Britain, France and the United States figuring at the head of the imports, Great Britain and France at the head of the exports. The exports of Spanish wines to France alone amounted to £12,000,000 annually. When France and other European nations abandoned free trade for protection towards 1890, a strong movement set in in Spain in favour of protection. In 1890 the Conservative cabinet of Señor Canovas raised the duties on agricultural products, in 1891 it denounced all the treaties of commerce that included most-favoured-nation treatment clauses, and in 1892 a new tariff law established considerably higher duties than those of 1882—in fact, duties ranging from 40% to 300%. The subsequent revision of the tariff, completed in 1906, involved no serious departure from the economic policy adopted in 1890.

The following table shows the value of Spanish imports and exports for a number of representative years after 1848:—

Year.	Imports.	Exports.
	£	£
1849	6,360,000	5,240,000
1860	14,833,000	10,982,000
1865	16,262,000	12,864,000
1870	20,876,000	15,982,000
1875	22,812,000	18,081,000
1880	28,482,000	25,999,000
1885	30,590,000	27,920,000
1890	37,646,000	37,510,000
1895	33,540,000	32,198,000
1900	34,496,000	28,955,000
1905	32,320,000	50,012,000

The principal exports include metals and other minerals; wine, sugar, fruit and other alimentary substances, cotton and its manufactures; animals and their products, including wool and hair; timber and wrought wood. The principal imports include grain, dried fish and other food-stuffs; livestock and animal products; machinery, vehicles and ships; stone, minerals, glass and pottery; drugs and chemical products; textiles and raw cotton. Great Britain, France, the United States, Germany and Portugal, named in the order of their importance, are the chief consumers of Spanish exports. The chief exporters to Spain (in the same order) are Great Britain, France, Cuba, Germany and Portugal. The foreign trade of the country is of course carried on mainly by sea, and of the land commerce by far the largest proportion is with or through France. The smallness of the trade with Portugal is partly due to the similarity of the chief products of the two countries.

Shipping and Navigation.—Spain has 21 seaboard provinces, with more than 120 ports of some importance. The merchant navy of Spain, far from decaying through the loss of her colonies in 1898, seems to have been given fresh impetus. Many English and French steamers have been purchased abroad and nationalized. In 1905 the mercantile marine comprised 449 steamships of 434,846 tons, and 541 sailing vessels of 85,583 tons. The sailing vessels are decreasing in numbers in the exterior trade, but not in the coasting

trade, which is decidedly developing and occupying more craft. It is carried on exclusively under the Spanish flag. The fishing fleet, chiefly sailing boats, is also important, and is manned by a hardy and active coast population. In 1905 19,722 ships of 16,595,267 tons entered, and 18,033 of 16,442,355 tons cleared.

Banking and Credit.—The Bank of Spain (Banco de España) has a charter which has been renewed and enlarged several times since its foundation after the Restoration, and its privileged note issue has had to be gradually and very largely increased by legislative authorizations, especially in 1891 and 1898, as its relations with the treasuries of Spain and of her colonies increased; since nothing in the services rendered by the bank to the public would ever have justified the growth of the note issue first to thirty millions sterling in 1891, then by quick strides to fifty and over sixty-one millions sterling in 1899 and 1900. At the close of the 19th century the remodelled bank charter, which is only to expire in 1921, authorized a maximum issue of £100,000,000, on condition that the bank keeps cash in hand, gold and silver in equal quantities, equal to a third of the notes in circulation up to £60,000,000, and equal to half the amount issued above that sum. Gold has practically disappeared from business of every kind since 1881, when the premium began to rise; it reached a maximum of 120% during the war with America. Afterwards it dropped to about 30 in 1900. Bank-notes and silver coin have been practically the currency for many years.

Currency, Weights and Measures.—The metric system of weights and measures was officially adopted in Spain in 1859 and the decimal monetary system in 1871. In the case of the weights and measures the French names were also adopted, with only the necessary linguistic changes. Certain older standards remain in common use, notably the *quintal* (of 101.4 lb avoirdupois), the *libra* (1.014 lb avoirdupois), the *arroba* (3½ imperial gallons for wine, 2½ imperial gallons for oil), the *fanega* (1½ imperial bushels). In the case of the currency the old Spanish name of *peseta* was retained for the unit (the franc, 9½d.). The *peseta* is divided into 100 *centesimos*. According to its par value 25.225 pesetas are about equal to £1, but the actual value of the peseta is about 7½d. In law, there is a double standard of value, silver and gold, in the ratio of 15½ to 1. But the only silver coin which is legal tender up to any amount is the 5-peseta piece, and the coinage of this is restricted. One-peseta pieces in silver, and 20-, 10- and 5-peseta pieces in gold are also current. Before the introduction of the decimal monetary system the peseta was the fifth part of a *peso duro*, which was equal to 20 *reales de vellon*, or rather more than a 5-franc piece. The only paper money consists of the notes of the Bank of Spain.

Finance.—Spanish finance passed through many vicissitudes during the 19th century. In the reigns of Ferdinand VII. and Isabella II. the creditors of the state had to suffer several suspensions of payments of their dues, and reductions both of capital and interest. During the Revolution, from 1868 to 1874, matters culminated in bankruptcy. Payments of interest were only in part resumed after the Restoration in 1876, and in 1882 the government of King Alphonso XII. proposed arrangements to consolidate the floating and treasury debts of the Peninsula in the shape of £70,000,000 of 4% stock, redeemable in 40 years, and to reduce and consolidate the old exterior and interior debts, then exceeding £480,000,000, in the form of £78,840,000 of exterior 4% debt—exempt from taxation under an agreement to that effect with the council of foreign bondholders in London on the 28th of June 1882—and £77,840,000 of perpetual interior 4%. The colonial debts were not included in those plans. The debts of Spain were further increased in 1891 by a consolidation of £10,000,000 of floating debt turned into 4% redeemable stock similar to that of 1882; and this did not prevent a fresh growth of floating debts out of annual deficits averaging two to three millions sterling during the last quarter of the 19th century. The floating debt in 1900 had swollen to £24,243,300. The government of Spain having guaranteed the colonial debts of Cuba and of the Philippines, when those colonies were lost in 1898, Spain was further saddled with £46,210,000 of colonial consolidated debts, and with the expenses of the wars amounting, besides, to £63,257,000. Consequently, the Spanish government had once more to attempt to make both ends meet by asking its creditors to assent to the suppression of all the amortization of imperial and colonial debts, and to a tax of 20% on the coupons of all the debts, whilst at the same time the Cortes were asked to authorize a consolidation and liquidation of the floating and war debts and an annual increase of £3,200,000 in already heavy taxation. Under these modifications the Spanish debt at the close of the 19th century, exclusive of £44,000,000 of treasury debt, consisted of £41,750,000 of exterior debt, still temporarily exempted from taxation on the condition of being held by foreigners, of £270,000,000 of 4% interior consols, and of £60,000,000 of new 5% consols, replacing the war and floating debts. In January 1905 this total outstanding debt of £415,750,000 had been reduced to £381,833,000; the capital sum was thus approximately equal to £20 8s. per head of the population, and the annual charge amounted to about 17s. 6d. per head. Between 1885 and 1905 the revenue of Spain varied from £30,000,000 to £40,000,000, and the expenditure was approximately equal; deficits were common towards the beginning of this period, surpluses towards the end. For an analysis of the budget the year 1908 may be taken as typical, inasmuch as trade had then resumed its normal condition, after

the disturbing influence of tariff revision in 1906 and the failure of many crops in 1907. The estimates for 1908 showed that the revenue was derived as follows: Direct taxes on land, houses, mines, industry and commerce, livestock, registration acts, titles of nobility, mortgages and salaries paid by the state, £18,020,800; indirect taxes, including customs, excise, tolls and bridge and ferry dues, £14,748,000; tobacco monopoly, lottery, mint, national property, balance from public treasury, &c., £8,858,400; total £41,627,200. The principal items of expenditure were: Public debt, £16,199,300; ministry of war, £6,301,100; ministry of public works, &c., £3,679,540; pensions, £2,881,400. The total was £40,926,740.

Constitution and Government.—Spain is an hereditary monarchy the constitution of which was voted by the Cortes and became the fundamental law of the 30th of June 1876. This law fixes the order of succession as follows: should no legitimate descendant of Alphonso XII. survive, the succession devolves first upon his sisters, next upon his aunt and her legitimate descendants, and finally upon the legitimate descendants of the brothers of Ferdinand VII. "unless they have been excluded." Should all lines become extinct, the nation may elect its monarch. The sovereign becomes of age on completing his or her sixteenth year. He is inviolable, but his ministers are responsible to the Cortes, and none of his decrees is valid unless countersigned by a minister. The sovereign is grand-master of the eight Spanish orders of knighthood, the principal of which is that of the Golden Fleece (Toison de Oro), founded in 1431 by Philip of Burgundy. The chain of this order surrounds the royal arms, in which are included, besides the arms of Castile, Leon, Granada, and the lilies of the royal house of Bourbon, the arms of Austria, Sicily, Savoy, Brabant and others. The national colours are red and yellow. The flag is divided into three horizontal stripes, two red stripes with a yellow one between bearing the royal arms.

The legislative authority is exercised by the sovereign in conjunction with the Cortes, a body composed of two houses—a senate and a chamber of deputies. The senate is composed of members of three classes: (1) members by right of birth or office—princes, nobles who possess an annual income of 60,000 pesetas (£2,400), and hold the rank of grandee (*grande*), a dignity conferred by the king either for life or as an hereditary honour, captains-general of the army, admirals of the navy, the patriarch of the Indies, archbishops, cardinals, the presidents of the council of state or of the Supreme Court, and other high officials, all of whom must have retained their appointments for two years; (2) members nominated by the sovereign for life; and (3) members elected three each by the 49 provinces of the kingdom, and the remainder by academies, universities, dioceses and state corporations. The members belonging to the first two classes must not exceed 180 in number, and there may be the same number of members of the third class. The senatorial electors in the provinces are (1) delegates of the communes and (2) all the members of the provincial council, presided over by the governor. The lower house of the Cortes was elected by a very limited franchise from 1877 to 1890, when the Cortes passed a reform bill which became law on the 29th of June 1890. This law re-established universal male suffrage, which had existed during the Revolution, from 1869 to 1877. Under the law of the 29th of June 1890 every Spaniard who is not debarred from his civil and civic rights by any legal incapacity, and has resided consecutively two years in his parish, becomes an elector on completing his twenty-fifth year. Soldiers and sailors in active service cannot vote. All Spaniards aged 25 who are not clerks in holy orders can be elected. The same electoral law was extended to the municipal elections.

The executive administration is entrusted to a responsible ministry, in which the president generally holds no portfolio, though some prime ministers have also taken charge of one of the departments. The ministerial departments are: Foreign affairs, grace and justice, finance, interior, war, education and fine arts, marine, public works, and agriculture and commerce. Under the secretary of state for the interior the civil administration in each province is headed by a governor, who represents the central power in the provincial council (*diputacion provincial*) which is also elected by universal suffrage. The provincial councils meet yearly, and are permanently

represented by a committee (*commission provincial*), which is elected annually to safeguard their interests. Every commune or municipality has its own elected *ayuntamiento* (*q.v.*), which has complete control over municipal administration, with power to levy and collect taxes. Its members are styled *regidores* or *concejales*, and half their number is elected every two years. They appoint an *alcalde* or mayor from among themselves to act as president, chief executive officer, and justice of the peace. In the larger towns the *alcalde* shares his responsibilities with several permanent officials called *tenientes alcaldes*. The fundamental law of 1876 secures to *ayuntamientos*, and to the provincial councils, an autonomy which is complete within its own limits. Neither the executive nor the Cortes may interfere with provincial and communal administration, except when the local authorities exceed their legal power to the detriment of public interests. This provision of the constitution has not always been strictly observed by the government.

Law and Justice.—Spanish law is founded on Roman law, Gothic common law, and the national code proclaimed at the meeting of the Cortes at Toro in 1501 (the *leyes de Toro*).

The present civil code was put into force on the 1st of May 1889 for the whole kingdom. The penal code dates from 1870, and was modified in 1877. The commercial code was put into force on the 22nd of August 1885, the code of civil procedure on the 1st of April 1881, and the code of criminal procedure on the 22nd of June 1882. There is a court of first instance in each of the 495 *partidos judiciales*, or legal districts, into which the kingdom is divided. From this inferior jurisdiction the appeals go to the 15 *audiencias territoriales*, or courts of appeal. There is in Madrid a Supreme Court, which is modelled upon the French Cour de Cassation, to rule on points of law when appeals are made from the decisions of inferior courts, or when conflicts arise between civil and military jurisdiction. When the law of the 20th of April 1888 established trial by jury for most crimes and delicts, 49 *audiencias criminales*, one in each province, were created; these are a sort of assize held four times a year. The administration of justice is public. The parties to a suit must be represented by counsel. The state is always represented in every court by *abogados fiscales*, public prosecutors, and counsel who are nominees of the Crown.

Religion.—Roman Catholicism is the established religion, and the Church and clergy are maintained by the state at an annual cost of about £1,600,000. The relations between Church and state, and the position of the religious orders, were defined by the concordat of 1851, remaining practically unchanged until 1910. There are ten archbishoprics (Toledo, Madrid, Burgos, Granada, Santiago, Saragossa, Seville, Tarragona, Valencia and Valladolid) and forty-five bishoprics. The archbishop of Toledo is primate. The number of monastic communities is about 3250, including some 600 convents for men and 2650 for women. Most of the religious orders carry on active educational or charitable work. The monks number about 10,000, the nuns 40,000. The immense majority of the people are professed adherents of the Roman Catholic faith, so that, so far as numbers go, Spain is still the most "Catholic" country in the world, as it has long been styled. With liberty of conscience during the Revolution, from 1868 to 1877, the Church lost ground, and anti-clerical ideas prevailed for a while in the centres of republicanism in Catalonia and Andalusia; but a reaction set in with the Restoration. The governments of the Restoration showed the Church much favour, allowed the Jesuits and religious orders of both sexes to spread to an extent without precedent in the century, and to take hold of the education of more than half of the youth of both sexes in all classes of society. This revival of Church and monastic influence began during the reign of Alphonso XII., 1877–1885, and considerably increased afterwards under the regency of Queen Christina, during the long minority of Alphonso XIII., the godson of Pope Leo XIII. Spanish codes still contain severe penalties for delicts against the state religion, as writers frequently discover when they give offence to the ecclesiastical authorities. Blasphemy is punished by imprisonment. The bishops sit in the superior council of education, and exercise much influence on public instruction. Since 1899 all boys have been obliged to attend lectures on theology and religion during six out of seven years of their curriculum to obtain the B.A. degree. Canon law and Church doctrine form an obligatory part of the studies of men qualifying for the bar and magistracy. By the constitution of 1876 non-Catholics were only permitted to exercise their form of worship on condition that they did so in private, without any public demonstration or announcement of their services. The same rule applies to their schools, which are, however, numerous, especially in Madrid, Seville, Barcelona and other towns, by children of Protestant families and of many Roman Catholics also. A proposal to abolish these restrictions was made by the government in 1910 (see *History*, below).

Education.—A law of the 17th of July 1857 made primary education free for the poor, and compulsory on all children of school age,

originally fixed at six to nine years. It proved impossible to enforce this statute, and the majority of Spaniards are still illiterate, though in decreasing proportion at each census. The primary schools for both sexes are kept up by the municipalities, at an annual cost of about £1,000,000, to which the state contributes a small subvention. The secondary schools, of which there must be at least one in every province, are styled institutes and are mostly self-supporting, the fees paid by the pupils usually cover the expenses of such establishments, which also receive subsidies from some of the provincial councils. Spain has nine universities: Madrid, the most numerous attended; Salamanca, the most ancient; Granada, Seville, Barcelona, Valencia, Santiago, Saragossa and Valladolid. There are also a faculty of medicine at Cadiz and a faculty of law at Oviedo. Most of the universities are self-supporting from the fees of matriculations and of degrees. The state also maintains a variety of technical schools, for agriculture, engineering, architecture, painting, music, &c. The whole system of public instruction is controlled by the minister of education and an advisory council. A law passed on the 1st of July 1902 requires that all private schools must be authorized by the state, and arranges for their periodical inspection, for the enforcement of proper sanitation and discipline, and for the appointment of a suitable staff of teachers. Among the institutions affected by this law are numerous Jesuit and other ecclesiastical schools for boys, and a Jesuit university at Deusto, near Bilbao, whose pupils have to pass their final secondary examinations and to take all degrees in the state establishments as free scholars. The education of girls has been much developed not only in the state schools but even more so in the convents, which educate more than half the girls of the upper and middle classes. Many girls attend the provincial institutes, and some have successfully gone in for the B.A. degrees and even higher honours in the universities.

Defence.—The Spanish army is recruited by conscription. Liability to service begins with the first day of the calendar year in which the twentieth year is completed. Except in extraordinary circumstances, the war ministers have seldom called for more than forty to sixty thousand men annually, and of this contingent all who can afford to do so buy themselves off from service at home by payment of £60, and if drafted for colonial service by payment of £80. The period of service for all arms is twelve years—three with the colours, three in the first-class reserve, six in the second-class reserve, which contains the surplus of the annual contingent of recruits, and is liable to one month's training in every year. The war ministers can, and frequently do, send on unlimited furlough, or place in the first-class reserve, men who have not completed their first three years, and thus a considerable saving is made. Brothers can take each other's place in the service, and eldest sons of aged parents, or sons of widows, easily get exempted. Spain is divided into seven military regions or army corps. The strength of the regular army for many years varied between 85,000 and 100,000 in time of peace, and during the Carlist Wars, 1868 to 1876, Spain had 280,000 under arms, and nearly 350,000 during her more recent wars. For 1899–1900 the figures were only 80,000. The active army is divided into 56 regiments of the line with 2 battalions each, 20 battalions of rifles or cazadores, 2 Balearic Islands, 1 Melilla, 4 African battalions of light infantry, 2 battalions of rifles in the Canaries. The cavalry includes a squadron of royal horse guards, 28 regiments of the line, remount and dépôt establishments, 4 regional squadrons in Majorca, the Canaries, Ceuta, Melilla. The artillery comprises 12 regiments of field artillery, 1 of horse artillery, 3 regiments and an independent division of mountain guns, and 7 battalions of garrison artillery. The royal engineers are 4 regiments of sappers and miners, 1 of pontoons, 1 battalion of telegraph engineers, 1 of railway engineers with cyclists, 1 balloon corps, and 4 colonial corps. Other permanent military forces are 1075 officers, 1604 mounted and 16,536 foot gendarmes, mostly old soldiers, and 14,156 carabineers, all of them old soldiers. The regular army, at the close of the wars in 1898, had 26,000 officers and about 400 generals, but a law was afterwards made to reduce their numbers by filling only one out of two death vacancies, with a view to reach a peace establishment of 2 marshals, 25 lieutenant-generals, 50 divisional- and 140 brigadier-generals, and 15,000 officers. The total strength of the field army may be estimated at 220,000 combatants. The military academies are Toledo for infantry, Segovia for artillery, Valladolid for cavalry, Ávila for commissariat, Escorial for carabineers, Getafe

for civil guards, besides a staff college styled Escuela Superior de Guerra at Madrid. Numerous fortresses guard the Portuguese frontier and the passes of the Pyrenees, but many of these are ill-armed and obsolete.

The navy is recruited by conscription in the coast or maritime districts, which are divided into three naval captaincies-general, those of Ferrol, Cadiz and Cartagena—at the head of each being a vice-admiral. No attempt was made, during the decade which followed the Spanish-American War, to replace the squadrons destroyed at Manila and Santiago de Cuba. When the reconstruction of the navy was begun, in 1908, Spain possessed 1 battleship, 2 armoured cruisers, 6 protected cruisers, 5 destroyers and 6 torpedo-boats. All the larger vessels were old and of little value.

BIBLIOGRAPHY.—The following works are mainly topographical and descriptive: G. H. Borrow, *The Bible in Spain* (1st ed., London, 1843; with notes and glossary by Ulick R. Burke, London, 1899); Madaz, *Diccionario geográfico-histórico y estadístico de las provincias de España* (16 vols., 1846-1850); F. Coello, *Reseña geográfica, geológica, y agrícola de España* (Madrid, 1859); W. Webster, *Spain* (London, 1882); M. Willkomm, *Die pyrenäische Halbinsel* (3 vols., Leipzig, 1884-1886); E. de Amicis, *Spagna* (Florence, 1885; Eng. trans. *Spain and the Spaniards*, New York, 1885); R. del Castillo, *Gran diccionario geográfico de España* (4 vols., Barcelona, 1889-1892); R. Bazin, *Terre d'Espagne* (Paris, 1895); E. Pardo Bazán, *Por la España pintoresca* (Barcelona, 1895); R. Foulché-Delbosc, *Bibliographie des voyages en Espagne* (Paris, 1896); H. Gadow, *In Northern Spain* (London, 1897); J. Hay, *Castilian Days* (2nd ed., London, 1897); W. J. Root, *Spain and its Colonies* (London, 1898); K. L. Bates, *Spanish Highways and Byways* (London, 1900); A. J. C. Hare, *Wanderings in Spain* (8th ed., London, 1904); R. Thirlmere, *Letters from Catalonia* (2 vols., London, 1905). Valuable information can be obtained from the *Boletins* of the Madrid Geographical Society. *España, sus monumentos y artes, su naturaleza e historia* is an illustrated series of 21 volumes by various writers (Barcelona, 1884-1891). The "Spanish Series" of monographs on towns and cities, edited by A. F. Calvert (London, 1906, &c.), is noteworthy for descriptions of architecture and painting, and for the excellence of its many illustrations. The best guide-books are H. O'Shea, *Guide to Spain and Portugal* (London, 1899); R. Ford, *Murray's Handbook for Spain* (2 vols., London, 1906); and C. Baedeker, *Spain and Portugal* (Leipzig, 1908). *Stieler's Handatlas* (Gotha, 1907) contains the best maps for general use. The *Mapa topográfica de España*, published by the Instituto geográfico y estadístico de España in 1080 sheets, is on the scale of 1:50,000, or 1.26 in. = 1 m. For geology, see the maps and other publications of the Comisión del Mapa Geológico de España; L. Mallada, "Explicación del mapa geológico de España," in *Mem. com. mapa geol. Esp.* (1895, 1896, 1898 and 1902); C. Barrois, "Recherches sur les terrains anciens des Asturies et de la Galicie," in *Mém. soc. géol. du Nord*, vol. ii. (Lille, 1882); F. Fouqué, &c., "Mission d'Andalousie," in *Mém. pres. par divers savants à l'acad. des sciences*, ser. 2, vol. xxx. (Paris, 1889).

The chief authorities on flora and fauna are M. Willkomm, *Illustrationes florae hispanicae insularumque Balearium* (2 vols., Stuttgart, 1881-1892); M. Colmeiro, *Enumeración de las plantas de la Península* (vol. i., Madrid, 1885); G. de la Puerta, *Botánica descriptiva*, &c. (Madrid, 1891); B. Merino, *Contribución á la flora de Galicia* (Tuy, 1897); A. Chapman and W. J. Buck, *Wild Spain* (London, 1893); id. *Unexplored Spain* (London, 1910).

Modern social and political conditions are described by G. Routier, *L'Espagne en 1897* (Paris, 1897); E. Pardo Bazán, *La España de ayer y la de hoy* (Madrid, 1899); *L'Espagne: politique, littérature, armée, &c., numéro spécial de la Nouvelle Revue Internationale* (Paris, 1900); J. R. Lowell, *Impressions of Spain* (London, 1900, written 1877-1880 when Lowell was American minister to the court of Spain); P. Gotor de Burbáguena, *Nuestras costumbres* (Madrid, 1900); R. Altamira y Creva, *Psicología del pueblo español* (Madrid, 1902); V. Amiral, *El Catalanismo* (Barcelona, 1902); J. Alenda y Mira, *Relaciones de solemnidades y fiestas públicas de España* (Madrid, 1903); Madrazo, *El Pueblo español ha muerto?* (Santander, 1903); V. Gay, *Constitución y vida del pueblo español* (Madrid, 1905, &c.); H. Havelock Ellis, *The Soul of Spain* (London, 1908).

A comprehensive account of such matters as population, industry, commerce, finance, mining, shipping, public works, post and telegraphs, railways, education, constitution, law and justice, public health, &c., may be found in the following works; all those of which the place and date of issue are not specified are published annually in Madrid: *Censo de la población de España: 1900* (Madrid, 1902, &c.); *Movimiento de la población de España*; British Foreign Office Reports (annual series and miscellaneous series, London); *Estadística general de comercio exterior de España con sus provincias de ultramar y potencias extranjeras, formada por la dirección general de Aduanas*; Annual Reports of the Council of the Corporation of Foreign Bondholders (London); *Estadística mineral de España*; *Memoria sobre las obras públicas*; *Anuario oficial de correos y telégrafos de España*; *Situación de los ferro-carriles*; *Anuario de la primera enseñanza*; H. Gmelin, *Studien zur spanischen Verfassungsgeschichte des neunzehnten Jahrhunderts* (Stuttgart, 1905); R. de

Olorz, *La Constitución española comparada con las de Inglaterra, Estados-Unidos, Francia y Alemania* (Valencia, 1904); T. Gomez Herrero, *Diccionario-guia legislativo español* (5 vols., Madrid, 1901-1903); *Estadística de la administración de justicia en lo criminal durante*; *Boletín mensual de estadística demográfica-sanitaria de la península y islas adyacentes* (Madrid, monthly); *Estado general de la armada para el año*; C. Fernandez Duro, *Armada española desde la union de los reinos de Castilla y de Leon* (9 vols., Madrid, 1895-1903); *Boletín oficial del ministerio de marina.* (K. G. J.)

HISTORY

A.—Ancient to A. D. 406.

Primitive Inhabitants.—The origin and character of the early inhabitants of the Peninsula are unknown; recent conjectures on the subject, which have been many, are more bold than probable, and we must await the result of further excavations of prehistoric sites and further inquiries into the native inscriptions before we can hope for much certainty. The Romans, whose acquaintance with the country began in the 3rd century B.C., mention three races: Iberians (in the east, north and south), Celts (north-west) and Celtiberians (centre), but the classification does not help us far. The use to-day of the strange and ancient Basque tongue on the western slopes of the Pyrenees and in Vizcaya (Biscay)—a tongue which is utterly unlike Celtic or Italian or any "Indo-Germanic" language—suggests that the Iberians may have been an older people than the Celts and alien from them in race, though the attempts hitherto made to connect Basque with ancient traces of strange tongues in the Basque lands have not yielded clear results. On the other hand, numerous place-names show that parts of the Peninsula were once held by Celtic-speaking peoples, and it is, of course, possible that Celts and Iberians may have formed a mixed race in certain regions. Of other ancient races little trace can be detected. The Phoenicians were here traders and not settlers; the Greeks, though they planted early colonies on the Gulf of Lyons, occupied hardly any site south of the Pyrenees, and the seeming likeness in name of Saguntum (*q.v.*) and the Greek island Zacynthus is mere coincidence. It is possible, however, that after the Roman conquest Italians drifted in, and it is fairly certain that after the Roman Empire fell German conquerors brought German settlers, though in what numbers no wise man will guess.

Earliest Historic Period.—Phoenician traders probably reached Spain long before our historical knowledge of the Peninsula begins, possibly as early as the 11th century B.C. One of their earlier settlements, Gades (now **The Phoenicians.** Cadiz), has been called the oldest town in the world (or in Europe) which has kept a continuity of life and name from its first origin. But the Phoenician exploitation of Spain dates principally from after the rise of Carthage (*q.v.*), the great Phoenician city of North Africa. Carthaginian "factories" were planted on many Spanish coasts: a Nova Carthago (New Carthage, mod. Cartagena) formed a Carthaginian fortress with the best harbour of south-eastern Spain. The expansion is attributed chiefly to the second half of the 3rd century B.C., and to the genius of the Carthaginian statesman, Hamilcar Barca, who, seeing his country deprived by Rome of her trading dominion in Sicily and Sardinia, used Spain, not only as a source of commercial wealth, but as an inexhaustible supply of warlike troops to serve in the Carthaginian armies. But Rome had already her eyes on the Spanish men and mines, and, in the second Punic War, drove Carthage finally and completely out of the Peninsula (201 B.C.).

Roman Spain.—The Romans divided Spain into two "spheres of administration" (*provinciae*), Hither or Citerior, that is the northern districts which were nearer to Italy, and **Republican** Further or Ulterior, the south. To each "province" **Period,** was sent yearly a governor, often with the title **200-27B.C.** *proconsul*. The commands were full of military activity. The south, indeed, and in particular the fertile valley of Andalusia, the region of the Guadalquivir (*Baetis*), then called Baetica, was from the first fairly peaceful. Settlements of Italian veterans or of Spanish soldiers who had served for Rome were made at Hispalis (Seville) and at Carteia near

Gibraltar, and a beginning was made of a Romanized provincial population, though in a somewhat half-hearted way. But in the north, on the high plateau and amidst the hills, there was incessant fighting throughout the greater part of the 2nd century B.C., and indeed in some quarters right down to the establishment of the empire. The Carthaginians had extended their influence no great distance from the eastern coast and their Roman successors had all the work to do. In the long struggle many Roman armies were defeated, many commanders disgraced, many Spanish leaders won undying fame as patriot chiefs (see NUMANTIA). Even where one Roman succeeded, the incapacity or the perfidy of his successor too often lost the fruits of success. But though its instruments were weak the Republic was still strong, and the struggle itself, a struggle quite as much for a peaceful frontier as for aggrandizement and annexation of fresh land, could not be given up without risk to the lands already won. So the war went on to its inevitable issue. Numantia, the centre of the fiercest resistance, fell in 133 B.C. before the science of Scipio Aemilianus (see SCIPIO), and even northern Spain began to accept Roman rule and Roman civilization. When in the decade 80-70 B.C. the Roman Sertorius (*q.v.*) attempted to make head in Spain against his political enemies in Rome, the Spaniards who supported him were already half Romanized. There remained only some disturbed and unconquered tribes in the northern hills and on the western coast. Some of these were dealt with by Julius Caesar, governor here in 61 B.C., who is said also to have made his way, by his lieutenant Crassus, to the tin mines of the north-west in Galicia. Others, especially the hill tribes of the Basque and Asturian mountains fringing the north coast, were still unquiet under Augustus, and we find a large Roman garrison maintained throughout the empire at Leon (*Legio*) to overawe these tribes. But behind all this long fighting, pacification and culture had spread steadily. The republican administration of Spain was wise. The Spanish subjects were allowed to collect themselves the taxes and tribute due to Rome, and, though the mineral wealth doubtless fell into the hands of Roman capitalists, the natives were free from the tithes and tithe system which caused such misery and revolt in the Roman province of Sicily. On the other hand, every facility was given them to Romanize themselves; there was no competing influence of Hellenic or Punic culture and the uncivilized Spaniards accepted Roman ways gladly. By the days of Cicero and Caesar (70-44 B.C.) the southern districts, at least, had become practically Roman: their speech, their literature, their gods were wholly or almost wholly Italian, as Cicero and Strabo and other writers of these and the next few years unanimously testify. Gades, once Phoenician, gained, by Caesar's favour and the intercession of Balbus, a Roman municipal charter as *municipium*: that is, its citizens were regarded as sufficiently Romanized to be granted both the Roman personal franchise and the Roman city-rights. It was the first city outside of Italy which obtained such a municipal charter, without the usual implantation of Roman citizens (either poor men needing land or discharged veteran soldiers) from Italy.

Augustus (or Tiberius possibly) reorganized the administration of Roman Spain. Henceforward there were three provinces: (a) the north and north-west, the central table-land and the east coast as far south as New Carthage, that is, all the thinly-populated and unquiet hill country, formed the province of *Tarraconensis* with a capital at Tarraco (Tarragona) under a *legatus Augusti pro praetore* with a legion (VII. Gemina) at Leon and some other troops at his disposal; (b) the fertile and peaceful west formed the province of Lusitania, very roughly the modern Portugal, also under a *legatus Augusti pro praetore*, but with very few troops; (c) the fertile and peaceful south formed the province of Baetica, called after its chief river, the Baetis, under a proconsul nominated by the senate, with no troops. These divisions (it will be observed) exactly coincide with the geographical features of the Peninsula. Substantially, they remained till

the end of the empire, though *Tarraconensis* was broken up at different dates into smaller and more manageable areas. Augustus also accelerated the Romanization of the land by planting in it many municipalities (*coloniae*) of discharged soldiers, such for example as Augusta Emerita (mod. Mérida), which declares by its name its connexion with time-expired veterans and still possesses extensive Roman ruins. Either now, too, or soon after, imperial finance agents (*procuratores*) were appointed to control the revenues and also to look after the mines, which now became Imperial property, while a special *praefectus* administered the Balearic Islands. The two principal features of the whole country during the imperial period are its great prosperity and its contributions to Roman literature. Shut off from foreign enemies (though occasionally vexed by pirates from Africa), secluded from the wars of the empire, it developed its natural resources to an extent unequalled before or since. Its iron and copper and silver and lead were well known: it was also (according to the elder Pliny) the chief source whence the Roman world obtained its tin and quite outdistanced in this period the more famous mines of Cornwall. But such commercial prosperity characterized many districts of the empire during the first two centuries of our era. Spain can boast that she supplied Rome with almost her whole literature in the silver age. The Augustan writers had been Italians. When they passed away there arose in their places such writers as the younger Seneca, the epic poet Lucan, the epigrammatist Martial, the literary critic Quintilian, besides a host of lesser names. But the impulse of the opening empire died away and successful commerce drove out literary interests. With the 2nd century the great Roman-Spanish literature ceased: it was left to other regions which felt later than Spain the stimulus of Romanization to enter into the literary tradition. Of statesmen the Peninsula was less prolific. The emperor Trajan, indeed, and his relative and successor Hadrian, were born in Spain, but they were both of Roman stock and Roman training. The 3rd and 4th centuries saw a decline in the prosperity of Roman Spain. The confiscations of Septimus Severus and the ravages of barbarians in the middle of the 3rd century have both been adduced as causes for such a decline. But while we need not doubt that the decline occurred, we can hardly determine either its date or its intensity without careful examination of the Roman remains of Spain. Many of the best Roman ruins—such as the aqueduct of Segovia or the bridge of Alcantara—no doubt date from before A.D. 200. Others are probably later, and indicate that prosperity continued here, as it did on the other side of the Pyrenees in Gaul, till the later days of the 4th century—perhaps indeed not till the fatal winter's night in 406-7 when the barbarians burst the Rhine frontier and flooded Gaul and even Spain with a deluge from which there was no recovery.

(F. J. H.)

B.—From A.D. 406 to the Mahomedan Conquest.

The Barbarian Invasion and the Visigothic Kingdom.—With the irruption of the Vandals, the Suebi and the Alans, the history of Spain enters on a long period of division and confusion which did not end even with the union of the chief kingdoms by the marriage of Isabella and Ferdinand at the close of the 15th century. The function of the barbarians everywhere was to cut the communications of commerce, and the nerves of the imperial administration, thereby throwing the invaded country back into a fragmentary condition from which a new order was to arise in the course of centuries.

This function was effectually discharged in Spain by the Vandals and their associates, who plundered far and wide, and then by the Visigoths, who appeared as the "foederati," or duly commissioned defenders of the Romans. The first-comers cannot be said to have conquered the country in the sense that they established a rule of their own. They were not numerous enough for the execution of such a task, even if they had possessed the capacity. When in 428 Gaiseric, king of the Vandals (*q.v.*), accepted the invitation of Bonifacius, the count of Africa, and passed out

Vandals and Suebi.

of Spain to found the Vandal kingdom of Carthage, his whole horde numbered only 80,000 persons, including old men, women and children, and runaway slaves who had joined him. The Suebi, who remained, were certainly not more numerous. Such small bodies could not have occupied so extensive a territory, even if they had scattered themselves in driblets all over its surface. What they did was to rove about in hordes, plundering or levying blackmail. The cowed inhabitants had been trained out of all habit of acting for themselves by the imperial despotism, and could only flee or submit. There is probably some truth in the assertion of Salvian that many of the subjects of the empire preferred poverty among the barbarians to the tyranny of the imperial tax collectors. This would be pre-eminently the case with the smaller landowners who formed the "curiales," and who were in reality serfs of the fisc, for on them fell the main weight of taxation, and they were confined to their position by oppressive laws. The great landowners who formed the "ordo senatorius" had almost as much to fear from the agrarian insurgents known as *bagaudae*, who are indeed found acting with the Suebi, as from the barbarians. In time some of them took to "living barbarously"—that is to say, they fortified their villas, collected an armed following and fought for their lives, families and property. In some districts the inhabitants reverted to a state of tribal independence. This undoubtedly was the case in the north, where the Asturians and Basques, the least Romanized part of the population, appear from the beginning of the age of barbarization as acting for themselves. In the mountain country of Cuenca, Albacete, and the Sierra Nevada the natives known as the Orosipedans were entirely independent in the middle of the 6th century. But if there lay in this revival of energy and character the germs of a vigorous national life, for the time being Spain was thrown back into the state of division from which it had been drawn by the Romans—with the vital difference that the race now possessed the tradition of the Roman law, the municipalities, and one great common organization in the Christian Church.

No help was to be expected from the empire. Unable to aid itself it had recourse to the Visigoths (see GORNS). Ataulphus (*q.v.*) the successor of Alaric, and the husband of *Visigothic Occupation.* Placidia, daughter of the emperor Theodosius, whom he had married against the wish of her brother Honorius, entered Spain in 412, as the ally of the empire. He was murdered in 415, but after the speedily ensuing murder of his murderer and successor Sigeric, Wallia (415-419), who was elected to the kingdom, continued his work. He destroyed the Alans, and drove the Vandals and Suebi into the north-west. Then he handed Spain back to the imperial officials, that is to say, to weakness and corruption, and marched with all his people into the Second Aquitaine, the south-west of modern France, which had been assigned to them by Honorius as a home and a reward. From this date till the very end of the reign of Amalaric (511-531), the seat of the Visigothic kings was at Bordeaux, or Toulouse or Narbonne, and their main interests were in Gaul. They continued to intervene in Spain and to extend their influence over it. But for an interval of more than twenty-five years they stood apart. Southern Spain was overrun and plundered by the Vandals before their departure for Africa. In 456 Theodoric II. (453-466) entered Spain as ally of Avitus, whom he had himself raised to the empire in Gaul. He defeated the Roman senators of the Tarraconensis and the Suebi, putting their king to death, and advanced as far as Mérida. But he was recalled to Gaul, and his return was accompanied by outrages against the Roman cities. Majorian (457-461), the last capable emperor of the West, proposed to make Spain the basis of his attack on the Vandals at Carthage till his fleet was destroyed by them in the harbour of Carthage. The fratricidal murderer and successor of Theodoric, Euric (466-485) followed his brother's policy in Spain. With the extinction of the Western Empire (476 or 479) the kings of the Visigoths became more and more the representatives of authority, which they exercised on Roman lines, and with an implied or formal deference to the distant emperor at Constantinople. But the continued existence of the

obscure Suevic kingdom in the north-west, the effective independence of several districts, and the rule of others by the Roman senators, proves that the regions actually under Visigothic rule were not extensive. After the defeat and death of Alaric II. (485-507) at Vouillé the shattered Visigoth power was preserved from destruction at the hands of the Frankish king Clovis (*q.v.*) by Theodoric, the Gothic king of Italy. But on his death the advance of the Franks began again. Amalaric (507-531) fled from Narbonne, to meet the usual violent end of a Visigothic king at Barcelona.

The line of the Visigothic kings of Spain begins, strictly speaking, with his successor Theudis (531-548), an Ostrogoth appointed by Theodoric to act as guardian of Amalaric. He had acquired great possessions in the valley of the *Visigothic Kingdom.* Ebro by marriage with a Roman lady. It was a *Kingdom.* government, and not a people, which was established in Spain with Theudis. The Visigoths had been much Romanized during their establishment in Gaul, and we hear of no exodus as having accompanied Amalaric. The example of Theudis is enough to show that the law of the Theodosian code which forbade the marriage of Romans and barbarians was not regarded by the Goths. It remained indeed unrepealed, as many laws have done since, long after it had become a mere dead letter. The government which came with Theudis, and fell to ruin with Roderic, may be described as having been at once Roman and bad. In so far as it was affected by the Visigoths it was influenced for the worse. Their monarchy was elective. Until the death of Amalaric the choice was confined to one family, but he was the last of his line. The kings tried to make the crown hereditary, and the nobles, Visigothic *seniores*, and Roman *senatores* seized every opportunity to keep it elective. Spain presented a forecast of the anarchy of Poland. Of the twenty-three kings between Theudis and Roderic five were certainly murdered, one was deposed, and three were tonsured by tricks or open force. Of the others some were passing phantoms, and the records of the later times of the kingdom are so obscure that we cannot be sure of knowing the names of all who perished by violence.

The administration which these kings of unstable authority had to direct was essentially the Roman system. The great owners, whether nominally Visigoth or nominally Roman—*seniores* or *senatores*—continued to enjoy all the privileges and exemptions of the *ordo senatorius* in the last days of the empire. They lived surrounded by multitudes of semi-servile *coloni*, or farmers, bound to the soil, of actual slaves, and of *buccelarei*, who were free swordsmen to whom they gave rations (*buccellatum*, soldiers' bread, or *buccella*, a portion). The *curiales* remained as before the victims of the fisc. How far the fact that Theudis and the four next sovereigns were Arians affected their government is not very clear. It prevented them from enjoying the active support of the Catholic clergy. But it is very doubtful whether Christianity had spread much beyond the cities. We hear of the conversion of pagans down to the last days of the Visigothic kingdom. The spread of Mahommedanism was so rapid in the first years after the conquest that it is impossible to believe that the country had been thoroughly christianized.

Theudis, who made his headquarters at Seville, endeavoured to complete his mastery of the diocese of Spain by occupying Mauritania Tingitana, but he was defeated by the *The Visigothic Kings.* imperial officers at Ceuta. He was in due course murdered at Seville by Theudigisel (548-549) who was himself promptly slain. The reigns of his two successors, Agila (549-554) and Athanagild (554-567), coincided with the reign of Justinian and the temporary revival of the Eastern Empire. Athanagild called on the imperial officers to help him against Agila, and paid for their assistance by the surrender of the province of Baetica. On his death there was an obscure interregnum of five months, which ended by the election of Liuva (567-572), the governor of Narbonne, the surviving remnant of the Visigoth power to the north of the Pyrenees. Liuva did not come to Spain, but associated his brother Leovigild (567-586) with him. The reigns of Leovigild and of his son Reccared are the greatest in the list of the Visigoth kingdom in

Spain. The father was manifestly a man of great energy who cowed his unruly nobles by murder, forced the Orosipedans to recognize his superiority, swept away the Suevic kingdom which had lingered in the north-west, and checked the raids of the Basques. To secure the succession in his family he associated his sons Hermenegild and Reccared with himself. He was the first Visigothic king who wore the crown, and it would appear that he threw off all pretence of allegiance to the empire. The series of the Visigothic gold coins begins with him, and it is to be noted that while the earliest are struck in the name of the emperor Justinian, the imperial superscription disappears in the later. Leovigild drove the imperial officers from Seville and Cordova, though they still retained control of the coast. His son Hermenegild, to whom he entrusted the government of Baetica, was married to a Frankish princess. Intermarriages had not been uncommon between Frank and Visigoth, but they had rarely led to any other result than to subject the Arian ladies who were sent from Spain, or the Catholic ladies who came from France, to blows and murder by their husbands and their husbands' families. Ingunda the Frankish wife of Hermenegild, with the help of Leandro, archbishop of Seville, the brother and predecessor of the more famous Isidore (*q.v.*), persuaded her husband to renounce Arianism. He revolted against his father, was reduced to submission and executed in prison.

The reign of Reccared (586-601) is famous in Spanish history for the establishment of Catholicism as the religion of the state. Reccared must have seen from the example of the Franks that the support of the Church was a great element of strength for the Crown. He made the change at the Third Council of Toledo. If Reccared hoped to secure the perpetuance of his dynasty he was mistaken. His son Liuva the second (601-603) was murdered by an Arian reaction headed by Witteric (603-610). The Catholics regained power by his overthrow, but they could not give stability to the state. A succession of obscure "priests' kings," who are but names, followed: Gunthemar (610-612), Sisebut (612-620), Reccared II. (620-621), Swintella, associated with his son Reccimer (621-631), Sisinand (631-636), Chintila (636-640), Tulga (640-641), Chindaswinth (641-652), Recceswinth (649-672). The growing weakness of the Merovingians saved them from serious attack, though not from occasional invasion on the north. The prostration of the empire in the East by Avar and Persian invasions enabled them to drive the imperial officers from the coast towns. But the kingdom was growing internally weaker. The nobles were strong enough to prevent the monarchy from becoming hereditary. The Church seemed to exert great power, but it had itself become barbarized by contact with kings and nobles. Violent persecutions of heretics and of the numerous Jews brought in new elements of discord. Wamba (672-680) is credited with an attempt to reform the state, but he was tonsured while unconscious from illness or poison, and disappeared into a religious house. His successors again are but names, Euric (680-687) and Egica (687-701). Witiza (697-710) has more substance. He was in aftertimes denounced as a monster of vice, whose sins accounted for the Mahommedan conquest. Contemporaries speak of him with respect, and he appears to have been a well-meaning man who endeavoured to check the corruption of the clergy and the persecution of the Jews, and who resisted the dictation of the pope. His reign ended in turmoil, and perhaps by murder. With Roderic, whose "tumultuous" election was the work of Witiza's enemies, the line of the Visigoth kings is considered to have ended.

The Visigoth kingdom presents an appearance of coherence which was very far from corresponding to the reality. At the head was the king, surrounded by his household of *leudes*, and aided by the palatines, great officers of state imitated from the imperial model. At the head of the provinces, eight in number, were dukes, and the cities were governed by counts. Both were, at least in theory, officers named by the king and removable by him. The king was advised by councils, made up by a combination of a senate of the great men, and of the ecclesiastical councils which had met under the Roman rule and that of the tolerant

**Organiza-
tion of the
Visigoth
Kingdom.**

Arian kings. The formation of the council was not complete until the establishment of Catholicism as the state religion. But from the reign of Reccared till the Arab invasion they met sixteen times in all, generally at Toledo in the church of Santa Leocadia. Purely ecclesiastical matters were first discussed by the clergy alone. Then the great men, Visigoth and Roman, joined with the clergy, and the affairs of the kingdom were debated. The *Leges Wisigothorum* were elaborated in these councils (see GERMANIC LAW). But there was more show than reality in this parade of government by free discussion and by law. There was no effective administration to enforce the law.

The Mahommedan Conquest.—How utterly weak it was can be seen from the fact that it was shattered by the feeble Moslem invasion of 711. The danger from Africa had been patent for half a century. During the reign of Witiza the Moslem masters of northern Africa had pressed the town of Ceuta, the last remnant of the Byzantine possessions, very closely, and it had been relieved by supplies from Spain. Only the want of ships had prevented the Mahommedans from mastering the town, and crossing the straits, and now this deficiency was supplied by the Christians themselves. It seems to be certain that Julian, the imperial count or governor of Ceuta, acting in concert with the family and faction of Witiza, who sought his help against Roderic, provided vessels to transport the Berber Tarik (*Tāriq*) across the straits. Tarik, the general of the caliph's governor in northern Africa, Mūsā b. Nosair, was invited as an ally by the conspirators, who hoped to make use of him and then send him back. He came with a small force, but with the certainty of finding allies, and on being joined by another detachment of Berbers marched inland. On the 19th of July 711 he met Roderic near the Lago de la Janda between Medina Sidonia and Vejer de la Frontera. He had perhaps already been joined by Spanish allies. It is at least certain that in the battle the enemies of Roderic passed over to the invader. The Visigoth king was routed and disappears from authentic history. There is some probability that he did not perish in the battle, but escaped to fall two years later, at Seguyjuela near Salamanca, in action with Merwan the son of Mūsā. A single blow delivered as much by Christian as by Moslem hands, sufficed to cut the bond which seemed to hold the kingdom together, and to scatter its fragments all over the soil of the Peninsula. Through these fragments Tarik marched without a single check of importance. Before the end of 711 he had advanced far north as Alcalá. Córdoba fell to a detachment of his army. In 712 Mūsā joined his lieutenant, and the conquest of the south was completed. Mérida was the only town which offered an honourable resistance. During 713 and 714 the north was subdued to the foot of the mountains, and when Mūsā and Tarik were recalled to Damascus by the caliph the progress of the Moslems was not delayed. In 718 they crossed the Pyrenees, and continued their invasions of Gaul till they met the solid power of the Austrasian Franks at Poitiers 732 (see CHARLES MARTEL and CALIPHATE, B. §§ 6, 10). The rush of the Mahommedan flood sent terror all over Europe, but the little opposition it encountered south of the Pyrenees is to be easily explained, and the victory, though genuine, was more specious than substantial. That the lieutenants of the caliph at Damascus should take the place of the Visigoth kings, their dukes and counts seemed to many no loss and to a still greater number a gain. The great landowners, to whom patriotism was unknown and whose religious faith was tepid, were as ready to pay tribute to the caliph as to render service to one of their own body who had become king by violence or intrigue. On the part of the Arabs, who, though a small minority of the invaders, were the ruling element, there was a marked absence of proselytizing zeal. They treated the occupation of Spain as a financial speculation more than as a war for the faith. The Arab, though he produced Mahommedanism, was the least fanatical of the followers of the Prophet, and was not only willing but desirous to leave to all men who would pay tribute the free exercise of their religion. He cynically avowed a greater liking for the poll tax

**Moslem
Invasion,
711.**

**The Ma-
hommedan
Conquest.**

**Character of
Arab Rule.**

paid by the Christian than for his conversion. The Spanish Roman and the Visigoth, so-called, of that epoch of poorness of spirit, accustomed as he was to compound with one master after another, saw nothing dishonourable in making such an arrangement. That it was made matter of record. In Murcia the duke whom the Arabs knew as Tadmir became a tributary prince, and his family retained the principality for generations. He no doubt contrived to induce the Arabs to recognize him as the owner of what had been public domain, and made an excellent bargain. The family of Witiza did obtain possession of an immense stretch of the land of the state in Andalusia on condition of paying tribute. One of them, by name Ardabast, was deprived of his holding at a later date on the ground that he held more land than could be safely left in the hands of a Christian. Everywhere landowners made the bargain, and the monasteries and the cities followed their example. Nor was submission and payment of tribute all that they were prepared to give. Many professed themselves converts to Mahommedanism. In the north one great Visigoth family not only accepted Islam, but founded a dynasty, with its capital at Saragossa, which played a stirring part in the 8th and 9th centuries, the Beni-Casi, or Beni-Lope. To the mass of the population the conquest was, for the present, a pure gain. The Jews, escaped from brutal persecution, were the eager allies of the Arabs. As the conquerors swept away the Roman fiscal system, which the Visigoths had retained, and replaced it by a poll tax (which was not levied on old men, women, children, cripples or the very poor) and a land tax, the gain to the downtrodden serfs of the fisc was immense. They acquired personal freedom. Add to this that a slave who professed Islam could secure his freedom, at least from slavery to a Christian master, that Arianism had not been quite rooted out, that the country districts were still largely pagan, and it will not appear wonderful that within a generation Mahommedan Spain was full of renegades who formed in all probability a majority of its population and a most important social and political element. The Arabs at first were content to take a fifth of the land to constitute the public domain, or *khoms*, out of which fiefs held on military tenure were provided for the chiefs of the conquering army.

If this moderate policy had been or could have been steadily pursued, the invaders would in all probability have founded a lasting state. But it could not be pursued, since it required for its application a consistency, and a power to act on a definite political principle, of which the Mahommedan conquerors were absolutely destitute. Nor had Spain been conquered by a single race. The invaders were a coalition of Arabs, Syrians and Berbers. The Arab was incurably anarchical, and was a noble who had no political idea except the tribal one. That their personal dignity must be asserted and recognized was the first article in the creed of these descendants of the heroes of the desert. They looked down on the Syrian, they thought the Berber a lout and a plebeian, they scorned the renegade, and called him a slave and son of a slave. They fought out the old tribal rivalries of Arabia on the banks of the Guadalquivir and on the Vega of Granada. They planted the Berber down on the bleak, ill-watered, and wind-swept central plateau. He revolted, and they strove to subdue him by the sword. He deserted his poor share of the conquered land, and in many cases returned to Africa. The conflict for the caliphate (*q.v.*) between Omayyad and Abbasid removed all shadow of control by the head of the Mahommedan world, and Spain was given up to mere anarchy. The treaties made with the Christians were soon violated, and it seemed as if Islam would destroy itself. From that fate it was preserved by the arrival in Spain of Abdurrahman (Abdarrahman b. Moawiya) the Omayyad (758), one of the few princes of his house who escaped massacre at the hands of the Abbasides. With the help of his clansmen among the Arabs, and to a large extent of the renegades who counted as his clients, by craft, by the sword, by keeping down the fanatical Berber element, and by forming a mercenary army of African negroes, and after thirty years of blood and battle, Abdurrahman founded the independent amirate, which in the 10th century became the caliphate of

Cordova. It was an Oriental monarchy like another, strong when the amir was a strong man, weak when he was not, but exceptionally rich in able men. Its rulers had to fight the Arab nobles as much as the Christians, and the real basis of their power was their slave army of negroes, or of Christian slaves, largely Slavonians sold by their German captors to the Jew slave traders of Verdun, and by them brought to Spain. These janissaries at first gave them victory, and then destroyed them.

Such a kingdom as this needed only attack from a more solidly organized power to be shattered. The Christian enemies of the Mahommedans were for long weak and no less *Christian States of the North* anarchical than themselves, but they were never altogether wanting, and they had, what the Arab and Berber had not, a tradition of law and a capacity for forming an organized polity and a state. They are to be sought for along the line of the mountains of the north. In the centre were the Basques, dwelling on both sides of the Pyrenees, who kept against the Mahommedan the independence they had vindicated against the Visigoth. On the east of the Basques, along the line of the Pyrenees, were others of kindred blood, who also kept a rude freedom on the slopes and in the valleys of the mountains. The Arab passed through them, going and returning to and from Gaul, but he never fully conquered them. The names of their leaders Garci Jimenez and Iñigo Arista are altogether legendary. But here were the roots of the kingdom of Navarre, of Sobrarbe and Aragon. In the earliest times their most pressing foe was not the Arab or Berber so much as the Carolingian. It was at their hands that Charlemagne (*q.v.*), while returning from his expedition to Saragossa, suffered that disaster to his rearguard at Roncesvalles which is more famous in poetry than important in history. With the aid of the Spanish Moslem Beni-Casi the Basques drove off the counts and wardens of the marches of the Carolingians. On the eastern extremity of the Pyrenees the Franks found no native free population. Here, mainly under the leadership of Louis the Pious, they formed the Marca Hispanica, where Frankish counts and wardens of the marches gradually gained ground. By the reign of Charles the Fat a principality had been founded. Wilfred the Hairy—the *Comes Vellusus*, so called because his countship was poor and covered with scrub wood, and not because the palms of his hands were covered with hair as the legend has it—became the founder of the counts of Barcelona.

The greatest destiny was preserved for the Christian remnant which stood out to the west of the Basques, in the mountains of Asturias. Pelayo, whom they chose for king, and his victory of Covadonga, are well nigh as legendary, and are quite as obscure as Garci Jimenes and Iñigo Arista. Yet it is certain that in this region were planted the seeds of the kingdom of Castile and Leon, the dominant power of the Spain of the future. The total silence of the contemporary chronicle, called by the name of Isidorus of Beja, shows that in the south of Spain, where the writer lived, nothing was known of the resistance made in the north. The next Christian authorities belong to the latter part of the 9th century. It is therefore with the warning that the dates can only be given as probably correct that the three first Christian kings can be said to have reigned from 718 to 757. Pelayo (718-737), his brother Favila (737-739)—of whom we only know that he is said to have been killed by a bear while hunting—and Alphonso I., the Catholic (739-757), stand as little more than names. While the invasion of Gaul was still going on Manuza, the chief of the Berbers settled in north-western Spain, had revolted against the caliph's lieutenants. In 740 came the great general revolt of the Berbers. In 750 plague, following on drought and famine, swept away thousands of conquered and conquerors alike. Amid the general desolation Alphonso I. duke of Cantabria and son-in-law of Pelayo, constituted the kingdom which the Arabs called Galicia. It answered *Kingdom of Gallicia* closely to the old Roman province of the same name—extending from the Bay of Biscay to the line of the Duero, from the ocean to the foot of the mountains of Navarre. Internally it was divided into two belts. Along the shores of the bay, and in the valleys of the mountains to the north and west it was inhabited;

but a great belt of desolation separated it from the regions in which the Moslem were fighting out their own quarrels. Alphonso swept all through that region, already more than half depopulated, slaying the lingering remnants of the Berbers, and carrying back the surviving Christians to the north. Behind that shield of waste the Christian kingdom developed; from the death of Alphonso I. to the reign of Ramiro II. (931-950) it was subject to no serious attack, though raids on the frontier never ceased. Norse pirates appeared on the coast in the 9th century, but made no permanent settlements. As the population grew, it pushed down to the plain of Leon and Castile. The advance is marked by the removals of the capital forward from Cangas de Oña to Oviedo, from Oviedo to Leon, and by the settlement of adventurous frontier men in the ancient Bardulia, which from their "peels," and towers of strength, gained the name of Castilla—the castles. Burgos became its centre. The Montaña (hill country) of Burgos, and in particular the district called the Alfoz of Lara, was the cradle of the heroes of the Castilian share in the reconquest—the count Porcellos, and the judge of the people, Lain Calvo, the infantes of Lara, the bastard Mudarra, and Ruy Diaz of Bivar, in whose lives legend and history are mingled beyond disentanglement, and of whom some are pure figures of romance. By a process which was going on elsewhere in Europe the frontier settled into a new political organism. As the Marca Hispanica on the east became the county of Barcelona, so the chiefs of Bardulia became the counts of Castile, then the count of Castile, the rival of the king at Leon, and in time the king of Castile, and head of Christian Spain.

There is much in the internal history of that kingdom which stands apart from the general development of western Europe, from which it was shut out. In all the long period from Pelayo to Ramiro II. only one event occurred which had much tendency to bring the Christians of the north-west into close relations with their neighbours of the same faith north of the Pyrenees. This was the discovery, or, in strict ecclesiastical language, the "invention" of the body of St James the Apostle in the reign of Alphonso II. the Chaste (789-842). The shrine at Santiago in Galicia was accepted in an age when evidence and criticism were words of no meaning, and it attracted pilgrims, who brought trade. But, apart from this opening for foreign influence, the Christians were left to develop their order untouched by alien examples, and they developed from the Visigoth monarchy. The men who raised Pelayo on the shield believed themselves to be electing a successor to Roderic, and indeed they were. They continued for a time to call themselves Goths, and to claim Gothic descent, which had become for them very much what descent from the companions of the conqueror was to Englishmen of the 14th or 15th centuries and later—another name for nobility of blood. There was the same king possessing theoretically almost absolute power, both administrative and legislative; the same nobles who limited his effective power by rebellion; their constant effort to keep the crown elective, and his no less steady, and by the 10th century victorious, effort to make it hereditary; the same distinction between the few free, who are also the rich owners of land, and the many serfs, who are partial bondsmen, or the slaves pure and simple. But the fact that every arm was needed for the raids on the frontier, and to provide settlers who should also be garrison for the regained lands, worked for freedom. The serf, who was also a soldier, revolted against bondage. The chief who had to "people" a new and exposed township had to tempt men by freedom and secure rights to follow his banner. The influences which by the 13th century had abolished serfdom in western Spain were all at work before the reign of Ramiro II. In spite of revolts and of fratricidal struggles a state was formed. To the east of it, the Navarrese, having rid themselves of the Carolingian counts and marchers, had made a kingdom in their mountains, and beyond them the little free territories of the central Pyrenees were advancing, in subordination to the Navarrese king at Pamplona. The Arab called them the Christians of Al Frank, and distinguished them from the Galicians.

The 10th century and the first years of the 11th saw a great

set-back of the Christian revival. Dissensions among themselves coincided with an energetic rally of the Moslem power. From the foundation of the amirate by Abdurrahman I. (758-790) to the beginning of the reign of Abdurrahman III. (912-961) Mahommedan Spain had shared the usual fortunes of an Oriental monarchy. A strong amir, such as Abdurrahman I. or his grandson Hakam I. (796-822), could enforce obedience by arms, or by murder, but it was the rule of the most pugnacious and the hardest hitter. Even with him it was often only apparent. On the upper frontier, which is now Aragon, the "Visigoth" Beni-Casi ruled, doing homage and paying tribute intermittently, supported by a loyal population of native Mahommedans, whose Christian or nominally Christian fathers had been their followers before the conquest. The "Moors," so called, who afterwards filled the kingdom of Aragon were of native blood. Toledo, relying on the immense military strength of its position, was more often in rebellion than in subordination. The massacre which Hakam I. effected by a lavish use of fraud cowed it only for a time. Abdurrahman III. found it independent again when he came to the throne, and had to besiege it for two years before it yielded. The renegades grew in numbers, and in faith. Under the influence of orthodox Berber teachers their fanaticism was turned against the amir himself. Hakam, a winebibber much suspected of heterodoxy, had to expel thousands from his capital. Part went to people the town of Fez, newly founded in the Morocco, by the Idrisites. Part wandered eastward to found a Mahommedan state in Crete. Under the stimulus of Berber fanaticism the toleration first shown to the Christians was turned to persecution. A counter fanaticism was aroused in them, and for years the "Martyrs of Cordoba" continued to force the often reluctant cadis to behead them, by blaspheming the Prophet. The relations of the amir to the Christian bishops were very much those of the Ottoman sultan to the Greek patriarch. There were Spaniards who, like the Greeks of the Phanar, were the servile instruments of their Moslem master. Under Abdurrahman II. (822-852), who spent his life listening to a favourite and highly accomplished Persian tenor and in the company of dancing girls, and under Mahommed I. (852-886), the niggardly Mondhir (886-888), whose time was short, and Abdalla (888-912), who was feeble, the amirate was torn to fragments.

From this state of anarchy the amirate was saved by Abdurrahman III. (912-961), the Akbar of his race. He came to the throne when half a century of war and murder had produced exhaustion. The country was swarming with brigands, and the communications were so dangerous that seven years had been known to pass during which no caravan travelled from Cordova to Saragossa. There was a disposition on all hands, save among the irreconcilable Christians of the Sierra de Ronda, to accept peace under a capable master. The Arabs were beaten down, and the renegades had gained most of what they fought for when the aristocracy was cowed. Abdurrahman III., an Oriental ruler of the great stamp, industrious, resolute, capable of justice, magnificent, and free handed without profusion, was eminently qualified to give all that his people wanted. The splendour of his reign is a commonplace. He restored order even in the Ronda, and then he took the field against the Christians. He obeyed the rule which has called upon all the intelligent governors of Spain to make sure of the African coast by occupying it. He saw the Christian princes of the north become his vassals and submit to his judgment in their quarrels. But within a period not so long as his own life his dynasty was extinct and his kingdom in fragments.

Hakam II. (961-976), Abdurrahman's son, ascended the throne in mature years, and continued his father's policy. A lover of books, he gave protection to writers and thinkers who were not strictly orthodox. From his Christian neighbours he had nothing to fear. The anarchy which broke out in the north-west, the kingdom now called Leon, on the death of Ramiro II.—whose sons fought among themselves—and the endless

conflicts between Leon and Castile, rendered the only formidable Christian kingdom powerless. Even on Hakam's death the power of the caliphate was exercised for some thirty years with great vigour. In his old age, one of his wives Sobh (the Day-break), a Basque, bore him the first son born in his harem. To this son Hishām II. (976- ?) he left the crown. The rule went to the sultana, and her trusted agent Ibn Abī 'Amir Mahommed ben Abdallah—an Arab of noble descent, who in his early life was a scribe, and who rose by making himself useful first to the ministers and to the favourite wife. By them he was promoted, and in time he brought their ruin. By her he was made *hajib*—lord chamberlain, prime minister, great domestic, *alter ego*, in short, of the puppet caliph—for Hishām II. in all his long life was nothing else—and in due time he reduced the sultana to insignificance. The administration of Mahommed ben Abdallah, who took the royal name al-Mansur Billah ("the victorious through God") and is generally known as Mansur (*q.v.*), is also counted among the glories of the caliphate of Cordova. It was the rule of a strong man who made, and kept under his own control, a janissary army of slaves from all nations, Christian mercenaries from the north, Berbers and negroes from Africa. With that host he made fifty invasions into the Christian territory. A more statesmanlike conqueror leading a people capable of real civilization would have made five, and his work would have lasted. Mansur made raids, and left his enemies in a position to regain all they had lost. It mattered little that he desolated the shrine of St James at Compostella, the monastery of Cardefa in Castile, took Leon, Pamplona and Barcelona, if at the end he left the roots of the Christian states firm in the soil, and to his son and successor as *hajib* only a mercenary army without patriotism or loyalty. In later times Christian ecclesiastical writers, finding it difficult to justify the unbroken prosperity of the wicked to an age which believed in the judgment of God and trial by combat, invented a final defeat for Mansur at Calatañaxor. He died in 1002 undefeated, but racked by anxiety for the permanence of the prosperity of his house. His son Mozaffar, kept the authority as *hajib*, always in the name of Hishām II., who was hidden away in a second palace suburb of Cordova, Zahira. But Mozaffar lasted for a short time, and then died, poisoned, as it was said, by his brother Abdurrahman, called Sanchol, the son of Mansur by one of the Christian ladies whom he extorted for his harem from the fears of the Christian princes. Abdurrahman Sanchol was vain and feather-headed. He extorted from the feeble caliph the title of successor, thereby deeply offending the princes of the Omayyad house and the populace of Cordova. He lost his hold on his slaves and mercenaries, whose chiefs had begun to think it would be more to their interest to divide the country among themselves. A palace revolution, headed by Mahommed, of the Omayyad family, who called himself Al Mahdi Billah (guided by God), and a street riot, upset the power of the *hajib* at Cordova while he was absent on a raid against Castile. His soldiers deserted him, and he was speedily slaughtered. Then in the twinkling of an eye the whole edifice went into ruin. The end of Hishām II. is unknown, and the other princes perished in a frantic scramble for the throne in which they were the puppets of military adventurers. A score of shifting principalities, each ready to help the Christians to destroy the others, took the place of the caliphate. The fundamental difference between the Moslem, who know only the despot and the Koran, and a Christian people who have the Church, a body of law and a Latin speech, was well seen in the contrast between the end of the greatness of Mansur, and the end of the weakness of his Christian contemporaries. The first left no trace. The second attained, after much fratricidal strife, to the foundation of a kingdom and of institutions. The interval between the death of Ramiro II. in 950 and the establishment of the kingdom of Castile by Fernando I. in 1037 is on the surface as anarchical as the Mahommedan confusion of any time.

The personages are not anywise heroic, even when like Alphonso V. (999-1027) they were loyal to their duty. Sancho the Fat, and Bermudo II. the Gouty, with their shameless feuds in the presence of the common enemy, and their appeals to the caliph, were miserable enough. But the emancipation of the serfs made progress. Charters began to be given to the towns, and a class of burghers, endowed with rights and armed to defend them, was formed; while the council of the magnates was beginning to develop into a Cortes. The council over which Alphonso V. of Leon and his wife Geloria (*i.e.* Elvira) presided in 1020, conferred the great model charter of Leon, and passed laws for the whole kingdom. The monarchy became thoroughly hereditary, and one main source of anarchy was closed. By the beginning of the 11th century the leading place among the Christian kings had been taken by Sancho the Sancho El Mayor (the Great) of Navarre. He was married to a sister of Garcia, the last count of Castile. Garcia was murdered by the sons of Count Vela of Alava whom he had despoiled, and Sancho took possession of Castile, giving the government of it to his son Fernando, (Ferdinand I.), with the title of king, and taking the name of "king of the Spains" for himself. It was the beginning of attempts, which continued to be made till far into the 12th century, to obtain the unity of the Christians by setting up an emperor, or king of kings, to whom the lesser crowns should be subject. Fernando was married to a daughter of Alphonso V. of Leon. Her brother Bermudo, the last of his line, could not live in peace with the new king, and lost his life in the battle of Tamaron, in a war which he had himself provoked. Fernando now united all the north-west of Spain into the kingdom of Castile and Leon with Galicia. Navarre was left by Sancho to another son, Garcia, while the small Christian states of the central Pyrenees, Aragon and Sobrarbe with the Ribagorza went to his other sons, Ramiro Sanchez and Gonzalo. Fernando, as the elder, called himself emperor, and asserted a general superiority over his brothers. That he took his position of king of kings seriously would seem to be proved by the fact that when his brother Garcia attacked him in 1054, and was defeated and slain at Atapuerca, he did not annex Navarre, but left his nephew, Garcia's son, on the throne as vassal. The Council of Coyanza, now Valencia de Don Juan (1050), at which he confirmed the charters of Alphonso V., is a leading date in the constitutional history of Spain. When he had united his kingdom, he took the field against the Mahommedans; and the period of the great reconquest began. So far the Christians had not gone much beyond the limits of the territory left to them at the end of the 8th century. They had only developed and organized within it. Under Fernando, they advanced to the banks of the Tagus in the south, and into Valencia on the south-east. They began to close round Toledo, the shield of Andalusia. The feeble Andalusian princes were terrified into paying tribute, and Fernando advanced to the very gates of Seville without finding an enemy to meet him in the field. His death in 1065 brought about a pause for a time. He left his three kingdoms to his three sons Sancho, Alphonso and Garcia. Alphonso, to whom Leon had fallen as his share, remained master after the murder of Sancho at Zamora, which he was endeavouring to take from his sister, and the imprisonment of Garcia of Galicia. The reign of Alphonso VI., which lasted till 1109, is one of the fullest in the annals of Spain. He took up the work of his father, with less of the crusading spirit than was in Fernando, but with conspicuous ability. His marriage with Constance, daughter of Robert, duke of Burgundy, brought a powerful foreign influence into play in Castile. Constance favoured the monks of Cluny, and obtained her husband's favour for them. Under their leadership measures were taken to reform the Church, from which hitherto little had been expected save that it should be zealous and martial. The adoption of the Roman instead of the Gothic

Abdurrahman Sanchol.

End of the Empire of Abdurrahman III.

Development of the Christian Kingdoms.

Sancho the Great of Navarre.

Ferdinand I. of Castile, "Emperor of the Spains."

Council of Coyanza, 1050.

Beginning of the Christian Reconquest.

Alphonso VI., 1065-1109.

French Influence.

ritual of Saint Isidore has been lamented, but it marked the assumption by Castile of a place in the community of the western European kingdoms. The Frenchmen, both monks and knights, who accompanied Constance brought to bear on Spain the ecclesiastical, architectural, literary and military influence of France, then the intellectual centre of Europe, as fully as it ever was exercised in later times. Castile ceased to be an isolated kingdom, and became an advance guard of Europe in not the least vital part of the crusades. Alphonso, who during his exile owed some good services to the Mahommedan king of Toledo, spared that city while his friend lived.

But he carried the war forward elsewhere. He **Alphonso overruns** extorted tribute, and double and treble tribute **Mahommedan Spain.** from the princes of Andalusia. In 1082 he swept all through the valley of the Guadalquivir to Tarifa, where he rode his horse into the sea and claimed possession of the "last land in Spain." In 1084, his friend being dead, he made himself master of Toledo. The fall of the city resounded throughout Islam, and shocked the Mahommedan princes of Andalusia into gravity and a sense of their position. Their peoples began to look to Africa, where Yusuf ben Techufin was ruling the newly founded empire of the Almorávides. The princes had cause to dread him; for Yusuf, the leader of a religious movement still in its first zeal, was known to have no friendly feeling for their religious indifference and elegant, dissipated habits. It was likely that, if he came as ally, he

would remain as master. But the case was **Invasion of the Almorávide.** excellently put by al-Motamid, amir of Seville, a brilliant cavalier, an accomplished Arab poet, and one of the most amiably spendthrift of princes. When the peril of appealing to Yusuf was put before him at durbar by his son, he acknowledged the danger, but added that he did not wish to be cursed throughout Islam as the case of the loss of Spain and that, if choose he must, he thought it better to lead camels in Africa than to tend pigs in Castile. Yusuf came, and in 1086 inflicted a terrible defeat on Alphonso VI. at Zalaca near Badajoz. The immediate results of the stricken field were, however, but small. Yusuf was called back to Africa, and in his absence the Christians resumed the advance. When he returned he was chiefly employed in suppressing the Mahommedan princes. Alphonso was compelled to withdraw a garrison he had placed in Murcia, and Valencia was, by his decision, given up by the widow of the Cid (*q.v.*). But he kept his hold on Toledo, and though his last days were darkened by the death of his only son in the lost battle of Ucles (1108), he died in 1109 with the security that his work would last.

The Almorávides went round the fatal circle of Asiatic and African monarchy with exceptional rapidity. One generation of military efficiency and of comparative honesty in administration was followed by sloth and corruption as bad as that of the Arabs. To this the **Decline of the Mahommedan Power under the Almorávide.** Almorávides, who were Berbers and were largely mingled with pure negroes, added a dull bigotry and a hatred of thought and knowledge from

which the Arab, anarchical and politically incapable as he was, was free. In Aragon the successors of Ramiro Sanchez had begun to press close on Saragossa when the Almorávide invasion took place. The battle of Zalaca gave pause to the Aragonese, as it did for a short space to the Castilians. The interval of advance in the reconquest would have been shorter than it was but for the results of a most unfortunate attempt on the part of Alphonso VI. to unite the crowns of Aragon and Castile by the marriage of Alphonso I. (1104-1134) of Aragon with his daughter Urraca. Urraca (the name is a form of Maria) was dissolute and Alphonso was arbitrary. There

was nothing in the manners of the 12th century **Alphonso I. of Aragon, 1104-1134.** to make a husband hesitate to beat his wife, and

Urraca was beaten, and in the presence of witnesses. The marriage, too, was declared null by the pope, as the parties were within the prohibited degrees. Alphonso and Urraca came to open war, in which he claimed to be king of Castile by right of his marriage and his election by the nobles.

The confusion was increased by the fact that Alphonso, Urraca's son by her first marriage with Raymond of Burgundy, was recognized as king in Galicia, was bred up there by the able bishop Diego Gelmirez, and took an active part in the feuds of his mother and step-father. The death of Urraca in 1126 allowed her son to reunite the dominions of his grandfather. In the meantime his quarrels with Urraca had not deterred Alphonso, who is surnamed the Battler in Aragonese history, from taking Saragossa in 1118, and from defeating the Almorávides at the decisive battle of Cutanda in 1120. In 1125 he carried out a great raid through Mahommedan Spain, camping in its midst for months, and returning with many thousands of the Christian *rayahs*, who, under the name of Mozárabes, had hitherto continued to live under Moslem rule. They now fled from the bigotry and negro brutality of the Almorávides. The failure of Alphonso's attempt to take Braga in 1134 was speedily followed by his death. He left his kingdom by will to the Knights of the Temple and the Hospital, but the barons of Aragon paid no attention to his wish, and drew his brother Ramiro, a monk, from his cell to continue the royal line. Ramiro, having been first ex-claustrated by the pope, married Agnes of Aquitaine, and on the birth of his daughter Petronilla affianced her to Ramon Berenguer (Raymond Berenger), count of Barcelona, and then retired to his cell at Narbonne.¹ **Union of Aragon and Catalonia.** This marriage united Aragon and Catalonia for ever, and marks a great step forward in the constitution of a national unity in Spain. Navarre, indeed, which had been united with Aragon since the fratricidal murder of its king Sancho in 1076, preferred to remain independent under a new ruler of its choice. It was henceforth **Kingdom of Navarre.** a small state lying across the Pyrenees, dependent on France, and doomed inevitably to be partitioned between its great neighbours to north and south.

Alphonso VII., the son of Urraca, was, during the twenty years between his mother's death and his own in 1157, the dominating sovereign of Spain. In 1135 he was **Alphonso VII., Emperor in Spain.** crowned at Leon, in the presence of the new king of Navarre, of the counts of Barcelona and Toulouse, and of other princes, Christian and Mahommedan, "Emperor in Spain, and king of the men of the two religions." In his character of emperor and king of the men of the two religions Alphonso VII. seems to have aimed not at expelling, but at reducing the Moors to subjection as vassal communities. He took Cordova and conquered as far as Almeria, but left vassal Moslem princes in possession. His **End of the Empire,** death was followed by another and, happily, a last division of Castile and Leon. Sancho, his eldest son, took the first and Fernando the second. The dream of the empire was speedily dissipated by the death of Sancho of Castile a year after his father; Portugal had already become a semi-independent state.

The complicated story of the Christian kingdoms of Spain during the next two generations can be best made intelligible by taking the king of Castile as the centre of the **Alfonso VIII. of Castile, 1158-1214.** turmoil. His boyhood was filled by all the miseries which rarely failed to descend in the middle ages on the people whose king was a child. Alphonso VIII. married Leonora, daughter of Henry II. of England, who, as duke of Aquitaine, by right of his marriage with the duchess Eleanor, had a strong direct interest in Spanish politics. Castile, by its geographical position as the centre of Spain from Cantabria to the Sierra Morena, was the forefront of the struggle with the Moors. In Andalusia the downfall of the Almorávides had **War with the Almohádes.** opened the way to the Almohádes, or followers of the Mahdi, an even more bigoted religious sect than the other. Alphonso had conquered Cuenca, in the hill country between Castile and Valencia, in 1177, with the help of the king of Aragon, also an Alphonso, the son of Petronilla and of Ramon Berenguer of Barcelona. With eminent good sense he rewarded his ally by resigning all claim to feudal superiority over Aragon.

¹ Raymond du Puy, grand master of the Hospitallers, came to terms with Count Raymond in the matter of the bequest. (See SAINT JOHN OF JERUSALEM, KNIGHTS OF.)

At a later period the two kingdoms defined their respective spheres of influence by a treaty. Aragon was left free to conquer the Balearic Islands and Valencia, while Murcia and Andalusia were to fall to Castile. The Almohâdes took the field against Alphonso in force, and as his fellow Christian sovereigns failed him in the hour of need, he was defeated at Alarcos. But this wave of the ebbing Moslem tide had less force than the Almorâvide, and fell back both sooner and farther than its predecessor. Alphonso had leisure to punish his brother kings for deserting him, and to look to the organization of his kingdom. It was a great epoch of the granting of charters, and of the advance of the towns. To this age also belongs the formation of the great monastic military orders of Calatrava, Santiago and Alcântara. They supplied the Crown with a strong force of well-disciplined and well-appointed cavalry. To tighten the bond with Leon, Alphonso of Castile married his daughter Berengaria to its king Alphonso (1188-1230), the son of his uncle Fernando. The marriage was dissolved by the pope as being within the prohibited degrees, but the son born of it was recognized as legitimate. Berengaria, a woman of very noble character and eminent ability, deserved a better husband than her cousin of Leon, who was nicknamed El Baboso—the Slobberer—and who appears to have been epileptic. In 1212 the king of Castile reaped the reward of long years of patience. The Almohâdes threatened an invasion in force; and he organized a crusade against them. Aragon was represented by its king Peter II., Navarre by its king Sancho, and Portugal by a strong contingent of Templars and other knights.

Recognition of the Independence of Aragon. At the Navas de Tolosa, just south of the Sierra Morena, the Almohâdes received the final overthrow which laid Mahommedan Spain at the feet of the Christians. Alphonso died in 1214. His son Enrique (Henry) was killed by the fall of a tile three years later; and Berengaria, to whom the crown came, sent to Leon for her son Fernando, and abdicated in his favour.

Fernando (Ferdinand III.) who was in all ways worthy of his mother, took up the crusading duty of a king of Castile, and continued the advance into Andalusia. The Almohâdes were in swifter decline than the Almorâvides. One of them, al-Mamun, even sought Fernando's help to regain his throne in Morocco, and ceded a suburb of the city to his Christian allies. In 1230 the death of Alphonso of Leon opened the way to a final union of the crowns. The "Baboso" had, indeed, left his kingdom by will to his daughters by Teresa of Portugal, but Fernando was saved from the necessity of enforcing his rights by his mother. She persuaded Teresa and the infantas to resign their claims in return for pensions and lordships. Castile and Leon were united, never to be divided again. The work of the reconquest was now completed with swift steps. In 1236 Cordova was conquered, and Seville fell in 1248 with the help of a fleet from the Basque coast and of the Moorish king of Granada, who was Fernando's vassal, paying tribute and attending Cortes when summoned. Fernando died in May 1252. It will avoid repetition to note here that the Aragonese share of the reconquest was completed by James the Conqueror (1213-1276), the son of that king Peter who fought in the Navas de Tolosa. He conquered the Balearic Islands in 1229 and Valencia in 1238. In 1265 he entered Murcia, which, however, he agreed to occupy in the name of Castile. Mahommedan Spain was reduced to Granada and a line of ports round to Cadiz. The Christian population had disappeared in Granada and Moslem refugees had peopled it closely. Its king was a vassal, and of itself it was no longer a danger.

Organization of the Kingdom. The Military Orders. The close of the period of the great reconquest, five centuries of struggle, left Spain divided between two states of different character. On the west of the Iberian range and south of the Guadarrama was the kingdom called, for short, Castile and Leon. In fact its sovereign was also king of Galicia, Asturias, Estremadura, Jaen, Cordova

Reconquest of Spain, except Granada. and Seville. This multiplicity of titles was more than a mere formula of the royal chancery. It was the official recognition of a substantial political fact—namely, that the kingdom of Castile and Leon had been made up by the agglutination of separate political entities. The real bond between them lay in the common crown, the common creed. They were one only as subjects of the same lords and members of the same Church. But their territorial patriotism was local. The peoples were not Spaniards, save as a general term, but Gallicians, Asturians, Castilians, Andalusians. The great foreign question for them was the possibility, and from time to time the imminence, of renewed invasion from Africa. That peril did not cease till the defeat of the last formidable African invader at the battle of the Rio Salado in 1340. It is characteristic of the loose construction of the kingdom that the Cortes of Leon and of Castile continued, after the final union, to meet apart on some occasions until 1301.

Final Union of Castile and Leon. On the eastern slope of the Iberian hills and the great central table-land was the kingdom called, again for short, Aragon. Its king was also a ruler of many titles—king in Aragon, in Valencia, and the Balearic Isles (with one interval of separation), count of Barcelona, and in Provence. Marriage and inheritance had given him territorial rights in the south-east of France. Thus he came in contact with the crusaders of Simon de Montfort and the expansion of the French monarchy. Another marriage, that of Peter, the son and successor of James the Conqueror, with Costanza, the daughter of Manfred of Beneventum, gave him claims on the Neapolitan and Sicilian inheritance of the Hohenstaufen. From the date of the Sicilian Vespers (1283) Aragon is found mixed in the politics of Italy. The commercial activity of Barcelona brought it into collision with Genoa and alliance with Venice. The curious double position of the king of Aragon is fully illustrated by the career of that king Peter who was the father of James the Conqueror. He fought as a crusader at the Navas de Tolosa, he went to Rome to be crowned, and did voluntary homage to the pope. Yet his interests as a prince of southern France compelled him to draw the sword in defence of the Albigenses, and, orthodox as he was in creed, he fell fighting for them at Muret in 1213. If the fortunes of Aragon were to be followed in an outline of Spanish history, it would be necessary to wander as far as Athens and Constantinople.

The difference of the relations of these two states towards the comity of nations had corresponding internal distinctions. It has been already noted that eastern Spain was feudal. Therefore the distinction of classes was far sharper in Aragon than in non-feudal Castile and Leon. Predial slavery, which had disappeared in Castile and Leon in the 13th century, existed unmodified in Aragon, and in its worst form, down to the Bourbon dynasty. When we are told of the freedom of Aragon, it is well to remember that it was enjoyed only by the small minority who were personally free and also privileged: by the citizens of the towns which had charters—called in Aragon the Universidades—the nobles, the gentry and the Church. The Catalans attained emancipation from feudal subjection by a succession of savage peasant revolts in the 15th and 16th centuries. In Valencia emancipation was finally brought by a measure which in itself was cruel—the expulsion of the Moriscoes in the 17th century. The landlords were compelled to replace them by free tenants. The prevalence of predial slavery in Aragon and Valencia can be largely explained by the number of Mudéjares, that is Mahommedans living under Christian rule, and of Moriscoes—converted Mohammedans.

If now we look at the internal history of Spain from the conclusion of the period of the reconquest, which may be put in the middle of the 13th century, down to the union of the crowns of Castile and of Aragon by the marriage of Ferdinand and Isabel in 1469, it will be found to be occupied with two great processes. These two processes are firstly, the christianization of Spain, a very different thing from its reconquest from Moslem masters—and, secondly, not its unification, for that is hardly attained even now, but its progress towards unification.

Castile and Leon.

Aragon.

Christianization of Spain.

Christianization of Spain.

Christianization of Spain.

When Fernando (Ferdinand III.), the conqueror of Andalusia, died in 1252, he was indeed the king of the two, or even the three, religions. The Jews and the Mahomedans formed a very large part of his subjects. We have no means of estimating their numbers, but there is much probability that together they formed not much less than a half of the population. The Jews, who had suffered cruelly from the brutal fanaticism of the Almohades, had done a great deal to forward the conquest of Andalusia. They were repaid by the confidence of the king, and the period which includes the reign of Fernando and lasts till the end of the 14th century was the golden age of their history in Spain. In 1391 the preaching of a priest of Seville, Fernando Martinez, led to the first general massacre of the Jews, who were envied for their prosperity and hated because they were the king's tax collectors. But the history of the persecution and expulsion of the Jews is the same everywhere except in date. The story of the Mudéjares and Moriscos is peculiarly Spanish. In the Christian advance they were from the beginning first subjected and then incorporated. As far north as Astorga there is still a population known as the Maragatos, and familiar to all Spain as carters and muleteers. This marked type of the Leonese of modern times represents a Berber colony cut off among the Christians, and christianized at an early date, who went on using Arab and Berber names long after their conversion. They are only the most conspicuous example of a process which was common to all the Peninsula. As the Christians worked down to the south they found an existing Mahomedan population. To reduce them to pure slavery would, in the case of Castile at least, have been dangerous, and would also have been offensive to the Christians, who were themselves fighting for emancipation. To expel them would have been to have the soil untilled. Therefore the king, the nobles, the Church and the military orders combined to give them protection. For them, as for the Jews, the 13th and 14th centuries were a golden age. By the end of the 14th the persecutions began. Forced conversion prepared the way for expulsion, which came in the reign of Philip III. (1598-1621). But before the end was reached all had been persuaded or forced into Christianity, had ceased to be Mudéjares, and had become Moriscos. In the majority of cases the conversion had occurred so long ago that the memory of the time when they were Mahomedans was lost, and multitudes of the children of Mudéjares remained. The Mozárabes again—the Christians who had always lived under Mahomedan rule—were an element of importance in medieval Spain. They had learnt to write in Arabic, and used Arabic letters even when writing Latin, or the corrupt dialect of Latin which they spoke. The conquest of Toledo by Alphonso VI. first brought the Christians into contact with a large body of these Arabized Spaniards, and their influence was considerable. By Alphonso they were favoured. He stamped his name on his coins in Arabic letters. It is said with probability that one of the early kings of Aragon, Peter I., could write no other letters than the Arabic. The Mozárabes were treated under the kings of the reconquest as separate bodies with their own judges and law, which they had been allowed to keep by the Moslem rulers. That code was the *forum judicum* of the Visigoths, the *fuero juzgo*, as it was called in the "romance" of later times and in Castilian. The Mozárabes brought in the large Arabic element, which is one of the features of the Castilian language. A part of the work of christianizing the Spain of the 13th century, and not the least part, was done by the monks of Cluny introduced by the French wife of Alphonso VI. To them was due the impulse given to the reform of the church, and to education. The foundation of the *studium generale* of Palencia in 1212 by Alphonso IX. was an outcome of the movement. It fell in the troubles following his death, but Fernando III. revived it by the foundation of the university of Salamanca, which dates from 1245. The church and the university were the great promoters of the effort to secure religious unity which began in the 14th and produced its full effects in the 17th century. How far the character, habits and morality of the Christian Spaniards were affected by Oriental influences is not a question which it is easy to answer. To some extent they no doubt were coloured. Such a social institution as the form of marriage known by the name of *barraganía* shows visible traces of Eastern influence. In so far as it was a mere agreement of a man and woman to live together as husband and wife, it had precedents both Roman and Teutonic. There was also Roman and Teutonic example for recognizing the children of such a union as having rights of inheritance. On the other hand the name is Arabic, and so is the term applied to the children, *hijos de ganancia*, sons of the strange woman. Moreover the Oriental character of this union, be its origin what it may, is visible from the fact that it was polygamous. The only insuperable barrier to a *barraganía* was the previous marriage "with the blessing," the full religious marriage, of the woman to another man. A married man might be united in *barraganía* to a woman other than his lawful wife, and the children of that connexion, though not fully legitimate, were not bastards. The most signal example among many which could be quoted is that of Peter the Cruel (1350-1367), who, though married to Blanche of Bourbon, was *abarraganado* to Maria de Padilla. He left his

kingdom to the daughters she bore him, and their *quasi* legitimacy was recognized not only by the Cortes during King Peter's life, but abroad. John of Gaunt, duke of Lancaster, married the elder of the daughters of Maria de Padilla, and claimed the crown of Castile by right of his wife. The clergy, who were debarred from the religious marriage by the discipline of the church, were commonly *abarraganado* all through the middle ages. The sumptuary laws, which required the *barraganas* of priests to wear a red border to their dresses, recognized them as a known and tolerated class.

The work of political unification was essentially more difficult than the christianization of Spain. The great common institution of the church, common enthusiasms, prejudices and envies, were available for the second. The first had to contend with deeply rooted differences of national character and of class. The Gallician who spoke, and still speaks, a language of his own, was profoundly separated from the Andalusian. The Basque, who till much later times practically included the Navarrese, was a man of another nationality and another speech from the Castilian. And what is true of Castile and Leon applies equally to Aragon. Aragonese, Catalans and Valencians were as different as Galicians, Basques, Castilians and Andalusians. Aragon spoke a dialect of Castilian. Catalonia and Valencia, together with the Balearic Islands, spoke, and speak, dialects of the southern French, the so-called Limosé, though it was not the language of the Limousin. And the causes of division did not end here. The word "commonwealth" had no meaning either east or west of the Iberian range. Every one of the kingdoms grouped round the two sovereigns who shared modern Spain was itself a loose conglomeration of classes. Mention has already been made of the Jew and the Mudéjar. These were more or less forcibly absorbed or brutally expelled. But the distinctions between noble and not noble, between town and country, were in the very fibre of all the Spanish peoples. Expulsion was impossible and combination only attainable by mutual agreement, and that was never secured. High mountain barriers and deep river courses had separated the Spaniards locally. They were more subtly and incurably separated by traditional and legal status. Speaking generally, and with the proviso that though names might differ from region to region, the facts did not; it may be said that Spain could be classified as follows: Under the crown of Castile all the territory was either *abadengo*, *realengo*, *salariego*, *behetria*, or it belonged to some town, big or little, which had its *carta pueblo* or town charter, its own *fuero* (forum) or law. *Abadengo* was land of the church, *realengo* domain of the crown, *salariego* land of the nobles. *Behetria* is less easy to translate. The word is the romance form of *benefactoria*. Behetrias, called "plebeian lordships," were districts and townships of peasants who were bound to have a lord, and to make him payments in money or in kind, but who had a varying freedom of choice in electing their lord. Some were described as "from sea to sea, and seven times a day," that is to say they could take him anywhere in the king's dominions from the Bay of Biscay to the Straits of Gibraltar, and change him as often as they pleased. Others were *de lineage*, that is to say, bound to take their lord from certain lineages. Their origin must probably be sought in the action of communities of Mozárabes, Christians living under Moslem rule as *rayahs*, who put themselves under Christian chiefs of the early days of the reconquest for the *benefice* of their protection. They were mainly in old Castile. By the end of the middle ages they had disappeared. The chartered towns, in Spain east and west, were practically republics living under their own *carta pueblo* with their own *fuero* or law. All charters were not granted by the king. Many of them were given by nobles or ecclesiastics, but required the confirmation of the king. And in this country, where all was local law usage and privilege, where uniformity was unknown, all charters were not held by towns. In many cases the serfs in the course of their struggle for freedom extorted charters and *fueros*. The greater chartered towns had their surrounding *comarcas*, answering to the "county" of an Italian city, over which they exercised jurisdiction. In time the villages dependent on a chartered city, as they grew to be towns themselves, fought for, and in many cases won, emancipation, which they then sought to have confirmed by the king and proceeded to symbolize by setting up their own gallows in the market-place. The church had won exemption from the payment of taxes by no general law, but by particular privilege to this or that chapter, bishopric or monastery. The nobles claimed, and were allowed, exemption from taxation. Church and nobles alike were for ever extending their borders by purchase, or trying to do so by force. They conferred their exemptions on the land they acquired, thus throwing the burden of taxation on the towns and the non-nobles with increasing weight. But in this land, where nothing was consistent, there was in reality no sharp division except in the smaller and feudal portion—called Aragon for convenience—and save as between Christian and non-Christian, noble and non-noble. The necessities of the reconquest made it obligatory that all the dwellers

Problem of the Unification of Spain.

National Differences.

Class Distinctions.

Systems of Land Tenure.

The Towns.

The Clergy and the Nobles.

on the frontier should be, garrison. Hence they were not only encouraged but required to possess arms. Those of them who could provide themselves with a charger, a mail shirt, a spear and sword were ranked as *militēs*—and the *miles* was a *caballero*. Alphonso VII. especially authorized all men who could arm themselves, mount themselves, and serve "cavalierly" to live as and count themselves "cavaliers." Hence the formation of the class of *caballeros de fuero*, non-nobles living "nobly" with a right to wear the sword. The privilege survived the epoch of the reconquest, and was often extended to gilds which the king wished to encourage. Hence came the practice which caused so much surprise and amusement to French and German travellers of the 16th and 17th centuries—the wearing of the gentlemanly sword by the artisans of towns.

No general law controlled these local usages and *fueros*. The *fuero juzgo* (*forum judicium*) was accepted by the Mozárabes, and had authority everywhere in cases not provided for by the charters, or where no privilege had been granted by the king. But it was subject to innumerable exceptions, and particular jurisdictions. There was no common tribunal. Nor was any material change introduced after the epoch of the reconquest. Alphonso X., El Sabio or Learned, made a *fuero real*, which was formed by combining the best parts of existing charters. It was accepted by towns and districts not already chartered, but by them only. The famous *siete partidas* (the seven divisions), drawn up about 1260, is often spoken of as a code of laws. It was never so treated till it was promulgated at the Cortes of Alcalá in 1338, in the reign of his great grandson, Alphonso XI. Even then it was subject to the restriction that it was not to prevail against any *fuero*, or the *fuero real*. The Cortes might have been expected to forward the work of unification. But without going into details on a subject which requires particular treatment, it may be noted that the

The Siete Partidas. Cortes was no more coherent, or fixed in constitution or working, and was no more national, than any other of the institutions of the country. The crown of Castile and Leon had indeed a common Cortes after 1301. Aragon never advanced so far. It, Catalonia and Valencia had each their Cortes, which never united. When King Philip IV. (1621–1665) wished to secure grants of money from these parts of his dominions he had to summon three separate Cortes, which sat in different frontier towns, and he had to negotiate simultaneously with all three. Then the Spaniards, in their carelessness of form and regularity, never fixed any rule as to the constitution of a Cortes. The third estate secured representation in the Cortes of Leon (1188), and then in Castile and the Common Cortes. In the kingdom of Aragon the right was secured about the same time. It was decided that no new tax could be imposed save with the consent of the commons, and that therefore they must be represented. But no rule was ever made as to whom the king was bound to summon, nor even that the presence of the clergy and the nobles was necessary to constitute a true Cortes. It was never claimed by the Cortes that its consent was necessary to the making of laws. The Roman maxim that what the "prince" wills has the force of law was not disputed—nor did the Spaniard doubt that the king acting by himself was "the prince." The check which the *justiza*, or chief justice, of Aragon imposed on the king was supported by the force of nobles and cities, but it was an exception in Spain. The representatives of the commons were the *personeros* and *procuradores*, i.e. attorneys of the cities. There was no knight of the shire in any Spanish Cortes. The great cities in Castile and Leon succeeded finally in reducing the right of representation to a privilege of eighteen among them, with the good will of the king, who found it easier to coerce or bribe the procurators of eighteen towns than the representatives of a hundred and fifty. The legislative work of such bodies was necessarily small. Their practical power might be great when the king was weak and necessitous, but only then.

It ought to have been easy for kings whose authority was confessedly so great to have made themselves effectively despotic amid all this division and weakness. Nor would they have failed so to do if the sovereigns of Castile had not been either incapable or short-lived, and if there had not been an extraordinary succession of long minorities; while the kings of Aragon were tempted to neglect their Spanish possessions because they were in pursuit of their claims and ambitions in Italy. Alphonso X. of Castile (1252–1284) was an admirable writer, and a man of keen intelligent interest in science and law. As a ruler he was at once weak, unstable and obstinate. He wasted much time and great sums of money in endeavouring to secure his election as emperor—not in Spain, but in the Holy Roman Empire. He did indeed add the town of Cadiz to his possessions with the help of his vassal, the Moorish king of Granada, but his reign is filled with quarrels between himself and his nobles. The nobles of Castile and Leon were not feudal

The Kings of Castile.

They have failed so to do if the sovereigns of Castile had not been either incapable or short-lived, and if there had not been an extraordinary succession of long minorities; while the kings of Aragon were tempted to neglect their Spanish possessions because they were in pursuit of their claims and ambitions in Italy. Alphonso X. of Castile

(1252–1284) was an admirable writer, and a man of keen intelligent interest in science and law. As a ruler he was at once weak, unstable and obstinate.

He wasted much time and great sums of money in endeavouring to secure his election as emperor—not in Spain, but in the Holy Roman Empire. He did indeed add the town of Cadiz to his possessions with the help of his vassal, the Moorish king of Granada, but his reign is filled with quarrels between himself and his nobles. The nobles of Castile and Leon were not feudal

vassals, but great landowners claiming and exercising rights or jurisdiction on their estates. Their name of *ricos hombres*, which first appears in written documents of the 12th century, has been credited with a Teutonic origin, but it was in all probability nothing but a "romance" or Castilian translation of the *seniores* and *senatores*, *potentiores* and *possessores* of the Visigoth councils and code. They represented a nobility of wealth and not of blood. In the earlier times their possessions were divided among their sons. It was only at the end of the 13th century and later that they began to form *mayorazgos* or entails, to preserve their name and family. It was then that *segundones*, or younger sons, began to be known in the social life of Spain. But whatever their position may have been legally, they were as grasping as any feudal nobility in Europe, and they were singularly destitute of any capacity for combined political action. In Aragon, indeed, the nobles did extort a promise from the king that they should not be put to death or deprived of their estates by his mere decision. In Castile they never went beyond begging or extorting grants of the crown lands, or pensions charged on the royal revenue. Alphonso X. ended his life in a civil war with his son Sancho, who claimed the succession in preference to the children of his elder brother, Fernando de la Cerda, and in virtue of a doctrine of which much was heard in the middle ages elsewhere than in Spain. He maintained that the younger son, being nearer to the father than the grandson, had a right to succeed in preference to the children of an elder brother who had died before the succession was open. Alphonso, after first accepting Sancho's claim, repudiated it, and made a will by which he not only left the crown of Castile to the eldest son of Fernando de la Cerda, but cut vassal kingdoms out of the southern parts of Spain for Sancho's younger brothers. The reign of

Sancho IV., surnamed El Bravo, or the Fierce (1284–1296),

was one constant struggle with the very nobles who had helped him against his father, with his younger brothers, and with the sons of Fernando de la Cerda. Murder and massacre were his familiar methods. He was succeeded by his infant son Fernando (Fer-

dinand IV.), whose long minority was an anarchy, tempered by the courage and the tact of his mother, Maria de Molina. Fernando, ungrateful to his mother and incapable as a king, died in 1312, leaving a son of less than a year old, Alphonso XI. (1312–1350). After another minority of confusion, Alphonso,

surnamed "of the Rio Salado," from the great victory he won over an invading host from Africa, ruled with energy and real political capacity. He

was indeed ferocious, but such actions as the murder of his great-uncle, Don Juan El Tuerto—the distorted in body and mind—did not seem to his subjects more than the exercise by "the prince" of that right to act for the good of the state *legibus solutus* which is inherent in sovereignty. But Alphonso did not use his freedom to act *legibus solutus* except against such hoary and incorrigible intriguers as Don Juan el Tuerto or the Caballero Diego Gil, whom he beheaded with seventeen of his men after promising them security for their lives. He did something to found the judicial and administrative unity of the country. His death at the age of thirty-eight, during the great plague, and while he was besieging Gibraltar, was a misfortune to Spain. His successor, Peter, surnamed the Cruel (1350–1368) was destined to show the Castilians exactly what the constant use by "the prince" of the reserved rights of the sovereign authority could be made to mean, when they were exercised by a passionate man maddened by suspicion of all about him. Administering the civil side of his government through Jewish tax-gatherers and farmers of the taxes, and surrounded by the Mudéjar guard, who were the executors of his justice, his path is marked by one long succession of murders. With all his appearance of energy, he shrank from action at the critical moment of his wars out of utter want of trust in all about him. His expulsion by his brother, Henry of Trastámara, the eldest son of Leonora de Guzman, his restoration by the Black Prince (*q.v.*), his treachery

Sancho IV., 1284–1296.

Ferdinand IV., 1296–1313.

Alphonso XI., 1312–1350.

Peter the Cruel, 1350–1368.

to him, and his final defeat and murder at Montiel, are famous episodes. Henry of Trastámara, the beginner of the "new kings" (1368-1379), reigned by election. The nobles and the cities to whom he owed his crown

Henry of Trastámara, 1368-1379. had proportionate power. In his reign and those of his immediate successors the Cortes flourished, although it failed to establish checks on the absolute power of the king. Henry was on the whole a successful ruler. He forced his neighbours of Portugal to make peace, his fleet defeated an English squadron off Rochelle, and he restored internal order. The civic *hermandades*, or brotherhoods, enforced respect from the nobles. John I. (1379-1390), Henry's son and successor, had to contend with John of Gaunt, son of Edward III. of England, who had married the eldest daughter of Peter the Cruel, and claimed the crown of Castile in her name. John averted the danger by arranging a marriage between his son Henry and Constance, the eldest daughter of John of Gaunt, an alliance which united the two equally illegitimate lines representing Alphonso XI., and so closed the dispute as to the succession. He was less fortunate in his efforts to vindicate the rights of his wife Beatrix to the throne of Portugal. The defeat of the Castilians at the battle of Aljubarrota (1385) compelled the king to renounce his pretensions. The minority of his son, Henry III. (1390-1406) was long, and his effective reign short, but in the brief space allowed him the king, a weakly man surnamed El Doliente (the sufferer) did something to establish order. He recovered all the immense grants of crown lands and rents, impounded by the nobles during his minority. The first years of the minority of his infant son, John II. (1406-1454), were by a rare exception peaceful. The young king's uncle Ferdinand (called "of Antequera" because he was besieging that town, which he took from the Moors, when he heard in 1412 that he had been declared heir to the crown of Aragon by the Cortes of Caspe) acted as regent. Ferdinand was able and honest. His succession to the throne of Aragon is an event of capital importance in the history of the Peninsula.

John I., 1379-1390.

Henry III., 1390-1406.

John II., 1406-1454.

The kings of Aragon from the death of James the Conqueror in 1276 to the death of Martin I. in 1410 were so largely concerned in the struggle with the Angevin party in Naples and Sicily, that their history belongs rather to Italy than to their Peninsular kingdom. They were six in number: Peter III. (1276-1285), Alphonso III. (1285-1291), James II. (1291-1327), Alphonso IV. (1327-1336), Peter IV. (1336-1387), John I. (1387-1395), and Martin I. (1395-1410). In so far as their influence was felt in the internal affairs of their Spanish kingdoms, they had a double task to perform. The first was to reunite the Balearic Islands and Roussillon, which James the Conqueror had left by will to a younger son, to the crown of Aragon. This was finally achieved, after a hideous story of fratricidal hatred and murder by poison, by Peter IV. Their second task was to reduce their turbulent barons, in Aragon, Catalonia and Valencia alike, to the position of obedient subjects. In this task also it was Peter IV. who achieved success. The barons of Aragon and Valencia had extorted from his weak father the charter known as the Union, which not only recognized their just right not to be punished in life or property, except by process of law, but explicitly authorized them to elect the *justiza* or the chief justice, whose decisions were to be independent of royal confirmation, and to take up arms whenever they considered themselves aggrieved. Such an instrument was of course incompatible with the monarchical or any other form of government. The object of the life of Peter IV. was to force the barons to surrender their charter. After years of struggle and preliminary failures, Peter IV. defeated the "Union" utterly at the decisive battle of Epila (1348). He was a typical king of the 15th century, immeasurably false, and unspeakably ferocious, but he was not a mere blood-thirsty sultan like his enemy, Peter the Cruel of Castile. When he won he took indeed a brutal vengeance on individuals, and

The Kings of Aragon.

Peter IV. and the "Union."

he extorted the surrender of the charter and destroyed it with his dagger in the presence of the Cortes at Saragossa. He cut his hand in his eagerness, and declared that the blood of a king was well shed in securing the destruction of such an instrument—whence his popular nickname of Peter of the Dagger (*del Punecjalet*). But his use of the victory was statesmanlike. He fully confirmed the right of the nobles to trial by law and security against arbitrary punishment; he left the franchises of the city untouched, and respected the independence of the *justiza*. The result of his victory was to give Aragon and his other dominions a measure of internal peace unknown in Castile. The reigns of his sons and successors, John and Martin, were insignificant and tranquil. The death of Martin without children in 1410 left the succession open. The two years of discussion which followed are interesting as a proof that Aragon had reached a higher political level than Castile. The Cortes was able to administer in peace, and the question of the succession was debated as if it had been in a suit between private persons. The judges finally decided in favour of Ferdinand, on the ground that his mother, Eleanor, was the daughter of Peter IV., and that though a woman could not reign as a "proprietary queen" in Aragon, she could convey the right to her husband or transmit it to her son. On their own principles they ought to have given the crown to John of Castile as the son of Ferdinand's elder brother. But the countries were not ripe for union. Nevertheless the choice of Ferdinand was a step forward towards union.

From 1412 to 1479 the separation lasted with a growing approximation of the two states whose interests touched one another so closely. In Castile John II. (1406-1454), a man of amiable but indolent character and of literary tastes, was governed by his favourite, Álvaro de Luna, and harassed by his nobles. His reign is full of contentions which were not wars for a principle, but were scuffles for the control of the spigot of taxation. At the end of his life he sacrificed his favourite at the instigation of his second wife, an act which, it is said, justly embittered his last days. Of his son, Henry IV. (1454-1474) it is enough to say that he was called "the Impotent," and that there is every reason to believe that he deserved the description in all the senses of the word. His reign was an inferior copy of his father's. As the legitimacy of his alleged daughter Juana was disputed, his sister Isabella claimed the succession, and married her cousin, Ferdinand of Aragon, son of John I., in 1469 in defiance of her brother. In Aragon, Ferdinand I. "of Antequera" (1412-1416) was succeeded by Alphonso V. (1416-1458) the Magnanimous, whose brilliant life belongs to Italy. In Aragon he was represented by his brother John, who administered as lieutenant-general, and who reigned in his own right (1458-1479) when Alphonso V. died without legitimate heirs, leaving Naples by will to a bastard son, John I., a man of indomitable energy and considerable capacity, spent most of his life in endeavouring to enforce his claims to the kingdom of Navarre as the husband and heir of its queen Blanche. His conflict with his son by his first marriage, Charles, prince of Viana, was settled in his favour by the death of the prince. Then he had to contend with a national revolt in Catalonia, which endeavoured to make itself independent under three successive foreign princes. In the end the pertinacity of John triumphed. At the age of over eighty, blind and unconquerable, he transmitted his kingdom to Ferdinand, his son by his second marriage, with Juana Enriquez, of the family of the hereditary admirals of Castile. Navarre went to a daughter, and Roussillon was somewhat fraudulently retained by Louis XI. as security for a debt. Ferdinand conquered the Spanish half of Navarre later, and recovered Roussillon from Charles VIII., the successor of Louis XI.

Castile, John II., 1406-1454.

Henry IV., 1454-1474.

Aragon, John II., 1458-1479.

With the death of John II. of Aragon in 1479 the history of Spain enters on an entirely new period. Hitherto it has been the story of a national development. The process did not cease, but, during the reign of Isabella the Catholic (1474-1504) until the death of her husband Ferdinand in 1516, was carried,

not to completion, but to the stopping place at which it was destined to rest for two centuries. The voyage of Columbus *Spanish History after 1479.* in 1492, and the intervention of Ferdinand in the great conflict of France, the empire and the papacy for predominance in Italy, had, simultaneously, the effect of opening to her the world of conquest and adventure in America, and of committing her to incessant wars in the Italian Peninsula. The death of John, the only son of Ferdinand and Isabella, the worst misfortune which ever happened to Spain, opened the succession to all the crowns and coronets worn by the Catholic sovereigns to Charles of Habsburg—the emperor Charles V. From that day Spain became a part—the leader, then the paymaster, then the dupe—of the international monarchical confederation called “the illustrious House of Austria.” The Spaniard became the swordsman and executioner of the counter-Reformation, because the power of the House of Austria depended on the imposition of religious unity in Europe. The decision of Charles V., king of Spain and emperor, to leave the Netherlands to his son Philip II., committed the Spaniards to conflict on the sea with England, and to the insane attempt to secure a safe road for their armies across Europe from the shores of the Mediterranean to the North Sea. Thereby they threatened the very national existence of France. The arrangement was made possible only by the hopeless divisions of Germany, the blind pride of Spain, and the utter political incapacity of both. It forced every patriotic ruler of England to oppose Spain on the sea, and every statesmanlike master of France to ruin her power on the land. Meanwhile the Spaniards were endeavouring to check the advance of the Turks in the Mediterranean, and to exclude all Europe from the waters of the New World. In the intensity of their struggle with the Reformation they subjected education to a censorship which, in order to exclude all risk of heresy, stifled thought and reduced knowledge to the repetition of safe formulas. With their eyes on the ends of the earth, and a ring of enemies from Constantinople to the Antilles, the Spaniards fought, with steadily diminishing material resources, with a character and intellect which shrivelled by swift degrees. When nearly bled to death for the illustrious House of Austria, they were transferred to the House of Bourbon, which in its turn dragged them into conflict with Austria in Italy and England on the sea. At the beginning of the 19th century they had fallen into such a state of weakness that Napoleon could, with some considerable measure of excuse, look upon their country as a species of no-man’s-land into which his troops had only to march on police duty to secure immediate obedience. The history of the 19th century is the liquidation of an enormous bankruptcy, and the completion of the circle which confines the Spaniard once more to the soil of the Peninsula.

Ferdinand and Isabella were proclaimed king and queen of Castile together, although the crown was hers alone, and although she never consented to part with her sovereign authority. In the purely internal affairs of Castile it was always she who decided on questions of administration. Some opposition was offered by a faction of the nobles who took up the claims of Henry’s supposed daughter, commonly called Juana la Beltraneja, because her father was alleged to have been Don Beltran de la Cueva, who, however, fought for Isabella. Juana’s party had the support of the king of Portugal, who arranged a marriage between her and his son. The defeat of the Portuguese at Toro made an early end of the war. The new sovereigns immediately began the work of establishing order and obedience in their dominions. The line of policy followed by the Catholic sovereigns¹ was to keep the old forms, but draw the substance of power to themselves. Thus, for instance, they organized a police to clear the country of brigands, and attached a special jurisdiction to it, but they gave it the old name of *Hermandad* and the very superficial appearance of a voluntary association of the cities and the gentry. It consisted of a force of well-appointed horsemen, in the pro-

¹ The name was not formally given to them by the pope till later, but it is convenient to use it at once.

portion of one to every hundred families. Its merits as a police have perhaps been exaggerated, and in the war with Granada its bands were employed as soldiers. But an end was at least put to the existence of *peñas bravas* in the dominions of the crown of Castile. And this was the uniform model of the policy. The masterships of the military orders of Calatrava, St Iago and Alcántara were one by one annexed to the Crown. Their commandaries were used to pay, or pension, the servants of the sovereigns. No attack was made on the charters of the towns, but in Castile and Aragon alike royal officers were appointed to adjudicate on disputes within the corporations themselves, or between corporation and corporation. By them the old councils were rapidly reduced to a state of atrophy. The same course was followed with the Cortes. It continued to be summoned by the Catholic sovereigns and their successors of the Habsburg line, but it was needed only to grant money. The nobles and the clergy, who as exempt from taxation had no vote, became purely ornamental parts of the Cortes. The representatives of the third estate were confined by the indifference of the Castilians to eighteen towns, whose procurators were named by the councils either from among themselves in rotation, or from particular families. Moreover, they received pay from the Crown while the Cortes sat. For the work of legislation the Cortes was not needed, and never had been. It was not even summoned during the whole of the war with Granada. The Catholic sovereigns provided themselves with a revenue by the customary wholesale resumptions of grants made during the reigns of John II. and Henry IV., and by the suppression or reduction of the pensions they had granted with profusion. The nobles, having been brought to obedience by a frown, were left in possession of their estates, their social rank and the obligation to render military service. They were summoned to the royal council, but only as ornamental members, the real authority and the exclusive right to vote being confined to the *letrados*, or lawyers, chosen by the Crown from the class of the burghers. Encouragement of industry was not wanting; the state undertook to develop the herds of merino sheep, by issuing prohibitions against inclosures, which proved the ruin of agriculture, and gave premiums for large merchant ships, which ruined the owners of small vessels and reduced the merchant navy of Spain to a handful of galleons. *Tasas*, fixed prices, were placed on everything. The weaver, the fuller, the armourer, the potter, the shoemaker were told exactly how to do their own work. All this did not bear its full fruit during the reign of the Catholic sovereigns, but by the end of the 16th century it had reduced Spain to a state of Byzantine regulation in which every kind of work had to be done under the eye and subject to the interference of a vast swarm of government officials, all ill paid, and often not paid, all therefore necessitous and corrupt. When the New World was opened, commerce with it was limited to Seville in order that the supervision of the state might be more easily exercised. The great resource of the treasury was the *alcabalas* or excises—taxes (farmed by contractors) of 5 or 10% on an article every time it was sold—on the ox when sold to the butcher, on the hide when sold to the tanner, on the dressed hide sold to the shoemaker and on his shoes. All this also did not bear its full fruit till later times, but by the 17th century it had made Spain one of the two “most beggarly nations in Europe”—the other being Portugal.

The policy of the Catholic sovereigns towards the Church was of essentially the same character as their treatment of the nobles or the cities. They aimed at using it as an instrument of government. One of the first measures adopted by them in Castile, before the union with Aragon, was to stop the nomination of foreigners to Spanish benefices by the pope. But the most characteristic part of their ecclesiastical policy was the establishment of the Spanish Inquisition (*q.v.*). By the bull of Sixtus IV. of 1578 they obtained authority to appoint three inquisitors, whom they were empowered to remove or replace, and who were independent of, and superior to, the inquisitorial courts of the bishops.

The Spanish Inquisition was a department of the royal government, employed to enforce religious unity and obedience, because they were held to be indispensable in order to obtain national unity and to enforce the authority of the Crown. The Inquisition was at first established (in 1480) in the dominions of Castile only, but it was extended in 1486 to Catalonia and in 1487 to Aragon, in spite of strong protests. The first duties of the Inquisition were to deal with the converted Jews and Mahommedans, respectively known as Marranos and Moriscos, and with those who still professed their religions. The latter were dealt with by expulsion, which in the case of the Jews was enforced in 1492, and in the case of the subject Mahommedans or Mudéjares in 1502. Both were industrious classes, and the loss of their services was disaster to Spain—the first of a long series of similar measures which culminated in the final expulsion of the Moriscos in 1610. The converted Jews and Mahommedans presented greater difficulties to the Inquisition. Many of the higher ecclesiastics and of the nobility were of Jewish, or partially Jewish, descent. The landlords who found the Moriscos useful tenants, and the commercial authorities of towns like Barcelona, who knew the value of the converted Jews, endeavoured to moderate the zeal of the inquisitors. But they were supported by the Crown, and there can be no question that the Holy Office was popular with the mass of the nation. It produced a wholesale flight of the converted Jews to France.

In social life the religious zeal favoured by the Inquisition led to such things as those public processions of flagellants which went on in Spain till the end of the 18th century. It aimed at preserving orthodoxy and developing sainthood on the medieval model. Of ordinary immorality it took little notice, and the triumph of its cause in the 16th and 17th centuries, while producing such types of ecstatic piety as St Theresa (*q.v.*), the Sor Mariade Jesus (Maria Agreda), (*q.v.*) and the Venerable Virgin Luisa de Carvajal (*q.v.*), was accompanied by an extraordinary development of moral laxity. The Holy Office showed equal zeal in extending its jurisdiction, and by the end of the 17th century had provoked a strong reaction. The most honourable passage in its history is the part it took in forwarding the great, though temporary, reform of the monastic orders, which was a favourite object with Queen Isabella.

Between 1481 and 1492 the Catholic sovereigns completed the work of the reconquest by subjugating the one surviving **Conquest of** Mahommedan state of Granada. Their task was **Granada,** materially facilitated by dissensions among the **1492.**

Moors, whose princes intrigued against one another, and were to the last ready to aid the Christians in the hope of obtaining a small fragment of territory for themselves. The surrender of Granada on the 2nd of January 1492 was partly secured by promises of toleration, which were soon violated. A revolt had to be suppressed in 1501. Having secured the unity of their territory in the Peninsula, the Catholic sovereigns were free to begin the work of expansion. In 1492 Columbus

(*q.v.*) sailed on his first voyage to the west. In 1493 Ferdinand secured the restoration of Roussillon from

Charles VIII. of France by the fallacious treaty in which he undertook to remain neutral during the king's expedition to Italy. The voyage of Columbus had unforeseen consequences which led to diplomatic difficulties with Portugal, and the treaty of Tordesillas in 1494, which defined the respective spheres of influence of the two powers in the New World and in Asia. In 1497 Ferdinand, with the support of his wife,

entered on those wars of Italy in which the Spanish regular soldiers first gained their reputation, and which made Spain for a time the dominant power in the Italian peninsula (see CÓRDOBA, GONZALO F. DE).

They endeavoured to strengthen themselves against France by marriages with the royal family of England (see CATHERINE OF ARAGON) and the Habsburgs. The marriage of Juana, called the Mad, with Philip of Habsburg, son of the emperor Maximilian (*q.v.*) brought a new dynasty to Spain. On the death of the queen in 1504 her son-in-law claimed the regency, and was supported by the

Castilian nobles. His death in 1506 and the insanity of his widow left the Castilians no choice but to restore Ferdinand as regent. During the

next ten years Ferdinand governed with the very able assistance of the archbishop of Toledo, Jimenes de Cisneros (*q.v.*). He annexed the southern part of Navarre, which was held by the representatives of his half-sister. The archbishop organized and directed the expedition which conquered Oran, Tripoli and other points on the African coast. Here beyond all doubt lay

the proper field for the expansion of Spain. She was drawn from it on the death of Ferdinand in 1516. He was succeeded by his grandson Charles of Habsburg, and when Charles was elected to the empire in 1519 Spain was dragged into the wars and politics of central Europe.

Only the smaller part of the reign of Charles was spent in Spain. He came to it from Flanders, where he had received his education, unable to speak the language and sur- **Charles I. of** rounded by Flemish favourites. To him and them **Spain, V. as** the country was only a source of supply from which **Emperor.**

money was to be obtained in order to bribe the German electors. The disregard which both showed for the interests of Spain and its constitutional rights led to the outbreak of the revolt of the cities—the **Comuneros**—which plunged Castile into confusion in 1519 and 1520 after the departure **Revolt of the** of Charles for Flanders. The rising of the **Comuneros,** **Comuneros** has often been spoken of as a **1519-20.**

struggle for freedom. But it has a very dubious right to the name. In many places the movement was simply an excuse for a revival of private wars between wealthy noble families. In others it was a struggle to enforce the claims of particular towns. It hardly extended as a political movement beyond the two Castiles. If its leaders had acted together, in combination with the nobles, the **Comuneros** could have imposed their own terms, for there was no royal army to oppose them. But they drifted into hostility with the nobles, and were defeated by them at Villalar. The movement then rapidly collapsed. Charles had no part in the suppression of the revolt. Throughout his reign he respected the claim of the Cortes that no new taxation should be raised without its consent, but as he had to deal only with the representatives of eighteen cities, who could generally be bribed, he rarely failed to secure what he demanded.

The outbreak of the **Comuneros** in Castile coincided with the social and agrarian revolt in Valencia known as the **Germania** or brotherhood, from the name of the directing committee appointed by the insurgents. It was in no sense a movement for political rights, but an attack by **Rising of the** the sailors, the workmen of the towns, and the **Germania in** Christian peasants on the landowners and their **Valencia.**

Mudéjar and Morisco serfs. It was accompanied by murder and massacre and by forced conversions of the Mudéjares. After desolating Valencia for some three years it was put down by the help of troops from Castile. The conquest of Mexico by Hernan Cortes (*q.v.*) and of Peru by Francisco **Spain and** Pizarro (*q.v.*) belong to this reign, but were imme- **the Euro-** diately due to the adventurers in America. These **pean Polky** conquests and the incessant wars into which Spain **of Charles V.**

was drawn by the Aragonese claims in Italy, and its connexion with the empire, gave to the nation a great European position and to the Spanish soldiers of the time many opportunities to win renown. The capture of the French king at Pavia and his imprisonment at Madrid gratified the pride of the Spaniards, and did much to reconcile them to the sacrifices which the policy of the emperor imposed on them. Except, however, in the case of the successful attack on Tunis in 1535, and the attempt to take Algiers in 1541, his actions were not inspired by any regard for the interests of his Spanish kingdoms. He treated them simply as instruments to promote the grandeur of his house. His indifference to their good, or his utter inability to see where it lay, was conspicuously shown when, on his abdication in 1556, he left his hereditary Flemish possessions to his son Philip, and not to his brother Ferdinand.

The reign of Philip II. (1556-1598) was a prolongation of the reign of his father, both in domestic and in foreign policy. In it the vices of this policy were displayed to the fullest extent. Philip's marriage with Mary Tudor **Philip II.,** (*q.v.*) in 1554 having proved barren, and her death in **1556-1598.** 1558 having placed Elizabeth on the throne of England, he was left without the support against France which this union was meant to secure. At the same time his inheritance of the Netherlands brought him into collision with their inhabitants, who feared his absolutist tendencies, and with the Reformation.

The revolt in the Low Countries was inevitably favoured by both France and England. Philip was consequently drawn into intervention in the religious wars of France *(q.v.)* and into war with England, which culminated in the great Armada *(q.v.)* of 1588. His relations with England were further complicated by the extension of English maritime enterprise to the New World (see HAWKINS, JOHN; and DRAKE, FRANCIS). In the Mediterranean he was equally forced by his position to take a part in resisting the Turks (see MALTA: *History*; and LEPANTO, BATTLE OF). But the key to his whole policy must be sought in his relations to his Flemish subjects. With his absolutist tendencies he was bound to wish to govern them as he did Castile, and the principle of religious toleration, which was not understood by any prince in Europe with the exception of the prince of Orange, William the Silent *(q.v.)*, was peculiarly impossible for him. His reign was therefore one long struggle with forces which he was unable to master.

The burden of the struggle fell with crushing effect on his Spanish dominions and peculiarly on Castile. Aragon, which was poor and tenacious of its rights, would give little; Catalonia and Valencia afforded small help. The Flemish revenue was destroyed by the revolt. The Italian states barely paid their expenses. Resources for the incessant wars of the reign had been sought in the taxation of Castile and the revenue from the mines of America. They were wholly inadequate, and the result of the attempt to dominate all western Europe was to produce bankruptcy and exhaustion. In his internal government Philip was fully despotic. He made no pretence of consulting the Cortes on legislation, and though he summoned them to vote new taxes he established the rule that the old were to be considered as granted for ever, and as constituting the fixed revenue of the Crown. The nobles were excluded from all share in the administration, which was in the hands of boards (*juntas*) of lawyers and men of the middle class. All business was conducted by correspondence, and with a final reference to the king, and the result was naturally endless delay.

The first years of the reign of Philip II. were occupied in concluding the last of his father's wars with France, to which was added a very unwelcome quarrel with the pope, arising out of his position as duke of Milan. He was unable to avoid sending an army under Alva against Paul IV., and was glad to avail himself of the services of Venice to patch up a peace. On the Flemish frontier, with the help of an English contingent and by the good generalship of Philibert of Savoy he defeated a French army at St Quentin on the 10th of August 1557, and again at Gravelines on the 13th of July 1558. But he did not follow up his successes, and the war was ended by the signing of the peace of Cateau Cambrésis on the 2nd of April 1559. The exhaustion of his resources made peace necessary to him, and it was no less desirable to the French government. Philip's marriage with Elizabeth, the daughter of Henry II. and of Catherine de Medici, together with their common fear of the Reformation, bound him for a time to the French royal house. In August 1559 he returned to Spain, which he never left for the rest of his life. The outcry of the Cortes, whether of Castile or of the other states, for relief from taxation was loud. In some cases the king went so far as to levy taxes in what he acknowledged was an illegal manner and excused under the plea of necessity. By 1567 the revolt in the Netherlands was flagrant, and the duke of Alva was sent with a picked army, and at the expense of Spain, to put it down. In the following year the tyranny of the Inquisition, encouraged by the king who desired to purge his kingdom of all taint of heterodoxy, led to the revolt of the Moriscos, which desolated Granada from 1568 to 1570, and ruined the province completely. The Moriscos had looked for help from the Turks, who were engaged in conquering Cyprus from Venice. The danger to Spain and to the Spanish possessions in Italy stimulated the king to join in the Holy League formed by the pope and Venice against the Turks; and Spanish ships and soldiers had a great

share in the splendid victory at Lepanto. But the penury of the treasury made it impossible to maintain a permanent naval force to protect the coast against the Barbary pirates *(q.v.)*. Andalusia, Murcia, Valencia, Catalonia and the Balearic Islands were subject to their raids throughout the whole of the 16th and 17th centuries. In 1581 Philip annexed Portugal, as heir to King Henry, the aged successor of Dom Sebastian. Philip endeavoured to placate the Portuguese by the fullest recognition of their constitutional rights, and in particular by favouring the *fidalgos* or gentry. The duke of Braganza, whose claims were better than Philip's, was bought off by immense grants. Spain seemed now to have reached a commanding height of power. But she was internally exhausted. Her real weakness, and the incompetence of her government, were shown when open war began with England in 1585. While a vast armament was being slowly collected for the invasion of England, Drake swept the West Indies, and in 1587 burnt a number of Spanish ships in their own harbour of Cadiz. The ruinous failure of the great Armada in 1588 demonstrated the incapacity of Spain to maintain her pretensions. In 1591 the support given by the Aragonese to Antonio Perez *(q.v.)* led to the invasion of their country by a Castilian army. The constitutional rights of Aragon were not entirely suppressed, but they were diminished, and the kingdom was reduced to a greater measure of submission. In his later years Philip added to all his other burdens a costly intervention in France to support the league and resist the succession of Henry IV. to the throne. He was compelled to acknowledge himself beaten in France before his death on the 13th of September 1598. He left the war with England and with the Netherlands as an inheritance to his son.

Exhaustion of Spain.

The period of one hundred and two years covered by the reigns of Philip III. (1598-1621), Philip IV. (1621-1665) and Charles II. (1665-1700), was one of decadence, ending in intellectual, moral and material degradation. The dynasty continued to make the maintenance of the rights and interests of the House of Austria its main object. Spain had the misfortune to be saved from timely defeat by the weakness of its neighbours. The policy of James I. of England *(q.v.)*, the civil wars of Charles I. *(q.v.)*, the assassination of Henry IV. of France, the troubles of the minority and reign of Louis XIII. *(q.v.)* and the Fronde *(q.v.)*, preserved her from concerted and persistent foreign attack. After a futile attempt to injure England by giving support to the earl of Tyrone in Ireland (see TYRONE, EARLS OF) peace was made between the powers in 1604. In 1609 a twelve years' truce was made with the Dutch. But the temporary cessation of foreign wars brought no real peace to Spain. In 1610 fears of the help which the Moriscos might give to a Mahomedan attack from Africa combined with religious bigotry to cause their expulsion. The measure was thoroughly popular with the nation, but it was industrially more injurious than a foreign invasion need have been. The king was idle and pleasure-loving. He resigned the control of his government to the duke of Lerma *(q.v.)*, one of the most worthless of all royal favourites. The expenses of the royal household increased fourfold, and most of the increase was absorbed by the favourite and his agents. The nobles, who had been kept at a distance by Philip II., swarmed round the new king, and began to secure pensions in the old style. The pillage was so shameless that public opinion was stirred to revolt. Some of the lesser sinners were forced to restitution, and in 1618 Lerma fell from power, but only because he was supplanted by his son, the duke of Uceda, a man as worthless as himself. In that year was taken the step which was destined to consummate the ruin of Spain. The Thirty Years' War began in Germany, and Spain was called upon to support the House of Austria.

Philip III., 1598-1621.

The death of Philip III. on the 21st of March 1621 brought no real change. His son, Philip IV., was an abler man, and even gave indications of a wish to qualify himself to discharge his duties as king. But he was young, pleasure-loving, and wanted the strength of will to make his good intentions effective.

For twenty years the administration was really directed by his favourite the count of Olivares (*q.v.*) and duke of San Lucar, known as the "Conde Duque," the count-
Philip IV., 1621-1665. Olivares was far more able and honest than Lerma. But he could only keep his place by supplying his master with the means of dissipation and by conforming to his dynastic sentiments. The truce concluded in 1609 with Holland ended in 1621, and was not renewed. The commercial classes, particularly in Portugal, complained that it subjected them to Dutch competition. War was renewed, and the Dutch invaded Brazil. As their fleets made it dangerous to send troops by sea to Flanders, Spain had to secure a safe road overland. Therefore she endeavoured to obtain full control of the Valtellina, the valley leading from Lombardy to Tirol, and from thence to the German ecclesiastical states, which allowed a free passage to the Spanish troops. War with France ensued. The failure of the treaty of marriage with England (see CHARLES I. and BUCKINGHAM, FIRST DUKE OF) led to war, for the English court was offended by the Spanish refusal to aid in the restoration of the count palatine, son-in-law of James I., to his dominions. In Flanders the town of Breda was taken after a famous siege. The French conducted their campaign badly. The Dutch were expelled from Bahia in Brazil, which they had seized. An English attack on Cadiz in 1625 was repulsed. His flatterers called the king Philip the Great. A few years later it began to be a standing jest that he was great in the sense that a pit is great: the more that is taken from it the greater it grows. By 1640 the feebleness of the monarchy was so notorious that it began to fall to pieces. In that year Portugal fell away without needing to strike a blow. Then followed the revolt of Naples (see MASANIELLO) and of the Catalans, who were bitterly angered by the excesses of the troops sent to operate against the French in Roussillon. They called in the French, and the Spanish government was compelled to neglect Portugal. Olivares, who was denounced by the nation as the cause of all its misfortunes, was dismissed, and the king made a brief effort to rule for himself. But he soon fell back under the control of less capable favourites than Olivares. In 1643 the prestige of the Spanish infantry was ruined by the battle of Rocroy. At the peace of Münster, which ended the Thirty Years' War in 1648, Spain was cynically thrown over by the German Habsburgs for whom she had sacrificed so much. Aided by the disorders of the minority of Louis XIV., she struggled on till the peace of the Pyrenees in 1659, by which Roussillon was ceded to France. An attempt was now made to subdue Portugal, but the battle of Montesclaros in 1665 proved the futility of the effort. The news of the disaster was followed by the death of the king on the 17th of September 1665. Catalonia was saved by the reaction produced in it by the excesses of the French troops, and in Naples the revolt had collapsed. But Portugal was lost for ever, and the final judgment on the time may be passed in the words of Olivares, who complained that he could find "no men" in Spain. He meant no men fit for high command. The intellect and character of the nation had been rendered childish.

Charles II., 1665-1700.

During the whole of the reign of Charles II. (1665-1700), the son of the second marriage of Philip IV. with his niece Mariana of Austria, the Spanish monarchy was an inert mass, which Louis XIV. treated as raw material to be cut into at his discretion, and was saved from dismemberment only by the intervention of England and Holland. The wars of 1667-68, ended by the peace of Aix-la-Chapelle, those of 1672-78, ended by the peace of Nijmegen, those of 1683-84, ended by the peace of Ratisbon, and the war of the League of Augsburg, 1689-96, were some of them fought wholly, and all of them partly, because the French king wished to obtain one or another portion of the dominions of the Spanish Habsburgs. But Spain took a subordinate and often a merely passive part in these wars. The king was imbecile. During his minority the government was directed by his mother and her successive favourites, the German Jesuit Nithard and the Granadine adventurer Fernando de Valenzuela. In 1677 the king's bastard brother,

the younger Don John of Austria, defeated the queen's faction, which was entirely Austrian in sentiment, and obtained power for a short time. By him the king was married in 1679 to Marie Louise of Orleans, in the interest of France. When she died in 1689, he was married by the Austrian party to Mariana of Neuburg. At last the French party, which hoped to save their monarchy from partition by securing the support of France, persuaded the dying king to leave his kingdom by will to the duke of Anjou, the grandson of Louis XIV., and of Maria Teresa, daughter of Philip IV. by his first marriage. On the death of Charles II., on the 1st of November 1700, the duke of Anjou was proclaimed king.

The Bourbon Dynasty.—The decision of Louis XIV. to accept the inheritance left to his grandson by Charles II. led to a final struggle between him and the other powers of western Europe (see SPANISH SUCCESSION, WAR OF THE), *War of Succession*, which was terminated in 1713 by the peace of Utrecht. The part taken by Spain in the actual *1700-13.*

struggle was mainly a passive one, and it ended for her with the loss of Gibraltar and the island of Minorca, which remained in the hands of England, and of all her dominions in Italy and Flanders. Another and a very serious consequence was that England secured the *Asiento* (*q.v.*), or contract, which gave her the monopoly of the slave trade with the Spanish colonies, as well as the right to establish "factories"—that is to say commercial agencies—in several Central and South American ports, and to send one cargo of manufactured goods yearly in a ship of 500 tons to New Carthage. In internal affairs the years of the war were of capital importance in Spanish history. The general political and administrative nullity of the Spaniards of this generation led to the assumption of all real power by the French or Italian servants and advisers of the king. Under their direction important financial and administrative reforms were begun. The opposition which these innovations produced encouraged the separatist tendencies of the eastern portion of the Peninsula. Philip V. was forced to reduce Aragon, Catalonia and Valencia by arms. Barcelona was only taken in 1714, the year after the signing of the treaty of Utrecht. The local privileges of these once independent kingdoms, which had with rare exceptions been respected by the Austrian kings, were swept away. Their disappearance greatly promoted the work of national unification, and was a gain, since they had long ceased to serve any really useful purpose. The removal of internal custom-houses, and the opening of the trade with America, hitherto confined to Seville and to the dominions of the crown of Castile, to all Spaniards, were considerable boons. The main agents in introducing and promoting these changes were the French ambassadors, a very able French treasury official—Jean Orry, seigneur de Vignory, (1652-1719)—and the lady known as the princess des Ursins (*q.v.*), the chief lady-in-waiting. Her maiden name was Anne Marie de la Trémoille, and she was the widow of Flavio Orsini, duke of Bracciano. Until 1714 she was the power behind the throne in Spain. On the death of Philip V.'s first wife Maria Louisa Gabriella of Savoy, in 1714, the king was married at once to Elizabeth Farnese of Parma, who expelled Mme des Ursins, obtained complete control over her husband, and used her whole influence to drag Spain into a series of adventures in order to obtain Italian dominions for her sons. Her first agent was the Italian priest Alberoni (*q.v.*), whose favour lasted from 1714 to 1719. Alberoni could not, and perhaps did not, sincerely wish to prevent the queen and king from plunging into an attempt to recover Sardinia and Sicily, which provoked the armed intervention of France and England and led to the destruction of the rising Spanish navy off Cape Pássaro (see TORRINGTON, GEORGE BYNG, VISCOUNT). In 1731 Elizabeth secured the succession of her eldest son, Charles, afterwards Charles III. of Spain, to the duchy of Parma, by arrangement with England and the Empire. Apart from the Italian intrigues, the most important foreign affairs of the reign were connected with the relations of Spain with England. A feeble attempt to regain

Philip V., 1700-1746.

Queen Elizabeth Farnese and Alberoni.

Gibraltar was made in 1733, and a serious war was only averted by the resolute peace policy of Sir Robert Walpole. But in 1739 trade difficulties, which had arisen out of the *Asiento* in America, led to a great war with England, which became merged in the War of the Austrian Succession (*q.v.*). The king, who had become almost entirely mad at the end of his life, died on the 9th of July 1746. His successor, Ferdinand VI., the second son of his first marriage, whose reign lasted till the 10th of August **Ferdinand VI., 1746-1759.** was a retiring and modest man, who adopted a policy of peace with England. His ministers, of whom the most notable were Zenon de Somadevila, marquis of Ensenada, and Richard Wall, an Irish Jacobite, carried on the work of financial and administrative reform. The advance of the country in material prosperity was considerable. Foreign influences in thought and literature began to modify the opinions of Spaniards profoundly. The party known as the *Regalistas*, the lawyers who wished to vindicate the regalities, or rights of the Crown, against the encroachments of the pope and the Inquisition, gained the upper hand.

The new sovereign was one of the most sincere, and the most successful, of the "enlightened despots" of the 18th century. He had had a long apprenticeship in Naples, and was **Charles III., 1759-1788.** a man of forty-three when he came to Spain in 1759. Until his death on the 14th of December 1788 he was engaged in internal politics, in endeavouring to advance the material prosperity of Spain. His foreign policy was less wise. He had a deep dislike of England, and a strong desire to recover Minorca and Gibraltar, which she held. He had also a strong family feeling, which induced him to enter into the "Family Compact" with his French cousins. He made war on England in 1761, with disastrous results to Spain, which for the time lost both Havana and Manila. In 1770 he came to the verge of war with England over the Falkland Islands. In 1778 he joined France in supporting the insurgent English colonists in America. The most statesmanlike of his foreign enterprises, the attempt to take the piratical city of Algiers in 1775 (see *BARBARY PIRATES*), was made with insufficient forces, was ill executed, and ended in defeat. Yet he was able to recover Minorca and Florida in the War of American Independence, and he finally extorted a treaty with Algiers which put a stop to piratical raids on the Spanish coast. The worst result for Spain of his foreign policy was that the example set by the United States excited a desire for independence in the Spanish colonies, and was the direct incitement to the rebellions at the beginning of the 19th century. The king's domestic policy, on the contrary, was almost wholly fruitful of good. Under his direction many useful public works were carried out—roads, bridges and large schemes of drainage. The first reforms undertaken had provoked a disturbance in Madrid directed against the king's favourite minister, the Sicilian marquis of Squillacci. Charles, who believed that the Jesuits had promoted the outbreak, and also that they had organized a murder plot against him, allowed his minister Aranda (*q.v.*), the correspondent of Voltaire, to expel the order in 1766, and he exerted his whole influence to secure its entire suppression. The new spirit was otherwise shown by the restrictions imposed on the numbers of the religious orders and on the Inquisition, which was reduced to practical subjection to the lay courts of law. Many of the king's industrial enterprises, such as the Bavarian colony, established by him on the southern slope of the Sierra Morena, passed away without leaving much trace. On the other hand the shipping and the industry of Spain increased greatly. The population made a considerable advance, and the dense cloud of sloth and ignorance which had settled on the country in the 17th century was lifted. In this work Charles III. was assisted, in addition to Squillacci and Aranda, by Campomanes (*q.v.*), who succeeded Aranda as minister of finance in 1787, and by Floridablanca (*q.v.*), who ruled the country in the spirit of enlightened bureaucracy.

Charles III. was succeeded in 1788 by his son Charles IV. The father, though "enlightened," had been a thorough despot; the son was sluggish and stupid to the verge of imbecility, but the despotism remained. The new king was much under the

influence of his wife, Maria Louisa of Parma, a coarse, passionate and narrow-minded woman; but he continued to repose confidence in his father's ministers. Floridablanca was, however, unable to continue his earlier policy, **Charles IV., 1788-1808.** in view of the contemporaneous outbreak of the Revolution in France. The revival of Spain depended on the restoration of her colonial and naval ascendancy at the expense of Great Britain, and for this the support of France was needed. But the "Family Compact," on which the French alliance depended, ceased to exist when Louis XVI. was deprived of power by his subjects. Of this conclusive evidence was given in 1791. Some English merchants had violated the shadowy claim of Spain to the whole west coast of America by founding a settlement at Nootka Sound. The Spanish government lodged a vigorous protest, but the French National Assembly refused to lend any assistance, and Floridablanca was forced to conclude a humiliating treaty and give up all hope of opposing the progress of Great Britain. This failure was attributed by the minister to the Revolution, **Spain and the French Revolution.** The reforms of Charles III.'s reign were abandoned and all liberal tendencies in Spain were suppressed. But Floridablanca was not content with suppressing liberalism in Spain; he was eager to avenge his disappointment by crushing the Revolution in France. He opened negotiations with the *émigrés*, urged the European powers to a crusade on behalf of legitimacy, and paraded the devotion of Charles IV. to the head of his family. This bellicose policy, however, brought him into collision with the queen, who feared that the outbreak of war would diminish the revenues which she squandered in self-indulgence. She had already removed from the ministry Campomanes and other supporters of Floridablanca, and had compelled the latter to restrict himself to the single department of foreign affairs. Early in 1792 she completed her task by inducing Charles IV. to banish Floridablanca to Murcia, and his place was entrusted to the veteran Aranda, who speedily found that he held office only by favour of the queen, and that this had to be purchased by a disgraceful servility to her paramour, Emanuel Godoy. Spain withdrew from the projected coalition against France, and sought to maintain an attitude of neutrality, which alienated the other powers, while it failed to conciliate the Republic. The repressive measures of Floridablanca were withdrawn; society and the press regained their freedom; and no opposition was offered to the propaganda of French ideas. Aranda's policy might have been successful if it had been adopted earlier, but the time for temporizing was now past, and it was necessary to choose one side or the other. In November 1792 the queen felt herself strong enough to carry out the scheme which she had been long maturing. Aranda was dismissed, **Godoy.** and the office of first minister was entrusted to Godoy, who had recently received the title of duke of Alcudia. Godoy, who was at once the queen's lover and the personal favourite of the king, had no experience of the routine of office, and no settled policy. Fortunately for him, the course now to be pursued was decided for him. The execution of Louis XVI. (Jan. 21, 1793) made a profound impression in a country where loyalty was a superstition. Charles IV. was roused to demand vengeance for the insult to his family, and Spain became an enthusiastic member of the first coalition against France. The number of volunteers who offered their services rendered conscription unnecessary; and the southern provinces of France welcomed the Spaniards as deliverers. These advantages, however, were nullified by the shameful incompetence and carelessness of the government. The troops were left without supplies; no plan of combined action was imposed upon the commanders; and the two campaigns of 1793 and 1794 were one long catalogue of failures. Instead of reducing the southern provinces of France, the Spaniards were driven from the strong fortresses that guarded the Pyrenees, and the French advanced almost to the Ebro; and at the same time the British were utilizing the war to extend their colonial power and were establishing more firmly that maritime

supremacy which the Spanish government had been struggling for almost a century to overthrow. Under the circumstances the queen and Godoy hastened to follow the example set by Prussia, and concluded the treaty of Basel with France (1795). The terms were unexpectedly favourable, and so great was the joy excited in Madrid that popular acclamation greeted the bestowal upon Godoy of the title of "Prince of the Peace." But the moderation of the treaty was only a flimsy disguise of the disgrace that it involved. Spain found herself tied hand and foot to the French republic. Godoy had to satisfy his allies by the encouragement of reforms which both he and his mistress loathed, and in 1796 the veil was removed by the conclusion of the treaty of San Ildefonso. This was a virtual renewal of the "Family Compact" of 1761, but with terms far more disadvantageous to Spain. Each power was pledged to assist the other in case of war with twenty-five ships, 18,000 infantry and 6000 cavalry. The real object of the treaty, which was to involve Spain in the war against Great Britain, was cynically avowed in the 18th article, by which, during the present war, the Spanish obligations were only to apply to the quarrel between Great Britain and France. A scheme was prepared for a joint attack on the English coast, but it was foiled by the battle of St Vincent (*q.v.*), in which Jervis and Nelson forced the Spanish fleet to retire to Cadiz. This defeat was the more disastrous because it deprived Spain of the revenues derived from her colonies. Great Britain seized the opportunity to punish Spain for its conduct in the American War by encouraging discontent in the Spanish colonies, and in the Peninsula itself both nobles and people were bitterly hostile to the queen and her favourite. It was in vain that Godoy sought to secure the friendship of the reforming party by giving office to two of its most prominent members, Jovellanos and Saavedra. Spanish pride and bigotry were offended by the French occupation of Rome and the erection of a republic in the place of the papal government. The treatment of the duke of Parma by the Directory was keenly resented by the queen. Godoy found himself between two parties, the Liberals and the Ultramontanes, who agreed only in hatred of himself. At the same time the Directory, whose mistrust was excited by his attitude in the question of Parma, insisted upon his dismissal. Charles IV. could not venture to refuse; the queen was alienated by Godoy's notorious infidelities; and in March 1798 he was compelled to resign his office.

Godoy's office was entrusted to Saavedra, but the reformers did not obtain the advantages which they expected from the change. Jovellanos was compelled in August to retire on account of ill health—the result, it was rumoured—of attempts on the part of his opponents to poison him. His place was taken by Caballero, an ardent opponent of reform, who restored all the abuses of the old bureaucratic administration and pandered to the bigoted prejudices of the clergy and the court. The only advantage which Spain enjoyed at this period was comparative independence of France. The military plans of the Directory were unsuccessful during the absence of their greatest general in Egypt, and the second coalition gained successes in 1799 which had seemed impossible since 1793. But the return of Bonaparte, followed as it was by the fall of the Directory and the establishment of the Consulate, commenced a new epoch for Spain. As soon as the First Consul had time to turn his attention to the Peninsula,

he determined to restore Godoy, who had already regained the affection of the queen, and to make him the tool of his policy. Maria Louisa was easily gained over by playing on her devotion to the house of Parma, and on the 1st of October 1800 a secret treaty was concluded at San Ildefonso. Spain undertook to cede Louisiana and to aid France in all her wars, while Bonaparte promised to raise the duke of Parma to the rank of king and to increase his territories by the addition either of Tuscany or of the Roman legations. This was followed by Godoy's return to power, though he left the department of foreign affairs to a subordinate. Spain was now more servile to France than ever, and in 1801 was compelled to attack Portugal in the French interests. The Spanish invasion, commanded by Godoy in person, met with no resistance, and the

prince ventured to conclude a peace on his own authority by which Portugal promised to observe a strict neutrality on condition that its territories were left undiminished. But Bonaparte resented this show of independence, and compelled Charles IV. to refuse his ratification of the treaty. Portugal had to submit to far harsher terms, and could only purchase peace by the cession of territory in Guiana, by a disadvantageous treaty of commerce, and by payment of twenty-five million francs. In the preliminary treaty with Great Britain he ceded the Spanish colony of Trinidad without even consulting the court of Madrid, while he sold Louisiana to the United States in spite of his promise not to alienate it except to Spain.

Godoy, since his return, had abandoned all connexion with the reforming party. The Spanish Church was once more placed in strict subjection to the Roman see, from which for a short time it had been freed. As soon as Bonaparte saw himself involved in a new war with England, he turned to Spain for assistance and extorted a new treaty (Oct. 9, 1803), which was still more burdensome than that of 1796. Spain had to pay a monthly subsidy of six million francs, and to enforce strict neutrality upon Portugal, this involving war with England. The last remnants of its maritime power were shattered in the battles of Cape Finisterre and Trafalgar, and the English seized Buenos Aires. The popular hatred of Godoy was roused to passion by these disasters, and Spain seemed to stand on the brink of revolution. At the head of the opposition was Ferdinand, the heir to the throne, as insignificant as his rival, but endowed with all good qualities by the credulous favour of the people. Napoleon was at this time eager to humble Great Britain by excluding it from all trade with Europe. The only country which had not accepted his "continental system" was Portugal, and he determined to reduce that kingdom by force. It was not difficult to bribe Godoy, who was conscious that his position could not be maintained after the death of Charles IV. In October 1807 Spain accepted the treaty of Fontainebleau. (See PORTUGAL: *History*.) The treaty was hardly concluded when a French army under Junot marched through Spain to Portugal, and the royal family of that country fled to Brazil. Ferdinand, whose wife had died in 1806, determined to imitate his rival by bidding for French support. He entered into secret relations with Eugène Beauharnais, Napoleon's envoy at Madrid, and went so far as to demand the hand of a Bonaparte princess. Godoy, who discovered the intrigue, induced Charles IV. to order his son's arrest (Oct. 27, 1807), on the charge of plotting to dethrone his father and to murder his mother and Godoy. The prince indeed was soon released and solemnly pardoned; but, meanwhile, Napoleon had seized the opportunity afforded by the effect of this public scandal in lowering the prestige of the royal family to pour his troops into Spain, under pretext of reinforcing Junot's corps in Portugal. Even this excuse was soon dropped, and by January and February 1808 the French invasion had become clearly revealed as one of conquest. Charles IV. and his minister determined on flight. The news of this intention, however, excited a popular rising at Aranjuez, whither the king and queen had gone from Madrid. A raging mob surrounded the palace, clamouring for Godoy's head; and the favourite's life was only saved by Charles IV.'s announcement of his abdication in favour of Ferdinand (March 17). Murat, however, who commanded the French, refused to be turned aside by this change of circumstances. He obtained from Charles IV. a declaration that his abdication had been involuntary, and occupied Madrid (March 23, 1808). Meanwhile Napoleon had advanced to Bayonne on the frontier, whither, at his orders, Murat despatched the old king and queen and their favourite Godoy. The emperor had already made up his mind to place one of his brothers on the Spanish throne; but in order to achieve this it was necessary to cajole the young king Ferdinand VII. and get him into his power. Ferdinand, instead of retiring to Andalusia and making himself the rallying point of national resistance, had gone to Madrid, where he was at the mercy of Murat's troops and whence he wrote grovelling letters to Napoleon. It was no difficult matter for the emperor's

Napoleon and Spain.

Napoleon attacks Spain.

envoy, General Savary, to lure him by specious promises to the frontier, and across it to Bayonne, where he was confronted with his parents and Godoy in a scene of pitiful degradation. Struck and otherwise insulted, he was forced to restore the crown to his father, who laid it at the feet of Napoleon. The old king and queen, pensioned by the French government, retired to Rome; *Abdication* Ferdinand was kept for six years under strict military guard at Talleyrand's château of Valençay (see *IV.* FERDINAND VII., King of Spain). On the 13th of May Murat announced to an improvised "junta of regency" at Madrid that Napoleon desired them to accept Joseph Bonaparte as their king.

But Spanish loyalty was too profound to be daunted even by the awe-inspiring power of the French emperor. For the first time Napoleon found himself confronted, not by *Joseph Bonaparte* terrified and selfish rulers, but by an infuriated *proclaimed* people. The rising in Spain began the popular movement which ultimately proved fatal to his power. At first he treated the novel phenomenon with contempt, and thought it sufficient to send his less prominent generals against the rebels. Madrid was easily taken, but the Spaniards showed great capacity for the guerrilla warfare in the provinces. The French were repulsed from Valencia; and Dupont, who had advanced into the heart of Andalusia, was compelled to retreat and ultimately to capitulate with all his forces at Baylen (July 10). The Spaniards now advanced upon Madrid and drove Joseph from the capital, which he had just entered. Unfortunately the insurgents displayed less political ability than military courage. Godoy's agents, the ministers, were swept aside by the popular revolt, and their place was taken by local *juntas*, or committees, and then by a central junta formed from among them, which ruled despotically in the name of the captive king. In a country divided by sectional jealousies it was impossible to expect a committee of thirty-four members to impose unity of action even in a common cause; and the Spanish rising, the first fierceness of which had carried all before it, lacked the organizing force which alone would have given it permanent success. As it was, Napoleon's arrival in Spain was enough to restore victory to the French. In less than a week the Spanish army was broken through and scattered, and Napoleon restored his brother in Madrid. Sir John Moore, who had advanced with an English army to the relief of the capital, retired when he found he was too late, and an obstinate battle, in which the gallant general lost his life, had to be fought before the troops could secure their embarkation at Corunna. Napoleon, thinking the work accomplished, had quitted the Peninsula, and Soult and Victor were left to complete the reduction of the provinces. The capture of Seville resulted in the dissolution of the central junta, and the Peninsula was only saved from final submission by the obstinate resistance of Wellington in Portugal and by dissensions among the French. The marshals were jealous of each other, and Napoleon's plans were not approved by his brother. Joseph wished to restore peace and order among his subjects in the hope of ruling an independent nation, while Napoleon was determined to annex Spain to his own overgrown empire. So far did these disputes go that Joseph resigned his crown, and was with difficulty induced to resume it. Meanwhile, the dissolution of the central junta had given free play to the extremest reforming parties; on the 24th of September these met at Cadiz, which became the capital of what was left of independent Spain.

The Spanish Cortes had never been so entirely suspended as the states-general of France. Philip V., after suppressing the local institutions of the crown of Aragon, had given *Cortes of 1810.* representation to some of the eastern cities in the general Cortes of Spain. This body had been summoned at the beginning of reigns to swear homage to the new king and his heir, or to confirm regulations made as to the succession. It sat in one house, and was composed of the nobles and churchmen who formed the great majority of procurators chosen by the town councils of a limited though varying number of towns, and of representatives of "kingdoms." The Cortes of 1810 was constructed on

these lines, but with a very important difference in the proportion of its elements. The third estate of the commons secured 184 representatives, who were sufficient to swamp the nobles and the clergy. No intelligent scheme under which the representatives were to be elected had been fixed. In theory the members of the third estate had been chosen by a process of double election. In fact, however, since much of the country was held by the French, they were often returned by such natives of the regions so occupied as happened to be present in Cadiz at the time. The real power fell to those of the delegates who were influenced by the new ideas. Unhappily, they had no experience of affairs; and they were perfectly ready to make a constitution for Spain on Jacobin lines, without the slightest regard to the real beliefs and interests of Spaniards. Out of these materials nothing could be expected to come except such a democratic constitution as might have been made by a Jacobin club in Paris. In a country noted for its fanatical loyalty to the Crown and the Church, the kingship was to be deprived of all power and influence, and the clergy to be excluded as such from *Spanish Constitution of 1812.* all share in legislation. As though to deprive the constitution of any chance of being made effective, the worst expedients dictated by the suspicious temper of the French convention of 1790 were adopted. Ministers were excluded from the chamber, thus rendering impossible any effective co-operation between the legislature and the executive; and, worst of all, a provision was introduced making members of the Cortes ineligible for re-election, an effective bar to the creation of a class of politicians possessing experience of affairs.

The Spaniards were so broken to obedience, and the manlier part of them so intent on fighting the French, that the Cortes was not at the time resisted. The suppression of the Inquisition and the secularization of the church lands—measures which had already been taken by the government of the intruding French king Joseph at Madrid—passed together with much else. But even before the new constitution was published and sworn, on the 19th of March 1812, large numbers of Spaniards had made up their minds that after the invaders were driven out the Cortes must be suppressed.

The liberation of Spain could hardly have been accomplished without the assistance of Great Britain. The story of the struggle, from the military point of view, is told in the article *PENINSULAR WAR.* In 1812 Wellington determined on a great effort. He secured his base of operations by the capture of Ciudad Rodrigo and Badajoz, and at Salamanca he completely routed the opposing army of Marmont. This victory enabled the English general to enter Madrid (Aug. 12), and Joseph retreated to Valencia. But further advance was prevented by the concentration of the French forces in the east, and Wellington found it advisable to retire for the third time to winter quarters on the Portuguese frontier. It was during this winter that Napoleon suffered his first and greatest reverse in the retreat from Moscow and the destruction of his grand army. This was the signal for the outbreak of the "war of liberation" in Germany, and French troops had to be withdrawn from Spain to central Europe. For the first time Wellington found himself opposed by fairly equal forces. In the spring of 1813 he advanced from Ciudad Rodrigo and defeated Jourdan at Vittoria, the battle which finally decided the Peninsular War. Joseph retired altogether from his kingdom, and Wellington, eager to take his part in the great European contest, fought his way through the Pyrenees into France. Napoleon, who had suffered a crushing defeat at Leipzig, hastened to recognize the impossibility of retaining Spain by releasing Ferdinand VII., who returned to Madrid in March 1814.

Before entering Spain Ferdinand had undertaken to maintain the constitution of 1812, and when on the 22nd of March 1814 he reached Figueras, he was met by a demand on *Restoration of Ferdinand VII., 1814.* the part of the Cortes that he must accept all the terms of the constitution as a condition of his recognition as king. But Ferdinand had convincing proof of the true temper of the nation. He now refused to recognize the constitution, and was supported in his refusal

not only by the army and the Church, but by the masses. There can be no doubt that Ferdinand VII. could have ruled despotically if he had been able to govern well. But, although possessed of some sardonic humour and a large measure of cunning, he was base, and had no real capacity. He changed his ministers incessantly, and on mere caprice. Governed by a *camarilla* of low favourites, he was by nature cruel as well as cowardly. The government under him was thoroughly bad, and the persecution of the "Jacobins," that is of all those suspected of Liberal sentiment, ferocious. Partial revolts took place, but were easily crushed. The revolt which overpowered him in 1820 was a military mutiny. During the war the American colonies had rebelled, and soldiers had been sent to suppress them. No progress had been made, the service was dreadfully costly in life, and it became intensely unpopular among the troops. Meanwhile the brutality of the king and his ministers had begun to produce a reaction. Not a few of the officers held Liberal opinions, and this was especially

Revolution of 1820. the case with those who had been prisoners in France during the war and had been inoculated with foreign doctrines. These men, of whom the most conspicuous was Colonel Rafael Riego (*q.v.*), worked on the discontent of the soldiers, and in January 1820 brought about a mutiny at Cadiz, which became a revolution. Until 1823 the king was a prisoner in the hands of a section of his subjects, who restored the constitution of 1812 and had the support of the army. The history of these three miserable years cannot be told except at impossible length. It was a mere anarchy. The Liberals were divided into sub-sections, distinguished from one another by a rising scale of violence. Any sign of moderation on the part of the ministers chosen from one of them was enough to secure him the name of "Servile" from the others. The "Serviles" proper took up arms in the north. At last this state of affairs became intolerable to the French government of Louis XVIII. As early as 1820 the emperor Alexander I. of Russia had suggested a joint intervention of the powers of the Grand Alliance to restore order in the Peninsula, and had offered to place his own army at their disposal for the purpose.

The Congress of Verona and Spain. The project had come to nothing owing to the opposition of the British government and the strenuous objection of Prince Metternich to a course which would have involved the march of a powerful Russian force through the Austrian dominions. In 1822 the question was again raised as the main subject of discussion at the congress assembled at Verona (see VERONA, CONGRESS OF). The French government now asked to be allowed to march into Spain, as Austria had marched into Naples, as the mandatory of the powers, for the purpose of putting a stop to a state of things perilous alike to herself and to all Europe. In spite of the vigorous protest of Great Britain, which saw in this demand only a pretext for reviving the traditional Bourbon ambitions in the Peninsula, the mandate was granted by the majority of the powers; and on the 7th of April 1823 the duke of

French intervention, 1823. Angoulême, at the head of a powerful army, crossed the Bidassoa. The result was a startling proof of the flimsy structure of Spanish Liberalism. What the genius of Napoleon had failed to accomplish through years of titanic effort, Angoulême seemed to have achieved in a few weeks. But the difference of their task was fundamental. Napoleon had sought to impose upon Spain an alien dynasty; Angoulême came to restore the Spanish king "to his own." The power of Napoleon had been wrecked on the resistance of the Spanish people; Angoulême had the active support of some Spaniards and the tacit co-operation of the majority. The Cortes, carrying the king with it, fled to Cadiz, and after a siege, surrendered with no conditions save that of an amnesty, to which Ferdinand solemnly swore before he was sent over into the French lines. As was to be expected, an oath taken "under compulsion" by such a man was little binding; and the French troops were compelled to witness, with helpless indignation, the orgy of cruel reaction which immediately began under the protection of their bayonets.

The events of the three years from 1820-1823 were the beginning of a series of convulsions which lasted till 1874. On the one hand were the Spaniards who desired to assimilate their country to western Europe, and on the other those of them who adhered to the old order. The first won because the general trend of the world was in their favour, and because their opponents were blind, contumacious, and divided among themselves.

If anything could have recalled the distracted country to harmony and order, it would have been the object-lesson presented by the loss of all its colonies on the continent of America. These had already become *de facto* **The Spanish Colonies.** independent during the death-struggle of the Spanish monarchy with Napoleon, and the recognition of their independence *de jure* was, for Great Britain at least, merely a question of time. A lively trade had grown up between Great Britain and the revolted colonies; but since this commerce, under the colonial laws of Spain, was technically illegitimate, it was at the mercy of the pirates, who preyed upon it under the aegis of the Spanish flag, without there being any possibility of claiming redress from the Spanish government. The decision of the powers at the congress of Verona to give a free hand to France in the matter of intervention in Spain, gave the British government its opportunity. When the invasion of Spain was seen to be inevitable, Canning had informed the French government that Great Britain would not tolerate the subjugation of the Spanish colonies by foreign force. A disposition of the powers of the Grand Alliance to come to the aid of Spain in this matter was countered by the famous message of President Monroe (Dec. 2, 1823), laying the veto of the United States on any interference of concerted Europe in the affairs of the American continent. The empire of Brazil and the republics of Mexico and Colombia were recognized by Great Britain in the following year; the recognition of the other states was only postponed until they should have given proof of their stability. In announcing these facts to the House of Commons, George Canning, in a phrase that became famous, declared that he had "called a new world into existence to redress the balance of the old" and that "if France had Spain, it should at least be Spain without her colonies."

In Spain itself, tutored by misfortune, the efforts of the king's ministers, in the latter part of his reign, were directed to restoring order in the finances and reviving agriculture **Reactionary Elements in Spain.** and industry in the country. The king's chief difficulties lay in the attitude of the extreme monarchists (*Apostolicos*), who found leaders in the king's brother Don Carlos and his wife Maria Francisca of Braganza. Any tendency to listen to liberal counsels was denounced by them as weakness and met by demands for the restoration of the Inquisition and by the organization of absolutist demonstrations, and even revolts, such as that which broke out in Catalonia in 1828, organized by the "supreme junta" set up at Manresa, with the object of freeing the king from "the disguised Liberals who swayed him." Yet the absolute monarchy would probably have lasted for long if a dispute as to the succession had not thrown one of the monarchical parties on the support of the Liberals. The king had no surviving **Question of the Succession. The Pragmatic Sanction.** children by his first three marriages. By his fourth marriage, on the 11th of December 1829, with Maria Christina of Naples he had two daughters. According to the ancient law of Castile and Leon women could rule in their own right, as is shown by the examples of Urraca, Berengaria, and Isabella the Catholic. In Aragon they could transmit the right to a husband or son. Philip V. had introduced the Salic Law, which confined the succession to males. But his law had been revoked in the Cortes summoned in 1789 by Charles IV. The revocation had not however been promulgated. Under the influence of Maria Christina Ferdinand VII. formally promulgated it **Isabella II., Queen, 1833.** at the close of his life, after some hesitation, and amid many intrigues. When he died on the 29th of September 1833, his daughter Isabella II. was proclaimed queen, with her mother Maria Christina as regent.

The immediate result of the dead king's decision was to throw Spain back into a period of squalid anarchy. Maria Christina would have ruled despotically if she could, and began by announcing that material changes would not be made in the method of government. But the Conservatives preferred to support the late king's brother Don Carlos, and they had the active aid of the Basques, who feared for their local franchises, and of the mountaineers of Navarre, Aragon, Catalonia and Valencia, who were either quite clerical, or who had become attached, during the French invasion and the troubles of the reign of Ferdinand,

to a life of *guerrillero* adventure. Maria Christina had the support of the army, and the control of the machinery of government; while the mass of the people passively submitted to the powers that were, while as far as possible eluding their orders. The regent soon found that this was not enough to enable her to resist the active hostility of the Carlists and the intrigues of their clerical allies. She was eventually driven by the necessities of her position to submit to the establishment of parliamentary institutions. She advanced only when forced, first by the need for buying support, and then with the bayonet at her back. First the historic Cortes was summoned. Then in April 1834, under the influence of the minister Martinez de La Rosa, a charter (*Estatuto Real*) was issued establishing a Cortes in two *Estamentos* or Estates, one of senators (*próceres*) and one of deputies, but with no rights save that of petition, and absolutely dependent on the Crown. This constitution was far from satisfying the advanced Liberals, and the supporters of Christina—known as *Cristinos*—broke into two sections, the *Moderados*, or Moderates, and *Progressistas* or *Exaltados*, the Progressists or Hot-heads. In August 1836 a military revolt at the palace of La Granja

in the hills above Segovia drove the regent by sheer violence to accept a democratic constitution, based on that of 1812, which was issued in 1837. Meanwhile *Cristinos* and *Carlistas*, the successors of the "Liberales" and "Serviles," were fighting out their quarrel. In 1835 a violent outbreak against the monastic orders took place. In some cities, notably in Barcelona, it was accompanied by cruel massacres. Though the measure was in itself repugnant to Maria Christina, the pressing needs of her government compelled her to consent when Juan Alvarez y Mendizabal (1790-1853), a minister of Jewish descent, forced on her by Liberals, secularized the monastic lands and used them for a financial operation which brought some relief to the treasury.

The Carlist War lasted from the beginning of Isabella's reign till 1840. At first the Carlists were feeble, but they gathered strength during the disputes among the *Cristinos*. Their leaders, Tomas Zumalacarrregui in Biscay and Navarre, and Ramon Cabrera in Valencia, were the ablest Spaniards of their time. The war was essentially a *guerrilleros* struggle in which the mountaineers held their ground among the hills against the insufficient, ill-appointed, and mostly very ill-led armies of the government, but were unable to take the fortresses, or to establish themselves in central Spain south of the Ebro; though they made raids as far as Andalusia. At last, in August 1839, exhaustion brought the Basques to recognize the government of Queen Isabella by the convention of Vergara in return for the confirmation of their privileges. The government was then able to expel Cabrera from Valencia and Catalonia. Great Britain and France gave some help to the young queen, and their intervention availed to bring a degree of humanity into the struggle.

Maria Christina, who detested the parliamentary institutions which she had been forced to accept, was always ready to nullify them by intrigue, and she was helped by the *Moderados*. In 1841 the regent and the *Espartero*. *Moderados* made a law which deprived the towns of the right of electing their councils. It was resented by the Liberals and provoked a military rising, headed by the most popular of the *Cristino* generals, Baldomero Espartero. The queen regent having been compelled to sign a decree illegally revoking the law, resigned and left for France. Espartero was

declared regent. He held office till 1843, during an agitated period, in which the Carlists reappeared in the north, mutinies were common, and a barbarous attempt was made to kidnap the young queen in her palace on the night of the 7th of October 1841. It was only defeated by the hard fighting of eighteen of the palace guards at the head of the main staircase. In 1843 Espartero, a man of much personal courage and of fitful energy, but of no political capacity, was expelled by a military rising, promoted by a combination of discontented Liberals and the Moderates. The queen, though only thirteen years old, was declared of age.

The reign of Queen Isabella, from 1843 till her expulsion in 1868, was a prolongation of that of her mother's regency. It was a confused conflict between the constant attempt of the court to rule despotically, with a mere pretence of a Cortes, and the growing wish of the Spaniards to possess a parliamentary government, or at least the honest and capable government which they hoped that a parliament would give them. In 1845 the Moderates having deceived their Liberal allies, revised the constitution of 1837 and limited the freedom it gave. Their chief leader, General Ramon Narvaez, had for his guiding principle that government must be conducted by the stick and by hard hitting. In 1846 Europe was scandalized by the ignominious intrigues connected with the young queen's marriage. Louis Philippe, king of the French, saw in the marriage of the young queen a chance of reviving the family alliance which had, in the 18th century, bound Bourbon Spain to Bourbon France. The court of Madrid was rent by the intrigues of the French and the English factions; the former planning an alliance with a son of the French king, the latter favouring a prince of the house of Coburg. The episode of the Spanish marriages forms an important incident in the history of Europe; for it broke the *entente cordiale* between the two western Liberal powers and accelerated the downfall of the July monarchy in France. There can be no doubt, in spite of the apology for his action published by Guizot in his memoirs, that Louis Philippe made a deliberate attempt to overreach the British government; and, if the attempt issued in disaster to himself, this was due, not to the failure of his statecraft so much as to his neglect of the obvious factor of human nature. Palmerston, on behalf of Great Britain, had agreed to the principle that the queen should be married to one of her Bourbon cousins of the Spanish line, and that the younger sister should marry the duke of Montpensier, son of Louis Philippe, but not till the birth of an heir to the throne should have obviated the danger of a French prince wearing the crown of Spain. Louis Philippe, with the aid of the queen-mother, succeeded in forcing Isabella to accept the hand of Don Francisco d'Assisi, her cousin, who was notoriously incapable of having heirs; and on the same day the younger sister was married to the duke of Montpensier. The queen's marriage was miserable; and she consoled herself in a way which at once made her court the scandal of Europe, and upset the French king's plans by providing the throne of Spain with healthy heirs of genuine Spanish blood. But incidentally the scandals of the palace had a large and unsavoury part in the political troubles of Spain. Narvaez brought Spain through the troubled revolutionary years 1848 and 1849 without serious disturbance, but his own unstable temper, the incessant intrigues of the palace, and the inability of the Spaniards to form lasting political parties made good government impossible. The leaders on all sides were of small capacity. In 1854 another series of outbreaks began which almost ended in a revolution. Liberals and discontented Moderates, supported as usual by troops led into mutiny by officers whose chief object was promotion, imposed some restraint on the queen. Another revision of the constitution was undertaken, though not carried out, and Espartero was brought from retirement to head a new government. But the coalition soon broke up. Espartero was overthrown by General Leopold O'Donnell, who in 1858 formed the Union-Liberal ministry which did at last give Spain

Rule of Isabella II.

The "Spanish Marriages."

Ministry of O'Donnell.

five years of fairly good government. A successful war in Morocco in 1859 flattered the pride of the Spaniards, and the country began to make real progress towards prosperity. In 1863 the old scene of confusion was renewed. O'Donnell was dismissed. For the next five years the political history of Spain was the story of a blind attempt on the part of the queen to rule despotically, by the help of reckless adventurers of mean capacity, and by brute violence. The opposition took the form of successive military outbreaks accompanied by murder, and suppressed by massacre. In 1868 the government of Queen Isabella collapsed by its own rottenness. She had even lost the mob popularity which she had once gained by her jovial manners. All men of political influence were either in open opposition or, when they belonged to the Conservative parties, were holding aloof in disgust at the predominance of the queen's favourites, Gonzales Brabo, a mere ruffian, and Marfori, her steward, whose position in the palace was perfectly well known.

In September 1868 the squadron at Cadiz under the command of Admiral Topete mutinied, and its action was the signal for a general secession. One gallant fight was made for the queen at the bridge of Alcolea in Andalusia by General Pavia, who was horribly wounded, but it was an exception. Gonzales Brabo deserted her in a panic. She went into exile, and her reign ended. The Revolution of 1868 was the first openly and avowedly directed against the dynasty. It became a familiar saying that the "spurious race of Bourbon" had disappeared for ever, and the country was called upon to make a new and a better government. But the history of the six years from September 1868 to December 1874 proved that the political incapacity of the Spaniards had not been cured. There was no definite idea anywhere as to how a substitute was to be found. A Republican party had been formed led by a few professors and coffee-house politicians, with the mob of the towns for its support, and having as its mouthpiece Don Emilio Castelar, an honest man of incredible fluency. The mass of the Spaniards, however, were not prepared for a republic. Besides them were the various monarchical parties: the *Alfonsistas*, who wished for the restoration of the queen's son with a regency, the partisans of the widower king consort of Portugal; those of the duke of Montpensier; the Carlists; and a few purely fantastic dreamers who would have given the crown to the aged Espartero. The real power was in the hands of the military politicians, Francisco Serrano (*q.v.*) and Juan Prim (*q.v.*), who kept order by means of the army. A constituent Cortes was assembled in 1869, and decided in favour of a monarchy. Serrano was declared regent until a king could be found, and it proved no easy task to find one. Ferdinand of Portugal declined. Montpensier was supposed to be unwelcome to Napoleon, and was opposed by Prim, who had also committed himself to the prophecy that the Bourbons would never return to Spain. Attempts to find a candidate in the Italian family failed at first. So did the first steps taken to find a king in the house of Hohenzollern-Sigmaringen. When the desired ruler was again sought in this family in 1870, the acceptance of the offer by Prince Leopold proved the immediate cause of the Franco-German War, in which Spain had a narrow escape of being entangled. At last, in August of 1870, Prince Amadeo of Savoy, second son of Victor Emmanuel II., consented to become candidate. He was elected on the 3rd of November. On the 27th of December 1870, on the very day on which the new king reached Carthage, Prim was murdered by assassins who were never discovered.

The nominal reign of Amadeo lasted till February 1873. It was a scandalous episode. The Italian prince had put himself into a thoroughly false position, in which the nearest approach to friends he could find were intriguing politicians who sought to use him as a tool, and where every man of honest principles, royalist or republican, looked upon him as an intruder. The Carlists began to collect in the mountains. Republican agitations went on in the towns. At last a dispute in regard to the officering of the artillery gave the king an honourable excuse for resigning a throne on which both he and his wife had been treated with the utmost insolence.

The Republicans entered the place he left vacant simply because there was nobody to oppose them. Until January of the following year the country was given up to anarchy. The Republicans had undertaken to abolish the conscription, and many of the soldiers, taking them at their word, disbanded. The Carlists increased rapidly in numbers, and were joined by many Royalists, who looked upon them as the last resource. Bands of ruffians calling themselves "volunteers of liberty" were found to defend the Republic, and to terrorize society. A new Cortes was collected and proved a mere collection of hysterical ranters. Three presidents succeeded one another within a year, Pi y Margall, Salmeron and Castelar. Ministries changed every few days. As the Republic was to be federal when finally organized many parts of Spain proceeded to act independently. One party went beyond federalism and proposed to split Spain into cantons. The Cantonalists, who were largely galley slaves and deserters, seized the important harbour of Carthage and the ships in it. The ships were taken out of their hands by the British and German squadrons. The spectacle of anarchy, and the stoppage in payment of taxes frightened the Republican deputies into some approach to sanity. Salmeron allowed General Pavia to restore order in Andalusia. When he gave place to Castelar, the eloquent Republican deputy, who was left unchecked by the recess, threw all his most eagerly avowed principles to the wind, raised a great conscription, and provided the means of reducing Carthage and pushing the war against the Carlists with vigour. When the Cortes met again in January 1874, the extreme parties voted against Castelar on the 3rd of the month. Hereupon General Pavia, the governor of Madrid, turned the Cortes into the streets, to the relief of all sane men in the country. Serrano was appointed as head of the executive, and was mainly employed during the year in efforts to save Bilbao from falling into the hands of the Carlists. It had now become clear that the restoration of the Bourbons in the person of Don Alphonso, Isabella's son, was the only way of securing a final settlement. His civilian agents would have preferred to see him brought in by a Cortes. But on the 29th of December 1874 General Martinez Campos caused him to be proclaimed king at Murviedro by a brigade of troops, and the example there set was followed everywhere. Don Alphonso XII. landed in Barcelona on the 10th of January 1875.

The Restored Monarchy, 1874-1900.—The first act of Alphonso was a royal decree confirming the appointment of Canovas del Castillo as prime minister. A strong Conservative administration was formed, to which Canovas admitted some men of the old parties of Queen Isabella's reign side by side with men who had played a part in the Revolution before they became his active auxiliaries in the Alfonsist propaganda in 1872 and 1873. This cabinet gave its chief attention for fifteen months to the pacification of the Peninsula, adopting a Conservative and Catholic policy which contributed quite as much as the great display of military resources to make the Pretender lose adherents and prestige from the moment that his cousin reached Madrid. The Church, the nobility and the middle classes soon pronounced for the new state of things. The Alfonsist armies, led by Marshals Campos and Jovellar, swept the Carlist bands from the right bank of the Ebro to the Pyrenees, and took their last strongholds in the eastern provinces, Cantavieja and Seo de Urgel. Not a few of the Carlist leaders accepted bribes to go abroad, and others put their swords at the disposal of the government for employment against the Cuban rebels. Then all the forces of King Alphonso under Marshal Quesada gradually closed round the remainder

truder. The Carlists began to collect in the mountains. Republican agitations went on in the towns. At last a dispute in regard to the officering of the artillery gave the king an honourable excuse for resigning a throne on which both he and his wife had been treated with the utmost insolence.

The Republicans entered the place he left vacant simply because there was nobody to oppose them. Until January of the following year the country was given up to anarchy. The Republicans had undertaken to abolish the conscription, and many of the soldiers, taking them at their word, disbanded. The Carlists increased rapidly in numbers, and were joined by many Royalists, who looked upon them as the last resource. Bands of ruffians calling themselves "volunteers of liberty" were found to defend the Republic, and to terrorize society. A new Cortes was collected and proved a mere collection of hysterical ranters. Three presidents succeeded one another within a year, Pi y Margall, Salmeron and Castelar. Ministries changed every few days. As the Republic was to be federal when finally organized many parts of Spain proceeded to act independently. One party went beyond federalism and proposed to split Spain into cantons. The Cantonalists, who were largely galley slaves and deserters, seized the important harbour of Carthage and the ships in it. The ships were taken out of their hands by the British and German squadrons. The spectacle of anarchy, and the stoppage in payment of taxes frightened the Republican deputies into some approach to sanity. Salmeron allowed General Pavia to restore order in Andalusia. When he gave place to Castelar, the eloquent Republican deputy, who was left unchecked by the recess, threw all his most eagerly avowed principles to the wind, raised a great conscription, and provided the means of reducing Carthage and pushing the war against the Carlists with vigour. When the Cortes met again in January 1874, the extreme parties voted against Castelar on the 3rd of the month. Hereupon General Pavia, the governor of Madrid, turned the Cortes into the streets, to the relief of all sane men in the country. Serrano was appointed as head of the executive, and was mainly employed during the year in efforts to save Bilbao from falling into the hands of the Carlists. It had now become clear that the restoration of the Bourbons in the person of Don Alphonso, Isabella's son, was the only way of securing a final settlement. His civilian agents would have preferred to see him brought in by a Cortes. But on the 29th of December 1874 General Martinez Campos caused him to be proclaimed king at Murviedro by a brigade of troops, and the example there set was followed everywhere. Don Alphonso XII. landed in Barcelona on the 10th of January 1875.

The Restored Monarchy, 1874-1900.—The first act of Alphonso was a royal decree confirming the appointment of Canovas del Castillo as prime minister. A strong Conservative administration was formed, to which Canovas admitted some men of the old parties of Queen Isabella's reign side by side with men who had played a part in the Revolution before they became his active auxiliaries in the Alfonsist propaganda in 1872 and 1873. This cabinet gave its chief attention for fifteen months to the pacification of the Peninsula, adopting a Conservative and Catholic policy which contributed quite as much as the great display of military resources to make the Pretender lose adherents and prestige from the moment that his cousin reached Madrid. The Church, the nobility and the middle classes soon pronounced for the new state of things. The Alfonsist armies, led by Marshals Campos and Jovellar, swept the Carlist bands from the right bank of the Ebro to the Pyrenees, and took their last strongholds in the eastern provinces, Cantavieja and Seo de Urgel. Not a few of the Carlist leaders accepted bribes to go abroad, and others put their swords at the disposal of the government for employment against the Cuban rebels. Then all the forces of King Alphonso under Marshal Quesada gradually closed round the remainder

Resignation of Amadeo.

Republican interlude.

Castelar's Presidency.

Alphonso XII. King, 1874.

of the Carlist army in Navarre and in the Basque Provinces at the beginning of 1876. The young king himself was present at the close of the campaign, which sent his rival a fugitive across the French frontier, with the few thousand followers who had clung to his cause to the very end.

Directly the Carlist War was over, the government used part of the large army at its disposal to reinforce the troops which *The Cuban Insurrection.* Marshal Jovellar was sent out to Havana as governor-general, with Marshal Martinez Campos as commander-in-chief of the forces. In about eighteen months they managed to drive the rebels into the eastern districts of the island, Puerto Principe and Santiago de Cuba, and induced all but a few irreconcilable chiefs to accept a convention that became famous under the name of the peace treaty of Zanjón. Marshal Campos, who very soon succeeded Jovellar as governor-general of Cuba, for the first time held out to the loyalists of the island the prospect of reforms, fairer treatment at the hands of the mother country, a more liberal tariff to promote their trade, and self-government as the crowning stage of the new policy. He also agreed to respect the freedom of the maroons who had fled from their masters to join the Cubans during the ten years' war, and this led to Spain's very soon granting gradual emancipation to the remainder of the slaves who had stood by their owners. Marshal Campos was not allowed to carry out his liberal and conciliatory policy, which the reactionary party in the colony, *el partido español*, resented as much as their allies in the Peninsula.

Though much of his time and energies had been devoted to the re-establishment of peace at home and in the colonies from 1875 to 1880, Señor Canovas had displayed *Internal Changes.* considerable activity and resolution in the re-organization of the monarchy. Until he felt sure of the early termination of the struggle with the pretender, he ruled in a dictatorial manner without the assistance of parliament. Royal decrees simply set aside most of the legislation and reforms of the Spanish Revolution. Universal suffrage alone was respected for a while and used as the means to call into existence the first Cortes of the Restoration in 1876. The electors proved, as usual, so docile, and they were so well handled by the authorities, that Canovas obtained a parliament with great majorities in both houses which voted a limited franchise to take the place of universal suffrage. Immediately afterwards they voted the constitution of 1876, which was virtually a sort of compromise between the constitution of 1845 in the reign of Isabella and the principles of the democratic constitution of the Revolution in 1869. For instance, liberty of conscience, established for the first time in 1869, was reduced to a minimum of toleration for Protestant worship, schools and cemeteries, but with a strict prohibition of propaganda and outward signs of faith. Trial by jury was abolished, on the plea that it had not worked properly. Liberty of associations and all public meetings and demonstrations were kept within narrow limits and under very close surveillance of the authorities. The municipal and provincial councils were kept in leash by intricate laws and regulations, much resembling those of France under the Second Empire. The political as well as the administrative life of the country was absolutely in the hands of the wire-pullers in Madrid; and their local agents, the governors, the mayors and the electoral potentates styled *los Caciques*, were all creatures of the minister of the interior at the head of Castilian centralization. The constitution of 1876 had created a new senate, of which half the members were either nominees of the Crown or sat by right of office or birth, and the other half were elected by the provinces of the Peninsula and the colonies, the clergy, the universities and the learned societies and academies. The House of Deputies, composed of 456 members, was elected by the limited franchise system in Spain and by an even more restricted franchise in the colonies, five-sixths of the colonists being deprived of representation. From the beginning of the Restoration the great statesman, who was nicknamed at the

time the Richelieu of Alphonso XII.'s reign, established a system of government which lasted for a quarter of a century. He encouraged the men of the Revolution who wanted to bow to accomplished facts and make the best of the restricted amount of liberty remaining, to start afresh in national politics as a Dynastic Liberal party. From the moment that such former revolutionists as Sagasta, Ulloa, Leon y Castillo, Camacho, Alonzo Martinez and the marquis de la Vega de Armijo declared that they adhered to the Restoration, Canovas did not object to their saying in the same breath that they would enter the Cortes to defend as much as possible what they had achieved during the Revolution, and to protest and agitate, legally and pacifically, until they succeeded in re-establishing some day all that the first cabinet of Alphonso XII. had altered in the Constitution of 1869. The premier not only approved Sagasta's efforts to gather round him as many Liberals and Democrats as possible, but did not even oppose the return of Emilio Castelar and a few Republicans. He also countenanced the presence in the Cortes for the first time of 15 senators and 42 deputies to represent Cuba and Porto Rico, including a couple of home rulers. Thus Canovas meant to keep up the appearance of a constitutional and parliamentary government with what most Spaniards considered a fair proportional representation of existing parties, except the Carlists and the most advanced Republicans, who only crept into the House of Deputies in some later parliaments. Canovas ruled his own coalition of Conservatives and Catholics with an iron hand, managing the affairs of Spain for six years with only two short interruptions, when he stood aside for a few months, just long enough to convince the king that the Conservative party could not retain its cohesion, even under such men as Marshals Jovellar and Campos, if he did not choose to support them.

In the early years of the Restoration the king and Canovas acted in concert in two most delicate matters. Alphonso XII. agreed with his chief counsellor as to the expediency of keeping military men away from active politics. Canovas boldly declared in the Cortes that the era of military *pronunciamientos* had been for ever closed by the Restoration, and the king reminded the generals more than once that he intended to be the head of the army. The king and his prime minister were equally agreed about the necessity of showing the Vatican and the Church sufficient favour to induce them to cease coquetting with the pretender Don Carlos, but not so much as to allow the pope and the clergy to expect that they would tolerate any excessive Ultramontane influence in the policy of the Restoration. In regard to foreign policy, the king and Canovas both inclined to assist national aspirations in Morocco, and jealously watched the relations of that empire with other European powers. This desire to exercise a preponderant influence in the affairs of Morocco culminated in the Madrid conference of 1880. Preponderant influence was not attained, but the conference led to a treaty which regulated the consular protection extended to the subjects of Morocco.

In 1878, in spite of the well-known hostility of his mother to the Montpensiers, and in spite of his ministers' preferences for an Austrian match, King Alphonso insisted *Marriage of* upon marrying the third daughter of the duke of Alphonso Montpensier, Doña Mercedes, who only survived *XII.* her marriage five months. Barely seventeen months after the death of his first wife, the king listened to the advice of Canovas and married, in November 1879, the Austrian archduchess Maria Christina of Habsburg. In general matters the king allowed his ministers much liberty of action. From 1875 to 1881, when not too much engrossed in more pressing affairs, his governments turned their attention to the re-organization of the finances, the resumption of payment of part of the debt coupon, and the consolidation of the colonial and imperial floating debts. They swerved from the mild free trade policy which was inaugurated by Señor Figuerola and by Prim at the beginning of the Revolution, and to which was due the remarkable progress of the foreign trade. This

went on almost continuously as long as the régime of moderate tariffs and commercial treatises lasted, *i.e.* until 1890.

In 1881 the Dynastic Liberals began to show impatience at being kept too long in the cold shade of opposition. Their chief, Sagasta, had found allies in several Conservative and Liberal generals—Campos, Jovellar, Lopez-Dominguez and Serrano—who had taken offence at the idea that Canovas wanted to monopolize power for civil politicians. These allies were said to be the dynastic and monarchical ballast, and in some sort the dynastic guarantees of liberalism in the eyes of the court. Canovas came to the conclusion that it was expedient for the Restoration to give a fair trial to the quondam revolutionists who coalesced under Sagasta in such conditions. He arranged with the king to moot a series of financial projects the acceptance of which by His Majesty would have implied a long tenure of office for the Conservatives, and so Alphonso XII. found a pretext to dissent from the views of his premier, who resigned on the spot, recommending the king to send for Sagasta. The Liberal administration which that statesman formed lasted two years and some months. The policy of Sagasta in domestic affairs resembled that of Canovas. The Liberals had to act cautiously and slowly, because they perceived that any premature move towards reform or democratic legislation would not be welcome at court, and might displease the generals. Sagasta and his colleagues therefore devoted their attention chiefly to the material interests of the country. They made several treaties of commerce with European and Spanish-American governments. They reformed the tariff in harmony with the treaties, and with a view to the reduction of the import duties by quinquennial stages to a fiscal maximum of 15% *ad valorem*. They undertook to carry out a general conversion of the consolidated external and internal debts by a considerable reduction of capital and interest, to which the bondholders assented. They consolidated the floating debt proper in the shape of a 4% stock redeemable in 40 years, of which £70,000,000 was issued in 1882 by Señor Camacho, the greatest Spanish financier of the century. Sagasta was not so fortunate in his dealings with the anti-dynastic parties, and the Republicans gave him much trouble in August 1883. The most irreconcilable Republicans knew that they could not expect much from popular risings in great towns or from the disaffected and anarchist peasantry in Andalusia, so they resorted to the old practice of barrack conspiracies, courting especially the non-commissioned officers and some ambitious subalterns. The chief of the exiles, Don Manuel Ruiz Zorilla, who had retired to Paris since the Restoration, organized a military conspiracy, which was sprung upon the Madrid government at Badajoz, at Seo de Urgel, and at Santo Domingo in the Ebro valley. This revolutionary outbreak was swiftly and severely repressed. It served, however, to weaken the prestige of Sagasta's administration just when a Dynastic Left was being formed by some discontented Liberals, headed by Marshal Serrano and his nephew, General Lopez-Dominguez. They were joined by many Democrats and Radicals, who seized this opportunity to break off all relations with Ruiz Zorilla and to adhere to the monarchy. After a while Sagasta resigned in order to let the king show the Dynastic Left that he had no objection to their attempting a mildly democratic policy, on condition that the Cortes should not be dissolved and that Sagasta and his Liberal majorities in both houses should grant their support to the cabinet presided over by Señor Posada Herrera, a former Conservative, of which the principal members were General Lopez-Dominguez and Señores Moret, Montero Rios and Becerra. The support of Sagasta did not last long, and he managed with skill to elbow the Dynastic Left out of office, and to convince all dissentients and free lances that there was neither room nor prospect for third parties in the state between the two great coalitions of Liberals and Conservatives under Sagasta and Canovas. When Posada Herrera resigned, the Liberals and Sagasta did not seem much displeased at the advent to power of Canovas in 1884, and soon

almost all the members of the Dynastic Left joined the Liberal party.

From 1881 to 1883, under the two Liberal administrations of Sagasta and Posada Herrera, the foreign policy of Spain was much like that of Canovas, who likewise had had to bow to the king's very evident inclination for closer relations with Germany, Austria and Italy than with any other European powers. Alphonso XII. found a very willing minister for foreign affairs in the person of the marquis de la Vega de Armijo, who cordially detested France and cared as little for Great Britain. The Red-books revealed very plainly the aims of the king and his minister. Spanish diplomacy endeavoured to obtain the patronage of Italy and Germany with a view to secure the admission of Spain into the European concert, and into international conferences whenever Mediterranean and North African questions should be mooted. It prepared the way for raising the rank of the representatives of Spain in Berlin, Vienna, Rome, St Petersburg and London to that of ambassadors. In Paris the country had been represented by ambassadors since 1760. The Madrid foreign office welcomed most readily a clever move of Prince Bismarck's to estrange Spain from France and to flatter the young king of Spain. Alphonso XII. was induced to pay a visit to the old emperor William in Germany, and during his stay there, in September 1883, he was made honorary colonel of a Uhlan regiment quartered at Strassburg. The French people resented the act, and the Madrid government was sorely embarrassed, as the king had announced his intention of visiting Paris on his way back from Germany. Nothing daunted by the ominous attacks of the French people and press, King Alphonso went to Paris. He behaved with much coolness and self-possession when he was met in the streets by a noisy and disgraceful demonstration. The president of the Republic and his ministers had to call in person on their guest to tender an apology, which was coldly received by Alphonso and his minister for foreign affairs. After the king's return, the German emperor sent his son the crown prince Frederick, with a brilliant suite, to the Spanish capital, where they were the guests of the king for several days. Until the end of his reign Alphonso XII. kept up his friendly relations with the German Imperial family and with the German government.

The close of the reign of Alphonso XII. was marked by much trouble in domestic politics, and by some great national calamities and foreign complications, while the declining health of the monarch himself cast a gloom over the court and governing classes. The last Conservative cabinet of this reign was neither popular nor successful. When the cholera appeared in France, quarantine was so rigorously enforced in the Peninsula that the external trade and railway traffic were grievously affected. On Christmas night, 1884, an earthquake caused much damage and loss of life in the provinces of Granada and Malaga. Many villages in the mountains which separate those provinces were nearly destroyed. At Alhama, in Granada, more than 1000 persons were killed and injured, several churches and convents destroyed, and 300 houses laid in ruins. King Alphonso went down to visit the district, and distributed relief to the distressed inhabitants, despite his visibly failing health. He held on gallantly through the greater part of 1885 under great difficulties. In the Cortes the tension in the relations between the government and the opposition was growing daily more serious. Outside, the Republicans and Carlists were getting troublesome, and the tone of their press vied with that of the Liberals in their attacks on the Conservative cabinet. Then, to make matters worse, an outbreak of cholera occurred in the eastern provinces of the kingdom. The epidemic spread rapidly over the Peninsula, causing great havoc in important cities like Granada, Saragossa and Valencia. The authorities confessed that 105,000 persons died of cholera in the summer and autumn of 1885, being on an average from 41 to 56% of those attacked.

In September a conflict arose between Spain and Germany which had an adverse effect upon his health. Prince Bismarck

Foreign Policy.

looked upon the rights of Spain over the Caroline Islands in the Pacific as so shadowy that he sent some German war-ships to take possession of a port in the largest island of the group. The action of Germany caused great indignation in Spain, which led, in Madrid, to imposing demonstrations. The government got alarmed when the mob one night attacked the German embassy, tore the arms of the empire from the door of the consulate, and dragged the escutcheon to the Puerto del Sol, where it was burnt amid much uproar. The troops had to be called out to restore order. Alphonso alone remained cool, and would not listen to those who clamoured for a rupture with Germany. He elected to trust to diplomacy; and Spain made out such a good case for arbitration, on the ground of her ancient rights of discovery and early colonization, that the German emperor, who had no desire to imperil the dynasty and monarchy in Spain, agreed to submit the whole affair to the pope, who gave judgment in favour of Spain.

After his return to Madrid the king showed himself in public less than usual, but it was clear to all who came in contact with him that he was dying. Nevertheless, in **Death of Alphonso XII.** Madrid, Canovas would not allow the press to say a word. Indeed, in the ten months before the death of Alphonso XII. the Conservative cabinet displayed unprecedented rigour against the newspapers of every shade. The Dynastic, Liberal and Independent press, the illustrated papers and the satirical weeklies fared no better than the Republicans, Socialists and Carlists, and in 60 days 1260 prosecutions were ordered against Madrid and provincial papers. At last, on the 24th of November 1885, the truth had to be admitted and on the morning of the 25th the end came.

It was no wonder that the death of a king who had shown so much capacity for rule, so much unselfish energy and courage, **Regency of Queen Christina.** and so many amiable personal qualities, should have made Spaniards and foreigners extremely anxious about the prospects of the monarchy. Alphonso XII. left no male issue. He had two daughters, the princess of the Asturias, born in 1880, and the Infanta Maria Theresa, born in 1882. At the time of his death it had not been officially intimated that the queen was *enceinte*. The *Official Gazette* did not announce that fact until three months after the demise of the sovereign. On the 17th of May 1886, six months after the death of Alphonso XII., his posthumous son, Alphonso XIII., was born at the palace of Madrid. Six months before this event definitely settled the question of the succession to the throne, the royal family and its councillors assembled to take very important decisions. There could be no doubt that under the constitution of 1876 the widowed queen was entitled to the regency. Doña Maria Christina calmly presided over this solemn council, listening to the advice of Marshal Campos, always consulted in every great crisis; of Captain-General Pavia, who answered for the loyalty of the capital and of its garrison; of the duke de Sexto, the chief of the household; of Marshal Blanco, the chief of the military household; and of all the members of the cabinet and the presidents of the Senate and Congress assembled in the presence of the queen, the ex-queen Isabella, and the Infanta Isabella. All looked chiefly to Marshal Campos and Canovas del Castillo for statesmanlike and disinterested advice. The question was whether it would be expedient to continue the policy of the late king and of his last cabinet. Canovas assured the queen-regent that he was ready to undertake the task of protecting the new state of things if it was thought wise to continue the Conservative policy of the late king, but in the circumstances created by his death, he must frankly say that he considered it advisable to send for Señor Sagasta and ask him to take the reins of government, with a view to inaugurate the regency under progressive and conciliatory policy.

Sagasta was summoned to El Pardo, and the result of his interview with the queen-regent, Canovas and the generals, was the understanding ever afterwards known as the pact of El Pardo, the corner-stone of the whole policy of the regency, and of the

two great statesmen who so long led the great dynastic parties and the governments of Doña Christina. It was agreed that during the first years of the regency, Canovas and Sagasta would assist each other in defending the institutions and the dynasty. Sagasta made no secret of the fact that it was his intention to alter the laws and the constitution of the monarchy so as to make them very much resemble the constitution of the Revolution of 1868, but he undertook to carry out his reform policy by stages, and without making too many concessions to radicalism and democracy, so that Canovas and his Conservative and Catholic followers might bow to the necessities of modern times after a respectable show of criticism and resistance. The generals assured the queen-regent and the leaders of the dynastic parties that the army might be counted upon to stand by any government which was sincerely determined to uphold the Restoration against Republicans and Carlists. Sagasta left the palace to form the first of several cabinets over which he presided continuously for five years. He took for colleagues some of the strongest and most popular statesmen of the Liberal party, virtually representing the three important groups of men of the Revolution united under his leadership—veteran Liberals like Camacho and Venancio Gonzalez; Moderates like Alonzo Martinez, Gamazo and Marshal Jovellar; and Democrats like Moret, Montero Rios and Admiral Beranger. The new cabinet convoked the Cortes elected under the administration of Canovas in 1884, and the Conservative majorities of both houses, at the request of Canovas, behaved very loyally, voting supplies and other bills necessary to enable the government to be carried on until another parliament could be elected in the following year, 1886.

Pending the dissolution and general election, Sagasta and his colleagues paid most attention to public peace and foreign affairs. A sharp look-out was kept on the doings of the Republicans, whose arch-agitator, Ruiz Zorilla, in Paris displayed unusual activity in his **Republican and Carlist Intrigues.** endeavours to persuade the Federals, the Intransigents, and even the Opportunists of Democracy that the times were ripe for a venture. Ruiz Zorilla found no response from the Republican masses, who looked to Pi y Margall for their watchword, nor from the Republican middle classes, who shared the views of Salmeron, Azcarate and Pedregal as to the inexpediency of revolutionary methods. Castelar, too, raised his eloquent protest against popular risings and barrack conspiracies. The Carlists showed equal activity in propaganda and intrigues. Sagasta derived much benefit from the divisions which made democracy powerless; and he was able to cope with Carlism chiefly because the efforts of the pretender himself abroad, and of his partisans in Spain, were first restrained and then decisively paralysed by the influence of foreign courts and governments, above all by the direct interference of the Vatican in favour of the Spanish regency and of the successor of Alphonso XII. The young and most impatient adherents of Carlism vainly pleaded that such an opportunity would not soon be found again, and threatened to take the law into their own hands and unfurl the flag of *Dios, Patria, y Rey* in northern and central Spain. Don Carlos once more showed his well-known lack of decision and dash, and the Carlist scare passed away. Pope Leo XIII. went even further in his patronage, for he consented to be the godfather of the posthumous son of Alphonso XII., and he never afterwards wavered in the steady sympathy he showed to Alphonso XIII. He was too well acquainted with the domestic politics of the Peninsula to suppose that Carlism could ever do more than disturb for a while the tranquillity of Spain. He did not wish to stake the interests of the Church on a cause which could only revive against her the old animosities of Spanish liberalism and democracy, so roughly displayed in the years 1836 and 1868. Doña Christina, apart from the dictates of gratitude towards the head of her Church for the kindness shown to her son and government, was a zealous Catholic. She proved all through her regency that she not only relied upon the support of the Vatican and of the prelates, but that she was determined to favour the Church

and the religious foundations in every possible way. Her purse was always open to assist convents, monasteries, and religious works and societies of all kinds, as long as they were under the management of the Church. She became regent when Spain had felt the consequences of the expulsion of the Jesuits and other religious orders from France after the famous Jules Ferry laws, which aimed at placing these orders more under state control, to which they declined to submit. They selected Spain as an excellent field of enterprise; and it must be said that all the governments of the regency showed so much indulgence towards the Catholic revival thus started, that in less than a decade the kingdom was studded with more convents, monasteries, Jesuit colleges, Catholic schools, and foundations than had existed in the palmy days of the houses of Austria and Bourbon in the 17th and 18th centuries. A wave of Clericalism and ultra-Catholic influences swept over the land, affecting the middle classes, the universities and learned societies, and making itself very perceptible also among the governing classes and both dynastic parties, Liberals and Conservatives.

Next in importance to papal protection was the favourable attitude of all the European governments towards the *Europe and the Regency.* queen-regent and, later, towards her son. The court and government of Germany vied with the Austrian and Italian royal families and governments in showing sympathy to the widow of Alphonso XII. Republican France and the tsar made as cordial demonstrations as Queen Victoria and her government, and Switzerland, Belgium, Holland and others followed suit. The Spanish foreign office received every assurance that friendly governments would watch the Carlists and Republicans, to prevent them from using their territories as a basis for conspiracies against the peace of Spain. The statesmen of both dynastic parties, from the beginning of the regency, agreed to observe strict neutrality in European affairs, in order to avoid complications fraught with evil consequences for the monarchy and the dynasty in the unsettled state of the country. This neutrality was maintained until the close of the 19th century.

Sagasta conducted the first general election in 1886 much after the usual precedents. The Long Parliament of the regency was composed of considerable Liberal majorities in both houses, though Sagasta had allowed a larger share than Canovas was wont to do to the minorities, so much so that on the opposition benches the Republicans of various shades were represented by their most eminent leaders, the Carlists had a respectable group, and the Conservatives a strong muster, flanked by a group of dissentients. The first Cortes of the regency in five sessions did really good and substantial work. A civil code was carefully drawn up by Señor Alonzo Martinez, in order to consolidate the very heterogeneous ancient legislation of the monarchy and the local laws of many provinces, especially Catalonia, Aragon, Valencia, Navarre, and the Basque territory. Trial by jury was re-established for most crimes and offences. The laws regulating the rights of association and public meeting, the liberty of the press, and other rights of the subject were reformed on liberal and more tolerant lines. Finance and trade received attention. Some commercial treaties and agreements were made, including one with Great Britain, which proved highly beneficial to home trade, and the tariff was altered, in spite of much resistance on the part of the Protectionists. In his progressive policy Sagasta was actively and usefully supported by the chief of the moderate Republicans, Emilio Castelar, who recommended his partisans to vote with the Liberal party, because he confessed that bitter experience had taught him that liberties and rights were better attained and made stable by pacific evolution than by revolution. He laid most stress upon this axiom when, in September 1886, Ruiz Zorrilla suddenly sprang upon Sagasta a military and revolutionary movement in the streets and barracks of Madrid. The military authorities acted with promptitude, the rebels being pursued, dispersed and arrested. General Marina and several other officers were condemned to death by court martial; but Queen Christina

commuted the sentence into penal servitude, and the ministers of war and marine retired from the cabinet in consequence. Very shortly afterwards, another war minister, General Castillo, attempted to strike at the root of military insubordination, and simultaneously in every garrison of the kingdom the senior sergeants, more than 1000 in all, were given their discharge and ordered to start for their homes on the spot. The lesson produced a good result, as no trace of revolutionary work revealed itself among the non-commissioned officers after 1886. As time wore on, Sagasta found it difficult to maintain discipline in the ranks of the Liberal party. He was obliged to reconstruct the cabinet several times in order to get rid of troublesome colleagues like General Cassola, who wanted to make himself a sort of military dictator, and Camacho, whose financial reforms and taxation schemes made him unpopular. He had more often to reorganize the government in order to find seats in the cabinet for ambitious and impatient worthies of the Liberal party—not always with success, as Señor Martos, president of the Congress, and the Democrats almost brought about a political crisis in 1889. Sagasta cleverly affected to resign and stand aside, so that Señor Alonzo Martinez might vainly attempt to form an intermediary cabinet. Canova's, who was consulted by the queen when Alonzo Martinez failed, faithfully carried out the pact of El Pardo and advised Her Majesty to send for Sagasta again, as he alone could carry out what remained to be done of the Liberal programme. Sagasta reconstructed his ministry for the last time, and announced his intention to make the re-establishment of universal suffrage the crowning act of the Liberal policy, knowing very well that he would thus rally round him all the Liberals, Democrats and Republicans in the last session of the Long Parliament. The Suffrage Bill was carried through the Senate and Congress in the spring of 1890 after protracted debates, in which the Conservatives and many military politicians who had previously been regarded as the allies of Sagasta did their best to obstruct the measure. Marshals Campos, Jovellar and Novaliches, and Generals Pavia, Primo de Rivera, Daban and others, were angry with Sagasta and the Liberals not only because they deemed their policy too democratic, but because they ventured to curb the insubordinate attitude of general officers, who shielded themselves behind the immunities of their senatorial position to write insolent letters to the war minister on purely professional questions. Spanish generals of *pronunciamiento* fame thought it perfectly logical and natural that sergeants and subalterns should be shot or sent to penal servitude for acts of indiscipline, but if an insubordinate general was sent to a fortress under arrest for two months they publicly demonstrated their sympathy with the offender, made angry speeches against their hierarchical chief, the war minister, in the Senate, and dared to call upon the queen-regent to make representations, which unfortunately were listened to, according to the worst precedents of the Spanish monarchy. The increasing violence of the Conservative press and opposition, the divisions developing in the ranks of liberalism, and the restlessness of the agricultural protectionists led by Señor Gamazo, did not weigh so much in the balance at court against Sagasta as the aggressive attitude of the military politicians. Sagasta held on as long as was necessary to secure the promulgation of the universal suffrage law, but he noticed that the queen-regent, when he waited upon her for the despatch of public business, showed almost daily more impatience for a change of policy, until at last, in July 1890, she peremptorily told him that she considered the time had come for calling the Conservatives and their military patrons to her councils. Sagasta loyally furnished the queen with a constitutional pretext for carrying out her desire, and tendered the resignation of the whole cabinet, so that Her Majesty might consult, as usual, the party leaders and generals on the grave question of the expediency of entrusting to new ministers or to the Liberals the mission of testing the new electoral system. Queen Christina on this occasion acted exactly as she henceforth did in all ministerial crises. She slowly consulted the magnates of all parties with apparent impartiality, and finally adopted the course

which it was an open secret she had decided upon *in pectore* beforehand.

Canovas gathered round him most of the prominent Conservative and Catholic statesmen. The first step of the new cabinet was calculated to satisfy the protectionist aspirations of **A Protectionist Régime.** which had spread in the kingdom about the same time that most Continental countries were remodeling and raising their tariffs. The Madrid government used an authorization which Sagasta had allowed his Long Parliament to vote, to please Señor Gamazo and the Liberal representatives of agricultural interests, empowering the government to revise and increase all tariff duties not covered by the then existing treaties of commerce. This was the case with most of the products of agriculture and with live stock, so Canovas and his finance minister made, by royal decree, an enormous increase in the duties on these classes of imports, and particularly on breadstuffs. Then, in 1891, they denounced all the treaties of commerce which contained clauses stipulating most-favoured-nation treatment, and they prepared and put in force in February 1892 a protectionist tariff which completely reversed the moderate free-trade policy which had been so beneficial to the foreign commerce of Spain from 1868 to 1892. Not a few nations retaliated with higher duties upon Spanish exports, and France raised her wine duties to such an extent that the exports of wines to that country dropped from £12,500,000 before 1892 to £2,400,000 in 1893 and the following years. The effects of a protectionist policy verging upon prohibition were soon sharply felt in Spain. Foreign exchanges rose, exports decreased, the railway traffic declined, and the commercial classes and consumers of foreign goods and products were loud in their protests. Industrial interests alone benefited, and imported more raw materials, chemicals, and coal and coke, which naturally influenced the exchanges adversely. Spain only attempted to make new treaties of commerce with Holland, Norway, Sweden, Denmark and Switzerland. The Great Powers contented themselves with securing by agreements the same treatment for their commerce in Spain as that granted by those five treaties. The Protectionists in 1893 wrecked a treaty of commerce with Germany in the Senate; and Spain subsequently persevered in her protectionist policy. During his two and a half years' stay in office Canovas had not so much trouble with the opposition as with the divisions which sprang up in the Conservative ranks, though he fancied that he had managed the general election in 1891 so as to secure the customary docile majorities. The split in the Conservative camp originated in the rivalry between the two principal lieutenants of Canovas, Romero Robledo and Francisco Silvela. The latter and a strong and influential body of Conservatives, chiefly young politicians, dissented from the easy-going views of Romero Robledo and of Canovas on the expediency of reforms to correct the notorious and old-standing abuses and corruption of the municipalities, especially of Madrid. When Canovas found himself deserted on so delicate a matter by a numerous section of his party, he resigned, and advised the queen to send for Sagasta and the Liberals.

Sagasta took office very reluctantly, as he considered a change of policy premature. He conducted the general election with **Difficulty with Morocco.** much regard for the wishes of the opposition, and out of 456 seats in the Lower House allowed them to have more than 170, the Conservatives getting nearly 100 and the Republicans 30. He had to settle some knotty questions, foremost a conflict with Morocco, which was the consequence of the aggression of the unruly Riff tribes upon the Spanish outposts around Melilla. Reinforcements were tardily sent out; and in a second attack by the Arabs the Spanish forces lost heavily, and their commander, General Margallo, was killed. Public opinion was instantly fired, and the press called so loudly for revenge that the government sent to Melilla no less a personage than Marshal Campos, at the head of 20 generals and 25,000 men. The sultan of Morocco lost no time in censuring the behaviour of the Riff tribes, and in promising that he would chastise them. Marshal Campos was sent to

Fez to make a treaty, in which he obtained ample redress and the promise of an indemnity of £800,000, which Morocco punctually paid.

Colonial affairs gave Sagasta much to do. He had given seats in his cabinet to Señor Antonio Maura as colonial secretary and to Señor Gamazo, his brother-in-law, as finance minister. These two moderate Liberals acted in **The Cuban Question.** concert to grapple with colonial questions, which in 1894 had assumed a very serious aspect. Spain had received many ominous warnings. Marshal Campos, on returning from Cuba in 1879, had advocated some concessions to satisfy the legitimate aspirations of the majority of the colonists. In 1886, in the first parliament of the regency, Cuban autonomist deputies divided the house on a motion in favour of home rule and of an extension of the franchise in Cuba. This motion was negated by all the Conservatives, by most of the Dynastic Liberals and by some of the Republicans. The majority of Spaniards were kept by the government and the press quite in the dark about the growth of disaffection in Cuba, so that they were loath to listen to the few men, soldiers and civilians, courageous enough to raise the note of alarm during the ten years before the final catastrophe. For no other reason did the minister for the colonies, Señor Maura, in 1894 fail to convince the Cortes, and even the Liberal party, that his very moderate Cuban Home Rule Bill was an indispensable and wise, though tardy, attempt to avert a conflict which many plain symptoms showed to be imminent in the West Indies. Maura was warmly supported in Congress by the Cuban home rulers and by some far-sighted Liberals and Republicans. Nevertheless, his bill did not find favour with the Conservatives or the majority of the Liberals, and Sagasta, trimming according to his inveterate habit, found a pretext to get rid of Maura and Gamazo. In the place of Maura he found a more pliant minister for the colonies, Señor Abarzuza, who framed a Cuban Reform Bill so much short of what his predecessor had thought an irreducible minimum of concessions, that it was censured in Havana by all the colonial Liberals and home rulers, and by their representatives in Madrid. The latter at the last moment recorded their votes in favour of the Abarzuza Bill when they perceived that a strange sort of eleventh-hour presentiment was about to make all the Spanish parties vote this insufficient reform. Before it could be promulgated, the tidings came of a separatist rising in the old haunts of Creole disaffection near Santiago de Cuba. Sagasta sent about 12,000 men to reinforce the 15,000 soldiers in Cuba under General Callaga, and was preparing more when a characteristically Spanish ministerial crisis arose. The subalterns of the Madrid garrison took offence at some articles published by Radical newspapers, and they attacked the editorial offices. Neither the war minister nor the commanders of the garrison chose to punish the offenders, and sooner than endorse such want of discipline, Sagasta and the Liberal party once more made way for Canovas. A very few days after he assumed office Canovas received information concerning the spread of the rising in Cuba which induced him to send out Marshal Campos with 30,000 men. He allowed Marshal Campos much liberty of action, but dissented from his views on the expediency of allowing him to offer the loyalists of Cuba as much home rule as would not clash with the supremacy of Spain. The prime minister declared that the Cubans must submit first, and then the mother country would be generous.

Before a year had passed, in view of the signal failure of Marshal Campos, the Madrid government decided to send out General Weyler, who had made himself famous in the Philippines and at Barcelona for his stern and cruel procedure against disaffection of every kind. He showed the same merciless spirit in dealing with the Cubans; and he certainly cleared two-thirds of the island of Creole bands, and stamped out disaffection by vigorous military operations and by obliging all the non-**General Weyler's Campaign.** combatants who sympathized with the rebels in arms to elect between joining them in the bush, La Manigua, or residing within the Spanish lines. This system might probably have succeeded if the United States had not

countenanced the sending of supplies of every kind to the rebels, and if American diplomacy had not again and again made representations against Weyler's ruthless policy. Canovas so fully comprehended the necessity of averting American intervention that he listened to the pressing demands of secretary Olney and of the American minister in Madrid, Hannis Taylor, and laid before the Cortes a bill introducing home rule in Cuba on a more liberal scale than Maura, Abarzuza and Sagasta had dared to suggest two years before. Canovas did not live to see his scheme put into practice, as he was assassinated by an anarchist at the baths of Santa Agueda, in the Basque Provinces, on the 9th of August 1897. The queen-regent appointed General Azcarraga, the war minister, as successor to Canovas; and a few weeks later President McKinley sent General Woodford as representative of the United States at the court of Madrid. At the end of September 1897 the American minister placed on record, in a note handed by him at San Sebastian to the minister for foreign affairs, the duke of Tetuan, a strongly-worded protest against the state of things in Cuba, and demanded in substance that a stop should be put to Weyler's proceedings, and some measures taken to pacify the island and prevent the prolongation of disturbances that grievously affected American interests. Less than a fortnight after this note had been delivered, the Conservative cabinet resigned, and the queen-regent asked Sagasta to form a new administration. The Liberal government recalled Weyler, and sent out, as governor-general of Cuba, Marshal Blanco, a conciliatory and prudent officer, who agreed to carry out the home-rule policy which was concerted by Señor Moret and by Sagasta, with a view to obtain the goodwill of the president of the United States. If things had not already gone too far in Cuba, and if public opinion in the United States had not exercised irresistible pressure on both Congress and president, the Moret home-rule project would probably have sufficed to give the Cubans a fair amount of self-government. All through the winter of 1897-1898 the Madrid government took steps to propitiate the president and his government, even offering them a treaty of commerce which would have allowed American commerce to compete on equal terms with Spanish imports in the West Indies and defeat all European competition. But the blowing up of the American cruiser "Maine" in the port of Havana added fuel to the agitation in the United States against Spanish rule in Cuba. When Congress met in Washington the final crisis was hurried on. Spain appealed in vain to European mediation, to the pope, to courts and governments. All, with the exception of Great Britain, showed sympathy for the queen-regent and her government, but none were disposed to go beyond purely platonic representations in Washington.

At last, on the 20th of April 1898, when the Spanish government learned that the United States minister, General Woodford, had been instructed by telegraph to present an ultimatum demanding the cessation of hostilities in Cuba, with a view to prepare for the evacuation of the island by the Spanish forces, Sagasta decided to give General Woodford his passports and to break off official relations with the United States. It was an open secret that this grave decision was not taken at the cabinet council presided over by the queen without a solemn protest by Señor Moret and the ministers of war and marine that the resources of Spain were totally inadequate for a struggle with the United States. These protests were overruled by the majority of the ministers, who invoked dynastic and monarchical considerations in favour of a desperate stand, however hopeless, in defence of the last remnants of the colonial empire of Spain. Reckless as was the course adopted, it was in touch with the feelings of the majority of a nation which had been to the very end deceived by the government and by the press not only in regard to its own resources, but also in regard to those of the United States and of the colonists in arms in Cuba and in the Philippine Islands. The sequel is soon told. The Spanish fleet in the Far East was defeated in Manila Bay by Admiral Dewey. Admiral Cervera's squadron was destroyed outside the Bay of Santiago de Cuba by the American fleet under Admirals Sampson and

Schley. All communication between Spain and her colonies was thus cut off. An American expedition landed near Santiago, and the Spanish garrison surrendered after a fortnight's show of resistance. Very shortly afterwards, at the end of July, Spain sued for peace through the mediation of French diplomacy, which did not obtain much from President McKinley. It was agreed that hostilities should cease on sea and land, but that Spain should evacuate Cuba and Porto Rico pending the negotiations for a peace treaty which were to begin in Paris at the end of September 1898. In the meantime Manila and its garrison had surrendered to the Americans. The agreement of the 9th of August, signed by M. Cambon, the French ambassador in Washington, in the name of Spain, clearly stipulated that her rule in the New World must be considered at an end, and that the fate of the Philippines would be settled at the Paris negotiations. Unfortunately, Spain indulged in the illusion that America would perhaps respect her rights of sovereignty in the Philippine Islands, or pay a considerable sum for their cession and recognize the debts of Cuba and of the Philippines. The American commission, presided over by secretary Day in Paris, absolutely refused to admit the Spanish contention that the United States or the new administration in Cuba and the Philippines should be saddled with several hundred million dollars of debts, contracted by the colonial treasuries, and guaranteed by Spain, almost entirely to maintain Spanish rule against the will of the Cubans and Filipinos. Spain could not help assenting to a treaty by which she renounced unconditionally all her rights of sovereignty over Cuba and Porto Rico and ceded the Philippine and Sulu Islands and the largest of the Marianne Islands in consideration of the payment of four millions sterling by America. Thus ended a struggle which only left Spain the Carolines and a few other islands in the Pacific, which she sold to Germany in 1899 for £800,000, and a couple of islands which were left out in the delimitation made by the Paris peace treaty of the 12th of December 1898, and for which America paid £20,000 in 1900.

The consequences of the war and of the loss of the colonies were very serious for Spanish finance. The national debt, which consisted before the war of £234,866,500 of external *Financial and Political* and internal consols and redeemable debts, and £24,250,000 of home floating debt, was increased *Reorganization* by £46,210,000 of Cuban and Philippine debts, which the Cortes had guaranteed, and by £60,000,000 of debts contracted at a high rate of interest, and with the national guarantee, to meet the expenses of the struggle with the colonies and of the war with the United States. These additional burdens rendered it necessary that taxation and the budget should be thoroughly reorganized. Sagasta and the Liberal party would gladly have undertaken the reorganization of Spain and her finances, but the issue of the war and the unavoidable peace treaty had so evidently damaged their popularity in the country and their credit at court, that the government seized the pretext of an adverse division in the Senate to resign. The Liberals left office after having done all that was morally and materially possible, considering the extremely difficult, indeed inextricable, situation in which they found the country in October 1897. The task of reorganization was confided by the queen-regent to Señor Silvela, who had been universally recognized as the leader of the Conservatives and Catholics after the death of Canovas del Castillo. Silvela endeavoured to unite in what he styled a Modern Conservative party the bulk of the followers of Canovas; the Ultramontanes, who were headed by General Polavieja and Señor Pidal; the Catalan Regionalists, whose leader, Duran y Bas, became a cabinet minister; and his own personal following, of whom the most prominent were the home secretary, Señor Dato, and the talented and energetic finance minister, Señor Villaverde, upon whose shoulders rested the heaviest part of the task of the new cabinet. Silvela lacked the energy and decision which had been the characteristics of Canovas. He behaved constantly like a wary and cautious trimmer, avoiding all extreme measures, shaking off compromising allies like the Ultramontanes and the Regionalists, elbowing out of the cabinet

General Polavieja when he asked for too large credits for the army, taking charge of the ministry of marine to carry out reforms that no admiral would have ventured to make for fear of his own comrades, and at last dispensing with the services of the ablest man in the cabinet, the finance minister, Señor Villaverde, when the sweeping reforms and measures of taxation which he introduced raised a troublesome agitation among the taxpayers of all classes. Villaverde, however, had succeeded in less than eighteen months in giving a decisive and vigorous impulse to the reorganization of the budget, of taxation and of the home and colonial debts. He resolutely reformed all existing taxation, as well as the system of assessment and collection, and before he left office he was able to place on record an increase of close upon three millions sterling in the ordinary sources of revenue. His reorganization of the national debt was very complete; in fact, he exacted even more sacrifices from the bondholders than from other taxpayers. The amortization of the home and colonial debts was suppressed, and the redeemable debts of both classes were converted into 4 % internal consols. The interest on all colonial debts ceased to be paid in gold, and was paid only in pesetas, like the rest of the internal debts, and like the external debt held by Spaniards. Alone, the external debt held by foreigners continued to enjoy exemption from taxation, under the agreement made on the 28th of June 1882 between the Spanish government and the council of foreign bondholders, and its coupons were paid in gold. The Cortes authorized the government to negotiate with the foreign bondholders with a view to cancelling that agreement. This, however, they declined to do, only assenting to a conversion of the 4 % external debt into a 3½ % stock redeemable in sixty-one years.

After parting with Villaverde, Silvela met with many difficulties, and had much trouble in maintaining discipline in the heterogeneous ranks of the Conservative party. He had to proclaim not only such important provinces as Barcelona, Valencia and Bilbao, but even the capital of Spain itself, in order to check a widespread agitation which had assumed formidable proportions under the direction of the chambers of commerce, industry, navigation and agriculture, combined with about 300 middle-class corporations and associations, and supported by the majority of the guilds and syndicates of taxpayers in Madrid and the large towns. The drastic measures taken by the government against the National Union of Taxpayers, and against the newspapers which assisted it in advocating resistance to taxation until sweeping and proper retrenchment had been effected in the national expenditure, checked this campaign in favour of reform and retrenchment for a while. Silvela's position in the country had been much damaged by the very fact of his policy having fallen so much short of what the nation expected in the shape of reform and retrenchment. At the eleventh hour he attempted to retrieve his mistake by vague promises of amendment, chiefly because all the opposition groups, above all Sagasta and the Liberals, announced their intention of adopting much the same programme as the National Union. The attempt was unsuccessful, and on the 6th of March 1901 a Liberal government, under the veteran Sagasta, was once more in office. (A. E. H.)

Parties and Conflicts, 1900-1910.—The loss of nearly all that remained of her colonial empire, though in appearance a crowning disaster, in fact relieved Spain of a perennial source of weakness and trouble, and left her free to set her own house in order. In this the task that faced the government at the outset of the 20th century was sufficiently formidable. Within the country the traditional antagonisms, regional, political, religious, still lived on, tending even to become more pronounced and to be complicated by the introduction of fresh elements of discord. The old separatist tendencies were increased by the widening gulf between the interests of the industrial north and those of the agricultural south. The growing disposition of the *bourgeois* and artisan classes, not in the large towns only, to imitate the "intellectuals" in desiring to live in closer touch with the rest of Europe as regards social, economic, scientific and political progress, embittered the

struggle between the forces of Liberalism and those of Catholicism, powerfully entrenched in the affections of the women and the illiterate masses of the peasantry. To these causes of division were added others from without: the revolutionary forces of Socialism and Anarchism, here, as elsewhere, so far as the masses were concerned, less doctrines and ideals than rallying-cries of a proletariat in revolt against intolerable conditions. Finally, as though to render the task of patriotic Spaniards wellnigh hopeless, there was little evidence of any cessation of that purely factious spirit which in Spanish politics has ever rendered stable party government impossible. A sketch of the political history of a country is necessarily concerned with the externals of politics—the shifting balance of parties, changes of ministries, the elaboration of political programmes; and these have their importance. It must, however, not be forgotten that in a country in which, as in Spain, the constitutional consciousness of the mass of the people is very little developed, all these things reflect only very imperfectly the great underlying forces by which the life of the nation is being moulded and its destiny determined. For a century politics in Spain had been a game, played by professionals, between the "ins" and "outs"; victory or defeat at the polls depended less on any intelligent popular judgment on the questions at issue than on the passing interests of the "wire-pullers" and "bosses" (*Caciques*) who worked the electoral machinery.

Silvela's Conservative cabinet was succeeded in March 1901 by a Liberal government under the veteran Sagasta, who remained in office—save for two short interludes—until the 3rd of December 1902. He was at once faced with two problems, very opposite in their nature, which were destined to play a very conspicuous part in Spanish politics. The first was that presented by the growth of the religious orders and congregations, the second that arising out of the spread of Socialism and industrial unrest. Under the concordat of the 20th of March 1851, by which the relations of Spain and the Vatican are still governed, the law under which since 1836 the religious congregations had been banished from Spain was so far relaxed as to permit the re-establishment of the orders of St Vincent de Paul, St Philip Neri and "one other among those approved by the Holy See," so that throughout the country the bishops "might have at their disposal a sufficient number of ministers and preachers for the purpose of missions in the villages of their dioceses, &c." In practice the phrase "one other" was interpreted by the bishops, not as one for the whole of Spain, but as one in each diocese, and at the request of the bishops congregations of all kinds established themselves in Spain, the number greatly increasing after the loss of the colonies and as a result of the measures of secularization in France.¹ The result was what is usual in such cases. The regular clergy were fashionable and attracted the money of the pious rich, until their wealth stood in scandalous contrast with the poverty of the secular clergy. They also all of them claimed, under the concordat, exemption from taxes; and, since many of them indulged in commercial and industrial pursuits, they competed unfairly with other traders and manufacturers, and tended to depress the labour market. The Law of Associations of the 30th of June 1887 had attempted to modify the evil by compelling all congregations to register their members, and all, except the three already recognized under the concordat, to apply for authorization. This law the congregations, hotbeds of reactionary tendencies, had ignored; and on the 19th of July 1901, the queen-regent issued a decree, countersigned by Sagasta, for enforcing its provisions.

Meanwhile, however, more pressing perils distracted the attention of the government. The industrial unrest, fomented by Socialist agitation, culminated in January 1902 in serious riots at Barcelona and Saragossa, and on the 16th of February in the proclamation of a general strike in the former city. The government sent General Weyler, of Cuban notoriety, to deal with the

¹ See "Church and State in Spain." *The Times*, July 15, 1910.

Spanish
Politics.

Question of
the Religious
Orders.

Conflicting
Tendencies.

Industrial
Unrest and
Socialist
Agitation.

situation; and order was restored. The methods by which this result had been achieved were the subject of violent attacks on the government in the Cortes, and on the 13th of March Sagasta resigned, but only to resume office five days later. He now returned to the question of the religious orders, and on the 9th of April issued a decree proclaiming his intention of enforcing that of the 19th of July 1901. The attitude of the Church was practically one of defiance. The nuncio, indeed, announced that the papacy would be prepared to discuss the question of authorization, but only on condition that all demands for such authorization should be granted. To avoid a crisis at the time when the young king was about to come of age, the government yielded; and on the 10th of May Sagasta announced that a *modus vivendi* with the Vatican had been established.

King Alphonso XIII., whose enthronement took place with all the antique ceremonial on the 17th of May, was himself at the outset under clerical and reactionary influences, and his contemptuous treatment of ministers—who at the ceremonial functions were placed wholly in the background—seemed to argue an intention of ruling personally under the advice of the court *camarilla*.¹ This impression, due doubtless to the king's extreme youth and inexperience, was belied in the event; but it served to discredit the Liberal government still further at the time. Señor Antonio Maura y Montanes, who proved himself later a statesman of exceptional character, seceded to the Conservatives. On the 7th of November Sagasta himself resigned, resumed office temporarily on the 14th, and handed in his final resignation on the 3rd of December. On the 6th of December a Conservative cabinet was formed under Señor Silvela, Señor Villaverde, pledged to a policy of retrenchment, taking the portfolio of finance.

The death of Sagasta, on the 5th of January 1903, temporarily broke up the Liberal party, which could not agree on a leader; its counsels were directed for the time by a committee, consisting of Señors Montero Rios and Moret, the marquis de la Vega de Armijo, Señor Salvador and Count Romanones. The Republicans, under Salmeron, also had their troubles, due to the growing influence of Socialism; and, finally, the Conservatives were distracted by the rivalries between Silvela, Villaverde and Maura. In the country, meanwhile, the unrest continued. At Barcelona the university had to be closed to stop the revolutionary agitation of the students; in April there were serious riots at Salamanca, Barcelona and Madrid. The result of the new elections to the Cortes, declared on the 26th of April, revealed tendencies unfavourable to the government and even to the dynasty; the large towns returned 34 Republicans. A ministerial crisis followed; Maura resigned; and though the elections to the senate resulted in a large Conservative majority, and though in the lower house a vote of confidence was carried by 183 to 81, Silvela himself resigned shortly afterwards. Señor Villaverde was now called upon to form a cabinet. His government, however, accomplished little but the suppression of renewed troubles at Barcelona. His programme included drastic proposals for financial reform, which necessarily precluded an adventurous policy abroad or any additional expenditure on armaments, principles which necessarily brought him into conflict with the military and naval interests. On the 3rd of December Villaverde was forced to resign, his successor being Señor Maura. Meanwhile, on the 24th of November, the Liberal party had been reconstructed, as the Democratic party, under Señor Montero Rios.

Señor Maura, as was to be proved by his second administration, represented the spirit of compromise and of conservative reform. His position now was one of singular difficulty. Though a Catholic, he had to struggle against the clerical *coterie* that surrounded the king, and had not influence enough to prevent the appointment of Monsignor Nozaleda, formerly archbishop of Manila and a prelate of notoriously reactionary views, to the important

¹Ann. Register (1902), p. 347.

see of Valencia. His concessions to the demands of the ministers of war and marine for additional estimates for the army and navy exposed him to the attacks of Villaverde in the Cortes; and still fiercer criticism was provoked by the measure, laid by him before the Cortes on the 23rd of June, for the revision of the concordat with Rome, and more especially by the proposal to raise a loan at 4% to indemnify the religious orders for their estates confiscated during the Revolution. Violent scenes greeted the attempt of the government to procure the suspension of the parliamentary immunities of 140 deputies, accused or suspected of more or less treasonable practices, and when, on the 4th of October, the Cortes reopened after the summer recess, Señor Romero Robledo, the president of the lower house, opened an attack on the ministry for their attempted breach of its privileges. Furious debates followed on this, and on the subject of Maura's financial proposals, which were attacked by the Conservative Villaverde and the Liberal Moret with impartial heat. On the 14th of December Maura resigned an impossible task and King Alphonso made General Azcarraga head of a narrowly Clerical-Conservative cabinet.

The new ministry, confronted by a rapidly spreading revolutionary agitation and by a rising provoked by a crop failure and famine in Andalusia, survived scarcely a month. On the 26th of January 1905 Azcarraga resigned, and two days later Señor Villaverde once more became prime minister. He was in no hurry to summon the Cortes, partly because the elections to the provincial councils were due in March, and these had to be manipulated so as to ensure the return of a Senate of the right colour, partly because the convocation of the Cortes seemed at best a necessary evil. Already the discredit of parliamentary government was being evidenced in the increased personal power of the young king. Alphonso was now shaking himself loose from the deadening influence of the reactionary court, and was beginning to display a disconcerting interest in affairs, information about which he was apt to seek at first hand. The resignation of the see of Valencia by Archbishop Nozaleda was a symptom of the new spirit. This was none the less distasteful to the Republicans, who thundered against personal government, and to the Liberals, who clamoured for the Cortes and the budget. The Cortes met at last on the 14th of June, and the upshot justified Villaverde's reluctance to meet it. Attacked by Maura and Moret alike, the prime minister (June 20) accused his former colleague of acting through personal pique; on a motion of confidence, however, he was defeated by 204 votes to 54, and resigned. He died on the 15th of July following, within a few weeks of his former leader and colleague Silvela.

The Liberals now once more came into power under Señor E. Montero Rios, Señor Moret having refused the premiership. The government programme, announced with a view to influencing the impending elections, included financial reform, reform of the customs, modification of the *octroi*, and the question of the concordat with Rome. The result of the elections was a substantial Liberal majority in both houses. The government was none the less weak. Quarrels broke out in the cabinet between Señor José Echeray, the distinguished banker and famous dramatist, who as minister of finance was intent on retrenchment, and General Weyler, who as minister of war objected to any starving of the army. On the 27th of October, scarcely a fortnight after the opening of the session, the government resigned. At the instance of the king, who was going abroad, Señor Montero Rios consented indeed to resume office; but his difficulties only increased. The price of corn rose, owing to the reimposition by the government, before the elections, of the import duties on corn and flour; and in November there was serious rioting in Seville, Granada, Oviedo, Bilbao and Valencia, while in Catalonia the Separatist movement gathered such force that on the 29th martial law was proclaimed throughout the province. The same day the government finally resigned. Señor Moret now accepted the

Enthronement of Alphonso XIII., 1902.

Resignation and Death of Sagasta.

Break-up of Parties.

Villaverde Ministry, 1904.

First Maura Ministry, 1904.

Azcarraga Ministry.

Villaverde Ministry, 1905.

Montero Rios Ministry, 1905.

Moret Ministry.

premiership; he took over Señor Echeray's budget, while General Weyler was replaced at the war office by General Luque.

The great constitutional parties had broken up into quarrelling groups just at the time when, as it seemed, the parties of reaction were concentrating their forces. Not the least ominous symptom was the attitude of the officers, who, irritated by newspaper attacks on their conduct in Catalonia more especially, demanded that all crimes against the army should be tried by the councils of war. The prolonged controversies to which this gave rise were settled on the 18th of March by a compromise passed by the Cortes; under this act all cases of press attacks on officers were to be tried by the courts martial, while those against the army generally and the national flag were still to be reserved for the civil courts. The singular weakness of the government revealed by this abdication of part of the essential functions of the civil power would have led to its speedy downfall, but for the truce cried during the festivities connected with the marriage of the king with Princess Victoria Eugénie Ena of Battenberg, which took place on the 31st of May.

The king's marriage was in many respects significant. In spite of the young queen's "conversion" and the singular distinction conferred on her by the papal gift of the golden rose, the "Protestant" alliance marked a further stage

Alphonso XIII. in Alphonso XIII's emancipation from the tutelage of the Clerical-Conservative court. He was, indeed, increasingly displaying a tendency to think and act for himself which, though never over-stepping the bounds of the constitution, was somewhat disconcerting to all parties. His personal popularity, too, due partly to his youth and genial manners, was at this time greatly increased by the cool courage he had shown after the dastardly bomb attack made upon him and his young wife, during the wedding procession at Madrid, by the anarchist Matteo Morales.¹ Whatever his qualities, the growing entanglement of parliamentary affairs was soon to put them to the test. For the coronation was hardly over when Señor Moret resigned,

and on the 6th of July Captain-General Lopez-Dominguez became head of a cabinet with a frankly anti-clerical programme, including complete liberty of worship, the secularization of education, and the drastic regulation of the right of association. The signature by the king of an ordinance giving legal validity to the civil marriages of Catholics aroused a furious agitation among the clergy, to which bounds were only set by the threat of the government to prosecute the bishop of Tuy and the chapter of Cordova. In the session 1906-1907 the most burning subject of debate was the new Associations Law, drawn up by Señor Davila. Even in the Liberal ranks the question aroused furious differences of opinion; Señor Montero Rios, the president of the senate, denounced the "infamous attacks on the church"; the government itself showed a wavering temper in entering on long and futile negotiations with the Vatican; while in January 1907 the cardinal archbishop of Toledo presented a united protest of the Spanish episcopate against the proposed law. This and other issues produced complete disunion in the Liberal party. Already, on the 27th of November, Lopez-Dominguez had resigned; his successor, Moret, had at once suffered defeat in the house and been succeeded in his turn, on the 4th of December, by marquis de la Vega de Armijo. The question was now mooted in the cabinet of dropping the Associations Law; but on the 21st of January Señor Canalejas, president of the lower house, who was credited with having inspired the bill, publicly declared that in that event he would cease to support the government. By the 24th the cabinet had resigned, and a Conservative government was in office under Señor Maura as premier.

Lopez-Dominguez Ministry, 1906.

Civil Marriage Question.

The administration of Señor Maura, which lasted till the 21st of October 1900 marks an important epoch in the history of

Vega de Armijo Ministry, 1906-1907.

modern Spain. The new premier was no mere party politician, but a statesman who saw the need of his country, on the one hand for effective government, on the other hand for education, so as to enable it ultimately to govern itself. Though a sincere Catholic, he was no Clerical, as was proved by his refusal to withdraw the ordinance on civil marriage. The main objects that he set before himself were, firstly, the maintenance of order; secondly, the reform of local government, so as to destroy the power of the *Caciques* and educate the people in their privileges and responsibilities. The dissolution of the Cortes produced a certain rearrangement of parties. The Liberal groups, as usual when in opposition, coalesced. The Republicans, on the other hand, split into sections; in Barcelona, Tarragona and Gerona they were Separatists, while a new party appeared under the name of Solidarists, consisting of Separatists, Carlists and Socialists. The elections in April resulted in a sweeping Conservative victory—the government secured a majority in the lower house of 88 over all other groups combined. As for the "dynastic opposition," it was reduced to a rump of 66 members, a result so unsatisfactory from the point of view of the monarchy that the government offered to quash certain Conservative returns in order to provide it with more seats. The dynastic opposition, however, considered that it had been unfairly dealt with in the conduct of the elections; and though, out of consideration for the dynasty (an heir to the throne having been born on the 10th of May), they attended the opening of the Cortes on the 13th of May, the Liberals refused to take part in the session that followed, which lasted till the 29th of July. When, however, the Cortes reopened on the 10th of October, the dynastic opposition was once more in its place. It was now that Señor Maura brought in his Local Administration Bill, a measure containing 429 clauses, the main features of which were that it largely increased the responsibility of the local elected bodies, made it compulsory for every elector to vote, and did away with official interference at the polls. The bill met with strenuous opposition, and on the 23rd of December 1907 the Cortes adjourned without its having been advanced.

At the close of the year an Anarchist outrage gave the excuse for the proclamation of martial law in Barcelona, and after the opening of the new session of the Cortes (January 23, 1908) a bill was introduced into the senate giving to the government the most drastic powers for the suppression of Anarchism. Its provisions practically amounted to a complete suspension of the guarantees for civil liberty, it met with the most strenuous opposition, and its final passing by the Senate (May 9) was followed by a serious crisis. Two months before (March 10-13) King Alphonso, with characteristic courage, had paid a surprise visit to Barcelona, and the general enthusiasm of his reception seemed to prove that the disaffection was less widespread or deep than had been supposed. In the circumstances, Señor Maura dropped the Suppression Bill, and the king issued an ordinance re-establishing constitutional guarantees in Catalonia.

This good feeling was unfortunately not destined to be of long duration; and in the following year the struggle between the antagonistic forces in Spain once more produced a perilous crisis. The Local Administration Bill, after being debated for two sessions, passed the lower house on the 13th of February 1909, having at the last moment received the support of the Liberal Señor Moret, though the Radicals as a whole opposed it as gratifying to Señor Cambò, the Regionalist leader, and therefore as tending to disintegration. Though ruling in the spirit of an enlightened despotism rather than in that of a constitutional government, Señor Maura had succeeded in doing a notable work for Spain. It was inevitable that in doing so he should incur unpopularity in many quarters. His efforts to reconstruct the Spanish navy were attacked both by the apostles of retrenchment and by those who saw in the shipbuilding contracts an undue favouring of the foreigner; the Marine Industries Protection Act was denounced as favouring the large ship-owners and exporters at the expense of the smaller men; the

Second Maura Administration, 1907.

Local Administration Reform.

Local Administration Reform.

Local Administration Reform.

Local Administration Reform.

¹The king's reckless daring was destined later to impair his popularity, for in an enthusiastic motorist blind courage is a quality apt to be exercised at the expense of others.

Compulsory Education Act as "a criminal assault on the rights of the family." His ecclesiastical policy also exposed him to the fate of those who take the middle way; the Liberals denounced the minister of education, Don F. Rodriguez San Pedro, for making concessions to the teaching orders, while the archbishops of Burgos and Santiago de Compostella fulminated against the government for daring to tax the congregations. In his reforming work Señor Maura had an active and efficient lieutenant in the minister of the interior, Señor La Cierva. Under his auspices laws were passed reforming and strengthening the police force, instituting industrial tribunals, regulating the work of women and children, introducing Sunday rest, early closing, and other reforms. In short, the government, whatever criticism might be levelled at its methods, had accomplished a notable work, and when on the 6th of June 1909 the Cortes adjourned, its position seemed to be assured.

Its downfall was ultimately due to the development of the crisis in Morocco. This is described elsewhere (see *MOROCCO: Morocco History*); here it is only proposed to outline the effects of its reaction upon the internal affairs of Spain.

The trouble, long brewing, broke out in July, with the attack by the Riff tribesmen upon the workmen engaged on the railway being built to connect Melilla with the mines in the hills, held by Spanish *cessionnaires*. The necessity for strengthening the Spanish forces in Africa had for some time been apparent; but Señor Maura had not dared to face the Cortes with a demand for the necessary estimates, for which, now that the crisis had become acute, he had to rely on the authorization of the council of state. The spark was put to the powder by the action of the war minister, General Linares, in proposing to organize a new field force by calling out the Catalan reserves. This summoned up too vivid memories of the useless miseries of former over-sea expeditions. On the 26th of July a general strike was proclaimed at Barcelona, and a movement directed at first against the "conscription" rapidly developed into a revolutionary attack on the established order in church and state.

The city, a *colluvies gentium*, was seething with dangerous elements, its native proletariat being reinforced by emigrants returned embittered from failure in South America and a cosmopolitan company of refugees from justice in other lands. The mob, directed by the revolutionary elements, attacked more especially the convents and churches. From the city the revolutionary movement spread to the whole province. In Barcelona the rising was suppressed after three days' street fighting (July 27-29). On the 28th martial law was proclaimed throughout Spain; and now began a military reign of terror, which lasted until the end of September. In the fortress of Monjuich in Barcelona were collected, not only rioters caught red-handed, but many others—notably journalists—whose opinions were obnoxious. The greatest sensation was caused by the arrest, on the 31st of August, of Señor Ferrer, a theoretical anarchist well known in many countries for his anti-clerical educational work and in Spain especially as the founder of the "lay schools." He was accused of being the chief instigator of the Barcelona rising, was tried by court martial (Oct. 11-13), and shot. This tragedy, which rightly or wrongly aroused the most widespread indignation throughout Europe, produced a ministerial crisis in Spain. The opening of the October session of the Cortes was signalized by a furious attack by Señor Moret on Señores Maura and La Cierva, who were accused of having sacrificed Ferrer to the resentment of their clerical task-masters. The government had been already weakened by the news of Marshal Marina's reverse in Morocco (Sept. 30); to this new attack it succumbed, Señor Maura resigning on the 21st of October 1909.

On the 22nd the formation of a new cabinet under Señor Moret was announced. It was from the first in a position of singular weakness, without a homogeneous majority in the Cortes, and depending for its very existence on the uncertain support of the extreme Left and the Republicans. For three months it existed without daring

to put forward a programme. It sent General Weyler to keep Barcelona in order, caused the release of most of the prisoners in Monjuich, reduced the forces in Morocco, reopened negotiations with Rome for a modification of the concordat, and on the 31st of December, the end of the financial year, was responsible for the issue of a royal decree stating that the budget would remain in force until the Cortes could pass a new one. But, meanwhile, the municipal elections, under the new Local Administration Law, had resulted in a triumph of the Liberals (Dec. 12). Señor Moret now considered the time ripe for a dissolution; the king, however, refused to consent, and on the 9th of February 1910 the ministry resigned. The new cabinet, with Señor Canalejas as president of the council, included members of the various Liberal and Radical groups: Garcia Prieto (foreign affairs), Count Sagasta (interior), General Aznar (war), the Democrat Arias Miranda (navy), Cobian, a strong Catholic though a Liberal (finance), Ruiz Valarino, a Democrat (justice), Calbeton (public works) and Count Romanones, who advocated a liberal settlement with the Church (education).

Though at once denounced by Señor Moret as "a democratic flag being used to cover reactionary merchandise,"¹ the name of Canalejas was in itself a guarantee that the burning question of the relations of the state to Rome and the religious orders would at last be taken in hand, while the presence of so many moderate elements in his cabinet showed that it would be approached in a conciliatory spirit. A beginning was made with the issue of a circular by the minister of finance (March 18), ordering the collection of taxes from all religious bodies carrying on commercial and industrial enterprises. What more could be done would depend on the result of the elections necessitated by the dissolution of the Cortes on the 15th of April. Count Romanones, desiring to educate the electors, had been busy establishing schools; but the sweeping victory of the Liberals at the polls² was probably far more due to the fact that this was the first election held under Señor Maura's Local Administration Act, and that the ignorant electors, indignant at being forced to vote under penalty of a fine, where they did not spoil their ballot papers, voted against the Conservatives as the authors of their grievance.

The government was thus in a position vigorously to pursue its religious policy. On the 31st of May the official *Gaceta* published a decree setting forth the rules to which the religious associations would have to submit. It was pointed out that, in conformity with the decree of the 9th of April 1902, it had become necessary to coerce those congregations and associations which had not fulfilled the formalities prescribed by the law of 1887, and also those engaged in commerce and industry which had not taken out patents with a view to their taxation. It further ordered that all foreign members of congregations were to register themselves at their respective consulates, in accordance with the decrees of 1901 and 1902. On the 11th of June a further and still more significant step was taken. A royal ordinance was issued repealing that signed by Canovas del Castillo (Oct. 23, 1876), immediately after the promulgation of the constitution of 1876, interpreting the 11th article of the constitution, by which the free exercise of all cults was guaranteed in Spain. The article in question forbade "external signs or public manifestations of all religious confessions with the exception of that of the state," which was defined by Canovas del Castillo as meaning "any emblem, attribute or lettering which would appear on the exterior walls of dissident places of worship."³ In the speech from the throne at the opening of the new Cortes (June 16) the king declared that his government would "strive to give expression to the

¹ *The Times* (Feb. 18, 1910).

² The composition of the new parliament was as follows—Senate: Ministerialists, 103; Conservatives, 42; Regionalists, 5; Republicans, 4; Carlists, 3; miscellaneous groups, 11. Lower House: Ministerialists, 227; Conservatives, 105; Republicans, 42; Carlists, 9; Catalans, 7; Integrists, 2; Independents, 9; unattached, 3.

³ *The Times* (June 13, 1910).

public aspirations for the reduction and control of the excessive number of orders and religious orders, without impairing their independence in spiritual matters," and in introducing a bill for the amendment of the law of 1887 Señor Canalejas declared that the government, "inspired by the universal spirit of liberty of conscience," had given to article xi. of the constitution "the full sense of its text."¹

"Liberty of conscience," a principle condemned by the Syllabus of 1864 and sneered at in the encyclical *Pascendi gregis* of 1905, was hardly a phrase calculated to conciliate the Spanish clergy, still less the Vatican. A cry went up that to allow dissident churches to announce their presence was to insult and persecute the Catholic Church;² at Rome the decree was attacked as unconstitutional, and a breach of diplomatic propriety all the more reprehensible as negotiations for a revision of the concordat were actually pending. A violent clerical agitation, encouraged by the Vatican, was started, 72 Spanish archbishops and bishops presenting a joint protest to the government. Fuel was added to the fire by the introduction of a bill—known as the Cadenas bill—prohibiting the settlement of further congregations in Spain until the negotiations with the Vatican should have been completed. This was denounced at Rome as a unilateral assertion on the part of the Spanish government of an authority which, under the concordat, belonged to the Holy See as well. As a preliminary to negotiation, the government was required to rescind all the obnoxious measures. This demand broke the patience of the prime minister, and on the 30th of July Señor de Ojeda, Spanish ambassador at the Vatican, was instructed to hand in his papers. In Vatican circles dark hints began to be dropped of a possible *rapprochement* with Don Jaime, who had succeeded his father Don Carlos, on the 18th of July 1909, as the representative of Spanish legitimacy and Catholic orthodoxy. The pretender, indeed, disclaimed any intention of stirring up civil war in Spain; his mission would be to restore order when the country should have wearied of the republican régime whose speedy advent he foresaw. The fulfilment of the first part of this prophecy seemed to some to be brought a step nearer by the overthrow of the monarchy in Portugal on the 5th of October 1910. For Spain its immediate effect was to threaten a great increase of the difficulties of the government, by the immigration of the whole mass of religious congregations expelled from Portugal by one of the first acts of the new régime.

(W. A. P.)

CHRONOLOGICAL TABLES OF CHRISTIAN DYNASTIES IN SPAIN.

Kings of the Visigoths, having relations with Spain, but not established within it:—

Ataulf . . .	410-415	Entered the north-east of Spain, murdered at Barcelona.
Sigeric . . .	415	His murderer, promptly murdered in turn.
Wallia . . .	415-419	Elected king, was the ally (foederatus) of the empire. Defeated the Vandals and Alans. Migrated to south-west of France with all his people.
Theodoric I. . .	419-451	Made inroads into Spain, as ally of the empire. Killed in the battle with Attila.
Thorismund . .	451-453	All these kings had the seat of their government north of the Pyrenees. They made inroads in Spain and had a stronghold on the north-east. Alaric was killed by the Frankish king, Clovis, at Vouillé, 507.
Theodoric II. .	453-466	
Eric . . .	466-485	
Alaric II. . .	485-507	
Gesalic . . .	507-511	Bastard son of Alaric, was murdered.
Amalaric . . .	507-531	Reigned in south and south-east of France under protection of Theodoric, the Ostrogothic king in Italy. Fled before Franks to Barcelona at end of reign, and was murdered at Barcelona.

Kings of the Visigoths established in Spain:—

Theudis . . .	531-548	An Ostrogoth, general of Theodoric. Murdered Amalaric, and was murdered in turn at Seville by Theudigisel.
Theudigisel . .	548-549	Murdered by Agila.
Agila . . .	549-554	Murdered at Mérida.
Athanagild . .	554-567	Rebelle against Agila, evacuated Andalusia to secure aid of Imperial officers. Established the capital at Toledo.
Liuva I. . .	567-572	Elected at Narbonne. Associated his brother Leovigild with himself.
Leovigild . . .	567-586	The first Visigoth king who assumed the diadem and purple, struck coins in his own name, and enforced recognition of his supremacy in all parts of Spain, except the south coast.
Reccared . . .	586-601	Son. Associated with his father. The first Visigoth king who was a Catholic.
Liuva II. . .	601-603	Son. Soon murdered.
Witteric . . .	603-610	Leader of Arian reaction.
Gunthemar . .	610-612	Obscure kings.
Sisebut . . .	612-620	
Reccared II. .	620-621	
Swintella . . .	621-631	Associated his family with him on the throne. They were all deposed by the nobles.
Reccimer . . .	621-631	
Sisinand . . .	631-636	These kings were mainly supported by the clergy, and were engaged in endeavouring to make the crown hereditary, by associating their kinsmen with themselves.
Chintila . . .	636-640	
Tulga . . .	640-641	
Chindaswinth .	641-652	
Recceswinth . .	649-672	
Wamba . . .	672-680	Unrelated to his predecessor and elected by the nobles—was deposed and tonsured.
Erwic . . .	680-687	The most obscure of the Visigoth kings. Egica and Witiza appear to have continued the struggle with the nobles, by whom Roderic was tumultuously elected, in opposition to Witiza's son Actula.
Egica . . .	687-701	
Witiza . . .	697-710	
Roderic . . .	710-711	

Early kings of the Christian north-west of Spain, of uncertain chronology and relationship:—

Pelayo . . .	718-737	Elected as "king of the Goths."
Favila . . .	737-739	Brother of Pelayo.
Alphonso I. . .	739-757	Son-in-law of Pelayo.
Froila . . .	757-768	Son of Alphonso I. Murdered by his brother.
Aurelio . . .	768-774	Brother or cousin.
Silon . . .	774-785	Brother-in-law of Aurelio.
Maurecat . . .	785-789	Bastard son of Alphonso I.
Bermudo . . .	789-792	Called the Deacon, descendant of Alphonso I., reigned for a very short time, and retired to a religious house.
Alphonso II. . .	792-842	Called the Chaste, son of Froila. Was perhaps chosen in opposition to Bermudo.
Ramiro I. . .	842-850	Son of Bermudo the Deacon.
Ordoño I. . .	850-866	Son of Ramiro.
Alphonso III. .	866-914	Son of Ordoño.

Period of the small kingdoms, unions, separations and reunions; the sons of Alphonso III. having rebelled, and forced a division of the kingdom near the close of the king's reign:—

Garcia	910-913	Took Leon, which then included Bardulia, or Castile, as the eldest son.
Ordoño II. . . .	913-923	Second son; became king in Galicia which included northern Portugal and acquired Leon on the death of his brother Garcia.
Fruela	923-924	Third brother; held Asturias, and was king of all north-west for a short time after death of Ordoño.
Alphonso IV. . . .	924-931	Son of Ordoño; became a monk at Sahagun, and was succeeded by his brother Ramiro.
Ramiro II. . . .	931-950	In his reign Castile broke away from Leon, under the count Fernan Gonzales.
Ordoño III. . . .	950-955	Son of Ramiro.
Sancho I., "The Fat."	955-967	Half brother of Ordoño III. and son of Ramiro II. by his second marriage with a daughter of Sancho Abarca of Navarre. Was driven out by his nobles, in alliance with Fernan Gonzales, count of Castile, and restored by the caliph. The rebels put Ordoño, son of Alphonso IV., on the throne for a time.
Ramiro III. . . .	967-982	Son of Sancho. Succeeded as a boy. His reign was a period of anarchy.
Bermudo II., "The Gouty"	982-999	Son of Ordoño III., was supported against his cousin Ramiro III. by the nobles, and was placed on the throne by the Hajib Mansur.
Alphonso V. . . .	999-1027	Son of Bermudo. Began the restoration of the kingdom after the period of anarchy, and subjection to the caliphate. Killed at siege of Viseu.
Bermudo III. . . .	1027-1037	Son of Alphonso V.; was killed in battle at Tamaron with his brother-in-law Ferdinand, count and then first king of Castile.
Fernando I., or Ferdinand.	1027-1065	Son of Sancho el Mayor of Navarre, king of Castile by right of his mother, and of Leon and Galicia by the sword.

COUNTS OF CASTILE

The counts of Castile began, as a body, and not as a line of chiefs, in the reign of Alphonso the Chaste (789-842). They strove for independence from the first, and when one count had replaced several they achieved it.

Fernan Gonzales	923-968	Made himself independent of Leon. One of his daughters married Ordoño III. of Leon. By a second marriage with a daughter of Sancho Abarca of Navarre he had a son and successor.
Garcia Fernandez	968-1006	Son.
Sancho Garcia	1006-1028	Son.
Garcia	1028	Murdered. Castile then passed to Garcia's sister, the wife of Sancho el Mayor of Navarre.

EARLY KINGS OF NAVARRE

The early history of Navarre has been overlaid with fable, and with pure falsification, largely the work of the Benedictines of San Juan de la Peña near Huesca. Their object was to prove the foundation of their house by a king of Navarre, Aragon and Sobrarbe, in the 9th century. They were helped by the patriotism of the Aragonese, who wished to give their kingdom an antiquity equal to that of Leon. Hence much pure invention, bolstered up by forgery of charters, falsification of genuine ones, and construction of imaginary pedigrees.

Sancho Abarca, <i>i.e.</i> Brogues	906-926	Made himself independent king at Pamplona. He fought with the Carolingian counts of the marches, and in alliance with the Spanish Mahomedan Beni Casi of Saragossa.
Garcia Sanchez	926-966	Very obscure. The most undoubted personality of the time is Tota (Theuda), widow of Sancho Abarca, who governed for her son and whose daughters were married to the kings of Leon and counts of Castile.
Sancho Garcia	966-993	
Garcia Sanchez	993-1000	
"The Trembler"		
Sancho el Mayor	1000-1035	Son of "The Trembler." He married a daughter of Sancho Garcia, count of Castile. On the murder of Garcia, the last count, he took Castile by right of his wife. He inherited, or acquired, superiority over the central Pyrenean regions of Aragon and Sobrarbe. He divided his various dominions—Navarre to Garcia, Castile to Fernando, Sobrarbe to Gonzalo, and Aragon to Ramiro Sanchez, a natural son.
Garcia III. . . .	1035-1054	Killed in battle with his brother Fernando of Castile and Leon at Atapuerca.
Sancho IV. . . .	1054-1076	Son. Murdered by his natural brother Ramon at Peñalen. The Navarrese then chose Sancho Ramirez of Aragon as king. The kingdoms remained united till 1134.

Historic kingdom of Aragon:—

Ramiro Sanchez	1035-1067	Natural son of Sancho el Mayor of Navarre, who on the death of his legitimate brother Gonzalo, annexed Sobrarbe. The kingdom of Sobrarbe lasted only during the life of Gonzalo.
Sancho I. . . .	1067-1094	Son of Ramiro. Was killed while besieging Huesca.
Pedro I. . . .	1094-1102	Son of Sancho.
Alphonso I. "The Battler."	1102-1134	Second son of Sancho. He took Saragossa from the Moors, and was married to Urraca, queen of Castile and Leon.
Ramiro II. . . .	1134-1137	Third son of Sancho. A monk, who was excommunicated after the death of Alphonso, but returned to the cloister on the birth of his daughter Petronilla.
Petronilla	1137-1164	Married to Ramon Berenguer, count of Barcelona, who became king by right of his wife.

THE EARLY COUNTS OF BARCELONA

In the last years of the 8th and beginning of the 9th century, Charlemagne and Louis the Pius began conquering the north-east of Spain, which the Arabs had occupied as early as 713. By 811 the Franks had conquered as far as Tortosa and Tarragona. The territory gained was called the Marca Hispanica, and was governed by counts of Roussillon, Ampurias, Besalut, Barcelona, Cerdeña, Pallars and Urgell. They became independent during the decadence of the Carolingians. The supremacy was acquired gradually by the

counts of Barcelona who became independent with Wilfred I. by 874. He and his immediate descendants gradually subdued the other counts. They suffered much from the inroads of Mansur in the 10th century, but on the decline of the caliphate, they took part in the general advance.

Berenguer Ramon I.	1018-1035	Held Barcelona, Vich and Manresa with land conquered from the Moors to the south.
Ramon Berenguer, "The Old."	1035-1076	Son. His father had divided his possessions between his widow and all his sons, but Ramon Berenguer reunited them by force. He left his dominion to be held in common by his two sons.
Ramon Berenguer II. and Berenguer Ramon II.	1076-1082	Ramon Berenguer II. Cap d'estops ("Tow Pow") was murdered by Berenguer Ramon II., whose end is unknown.
Ramon Berenguer	1076-1082	
Ramon Berenguer	1082-1131	Son of Ramon Berenguer II. By his marriage with Aldonza or Douce of Provence he acquired territory in south-eastern France. He inherited or subdued all the other countships of Catalonia, except Peralada.
Ramon Berenguer	1131-1162	Son. Inherited the Spanish possessions of his father, the French going to a brother. Was betrothed to Petronilla of Aragon, and married her in 1150, becoming king of Aragon.

Second period of the union, disunion and reunion of Castile and Leon from Fernando I. to Fernando III. Fernando I. divided his dominions among his three sons: to Sancho, the eldest, Castile; to Alfonso, the second son, Leon; to Garcia, the third son, Galicia.

Sancho II.	1065-1072	He expelled Alphonso and Garcia, reuniting the three kingdoms. Murdered at Zamora.
Alphonso VI.	1065-1109	Returned from exile, obtained all the three kingdoms, and imprisoned Garcia for life.
Urraca	1109-1126	Daughter of Alphonso VI., and widow of Raymond of Burgundy.
Alphonso VII.	1126-1157	Son. Recognized as king in Galicia during his mother's life. Divided his kingdoms between his sons; to the elder Sancho, Castile, to the younger, Fernando, Leon.
Sancho III.	1157-1158	In Castile.
Fernando II.	1157-1188	In Leon.
Alphonso VIII.	1158-1214	Castile. Son of Sancho III.
Alphonso IX.	1188-1230	Leon. Son of Fernando II. Is numbered IX. because he was junior to the cousin Alphonso of Castile.
Henry I.	1214-1217	Castile. Son of Alphonso VIII.
Berengaria	1217-	Daughter of Alphonso VIII. Married to Alphonso IX. of Leon, but the marriage was declared uncanonical by the pope. The children were declared legitimate. Berengaria resigned the crown of Castile to her son Fernando by the uncanonical marriage with Alphonso IX. of Leon.
Fernando III.	1217-1252	Inherited Leon on the death of his father Alphonso IX., and united the crowns for the last time, in 1230.

CASTILE AND LEON TILL THE UNION WITH ARAGON.

Fernando III. was king of Castile and Leon from 1230 to 1252.

Alphonso X.	1252-1284	Eldest son of Fernando III.
Sancho IV.	1284-1295	Second son of Alphonso X. Was preferred to the sons of his elder brother Ferdinand de la Cerda, who died in Alphonso's lifetime.
Ferdinand IV.	1295-1312	Son of Sancho.
Alphonso XI.	1312-1350	Son of Ferdinand IV.
Peter "The Cruel"	1350-1369	Son of Alphonso XI.
Henry II.	1369-1379	Natural son of Alphonso IX. He deposed and murdered Peter, and founded the line of the new kings.
John I.	1379-1390	Son of Henry II.
Henry III.	1390-1406	Son of John I.
John II.	1406-1454	Son of Henry III.
Henry IV.	1454-1474	Son. The legitimacy of the daughter of his second marriage was not recognized, and the crown of Castile passed to his sister, who married Ferdinand of Aragon. The marriage united the crowns in 1479.
Isabella	1474-1504	

Aragon, from the union with the county of Barcelona, to the union with Castile:—

Alphonso II.	1162-1196	Son and successor of Petronilla and Ramon Berenguer IV. Recovered the Provençal possessions of Ramon Berenguer II.
Peter II.	1196-1213	Son. Killed at Muret.
James I., "The Conqueror."	1213-1276	Son. Conquered the Balearic Islands and Valencia. Left the islands to his son James, from whom the title passed in succession to Sancho (d. 1324), his eldest son, to Sancho's nephew James (d. 1349), and to another James, his son (d. 1375); but the actual possession was recovered by the elder line before the extinction of the younger branch.
Peter III.	1276-1285	Eldest son. Conquered Sicily, claimed by right of his wife Constance, daughter of Manfred of Beneventum.
Alphonso III.	1285-1291	Eldest son. Succeeded to Spanish possessions.
James II.	1291-1327	Second son of Peter III. He had succeeded to Sicily, but resigned his rights, which were then assumed by his brother Frederick, who founded the Aragonese line of kings of Sicily.
Alphonso IV.	1327-1336	Son of James II.
Peter IV.	1336-1387	Finally reannexed the Balearic Islands.
John I.	1387-1395	Son by the marriage of Peter IV. with his cousin Eleanor of the Sicilian line.
Martin	1395-1410	Younger brother of John I. His son Martin was chosen king of Sicily, but died in 1409. The male line of the kings of Aragon of the House of Barcelona ended with Martin.
Ferdinand I.	1412-1416	Second son of Eleanor, sister of Martin, and wife of John I. of Castile. Succeeded by choice of the Cortes.
Alphonso V.	1416-1458	Son. Spent most of his life in Italy, where he was king of Naples and Sicily.
John II.	1458-1479	Brother of Alphonso V., whom he succeeded in the Spanish possessions, and Sicily, but not in Naples.
Ferdinand II.	1479-1516	Son. His marriage with Isabella united the crowns.

Navarre till the conquest of Ferdinand the Catholic:—

Garcia IV.	1134-1150	A descendant of Sancho el Mayor. Elected by the Navarrese on the death of Alphonso of Aragon without issue.
Sancho VI., called "The Wise"	1150-1194	Son. Father of Berengaria, wife of Richard Cœur de Lion.
Sancho VII.	1194-1234	Son. Died without issue.
Theobald I.	1234-1253	Husband of Blanche, daughter of Sancho "The Wise."
Theobald II.	1253-1270	Son. Died without issue.
Henry I.	1270-1274	Brother.
Jeanne I.	1274-1305	Daughter, wife of Philip IV. of France. Navarre was now absorbed in France, and so remained till 1328, when on the death of Charles IV. of France, the last of the house of Hugh Capet, it passed to his niece Jeanne, daughter of Louis X., and wife of Philip, count of Evreux.
Jeanne II.	1328-1349	Son. These two kings were much concerned with France, and little with Spain.
Charles II., called "The Bad"	1349-1387	
Charles III., "The Noble"	1387-1425	
John I. of Aragon	1425-1479	
Francis Phoebus	1479-1483	Died without issue, and was succeeded by his sister, the wife of Jean D'Albret. The Spanish part of Navarre was conquered by Ferdinand the Catholic in 1512.
Catherine	1483-1514	

KINGS OF UNITED SPAIN

Joan, "The Mad"	1504-1520	Daughter of Isabella, whom she succeeded in Castile, with her husband Philip I., of Habsburg. After his death, her father Ferdinand was guardian and regent.
Charles I. in Spain	1516-1556	Son of Joan. Was recognized as king with his mother; elected to the empire as Charles V.
Philip II.	1556-1598	Son. Succeeded on abdication of Charles V.
Philip III.	1598-1621	Son.
Philip IV.	1621-1665	Son.
Charles II.	1665-1700	Son. Died without issue.
Philip V.	1700-1746	Succeeded by the will of Charles II., as grandson of Maria Teresa, daughter of Philip IV., and of Louis XIV., king of France. With him began the line of the Spanish Bourbons. He abdicated for a few months in 1724-1725 in favour of his son Louis, but resumed the crown when Louis died.
Ferdinand VI.	1746-1759	Son by Philip V.'s first marriage with Maria Louisa of Savoy. Died without issue.
Charles III.	1759-1788	Brother. Son of Philip V. by his second marriage with Elizabeth Farnese.
Charles IV.	1788-1808	Son. He abdicated under pressure in 1808 in favour of his son Ferdinand, and then resigned his rights to Napoleon.

KINGS OF UNITED SPAIN (continued)

Ferdinand VII.	1808-1833	Was proclaimed king on the forced abdication of his father. Remained a prisoner in France during the Peninsular War. He repealed the Salic Law established by Philip V.
Isabella II.	1833-1868	Daughter. Her succession was resisted by her uncle Don Carlos, and the Carlist Wars ensued. Deposed.
Alphonso XII.	1875-1885	Son. His mother abdicated in his favour and he was restored.
Alphonso XIII.	1886-	Born after his father's death.

(D. H.)

BIBLIOGRAPHY.—(1) *Sources*: There are several published collections of sources for Spanish history. Of these the oldest is R. Belus, *Rerum hispanicarum scriptores aliquot in bibliotheca Roberti Beli* . . . 3 vols. fol. (Frankfort, 1579-1581). In 1740-1752 was published at Madrid J. A. de Creu y Bertodano's *Coleccion de los tratados de paz, alianza, neutralidad, garanzia, proteccion, treguia y mediacion, &c., que han hecho los reyes de España con los pueblos, republicas y demas potencias y otras partes del mundo*, in 12 vols. folio. A *Coleccion de documentos inéditos para la historia de España*, by Pidal and others, was published in 65 vols. (Madrid 1842-1876). In 1851 the Royal Academy of History of Madrid began the publication of its *Memorial histórica español*, a collection of documents, &c. See also Dionisio Hidalgo, *Diccionario general de bibliografía española*, 7 vols. (Madrid, 1862-1881).

(2) *Works*: The standard general history of Spain written by a Spaniard is that of Don Modesto Lafuente in 30 volumes (1850-1867; new ed., by Valera, 22 vols., Barcelona, 1888). It was written before the mediæval period had been properly investigated, is wordy, and largely spoilt by displays of national vanity. A later and more critical writer of nearly the same name, Don Vicente de la Fuente, has published valuable *Estudios críticos sobre la historia y el derecho de Aragon* (1884-1886). No satisfactory general history of Spain has been written by a foreigner. The best is that of M. Romey, *Histoire d'Espagne* (1843). Don Rafael Altamira has published an *Historia de España y de la civilización española* (2 vols., Barcelona, 1900-1902), in which he sums up the results of later research. Among older writers Juan de Mariana, who ends with the Catholic sovereigns, professedly took Livy as a model, and wrote a fine example of a rhetorical history published in Latin (1592-1609), and then in Spanish translated and largely re-written by himself. It was continued to 1600 by Minana. An English translation, with supplements, was published by Captain J. Stephens in 1699. *The Anales de Aragon* of Gerónimo Zurita (1610) are very far superior to the history of Mariana in criticism and research. The great school of Spanish historians died out with the other glories of the nation in the 17th century. The later periods have been indifferently treated by them, but Don Antonio Cánovas del Castillo published some valuable studies on the later Austrian dynasty under the title *Estudios del reinado de Felipe IV.* (1889). The reader may also consult—for the earlier period—Florian de Ocampo and Ambrosio de Morales, whose combined works are known as the *Crónica general de España* (fol. editions, 1543-1586, republished in 10 small volumes at Madrid, 1791-1792). This was continued by Prudencio de Sandoval, bishop of Tuy and afterwards of Pampeluna, under the title of *Hist. de los reyes de Castilla y de Leon: Fernando I.—Alonso VII.* Both ancient and later times are dealt with in the *Historia general de España, escrita por individuos de la real academia de la historia* (Madrid, 1892 sqq.)—a series of studies by different hands; that on the reign of Charles III., by Señor Manuel Danvila, is very valuable for the later 18th century. An account of the troubled years of the 19th century has been written by Don Antonia Piralá, *Historia contemporánea* (1871-1879). The latest general history of Spain is Don Rafael Altamira y Crevea's *Historia de España y de la civilización española*, 3 vols. (Barcelona 1902-1906). The standard authority for the Mahomedan side of Spanish history is the *Histoire des Musulmans d'Espagne, 711-1110*, by R. P. A. Dozy (4 vols., Leiden, 1861). It requires to be supplemented by Don Pascual de Gayongos's translation of Al Makkari's *History of the Mahomedan Dynasties in Spain* (1840-1843) and by Señor Francisco Codera's *Decadencia y desaparición de los Almoravides en España* (Saragossa, 1899) and *Estudios críticos de hist. árabe española* (ibid., 1903). See also Stanley Lane Poole, *The Moors in Spain* ("Story of the Nations" Series, 1887) and S. P. Scott, *Hist. of the Moorish Empire in Europe* (3 vols., Philadelphia and London, 1904). Other English works, on general Spanish history, are Martin A. S. Hume's *Spain, its Greatness and Decay, 1470-1788* (Cambridge, 1898) and *Modern Spain, 1788-1898* ("Story of the Nations" Series, 1899), and Butler Clarke's *Modern Spain, 1815-1898* (Cambridge, 1906). Excellent summaries of Spanish history year by year are published in the *Annual Register*.

THE SPANISH LANGUAGE

The Iberian Peninsula is not a linguistic unit. Not to speak of the Basque, which still forms an island of some importance in the north-west, three Romance languages share this extensive territory: (1) Portuguese-Galician, spoken in Portugal, Galicia, and a small portion of the province of Leor; (2) Castilian, covering about two-thirds of the Peninsula in the north, centre, and south; (3) Catalan, occupying a long strip of territory to the east and south-east.

These three varieties of the *Romana rustica* are marked off from one another more distinctly than is the case with, say the Romance dialects of Italy; they do not interpenetrate one another, but where the one ends the other begins. It has only been possible to establish at the points of junction of two linguistic regions the existence of certain mixed jargons in which certain forms of each language are intermingled; but these jargons, called into existence for the necessities of social relations by bilinguals, have an essentially individualistic and artificial character. The special development of the vulgar Latin tongue in Spain, and the formation of the three linguistic types just enumerated, were promoted by political circumstances. From the 9th century onwards Spain was slowly recaptured from the Mahomedans, and the Latin spoken by the Christians who had taken refuge on the slopes of the Pyrenees was gradually carried back to the centre and ultimately to the south of the Peninsula, whence it had been driven by the Arab invasion. Medieval Spain divides itself into three *conquistas*—that of Castile (much the most considerable), that of Portugal, and that of Aragon. If a given province now speaks Catalan rather than Castilian, the explanation is to be sought simply and solely in the fact that it was conquered by a king of Aragon and peopled by his Catalan subjects.

1. *Catalan*.—This domain now embraces, on the mainland, the Spanish provinces of Gerona, Barcelona, Tarragona and Lérida (the old principality of Catalonia), and of Castellon de la Plana, Valencia and Alicante (the old kingdom of Valencia), and, in the Mediterranean, that of the Balearic Islands (the old kingdom of Majorca). Catalan, by its most characteristic features, belongs to the Romance of southern France and not to that of Spain; it is legitimate, therefore, to regard it as imported into Spain by those *Hispani* whom the Arab conquest had driven back beyond the mountains into Languedoc, and who in the 9th century regained the country of their origin; this conclusion is confirmed by the fact that the dialect is also that of two French provinces on the north of the Pyrenees—Roussillon and Cerdagne. From the 9th to the 12th century Catalan spread farther and farther within the limits of Catalonia, properly so called; in 1229 it was brought to Majorca by Jaime el Conquistador, and in 1238 the same sovereign carried it to Valencia also. Even Murcia was peopled by Catalans in 1266, but this province really is part of the Castilian conquest, and accordingly the Castilian element took the upper hand and absorbed the dialect of the earlier colonists. The river Segura, which falls into the Mediterranean in the neighbourhood of Orihuela, a little to the north of Murcia, is as nearly as possible the southern boundary of the Catalan domain; westward the boundary coincides pretty exactly with the political frontier, the provinces of New Castile and Aragon not being at all encroached on. Catalan, which by the reunion of Aragon and the countship of Barcelona in 1137 became the official language of the Aragonese monarchy—although the kingdom of Aragon, consisting of the present provinces of Saragossa, Huesca and Teruel, has always been Castilian in speech—established a footing in Italy also, in all parts where the domination of the kings of Aragon extended, viz. in Sicily, Naples, Corsica and Sardinia, but it has not maintained itself here except in a single district of the last-named island (Alghero); everywhere else in Italy, where it was not spoken except by the conquerors, nor written except in the royal chancery, it has disappeared without leaving a trace.

In the 13th century the name given to the vulgar tongue of eastern Spain was *Catalanesch* (*Catalaniscus*) or *Catalá* (*Cata-*

lanus)—the idiom of the Catalans.¹ By *Catalanesch* or *Catalá* was understood, essentially, the spoken language and the language of prose, while that of poetry, with a large admixture of Provençal forms, was early called *Lemosi*, *Limosi* or language of Limousin—Catalan grammarians, and particularly the most celebrated of them, Ramon Vidal de Besalú, having adopted *Lemosi* as the generic name of the language of the troubadours. These grammarians carefully distinguish the vulgar speech, or *pla Catalá*, from the refined *trobar* idiom, which originally is a modified form of Provençal. Afterwards, and especially in these parts of the Catalan domain outside of Catalonia which did not acknowledge that they derived their language from that province, *Lemosi* received a more extensive signification, so as to mean the literary language in general, whether of verse or of prose. To this hour, particularly in Valencia and the Balearics, *Lemosi* is employed to designate on the one hand the old Catalan and on the other the very artificial and somewhat archaizing idiom which is current in the *jochs florals*; while the spoken dialect is called, according to the localities, *Valenciá* (in Valencia), *Majorquí* and *Menorquí* (in Majorca and Minorca), or *Catalá* (in Catalonia); the form *Catalanesch* is obsolete.

The principal features which connect Catalan with the Romance of France and separate it from that of Spain are the following: (1) To take first its treatment of the final vowels—Catalan, like French and Provençal, having only oxytones and paroxytones, does not admit more than one syllable after the tonic accent: thus *anima* gives *arma*, *cámara* gives *cambra*. All the proparoxytones of modern Catalan are of recent introduction and due to Castilian influence. Further, the only post-tonic Latin vowel preserved by the Catalan is, as in Gallo-Roman, *a*: *mare* gives *mar*, *gratu* (*s*) gives *grat*, but *anima* gives *arma*; and, when the word terminates in a group of consonants requiring a supporting vowel, that vowel is represented by an *e*: *arb(o)rem*, Cat. *abre* (Prov. and Fr. *arbre*, but Cast. *árbol*); *pop(u)l(us)*, Cat. *poble* (Prov. *poble*, Fr. *peuple*, but Cast. *pueblo*); sometimes, when it is inserted between the two consonants instead of being made to follow them, the supporting vowel is represented by an *o*: *escándol* (*s* *cándalum*), *frévol* (*f* *rivolus*), *círcol* (*c* *irculus*). In some cases a post-tonic vowel other than *a* is preserved in Catalan, as, for example, when that vowel forms a diphthong with the tonic (*Deu*, *Deus*; *Ebriu*, *Hebreus*); or, again, it sometimes happens, when the tonic is followed by an *i* in hiatus, that the *i* persists (*dilúvi*, *dilúvium*; *servici*, *servicium*; *lábi*, *lábiu*m; *ciri*, *cereus*); but in many cases these ought to be regarded as learned forms, as is shown by the existence of parallel ones, such as *servey*, where the atonic *i* has been attracted by the tonic and forms a diphthong with it (*servici*, *servii*, *servey*). What has just been said as to the treatment of the final vowels in Catalan must be understood as applying only to pure Catalan, unaltered by the predominance of the Castilian, for the actual language is no longer faithful to the principle we have laid down; it allows the final *o* atonic in a number of substantives and adjectives, and in the verb it now conjugates *canto*, *temo*, *sento*—a thing unknown in the ancient language. (2) As regards conjugation only two points need be noted here: (a) it employs the form known as the inchoative, that is to say, the lengthening of the radical of the present in verbs of the third conjugation by means of the syllable *ex* or *ix*, a proceeding common to Italian, Walachian, Provençal and French, but altogether unknown in Hispanic Romance; (b) the formation of a great number of past participles in which the termination is added, as in Provençal, not to the radical of the verb, but to that of the perfect: *tingut* from *tinch*, *poçut* from *poch*, *conegut* from *conech*, while in Castilian *tenido* (formerly also *tenudo*), *podido*, *conocido*, are participles formed from the infinitive.

As for features common to Catalan and Hispanic (Castilian and Portuguese) Romance, on the other hand, and which are unknown to French Romance, only one is of importance; the conservation, namely, of the Latin *u* with its original sound, while the same vowel has assumed in French and Provençal,

¹ The origin of the name *Catalanus* is unknown.

from a very early period—earlier doubtless than the oldest existing monuments of those languages—a labio-palatal pronunciation (*ü*). It is not to be supposed that the separation of Catalan from the Gallo-Roman family occurred before the transformation had taken place; there is good reason to believe that Catalan possessed the *ü* at one time, but afterwards lost it in its contact with the Spanish dialects.

Catalan being a variety of the *langue d'oc*, it will be convenient to note the peculiarities of its phonetics and inflexion as compared with ordinary Provençal.

Tonic Vowels.—With regard to *a*, which is pronounced alike in open and close syllables (*amar*, a m a r e; *abra*, a r b o r), there is nothing to remark. The Latin *ē*, which is treated like *ī*, gives *e*, sometimes close, sometimes open. On this point Catalan is more hesitating than Provençal; it does not distinguish so clearly the pronunciation of *e* according to its origin; while *ē* (*ī*) is capable of yielding an open *e*, the *ē* is often pronounced close, and the poets have no difficulty in making words in *e* close and in *e* open rhyme together, which is not the case in Provençal. The Latin *ē* never yields *ie* in Catalan as it does in French and occasionally in Provençal; *sedet* becomes *seu* (where *u* represents the final *d*), *pedem* makes *peu*, and *ego eu*; in some words where the tonic *ē* is followed by a syllable in which an *i* occurs, it may become *i* (*ir*, h ē r i; *mig*, m ē d i u s; *mils*, m ē l i u s); and the same holds good for *ē* in a similar situation (*ciri*, c ē r i u s, c ē r e u s; *fira*, f ē r i a), and for *e* in a close syllable before a nasal (*eximpli*, e x e m p l u m; *mintré* for *mentiré*, g i n t for g e n t). *I* tonic long and *i* short, when in hiatus with another vowel, produce *i* (*amich*, a m i c u s; *via*, v i a). *O* tonic long and *o* short are represented by *o* close and *o* open (*amor*, a m o r e m; *popble*, p o p u l u s). *O* short is never diphthongized into *uo* or *ue*; such a treatment is as foreign to Catalan as the diphthongization of *ē* into *ie*. Just as *e* before a syllable in which an *i* occurs is changed into *i*, so in the same circumstances *o* becomes *u* (*full*, f o l i u m; *vull*, v o l i o for v o l e o) and also when the accented vowel precedes a group of consonants like *cl*, *pl*, and the like (*ull*, o c ' l u s; *escull*, s e o p ' l u s). Latin *u* persists with the Latin pronunciation, and, as already said, does not take the Franco-Provençal pronunciation *ü*. Latin *au* becomes *o* (*cosa*, c a u s a; *or*, a u r u m); Old Catalan has kept the diphthong better, but possibly we should attribute the examples of *au* which are met with in texts of the 13th and 14th centuries to the literary influence of Provence. Latin *ua* tends to become *o* (*cor*, q u a r e).

Atonic Vowels.—As for the Latin post-tonic vowels already spoken of, it remains to be noted that *a* is often represented in writing by *e*, especially before *s*; in old Catalan, the substantives, adjectives and participles readily form their singular in *a* and their plural in *es*: *arma*, *armes* (a n i m a, a n i m a s); *bona*, *bones* (b o n a, b o n a s); *amada*, *amades* (a m a t a, a m a t a s). This *e* is neither open nor close, but a surd *e* the pronunciation of which comes very near *a*. In the same way the supporting vowel, which is regularly an *e* in Catalan, is often written *a*, especially after *r* (*abra*, a r b o r e m; *astra*, a s t r u m; *para*, p a t r e m); one may say that in the actual state of the language post-tonic *e* and *a* become indistinguishable in a surd sound intermediate between the French *a* and mute *e*. Before the tonic the same change between *a* and *e* constantly takes place; one finds in manuscripts *enar*, *emor* for *anar*, *amor* (the same extends even to the case of the tonic syllable, *ten* and *sent* from t a n t u m and s a n c t u m being far from rare), and, on the other hand, *antre*, *arrar*, for *entre*, *errar*. *I* atonic is often represented by *e* even when it is long (*vehi*, v i c i n u s). *O* atonic close, which in genuine Catalan exists only before the tonic, has become *u*; at the present day *trubar*, *cuntradir* is the real pronunciation of the words spelt *trovar*, *contradir*, and in the final syllables, verbal or other, where under Castilian influence an *o* has come to be added to the normal Catalan form, this *o* has the value of a *u*: *trovo* (genuine Catalan, *trof*) is pronounced *trovu*; *bravo* (genuine Catalan, *brau*) is pronounced *bravu*. *U* atonic keeps its ground.

The only strong diphthongs of the spoken language are *ái*, *áu* (rather rare), *éi*, *éu*, *íu*, *ói*, *óu*, *úí*, *úu*. *Ai* produced by *a+i* or by *a+a* palatal consonant has for the greater part of the time become an *e* in the modern language; *factum* has yielded *fait*, *feit*, and then *fet*, the last being the actual form; *arius* has given *er* alongside of *aire*, *ari*, which are learned or semi-learned forms. Of the two weak diphthongs *íó* and *úá*, the latter, as has been seen, tends to become *o* close in the atonic syllable, and is pronounced *u*: *quaranta* has become *coranta*, then *curanta*. After the tonic *ua* often becomes *a* in the Catalan of the mainland (*ayga*, a q u a, *llenga*, l i n g u a), while in Majorca it becomes *o* (*aygo*, *llengo*).

Consonants.—Final *t* readily disappears after *n* or *l* (*tan*, t a n t u m; *aman*, v e n i n, p a r t i n, for a m a n t, v e n i n t, &c.; *mol*, m u l t u m; *ocul*, o c u l t u m); the *t* reappears in composition before a vowel (*font*, f o n t e m, but *Font-alba*). On the other hand, a *t* without etymological origin is frequently added to words ending in *r* (*cart* for *car*, *quare*; *mart* for *mar*, *mare*; *amart*, *ohirt*, infinitive for *amar*, *ohir*), and even to some words terminating in a vowel (*genit*, i n g e n i u m; *premit*, p r e m i u m), or the addition of the *t* has taken place by

assimilation to past participles in *it*. The phenomenon occurs also in Provençal (see *Romania*, vii. 107, viii. 110). Median intervocal *d*, represented by *s* (*z*) in the first stage of the language, has disappeared: *fidelis* gave *fesel*, then *feel*, and finally *fel*; *videtis* became *vezets*, then *veets*, *vels* and *veu*. Final *d* after a vowel has produced *u* (*peu*, p e d e m; *niu*, n i d u m; *mou*, m o d u m); but when the *d*, in consequence of the disappearance of the preceding vowel, rests upon a consonant, it remains and passes into the corresponding surd; *frigidus* gives *fred* (pronounced *fret*). The group *dr*, when produced by the disappearance of the intermediate vowel, becomes *ur* (*creure*, c r e d e r e; *ociure*, o c c i d e r e; *veure*, v i d e r e; *seure*, s e d e r e). Final *n*, if originally it stood between two vowels, drops away (*bo*, b o n u m; *vi*, v i n u m), but not when it answers to *mn* (thus *donum* makes *do*, but *domnum* *don*; *sonum* makes *so*, but *sonnum* *son*). *Nd* is reduced to *n* (*demanar*, *comanar* for *demandar*, *comandar*). Assibilated *c* before *e*, *i* is treated like *d*; within a word it disappears after having been represented for a while by *s* (*lucere* gives *lusir*, *luhir*; *recipere* gives *rezebre*, *reebre*, *rebre*); at the end of a word it is replaced by *u* (*veu*, v i c e m; *feu*, f e c i t). The group *cr* gives *ur*, just like *dr* (*jaure*, j a c e r e; *naure*, n o c e r e; *plaire*, p l a c e r e; but *facere*, f a c e r e, d u c e r e, m a k e f a r (f e r), d i r, d u r). Initial *l* has been preserved only in certain monosyllables (the article *lo*, *los*); everywhere else it has been replaced by *l* mouillée (Prov. *lh*), which in the present orthography is written *ll* as in Castilian, but formerly used to be represented by *ly* or *yl* (*Uetra*, l i t e r a, *llengua*, l i n g u a). *P* readily disappears after *m*, like *t* after *n* (*cam*, c a m p u m; *tems*, t e m p u s). *B* is replaced by the surd *p* at the end of a word (*trobar* in the infinitive, but *trof* in the present tense); so also in the interior of a word when it precedes a consonant (*subvenir*, s u b v e n i r e, *sople*, s u b ' t o). Median intervocalic *f* gives *v* (*Estève*, S t e p h a n u s); it has disappeared from *profundus*, which yielded the form *preon*, then *pregon* (*g* being introduced to obviate the hiatus). *V*, wherever it has been preserved, has the same pronunciation as *b*; at the end of a word and between vowels it becomes vocalized into *u* (*suau*, s u a v i s; *viure*, v i v e r e). *C* guttural, written *qu* before *e* and *i*, keeps its ground as a central and as a final letter; in the latter position it is generally written *ch* (*amich*, a m i c u m; *joch*, j o c u m). *G* guttural is replaced as a final letter by surd *c* (*longa*, but *lonc*; *trigar*, but *trich*). *Tj* after a consonant gives *ss* (*assar*, c a p t i a r e); between vowels, after having been represented by soft *s*, it has disappeared (*rationem* gave *razó*, *raysó*, then *rahó*); at the end of every word it behaves like *ts*, that is to say, changes into *u* (*preu*, p r e t i u m); instead of *ts* the second person plural of the verb—a *t(i)s*, *e t(i)s*, *it(i)s*—now has *au*, *eu*, *iu* after having had *ats*, *ets* *its*. *Dj* gives *g* between vowels (*verger*, v i r i d i a r u m), and *c* as a terminal (written either *ig* or *ix*: *goig*, g a u d i u m *mig*, *mitx*, m e d i u m). *Stj* and *sc* before *e* and *i*, as well as *x* and *ps*, yield the sound *sh*, represented in Catalan by *x* (*angoxa*, a n g u s t i a; *conexer*, c o g n o s c e r e; *dix*, d i x i t; *mateix*, m e t i p s e). *J* almost everywhere has taken the sound of the French *j* (*judge*, &c.). *Lj* and *ll* give *l* mouillée (*ll* in the present orthography: *fill*, f i l i u m; *consell*, c o n s i l i u m; *null*, n u l l u m). In the larger portion of the Catalan domain this *l* mouillée has become *y*, almost everywhere *fy* is pronounced for *fill*, *consey* for *consell*. *Nj* and *nn* give *n* mouillée (*ny* in both old and modern spelling: *senyor*, s e n i o r e m; *any*, a n n u m). Sometimes the *ny* becomes reduced to *y*; one occasionally meets in manuscripts with *seyor*, *ay*, for *senyor*, *any*, but this pronunciation has not become general, as has been the case with the *y* having its origin in *ll*. Lingual *r* at the end of a word has a tendency to disappear when preceded by a vowel: thus the infinitives *a mare*, *temere*, **legire* are pronounced *amad*, *temé*, *llegí*. It is never preserved except when protected by the non-etymological *t* already spoken of (*llegirt* or *llegí*, but never *llegír*); the *r* reappears, nevertheless, whenever the infinitive is followed by a pronoun (*donarme*, *dirho*). *Rs* is reduced to *s* (*cos* for *cors*, c o r p u s). *H* is merely an orthographic sign; it is used to indicate that two consecutive vowels do not form a diphthong (*vehi raho*), and, added to *c*, it denotes the pronunciation of the guttural *c* at the end of a word (*amich*).

Inflexion.—Catalan, unlike Old Provençal and Old French, has never had declensions. It is true that in certain texts (especially metrical texts) certain traces of case-endings are to be met with, as for example *Deus* and *Deu*, *amors* and *amor*, *clars* and *clár*, *forts* and *fort*, *tuyt* and *tots*, *abduy* and *abdos*, *senyer* and *senyor*, *emperaire* and *emperador*; but, since these forms are used convertibly, the nominative form when the word is in the objective, and the accusative form when the word is the subject, we can only recognize in these cases a confused recollection of the Provençal rules known only to the literate but of which the transcribers of manuscripts took no account. Catalan, then, makes no distinctions save in the gender and the number of its nouns. As regards the formation of the plural only two observations are necessary. (1) Words which have their radical termination in *n* but which in the singular drop that *n*, resume it in the plural before *s*: *homin-em* makes *ome* in the singular and *omens* in the plural; *asin-um* makes *ase* and *asens*. (2) Words terminating in *s* surd or sonant and in *x* anciently formed their plural by adding to the singular the syllable *es* (*bras*, *brasses*; *pres*, *preses*; *mateix*, *mateixes*), but subsequently, from about the 15th century,

the Castilian influence substituted *os*, so that one now hears *brassos*, *presos*, *mateixos*. The words in *ix*, *sc*, *st* have been assimilated to words in *s* (*x*); from *bosch* we originally had the plural *bosches*, but now *boscos*; from *trist*, *tristes*, but now *tristos*. For these last in *st* there exists a plural formation which is more in accordance with the genius of the language, and consists in the suppression of the *s* before the *t*; from *aquest*, for example, we have now side by side the two plurals *aquestos*, in the Castilian manner, and *aquets*. The article is *lo*, *los* (pronounced *lu*, *lus* in a portion of the domain), fem. *la*, *les* (*las*). Some instances of *li* occur in the ancient tongue, applying indifferently to the nominative and the objective case; *el* applying to the singular is also not wholly unknown. On the north-western border of Catalonia, and in the island of Majorca, the article is not a derivative from *ille* but from *ipse* (sing. masc. *es* or *so*, fem. *sa*; pl. masc. *es*, and also *ets*, which appears to come from *istos*—*ets* for *ests*, like *aquets* for *aquests*—fem. *sas*). Compare the corresponding Sardinian forms *su*, *sa*, pl. *sos*, *sas*. On the pronouns it has only to be remarked that the modern language has borrowed from Castilian the composite forms *nosaltres* and *vosaltres* (pronounced also *nosaltros* and *nosatrus*), as also the form *vosté*, *vusté* (Castilian *usted* for *vuestra merced*).

Conjugation.—Catalan, and especially modern Catalan, has greatly narrowed the domain of the 2nd conjugation in *ēre*; a large number of verbs of this conjugation have been treated as if they belonged to the 3rd in *ēre*; *dēbere* makes *deure*, *videre*, *veure*, and alongside of *haber*, which answers to *habēre*, there is a form *heure* which points to *habēre*. A curious fact, and one which has arisen since the 15th century, is the addition of a paragogic *r* to those infinitives which are accented on the radical; in a portion of the Catalan domain one hears *creurer*, *veurer*. Some verbs originally belonging to the conjugation in *ēre* have passed over into that in *ir*; for example *tenēre* gives *tenir* alongside of *tindre*, *remānēre* *romanir* and *romandre*. In the gerundive and in the present participle Catalan differs from Provençal in still distinguishing the conjugation in *ir* from that in *er*, *re*—saying, for example, *sentint*. As in Provençal, the past participle of a large number of verbs of the 2nd and 3rd conjugations is formed, not from the infinitive, but from the perfect (*pogut*, *volgut*, *tingut* suggest the perfects *poch*, *volch*, *tinch*, and not the infinitives *poder*, *voler*, *tenir*). In the present indicative and subjunctive many verbs in *ir* take the inchoative form already described, by lengthening the radical in the three persons of the singular and in the third person of the plural by means of the syllable *esc* (*isc*). *agrahir* has the present indicative *agraesch*, *agraheixes*, *agraheix*, *agraheixen*, the present subjunctive *agraesca*, *-as*, *-a*, *-an* (or more usually now *agraesqui*, *-is*, *-i*, *-in*). The old perfect of the conjugation in *ar* had *ē* (also *i*) in the 1st pers. sing. and *-ān* in the 3rd; alongside of the *-ā*, which is proper to Catalan exclusively, we also find, in the first period of the language, *-el* as in Provençal. Subsequently the perfect of the three conjugations has admitted forms in *-r* (*amāres*, *amārem*, *amāreu*, *amāren*), derived from the ancient pluperfect *amara*, &c., which has held its ground down to the present day, with the meaning of a conditional in some verbs (one still hears *fora*, *haguera*). But the simple perfect is no longer employed in the spoken language, which has substituted for it a periphrastic perfect, composed of the infinitive of the verb and the present of the auxiliary *anar*: *vaig pendre*, for example, does not mean "I am going to take," but "I have taken." The earliest example of this periphrastic perfect carries us back to the 15th century. The most usual form of the subj. pres. in spoken Catalan is that in *-i* for all the three conjugations (*ami*, *-is*, *-i*, *-em*, *-eu* *-in*; *temi*, *-is*, &c.; *sentí*, *-is*, &c.); it appears to be an abbreviation from *-ia*, and in effect certain subjunctives, such as *cāntia*, *tēmia*, *tinguia*, *vinguia* (for *cante*, *tema*, *tinga*, *vingia*), evidently formed upon *sia* (subj. of *esser*), have been and still are used. The same *i* of the present subjunctive, whatever may be its origin, is still found in the imperfect: *amés*, *-essis*, *-cs*, *-essium*, &c.

Catalan Dialect of Alghero (Sardinia).—As compared with that of the mainland, the Catalan of Alghero, introduced into this portion of Sardinia by the Aragonese conquerors and colonists, does not present any very important differences; some of them, such as they are, are explicable by the influence of the indigenous dialects of Sassari and Logudoro. In phonetics one observes—(1) the change of *lj* into *y* as an initial before *i* (*yix*, *yigis*; *lego*, *legis*), a change which does not take place in the Catalan of the mainland except in the interior, or at the end of the word; (2) the frequent change of *l* between vowels and of *l* after *c*, *g*, *f*, *p* or *b* into *r* (*laura tabula*; *candera*, *candela*; *sangrot*, *singulum*; *frama*, *flama*). In conjugation there are some notable peculiarities. The 1st pers. sing. does not take the *o* which continental Catalan has borrowed from Castilian (*cant*, not *canto*, &c.); the imp. ind. of verbs of the 2nd and 3rd conjugations has *eva*, *va* instead of *ia*, a form which also occurs in the conditional (*cantariva*, *drumiriva*); the simple perfect, of which some types are still preserved in the actual language (e.g. *anighé*, *aghé*), has likewise served for the formation not only of the past participle but also of the infinitive (*agher*, *habere*, can only be explained by *ach*, 3rd person of the perfect); the infinitives with *r* paragogic (*viurer*, *seurer*, *plourer*) are not used (*viure*, *seure*, *ploure* instead); in the conjugation of the present of the verb *essar* or *esser*, the 2nd pers. sing. *ses* formed upon the persons of the plural, while

continental Catalan says *ets* (anciently *est*), as also, in the plural, *sem*, *seu*, instead of *som*, *sou*, are to be noted; *tenere* has passed over to the conjugation in *re* (*trenda* = *tendre*), but it is at the same time true that in ordinary Catalan also we have *tindrer* alongside of *tenir* the habitual form; *dicere* gives not *dir* but *diure*, which is more regular.

2. **Castilian.**—This name is the most convenient designation to apply to the linguistic domain which comprises the whole of central Spain and the vast regions of America and Asia colonized from the 16th century onwards by the Spaniards. We might also indeed call it the *Spanish* domain, narrowing the essentially geographical meaning of the word *Español* (derived, like the other old form *Españon*, from *Hispania*), and using it in a purely political sense. But the first expression is to be preferred, all the more because it has been long in use, and even the inhabitants of the domain outside the two Castiles fully accept it and are indeed the first to call their idiom *Castellano*. It is agreed on all hands that Castilian is one of the two branches of the vulgar Latin of Spain, Portuguese-Galician being the other; both idioms, now separated by very marked differences, can be traced back directly to one common source—the Hispanic Romance. One and the same vulgar tongue, diversely modified in the lapse of time, has produced Castilian and Portuguese as two varieties, while Catalan, the third language of the Peninsula, connects itself, as has already been pointed out, with the Gallo-Roman.

Within the Castilian domain, thus embracing all in Spain that is neither Portuguese nor Catalan, there exist linguistic varieties which it would perhaps be an exaggeration to call dialects, considering the meaning ordinarily attached to that word, but which are none the less worthy of attention. Generally speaking, from various circumstances, and especially that of the reconquest, by which the already-formed idiom of the Christian conquerors and colonists was gradually conveyed from north to south, Castilian has maintained a uniformity of which the Romance languages afford no other example. We shall proceed in the first instance to examine the most salient features of the *normal Castilian*, spoken in the provinces more or less closely corresponding to the old limits of Old and New Castile, so as to be able afterwards to note the peculiarities of what, for want of a better expression, we must call the Castilian dialects.

In some respects Castilian is hardly further removed from classical Latin than is Italian; in others it has approximately reached the same stage as Provençal. As regards the tonic, accent and the treatment of the vowels which come after it, Castilian may be said to be essentially a paroxytonic language, though it does not altogether refuse proparoxytonic accentuation and it would be a mistake to regard vocables like *lámpara*, *lágrima*, *rápido*, &c., as learned words. In this feature, and in its almost universal conservation of the final vowels *e*, *i*, *u* (*o*), Castilian comes very near Italian, while it separates from it and approaches the Gallo-Roman by its modification of the consonants.

Vowels.—Normal Castilian faithfully preserves the vowels *ē*, *ī*, *ō*, *ū*; the comparatively infrequent instances in which *ē* and *ō* are treated like *ě* and *ǒ* must be attributed to the working of analogy. It diphthongizes *ē* in *ie*, *ō* in *ue*, which may be regarded as a weakening of *uo* (see *Romania*, iv. 30). Sometimes *ie* and *ue* in the modern language are changed into *i* and *e*: *silla* from *sēlla* (Old Cast. *siella*), *vispera* from *vēspera* (Old Cast. *viespera*), *castillo* from *castēllum* (Old Cast. *castiello*), *frente* from *frōntem* (Old Cast. *fruento*), *fleco* from *flōccus* (Old Cast. *flueco*). The words in which *ē* and *ō* have kept their ground are either learned words like *médico*, *mérito*, or have been borrowed from dialects which do not suffer diphthongization. In many cases the old language is more rigorous; thus, while modern Castilian has given the preference to *mente*, *como*, *modo*, we find in old texts *miente*, *cuemo*, *muedo*. Lat. *a* makes *o* in all words of popular origin (*cosa*, *oro*, &c.).

Consonants.—On the liquids *l*, *m*, *n*, *r* there is little to be remarked, except that the last-named letter has two pronunciations—one soft (voiced), as in *amor*, *burla*, the other hard (voiceless), as in *rendir*, *tierra* (Old Cast. in this case goes so far as to double the initial consonant: *rrendir*)—and that *n* is often inserted before *s* and *d*: *ensayo*, *mensaje*, *rendir* (*reddere*). *L* mouillée (written *ll*) represents not only the Latin *l*, *ll*, *lj*, but also, at the beginning of words, the combinations *cl*, *gl*, *pl*, *bl*, *fl*: *llama* (*flama*), *llave*

(c l a v i s), *llorar* (p l o r a r e); the tendency of the modern language is, as in Catalan, to reduce *ll* to *y*; thus one readily hears *yeno* (p l e n u m). *N* mouillée (*ñ*) corresponds to the Lat. *nm, mn, nj*, and sometimes to initial *n*: *año* (a n n u m), *daño* (d a n n u m), *ñudo* (n o d u m). Passing to the dentals, except as an initial, *t* in words that are popularly current and belong to the old stock of the language, can only be derived from Lat. *tt, pt*, and sometimes *ct*, as in *meter* (m i t t e r e), *catar* (c a p t a r e), *punto* (p u n c t u m); but it is to be observed that the habitual mode of representing *ct* in normal Castilian is by *ch* (pron. *tch*), as in *derecho* (d i r e c t u m), *pecho* (p e c t u s), so that we may take those words in which *t* alone represents *ct* as secondary forms of learned words; thus we have *bendito*, *otubre*, *santo* as secondary forms of the learned words *bendicto*, *octubre*, *sancto*, alongside of the old popular forms *bendicho*, *ochubre*, *sancho*. *D* corresponds in Castilian to Latin *t* between vowels, or *t* before *r*: *amado* (a m a t u s), *padre* (p a t r e m). At the present day the *d* of the suffixes *ado*, *ido* is no longer pronounced throughout the whole extent of the domain, and the same holds good also of the final *d*: *salú*, *poné*, for *salud*, *poned* (from *s a l u t e m*, *p o n i t e*). Sometimes *d* takes the interdental sound of *z* (English *th*), or is changed into *l*; witness the two pronunciations of the name of the capital—*Madrid* and *Madril* (adj. *Madriñeño*). The study of the spirants, *c, z, s; g, j* is made a very delicate one by the circumstance that the interdental pronunciation of *c, z* on the one hand, and the guttural pronunciation of *g, j* on the other, are of comparatively recent date, and convey no notion of the value of these letters before the 17th century. It is admitted, not without reason, that the spirants *c, z*, which at present represent but one interdental sound (a lispéd *s*, or a sound between *s* and Eng. *th* in thing), had down till about the middle of the 16th century the voiceless sound *ts* and the voiced sound *dz* respectively, and that in like manner the palatal spirants *g, j, x*, before assuming the uniform pronunciation of the guttural spirant (=Germ. *ch* in *Buch*), had previously represented the voiced sound of *ž* (Fr. *j*) and the voiceless sound of *š* (Fr. *ch*), which are still found in Portuguese and in the Castilian dialects of the north-west. The substitution of these interdental and guttural sounds for the surd and sonant spirants respectively did certainly not take place simultaneously, but the vacillations of the old orthography, and afterwards the decision of the Spanish Academy, which suppressed *x* (=š; *x* was retained for *cs*) and allows only *c* and *g* before *e* and *i*, *z* and *j* before *a, o, u*, make it impossible for us to follow, with the help of the written texts, the course of the transformation. *S* now has the voiceless sound even between vowels: *casa* (pronounced *cassa*); final *s* readily falls away, especially before liquids: *todo los* for *todos los*, *vamono* for *vamos nos*. The principal sources of *j* (*g*) are—Lat. *j* and *g* before *e* and *i* (*juego*, *jocum*; *gente*, *gentem*); Lat. initial *s* (*jabon*, *saponeum*); Lat. *x* (*cojo*, *coxum*); *lj, cl* (*consejo*, *consilium*); *ojó*, *oculum*. The sources of *z* (*c*) are Lat. *ce, cj, tj, s* (*cielo*, *caelum*; *calza*, *calcea*; *razon*, *ratiōnem*; *zampaña*, *sympōnia*). As regards the spirants *f* and *v*, it is to be observed that at the beginning of a word *f* has in many instances been replaced by the aspirated *h* (afterwards silent), while in others no less current among the people the transformation has not taken place; thus we have *hijo* (*filium*) alongside of *fiesta* (*festā*). In some cases the *f* has been preserved in order to avoid confusion that might arise from identity of sound: the *f* in *fiel* (*fidelis*) has been kept for the sake of distinction from *hiel* (*iel*). As for *v*, it has a marked tendency to become confounded, especially as an initial letter, with the sonant explosive *b*; Joseph Scaliger's pun—*bibere est vivere*—is applicable to the Castilians as well as to the Gascons. *H* is now nothing more than a graphic sign, except in Andalusia, where the aspirate sound represented by it comes very near *j*. Words beginning in *hue*, where the *h*, not etymologically derived, marks the inseparable aspiration of the initial diphthong *ue*, are readily pronounced *güe* throughout almost the whole extent of the domain: *güele* for *huele* (*olet*); *güeso* for *hueso* (*os*). This *güe* extends also to words beginning with *bue*: *güeno* for *bueno* (*bonum*).

Inflection.—There is no trace of declension either in Castilian or in Portuguese. Some nominative forms—*Diós* (anciently *Dios*, and in the Castilian of the Jews *Dío*), *Cárlos*, *Márcos*, *sastre* (*sártor*)—have been adopted instead of forms derived from the accusative, but the vulgar Latin of the Peninsula in no instance presents two forms (subjective and objective case) of the same substantive. The article is derived from *ille*, as it is almost everywhere throughout the Romance regions: *el, la*, and a neuter *lo; los, las*. The plural of the first and second personal pronoun has in the modern language taken a composite form—*nosotros, vosotros*—which has been imitated in Catalan. *Quien*, the interrogative pronoun which has taken the place of the old *qui*, seems to come from *quem*.

Conjugation.—The conjugation of Castilian (and Portuguese) derives a peculiar interest from the archaic features which it retains. The vulgar Latin of Spain has kept the pluperfect indicative, still in current use as a secondary form of the conditional (*cantára, vendiéra, partiéra*), and, what is more remarkable still, as not occurring anywhere else, the future perfect (*cantáre, vendiére, partiére*, formerly *cantáro, vendiéro, partiéro*). The Latin future has been replaced, as everywhere, by the periphrasis (*cantare habeo*), but it is worth noticing that in certain old texts of the 13th century, and

in the popular songs of a comparatively ancient date which have been preserved in Asturias, the auxiliary can still precede the infinitive (*habeo cantare*), as with the Latin writers of the decadence: "Mucho de mayor precio a seer el tu manto Que non será el nuestro" (Berceo, *S. Laur.*, str. 70), where a *seer* (*habere seere*) corresponds exactly to *será* (*seere habet*). The vulgar Latin of the Peninsula, moreover, has preserved the 2nd pers. pl. of the imperative (*cantad, vended, partid*), which has disappeared from all the other Romance languages. Another special feature of Castilian-Portuguese is the complete absence of the form of conjugation known as inchoative (intercalation, in the present tense, of the syllable *isc* or *esc* between the radical and the inflexion), although in all the other tenses, except the present, Spanish shows a tendency to lay the accent upon the same syllable in all the six persons, which was the object aimed at by the inchoative form. Castilian displaces the accent on the 1st and 2nd pers. pl. of the imperfect (*cantábamos, cantábais*), of the pluperfect indicative (*cantáramos, cantárais*), and of the imperfect subjunctive (*cantásemos, cantáseis*); possibly the impulse to this was given by the forms of future perfect *cantáremos, cantáreis* (*cantarimus, cantaritis*). The 2nd persons plural were formerly (except in the perfect) *-ades, -edes, -ides*; it was only in the course of the 16th century that they got reduced, by the falling away of *d*, to *ais, eis* and *is*. The verb *essere* has been mixed, not as in the other Romance languages with *s t a r e*, but with *s e d e r e*, as is proved by older forms *seer, sieder, seyendo*, obviously derived from *s e d e r e*, and which have in the texts sometimes the meaning of "to be seated," sometimes that of "to be," and sometimes both. In old Latin charters also *s e d e r e* is frequently met with in the sense of *esse*: e.g. "*sedeat istum meum donativum quietum et securum*" (anno 1134), where *sedeat*=*sil*. The 2nd pers. sing. of the present of *ser* is *eres*, which is best explained as borrowed from the imperfect (*eras*), this tense being often used in Old Spanish with the meaning of the present; alongside of *eres* one finds (but only in old documents or in dialects) *sos*, formed like *sois* (2nd pers. pl.) upon *somos*. The accentuation in the inflexion of perfects in the conjugation called strong, like *hubieron hicieron*, which correspond to *habuerunt, fecerunt* (while in the other Romance languages the Latin type is *erunt*: Fr. *urent, firent*), may be regarded as truly etymological, or rather as a result of the assimilation of these perfects to the perfects known as weak (*amaron*), for there are dialectic forms having the accent on the radical, such as *dixon, hizon*. The past participle of verbs in *er* was formerly *udo* (*utus*) in most cases; at present *ido* serves for all verbs in *er* and *ir*, except some ten or twelve in which the participle has retained the Latin form accented on the radical: *dicho, hecho, visto*, &c. It ought to be added that the past participle in normal Castilian derives its theme not from the perfect, but from the infinitive: *habido, sabido*, from *haber, saber*, not from *hubo, supo*.

CASTILIAN DIALECTS.—To discover the features by which these are distinguished from normal Castilian we must turn to old charters and to certain modern compositions in which the provincial forms of speech have been reproduced more or less faithfully.

Asturian.—The Asturian idiom, called by the natives *bable*, is differentiated from the Castilian by the following characters. *Ie* occurs, as in Old Castilian, in words formed with the suffix *ellum* (*castiellu, portiellu*), while modern Castilian has reduced *ie* to *i*. *E, i, u*, post-tonic for *a, e, o*: *penes* (*penas*), *gracies* (*gracias*), *esti* (*este*), *frenti* (*frente*), *llechi* (*leche*), *nucchi* (*noche*), *unu* (*uno*), *primeru* (*primero*). There is no guttural spirant, *j*, but, according to circumstances, *y* or *x* (*š*); thus Lat. *cl, lj* gives *y*: *veyu* (**veclus*), *espeyu* (*speculum*), *conseyu* (*consilium*); and after an *i* this *y* is hardly perceptible, to judge by the forms *fiu* (*fillium*); *escoidos* (Cast. *escogidos*), *Castia* (*Castilla*); Lat. *g* before *e* and *i*, Lat. initial *j*, and Lat. *ss, x*, give *x* (*š*)—*xiente* (*gentem*), *xudiu* (*Judaeus*), *baxu* (*bassus*), *coxu* (*coxus*), *floxu* (*fluxus*). Lat. initial *f* has kept its ground, at least in part of the province: *fiu, fueya* (Cast. *hijo, hoja*). A very marked feature is the habitual "mouillure" of *l* and *n* as initial letters: *lleche, leer, lluna, llutu; ñon, ñunca, ñueve, ñube*. With respect to inflexion the following forms may be noted: personal pronouns: *i* (*illi*), *yos* (*illos*); possessive pronouns: *mió*, pl. *miós; to, tos; so, sos* for both masc. and fem.; verbs: 3rd pers. pl. imp. of the 2nd and 3rd conjugations in *in* for *ien* (Cast. *ian*); *train, tenin, facin* (from *facer*), *fiin* (from *fer*), and even some instances of the 2nd pers. sing. (*abis*; Cast. *habias*); instances of pres. subj. in *ia* for *a* (*sírvia, méria, sépia*). The verb *ser* gives *yees* (sometimes *yeres*) in the 2nd pers. sing., *ye* in the 3rd. *Facer* appears under two forms—*facer* and *fer*—and to the abridged form correspond *feis, fiendo, fiin*, &c. *Ire* often appears under the form *dir* (*antes de diros*=*antes de iros*), which it is not necessary to explain by *de-ire* (see H. Schuchardt, *Ztschr. f. rom. Philol.*, v. 312).

Navarrese-Aragonese.—In its treatment of the post-tonic vowels this dialect parts company with normal Castilian and comes nearer Catalan, in so far as it drops the final *e*, especially after *nt, rt* (*mont, plazient, muert, fuerit, parents, gents*); and, when the atonic *e* has dropped after a *v*, this *v* becomes a vowel—*brevu* (*breve*), *grievu* (**greve*), *nuevu* (*novem*). Navarrese-Aragonese has the diphthongs *ie, ue* from tonic *e* and *i*, and adheres more strictly to them than normal Castilian does—*cuende* (*domitem*), *huey* (*hodie*), *pueyo* (*podium*), *yees* (*est*), *yeran* (*erant*), while

Castilian says *conde, hoy, poyo, es, eran*. The initial combinations *cl, pl, fl*, have withstood the transformation into *ll* better than in Castilian: *plano, pleno, plega, clamado, flama* are current in old documents; and at the present day, although the *l* has come to be "mouillée," the first consonant has not disappeared (*pluma, plorá, plano*—pronounced *pljuma, &c.*). Lat. *ct* gives *ll*, not *ch* as in Castilian: *noeyt* (noctem), *destruito* (destructum), *proveito* (profectum), *dito* for *ditto* (dictum). *D* between vowels kept its ground longer than in Castilian: documents of the 14th century supply such forms as *vidieron, vido, hudio, provedir, redemir, prodeza, Benedir, vidiendo, &c.*; but afterwards *y* came to be substituted for *d* or *dj*: *veyere* (viderē), *seyer* (sederē), *seya* (sedea), *goyo* (gaudiū), *enuyo* (inodiū). Initial *f* does not change into *h*: *fillo, feito*. Navarrese-Aragonese does not possess the guttural spirant (*j*) of Castilian, which is here rendered according to circumstances either by *g* (Fr. *j*) or by *ll* (*l* mouillée), but never by the Asturian *x*. Certain forms of the conjugation of the verb differ from the Castilian: *dar, estar, haver, saber, poner* readily form their imperfects and imperfect subjunctives like the regular verbs in *ar* and *er*—*havieron* (Cast. *hubieron*), *estaron* (Cast. *estubieron*), *sabió* (Cast. *supo*), *dasen* (Cast. *diesen*), *poniese* (Cast. *pusiese*); on the other hand, past participles and gerundives formed from the perfect are to be met with—*fisiendo* for *faciendo* (perf. *fiso*), *twiando* and *twido* for *teniendo, tenido* (perf. *tuvo*). In the region bordering on Catalonia the simple perfect has given way before the periphrastic form proper to Catalan: *voy cayer* (I fell), *va fê* (he has done), *vamos ir* (we went), &c.; the imperfects of verbs in *er, ir*, moreover, are found in *eba, iba* (*comeba, subiba*, for *comia, subia*), and some presents also occur where the Catalan influence makes itself felt: *estigo* (Cat. *estich*), *vaigo* (Cat. *vaig*), *veigo* (Cat. *veig*). Navarrese-Aragonese makes use of the adverb *en* as a pronoun: *no les en daren pas, no'n hi ha*.

Andalusian.—The word "dialect" is still more appropriately applied to Andalusian than either to Asturian or Navarrese-Aragonese. Many peculiarities of pronunciation, however, are commonly called Andalusian which are far from being confined to Andalusia proper, but are met with in the vulgar speech of many parts of the Castilian domain, both in Europe and in America. Of these but a few occur only there, or at least have not yet been observed elsewhere than in that great province of southern Spain. They are the following: *L, n, r, d* between vowels or at the end of a word disappear: *sá* (*sal*), *só* (*sol*), *víee* (*viene*), *tiée* (*tiene*), *paá* and *pa* (*para*), *mía* (*mira*), *naa* and *na* (*nada*), *too* and *to* (*todo*). *D* is dropped even from the beginning of a word: *e* (*de*), *inero* (*dinero*), *on* (*don*). Before an explosive; *l, r, d* are often represented by *i*: *saiga* (*salga*), *vaiga* (*valga*), *laigo* (*largo*), *maire* (*madre*), *paire* (*padre*). Lat. *f* is more rigorously represented by *h* than in normal Castilian, and this *h* here preserves the aspirate sound which it has lost elsewhere; *hablá, horma* (*forma*), *hoder*, are pronounced with a very strong aspiration, almost identical with that of *j*. The Andalusians also very readily write these words *jablá, jorma, joder*. This aspirate, expressed by *j*, often has no etymological origin; for example, *Jándalo*, a nickname applied to Andalusians, is simply the word *Andaluz* pronounced with the strong aspiration characteristic of the inhabitants of the province. *C, z* are seldom pronounced like *s*; but a feature more peculiar to the Andalusians is the inverse process, the softened and interdenial pronunciation of the *s* (the so-called *ceceo*): *señor* (*señor*), &c. Before a consonant and at the end of a word *s* becomes a simple aspiration: *mihmo* (*misimo*), *Dioh* (*Dios*), *do reales* (*dos reales*). In the inflexion of the verb there is nothing special to note, except some instances of 2nd pers. sing. of the perfect in *tes* for *te*: *estuvistes, estuvites*, for *estuviste*—evidently a formation by analogy from the 2nd pers. of the other tenses, which all have *s*.

It is with the Andalusian dialect that we can most readily associate the varieties of Castilian which are spoken in South America. Here some of the most characteristic features of the language of the extreme south of Spain are reproduced—either because the Castilian of America has spontaneously passed through the same phonetic transformations or because the Andalusian element, very strongly represented in colonization, succeeded in transporting its local habits of speech to the New World.

Leonese.—Proceeding on inadequate indications, the existence of a Leonese dialect has been imprudently admitted in some quarters; but the old kingdom of Leon cannot in any way be considered as constituting a linguistic domain with an individuality of its own. The fact that a poem of the 13th century (the *Alexandro*), and certain redactions of the oldest Spanish code, the *Fuero Juzgo*, have a Leonese origin has been made too much of, and has led to a tendency to localize excessively certain features common to the whole western zone where the transition takes place from Castilian to Galician-Portuguese.

3. PORTUGUESE.—Portuguese-Galician constitutes the second branch of the Latin of Spain. In it we must distinguish—(1) Portuguese (*Portuguez*, perhaps a contraction from the old *Portugales*=Portugalensis), the language of the kingdom of Portugal and its colonies in Africa, Asia and America (Brazil); (2) Galician (*Gallego*), or the language of the old kingdom of

Galicia (the modern provinces of Pontevedra, La Coruña, Orense, and Lugo) and of a portion of the old kingdom of Leon (the territory of Vierzo in the province of Leon). Portuguese, like Castilian, is a literary language, which for ages has served as the vehicle of the literature of the Portuguese nation constituted in the beginning of the 12th century. Galician, on the other hand, which began a literary life early in the middle ages—for it was employed by Alfonso the Learned in his *Cantigas* in honour of the Virgin—decayed in proportion as the monarchy of Castile and Leon, to which Galicia had been annexed, gathered force and unity in its southward conquest. At the present day Gallego, which is simply Portuguese variously modified and with a development in some respects arrested, is much less important than Catalan, not only because the Spaniards who speak it (1,800,000) are fewer than the Catalans (3,500,000), but also because, its literary culture having been early abandoned in favour of Castilian, it fell into the vegetative condition of a provincial patois. Speaking generally, Portuguese is further removed than Castilian from Latin; its development has gone further, and its actual forms are more worn out than those of the sister language, and hence it has, not without reason, been compared to French, with which it has some very notable analogies. But, on the other hand, Portuguese has remained more exclusively Latin in its vocabulary, and, particularly in its conjugation, it has managed to preserve several features which give it, as compared with Castilian, a highly archaic air. Old Portuguese, and more especially the poetic language of the 13th century, received from the language of the troubadours, in whose poetry the earlier Portuguese poets found much of their inspiration, certain words and certain turns of expression which have left upon it indelible traces.

Vowels.—Lat. *ē, ō* with the accent have not been diphthongized into *ie, uo*, *ue*: *pé* (pedem), *dez* (decem), *bom* (bonus), *pode* (potet). On the other hand, Portuguese has a large number of strong diphthongs produced by the attraction of an *i* in hiatus or the resolution of an explosive into *i*: *raida* (rabia), *feira* (feria), *feito* (factum), *seixo* (saxum), *oito* (octo). A quite peculiar feature of the language occurs in the "nasal vowels," which are formed by the Latin accented vowels followed by *m, n, or ñ, nd*: *bē* (bene), *grā* (grande), *bō* (bonum). These nasal vowels enter into combination with a final atonic vowel: *irmão* (germanus); also *amão* (amant), *sermão* (sermonem), where the *o* is a degenerated representative of the Latin final vowel. In Old Portuguese the nasal vowel or diphthong was not as now marked by the *til* (˘), but was expressed indifferently and without regard to the etymology by *m* or *n*: *ben* (bene), *tan* (tantum), *disserom* (dixerunt), *serrom* (sermonem). The Latin diphthong *au* is rendered in Portuguese by *ou* (*ouro*, aurum), *pouco*, paucum), also pronounced *oi*. With regard to the atonic vowels, there is a tendency to reduce *a* into a vowel resembling the Fr. *e* "muet," to pronounce *o* as *u*, and to drop *e* after a group of consonants (*dent* for *dente*).

Consonants.—Here the most remarkable feature, and that which most distinctly marks the wear and tear through which the language has passed, is the disappearance of the median consonants *l* and *n*: *corão* (corona), *lua* (luna), *pôr* formerly *poer* (ponere), *conego* (canonicus), *vir* (venire), *dôr*, formerly *door* (dolorem), *paço* (palatium), *saude* (salutem), *pego* (pelagus). Lat. *b* passes regularly into *v*: *cavallo* (caballus), *fava* (faba), *arvore* (arborum); but, on the other hand, Lat. initial *v* readily tends to become *b*: *bexiga* (vesica), *bodo* (votum). Lat. initial *f* never becomes *h*: *fazer* (facere), *filo* (filum). Lat. *c* before *e* and *i* is represented either by the hard sibilant *s* or by the soft *z*. Lat. *g* between vowels is dropped before *e* and *i*: *ler* for *leer* (legere), *dedo* (digitum); the same is the case with *d*, of course, in similar circumstances: *remir* (redimere), *rir* (ridere). Lat. *j* has assumed the sound of the French *j*. The Latin combinations *cl, fl, pl* at the beginning of words are transformed in two ways in words of popular origin. Either the initial consonant is retained while the *l* is changed into *r*: *cravo* (clavum), *prazer* (placere), *fror* (florē); or the group is changed in *ch* (=Fr. *ch*, Catal. *x*) through the intermediate sounds *kj, fj, pj*: *chamar* (clamare), *chao* (planus), *chamma* (flamma). Within the word the same group and other groups also in which the second consonant is an *l* produce *l* mouillée (written *lh*, just as *n* mouillée is written *nh*, as in Provençal): *ovelha* (ovicla), *velho* (*vecllus); and sometimes *ch*: *facho* (fascium), *ancho* (amplum). Lat. *ss* or *sc* before *e* and *i* gives *ç* (Fr. *ch*): *baixo* (bassus), *facha* (fascia). The group *ct* is reduced to *it*: *leito* (lectum), *peito* (pectus), *noite* (noctem); sometimes to *ut*: *douto* (doctus). Such words as *fruto, reto, dileto* are modern derivatives from the learned forms *fructo,*

recto, dilecto. Lat. *es* becomes *is*: *seis* (s e x); or *isc*, *x* (=Fr. *ich*, *ch*): *seixo* (s a x u m), *luxo* (l u x u m); or even *ss*: *düsse* (d i x i).

Inflexion.—The Portuguese article, now reduced to the vocalic form *a, o, os, as*, was *lo* (exceptionally also *el*, which still survives in the expression *El-Rei*), *la, los, las* in the old language. Words ending in *l* in the singular lose the *l* in the plural (because it then becomes median, and so is dropped): *sol* (s o l e m), but *soes* (s o l e s); those having *ão* in the sing. form the plural either in *ões* or in *ães* according to the etymology: thus *cão* (c a n e m) makes *cães*, but *ração* makes *rações*. As regards the pronoun, mention must be made of the non-etymological forms of the personal *mim* and of the feminine possessive *minha*, where the second *n* has been brought in by the initial nasal. Portuguese conjugation has more that is interesting. In the personal suffixes the forms of the 2nd pers. pl. in *ades, edes, ides* lost the *d* in the 15th century, and have now become *ais, eis, is*, through the intermediate forms *aes, ees, eis*. The form in *des* has persisted only in those verbs where it was protected by the consonants *n* or *r* preceding it: *pondes, tendes, vindes, amardes*, and also no doubt in some forms of the present of the imperative, where the theme has been reduced to an extraordinary degree by the disappearance of a consonant and the contraction of vowels: *ides, credes, ledes*, &c. Portuguese is the only Romance language which possesses a personal or conjugated infinitive: *amar, amar-es, amar, amar-mos, amar-des, amar-em*; e.g. *antes de sair-mos*, "before we go out." Again, Portuguese alone has preserved the pluperfect in its original meaning, so that, for example, *amara* (a m a v e r a m) signifies not merely as elsewhere "I would love," but also "I had loved." The future perfect, retained as in Castilian, has lost its vowel of inflexion in the 1st and 3rd pers. sing. and consequently becomes liable to be confounded with the infinitive (*amar, render, partir*). Portuguese, though less frequently than Castilian, employs *ter* (t e n e r e) as an auxiliary, alongside of *aver*; and it also supplements the use of *e s s e r e* with *s e d e r e*, which furnished the subj. *seja*, the imperative *se, sede*, the gerundive *sendo*, the participle *sido*, and some other tenses in the old language. Among the peculiarities of Portuguese conjugation may be mentioned—(1) the assimilation of the 3rd pers. sing. to the 1st in strong perfects (*houve, pude, quiz, fez*), while Castilian has *hubo and hubo*; (2) the imperfects *punha, tinha, vinha* (from *por, ter and vir*), which are accented on the radical in order to avoid the loss of the *n* (*ponia* would have made *poia*), and which substitute *u* and *i* for *o* and *e* in order to distinguish from the present subjunctive (*ponha, tenha, venha*).

Galician.—Almost all the phonetic features which distinguish Portuguese from Castilian are possessed by Gallego also. Portuguese and Galician even now are practically one language, and still more was this the case formerly: the identity of the two idioms would become still more obvious if the orthography employed by the Galicians were more strictly phonetic, and if certain transcriptions of sounds borrowed from the grammar of the official language (Castilian) did not veil the true pronunciation of the dialect. It is stated, for example, that Gallego does not possess nasal diphthongs; still it may be conceded once for all that such a word as *planus*, which in Galician is written sometimes *chau* and sometimes *chan*, cannot be very remote from the Portuguese nasal pronunciation *chao*. One of the most notable differences between normal Portuguese and Galician is the substitution of the surd spirant in place of the sonant spirant for the Lat. *j* before all vowels and *g* before *e* and *i*: *xuez* (j u d i c e m), Port. *juiz*; *xunto* (j u n c t u m), Port. *junto*; *xente* (g e n t e m), Port. *gente*. In conjugation the peculiarities of Gallego are more marked; some find their explanation within the dialect itself, others seem to be due to Castilian influence. The 2nd persons plural have still their old form *ades, edes, ides*, so that in this instance it would seem as if Gallego had been arrested in its progress while Portuguese had gone on progressing; but it is to be observed that with these full forms the grammarians admit contracted forms as well: *ás* (Port. *ais*), *és* (Port. *eis*), *ís* (Port. *is*). The 1st pers. sing. of the perfect of conjugations in *er* and *ir* has come to be complicated by a nasal resonance similar to that which we find in the Portuguese *mim*; we have *vendin, partin*, instead of *vendi, parti*, and by analogy this form in *in* has extended itself also to the perfect of the conjugation in *ar*, and *falin, gardin*, for *falei, gardei* are found. The second persons of the same tense take the ending *che, ches* in the singular and *chedes* in the plural: *falache or falaches* (f a b u l a s t i), *falachedes* as well as *falásledes* (f a b u l a s t i s), *bateche or batiche*, pl. *batesles or batechedes*, &c. *Ti* (t i b i) having given *che* in Galician, we see that *falasti* has become *falache* by a phonetic process. The 3rd pers. sing. of strong perfect is not in *e* as in Portuguese (*houve, pôde*), but in *o* (*houbo, pôdo, soubo, coubo*, &c.); Castilian influence may be traceable here. If a contemporary grammarian, Saco Arce, is to be trusted, Gallego would form an absolute exception to the law of Spanish accentuation in the imperfect and pluperfect indicative: *falábamos, falabádes; batíamos, batíades; pidíamos, pidíades*; and *falaríamos, falarádes; bateríamos, baterádes; pidiríamos, pidirádes*. The future perfect indicative and the imperfect subjunctive, on the other hand, would seem to be accented regularly: *faláremos, falásemos*. The important question is worth further study in detail.

BIBLIOGRAPHY.—On the general subject the most important works are F. Diez, *Grammatik der romanischen Sprachen* (5th ed., Bonn, 1882) and *Etymologisches Wörterbuch der romanischen Sprachen* (4th ed., Bonn, 1878); W. Meyer-Lübke, *Grammatik der romanischen*

Sprachen (Leipzig, 1890-1894); G. Körting, *Lateinisch-romanisches Wörterbuch* (Paderborn, 1890-1891). See also A. Carnoy, *Le Latin d'Espagne d'après les inscriptions* (2nd ed., Brussels, 1906). (1) CATALAN.—A. Morel-Fatio, "Das Catalanische," in G. Gröber's *Grundriss der romanischen Philologie* (1888); E. Vogel, "Neucatalanische Studien," in G. Körting's *Neuphilologische Studien* (Heft 5, 1886); M. Milá y Fontanals, *De los Trovadores en España* (Barcelona, 1861), and *Estudios de lengua catalana* (Barcelona, 1875); A. Mussafia's introduction to *Die catalanische metrische Version der sieben weisen Meister* (Vienna, 1876); A. Nonell y Mas, *Análisis de la llenga catalana antiga comparada ab la moderna* (Manresa, 1895); J. P. Ballot y Torres, *Gramática y apología de la llengua catalana* (Barcelona, 1815); A. de Bofarull, *Estudios, sistema gramatical y crestomatia de la llengua catalana* (Barcelona, 1864); P. Fabrá, *Contribución á la gramática de la llengua catalana* (Barcelona, 1898). For the Catalan dialect of Sardinia see G. Morosi, "l'Odierno dialetto catalano di Alghero in Sardegna," in the *Miscellanea di filologia dedicata alla memoria dei Prof. Caix e Canello* (Florence, 1885), and F. Romoni, *Sardismi* (Sassari, 1887). (2) CASTILIAN.—Conde de la Viñaza, *Biblioteca histórica de la filología castellana* (Madrid, 1893); A. Bello, *Gramática de la lengua castellana* (7th ed., with notes by R. J. Cuervo, Paris, 1902); R. J. Cuervo, *Apuntes sobre el lenguaje bogotano* (5th ed., Paris, 1907); G. Baist, "Die spanische Sprache," in G. Gröber's *Grundriss der romanischen Philologie*; P. Förster, *Spanische Sprachlehre* (Berlin, 1880); E. Gorra, *Lingua e letteratura spagnuola delle origini* (Milan, 1898); R. Menéndez Pidal, *Manual elemental de gramática histórica española* (Madrid, 1905); F. M. Josselyn, *Études de phonétique espagnole* (Paris, 1907); C. Michaëlis, *Studien zur romanischen Wortschöpfung* (Leipzig, 1876); A. Keller, *Historische Formenlehre der spanischen Sprache* (Murrhardt, 1894); P. de Mugica, *Gramática del castellano antiguo* (Berlin, 1891); S. Padilla, *Gramática histórica de la lengua castellana* (Madrid, 1903); J. D. M. Ford, "The Old Spanish Sibilants" in *Studies and Notes in Philology* (Harvard University, Cambridge, Mass., 1900). For Asturian, see A. de Rato y Hévia, *Vocabulario de las palabras y frases que se hablan en Asturias* (Madrid, 1891), and the *Colección de poesías en dialecto asturiano* (Oviedo, 1839); for Navarrese-Aragonese, see J. Boraio, *Diccionario de voces aragonesas* (2nd ed., Saragossa, 1885); for Andalusian, the searching study of H. Schuchardt in the *Zeitschrift für romanische Philologie*, vol. v.; and for Leonese, R. Menéndez Pidal, "El Dialecto leonés," in the *Revista de archivos, bibliotecas, y museos* (Madrid, 1906). R. J. Cuervo's *Apuntes* (noted above) is the leading authority on American Spanish. The following publications may be consulted, but with caution: L. Abeille, *Idioma nacional de los Argentinos* (Paris, 1900); D. Granáda, *Vocabulario rioplatense razonado* (Montevideo, 1890); J. Fernández Ferraz, *Nahuatlismos de Costa Rica* (San José, 1892) and C. Gagini, *Diccionario de barbarismos de Costa Rica* (San José, 1893); A. Membreño, *Hondureñismos* (Tegucigalpa, 1897). See also C. C. Marden, *The Phonology of the Spanish Dialect of Mexico City* (Baltimore, 1896); J. Sánchez Somoano, *Modismos, locuciones y términos mexicanos* (Madrid, 1892), and F. Ramos i Duarte, *Diccionario de mejicanismos* (Mexico, 1895); J. de Arona, *Diccionario de peruanismos* (Lima, 1883); J. Calcaño, *El Castellano en Venezuela* (Caracas, 1897). (3) PORTUGUESE.—J. Cornu, "Die portugiesische Sprache," in G. Gröber's *Grundriss der romanischen Philologie*; F. A. Coelho, *Theoria da conjugação em latim e português* (Lisbon, 1871), and *Questões da lingua portuguesa* (Oporto, 1874). For Galician, see A. Fernández y Morales's *Ensayos poéticos de berceano* (León, 1861); M. R. Rodriguez, *Apuntes gramaticales sobre el romance gallego de la crónica troyana* (La Coruña, 1898), and Saco Arce, *Gramática gallega* (Lugo, 1868); for other dialectical varieties, see I. J. da Fonseca, *Noções de philologia accomodadas á lingua brasileira* (Rio de Janeiro, 1885); J. Leite de Vasconellos, *Dialectos beires* (Oporto, 1884), and *Sur le dialecte portugais de Macao* (Lisbon, 1892). Important articles by many of the above writers, and by other philologists of note, will be found in *Romania*, the *Zeitschrift für romanische Philologie*, the *Revue des langues romanes*, the *Revista lusitana*, the *Revue hispanique*, the *Bulletin hispanique*, *Cultura española* and the *Archiv für das Studium der neueren Sprachen*.

(A. M.-FA.; J. F.-K.)

SPANISH LITERATURE

The name Spanish in connexion with literature is now generally restricted to works in the Castilian tongue. In the present article it is taken in the wider sense as embracing the literary productions of the whole Iberian Peninsula, with the exceptions of Portugal and of Galicia, the latter of which, as regards language and literature, belongs to the Portuguese domain. Spanish literature thus considered falls into two divisions—Castilian and Catalan.

I. Castilian Literature.—Of the Castilian texts now extant none is of earlier date than the 12th century, and very probably none goes farther back than 1150. The text generally accepted as the oldest—the *Mystery of the Magian Kings*, as it is rather inappropriately designated by most historians of literature—is a fragment of a short semi-liturgical play meant to be acted

in the church of Toledo on the feast of Epiphany. Manifestly an imitation of the Latin *ludi* represented in France during the early years of the 12th century, the Spanish piece cannot have been composed much before 1150.

The national hero Rodrigo Diaz de Bivar (d. 1099), better known in history by the Arabic surname of the Cid, was celebrated in the vulgar tongue in two poems, neither of which has come down to us in its entirety. The more ancient *cantar*, usually entitled *Poema del Cid*, since it was originally edited (1779) by Tomás Antonio Sanchez, relates in its first part the valiant deeds (*gesta*) of the Cid subsequent to his quarrel with Alphonso VI.; in the second the capture of Valencia, the reconciliation of the hero with the king and the marriage of his daughters with the infantes of Carrión; and in the third the treason of the infantes, the vengeance of the Cid, and the second marriage of his daughters with the infantes of Navarre and Aragon. The narrative of the last years of the Cid, which closes the epic, is much curtailed. Whilst in the *Poema* the Cid appears as the loyal vassal, deploring the necessity of separating from his king, the Cid of the second poem, *Crónica rimada del Cid*, is almost a rebel and at least a refractory vassal who dares treat his sovereign as an equal. The portion of the *Crónica* which has been preserved deals in the main with the youth of Rodrigo; it contains the primitive version of his quarrel with the Count Gomez de Gormaz and the marriage of the slayer with Ximena, the Count's daughter, and also a series of fabulous episodes, such as the Cid's journey to France to fight with the twelve peers of Charlemagne, &c. The *Poema*, which survives in a 14th-century manuscript, belongs to about the middle of the 12th century; the form under which the *Crónica* text has reached us is at least two centuries later; but, on the other hand, several traditions collected by the author bear an incontestable stamp of antiquity. The versification of both poems is irregular. Normally this epic measure may be divided into two hemistichs of seven or eight syllables each; but here the lines sometimes fall short of this number and sometimes exceed it; the strophes follow the model of the *laissez* of the French *chansons de geste*—that is, they have a single assonance and vary greatly in extent.

A fragment of an epic poem on the infantes de Lara has been reconstituted from the *Crónica general* by Ramón Menéndez Pidal (1896); if similar poems existed on real personages like Roderick, or mythical heroes like Bernardo del Carpio, they have not survived. Still the frequent allusions in the chronicles to the narratives of the *juglares* suggest that Castilian heroic poetry was richer than the scarcity of the monuments now extant would lead us to believe. Fernán González, first independent count of Castile (10th century), has alone been celebrated in a poem composed (about 1250 or later) in single-rhyme quatrains.

With the heroic poetry which takes its themes from the national history and legends, there grew up in the 13th century a school of religious and didactic poetry, the most eminent representative of which is Gonzalo de Berceo (1180?–1246?). This poet, born at Berceo (Logroño), composed several lives of Spanish saints, and other devotional poems, such as the *Miracles* and the *Praises of the Virgin*. Berceo calls his poems *prosa*, *decir*, *dictado*, indicating thereby that he intended them to be read and recited, not sung like the *cantares*. They are written in single-rhyme quatrains and in verses of twelve to fourteen syllables, according as the ending of each hemistich is masculine or feminine. In the same metre were composed, also in the 13th century, two long poems—one on Alexander the Great, the other on Apollonius of Tyre—after Latin and French sources. The author of the first of these poems contrasts his system of versification, which he calls *mester de clerecía*, with the *mester de joglaría* used in heroic poetry, and intended to be sung; and he declares that this single-rhyme quatrain (*curso rimado por la quaderna via*) consists of counted syllables. The composer of *Apolonio* calls this same versification *nueva mestría*. The single-rhyme quatrain, introduced in imitation of the French poetry of the 12th century,

became from the time of Berceo and the *Alixandre* and *Apolonio* the regular form in Castilian narrative and didactic poetry, and prevailed down to the close of the 14th century.

To the 13th century are assigned a *Life of St Mary the Egyptian*, translated from the French, perhaps through a Provençal version, and an *Adoration of the Three Kings*, in verses of eight or nine syllables rhyming in pairs (*aa, bb, cc, &c.*), as well as a fragment of a *Debate between Soul and Body*, in verses of six or seven syllables, evidently an imitation of one of the medieval Latin poems, entitled *Rixa animi et corporis*. The oldest lyric in Castilian, *La Razón feita d'amor*, belongs to the same period and probably derives from a French source; it bears the name of Lope de Moros, who, however, seems to have been merely the copyist. Mention may here also be made of the *cantigas* (songs) of Alphonso the Learned in honour of the Virgin, although, being in the Galician dialect, these properly belong to the history of Portuguese literature.

The 14th century saw the birth of the most original medieval Spanish poet. Juan Ruiz, archpriest of Hita (near Guadalajara), has left us a poem of irregular composition, *Poetry of 14th Century*, in which, while reproducing apologues and *dits* from foreign sources, he frequently trusts to his own inspiration. Ruiz celebrates love and woman; his book is of *buen amor*, that is, he shows by his own experience and the example of those whom he follows how a man may become a successful lover. By way of precaution, the poet represents himself as one who has survived his illusions, and maintains that carnal love (*loco amor*) must finally give place to divine love; but this mask of devotion cannot disguise the real character of the work. The *Rimado de palacio* of Pero Lopez de Ayala, chancellor of Castile at the end of the 14th century, does not refer exclusively to court life; the author satirizes with great severity the vices of all classes of laymen and churchmen. Akin to this *Rimado de palacio* are the *proverbios morales* of the Jew Sem Tob of Carrión, dedicated to Peter the Cruel (1350 to 1369). The *Poema de Alfonso Onceno*, by Rodrigo Yañez, is a far-off echo of the epical poems, the *laissez* being superseded by octo-syllabic lines with alternate rhymes. The *General Dance of Death* and a new version of the *Debate between Soul and Body*, both in eight-line strophes of *arte mayor* (verses of twelve syllables), and both imitated from French originals, are usually referred to this period; they both belong, however, to the 15th century.

The word "romance" not only signifies in Spain, as in other Romanic countries, the vulgar tongue, but also bears the special meaning of a short epic narrative poem (historic ballad) or, at a later date, a short lyric poem. As regards the form, the "romance" (Spanish *el romance*, in contrast to French, &c., *la romance*) is a composition in long verses of sixteen syllables ending with one assonance; these verses are often wrongly divided into two short lines, the first of which, naturally, is rhymeless. This being the form of the *romance* verse, the *Crónica rimada del Cid*, and even the *Poema* (though in this case the influence of the French alexandrines is perceptible), might be considered as a series of *romances*; and in fact several of the old *romances* of the Cid, which form each an independent whole and were printed as separate poems in the 16th century, are partly to be found in the *Crónica*. Other *romances*, notably those dealing with the heroes of the Carolingian epic, so popular in Spain, or with the legendary figures which Spanish patriotism opposed to the French paladins—as, for example, Bernardo del Carpio, the rival and the conqueror of Roland in Castilian tradition—seem to be detached fragments of the *cantares de gesta* mentioned by Alphonso X. At the close of the 15th century, and especially during the 16th, the *romances*, which had previously passed from mouth to mouth, began to be written down, and afterwards to be printed, at first on broadsheets (*pliegos sueltos*) and subsequently in collections (*romanceros*); these are either general collections, in which *romances* of very different date, character and subject are gathered together, or are collections restricted to a single episode or personage (for example, the *Romancero*

del Cid). In such *romances* the epic verse is usually regarded as octosyllabic and is printed as such; occasionally certain editions divide the *romance* into strophes of four verses (*cuartetas*).

King Alphonso X. (d. 1284), under whose patronage were published the code entitled *Las Siete partidas* and several great scientific compilations (such as the *Libros de astro-chronicles*, *nomía* and the *Lapidario*), was also the founder of Spanish historiography in the vulgar tongue. The *Crónica general*, composed under his direction, consists of two distinct parts: the one treats of universal history from the creation of the world to the first centuries of the Christian era (*La General é grant historia*); the other deals exclusively with the national history (*La Crónica ó Historia de España*) down to the death of Ferdinand III. (1252), father of Alphonso. The main sources of the *Crónica general* are two Spanish ecclesiastical chroniclers of the 13th century—Lucas of Tuy and Rodrigo of Toledo; both wrote in Latin, but their works were early translated into the vernacular. In the *Historia de España*, printed in its true form for the first time in 1906, are collected many legends and occasional references to the songs of the *juglares* (for the purpose, however, of refuting them), the narrative relating to the Cid being partly based on an Arabic text. This portion, as recast in the *Crónica de Castilla* compiled by order of Alphonso XI., was published apart by Juan de Velorado under the title of the *Crónica del Cid* (1512), and has often been reprinted. Alphonso's example bore fruit. In the 14th century we find another *Crónica general de España* or *de Castilla*, constructed on the model of the first and embracing the years 1030–1312; next, the *Grant crónica de España* and the *Grant Crónica de los congueridores*, compiled by command of the grand master of the order of St John of Jerusalem, Juan Fernandez de Heredia (1310–1396), about 1390. Special chronicles of each king of Castile were soon written. Our information is defective regarding the authorship of the chronicles of Alphonso X., Sancho IV., Ferdinand IV. and Alphonso XI.; but the four following reigns—those of Pedro I., Henry II., John I. and Henry III.—were dealt with by Pero Lopez de Ayala; here we recognize the man of literary culture who had acquired some knowledge of ancient history, for the form of the narrative becomes freer and more personal, and the style rises with the thought. Alvar Garcia de Santa Maria and other writers whose names are not recorded probably compiled the chronicle of John II.; the events of Henry IV.'s disastrous reign were related by Diego Enriquez del Castillo and Alfonso Fernández de Palencia; the triumphs of the Catholic sovereigns Ferdinand and Isabella by Fernando del Pulgar and Andrés Bernáldez. With these royal chronicles should be mentioned some biographies of important persons. Thus in the 15th century the chronicle of Pedro Niño, count of Buelna (1375–1446), by Gutierre Diez de Games; that of Alvaro de Luna, constable of Castile (d. 1453); and a curious book of travels, the narrative of the embassy sent by Henry III. of Castile to Timur in 1403, written by the head of the mission, Ruy González de Clavijo.

The other productions of Castilian prose in the 13th and 14th centuries are for the most part didactic and sententious compositions, which, however, contain illustrations or tales of Eastern origin. The Spanish translation of *Kalila and Dimna*, made direct from an Arabic text, dates from the middle of the 13th century, and the romance of the *Seven Sages* (*Sindibad*), translated under the title of *Libro de los engaños é asayamientos de las mugeres*, is referred to 1253. From the second half of the 13th century the collections of aphorisms, *dits*, apologues and moral tales become very numerous: first of all, versions of the *Secretum secretorum*, attributed in the middle ages to Aristotle, one of which is entitled *Poridad de las poridades*, next the *Proverbios buenos*, the *Bocados de oro* or *Libro de bonium*, *Rey de Persia* and the *Libro de los gatos*, which is derived from the *Narrationes* of Odo of Cheriton. During the first half of the 14th century the nephew of Alphonso X., the

infante Juan Manuel, wrote the various works which place him in the first rank of medieval Spanish prose writers. The best known is the collection of tales, many of them borrowed from Oriental sources, entitled *El Conde Lucanor*; but, besides this contribution to literature, he wrote graver and still more didactic treatises. The knowledge of antiquity, previously so vague, made remarkable progress in the 14th century. Curiosity was awakened concerning certain episodes of ancient history, such as the War of Troy, and Benoît de Sainte-More's poem and the Latin narrative of Guido delle Colonne were both translated. Lopez de Ayala translated, or caused to be translated, Pierre Bersuire's French version of Livy, Boetius and various writings of Isidore of Seville and Boccaccio.

While the Carolingian cycle is mainly represented in Spain by assonanced *romances*, of which the oldest seem to be fragments of lost poems by the *juglares*, the British cycle (Lancelot, Tristram, Merlin, &c.) is represented almost exclusively by works in prose (see ROMANCE). Those narratives are known only in 15th and 16th century editions, and these have been more or less modified to suit the taste of the time; but it is impossible not to recognize that books such as *El Baladro del sabio Merlin* (1498) and *La Demanda del sancto grial* (1515) presuppose a considerable antecedent literature of which they are only the afterglow. The principal French romances of the Round Table were translated and imitated in Spain and in Portugal as early as the first half of the 14th century at least; of that there is no doubt. And, even if there were not satisfactory testimony on this point, the prodigious development in Spanish literature of the *caballerías*, or "books of chivalry," incontrovertibly derived from fictions of Breton origin, would be proof enough that at an early date the Spaniards were familiar with these romantic tales derived from France. The oldest work of the kind is *El Caballero Cifar*, composed at the beginning of the 14th century, but the first book of real importance in the series of strictly Spanish *caballerías* is the *Amadís de Gaula*. Certain considerations lead one to seek for the unknown author of the first *Amadís* in Portugal, where the romances of the Round Table were more highly appreciated than in Spain, and where they have exercised a deeper influence on the national literature. To Garci Rodríguez de Montalvo, however, falls the honour of having preserved the book by printing it; he made the mistake of diluting the original text and of adding a continuation, *Las Sergas de Esplandián*. Allied to Montalvo's *Amadís* with its supplementary *Esplandián* (1510) are the *Don Florisando* (1510) and the *Lisuarte de Grecia* (1514), the *Amadís de Grecia* (1514), the *Don Florisado de Niquea* (1532–1551), &c., which form what Cervantes called the "Amadis sect." Parallel with the Amadis are the Palmerines, the most celebrated of which are *Palmerin de Oliva* (1511), *Primaleon* (1512), and *Palmerin de Inglaterra*, which was first written in Portuguese by Moraes Cabral. None of those *caballerías* inspired by the *Amadís* were printed or even written before the 16th century, and they bear the stamp of that period; but they cannot be separated from their medieval model, the spirit of which they have preserved. Among the *caballerías* we may also class some narratives derived from the Carolingian epic—the *Historia del emperador Carlomagno y de los doce pares*, a very popular version still reprinted of the French romance of *Fierabras*, the *Espejo de caballerías*, into which has passed a large part of Boiardo's *Orlando innamorato*, the *Historia de la reina Sibilla*, &c.

The first half of the 15th century, or what comes almost to the same thing, the reign of John II. of Castile (1407–1454), is characterized as regards his literature (1) by the development of a court poetry, artificial and pretentious; (2) by the influence of Italian literature on Castilian prose and poetry, the imitation of Boccaccio and Dante, especially of the latter, which introduced into Spain a liking for allegory; and (3) by more assiduous intercourse with antiquity. After the example of the Provençal troubadours whose literary doctrines had made their

Other Prose Works of 13th and 14th Centuries.

Books of Chivalry.

Poetry of 15th Century.

way into Castile through Portugal and Catalonia, poetry was now styled the *arte de trovar*. The *arte de trovar* is strictly "court" poetry, which consists of short pieces in complicated measures—love plaints, debates, questions and repartees, *motes* with their *glosas*, burlesque and satirical songs—verse wholly "occasional" and deficient in charm when separated from its natural environment. In order to understand and appreciate these pieces they must be read in the collections made by the poets of the time, where each poem throws light on the others. The most celebrated *cancionero* of the 15th century is that compiled for the amusement of his sovereign by Juan Alfonso de Baena; it is, so to say, the official collection of the poetic court of John II., although it also contains pieces by poets of earlier dates. After Baena's collection may be mentioned the *Cancionero de Ståniga*, which contains the Castilian poems of the *trobadores* who followed Alphonso V. of Aragon to Naples. These *cancioneros*, consisting of the productions of a special group, were succeeded by collections of a more miscellaneous character in which versifiers of very different periods and localities are brought together, the pieces being classed simply according to their type. The earliest genuine *Cancionero general* (though it does not bear the title) is that compiled by Juan Fernández de Constantina, which appears to have been issued from the Valencia press at the beginning of the 16th century; the second, much better known, was published for the first time at Valencia in 1511 by Hernando del Castillo. The other poetic school of the 15th century, which claims to be specially related to the Italians, had as its leaders Juan de Mena, author of the *Coronación* and the *Laberinto de fortuna*, and the marquis of Santillana, Iñigo Lopez de Mendoza, who in his sonnets was, perhaps, the first to imitate the structure of the Italian hendecasyllabics. With those two chiefs, who may be designated *poetas* as distinguished from the *decidores* and the *trobadores* of the *cancioneros*, must be ranked Francisco Imperial, a Genoese by descent, who at a somewhat earlier date helped to acclimatize in Spain the forms of Italian poetry. The marquis of Santillana occupies a considerable place in the literature of the 15th century not only by reason of his poems, but through the support he afforded to all the writers of his time, and the impulse he gave to the study of antiquity and to the labours of translators. In the next generation the most prominent figures are Gomez Manrique and Jorge Manrique, the latter of whom has produced a short poem which is a masterpiece.

With the exception of the chronicles and some *caballerías* the prose of the 15th century contains little that is striking.

Prose of 15th Century. The translation of Virgil by Enrique de Villena is ponderous and shows no advance on the versions of Latin authors made in the previous century. A curious and amusing book, full of details about Spanish manners, is the *Corbacho* (1438) of the archpriest of Talavera, Alfonso Martinez de Toledo, chaplain to King John II.; the *Corbacho* belongs to the numerous family of satires against women, and this title, by which it is commonly known—borrowed from a work of Boccaccio's, with which it has otherwise nothing in common—indicates that he has not spared them.

The ancient liturgical Spanish theatre is known to us only by fragments of the play of the *Magian Kings*, already mentioned; but certain regulations given in the **Dramatic Literature.** *Siete parlidas* (compiled between 1252 and 1257) prove that such a theatre existed, and that at the great festivals, such as Christmas, Epiphany and Easter, dramatic representations were given in church. These representations, originally a simple commentary on the liturgy, were gradually adulterated with buffoonery, which frequently brought down the censure of the clergy. Alphonso X. even thought it necessary to forbid the "clerks" playing *juegos de escarnios*, and permitted in the sanctuary only dramas destined to commemorate the principal episodes of the life of Christ. Of all the Church festivals, the most popular in Spain was that of Corpus Christi, instituted by Urban IV. in 1264. At an early date the celebration of this festival was accompanied with

dramatic performances intended to explain to the faithful the eucharistic mystery. These dramas, called *autos sacramentales*, acquired more and more importance; in the 17th century, with Calderón, they become grand allegorical pieces, regular theological dissertations in the form of dramas. To the *auto sacramental* corresponds the *auto al nacimiento*, or drama of the Nativity. In Spain, as elsewhere, the secular theatre is a product of the religious theatre. Expelled from the Church, the *juegos de escarnios* took possession of the public squares and there attained free development; ceasing to be a mere travesty of dogma, they developed into a drama whose movement is no longer determined by the liturgy, and whose actors are borrowed from real life in Spanish society. This new theatre begins towards the close of the 15th century, with the pastoral pieces of Juan del Encina, which, after Virgil's example, he calls *églogas*. Genuine shepherds are the interlocutors of these bucolics, into which are also sometimes introduced students, and Lucas Fernández, a contemporary and pupil of Encina's, introduces gentlemen and soldiers. A book which, strictly speaking, does not belong to the theatre, the *Tragicomedia de Calixto y Melibea*, much better known as *La Celestina*, caused the new theatre, still rudimentary in the attempts of the school of Encina, to make a step onwards. This astonishing novel taught the Spaniards the art of dialogue, and for the first time exhibited persons of all classes of society (particularly the lowest) speaking in harmony with their natural surroundings. The progress caused by the *Celestina* may be estimated by means of the *Propaladia* of Bartolomé de Torres Naharro, a collection of pieces represented at Rome in presence of Leo X. Torres Naharro is thought to have borrowed from France the division of the play into "days" (*jornadas*); shortly after Naharro we find the comedy of manners in Lope de Rueda, whose dramatic work is composed of regular comedies constructed on the model of Italian authors of the beginning of the 16th century, and also of little pieces intended for performance in the intervals between the larger plays (*entremeses* and *pasos*), some of which are models of sprightly wit. Some of Naharro's, and especially of Rueda's, pieces foreshadow the comedy of intrigue, which is emphatically the type of the classic stage. But to reach Lope de Vega, the Spanish stage had to be enlarged in relation to national history. A poet of Seville, Juan de la Cueva, first brought on the boards subjects such as the exploits of the Cid, Bernardo del Carpio, and others, which had previously been treated of only in the *romances*. To a poet called Berrio, of whose work nothing has been preserved, are attributed the *comedias* of Moors and Christians, in which were represented famous episodes of the age-long struggle against the infidel. And it was at this period (1585) that Cervantes experimented in the drama; in his *Tratos de Argel* he gives us a picture of galley-life, recollections of his long captivity in Algiers. There is no need to linger over the attempts at tragedy of the ancient type by Jerónimo Bermúdez, Cristóbal de Virués, Lupericio Leonardo de Argensola, &c., the only successful specimen of which is the *Numancia* of Cervantes; these works, mere exercises in style and versification, remained without influence on the development of the Spanish stage. The pre-classic period of this stage is, as regards dramatic form, one of indecision. Some write in prose, like Rueda; others, like Naharro, show a preference for the *redondillas* of popular poetry; and there are those again who, to elevate the style of the stage, versify in hendecasyllabics. Hesitation is also evident as to the mode of dividing the drama. At first a division into five acts, after the manner of the ancients, is adopted, and this is followed by Cervantes in his early pieces; then Juan de la Cueva reduced the five acts to four, and in this he is imitated by most poets till the close of the 16th century (Lope de Vega himself in his youth composed pieces in four acts). Francisco de Avendaño divided his *Florisea* into three acts as early as 1551, but his example was not followed till about forty years later, when this division was generally adopted in all dramatic works—with the exception of short pieces like the *loa* (prologue), the *entremés*, the *paso*, the *baile* (different kinds of *entr'acte*).

The golden age of Spanish literature belongs to the 16th and 17th centuries, extending approximately from 1550 to 1650.

Classic Age, 16th and 17th Centuries. Previous to the reign of the Catholic sovereigns there exists, strictly speaking, only a Castilian literature, largely influenced by imitation first of

France and then of Italy; the union of the two crowns of Aragon and Castile, and afterwards the advent of the house of Austria and the king of Spain's election as emperor, achieved the political unity of Spain and the unity of Spanish literature. After the death of Philip IV. (1665) the light went out; the nation, exhausted by wars and bad administration, produced nothing; its literary genius sank in the general decline, and Spain was destined ere long to fall again under the influence of France, to which she had submitted during the first period of the middle ages. In the 16th and 17th centuries the literature was eminently national. Yet in certain kinds of literature the Spaniards continued to seek models abroad.

Lyric poetry, especially that of the more ambitious order, is always inspired by the Italian masters. An irresistible

tendency leads the Spanish poets to rhyme in hendecasyllabics—as the marquis of Santillana had formerly done, though his attempts had fallen

into oblivion—and to group their verses in tercets, octaves, sonnets and *canciones* (*canzoni*). Juan Boscán, Garcilaso de la Vega and Diego Hurtado de Mendoza are the recognized chiefs of the school *al itálico modo*, and to them belongs the honour of having successfully transplanted to Spain these different forms of verse, and of having enriched the poetic language of their country. The defects of Boscán and Mendoza (such as certain faults of rhythmic accentuation) were corrected by their disciples Gutierre de Cetina, Gregorio Silvestre, Hernando de Acuña, by the poets of the so-called school of Seville, headed by Fernando de Herrera and also by those of the rival school of Salamanca, rendered famous mainly by the inspired poetry of Luis Ponce de León. Against these innovators the poets, faithful to the old Castilian manner, the rhymers of *redondillas* and *romances*, held their own; under the direction of Cristóbal de Castillejo, they carried on a fierce war against the "Petrarchists." But by the last third of the 16th century the triumph of the new Italian school was assured, and no one any longer thought of reproaching it for its exotic flavour. Still at this period there was a schism between the higher poetry and the other varieties: in the former only the hendecasyllabic and the heptasyllabic (*quebrado*) were employed, while the popular poets, or those who affected a more familiar tone, preserved the national metres. Almost all the poets, however, of the 16th and 17th centuries tried their powers in both kinds of versification, using them in turn according to the nature of their subjects. Thus Lope de Vega, first of all, who wrote *La Dragontea* (1598), *La Hermosura de Angélica* (1602), *La Jerusalem conquistada* (1609), in Italian verses and in octaves, composed his long narrative poem on Isidore, the patron of Madrid (1599), in *quintillas* of octosyllabic verse, not to mention a great number of *romances*. As regards this last form, previously disdained by artistic poets, Lope de Vega gave it a prestige that brought it into favour at court. A host of poets were pleased to recast the old *romances* or to compose new ones. The 17th century, it may be said, is characterized by a superabundance of lyric poetry, to which the establishment of various literary academies contributed. Of this enormous mass of verses of all sorts little still survives; the names of most of the versifiers must be omitted, and in addition to those already cited it will be sufficient to mention Góngora and Quevedo. Góngora is especially famous as the founder of the "cultist" school, as the introducer into Castilian poetry of a periphrastic style, characterized by sonorous diction and artificial arrangements of phrase. The Spaniards have given the name of *culto* to this eccentric style, with its system of inversions based on Latin syntax; but Góngora, a poet of really great powers, had begun better, and as often as he is contented with *romances* he finds true poetic accents, ingenious ideas and felicitous expressions. Quevedo, much

greater in prose than in verse, displays real power only in satire, epigram and parody. There is in some of his serious pieces the stuff of a Juvenal, and his satiric and burlesque *romances*, of which several are written in slang (*germania*), are in their way little masterpieces. Another commonplace of Spanish poetry at this period was epic poetry after the style of Tasso's *Gerusalemme*. These interminable and prosaic compositions in *octavos reales* do not approach their model; none of them can even be compared in style, elevation of thought and beauty of imagery, to Camoens's *Lusiadas*. They are in reality rhymed chronicles, and consequently, when the author happens to have taken part in the events he narrates, they have a genuine historical interest. Such is the case with Alonso de Ercilla's *Araucana*, of which it may be said that it was written less with a pen than with a pike. In burlesque poetry the Spaniards have been more successful: *La Gatomaquia* of Lope de Vega, and *La Moschea* of Villaviciosa (d. 1658) are agreeable examples of witty invention.

The departments of imaginative literature in which the genius of the new Spanish nation revealed itself with most vigour and originality are the *novela* and the **Fiction.** drama. By *novela* must be understood the novel of

manners, called *picaresca* (from *pícaro*, a rogue or "picaroon") because of the social status of the heroes of those fictions; and this type of novel is a Spanish invention. The pastoral romance, on the other hand—the best-known examples of which are the *Diana* of Jorge de Montemayor, continued by Alonso Perez and Gaspar Gil Polo, the *Galatea* of Cervantes, and the *Arcadia* of Lope de Vega—as well as the novel of adventure begun by Cervantes in his *Novelas exemplares*, and cultivated after him by a host of writers, is directly derived from Italy. The *Arcadia* of Sannazaro is the source of the *Diana* and of all its imitations, just as the Italian *novellieri* are the masters of most Spanish *novelistas* of the 17th century. The picaresque novel starts in the middle of the 16th century with the *Vida de Lazarillo de Tormes, sus fortunas y adversidades*; the impetus was given, and the success of *Lazarillo* was so great that imitators soon appeared. In 1599 Mateo Alemán published the first part of the adventures of another picaroon, Guzman de Alfarache; before he could issue the sequel (1604) he was anticipated (1602) by an unscrupulous rival, whose continuation was on a lower plane. Quite unlike that of the *Lazarillo*, the style of Mateo Alemán is eloquent, full, with long and learned periods, sometimes diffuse. Nothing could be more extravagant and more obscure than the history of Justina the beggar woman (*La Pícaro Justina*) by Francisco Lopez de Ubeda (1605), which is generally (but perhaps wrongly) said to be a name assumed by the Dominican Andrés Perez. A long series of similar tales continued to be published by writers of considerable merit (see PICARESQUE NOVEL).

By degrees the picaresque romance was combined with the novel of Italian origin and gave rise to a new type—half novel of manners, half romance of adventure—of which the characteristic example appears to be the *Marcos de Obregón* (1618) of Vicente Martínez Espinel, one of the best written works of the 17th century. To the same class belong almost all the novels of Alonso Jerónimo de Salas Barbadillo, Luiz Velez de Guevara and Francisco Santos's popular pictures of life in Madrid, *Día y noche de Madrid* (1663), *Periquillo, el de las gallineras*, &c. On the other hand, the novels of Tirso de Molina (*Los Cigarrales de Toledo*, 1624), Perez de Montalbán (*Para todos*, 1632), Maria de Zayas (*Novelas*, 1635–1647), are more in the manner of the *Novelas exemplares* of Cervantes, and consequently of the Italian type. Among the so-called historical romances one only deserves to be mentioned—the *Guerras civiles de Granada* (1595–1604) by Ginés Perez de Hita, which deals with the last years of the kingdom of Granada and the insurrection of the Moors of the Alpujarras in the time of Philip II. *Don Quixote* (1605–1615), the masterpiece of Cervantes, is too great a work to be treated with others; and, moreover, it does not fall strictly within the limits of any of the classes just mentioned. If it has to be defined, it may be described as the social romance of

16th and 17th century Spain. Cervantes undoubtedly owed much to his predecessors, notably to the few picaresque romancers who came before him, but he considerably enlarged the scope of the type and strengthened the framework of the story by a lofty moral idea. His main purpose was not so much to ridicule the books of chivalry, which were already out of fashion by his time, but to show by an example pushed to absurdity the danger of those prejudices of pure blood and nobler race with which three-fourths of the nation were imbued, and which, by the scorn of all useful labour which they involved, were destined to bring Spain to ruin. The lesson is all the more effective, as Cervantes's *hidalgo*, although ridiculous, was not put beyond the pale of the reader's sympathy, and the author condemns only the exaggeration of the chivalrous spirit, and not true courage and devotion when these virtues have a serious object. What happened to *Guzman de Alfarache* happened to *Don Quixote*. In 1614 a spurious second part of the adventures of Don Quixote made its appearance; Cervantes was thus roused from inactivity, and the following year gave to the world the true second part, which instantly eclipsed Avellaneda's imitation.

The stage in the 17th century in some measure took the place of the *romances* of the previous age; it is, as it were, the **Drama of 17th Century.** medium of all the memories, all the passions, and all the aspirations of the Spanish people. Its style, being that of the popular poetry, made it accessible to the most illiterate classes, and gave it an immense range of subject. The Bible, the lives of the martyrs, national traditions, the chronicles of Castile and Aragon, foreign histories and novels, even the daily incidents of contemporary Spanish life, the escapades and nightly brawls of students, the gallantries of the Calle Mayor and the Prado of Madrid, balcony escalades, sword-thrusts and dagger-stabs, duels and murders, fathers befooled, jealous ladies, pilfering and cowardly valets, inquisitive and sprightly waiting-maids, sly and tricky peasants, fresh country girls—all are turned to dramatic account. The enormous mass of plays with which the literature of this period is inundated may be divided into two great classes—secular and religious; the latter may be subdivided into (1) the liturgical play, *i.e.* the *auto* either *sacramental* or *al nacimiento*, and (2) the *comedia divina* or the *comedia de santos*, which has no liturgical element, and differs from a secular play only in the fact that the subject is religious and frequently, as one of the names indicates, derived from the biography of a saint. In the secular drama, classification might be carried almost to any extent if the nature of the subject be taken as the criterion. It will be sufficient to distinguish the *comedia* (*i.e.* any tragic or comic piece in three acts) according to the social types brought on the stage, the equipment of the actors, and the artifices resorted to in the representation. We have (1) the *comedia de capa y espada*, which represents everyday incident, the actors belonging to the middle class, simple *caballeros*, and consequently wearing the garb of ordinary town life, of which the chief items were the cloak and the sword; and (2) the *comedia de teatro* or *de ruido*, or again, *de tramoya* or *de apariencias* (*i.e.* the theatrical, spectacular or scenic play), which has kings and princes for its dramatis personae and makes a great display of mechanical devices and decorations. Besides the *comedia*, the classic stage has also a series of little pieces subsidiary to the play proper: the *loa*, or prologue; the *entremés*, a kind of interlude which afterwards developed into the *sainete*; the *baile*, or ballet, accompanied with singing; and the *zarzuela*, a sort of operetta thus named after the royal residence of La Zarzuela, where the kings of Spain had a theatre. As to the dramatic poets of the golden age, even more numerous than the lyric poets and the romancers, it is difficult to group them. All are more or less pupils or imitators of the great chief of the new school, Lope Felix de Vega Carpio; everything has ultimately to be brought back to him who with the Spaniards call the "monster of Nature." Among Lope's contemporaries only a few poets of Valencia—Gaspar Honorat de Aguilar (1561–1623), Francisco Tárrega, Guillen de Castro, the author of the *Mocedades del Cid* (from which Corneille derived his inspiration)—formed a small

school, as it were, somewhat less subject to the master than that of Madrid, which could only win the applause of the public by copying as exactly as possible the manner of the great initiator. Lope left his mark on all varieties of the *comedia*, but did not attain equal excellence in all. He was especially successful in the comedy of intrigue (*enredo*), of the *capa y espada* class, and in dramas whose subjects are derived from national history. His most incontestable merit is to have given the Spanish stage a range and scope of which it had not been previously thought capable, and of having taught his contemporaries to invent dramatic situations and to carry on a plot. It is true he produced little that is perfect: his prodigious fecundity and facility allowed him no time to mature his work; he wrote negligently, considered the stage an inferior department, good for the *vulgo*, and consequently did not judge it worthy of the same esteem as lyric or narrative poetry modelled on the Italians. Lope's first pupils exaggerated some of his defects, but, at the same time, each, according to his own taste, widened the scope of the *comedia*. Antonio Mira de Amescua and Luis Velez de Guevara were successful, especially in tragic histories and *comedias divinas*. Gabriel Téllez, better known under the pseudonym of Tirso de Molina, one of the most flexible, ingenious and inventive of the dramatists, displayed no less talent in the comedy of contemporary manners than in historical drama. *El Burlador de Sevilla* (*Don Juan*) is reckoned his masterpiece; but he showed himself a much greater poet in *El Vergonzoso en palacio*, *Don Gil de las Calzas Verdes* and *Marta la Piadosa*. Finally Juan Ruiz de Alarcón the most serious and most observant of Spanish dramatic poets, successfully achieved the comedy of character in *La Verdad sospechosa*, closely followed by Corneille in his *Menteur*. Most of the remaining play-writers did little but increase the number of *comedias*; they added nothing to the real elements of the drama. The second epoch of the classical drama is represented mainly by Pedro Calderón de la Barca, the Spanish dramatist who has obtained most celebrity abroad, where his pieces have been much studied and admired (perhaps extravagantly). It is Calderón who first made honour, or more correctly the point of honour, an essential motive in the conduct of his personages (*e.g.* *El Médico de su honra*); it is he also who made the *comedia de capa y espada* uniform even to monotony, and gave the comic "part" of the *gracioso* (confidential valet of the *caballero*) a rigidity which it never previously possessed. There is depth and poetry in Calderón, but also vagueness and bad taste. His most philosophic drama, *La Vida es sueño*, is a bold and sublime idea, but indistinct and feebly worked out; his *autos sacramentales* give evidence of extensive theological knowledge and dexterity in dramatizing abstractions. Calderón was imitated, as Lope had been, by exaggerating his manner and perverting his excellences. Two contemporaries deserve to be cited along with him—Francisco de Rojas Zorrilla, author of the fine historic play *Del Rey abajo ninguno*, and Augustín Moreto, author of some pleasant comedies. Among those who worked in a less ambitious vein, mention must be made of Luis Quiñones de Benavente, a skilful writer of *entremeses*.

A new manner of writing appears with the revival of learning; the purely objective style of the old chroniclers, accumulating one fact after another, without showing the logical connexion or expressing any opinion on men or things, began to be thought puerile. An attempt was made to treat the history of Spain in the manner of Livy, Sallust, and Tacitus, whose methods of narration were directly adopted. The 16th century, however, still presents certain chroniclers of the medieval type, with more erudition, precision and the promise of a critical faculty. *La Crónica general de España*, by Ambrosio de Morales; the *Compendio historial* of Estéban de Garibay; and the *Historia general de las Indias occidentales*, by Antonio de Herrera, are, so far as style is concerned, continuations of the last chronicles of Castile. Jerónimo de Zurita is emphatically a scholar; no one in the 16th century knew as he did how to turn to account documents and records for the purpose of completing and correcting the narratives of the

ancient chronicles; his *Anales de la corona de Aragón* is a book of great value, though written in a laboured style. With Juan de Mariana history ceases to be a mere compilation of facts or a work of pure erudition, and becomes a work of art. The *Historia de España* by the celebrated Jesuit, first written in Latin (1592) in the interest especially of foreigners, was afterwards rendered by its author into excellent Castilian; as a general survey of its history, well planned, well written and well thought out, Spain possesses nothing that can be compared with it. Various works of less extent—accounts of more or less important episodes in the history of Spain—may take their place beside Mariana's great monument: for example, the *Guerra de Granada*, by Diego Hurtado de Mendoza (a history of the revolt of the Moors of the Alpujarras under Philip II.), written about 1572, immediately after the events, but not published till 1627; the narrative of the expedition of the Catalans in the Morea in the 14th century, by Francisco de Moncada (d. 1635); that of the revolt of the same Catalans during the reign of Philip IV., by Francisco Manuel de Mello, a Portuguese by birth; and that of the conquest of Mexico by Antonio de Solís. Each of these writers was more or less inspired by some Latin author, one preferring Livy, another Sallust, &c. Most of these imitations are somewhat stilted, and their artificiality in the long run proves as fatiguing as the heaviness of the medieval chroniclers. On the other hand, the historians of the wars of Flanders, such as Carlos Coloma, Bernardino de Mendoza, Alonso Vazquez and Francisco Verdugo, are less refined, and for that very reason are more vivid and more capable of interesting us in the struggle of two races so foreign to each other and of such different genius. As for the accounts of the transatlantic discoveries and conquests, they are of two kinds—either (1) memoirs of the actors or witnesses of those great dramas, as, e.g. the *Historia verdadera de la conquista de la nueva España*, by Bernal Diaz del Castillo (1492-1581), one of the companions of Cortés, and the *Historia de las Indias*, by Bartolomé de las Casas, the apostle of the Indians; or (2) works by professional writers, such as Francisco Lopez de Gómara, official historiographers who wrote in Spain on information sent to them from the newly-discovered lands.

Letter writers, a rather numerous body in Spanish literature, are nearly related to the historians; in fact, letters written to be read by others than the persons addressed, or in any case revised afterwards, are only a method of writing history in a familiar style. Fernando del Pulgar appended to his *Claros varones* a series of letters on the affairs of his time; and in the 16th century Antonio de Guevara (d. 1544) collected, under the title of *Epistolas familiares*, his correspondence with his contemporaries, which throws a great light on the early part of the reign of Charles V., although it must be used with caution because of the numerous recasts it has undergone. A celebrated victim of Philip II., Antonio Perez (d. 1611), revenged himself on his master by relating in innumerable letters, addressed during his exile to his friends and protectors, all the incidents of his disgrace, and by selling to the ministers of France and England the secrets of the Spanish policy in which he had a hand; some of these letters are perfect specimens of urbane gallantry.

Philosophy is rather poorly represented in the 16th and 17th centuries in the literature of the vernacular. The greater number of the Spanish thinkers of this epoch, whatever the school to which they belonged—scholastic, Platonic, Aristotelian or independent—wrote in Latin. Ascetic and mystical authors alone made use of the vulgar tongue for the readier diffusion of their doctrine among the illiterate, from whose ranks many of their disciples were recruited. Luis de Granada (1504-1588), Luis Ponce de León (1528-1598), Teresa de Jesús (1515-1582), Pedro Malón de Chaide and St John of the Cross are the brighter lights of this class of writers. Some of their books, like the *Guía de pecadores* of Luis de Granada, the autobiography of St Theresa, and Malón de Chaide's *Conversion of the Magdalen* (1588), have obtained a lasting

success beyond the limits of the Peninsula, and have influenced the development of mysticism in France. The Spanish mystics are not only remarkable for the depth or subtlety of their thoughts and the intensity of the divine love with which they are inspired; many of them are masters of style, and some, like St John of the Cross, have composed verses which rank with the most sublime in the language. A notable fact is that those who are regarded as illuminati profess the most practical ideas in the matter of morality. Nothing is more sensible, nothing less ecstatic, than the manual of domestic economy by Luis de León—*La Perfecta casada*. Lay moralists are numerous in the 16th and 17th centuries. Some write long and heavy treatises on the art of governing, the education of princes, the duties of subjects, &c. Pedro Fernandez de Navarrete's *Conservación de monarquias*, Diego de Saavedra Fajardo's *Idea de un príncipe cristiano*, Quevedo's *La Política de Dios y gobierno de Cristo*, give a correct idea of the ability which the Spaniards have displayed in this kind of didactic literature—ability of no high order, for the Spaniard, when he means to expound a doctrine, loses himself in distinctions and easily becomes diffuse, pedantic and obscure. But there is a kind of morality in which he indubitably excels, namely, in social satire, which, under all its forms—dialogue and dream in the style of Lucian, epistle after the manner of Juvenal, or pamphlet—has produced several masterpieces and a host of ingenious, caustic and amusing compositions. Juan de Valdés (d. 1541), the most celebrated of the Spanish Protestants, led the way with his *Diálogo de Mercurio y Carón*, where the great political and religious questions of the first half of the 16th century are discussed with admirable vigour and freedom. The most eminent author in the department of social satire, as in those of literary and political satire, is Quevedo. Nothing escapes his scrutinizing spirit and pitiless irony. All the vices of contemporary society are remorselessly pilloried and cruelly dissected in his *Sueños* and other short works. While this great satirist, in philosophy a disciple of Seneca, imitates his master even in his diction, he is none the less one of the most vigorous and original writers of the 17th century. The only serious defect in his style is that it is too full, not of figures and epithets, but of thoughts. His phrases are of set purpose charged with a double meaning, and we are never sure on reading whether we have grasped all that the author meant to convey. *Conceptism* is the name that has been given to this refinement of thought, which was doomed in time to fall into ambiguity; it must not be confounded with the *cullism* of Góngora, the artifice of which lies solely in the choice and arrangement of words. This new school, of which Quevedo may be regarded as the founder, had its Boileau in the person of Baltasar Gracián, who published his *Agudeza y arte de ingenio* (1642), in which all the subtleties of conceptism are reduced to an exact code. Gracián, who had the gift of sententious moralizing rather than of satire, produced in his *Crítica* animated pictures of the society of his own day, while he also displayed much ingenuity in collections of political and moral aphorisms which have won him a great reputation abroad.

Spanish thought as well as public spirit and all other forms of national activity began to decline towards the close of the 17th century. The advent of the house of Bourbon, and the increasing invasion of French influence in the domain of politics as well as in literature and science, frustrated the efforts of a few writers who had remained faithful to the pure Spanish tradition. In the hands of the second-rate imitators of Calderón the stage sank lower and lower; lyric poetry, already compromised by the affected diction of Góngora, was abandoned to rhymesters who tried to make up by extravagance of style for poverty of thought. The first symptoms, not of a revival, but of a certain resumption of intellectual production, appear in the department of linguistic study. In 1714 there was created, on the model of the French academies, La Real Academia Española, intended to maintain the purity of the language and to correct its abuses. This academy set itself at once to work, and in 1726 began the

publication of its dictionary in six folio volumes, the best title of this association to the gratitude of men of letters. The *Gramática de la lengua castellana*, drawn up by the academy, did not appear till 1771. For the new ideas which were introduced into Spain as the result of more intimate relations with France, and which were in many cases repugnant to a nation for two centuries accustomed to live a self-contained life, it was necessary that authoritative sanction should be found. Ignacio de Luzán, well read in the literatures of Italy and France, a disciple of Boileau and the French rhetoricians, yet not without some originality of his own, undertook in his *Poética* (1737) to expound to his fellow countrymen the rules of the new school, and, above all, the principle of the famous "unities" accepted by the French stage from Corneille's day onward. What Luzán had done for letters, Benito Fejoo, a Benedictine of good sense and great learning, did for the sciences. His *Teatro crítico* and *Cartas erúditas y curiosas*, collections of dissertations in almost every department of human knowledge, introduced the Spaniards to the leading scientific discoveries of foreign countries, and helped to deliver them from many superstitions and absurd prejudices. The study of the ancient classics and the department of learned research in the domain of national histories and literatures had an eminent representative in Gregorio Mayáns y Siscar (1699-1781), who worthily carried on the great traditions of the Renaissance; besides publishing good editions of old Spanish authors, he gave to the world in 1757 a *Retórica* which is still worth consulting, and a number of learned memoirs. What may be called the *littérature d'agrément* did not recover much lost ground; it would seem as if the vein had been exhausted. Something of the old picaresque novel came to life again in the *Fray Gerundio* of the Jesuit Isla, a

Romance. biographical romance which is also and above all—to the detriment, it is true, of the interest of the narrative—a satire on the follies of the preachers of the day. The lyric poetry of this period is colourless when compared with its variegated splendour in the preceding century. Nevertheless

Poetry. one or two poets can be named who possessed refinement of taste, and whose collections of verse at least show respect for the language. At the head of the new school is Menéndez Valdés, and with him are associated Diego González (1733-1794), José Iglesias de la Casa (1748-1791), known by his *letrillas*, Cienfuegos, and some others. Among the verse writers of the 18th century who produced odes and didactic poetry it is only necessary to mention Leandro Fernández de Moratín and Quintana, but the latter belongs rather to the 19th century, during the early part of which he published his most important works. The poverty of the period in lyric poetry is even exceeded by that of the stage. No kind of comedy or tragical drama arose to take the place of the ancient *comedia*, whose platitudes and absurdities of thought and expression had ended by disgusting even the least exacting portion of the public. The attempt was indeed made to introduce the comedy and the tragedy of France, but the stiff and pedantic adaptations of such writers as the elder Moratín, Agustín de Montiano y Luyando (1697-1764), Tomás de Iriarte, García de la Huerta and the well-known economist Gaspar de Jovellanos failed to interest the great mass of playgoers. The only dramatist who was really successful in composing on the French pattern some pleasant comedies, which owe much of their charm to the great purity of the language in which they are written, is Leandro Fernández de Moratín. It has to be added that the *saineté* was cultivated in the 18th century by one writer of genuine talent, Ramón de la Cruz; nothing helps us better to an acquaintance with the curious Spanish society of the reign of Charles IV. than the interludes of this genial and light-hearted author, who was succeeded by Juan Ignacio González del Castillo.

The struggle of the War of Independence (1808-14), which was destined to have such important consequences in the

19th Century. world of politics, exerted no immediate influence on the literature of Spain. One might have expected as a consequence of the rising of the whole nation against

Napoleon that Spanish writers would no longer seek their inspiration from France, and would resume the national traditions which had been broken at the end of the 17th century. But nothing of the sort occurred. Not only the *afrancesados* (as those were called who had accepted the new régime), but also the most ardent partisans of the patriotic cause, continued in literature to be the submissive disciples of France. Quintana, who in his odes preached to his compatriots the duty of resistance, has nothing of the innovator about him; by his education and by his literary doctrines he remains a man of the 18th century. The same may be said of Martínez de la Rosa, who, though less powerful and impressive, had a greater independence of spirit and a more highly trained and classical taste. And when romanticism begins to find its way into Spain and to enter into conflict with the spirit and habits of the 18th century, it is still to France that the poets and prose writers of the new school turn, much more than to England or to Germany. The first decidedly romantic poet of the generation which flourished about 1830 was the duke of Rivas; no one succeeded better in reconciling the genius of Spain and the tendencies of modern poetry; his poem *El Moro expósito* and his drama of *Don Alvaro ó la fuerza del sino* belong as much to the old romances and old theatre of Spain as to the romantic spirit of 1830. On the other hand, Espronceda, who has sometimes been called the Spanish Musset, savours much less of the soil than the duke of Rivas; he is a cosmopolitan romantic of the school of Byron and the French imitators of Byron; an exclusively lyric poet, he did not live long enough to give full proof of his genius, but what he has left is often exquisite. Zorilla has a more flexible and exuberant, but much more unequal, talent than Espronceda, and if the latter has written too little it cannot but be regretted that the former should have produced too much; nevertheless, among a multitude of hasty performances, brought out before they had been matured, his *Don Juan Tenorio*, a new and fantastic version of the legend treated by Tirso de Molina and Molière, will remain as one of the most curious specimens of Spanish romanticism. In the dramatic literature of this period it is noticeable that the tragedy more than the comedy is modelled on the examples furnished by the French drama of the Restoration; thus, if we leave out of account the play by García Gutiérrez, entitled *El Trovador*, which inspired Verdi's well-known opera, and *Los Amantes de Teruel*, by Hartzbusch, and a few others, all the dramatic work belonging to this date recalls more or less the manner of the professional playwrights of the boulevard theatres, while on the other hand the comedy of manners still preserves a certain originality and a genuine local colour. Bretón de los Herreros, who wrote a hundred comedies or more, some of them of the first order in their kind, apart from the fact that their diction is of remarkable excellence, adheres with great fidelity to the tradition of the 17th century; he is the last of the dramatists who preserved the feeling of the ancient *comedia*. Mariano José de Larra, a prose writer of the highest talent, must be placed beside Espronceda, with whom he has several features in common. Caustic in temper, of a keenly observant spirit, remarkably sober and clear as a writer, he was specially successful in the political pamphlet, the *article d'actualité*, in which he ridicules without pity the vices and oddities of his contemporaries; his reputation is much more largely due to these letters than either to his plays or his novel *El Doncel de Don Enrique el Doliente*. With Larra must be associated two other humoristic writers. The first of these is Mesonero Romanos, whose *Escenas matritenses*, although of less literary value than Larra's articles, give pleasure by their good-natured gaiety and by the curious details they furnish with regard to the contemporary society of Madrid. The other is Estébanez Calderon, who in his *Escenas andaluzas* sought to revive the manner of the satirical and picaresque writers of the 17th century; in a uselessly archaic language of his own, tessellated with fragments taken from Cervantes, Quevedo and others, he has delineated with a somewhat artificial grace various piquant scenes of Andalusian or Madrid life. The most prominent literary critics belonging to the first generation of the

century were Alberto Lista (1775-1848), whose critical doctrine may be described as a compromise between the ideas of French classicism and those of the romantic school, and Agustín Durán, who made it his special task to restore to honour the old literature of Castile, particularly its *romances*, which he had studied with ardour, and of which he published highly esteemed collections.

If the struggle between classicists and romanticists continued even after 1830, and continued to divide the literary world into two opposing camps, the new generation—that which occupied the scene from 1840 till about 1868—had other pre-occupations. The triumph of the new ideas was assured; what was now being aimed at was the creation of a new literature which should be truly national and no longer a mere echo of that beyond the Pyrenees. To the question whether modern Spain has succeeded in calling into existence such a literature, we may well hesitate to give an affirmative answer. It is true that in every species of composition, the gravest as well as the lightest, it can show works of genuine talent; but many of them are strikingly deficient in originality; all of them either bear unmistakable traces of imitation of foreign models, or show (more or less happily) the imprint of the older literature of the 17th century, to which the historical criticism of Durán and the labours of various other scholars had given a flavour of novelty.

Foreign influence is most clearly marked in the work of Ventura de la Vega (1807-1865), whose relationship to the younger Moratín, and therefore to Molière, is unmistakable in *El Hombre de mundo* (1845), a piece written after a long apprenticeship spent in translating French plays. Among those who endeavoured to revive the dramatic system established by Lope de Vega were Aureliano Fernández-Guerra y Orbe (1816-1894) and Francisco Sánchez de Castro (d. 1878); the former in *Alonso Cano*, and the latter in *Hermenegildo*, produced examples of ingenious reconstruction, which testified to their scholarship but failed to interest the public permanently. A fusion of early and later methods is discernible in the plays of Adelardo López de Ayala and Tamayo y Baus. Campoamor wrote dramas which, though curious as expressions of a subtle intelligence cast in the form of dialogue, do not lend themselves to presentation, and were probably not intended for the stage. Núñez de Arce in *El Haz de leña* produced an impressive drama, as well as several plays written in collaboration with Antonio de Hurtado, before he found his true vocation as a lyric poet. The successor of Tamayo y Baus in popular esteem must be sought in José Echegaray, whose earlier plays—such as *La Esposa del vengador* and *En el puño de la espada*—are in the romantic style; in his later works he attempts the solution of social problems or the symbolic drama. Such pieces as *El Gran Galesto*, *El Hijo de Don Juan* and *El Loco dios* indicate a careful study of the younger Dumas and Ibsen. During the last few years his popularity has shown signs of waning, and the copious dramatist has translated from the Catalan at least one play by Angel Guimerá (b. 1847). To Echegaray's school belong Eugenio Sellés (b. 1844), author of *El Nudo gordiano*, *El Cielo ó el suelo* and *La Mujer de Loth*, and Leopoldo Cano y Masas (b. 1844), whose best productions are *La Mariposa*, *Gloria* and *La Pasión-aria*, an admirable example of concise and pointed dialogue. Mention must also be made of José Felfu y Codina (1843-1897), a Catalan who wrote two vigorous plays entitled *La Dolores* and *Morla del Carmen*; Joaquín Dicenta (b. 1860), whose *Juan José* showed daring talent; and especially Jacinto Benavente (b. 1866), a dramatist whose mordant vigour and knowledge of stage-effect is manifest in *La Comida de las fieras* and *Rosas de otoño*. In a lighter vein much success has attended the efforts of Miguel Echegaray (b. 1848), whose buoyant humour is in quaint contrast with his brother's sepulchral gloom, and Vital Aza (b. 1851) and Ricardo de la Vega (b. 1858) deserve the popularity which they have won, the first by *El Señor Cura* and the second by *Pepa la frescachona*, excellent specimens of humorous contrivance. But the most promising writers for the Spanish stage at the present time are Serafín Alvarez Quintero (b. 1871) and his brother Joaquín (b. 1873), to

whose collaboration are due *El Ojito derecho* and *Abanicos y panderetes*, scenes of brilliant fantasy which continue the tradition of witty observation begun by Lope de Rueda.

Rivas, Espronceda and Zorrilla owe more to foreign models than either Campoamor or Núñez de Arce. It is true that Campoamor has been described, most frequently by foreign critics, as a disciple of Heine, and undoubtedly Campoamor suggests to cosmopolitan readers something of Heine's concentrated pathos; but he has nothing of Heine's acrimony, and in fact continued in his own semi-philosophic fashion a national tradition of immemorial antiquity—the tradition of expressing lyrical emotion in four or eight lines which finds its most homely manifestation in the five volumes of *Cantos populares españoles* edited by Francisco Rodríguez Marín. No less national a poet was Núñez de Arce, in whose verses, though the sentiment and reflection are often commonplace, the workmanship is of irreproachable finish. His best performance is *Gritos del combate* (1875), a series of impassioned exhortations to concord issued during the civil war which preceded the restoration of the Bourbon dynasty. An ineffectual politician, Núñez de Arce failed in oratory, but produced a permanent political impression with a small volume of songs. He wrote much in the ensuing years, and though he never failed to show himself a true poet he never succeeded in repeating his first great triumph—perhaps because it needed a great national crisis to call forth his powers. He found an accomplished follower in Emilio Pérez Ferrari (b. 1853), whose *Pedro Abelardo* and *Dos cetros y dos almas* recall the dignity but not the impeccability of his model. Another pupil in the same school was José Velarde (d. 1892), whose best work is collected in *Voces del alma*, some numbers of which are indications of a dainty and interesting, if not virile, talent. Absorbed by commerce, Vicente Wenceslao Querol (d. 1889) could not afford to improvise in the exuberant manner of his countrymen, and is represented by a single volume of poems as remarkable for their self-restraint as for a deep tenderness which finds expression in the *Cartas á María* and in the poignant stanzas *A la muerte de mi hermana Adela*. The temptation to sound the pathetic note so thrillingly audible in Querol's subdued harmonies proved irresistible to Federico Balart (1831-1905), a critic and humorist of repute who late in life astonished and moved the public with a volume of verse entitled *Dolores*, a sequence of elegiacs which bear a slight formal resemblance to *In Memoriam*; but the writer's sincerity was doubtful, and in *Horizontes* the absence of genuine feeling degenerated into fluent fancy and agreeable prettiness. A more powerful and interesting personality was Joaquín María Bartrina (1850-1880), who endeavoured to transplant the pessimistic spirit of Leconte de Lisle to Spanish soil. Bartrina's crude materialism is antipathetic; he is wholly wanting in the stately impassability of his exemplar, and his form is defective; but he has force, sincerity and courage, and the best verses in *Algo* (1876) are not easily forgotten. The *Andantes y allegros* and *Cromos y acuarelas* of Manuel Reina (1856-1905) have a delightful Andalusian effusiveness and metrical elegance, which compensate for some monotony and shallowness of thought. Manuel del Palacio (1832-1907) combined imagination and wit with a technical skill equal to that of the French Parnassians; but he frittered away his various gifts, so that but a few sonnets survive out of his innumerable poems. More akin to the English "Lake poets" was Amós de Escalante y Prieto (1831-1902), better known by his pseudonym of "Juan García," whose faculty of poetic description, revealed only to the few who had read his verses in the edition privately circulated in 1890, is now generally recognized. The vein of religious sentiment which runs through Escalante's most characteristic lyrics was also worked by Luis Ramírez Martínez y Guertero (d. 1874), who, under the pseudonym of "Larmig," wrote verses impregnated with Christian devotion as well as with a sinister melancholy which finally led him to commit suicide. The most interesting of the younger poets are provincials by sympathy or residence, if not by birth. Salvador Rueda (b. 1857), in his

Aires españoles, represents the vivid colouring and resonant emphasis of Andalusia; Ramon Domingo Perés (b. 1863), a Cuban by birth but domiciled at Barcelona, strikes a Catalan note in *Musgo* (1902), and substitutes restraint and simplicity for the Castilian sonority and pomp; Vicente Medina (b. 1866) in *Aires murcianos* and *La Canción de la huerta* reproduces with vivid intensity the atmosphere of the Murcian orchard-country; Juan Alcover and Miguel Costa, both natives of Majorca, celebrate their island scenery with luminous picturesqueness of phrase. The roll of Spanish poets may close with the name of José María Gabriel y Galán (d. 1905), whose reputation depends chiefly on the verses entitled "El Ama" in *Castellanas*; Gabriel y Galán was extremely unequal, and his range of subjects was limited, but in *El Ama* he produced a poem which is unsurpassed in modern Spanish poetry. The facility with which verses of a kind can be written in Spanish has made Spain a nest of singing-birds; but the chief names have been already mentioned, and no others need be recorded here.

Since 1850 there has been a notable renaissance of the Spanish novel. Fernán Caballero is entitled to an honourable place in

Fiction.

literary history as perhaps the first to revive the native realism which was temporarily checked by the romantic movement. In all that concerns truth and art she is superior to the once popular Manuel Fernández y González (d. 1888), of whom it has been said that Spain should erect a statue to him and should burn his novels at the foot of it. A Spanish Dumas, he equals the French author in fecundity, invention and resource, and some of his tales—such as *El Cocinero de su majestad*, *Los Minfies de las Alpujarras* and *Martín Gil*—are written with an irresistible brio; but he was the victim of his own facility, grew more and more reckless in his methods of composition, and at last sank to the level of his imitators. Antonio de Trueba followed Fernán Caballero in observing local customs and in poetizing them with a sentimental grace of his own, which attracted local patriots and uncritical readers generally. He had no gift of delineating character, and his plots are feeble; but he was not wanting in literary charm, and went his road of incorrigible optimism amid the applause of the crowd. His contemporary, Pedro Antonio de Alarcón, is remembered chiefly as the author of *El Sombrero de tres picos*, a peculiarly Spanish tale of picaresque malice. Neither Trueba nor Alarcón could have developed into great artists; the first is too falsetto, the second is too rhetorical, and both are too haphazard in execution. Idealizing country life into a pale arcadian idyll, Trueba frowned upon one of his neighbours whose methods were eminently realistic. José María de Pereda is the founder of the modern school of realistic fiction in Spain, and the boldness of his experiment startled a generation of readers accustomed to Fernán Caballero's feminine reticence and Trueba's deliberate conventionality. Moreover, Pereda's reactionary political views—too frequently obtruded in his imaginative work—alienated from him the sympathies of the growing Liberal element in the country; but the power which stamps his *Escenas montañesas* was at once appreciated in the northern provinces, and by slow degrees he imposed himself upon the academic critics of Madrid. So long as Pereda deals with country folk, sailors, fishermen, aspects of sea and land, he deserves the highest praise, for he understands the poor, hits upon the mean between conventional portraiture and caricature, and had the keenest appreciation of natural beauty. His hand was far less certain in describing townsmen; yet it is a mistake to class him as merely a successful landscape painter, for he created character, and continually revealed points of novelty in his descriptions of the common things of life. Pereda is realistic, and he is real. His rival, Juan Valera, is not, in the restricted sense of the word, realistic, but he is no less real in his own wider province; he has neither Pereda's energy nor austerity of purpose, but has a more infallible tact, a larger experience of men and women, and his sceptical raillery is as effective a moral commentary as Pereda's Christian pessimism. In Valera's *Pepita Jiménez* and *Doña Luz*, and in Pereda's *Sotileza*, we have a trio of Spanish heroines who deserve their fame: Pereda's is the more vigorous, full-

blooded talent, as Valera's is the more seductive and patrician; yet, much as they differ, both are essentially native in the quality of their genius, system and phrasing. Benito Pérez Galdós gave a new life to the historical novel in his huge series entitled *Episodios nacionales*, a name perhaps suggested by the *Romans nationaux* of Erckmann-Chatrian; but the subjects and sentiment of these forty volumes are intensely local. The colouring of the *Episodios nacionales* is so brilliant, their incident is so varied and so full of interest, their spirit so stirring and patriotic, that the born Spaniard easily forgives their frequent prolixity, their insistence on minute details, their loose construction and their uneven style. Their appeal is irresistible; there is no such unanimous approbation of the politico-religious novels such as *Doña Perfecta*, *Gloria* and *León Roch*, each of which may be regarded as a *roman à thèse*. The quick response of Pérez Galdós to any external stimulus, his sensitiveness to every change in the literary atmosphere, made it inevitable that he should come under the influence of French naturalism, as he does in *Lo Prohibido* and in *Realidad*; but his conversion was temporary, and two forcible novels dealing with contemporary life—*Fortunata y Jacinta* and *Angel Guerra*—mark the third place in the development of a susceptible talent. The true leader of the naturalistic school in Spain is Armando Palacio Valdés, whose faculty of artistic selection was first displayed in *El Señorito Octavio*. Two subsequent works—*Marta y María* and *La Hermana San Sulpicio*—raised hopes that Spain had, in Palacio Valdés, a novelist of the first order to succeed Pereda and Valera; but in *La Espuma* and *La Fe*, two social studies which caused all the more sensation because they contained caricatures of well-known personages, the author followed the French current, ceased to be national and did not become cosmopolitan. His latest books are more original and interesting, though they scarcely fulfil his early promise. Another novelist who for a time divided honours with Palacio Valdés was the lady who publishes under her maiden name of Emilia Pardo Bazán. The powerful, repellent pictures of peasant life and the ethical darning of *Los Pazos de Ulloa* and *La Madre Naturaleza* are set off by graphic passages of description; in later works the author chose less questionable subjects, and the local patriotism which inspires *Insolación* and *De mi tierra* is expressed in a style which secures Emilia Pardo Bazán a high place among her contemporaries. Leopoldo Alas (1851-1901), who used the pseudonym of "Clarín," was better known as a ruthless critic than as a novelist; the interest of his shorter stories has evaporated, but his ambitious novel, *La Regenta*, lives as an original study of the relation between mysticism and passion. Jacinto Octavio Picón (b. 1852), who has deserted novel writing for criticism, displayed much insight in *Lázaro*, the story of a priest who finds himself forced to lay down his orders; this work was naturally denounced by the clerical party, and orthodoxy declared equally against *El Enemigo* and *Dulce y sabrosa*; more impartial critics agree in admiring Picón's power of awakening sympathy and interest, his gift of minute psychological analysis and his exquisite diction. No suspicion of heterodoxy attaches to Manuel Polo y Peyrolón, the author of that charming story *La Tía Levítico*, nor to the Jesuit-Luis Coloma (b. 1851), who obtained a fleeting triumph with *Pequeñeces*, in which the writer satirized the fashionable society of which he had been an ornament before his conversion. Juan Ochoa (d. 1899) showed promise of the highest order in his two short stories, *El Amado discípulo* and *Un alma de Dios* and Angel Ganivet (d. 1898) produced in *Los Trabajos del infatigable creador Pio Cid*, a singular philosophical romance, rich in ideas and felicitous in expression, though lacking in narrative interest. With him may be mentioned Ricardo Macías Picavea (d. 1899), author of *La Tierra de campos*, who died prematurely before his undoubted talent had reached maturity. Of the younger novelists the most notable in reputation and achievement is Vicente Blasco Ibáñez (b. 1866) who began with pictures of Valencian provincial life in *Flor de mayo*, made romance the vehicle of revolutionary propaganda in *La Catedral* and *La Horda*, and shows the influence of Zola in one of his latest books, *La Maja desnuda*. Blasco Ibáñez lacks taste and

judgment, and occasional provincialisms disfigure his style; but his power is undeniable, and even his shorter tales are remarkable examples of truthful impressionism. Ramón del Valle-Inclán (b. 1869) tends to preciosity in *Corte de amor* and *Flor de santidad*, but excels in finesse and patient observation; J. Martínez Ruiz (b. 1876) is wittier and weightier in *Las Confesiones de un pequeño filósofo* and the other stories which he publishes under the pseudonym of "Azorín," but he lacks much of Valle-Inclán's picturesque and perceptive faculty; Pío Baroja's restless and picaresque talent finds vigorous but incoherent expression in *El Camino de perfección* and *Aurora roja*, and Gregorio Martínez Sierra (b. 1882) has shown considerable mastery of the difficulties of the short story in *Pascua florida* and *Sol de la tarde*.

The tendency of Spanish historical students is rather to collect the raw material of history than to write history. Antonio Cánovas del Castillo was absorbed by politics to the loss of literature, for his *Ensayo sobre la casa de Austria en España* is ample in information and impartial in judgment; the composition is hasty and the style is often ponderous, but many passages denote a genuine literary faculty, which the author was prevented from developing. The *Historia de los Visigodos*, in which Aureliano Fernández-Guerra y Orbe collaborated with Eduardo de Hinojosa, illuminates an obscure but important period. Francisco Cárdenas (1816-1898) in his *Historia de la propiedad territorial en España* did for Spain much that Maine did for England. Eduardo Pérez Pujol (b. 1830) in his *Historia de las instituciones de la España goda* (1896) supplements the work of Fernández-Guerra and Hinojosa, the latter of whom has published a standard treatise entitled *Historia del derecho romano*. Joaquín Costa's *Estudios ibéricos* (1891) and *Colectivismo agrario en España* (1898) have been praised by experts for their minute research and exact erudition; but his *Poesía popular española y mitología y literatura cello-hispanas*, in which a most ingenious attempt is made to reconstitute the literary history of a remote period, appeals to a wider circle of educated readers. The monographs of Francisco Codera y Zaidín (b. 1836), of Cesáreo Fernández Duro (1830-1907), of Francisco Fernández y González (b. 1833), of Gumersindo Azcárate (b. 1840), and of many others, such as the Jesuit epigraphist Fidel Fita y Calomé, are valuable contributions to the still unwritten history of Spain, but are addressed chiefly to specialists. Many of the results of these investigators are embodied in Rafael Altamira y Crevea (b. 1866) in his *Historia de España y de la civilización española*, now in progress. Literary criticism in Spain, even more than elsewhere, is too often infected by intolerant party spirit. It was difficult for Leopoldo Alas ("Clarín") to recognize any merit in the work of a reactionary writer, but his prejudice was too manifest to mislead, and his intelligent insight frequently led him to do justice in spite of his prepossessions. In the opposite camp Antonio Valbuena, a humorist of the mordant type, has still more difficulty in doing justice to any writer who is an academician, an American or a Liberal. Pascual de Gayangos y Arce and Manuel Milá y Fontanals escaped from the quarrels of contemporary schools by confining their studies to the past, and Marcelino Menéndez y Pelayo has earned a European reputation in the same province of historical criticism. Among his followers who have attained distinction it must suffice to mention Ramón Menéndez Pidal (b. 1869), author of *La Leyenda de los infantes de Lara* (1897), a brilliant piece of scientific, reconstructive criticism; Francisco Rodríguez Marín (b. 1855), who has published valuable studies on 16th and 17th century authors, and adds to his gifts as an investigator the charm of an alembicated, archaic style; Emilio Cotarelo y Mori (b. 1858), who, besides interesting contributions to the history of the theatre, has written substantial monographs on Enrique de Villena, Villamediana, Tirso de Molina, Iriarte and Ramón de la Cruz; and Adolfo Bonilla y San Martín (b. 1875), whose elaborate biography of Juan Luis Vives, which is a capital chapter on the history of Spanish humanism, gives him a foremost place among the scholars of the younger generation.

BIBLIOGRAPHY.—The basis of study is Nicolás Antonio's *Bibliotheca hispana vetus* and *Bibliotheca hispana nova*, in the revised edition of Francisco Pérez Bayer (4 vols., Madrid, 1788). Supplementary to this are Bartolomé José Gallardo's *Ensayo de una biblioteca española de libros raros y curiosos* (4 vols., Madrid, 1863-1889), edited by M. R. Zarco del Valle and José Sancho Rayón; Pedro Salvá y Mallén's *Catálogo de la biblioteca de Salvá* (2 vols., Valencia, 1872); James Lyman Whitney's *Catalogue of the Spanish Library and of the Portuguese Books bequeathed by George Ticknor to the Boston Public Library* (Boston, 1879); Domingo García Peres, *Catálogo de los autores portugueses que escribieron en castellano* (Madrid, 1890). For incunables the best authority is Conrado Haebler, *Bibliografía ibérica del siglo xv.* (the Hague and Leipzig, 1904). Of general histories the most extensive is George Ticknor's *History of Spanish Literature* (3 vols., New York, 1849, and 6th ed., 3 vols., Boston, 1872), which is particularly valuable as regards bibliography; additional information is embodied in the German translation of this work by N. H. Julius (2 vols., Leipzig, 1852) and the supplement by F. J. Wolf (1867); and the Spanish translation by Pascual de Gayangos and Enrique de Vedia (4 vols., Madrid, 1851-1856) may be consulted with profit. On a smaller scale are G. Baist, *Die spanische Litteratur* (Strasburg, 1897) in the second volume of the *Grundriss der romanischen Philologie* (pt. ii.), H. Butler Clarke, *Spanish Literature* (London, 1893); Rudolph Beer, *Spanische Literaturgeschichte* (Leipzig, 1903); Philipp August Becker, *Geschichte der spanischen Literatur* (Strasburg, 1904). The three last-named include modern authors, as do E. Mérimée, *Précis d'histoire de la littérature espagnole* (Paris, 1908) and J. Fitzmaurice-Kelly, *History of Spanish Literature* (London, 1898; Spanish translation, Madrid, 1901, and French translation, with a revised text and serviceable bibliography). For the middle ages the best works are F. J. Wolf, *Studien zur Geschichte der spanischen und portugiesischen Nationalliteratur* (Berlin, 1859), and M. Milá y Fontanals, *De la Poesía heroica-popular castellana* (Barcelona, 1874). José Amador de los Ríos, *Historia crítica de la literatura española* (7 vols., Madrid, 1861-1865), is diffusive and inaccurate, but gives useful information concerning the period before the 16th century. On the drama the most solid works are Cayetano Alberto de la Barrera y Leirado, *Catálogo bibliográfico y biográfico del teatro antiguo español* (Madrid, 1860); A. Paz y Mélia, *Catálogo de las piezas de teatro que se conservan en el departamento de manuscritos de la biblioteca nacional* (Madrid, 1899); C. Pérez Pastor, *Nuevos datos acerca del histrionismo español en los siglos xvi. y xvii.* (Madrid, 1901); José Sánchez-Arjona, *Noticias referentes a los anales del teatro en Sevilla* (Seville, 1898); Antonio Restori, "La Collezione della biblioteca palatina-parmense," in *Studj di filologia romanza*, fasc. 15 (Rome, 1891); E. Cotarelo y Mori, *Controversias sobre la licitud del teatro en España* (Madrid, 1904). Adolf Friedrich von Schack, *Geschichte der dramatischen Literatur und Kunst in Spanien* (Frankfort-on-Main, 1846-1854), a valuable work when published and still to be read with pleasure, is now out of date, and is not improved in the Spanish translation by Eduardo de Mier; it is in course of being superseded by Wilhelm Creizenach's *Geschichte des neueren Dramas*, of which three volumes have already appeared (Halle, 1893-1903). Two fluent and agreeable works on the subject are Adolf Schaeffer, *Geschichte des spanischen Nationaldramas* (2 vols., Leipzig, 1890), and Louis de Viel Castel, *Essai sur le théâtre espagnol* (2 vols., Paris, 1882). Julius Leopold Klein's extravagant prejudices detract greatly from the value of *Das spanische Drama* (Leipzig, 1871-1875), which forms part of his *Geschichte des Dramas*; but his acumen and learning are by no means contemptible. Other works on the Spanish drama are indicated by A. Morel-Fatio and L. Rouanet in their critical bibliography, *Le Théâtre espagnol* (Paris, 1900). The prefaces by M. Menéndez y Pelayo in the *Antología de poetas líricos castellanos desde la formación del idioma hasta nuestros días* (12 vols. already published, Madrid, 1890-1906) form a substantial history of Spanish poetry. The same writer's *Orígenes de la novela* (Madrid, 1905-1907) and unfinished *Historia crítica de las ideas estéticas en España* (9 vols., Madrid, 1884-1891), are highly instructive. For the 18th century the student is referred to the *Historia crítica de la poesía castellana en el siglo xviii.* (3rd ed., 3 vols., Madrid, 1893) by Leopoldo Augusto de Cueto, marqués de Valmar; Francisco Blanco García, *La Literatura española en el siglo xix.* (3 vols., Madrid, 1891-1894), is useful and informing, but must be consulted with caution, owing to the writer's party spirit. Similar prejudices are present in the much more suggestive and acute volumes of Leopoldo Alas. The history of modern criticism is traced by Francisco Fernández y González, *Historia de la crítica literaria en España desde Luzán hasta nuestros días* (Madrid, 1870). Among miscellaneous monographs and essays the most recommendable are Count Théodore de Puymaigre, *Les vieux auteurs castillans* (Paris 1861-1862; 2nd ed., incomplete, 2 vols., Paris, 1889-1890), and *La Cour littéraire de don Juan II. roi de Castille* (2 vols., Paris, 1893); A. Morel-Fatio, *L'Espagne au xvi^{me} et au xvii^{me} siècle* (Heilbronn, 1878), and *Etudes sur l'Espagne* (3 vols., Paris, 1888-1904); Enrique Piñeyro, *El Romanticismo en España* (Paris, 1904); J. Fitzmaurice-Kelly, *Chapters on Spanish Literature* (London, 1908). The *Revue hispanique* (Paris) and the *Bulletin hispanique* (Bordeaux) are specially dedicated to studies on the literary history of Spain, and articles on the subject appear from time to time in

Romania, the *Zeitschrift für romanische Philologie* and *Romanische Forschungen*, as also in *Modern Language Notes* (Baltimore) and the *Modern Language Review* (Cambridge).

2. *Catalan Literature*.—Although the Catalan language is simply a branch of the southern Gallo-Roman, the literature, **Poetry of Middle Ages.** in its origin at least, should be considered as supplementary to that of Provence. Indeed, until about the second half of the 13th century there existed in the Catalan districts no other literature than the Provençal, and the poets of north-eastern Spain used no other language than that of the troubadours. Guillem de Bergadan, Uc de Mataplana, Ramón Vidal de Besalú, Guillem de Cervera, Serveri de Gerona and other verse writers of still more recent date were all genuine Provençal poets, in the same sense as are those of Limousin, Quercy or Auvergne, since they wrote in the *langue d'oc* and made use of all the forms of poetry cultivated by the troubadours north of the Pyrenees. Ramón Vidal (end of the 12th century and beginning of 13th) was a grammarian as well as a poet; his *Rasos de trobar* became the code for the Catalan poetry written in Provençal, which he called *Lemosí*, a name still kept up in Spain to designate, not the literary idiom of the troubadours only, but also the local idiom—Catalan—which the Spaniards chose to consider as derived from the former. The influence of R. Vidal and other grammarians of his school, as well as that of the troubadours we have named, was enduring; and even after Catalan prose—an exact reflection of the spoken language of the south-east of the Pyrenees—had given evidence of its vitality in some considerable works, Catalan poetry remained faithful to the Provençal tradition. From the combination of spoken Catalan with the literary language of the troubadours there arose a sort of composite idiom, which has some analogy with the Franco-Italian current in certain parts of Italy in the middle ages, although in the one case the elements of the mixture are more distinctly apparent than are the romance of France and the romance of Italy in the other. The poetical works of Raymond Lully or Ramón Lull are among the oldest examples of this Provençalised Catalan; one has only to read the fine piece entitled *Lo Desconort* ("Despair"), or some of his stanzas on religious subjects, to apprehend at once the eminently composite nature of that language. Muntaner in like manner, whose prose is exactly that spoken by his contemporaries, becomes a troubadour when he writes in verse; his *Sermó* on the conquest of Sardinia and Corsica (1323), introduced into his *Chronicle* of the kings of Aragon, exhibits linguistically the same mixed character as is found in Lully, or, we may venture to say, in all Catalan verse writers of the 14th century. These are not very numerous, nor are their works of any great merit. The majority of their compositions consist of what were called *noves rimades*, that is, stories in octosyllabic verse in rhymed couplets. There exist poems of this class by Pere March, by a certain Torrella, by Bernat Metge (an author more celebrated for his prose), and by others whose names we do not know; among the works belonging to this last category special mention ought to be made of a version of the romance of the *Seven Sages*, a translation of a book on good breeding entitled *Facetus*, and certain tales where, by the choice of subjects, by various borrowings, and even occasionally by the wholesale introduction of pieces of French poetry, it is clearly evident that the writers of Catalonia understood and read the *langue d'oui*. Closely allied to the *noves rimades* is another analogous form of versification—that of the *codolada*, consisting of a series of verses of eight and four syllables, rhyming in pairs, still made use of in one portion of the Catalan domain (Majorca).

The 15th century is the golden age of Catalan poetry. At the instigation and under the auspices of John I. (1387–1395), Martin I. (1395–1410), and Ferdinand I. (1410–1416), kings of **15th Century.** Aragon, there was founded at Barcelona a consistory of the "Gay Saber," on the model of that of Toulouse, and this official protection accorded to poetry was the beginning of a new style much more emancipated from Provençal influence. It cannot be denied, indeed, that its forms are of foreign importation, that the Catalan verse writers accept the prescriptions of

the *Leys d'amor* of Guillaume Molinier, and that the names which they gave to their *cobles* (stanzas) are all borrowed from the same *art de trobar* of the Toulouse school; but their language begins to rid itself more and more of Provençalisms and tends to become the same as that of prose and of ordinary conversation. With Pere and Jaume March, Jordi de Sant Jordi, Johan de Masdovelles, Francesch Ferrer, Pere Torroella, Pau de Bellviure, Antoni Vallmanya, and, above all, the Valencian Auzias March, there developed a new school, which flourished till the end of the 15th century, and which, as regards the form of its versification, is distinguished by its almost exclusive employment of eight-verse *cobles* of ten syllables, each with "crossed" or "chained" rhymes (*cobla crohada* or *encadenada*), each composition ending with a *tornada* of four verses, in the first of which the "device" (*divís* or *senyal*) of the poet is given out. Many of these poems are still unedited or have only recently been extracted from the *cançoners*, where they had been collected in the 15th century. Auzias March alone, the most inspired, the most profound, but also the most obscure of the whole group, was printed in the 16th century; his *cants d'amor* and *cants de mort* contain the finest verses ever written in Catalan, but the poet fails to keep up to his own high level, and by his studied obscurity occasionally becomes unintelligible to such a degree that one of his editors accuses him of having written in Basque. Of a wholly different class, and in quite another spirit, is the *Libre de les dones* of Jaume Roig (d. 1478), a Valencian also, like March; this long poem is a *nova rimada*, only *comediada*, that is to say, it is in quadrisyllabic instead of octosyllabic verse. A bitter and caustic satire upon women, it purports to be a true history—the history of the poet himself and of his three unhappy marriages in particular. Notwithstanding its author's allegations, however, the *Libre de les dones* is mostly fiction; but it derives a very piquant interest from its really authentic element, its vivid picture of the Valencia of the 15th century and the details of contemporary manners. After this bright period of efflorescence Catalan poetry rapidly faded, a decline due more to the force of circumstances than to any fault of the poets. The union of Aragon with Castile, and the resulting predominance of Castilian throughout Spain, inflicted a death-blow on Catalan literature, especially on its artistic poetry, a kind of composition more ready than any other to avail itself of the triumphant idiom which soon came to be regarded by men of letters as the only noble one, and alone fit to be the vehicle of elevated or refined thoughts. The fact that a Catalan, Juan Boscan, inaugurates in the Castilian language a new kind of poetry, and that the Castilians themselves regard him as the head of a school, is important and characteristic; the date of the publication of the works of Boscan (1543) marks the end of Catalan poetry.

The earliest prose works in Catalan are later than the poems of the oldest Catalan troubadours of the Provençal school; these prose writings date no further back than the **Prose of 13th-15th Centuries.** close of the 13th century, but they have the advantage of being entirely original. Their language is the very language of the soil which we see appearing in charters from about the time of the accession of James I. (1213). This is true especially of the chronicles, a little less so of the other writings, which, like the poetry, do not escape the influence of the more polished dialect of the country to the north of the Pyrenees. Its chronicles are the best ornament of medieval Catalan prose. Four of them—that of James I., apparently reduced to writing a little after his death (1276) with the help of memoirs dictated by himself during his lifetime; that of Bernat Desclot, which deals chiefly with the reign of Pedro III. of Aragon (1276–1286); that of Ramon Muntaner (first half of the 14th century), relating at length the expedition of the Catalan company to the Morea and the conquest of Sardinia by James II.; finally that of Pedro IV., the Ceremonious (1335–1387), genuine commentaries of that astute monarch, arranged by certain officials of his court, notably by Bernat Descoll—these four works are distinguished alike by the artistic skill of their

narration and by the quality of their language; it would not be too much to liken these Catalan chroniclers, and Muntaner especially, to Villehardouin, Joinville and Froissart. The Doctor Illuminatus, Raymond Lully, whose acquaintance with Latin was very poor—his philosophical works were done into that language by his disciples—wrote in a somewhat Provençalized Catalan various moral and propagandist works—the romance *Blanquerna* in praise of the solitary life, the *Libre de les maravelles*, into which is introduced a “bestiary” taken by the author from *Kalilah and Dimnah*, and the *Libre del orde de cavalleria*, a manual of the perfect knight, besides a variety of other treatises and opuscula of minor importance. The majority of the writings of Lully exist in two versions—one in the vernacular, which is his own, the other in Latin, originating with his disciples, who desired to give currency throughout Christendom to their master’s teachings. Lully—who was very popular in the lay world, although the clergy had a low opinion of him and in the 15th century even set themselves to obtain a condemnation of his works by the Inquisition—had a rival in the person of Francesch Ximenez or Eximeniz, a Franciscan, born at Gerona some time after 1350. His *Crestia* (printed in 1483) is a vast encyclopaedia of theology, morals and politics for the use of the laity, supplemented in various aspects by his three other works—*Vida de Jesucrist*, *Libre del angels*, and *Libre de les dones*; the last named, which is at once a book of devotion and a manual of domestic economy, contains a number of curious details as to a Catalan woman’s manner of life and the luxury of the period. Lully and Eximeniz are the only Catalan authors of the 14th century whose works written in a vulgar tongue had the honour of being translated into French shortly after their appearance.

We have chiefly translators and historians in the 15th century. Antoni Canals, a Dominican, who belongs also to the previous century, translates into Catalan Valerius Maximus and a treatise of St Bernard; Bernat Metge, himself well versed in Italian literature, presents some of its great masters to his countrymen by translating the *Grisididis* of Petrarch, and also by composing *Lo Somni* (“The Dream”), in which the influence of Dante, of Boccaccio, and, generally speaking, of the Italy of the 13th and 14th centuries is very perceptible. The *Feyts d’armes de Catalunya* of Bernat Boades (d. 1444), a knightly chronicle brought to a close in 1420, reveals a spirit of research and a conscientiousness in the selection of materials which are truly remarkable for the age in which it was written. On the other hand, Pere Tomich, in his *Histories é conquestes del reyalme d’Aragó* (1448), carries us back too much to the manner of the medieval chroniclers; his credulity knows no bounds, while his style has altogether lost the naïve charm of that of Muntaner. To the list of authors who represent the leading tendencies of the literature of the 15th century we must add the name of Johanot Martorell, a Valencian author of three-fourths of the celebrated romance, *Tirant lo blanch* (finished in 1460 and printed in 1490), which the reader has nowadays some difficulty in regarding as that “treasury of content” which Cervantes will have it to be.

With the loss of political independence in the Catalonian countries. Catalan fell to the rank of a patois and was written less and less; lettered persons ceased to cultivate it, and the upper classes, especially in Valencia, owing to the proximity of Castile, soon affected to make no further use of the local speech except in familiar conversation. The 16th century, in fact, furnishes literary history with hardly more than a single poet at all worthy of the name—Pere Serafi, some of whose pieces, in the style of Ausias March, but less obscure, are graceful enough and deserve to live; his poems were printed at Barcelona in 1565. Prose is somewhat better represented, but scholars alone persisted in writing in Catalan—antiquaries and historians like Miquel Carbonell (d. 1517), compiler of the *Chroniques de Espanya* (printed in 1547), Francesch Tarafa, author of the *Cronica de cavallers catalans*, Anton Beuter and some others not so well known. In the 17th and 18th centuries the decadence became

still more marked. A few scattered attempts to restore to Catalan, now more and more neglected by men of letters, some of its old life and brilliance failed miserably. Neither Hieronim Pujades, author of an unfinished *Coronica universal del principat de Catalunya* (Barcelona, 1609), nor even Vicent Garcia, rector of Vallfogona (1582–1623), a verse-writer by no means destitute of verve or humour, whose works were published in 1700 under the quaint title of *La Armonia del Parnás, mes numerosa en las poesias variadas del allant del cel poetic lo Dr Vicent Garcia*, and whose literary talent and originality have been greatly exaggerated by the Catalans of the present day, could induce his countrymen to cultivate the local idiom once more. Sermons, lives of saints, a few works of devotion, didactic treatises and the like are all that was written henceforth in Catalan till the beginning of the 19th century. Writers who were Catalan by birth had so completely unlearned their mother-tongue that it would have seemed to them quite inappropriate, and even ridiculous, to make use of it in serious works, so profoundly had Castilian struck its roots in the eastern provinces of Spain, and so thoroughly had the work of assimilation been carried out to the advantage of the official language of the court and of the government.

In 1814 appeared the *Gramática y apologia de la llengua Catalana* of Joseph Pau Ballot y Torres, which may be considered as marking the origin of a genuine renaissance of the grammatical and literary study of Catalan. Although the author avows no object beyond the purely practical one of giving to strangers visiting Barcelona for commercial purposes some knowledge of the language, the enthusiasm with which he sings the praises of his mother-tongue, and his appended catalogue of works which have appeared in it since the time of James I., show that this was not his only aim. In point of fact the book, which is entitled to high consideration as being the first systematic Catalan grammar, written, too, in the despised idiom itself, had a great influence on the authors and literary men of the principality. Under the influence of the new doctrines of romanticism twenty years had not passed before a number of attempts in the way of restoring the old language had made their appearance, in the shape of various poetical works of very unequal merit. The *Oda á la patria* (1833) of Buenaventura Carlos Aribau is among the earliest if not actually the very first of these, and it is also one of the best; the modern Catalan school has produced few poems more inspired or more correct. Following in the steps of Aribau, Joaquin Rubio y Ors (*Lo Gayter del Llobregat*), Antonio de Bofarull (*Lo Cobejador de Moncada*), and soon afterwards a number of other versifiers took up the lyre which it might have been feared was never to sound again since it fell into the hands of Ausias March. The movement spread from Catalonia into other provinces of the ancient kingdom of Aragon; the appeal of the Catalans of the principality was responded to at Valencia and in the Balearic Isles. Later, the example of Provence, of the *félibrige* of the south of France, accelerated still further this renaissance movement, which received official recognition in 1859 by the creation of the *jochs florals*, in which prizes are given to the best competitors in poetry, of whom some succeed in obtaining the diploma of *mestre en gay saber*. It is of course impossible to foresee the future of this new Catalan literature—whether it is indeed destined for that brilliant career which the Catalans themselves anticipate. In spite of the unquestionable talent of poets like Mariano Aguiló (Majorca), Teodoro Llorente (b. 1836; Valencia), and more especially Jacinto Verdager (1845–1902), author of an epic poem *Atlántida* and of the very fascinating *Cants místichs*, it is by no means certain that this renaissance of a provincial literature will be permanent now that the general tendency throughout Europe is towards unity and centralization in the matter of language. At all events it would be well if the language were somewhat more fixed, and if its writers no longer hesitated between a pretentious archaism and the incorrectness of vulgar colloquialism. Some improvement in this respect is discernible in the poems of Joan Maragall (b. 1860), the lyrical verse of

Apels Mestre (b. 1854), the fiction of Narcis Oller and Santiago Rusiñol, as also in the dramas of Angel Guimerá, and if the process be continued there may be a future, as well as a past, for Catalan literature.

BIBLIOGRAPHY.—José Rodríguez, *Biblioteca valentina* (Valencia, 1747); Vicente Ximeno, *Escritores del reyno de Valencia* (2 vols., Valencia, 1747-1749); Justo Pastor Fuster, *Biblioteca valenciana* (2 vols., Valencia, 1827-1830); Felix Torres Amat, *Memoirs para ayudar á formar un diccionario crítico de los escritores catalanes* (Barcelona, 1836), with a supplement by J. Corminas (Burgos, 1849); F. R. Camboulin, *Essai sur l'histoire de la littérature catalane* (Paris, 1858); M. Milá y Fontanals, *De los Trovadores en España* (Barcelona 1861), and studies included in his *Obras completas*; E. Cardona, *De la Antica literatura catalana* (Naples, 1880); A. Morel-Fatio, "Katalanische Litteratur," in the second volume of the *Grundriss der romanischen Philologie*, pt. ii., and *Catalogue des manuscrits espagnols et portugais de la bibliothèque nationale* (Paris, 1881-1892); V. M. O. Denk, *Einführung in die Geschichte der altcatalanischen Litteratur* (Munich, 1893); J. Massó Torrents, *Manuscrits catalans de la biblioteca nacional de Madrid* (Barcelona, 1896). For the modern period see Joaquín Rubió y Ors, *Breve reseña del actual renacimiento de la lengua y literatura catalanas* (2 vols., Barcelona, 1880); F. M. Tubino, *Historia del renacimiento contemporáneo en Cataluña, Baleares y Valencia* (Madrid, 1880); A. de Molins, *Diccionario biográfico y bibliográfico de escritores y artistas catalanes del siglo xix.* (Barcelona, 1891-1896); E. Toda, *La Poesía catalana á Sardenya* (Barcelona, 1888). Important articles by P. Meyer, A. Thomas, A. Pagés, J. Massó Torrents, A. Morel-Fatio and others appear from time to time in *Romania*, the *Revue des langues romanes*, the *Revue hispanique*, the *Revista catalana* and other special periodicals.

(J. F.-K.; A. M.-FA.)

SPALATIN, GEORGE, the name taken by George Burkhardt (1484-1545), an important figure in the history of the Reformation, who was born on the 17th of January 1484, at Spalt (whence he assumed the name Spalatinus), near Nuremberg, where his father was a tanner. He went to Nuremberg for his education when he was thirteen years of age, and soon afterwards to the university of Erfurt, where he took his bachelor's degree in 1499. There he attracted the notice of Nikolaus Marschalk, the most influential professor, who made Spalatin his amanuensis and took him to the new university of Wittenberg in 1502. In 1505 Spalatin returned to Erfurt to study jurisprudence, was recommended to Conrad Mutianus, and was welcomed by the little band of German humanists of whom Mutianus was chief. His friend got him a post as teacher in the monastery at Georghenthal, and in 1508 he was ordained priest by Bishop Johann von Laasphe, who had ordained Luther. In 1509 Mutianus recommended him to Frederick III. the Wise, the elector of Saxony, who employed him to act as tutor to his nephew, the future elector, John Frederick. Spalatin speedily gained the confidence of the elector, who sent him to Wittenberg in 1511 to act as tutor to his nephews, and procured for him a canon's stall in Altenburg. In 1512 the elector made him his librarian. He was promoted to be court chaplain and secretary, and took charge of all the elector's private and public correspondence. His solid scholarship, and especially his unusual mastery of Greek, made him indispensable to the Saxon court.

Spalatin had never cared for theology, and, although a priest and a preacher, had been a mere humanist. How he first became acquainted with Luther it is impossible to say—probably at Wittenberg; but the reformer from the first exercised a great power over him, and became his chief counsellor in all moral and religious matters. His letters to Luther have been lost, but Luther's answers remain, and are extremely interesting. There is scarcely any fact in the opening history of the Reformation which is not connected in some way with Spalatin's name. He read Luther's writings to the elector, and translated for his benefit those in Latin into German. He accompanied Frederick to the Diet of Augsburg in 1518, and shared in the negotiations with the papal legates, Cardinal Cajetan and Karl von Miltitz. He was with the elector when Charles was chosen emperor and when he was crowned. He was with his master at the Diet of Worms. In short, he stood beside Frederick as his confidential adviser in all the troubled diplomacy of the earlier years of the Reformation. Spalatin would have dissuaded Luther again and again from publishing books or

engaging in overt acts against the Papacy, but when the thing was done none was so ready to translate the book or to justify the act.

On the death of Frederick the Wise in 1525 Spalatin no longer lived at the Saxon court. But he attended the imperial diets, and was the constant and valued adviser of the electors, John and John Frederick. He went into residence as canon at Altenburg, and incited the chapter to institute reforms somewhat unsuccessfully. He married in the same year. During the later portion of his life, from 1526 onwards, he was chiefly engaged in the visitation of churches and schools in electoral Saxony, reporting on the confiscation and application of ecclesiastical revenues, and he was asked to undertake the same work for Albertine Saxony. He was also permanent visitor of Wittenberg University. Shortly before his death he fell into a state of profound melancholy, and died on the 16th of January 1545, at Altenburg.

Spalatin left behind him a large number of literary remains, both published and unpublished. His original writings are almost all historical. Perhaps the most important of them are: *Annales reformationis*, edited by E. S. Cyprian. (Leipzig, 1718); and "Das Leben und die Zeitgeschichte Friedrichs des Weisen," published in *Georg Spalatin's Historischer Nachlass und Briefe*, edited by C. G. Neudecker and L. Preller (Jena, 1851). A list of them may be found in A. Seelheim's *George Spalatin als sächs. Historiograph* (1876). There is no good life of Spalatin, nor can there be until his letters have been collected and edited, a work still to be done. There is an excellent article on Spalatin, however, by T. Kolde, in Herzog-Hauck, *Realencyklopädie*, Bd. xviii. (1906).

SPALATO, or SPALATRO (Serbo-Croatian *Spljet* or *Split*), an episcopal city, and the centre of an administrative district, in Dalmatia, Austria, and on the Adriatic Sea. Pop. (1900), of town and commune, 27,198; chiefly Serbo-Croatian, and almost exclusively Roman Catholic. Spalato is situated on the seaward side of a peninsula between the Gulf of Brazza and the Gulf of Salona. Though not the capital, it is commercially the most important city in Dalmatia and carries on an extensive trade in wine and oil. It is a port of call for the Austrian Lloyd steamers, and communicates by rail with Sebenico, Knin and Sinj. Spalato has a striking sea-front, in which the leading feature is the ruined façade of the great palace of Diocletian, to which the city owes its origin. A large part of Spalato is actually within the limit of the palace; and many modern houses are built against its ancient walls and incorporate parts of them, not only on the inner but also on the outer side. This palace was erected between A.D. 290 and 310. In ground plan it is almost a square, with a quadrangular tower at each of the four corners. It covers 9½ acres. There were originally four principal gates, with four streets meeting in the middle of the quadrangle, after the style of a Roman camp. The eastern gate, or Porta Aenea, is destroyed, but, though the side towers are gone, the western gate, or Porta Ferrea, and the main entrance of the building, the beautiful Porta Aurea, in the north front, are still in fairly good preservation. The streets are lined with massive arcades. The vestibule now forms the Piazza del Duomo or cathedral square; to the north-east of this lies the temple of Jupiter, or perhaps the mausoleum. This has long been the cathedral of St Doimo or Domnius, small and dark, but noteworthy for its finely carved choir stalls. To the south-east is the temple of Aesculapius, which served originally as a kind of court chapel, and has long been transformed into a baptistery. A beautiful Romanesque campanile was added to the baptistery in the 14th and 15th centuries. Architecturally the most important of the many striking features of the palace is the arrangement in the vestibule by which the supporting arches spring directly from the capitals of the large granite Corinthian columns. This, as far as the known remains of ancient art are concerned, is the first instance of such a method.

The ruins of Salona or Salonae, lying about 4 m. north-east of the palace, were chiefly exhumed during a series of excavations undertaken after the visit of the emperor Francis I. in 1818. Research was carried on regularly from 1821 to 1827, and again from 1842 to 1850. It was afterwards resumed at intervals

until 1877, when the excavation committee was granted an annual subsidy by the Austrian government. Many discoveries were made, including the ruins of a theatre, amphitheatre, city walls and gates, baths, aqueducts, pagan and Christian cemeteries, basilicas and many fragments of houses and arches. Professor F. Bulić, who had charge of the work and of the museum at Spalato, reported in 1894 that the collection of minor objects comprised "2034 inscriptions, 387 sculptures, 176 architectural pieces, 1548 fragments or objects of terra-cotta and vases, 1243 objects of glass, 3184 of metal, 929 of bone, 1229 gems, 128 objects from prehistoric times, and 15,000 coins" (Munro, p. 244). These are preserved in the museum. One vase, of Corinthian workmanship, dates from the 6th century B.C.; and many of the early Christian relics are of unusual interest. The so-called "cyclopean" walls, mortarless, but constructed of neatly squared and fitted blocks, are probably of Roman workmanship. Jackson suggests that perhaps, like the long walls at Athens, they were intended to unite the city with its port.

Salona under the early Roman emperors was one of the chief ports of the Adriatic, on one of the most central sites in the Roman world. Made a Roman colony after its second capture by the Romans (78 B.C.), it appears as *Colonia Martia Julia* and *Colonia Claudia Augusta Pia Veteranorum*, and bears at different periods the titles of *respublica*, *conventus*, *metropolis*, *praefectura* and *praetorium*. Diocletian died in 313; and before long the city became an episcopal see, with St Doimo as its first bishop. The palace was transformed into an imperial cloth factory, and, as most of the workers were women, it became known as the *gynaecium*. Salona was several times taken and retaken by the Goths and Huns before 639, when it was sacked and nearly destroyed by the Avars. Its inhabitants fled to the Dalmatian islands, but returned shortly afterwards to found a new city within the walls of the palace. Salona itself was not entirely deserted until the close of the 12th century. In 650 the papal legate, John of Ravenna, was created bishop of Spalato, as the new city was named. "Spalato," or "Spalatro" (a very old spelling), was long regarded as a corruption of *Salonae Palatium*; but its true origin is doubtful. The most ancient form is *Aspalathum*, used in the 10th century by Constantine Porphyrogenitus. *Spalathum*, *Spalathrum* and *Spalatum* are early variants. In a few years Spalato became an archbishopric, and its holders were metropolitans of all Dalmatia until 1033. In 1105 Spalato became a vassal state of Hungary; in 1327 it revolted to Venice; in 1357 it returned to its allegiance. It was ruled by the Bosnian king, Tvrtko, from 1390 to 1391; and in 1402 the famous and powerful Bosnian prince, Hrvoje or Harvoje, received the dukedom of Spalato from Ladislaus of Naples, the claimant to the Hungarian throne. In 1413, after the overthrow of Ladislaus by the emperor Sigismund, Hrvoje was banished; but a large octagonal tower, the Torre d'Harvoje, still bears his name. Spalato received a Venetian garrison in 1420, and ceased to have an independent history. The castle and city walls, erected by the Venetians between 1645 and 1670, were dismantled after 1807.

See T. G. Jackson, *Dalmatia, the Quarnero and Istria* (Oxford, 1887); and E. A. Freeman, *Subject and Neighbour Lands of Venice* (London, 1881), for a general description of Spalato, its antiquities and history. A valuable account of the researches at Salona is given in R. Munro, *Bosnia-Herzegovina and Dalmatia* (London, 1900). There are two magnificently illustrated volumes which deal with Diocletian's palace: R. Adam, *Ruins of the Palace of the Emperor Diocletian at Spalato, in Dalmatia* (London, 1764), engravings by Bartolozzi; and L. J. Cassas and J. Lavallée, *Voyage pittoresque et historique de l'Istrie* (Paris, 1802). The Dalmatian chronicles, reproduced by G. Lucio in his *De regno Dalmatiae et Croatiae* (Amsterdam, 1666), include several which deal specially with Salona and Spalato. The most important is the *Historia salontanorum pontificum et spalatensium*, by Thomas, archdeacon of Spalato (1200-1268).

SPALDING, WILLIAM (1809-1859), British author, was born in Aberdeen on the 22nd of May 1809. He was educated at the grammar school there and at Marischal College, and he went in 1830 to Edinburgh, where he was called to the bar in 1833. In that year he published a *Letter on Shakespeare's*

Authorship of the two Noble Kinsmen (reprinted for the New Shakspeare Society in 1876), which attracted the notice of Jeffrey, who invited Spalding to contribute to the *Edinburgh Review*. He also spent some time in Italy, and in 1841 published *Italy and the Italian Islands from the Earliest Ages to the Present Time*. He occupied the chair of rhetoric in Edinburgh University from 1840 to 1845, when he was appointed professor of logic in the university of St Andrews, a post which he held till his death on the 16th of November 1859.

Besides contributions to the *Edinburgh Review*, *Blackwood's Magazine* and the eighth edition of the *Encyclopaedia Britannica*, he was the author of a concise *History of English Literature* (1853).

SPALDING, a market town in the Holland or Spalding parliamentary division of Lincolnshire, England, on the river Welland, and on the Great Northern and Great Eastern railways, 93 m. N. from London. Pop. of urban district (1901), 9385. The town is the centre of a rich agricultural district. The parish church of St Mary and St Nicholas was built in 1284 and is of peculiar construction, having four aisles to the nave. It is mainly Decorated in style. The adjoining lady chapel (St Mary and St Thomas à Becket) was built in 1315; in 1588 it was appropriated for the grammar school endowed in 1568 by John Blanke and again in 1588 by John Gamlyn. A new grammar school was erected in 1881. There are several modern churches and chapels, a corn exchange, a Christian association and literary institute, and the Johnson hospital (1881, endowed). The existing high bridge over the Welland, constructed in 1838, took the place of a wooden erection dating from the end of the 17th century; this last was built on the site of a Roman bridge of two arches, the foundations of the centre pier of which were disclosed when the wooden bridge was constructed. Trade is principally agricultural, and there is considerable water-traffic on the Welland.

Although there are no traces of settlement at Spalding (*Spaltnige*) before late Saxon times there was probably a village here before Thorold the sheriff founded his cell of Crowland Abbey in 1051. In Domesday Book the manor is said to belong to Ivo de Taillebois, who possessed a market there worth 40s., six fisheries and rent from salt-pans. The manor was afterwards granted to Angers, and later belonged to Spalding Priory, which retained it until at the suppression it passed to the Crown. Stephen made Spalding Priory free of toll, while John gave the monks forest rights. The town was governed by the prior's manorial court, and never became a parliamentary or municipal borough. The prior obtained the grant of the Friday market in 1242, and in the reign of Edward I. claimed from of old fairs on the feast of St Nicholas and fifteen days following, and on the vigil and octave of St Cross. In more modern times Spalding was well known for the club known as the "Gentleman's Society," founded in 1710 by Maurice Johnson, which met once a week at a coffee-house in the town for the discussion of literary and antiquarian subjects, and numbered among its members Newton, Bentley, Addison, Pope and Gay.

SPALLANZANI, LAZARO (1729-1799), Italian man of science, was born at Scandiano in Modena on the 10th of January 1729, and was at first educated by his father, who was an advocate. At the age of fifteen he was sent to the Jesuit college at Reggio di Modena, and was pressed to enter that body. He went, however, to the university of Bologna, where his famous kinswoman, Laura Bassi, was professor of physics, and it is to her influence that his scientific impulse has been usually attributed. With her he studied natural philosophy and mathematics, and gave also great attention to languages, both ancient and modern, but soon abandoned the study of law, and afterwards took orders. His reputation soon widened, and in 1754 he became professor of logic, metaphysics and Greek in the university of Reggio, and in 1760 was translated to Modena, where he continued to teach with great assiduity and success, but devoted his whole leisure to natural science. He declined many offers from other Italian universities and from St Petersburg until 1768, when he accepted the invitation of Maria Theresa to the chair of natural history in the university of Pavia, which was then being reorganized. He also became director of the museum, which he greatly

enriched by the collections of his many journeys along the shores of the Mediterranean. In 1785 he was invited to Padua, but to retain his services his sovereign doubled his salary and allowed him leave of absence for a visit to Turkey, where he remained nearly a year, and made many observations, among which may be noted those of a copper mine in Chalki and of an iron mine at Principi. His return home was almost a triumphal progress: at Vienna he was cordially received by Joseph II., and on reaching Pavia he was met with acclamations outside the city gates by the students of the university. During the following year his students exceeded five hundred. His integrity in the management of the museum was called in question, but a judicial investigation speedily cleared his honour, to the satisfaction even of his accusers. In 1788 he visited Vesuvius and the volcanoes of the Lipari Islands and Sicily, and embodied the results of his researches in a large work (*Viaggi alle due Sicilie ed in alcune parti dell' Apennino*), published four years later. He died from an apoplectic seizure on the 12th of February 1799, at Pavia.

His indefatigable exertions as a traveller, his skill and good fortune as a collector, his brilliance as a teacher and expositor, and his keenness as a controversialist no doubt aid largely in accounting for Spallanzani's exceptional fame among his contemporaries; yet greater qualities were by no means lacking. His life was one of incessant eager questioning of nature on all sides, and his many and varied works all bear the stamp of a fresh and original genius, capable of stating and solving problems in all departments of science—at one time finding the true explanation of "ducks and drakes" (formerly attributed to the elasticity of water) and at another helping to lay the foundations of our modern vulcanology and meteorology. His main discoveries, however, were in the field of physiology: he wrote valuable and suggestive papers on respiration, on the senses of bats, &c., while he made experiments (1768) to disprove the occurrence of spontaneous generation, showing in opposition to J. H. Needham (1713-1781) that animalcules did not develop in vegetable infusions which had been boiled and were kept in properly closed vessels. His great work, however, is the *Dissertationi de fisica animale e vegetale* (2 vols., 1780). Here he first interpreted the process of digestion, which he proved to be no mere mechanical process of trituration, but one of actual solution, taking place primarily in the stomach, by the action of the gastric juice. He also carried out important researches on fertilization in animals (1780).

SPAN (from O. Eng. *spannan*, to bind, connect together; the word is of general occurrence in Teutonic languages, the ultimate origin being the root *spa-*, to extend, stretch out, cf. Gr. *σπᾶν*, to draw out, Lat. *spatium*, space), a distance stretched, the space between terminal points. The word was formerly used as a measure of length=10.368 in., taken from the stretch of the fully opened hand from thumb to little finger. The term is used in architecture for the width or opening of an arch or arched opening, and also the width of a roof between the wall plates. A "span roof" is a roof having two sides inclining to a centre or ridge, in contradistinction to a "shed roof" (see SHED).

SPANDAU, a town of Germany, in the Prussian province of Brandenburg, at the confluence of the Havel and Spree, 8 m. N.W. of Berlin, of which it is practically a suburb, on the main lines of railway to Hanover and Hamburg respectively. Pop. (1885), 31,463; (1895), 55,813; (1905), 70,295 (including a garrison of about 5000). The town has of recent years made marked progress, its trade being enhanced by an excellent railway service with Berlin and improved navigation on the Havel. The fortifications, which were strengthened after the war, 1870-71, for the protection of the arsenal, have been razed on the northern and eastern sides, and of its former defences none remain except the citadel and a line of works along a ridge of hills to the south of the town. The Julius tower in the citadel, which is surrounded by water, contains the Imperial war treasure (*Reichskriegsschatz*),—a sum of £6,000,000 in gold, kept in readiness for any warlike emergency, and reserved for the indemnity paid by France after the war of 1870-71. Spandau contains four Protestant churches, a Roman Catholic church, a gymnasium and a school of musketry. Besides numerous barracks, there are various military establishments appropriate to an important garrison town; and its chief industries are connected with the preparation of munitions of war. The government factories for the

manufacture of small arms, artillery, gunpowder, &c., cover upwards of 200 acres, and employ about 6000 workmen. The other industries are not very important; they comprise miscellaneous manufactures, fishing, boat-building, and some shipping on the Havel.

Spandau is one of the oldest places in the Altmark, and received civic rights in 1232. It afterwards became a favourite residence of the Hohenzollern electors of Brandenburg, and was fortified in 1577-1583. In 1635 it surrendered to the Swedes, and in 1806 to the French. A short investment in 1813 restored it to Prussia.

See Zech and Günther, *Geschichtliche Beschreibung der Stadt und Festung Spandau* (Spandau, 1847), and Kuntzemüller, *Urkundliche Geschichte der Stadt und Festung Spandau* (Spandau, 1881).

SPANDRIL, or SPANDREL (formerly *splaudrel*, a word of unknown origin), in architecture, the space between any arch or curved brace and the level label, beams, &c., over the same. The spandrils over doorways in Perpendicular work are generally richly decorated. At Magdalen College, Oxford, is one which is perforated, and has a most beautiful effect. The spandril of doors is sometimes ornamented in the Decorated period, but seldom forms part of the composition of the doorway itself, being generally over the label.

SPANGENBERG, AUGUST GOTTLIEB (1704-1792), Count Zinzendorf's successor, and bishop of the Moravian Brethren, was born on the 15th of July 1704 at Klettenberg, on the south of the Harz Mountains, where his father, Georg Spangenberg, was court preacher and ecclesiastical inspector of the countship of Hohenstein. Left an orphan at the early age of thirteen, he was sent to the gymnasium at Ilfeld, and passed thence (1722), in poorest circumstances, to the university of Jena to study law. Professor Johann Franz Buddeus (1667-1729) received him into his family, and a "stipendium" was procured for him. He soon abandoned law for theology; took his degree in 1726, and began to give free lectures on theology. He also took an active part in a religious union of students, in the support of the free schools for poor children established by them in the suburbs of Jena, and in the training of teachers. In 1728 Count Zinzendorf visited Jena, and Spangenberg made his acquaintance; in 1730 he visited the Moravian colony at Herrnhut. A "collegium pastorale practicum" for the care of the sick and poor was in consequence founded by him at Jena, which the authorities at once broke up as a "Zinzendorffian institution." But Spangenberg's relations with the Moravians were confirmed by several visits to the colony, and the accident of an unfavourable appeal to the lot alone prevented his appointment as chief elder of the community, March 1733. Meanwhile his free lectures in Jena met with much acceptance, and led to an invitation from Gotthilf Francke to the post of assistant professor of theology and superintendent of schools connected with his orphanage at Halle. He accepted the invitation, and entered on his duties in September 1732. But differences between the Pietists of Halle and himself soon became apparent. He found their religious life too formal, external and worldly; and they could not sanction his comparative indifference to doctrinal correctness and his incurable tendency to separatism in church life. Spangenberg's participation in private observances of the Lord's Supper and his intimate connexion with Count Zinzendorf brought matters to a crisis. He was offered by the senate of the theological faculty of Halle the alternative of doing penance before God, submitting to his superiors, and separating himself from Zinzendorf, or leaving the matter to the decision of the king, unless he preferred to "leave Halle quietly." The case came before the king, and, on the 8th of April 1733, Spangenberg was conducted by the military outside the gates of Halle. At first he went to Jena, but Zinzendorf at once sought to secure him as a fellow labourer, though the count wished to obtain from him a declaration which would remove from the Pietists of Halle all blame with regard to the disruption. Spangenberg went to Herrnhut and found amongst the Moravians his life-work, having joined them at a moment when the stability of the society was threatened. He became its theologian, its

apologist, its statesman and corrector, through sixty long years of incessant labour.

For the first thirty years (1733-1762) his work was mainly devoted to the superintendence and organization of the extensive missionary enterprises of the body in Germany, England, Denmark, Holland, Surinam, Georgia and elsewhere. It was on an island off Savannah that Spangenberg startled John Wesley with his questions and profoundly influenced his future career. One special endeavour of Spangenberg in Pennsylvania was to bring over the scattered Schwenkfeldians to his faith. In 1741-1742 he was in England collecting for his mission and obtaining the sanction of the archbishop of Canterbury. During the second half of this missionary period of his life he superintended as bishop the churches of Pennsylvania, defended the Moravian colonies against the Indians at the time of war between France and England, became the apologist of his body against the attacks of the Lutherans and the Pietists, and did much to moderate the mystical extravagances of Zinzendorf, with which his simple, practical and healthy nature was out of sympathy. The second thirty years of his work (1762-1792) were devoted to the consolidation of the German Moravian Church. Zinzendorf's death (1760) had left room and need for his labours at home. At Herrnhut there were conflicting tendencies, doctrinal and practical extravagances, and the organization of the brethren was very defective. In 1777 Spangenberg was commissioned to draw up an *idea fidei fratrum*, or compendium of the Christian faith of the United Brethren, which became the accepted declaration of the Moravian belief. As compared with Zinzendorf's own writings, this book exhibits the finer balance and greater moderation of Spangenberg's nature, while those offensive descriptions of the relation of the sinner to Christ in which the Moravians at first indulged are almost absent from it. In his last years Spangenberg devoted special attention to the education of the young, in which the Moravians have since been so successful. He died at Berthelsdorf, on the 18th of September 1792. In addition to the *Idea fidei fratrum*, Spangenberg wrote, besides other apologetic books, a *Declaration über die seither gegen uns ausgegangenen Beschuldigungen sonderlich die Person unseres Ordinarius (Zinzendorf) betreffend* (Leipzig, 1751), an *Apologetische Schlusschrift* (1752), *Leben des Grafen Zinzendorf* (1772-1775); and his hymns are well known beyond the Moravian circle.

In addition to his autobiography (*Selbstbiographie*), see J. Risler, *Leben Spangenbergs* (Barby, 1794); K. F. Ledderhose, *Das Leben Spangenbergs* (Heidelberg, 1846); Otto Frick, *Beiträge zur Lebensgeschichte A. G. Spangenbergs* (Halle, 1884); Gerhard Reichel's article in Herzog-Hauck's *Realencyklopädie* (ed. 1906), s.v. "Spangenberg"; the article by Ledderhose, in the *Allgemeine deutsche Biographie*; also MORAVIAN BRETHERN.

SPANISH-AMERICAN WAR OF 1898. For the causes leading up to the war see CUBA and UNITED STATES: *History*. On the 15th of February 1898 the U.S. battleship "Maine," which had been sent to Havana on the 25th of January, was destroyed in Havana harbour by an explosion, with a loss of 266 lives. An American board of inquiry, of which Captain W. T. Sampson was president, made an extensive examination of the wreck, and reported to the navy department on the 21st of March that the explosion was caused by an exterior mine, the principal reason for this decision being the upheaval of the ship's bottom.¹ On the 20th of April President McKinley approved a resolution demanding the withdrawal of Spain from Cuba and setting noon of the 23rd of April as the latest date for a reply to the demand. Before this could be delivered by the American minister in Madrid, the Spanish government sent him his passports. On the 22nd the president declared a blockade of Cuban ports; on the 24th the Spanish government declared war; and on the

¹The Spanish authorities made an examination, but did not inspect the interior, the chief diver reporting that "the bilge and keel of the vessel throughout its entire extent were buried in the mud, but did not appear to have suffered any damage." It has been suggested that the explosion was the work of Cuban sympathizers who thus planned to secure American assistance against Spain. It was not until 1910 that Congress made an appropriation (and an inadequate one then) for raising the "Maine."

25th the United States Congress declared that war had existed since the 21st.

The American government had begun to prepare for war as early as January: ships on several foreign stations had been drawn nearer home, and those in Chinese waters were collected at Hong-Kong; the North Atlantic squadron, the only powerful one, had been sent from Hampton Roads into the waters of Florida for manœuvres; after the destruction of the "Maine" the chief part of the ships in the Atlantic were concentrated at Key West; the battleship "Oregon" was ordered east from the Pacific; \$50,000,000 was voted (March 9) "for the national defence"; steps were taken to purchase auxiliary cruisers, yachts and tugs, which were rapidly equipped; large supplies of ammunition were ordered, and Key West became an active base of preparation; Captain Sampson, senior officer of the North Atlantic squadron, was appointed its commander-in-chief with rank of acting rear-admiral; and a "flying squadron" composed of the armoured cruiser "Brooklyn" (flag), the battleships "Texas" and "Massachusetts," and the fast cruisers "Minneapolis" and "Columbia," with Commodore W. S. Schley in command, was stationed at Hampton Roads.

There was a great preponderance of large ships on the side of the United States; only in torpedo craft and small gunboats was Spain superior. The American ships were highly efficient; in Spain everything was unready; Admiral Cervera felt that to send a Spanish squadron across the Atlantic was to send it to destruction, and when he had collected his squadron (including two cruisers from Havana) at the Cape Verde Islands in March, he renewed his expostulations, in which he was supported by a council of war. But on the 24th of April he was peremptorily ordered to leave for Porto Rico, without definite instructions or plan of campaign.

The American flying squadron was held at Hampton Roads, so great was the fear of attack by Spanish ships; and armed auxiliaries and fast cruisers were employed in patrolling the coast east of New York; these could have rendered good service elsewhere, but would have been of no use in repelling an attack by Cervera's squadron had it come that way.

The joint resolution of Congress of the 20th of April had declared that the relinquishment by Spain of authority in Cuba was the object of American action; the struggle thus naturally centred about the island. All operations were thus near at hand, Havana, the real objective in Cuba, being only about 100 m. from Key West. A political reason for confining action to the western Atlantic was that an immediate attack upon the coasts of Spain might have aroused the strongly pro-Spanish sympathy of continental Europe into greater activity. The regular United States army, the only available force until war was declared and a volunteer force was authorized, had been assembled at Tampa, Florida, New Orleans and Chickamauga, Georgia, but until the control of the sea was decided, the army could not prudently be moved across the Strait of Florida. Cervera's fleet was thus the real objective of the navy, and had to be settled with before any military action could be undertaken.

Rear-Admiral Sampson left Key West early on the 22nd, and began the blockade of Havana and the north coast of Cuba as far as Cardenas, 80 m. east, and Bahia Honda, 50 m. west. His North Atlantic squadron of 28 vessels of all kinds, of which the armoured cruiser "New York" (flag), the battleships "Iowa" and "Indiana," and the monitors "Puritan," "Terror" and "Amphitrite," were the most important, and which included six torpedo-boats, was increased to 124 vessels by the 1st of July, chiefly by the addition of extemporized cruisers, converted yachts, &c.

In the Pacific, the American squadron—the protected cruisers "Olympia" (flagship of Commodore George Dewey), "Baltimore," "Raleigh" and "Boston," the small unprotected cruiser "Concord," the gunboat "Petrel," the armed revenue cutter "Hugh M'ulloch," with a purchased collier "Nanshan" and a purchased supply ship "Zafiro"—left Hong-Kong at the request of the governor and went to Mirs Bay, some miles east

on the Chinese coast. Ordered (April 25) to begin operations, particularly against the Spanish fleet, which he was directed to capture or destroy, Dewey left Mirs Bay on the 27th, and arrived off Luzon, in the Philippines, on the 30th of April. The Spanish admiral Montojo anchored to the eastward of the spit on which are the village and arsenal of Cavite, in a general east and west line, keeping his broadside to the northward. His force consisted of the "Reina Cristina," the "Castilla" (an old wooden steamer which had to be towed); the "Isla de Cuba" and "Isla de Luzon" (protected cruisers of 1050 tons); the "Don Juan de Austria" and the "Don Antonio de Ulloa" (gunboats of about 1150 tons), and the "Marques del Duero" (of 500 tons). There were six guns (3 breech-loaders) in battery at or near Cavite.

Dewey stood on during the night, and passed into the Boca Grande (about 5 m. broad), paying no attention to rumours of torpedoes in a channel so broad and deep, and at midnight passed El Fraile (a large rock, $1\frac{1}{2}$ m. from the south side), from which two shots were fired at him, and he was also fired at by the "Cavite" and one of the city batteries. When he sighted the Spanish squadron to the southward he ordered his transports and the revenue cutter "Hugh M'Culloch" out into the bay, and stood down in column with the "Olympia," "Baltimore," "Raleigh," "Petrel," "Concord" and "Boston" at 400-yd. intervals. When, within 5000 yds. he ported his helm, and at 5.41 a.m. opened fire. He stood westwards along the Spanish line, using his port batteries, turned to starboard and stood back, gradually decreasing his distance to 2000 yds. At 7 o'clock the Spanish flagship attempted to come out and engage at short range, but was driven back by the American fire. The Spanish squadron was now in very bad plight, but the seriousness of its condition was not fully known to the American commander. At 7.35 Dewey withdrew, gave his men breakfast, and had a consultation of commanding officers. Before he re-engaged at 11.16 the "Cristina" and "Castilla" had broken into flames, so that the remainder of the action consisted in silencing the Cavite batteries and completing the destruction and demoralization of the smaller Spanish ships, which the "Petrel" was ordered in to burn. The victory was complete. All the Spanish ships¹ were sunk or destroyed. The injury done the American ships was practically nil. The Spanish lost 167 killed and 214 wounded, out of a total of 1875. The Americans had 7 slightly wounded out of 1748 men in action. Dewey took possession of Cavite, paroled its garrison, and awaited the arrival of a land force to capture Manila.

The blockade of Havana had progressed without incident, beyond the capture of a number of Spanish steamers and sailing vessels,² and the shelling of some new earthworks at Matanzas on the 27th of April; but on the 11th of May a small action was fought at Cardenas, in which the Americans were repulsed and Ensign Worth Bagley, the first American officer to lose his life in the war, was killed. On the same day a partially successful attempt was made, under a heavy fire from the shore, to cut the cable between Cienfuegos and Havana.

Cervera had left the Cape Verde Islands on the 29th of April with four armoured cruisers, the "Almirante Oquendo," "Infanta Maria Theresa" and "Vizcaya" (sister ships of 7000 tons) and the "Cristobal Colon" (same size; differently equipped) and three torpedo-boat destroyers—a type not then represented in the American navy—"Furor," "Terror" and "Pluton." On hearing (May 1) of Cervera's departure, Sampson went east 1000 m. to San Juan, Porto Rico, with the armoured cruiser "New York," the battleships "Iowa" and "Indiana," the cruisers "Montgomery" and "Detroit," and one torpedo-boat. In going east he calculated on using a speed of 10 knots, on getting to San Juan on the 8th, about the time the Spaniards would reach

its longitude, and if they were not there, on returning off Havana before they could get to Havana harbour. He wished to prevent Cervera's refitting at San Juan, from which place the American coast would be within easy reach, New York being only about 1400 m. away. But the speed of the American squadron fell short of Sampson's expectation; he reached San Juan on the 12th, stood in to see if Cervera was in the harbour, and opened fire upon the fortifications. He did not press the attack since Cervera was not present, and at once started back for Havana without news of Cervera, who was then in fact off Martinique, with orders to go to San Juan. When he heard that Sampson was at San Juan, he steamed to Curaçao, where he arrived on the 14th of May and where the authorities allowed him to coal. He reached Santiago de Cuba early on the 19th without being sighted *en route* by any of the American scouts, though several were in the vicinity. Sampson thought the Spanish squadron might have returned to Spain.³ But he learned that the enemy had not turned back, on the night of the 15th, when a telegram from the navy department directed him to proceed with all despatch to Key West. He got there on the afternoon of the 18th, and found the flying *The Search* squadron ("Brooklyn" (flag), "Massachusetts," *for Cervera's* "Texas," and "Scorpion"), which left on the next *Squadron.*

morning (19th) for Cienfuegos, then regarded by the navy department as the certain objective of the Spanish squadron. The battleship "Iowa," the gunboat "Castine," the torpedo-boat "Dupont" and the collier "Merrimac" sailed to join Schley on the 20th, and gave him a force sufficient to meet Cervera. Sampson was advised by the department (on the 20th) to "send by the 'Iowa' to Schley to proceed off Santiago de Cuba with his whole command, leaving one small vessel off Cienfuegos," but he directed Schley in an order of the 21st if he was satisfied that Cervera was not at Cienfuegos, to proceed with all despatch to Santiago, and if the Spanish squadron was there, to blockade it.

Commodore Schley arrived off Cienfuegos on the 22nd, and held to the opinion that Cervera was there until the 24th, when Commodore M'Calla of the "Marblehead" communicated with the insurgents some miles westwards, and learned the truth. Schley started that evening for Santiago, 300 m. distant, but on the afternoon of the 26th was 20 m. south of the port. Early on the 27th Schley received a despatch from the navy department suggesting that the Spanish squadron was in Santiago and bidding him see "that the enemy, if therein, does not leave without a decisive action." Schley replied ". . . cannot remain off Santiago present state squadron coal account . . . much to be regretted cannot obey orders of department. . . forced to proceed for coal to Key West by way of Yucatan Passage"; in the controversy that arose out of these events Schley's critics insisted that the "Iowa" and the "Massachusetts" had at this time enough coal to carry them three times the distance from Santiago to Key West.

Sampson with the "New York" had arrived early on the 28th of May off Key West. When Schley's telegram, which had much disturbed the Washington officials, was forwarded to Sampson, he secured permission to go at once to Santiago with the "New York" and "Oregon" (which had arrived at Key West on the 26th of May in excellent condition after her voyage of nearly 16,000 m. from the Pacific) to turn back Schley's heavier ships. Before he started he received a telegram from Schley stating that he would remain off Santiago. It is now known from the documents published by Admiral Cervera that the Spanish squadron, in the interval preceding the 28th, when Schley arrived in sight of the port, was on the point of leaving Santiago. On the morning of the 29th two Spanish cruisers were seen a short distance within the entrance, and on the 31st Schley, with the "Massachusetts," "Iowa" and "New Orleans," stood in and made an attack upon these and the batteries at long range (8500-11,000 yds.). On the 30th Sampson, leaving a squadron on the north side under Commodore Watson, stood for

³ A telegram (not received by Cervera) had been sent to Martinique on the 12th of May, authorizing the squadron's return.

¹ Three of the best were afterwards raised and repaired by American engineers.

² The "Buenaventura," the first prize of the war, was taken by the gunboat "Nashville" off Key West on the 23rd of April.

Santiago at a speed of 13 knots. He arrived early on the 1st of June and work was at once begun on the preparations for sinking the collier "Merrimac" in the entrance channel, which was less than 200 ft. broad in parts available for ships. The preparations for a quick sinking were chiefly carried out by naval constructor Richmond P. Hobson, who went in, in the early morning of the 3rd of June, with a crew of seven men. The steering-gear was disabled by a shell, and the ship drifted too far with the tide and was sunk in a broad part of the channel where it did not block the egress of Cervera's squadron. Cervera sent word to Sampson that Hobson and his men, who had been captured, were unhurt. They were exchanged on the 7th of July.

On the 6th of June the batteries at the entrance were bombarded and their weakness was ascertained. Sampson thereupon placed, every evening, a battleship (relieved every two and a half hours) close in, with a searchlight turned on the channel, making it impossible, as Cervera afterwards said, for the Spanish squadron to escape by night. The port of Guantánamo, 40 m. east of Santiago, was occupied by the "Marblehead" and "Yankee" on the 7th, a battalion of marines from the transport "Panther" landed there on the 10th, and the port was used thereafter as a base and coaling station. On the 14th the Spanish land forces retired before an expedition of the American marines, who remained in occupation until the 5th of August.

A blockade of San Juan, Porto Rico, by one or two fast ships was kept up on account of the presence there of the destroyer "Terror," but this vessel, coming out (June 22) with a gunboat to attack the auxiliary cruiser "St Paul," suffered so severely that she could hardly return to port, and was thereafter unserviceable.

When war was declared the total military forces of the United States consisted of 27,822 regulars and 114,602 militia. An act of the 22nd of April had authorized the president to call upon the states and Territories for men in proportion to their population, the regimental and company officers to be named by the governors of the states, the general and staff officers by the president. A first call was made for 125,000 men, and a month later a second call for 75,000. On the 26th of April large additions to the regular army were sanctioned for the war. The quotas were filled with extraordinary rapidity, and in May 124,776 had volunteered. The troops were concentrated chiefly at Chickamauga, Georgia, at Camp Alger, Virginia, and at Tampa, Florida, **Preparations for a Land Campaign.** which was selected as the point for the embarkation of the expeditionary force for Cuba, and where Major-General W. R. Shafter was in command. With the exception of unimportant small expeditions, everything was delayed until control of the sea was assured, though some thirty large steamers were held in readiness near Tampa. After the arrival of Cervera at Santiago, the blockade of his squadron and the request (June 7) of Admiral Sampson to send a land force for co-operation, the troops embarked on the 7th and 8th of June, but a start was not made until the 14th, owing to a false report that Spanish war-ships were in Nicholas Channel. On the 29th the fleet of 32 transports, under convoy, arrived off Santiago. The whole force consisted of about 17,000 officers and men, 16 light field-guns, a train of heavier pieces, and some 200 vehicles. General Shafter selected Daiquiri, about 18 m. east of Santiago, for the point of landing, and the harbour entrance (preferred by Sampson) was disregarded. The fleet furnished all its available boats, and on the 22nd-25th the army was landed on a rough coast with scarcely any shelter from the sea; after the first day Siboney, 7 m. nearer Santiago, was used as well as Daiquiri. With the exception of three volunteer regiments (the 1st Volunteer Cavalry, known as the Rough Riders, of which Theodore Roosevelt was lieutenant-colonel; the 2nd Massachusetts and the 71st New York Volunteers), these troops were composed almost wholly of regulars, most of whom had served on the plains against the Indians. Soon afterwards more volunteers arrived.

No opposition was made to the landing and the small Spanish contingents at Daiquiri and Siboney were withdrawn without doing

any damage to the equipment of the railway which ran from Santiago to the iron mines at these points. The American troops (commanded by Major-General Joseph Wheeler until the 20th, when General Shafter landed) pushed forward, as soon as they landed, and found a small Spanish rearguard which was covering the concentration of outlying detachments on Santiago and which was entrenched 2½ m. beyond Siboney, at Las Guásimas. Brigadier-General S.B.M. Young with 664 dismounted cavalry engaged (June 24), and after a sharp action, in which he lost 16 killed and 52 wounded, drove back the enemy, of whom 11 were killed and 50 of some 500 engaged. The advance was slow and a week elapsed before Shafter was ready to fight a battle in front of Santiago. Here the defenders, under General Arsenio Linares, held two positions, the hill of San Juan, barring the direct road to Santiago, and the village of El Caney, to the northward of the American position at El Pozo. The plan of attack on the 1st of July was Shafter's, but owing to the illness of Shafter the actual command was exercised by the subordinate generals, Joseph Wheeler, H. W. Lawton and J. F. Kent. General Lawton's division was to attack and capture El Caney, and thence move against the flank and rear of the defenders of San Juan, which would then be attacked in front by Kent and Wheeler from El Pozo. But Lawton for nine hours was checked by the garrison of El Caney, in spite of his great superiority in numbers (4500 to 520); at 3 p.m. the final assault on El Caney was successfully delivered by General A. R. Chaffee's brigade. Only about 100 of the Spanish garrison escaped to Santiago; about 320 were killed or wounded, including General Vara del Rey, who, with a brother and two sons, was killed. In the meantime Wheeler and Kent had an equally stubborn contest opposite San Juan hill, where, in the absence of the assistance of Lawton, the battle soon became a purely frontal-fire fight, and the rifles of the firing line had to prepare the attack unaided. The strong position of the Spaniards, gallantly defended by about 700 men, held out until 12.30, when the whole line of the assailants suddenly advanced, without orders from or direction by superior authority, and carried the crest of the Spanish position. A notable part in the attack was taken by the 1st Volunteer Cavalry or "Rough Riders," commanded by Colonel Leonard Wood and Lieut.-Colonel Theodore Roosevelt. The Spaniards had no closed reserves, and their retreat was made under a devastating fire from the Americans on the captured hills. On the American side over 1500 men out of 15,000 engaged, including several of the senior officers, were killed or wounded; and in one of Kent's brigades three successive commanders were killed or wounded. On the Spanish side, out of the small numbers engaged, over 50% were out of action. Linares himself was severely wounded, and handed over the command to General José Toral. The Cubans on the American right failed to prevent General Escario from entering Santiago with reinforcements from the interior, and at the beginning of the investment General Toral's forces numbered about 10,000 men of the army and a naval contingent from the fleet.

Though victorious, the American army was in danger: after great fatigue under a tropical sun by day, the time spared at night from digging trenches was spent on a rain-soaked ground covered with thick vegetation; the soldiers' blankets and heavy clothing had been cast aside in the attack; and there was insufficient food, because it was difficult to haul supplies over the one poor road from the base of supplies at Siboney. There was even discussion of retiring to a point nearer Siboney. Brisk firing was continued on the 2nd and 3rd of July, with a considerable number of casualties to the Americans. On the morning of the 3rd a demand was sent to the Spanish commander to surrender, with the alternative of a bombardment of the city to begin on the 4th. This in effect had already begun on the 1st, when Admiral Sampson fired a number of 8-in. shells from a point 3 m. east of the harbour entrance over the hills into the city, using a range of about 4½ land miles. The result of this and the threat of General Shafter was an exodus of many thousands of civilians towards El Caney, where the American supplies were heavily taxed to support them.

On the morning of the 3rd of July Sampson, in his flagship the "New York," left the fleet to confer with General Shafter at *Naval* Siboney with regard to combined operations at the *Battle of* harbour entrance.¹ At 9.31, when he had gone about *Santiago.* 5 m., the "Maria Teresa" was seen coming out. The ships in front of the port were the yacht "Gloucester," the battleships "Indiana," "Oregon," "Iowa," and "Texas," the armoured cruiser "Brooklyn" and yacht "Vixen," in the order named from east to west, making a semicircle about 8 m. in length. The "Massachusetts" and "Suwanee" were coaling at Guantánamo. The "Iowa" hoisted the signal "Enemy coming out." All at once stood in toward the Spanish ships, which were standing westwards along shore, and began a heavy fire. The "Maria Teresa" (flagship) was followed at 800-yd. intervals by the "Vizcaya," "Colon" and "Oquendo." They were firing vigorously, but most of their projectiles went far beyond the American ships. The "Brooklyn" (flag of Commodore Schley, the senior officer present) made a turn to starboard, which seems to have caused the "Texas" to stop and back, and to have given the "Colon" the opportunity of passing almost unscathed. The "Maria Teresa" and "Oquendo" had taken fire almost at once, and, as their water mains (outside the protective deck) were cut, they were unable to extinguish the flames: they were run ashore at 10.15 and 10.20 respectively, about 6½ m. west of Santiago, burning fiercely. The "Vizcaya" and "Colon" were still standing westwards: Cervera's destroyers, the "Pluton" and "Furor," had come out last, some distance behind the "Oquendo," and were received with a heavy fire from the "Indiana" and from the unarmoured "Gloucester," which engaged them at close quarters. They attempted to close, but were cut to pieces. The "New York," Sampson's flagship, had passed, and stood on signalling the "Iowa" and "Indiana" to go back and watch the port, lest an attack be made on the American transports. The torpedo-boat "Ericsson" was ordered to rescue the men from the two Spanish ships ashore, and the flagship, with all the others, stood on in pursuit of the "Vizcaya" and "Colon." The "Vizcaya" hauled down her colours off Aserraderos, 15 nautical miles west of Santiago, and was there run ashore burning about 11.15 a.m. The "Iowa" was ordered to stop and rescue her men, and the "Oregon," "Brooklyn" and "Texas" (and behind them the flagship) settled down to the chase of the "Colon," some 6 m. ahead of the nearest American ship. She was, however, slacking her speed, and at 12.40 the "Oregon" opened with her 13-in. guns at a range of 9000 yds., as did also the "Brooklyn," with her 8-in. When the "Oregon" had fired five shells, the "Colon" hauled down her colours, and was beached at the mouth of the Rio Turquino, where in spite of endeavours to recover her, she became a total wreck. The whole Spanish fleet was destroyed; Admiral Cervera was taken prisoner; Captain Villamil, commanding the torpedo flotilla, went down with his ship; and Captain Lazaga of the "Oquendo" was drowned. Over 500 Spaniards were killed or wounded, and the survivors (except a few who escaped to Santiago) were prisoners. On the American side only one man was killed and ten were wounded, and no ship received serious injury.

After the naval victory combined operations were arranged for attacking the batteries of the harbour, but little more fighting occurred, and eventually a preliminary agreement was signed on the 15th, and the besiegers entered Santiago on the 17th. In accordance with the terms of the capitulation, all the Spanish forces in the division of Santiago de Cuba surrendered and were conveyed to Spain. The total number amounted to about 23,500, of whom some 10,500 were in the city of Santiago. The exposure of the campaign had begun to tell in the sickness of the Americans: yellow fever had broken out to some extent; and no less than 50% were attacked by the milder forms of

¹ Shafter had urged that the squadron should enter the harbour and take the city. Sampson (and the Navy department) was unwilling to risk losing a ship in the well-mined harbour and wanted the army to move on the forts and give the American squadron an opportunity to drag the harbour for mines.

malarial fever. The army, indeed, was so weakened by illness that the general officers united in urging its removal from Cuba. Major-General Nelson A. Miles, the general-in-chief, had arrived with reinforcements on the 12th of July, but the majority of these men were retained on board ship.

The fleet and the army gathered in Guantánamo Bay; and a new flying squadron, the "eastern squadron," was organized under Commodore John C. Watson, to proceed by way of the Mediterranean to the Philippines, threatening the Spanish coast, in order to meet a Spanish "reserve squadron," which had been formed towards the end of May, and which was to be sent on to the eastern coast of the United States, and thence to Cuba, but which was diverted toward the Philippines, and left Cadiz, on the 16th of June, for the East. This squadron turned back on the 8th of July after hearing the news of the Spanish defeat at Santiago.

On the 7th of May a telegram had been received from Dewey at Manila: "I control bay completely, and can take city at any time, but I have not sufficient men to hold." The cruiser "Charleston" and the steamer "Peking," with ammunition, supplies and troops, were sent to him at once. Major-General Wesley Merritt, to whom was assigned the command of the troops for the Philippines, first requested a force of 14,000, and afterwards asked for 20,000 men. On the 25th of May the first troops, 2491 in number, under Brigadier-General T. M. Anderson, sailed in three transports from San Francisco, touched at Honolulu, and were convoyed thence by the "Charleston." On the 20th of June possession was taken of the island of Guam, and on the 30th of June the ships arrived in Manila Bay. A second detachment of troops, 3586 in number, under Brigadier-General F. V. Greene arrived on the 17th of July; on the 25th of July General Merritt, who had been appointed governor-general, arrived; and on the 31st the five transports with which he had left San Francisco arrived with 4847 men, making nearly 11,000 men at Manila, with 5000 more on the way. General Merritt moved his forces from Cavite, and established an entrenched line within a thousand yards of the Spanish position at Manila, from which, on the night of the 31st of July, a heavy fire of musketry and artillery was opened, causing a loss to the Americans of 10 killed and 43 wounded, and for the next few days night-firing was frequent from the Spanish lines. On the 7th of August, a joint note from Dewey and Merritt, announcing that bombardment might begin at any time after forty-eight hours, and affording opportunity for the removal of non-combatants, was sent to the Spanish captain-general, Fermin Jaudenes, who replied that he was surrounded by the insurgents,² and that there was no place of refuge for the sick and for the women and children. A second joint note demanding surrender was declined by the Spanish commander, who offered to refer it to Madrid. This was refused, and preparations were made for an attack. There were 13,000 troops within the city fortifications, but with the strong fleet in front, and with the beleaguering force of Americans and insurgents ashore, resistance was hopeless. When the combined assault of army and navy was made on the 13th there was no great resistance, and a white flag was hoisted at 11 o'clock, within one and a half hours after the fleet opened fire, a formal capitulation being signed the next day, the 14th of August. The total loss of the Americans during the whole campaign was 20 killed, 105 wounded.

Immediately after the surrender of Santiago (July 17), preparations were made for the invasion of Porto Rico with 3500 troops which had been sent as reinforcements to Santiago, but had not landed. They were largely reinforced and left Guantánamo, under General Miles, on the 21st of July, convoyed by a strong squadron.

² On the 19th of May, Emilio Aguinaldo, who had been at Hong-Kong, had landed from one of the American vessels at Cavite, and on the 1st of July, when the American troops landed, had proclaimed himself president of the Philippine Republic. The political attitude which he assumed was not sanctioned by the American authorities. At the head of the insurgents he had instituted a close siege of Manila.

Capture of Manila.

Operations in Porto Rico.

Fajardo, at the extreme north-eastern end of the island, was given out as the objective point of the expedition, but after sailing the plans were changed, and the towns on the south side were occupied, practically without resistance. The attitude of the population was exceedingly friendly, and opposition was not met until advance was begun northward. The troops were divided into four columns, advancing from Guanica around the western end of the island to Mayaguez: from Arroyo at the eastern end to meet the San Juan road at Cayey; from Ponce by the fine military road, 70 m., to San Juan; and the fourth column by way of Adjuntas and Utuado, midway of the island. The various movements involved several skirmishes, the chief opposition being met by the western column on the 10th of August, and by the column from Ponce on the 9th, when the Americans lost 1 killed and 22 wounded; the Spanish, 126 killed and wounded, and over 200 prisoners. A further advance on the San Juan highway would probably have developed greater resistance, but news of the suspension of hostilities intervened. The total American loss had been 3 killed and 40 wounded. On the 12th of August operations were begun by the "Newark" and other vessels against Manzanillo. But during the night news arrived of the signing of the peace protocol on the 12th, and of an armistice, of which the Americans were informed by the Spanish commander under a flag of truce.

The total American loss was—in the navy, 1 officer, 17 men killed; in the army, 29 officers, 440 men. The health of the American fleet was kept remarkably. Its average strength during the 114 days of hostilities was 26,102; the deaths from disease during this time were 56, or at the rate of 7 per 1000 per year. As nearly the whole of the service was in the tropics, and in the summer or wet season, this is a convincing proof of the efficiency in sanitary administration. The army did not fare so well, losing by disease during May, June, July and August, 67 officers and 1872 men out of an average total of 227,494. Its larger proportion of illness must of course be ascribed, in part, to its greater hardships. The war department was accused of gross maladministration; but the charges were not upheld by an investigating committee. The lack of proper preparation by the war department and the ignorance and thoughtlessness of the volunteers were the principal reasons for the high death-rate in the army.

For the terms of the peace and the results of the war see UNITED STATES; PHILIPPINE ISLANDS; CUBA; PORTO RICO.

The literature of the Spanish-American War is voluminous: amongst the principal sources of information may be mentioned: The annual reports of various departments for 1898, especially the *War Notes* of the Office of Naval Intelligence, Washington, which include Spanish translations, and the appendix to the report of the Bureau of Navigation; R. H. Titherington, *A History of the Spanish-American War* (New York, 1900); H. C. Lodge, *Story of the Spanish War* (New York, 1899); H. W. Wilson, *The Downfall of Spain* (London, 1900); W. A. M. Goode, *With Sampson through the War* (London, 1899); J. Wheeler, *Santiago Campaign* (Philadelphia, 1899); Theodore Roosevelt, *The Rough Riders* (New York, 1899); C. D. Sigsbee, *Personal Narratives of the Battleship Maine* (New York, 1899); R. A. Alger, *Spanish-American War* (New York, 1900); Gomez Nuñez, *La Guerra hispano-americana* (Madrid, 1900); H. Kunz, *Taktische Beispiele aus den Kriegen der Neuesten Zeit II.* (Berlin, 1901); Admiral Plüddemann, *Der Krieg um Cuba 1898* (Berlin); John D. Long, *The New American Navy* (2 vols., New York, 1903); John R. Spears, *Our Navy in the War with Spain* (ibid., 1898); Bujac, *Précis de quelques campagnes contemporaines*, IV. (Paris, 1899); and the *Century* and *Scribner's* magazines for 1898 and 1899 *passim*.

SPANISH BROOM, a handsome shrub with long switch-like green few-leaved or leafless branches and large yellow sweet-scented papilionaceous flowers. It is a member of the Pea family (Leguminosae), and known botanically as *Spartium junceum*. It is a native of the Mediterranean region and the Canary Islands, and is often cultivated. The whole plant, but especially the flower shoots and seeds (*herba et semen genistae hispanicae vel juncea*), have a bitter taste and tonic and diuretic properties, and were formerly used medicinally. The fibres of the young stems were used in making nets, carpets, mats, baskets, &c.

SPANISH REFORMED CHURCH (Iglesia española reformada), a small community of Protestants in Spain organized on the model of the Anglican Church. This body of Spanish Episcopalians had its origin in a congregation which met for the first time, in June 1871, in the secularized church of San Basilio at Seville, under the leadership of Francisco Palomares, a priest who had left the Roman communion. Before long it was joined by numbers of lay people and several clergymen, including Juan Cabrera, an ex-Roman priest, who had for some time been a Presbyterian minister. In July 1878 a memorial was presented to the Lambeth Conference by nine congregations in Spain and Portugal (see below) asking for the episcopate. The reply expressed the sympathy of the bishops, but only suggested that Dr Riley, recently consecrated by the Protestant Episcopal Church of the United States to minister to the reformed congregations in Mexico, should be invited to visit them and ordain and confirm for them. Archbishop Tait wrote a formal letter to Bishop Riley to this effect, and the request was complied with. A second petition for the episcopate was sent to the Irish bishops in 1879, and early in 1881, at their request, Lord Plunket paid his first visit to the Spanish Reformed Church, though nothing immediately resulted from it. In 1880 the first "synod" of the Church was held, under the presidency of Bishop Riley; the principles of the Church were laid down, Señor Cabrera was chosen bishop-elect, the preparation of a liturgy was begun, and the Thirty-nine Articles of Religion of the Church of England, with certain modifications, were formally adopted as a standard of doctrine. Archbishop Plunket continued his efforts on their behalf; and at length the Irish bishops, having again received from them a petition for a bishop, brought the matter before the Lambeth Conference of 1888. The conference deprecated "any action that does not regard primitive and established principles of jurisdiction and the interests of the whole Anglican communion." The archbishop interpreted this as a modified consent; but the Irish bishops understood it otherwise, and again declined to consecrate a bishop for them. Meanwhile the movement prospered, being largely helped with money from friends in England. The foundation-stone of a new church was laid in Madrid in 1891, on the site of the *Quemadero*, where the *autos de fé* were formerly held; and after considerable legal and other difficulties, religious toleration in Spain being still imperfect, it was dedicated and opened for service. At length, at the meeting of the Irish House of Bishops on the 21st of February 1894, a letter was read from the archbishop of Dublin and the bishops of Clogher (C. M. Stack) and Down (C. Welland), in which they declared their intention, unless a formal protest were made by the bishops, or by the general synod, to consecrate bishops for the Reformed churches in Spain and Portugal, subject to certain conditions being fulfilled by those churches. The bishops resolved, *nemine contradicente*, although the bishops of Derry (W. Alexander, subsequently primate of Armagh) and Cork did not vote, that they would not regard such action as "an indefensible exercise of the powers entrusted to the episcopate"; and the general synod passed a resolution leaving the matter in the hands of the bishops. Accordingly, on the 23rd of September 1894, the three bishops laid hands on Señor Cabrera. The matter occasioned no little stir in the English Church, more especially as the Old Catholic bishops (see OLD CATHOLICS) had recently refused to take any part in the matter. It called forth a letter of protest and repudiation from Lord Halifax, as president of the English Church Union, to Cardinal Monescillo, archbishop of Toledo; and this in turn evoked a letter from Cardinal Vaughan, which was widely circulated in Spain.

The consecration of Bishop Cabrera certainly produced, from the point of view of Anglican churchmen, a somewhat anomalous state of things, and the action, or inaction, of the Irish bishops laid them open to criticism from many who were not unfriendly to such movements (see e.g. Bishop John Wordsworth, *Ministry of Grace*, pp. 176-177, London, 1901). Objection was made to the act as contrary to church order, and as unjustifiable in view of the nature of the Spanish Reformed Church itself. As regards the latter, it is true that the Prayer-book of the body (first

made in 1881 and published in a revised form in 1889) cannot really justify the claim made on its behalf as a "revised Mozarabic rite": it contains indeed many beautiful prayers from the Mozarabic and other offices, but its doctrinal teaching is more unambiguously "Protestant" than that of the English Prayer-book. The Church possessed in 1906 ten congregations with some dozen clergy.

Lusitanian Church.—A similar movement began in Lisbon in 1867, owing to the work of a Spanish priest there, Señor Mora; and at first its success was even greater than the movement in Spain, in spite of the fact that Portuguese priests who left the Roman communion had either to leave Portugal or to become subjects of another power. In 1875 the adherents of this movement threw in their lot with their Spanish brethren, and when Bishop Riley visited them in 1878 the Portuguese members organized themselves as the "Lusitanian Church," and the Rev. T. Godfrey Pope, D.D. (d. 1902), the English chaplain at Lisbon, was subsequently chosen by them as president of the synod. A request made to the Irish bishops in 1897 for the consecration of Canon Pope as their bishop led to an examination of the Lusitanian Prayer-book, which was found to be even more defective from the Anglican point of view than that of the Spanish Reformed Church. Consequently no action was taken. In 1906 the Church had only some 500 adherents with five clergy.

AUTHORITIES.—H. E. Noyes, *Church Reform in Spain and Portugal* (London, 1897); F. D. How, *Life of Archbishop Plunket* (London, 1900); A. C. Benson, *Life of Archbishop Benson*, vol. ii. (London, 1899); *Oficios divinos, &c. en la iglesia española reformada* (Madrid, 1898; Eng. trans., Dublin, 1889; new ed., 1894); *Divine Offices and other Formularies of the Reformed Episcopal Churches of Spain and Portugal* (London, 1882); *Church Quarterly Review*, xxxviii. 283 (July 1894), art. "The Proposed Episcopate for Spanish Protestants."

SPANISH SUCCESSION, WAR OF THE, the name given to the general European war which began in 1701 and ended with the Treaties of Utrecht and Rastatt in 1713-14. The war in its *ensemble* is the typical "war with limited aim," carried out by professional armies in the interests of sovereigns and their cabinets and (except in the last stages of the war in northern France) enlisting no more than the platonic sympathies of the various peoples whose rulers were at war. Nevertheless, its monotonous round of marches and sieges is now and then quickened by the genius of three great soldiers, Marlborough, Eugene and Villars, and Peterborough and Galway, Catinat and Vendôme, though less highly gifted, were men of unusual and conspicuous ability. As usual in these wars, manœuvres, threats and feints played the principal part in field warfare. The soldiers of those days were too costly to be squandered on indecisive battles, and few generals of the time either knew how to make a battle a means of definitively settling the quarrel or had the influence and force of character to extort from their sovereigns permission to play for high stakes. The tangible assets, at the conclusion of peace, were fortresses and provinces; and the effective seizure of fortresses and provinces, "here a little, there a little," was in most cases the principal object with which kings and princes made war. Nevertheless, at the time of the Spanish Succession War the generals had not yet wholly reconciled themselves to their new position of superior chess-players. Moreover, the object of the war, at least in the case of England and Holland, was less to add a few cities and districts to their own domains than to cripple the power of Louis XIV. The ambition of the *Grand Monarque* had stepped beyond these narrow limits, and by placing on the throne of Spain his grandson Philip he had brought into politics the fear not merely of a disturbance but of an entire overthrow of the "balance of power." Thus the instrument of his ambition, his magnificent army, was (above all for England) an object in itself and not merely an obstacle to the attainment of other objects. Many of the allies, however, had good reason to fear for their own possessions, and others entered the alliance with at least the hope of acquiring a few material gains at small expense. On the side of the allies therefore, throughout the war, there was a perpetual struggle between offensive activity and defensive passivity, and within the category of "activity"

two very different forms of offensive alternately prevailed, the decision of the main question by the sword and the seizure of a minor object by stratagem. Were it not for the existence of this struggle, indeed, the war would be devoid of interest. Later in the 18th century there was, as a rule, no such struggle, for the grander form of offensive died out completely, and the feebler form was easily reconciled with the requirements of passive defence. But in 1700 the true spirit of war—in a leader of the greatness of Marlborough at least—was not yet entirely smothered by chicanery.

The action of Louis XIV. in the matter of the Spanish succession was foreseen, and William III. of England had devoted his last years to providing against the emergency by the formation of a coalition to deal with it, and the production of a claimant for the Spanish throne, the archduke Charles. The coalition naturally grew out of the Grand Alliance (see **GRAND ALLIANCE, WAR OF THE**), and consisted of Austria, some of the German states, Great Britain, Holland, Denmark and Portugal. On the other side Louis XIV. was supported by Spain—where Philip, recognized as heir by the dying Charles II., had been promptly installed—Bavaria and Cologne. A doubtful ally was the duke of Savoy, whose policy was to secure and aggrandise himself by adhering at each moment to the stronger party. The alliance of Louis with the discontented prince of Hungary and Transylvania Rakocsy was rather an impediment to his enemy than a direct assistance to himself.

The war began, to all intents and purposes, with the handing over of the fortresses in the Spanish Netherlands to the French in March 1701. England and Holland at once began their preparations, but neither state was able to put an army in the field in the year—England because her peace-time army was absolutely insignificant, and Holland because she dared not act alone. In Italy, however, the emperor took the initiative, and an Austrian army under Prince Eugene, intended to overrun the Spanish possessions in the Peninsula, assembled in Tirol in the early summer, while the opposing army (French, Spaniards and Piedmontese), commanded by Marshal Catinat, was slowly drawing together between the Chiese and the Adige. But supply difficulties hampered Eugene, and the French were able to occupy the strong positions of the Rivoli defile above Verona. There Catinat thought himself secure, as all the country to the east was Venetian and neutral. But Eugene, while making ostentatious preparations to enter Italy by the Adige or Lake Garda or the Brescia road, secretly reconnoitred passages over the mountains between Roveredo and the Vicenza district. On the 27th of May, taking infinite precautions as to secrecy, ^{*Carpi and Chiari, 1701.*} and requesting the Venetian authorities to offer no opposition so long as his troops behaved well, Eugene began his march by paths that no army had used since Charles V.'s time, and on the 28th his army was on the plains. His first object was to cross the Adige without fighting, and also by ravaging the duke of Mantua's private estates (sparing the possessions of the common people) to induce that prince to change sides. Catinat was completely surprised, for he had counted upon Venetian neutrality, and when in the search for a passage over the lower Adige, Eugene's army spread to Legnago and beyond, he made the mistake of supposing that the Austrians intended to invade the Spanish possessions south of the Po. His first dispositions had, of course, been for the defence of the Rivoli approaches, but he now thinned out his line until it reached to the Po, and after five weeks' cautious manœuvring on both sides, Eugene found an unguarded spot. With the usual precautions of secrecy (deceiving even his own army), he crossed the lower Adige in the night of the 8th-9th of July, and overpowered the small cavalry corps that alone was encountered at Carpi (July 9). Catinat at once concentrated his scattered army backwards on the Mincio, while Eugene turned northward and regained touch with his old line of supply, Roveredo-Rivoli. For some time Eugene was in great difficulties for supplies, as the Venetians would not allow his barges to descend the Adige. At last, however, he made his preparations to cross the Mincio close to Peschiera and well beyond Catinat's left, with the intention

of finding a new supply area about Brescia. This was executed on the 28th of July, Catinat's cavalry, though coming within sight of Eugene's bridges, offering no opposition. It seems that the marshal was well content to find that his opponent had no intention of attacking the Spanish possessions in the Peninsula, at any rate Catinat fell back quietly to the Oglio. But his army resented his retreat before the much smaller force of the Austrians and, early in August, his rival Tessé reported this to Paris, whereupon Marshal Villeroy, a favourite of Louis, was sent to take command. The new commander was perhaps the least competent of all the French senior officers, and ere long he attacked Eugene in a well entrenched position at Chiari (Sept. 1), and was thoroughly defeated, with a loss, it is said, of 3000 to the Austrians' 150. Both armies then stood fast until the exhaustion of supplies compelled them to move, when Villeroy retreated to the Adda. Both Villeroy and Catinat (who had remained with him as second-in-command), warned the king of the duplicity of the duke of Savoy, who, for all the reckless bravery that he had displayed in attempting to storm his cousin's entrenchments, was in reality already intending to change sides.

As yet there was no declaration of war by either party. Preparations were made by both sides during the year, most vigorously of all by Louis, who set on foot no less than 450,000 regulars and embodied militia, and had always prided himself on being first in the field. But the début was disheartening, and in the winter a fresh mishap befell the French. Eugene, who had taken up his winter quarters in such a way as to play upon Villeroy's fears of an invasion of Naples, surprised Cremona on the night of the 1st of February 1702, and, after a confused fight, drew off, taking with him Villeroy as a prisoner. The brave but incapable marshal was however little loss, and the French troops, many of them surprised in their beds, had yet managed to expel Eugene's men. The rest of the French army, instead of marching to the guns in the 19th-century manner, retreated in the 18th-century manner, while Eugene quietly resumed his winter quarters and his blockade of Mantua.

With the year 1702 the real struggle began. Villars and one or two others of Louis's best counsellors urged the king to concentrate his attention on the Rhine and the Danube, where, they pointed out, was the centre of gravity of the coalition. This advice was disregarded, and with political aims, which it is hard to imagine, the largest French army was employed on the side of the Meuse, while the Rhine front was entrusted to smaller forces acting on the defensive. In Italy the balance of power remained unchanged, except that one of Louis's best generals, Vendôme, was sent to replace the captured Villeroy. In the Low Countries, Ginckell, earl of Athlone, the interim commander of the allies (English, Dutch and minor German states), was at the outset outmanœuvred by the French (Boufflers), and although, in fact, the material advantage was with the allies, who captured Kaiserswerth on the Rhine, the momentary threat of a French invasion had a lasting effect on the Dutch authorities, whose timidity thereafter repeatedly ruined the best-laid schemes of Marlborough, who was obliged to submit to their obstruction and their veto. This handicap, moreover, was not the only one

Marlborough's First Campaign. under which Marlborough suffered. Unless it is realized and borne in mind that the great captain was struggling against factiousness and intrigue in England and from jealousies, faint-heartedness and disagreements amongst the states who lent their contingents to his miscellaneous army, the measure of his achievements in ten years seems small. But in fact it was marvellous. Under 18th-century conditions of warfare, and with an army so composed that probably no other man in Europe could have held it together at all, obstructed and thwarted at every turn, he yet brought Louis XIV. and France to the very edge of ruin.

In this theatre of war the French, in concert with the garrisons of the Spanish Netherlands, had fortified a line of defence more than 70 m. long from Antwerp to Huy, as well as another line, longer but of only potential importance, from Antwerp along the Scheldt-Lys to Aire in France. Besides the "lines of Brabant" Boufflers held all the Meuse fortresses below Huy except Maes-

tricht. Marlborough concentrated 60,000 men (of whom 12,000 only were British) about Nijmegen in June, and early in July, having made his preparations, he advanced directly by Hamont on Diest. Boufflers, who had drawn together his field army in Gelderland for the relief of Kaiserswerth and the late attack on the earl of Athlone, hastily fell back, in order to regain touch with the Brabant lines. Marlborough, with the positive object of bringing his opponent to battle at a disadvantage, won the race and awaited the arrival of Boufflers' tired army to strike it a paralysing blow. But at the critical moment the Dutch deputies forbade the battle, content to see the army that had threatened Holland with invasion driven off to a safe distance without bloodshed (July 22). Ten days later Boufflers, thus easily let go, again advanced from Diest, was trapped by Marlborough and released by the Dutch. This time it was a disobedient general, not the civilian commissioners at headquarters, who did the mischief, but after this second experience Marlborough thought it prudent to pacify the Dutch by besieging the Meuse fortresses, several of which fell in rapid succession (September-October). His return to the Meuse led Boufflers to suppose that the enemy had a Rhine campaign in view and he at once sent off a corps under Tallard towards Cologne, standing on the defensive himself at Tongres, where for the third time in the campaign he was outmanœuvred by Marlborough and saved by the deputies at Marlborough's headquarters. Boufflers hurriedly fell back within the defended area of the lines of Brabant, and the campaign closed with the capture of Liège by the allies (Oct. 12). Marlborough was created a duke on his return to England in November. He had checked the main enterprise, or at least (for an enterprise commensurate with the force employed had scarcely been imagined) the main army, of the French. Every man in the army knew, moreover, that but for the Dutch deputies the enemy would have been destroyed.

On the Rhine the campaign was, except for two disconnected episodes, quite uneventful. The Imperialists under a methodical general, the margrave Louis of Baden, gathered in the Neckar country and crossed the Rhine above Spire. Catinat, now old and worn out, was sent to Strassburg to oppose the threatened invasion of Alsace, and, like MacMahon in 1870, he dared not assemble his whole force either on the Lauter or on the Ill. The margrave invested Landau (July 29) and with a covering army occupied the lines of the Lauter about Weissenburg, which Catinat did not attack. Hence Landau, valiantly defended by Melac, had to be surrendered on the 12th of September. But at the same time the elector of Bavaria took the side of France, surprised Ulm, and declared a local war on the house of Austria and the "circles" of Swabia and Franconia. The margrave then, in order to defend his own country, prevent the junction of Catinat's forces with the elector, and win back the latter to the Austrian side, recrossed the Rhine and hurried to Kehl with the greater part of his army, leaving a garrison in Landau and a corps of observation on the Lauter. To co-operate with the elector, Catinat had made up a corps out of every available battalion and squadron (keeping for himself not more than a personal escort) and placed it under Lieut.-General Villars. This corps drew away into Upper Alsace and the margrave followed suit until the two armies faced one another on opposite sides of the Rhine near Huningen. But the corps that the elector on his part was to send to meet Villars **Friedlingen.** halted east of the Black Forest, and although, on the 14th of October 1702, after a series of skillful manœuvres, Villars crossed the Rhine and won the first victory of his brilliant career at Friedlingen (opposite Huningen), it was profitless. Soon afterwards Villars placed his army in winter quarters in Alsace, and Louis of Baden disposed his troops in two entrenched camps opposite Breisach and Strassburg respectively. In Italy Vendôme, superior in numbers but handicapped by instructions from Versailles and by the necessity of looking to the Italian interests of King Philip, gained a few minor successes over Eugene. A very hard-fought and indecisive battle took place at Luzzara on the Po on the 15th of August.

In the next two years Bavaria was the centre of gravity of the

French operations, and only campaigns of the methodical and non-committal kind were planned for Italy¹ and the Low Countries. Villeroy and Boufflers commanded the French in the Low Countries, Tallard in Lorraine, Villars in Alsace, and Vendôme in Italy.

In the Netherlands the French field army was behind the lines of Brabant, the Spanish troops in the lines of Flanders (Antwerp-Ghent-Aire). Together the two considerably outnumbered Marlborough (90,000 against 50,000), but the duke managed to be first in the field. As early as February Rheingberg had been taken, and in May he followed up this success by the capture of Bonn, returning to the Meuse before Villeroy had assembled his army at Diest. Marlborough's plan was to break the immensely long line of defence of the French and Spaniards by the capture of Antwerp. One Dutch corps under Coehoorn was to assemble in the Sluys-Hulst region, and another under Opdam at Bergen-op-Zoom and Marlborough, after manœuvring Villeroy's field army out of the way, was to join them before the fortress. Marlborough executed his own share of the movement with his usual skill, he pushed back Villeroy towards the Meuse and at the right moment, giving them the slip, marched for Antwerp via Hasselt. Villeroy, soon discovering this, hastened thither as fast as possible, and the Dutch generals enabled him to emerge from the manœuvre with a handsome victory, for Coehoorn (in order to fill his own pockets, it has been suggested) had departed on a raid into West Flanders and Opdam was left alone at Eeckeren in front of Antwerp, where Boufflers and the Spanish general Bedmar surprised him (June 30) and put his corps to flight before Marlborough could come to his assistance. In disgust the great captain then resigned himself to a war of small sieges on the Meuse. The campaign closed with the capture of Huy (Aug. 25) and Limbourg (Sept. 27). On the Rhine great projects were entertained by the French, nothing less than the capture of Vienna by a combined Franco-Bavarian-Hungarian army being intended. Villars began by capturing Kehl (March 10) under the very eyes of the margrave, who dared not risk a battle lest the Bavarians coming up in his rear should destroy his weakened army. The Bavarians had in fact no such intention. The elector, while carrying on a trifling war with a small imperial army under Count Styrum, insisted that Villars should cross the Black Forest and join him, which Villars was unwilling to do thus early in the year, as two-thirds of his officers were as usual on leave or detached on recruiting duties. Courtier though he was, the marshal would not stir even in spite of the king's orders until he was ready. At the end of April, leaving Tallard alone to defend Alsace and Lorraine against the margrave, Villars plunged into the defiles of the Black Forest and on the 8th of May joined the elector at Ebingen. All seemed favourable for the advance on Vienna, but at the last moment the elector half repented of his alliance with the enemies of Germany and proposed instead a junction with Vendôme by way of Tirol. This proposal came to nothing, the Tirolese were soon roused to revolt by the misconduct of the ill-disciplined Bavarians, and Vendôme, who, like Luxembourg, was a giant in battle and a sluggard in camp, would not stir. The active Villars meantime was reduced to impotence and faced Styrum in an entrenched camp at Dillingen on the Danube, neither side offering battle.

Villars had posted a protective force at Ulm to contain the margrave's army should it turn back upon him, and this, after an engagement at Munderkingen (July 31) induced the cautious Louis to return to the Rhine. Five weeks later, however, the margrave returned in full force, and moving by the right bank of the Danube reached Augsburg on the 6th of September. The elector, returning from his futile Tirol expedition, had already rejoined Villars at Dillingen, and the marshal persuaded him to attack Styrum before the two imperial generals could join

¹ In this year began the Camisard insurrection, in the Cevennes, which necessitated the detachment of a considerable body of troops from Vendôme's army in Italy. Similarly both in 1702 and 1703 the Hungarian insurrection compelled the Viennese government to keep back the reinforcements of which Eugene stood in need.

forces. The result was the battle of Hochstett² (Sept. 20) in which the elector and Villars won a great victory, at a loss of only 1000 men to Styrum's 11,000. Rarely indeed had an 18th-century general so great an opportunity of finishing a war at one blow. But even Villars saw no better use for the *Hochstett*, victory than the unimpeded junction of his own army *1703*, and Tallard's and winter quarters in Württemberg, and the elector on the other hand was principally anxious to evict the margrave's army from his dominions. The question was referred to Versailles, and another month passed away in inactivity. Tallard remained on the Rhine, and Villars in disgust applied to be recalled. The margrave, entrenched as usual, kept the field for another month and then retired to the Lake of Constance, where, in a still unexhausted district, he spent the winter. The elector wintered in the Iller with the combined army. Tallard meanwhile invested Landau and defeated a detachment sent from Marlborough's distant army to relieve the place in the battle of Spire (Nov. 10), which was almost as costly to the allies as Hochstett. Landau surrendered on the 12th of November. Old Breisach, besieged by Vauban, capitulated on the 6th of September. Thus in Germany, though the grand advance on Vienna had come to nothing, the French had won two important victories and established an army in Bavaria. More than this, under the prevailing conditions of warfare, it was impossible to expect. In Italy, on the other hand, Vendôme, although no longer opposed by Eugene, achieved nothing. After a raid towards Trieste he was brought back hurriedly by the news that Victor Amadeus of Savoy had changed sides, and though he was victorious in a few skirmishes and re-established touch with France by capturing Asti, he failed to prevent the Imperialists, under Guido Starhemberg, from slipping past his position in Lombardy and joining the duke of Savoy in Piedmont.

The campaign of 1704, though in the Low Countries and in Italy practically nothing was done, is memorable for what was probably the greatest strategical operation in the 18th century, Marlborough's march to the Danube. At the outset the elector and Marsin (Villars' successor) were on the Iller, between Ulm and Memmingen, Tallard between Strassburg and Landau, Villeroy as usual between the Brabant lines and the Meuse. Between Villeroy and Tallard there was a small force on the Moselle, intended to reinforce either. On the other side the Margrave Louis was in the Stockach-Engen region, with his own army and the relic of Styrum's, but being responsible for guarding the whole of the Middle Rhine as well as for opposing the elector he was weak everywhere, and his defence of the Rhine was practically limited to holding the "lines of Stollhofen," a defensive position near Bühl in Baden. With Breisach and Kehl in their own hands, the French were more or less closely in touch with their comrades in Bavaria, and Tallard convoyed a large body of recruits for Marsin's army through the Black Forest defiles. But in doing so he lost most of them by desertion, the margrave's army dogged his march, and in fact no regular line of communication was established. Thus *Rhine and Danube Campaign of 1704*, the five armies (Marlborough's, Eugene's, Tallard's, Marsin's and the margrave's) engaged in this theatre of war, were moving and facing in all directions in turn in a most bewildering fashion. Marlborough's purpose at any rate was quite definite—to transfer a large corps from the Low Countries to Bavaria and there in concert with the allies in that quarter to crush the elector decisively. He took no one into his confidence. The timid Dutch were brought, not without difficulty, to assent to a Lower Rhine and Moselle campaign, of much the same sort as the Bonn expedition of 1703, but rather than be burdened with Dutch counsellors he forwent the assistance of the Dutch troops. These were left under Overkirk to defend the Meuse, and English and English-paid troops alone took part in the great venture. Meanwhile Tallard and Marsin, united at the moment of handing over the recruits, had promptly separated again. Tallard, Villeroy and the Versailles strategists,

² Fought on the same battlefield as was Blenheim next year; the latter is consequently called by some the "second battle of Hochstett."

well aware that Marlborough was ascending the Rhine, thought that a diversion on the Moselle was intended, and the feeble warnings of Marsin, who half suspected the real purpose, were disregarded. Villeroy remained in Brabant for fear that Overkirk would take a few towns in his absence.

Marlborough calculated that as he progressed up the Rhine the French would collect to prevent his crossing, instead of themselves passing over to join the elector and Marsin. Thus the expedition would reach the Neckar mouth, without its true purpose being suspected, and once there Marlborough would vanish from the ken of the defenders of the Rhine, to reappear on the Danube where he was least expected. On the 12th of May the army crossed the Meuse at Ruremond, on the 23rd it reached Bonn, on the 29th Mainz. On the 1st of June the puzzled French noted preparations for bridging the Rhine at Philipsburg. But two days later the English had turned to their left into the valley of the Neckar. On the 10th of June Prince Eugene and on the 13th the margrave appeared at the duke's headquarters to concert operations. It was arranged that the margrave was to join Marlborough and that Eugene should command the Stollhofen

Marlborough's March to the Danube. and other forces on the Rhine, for Tallard, it seemed, was about to be joined by Villeroy¹ and Marlborough knew that these marshals must be kept west of the Rhine for the six weeks he allowed himself for the Bavarian enterprise. The margrave's army duly joined Marlborough's on the 22nd of June at Ursprung, 12 m. north of Ulm, where the elector and Marsin were encamped. The endurance of Marlborough's corps, as displayed in the long march from Ruremond, was not the least extraordinary feature of the operation. For 18th-century troops such performances were generally provocative of desertion, and involved the ruin of the army that attempted it. But Prince Eugene, we are told, was astonished at the fine condition of the army. On the French side meantime all was perplexity, and it was not until a week after the margrave and Marlborough had united that a decision was arrived at by Louis XIV., in whose eyes the feeble corps of Eugene sheltered in the lines of Stollhofen constituted a grave menace for Alsace and Lorraine. Villeroy's main body from the Meuse had after its first hesitations followed up Marlborough, in readiness for the supposed Rhine and Moselle campaign, and was now about Landau. Tallard with the smaller half of the united armies was to advance by Breisach and to "try to capture Villingen." Villeroy was to watch Eugene's corps, or rather the Stollhofen-Bühl position, and the small Moselle corps was to remain west of the Rhine. This meant conceding both the initiative and the superiority in numbers to Marlborough.

The duke had now manœuvred himself with brilliant success from one theatre of war to another, and had secured every advantage to himself. His method of utilizing the advantage showed his mastery of the rules of the strict game that, with the instinct of a great captain, he had just set at nought. From before Ulm he sidled gradually along the north side of the Danube in the hope of finding an unguarded passage. He and the margrave exercised the general command on alternate days, and when on his own day he arrived opposite Donauwörth, knowing Louis's caution, he thought that direct attack was better than another two days' extension to the east. Moreover he needed a walled town to serve as a magazine instead of Nördlingen, which he had used of late but which could not serve him for operations over the river. In the late afternoon of the 21st the army was flung, regardless of losses, against the entrenched hill of the Schellenberg at Donauwörth, where the elector had posted a strong detachment. The attack cost 6000 men, but it was successful, and of the 12,000 Bavarians on the hill only 3000 returned to their main body, which had now moved from Ulm to Lauingen. Passing the river, the allies besieged and took the small fortress of Rain, and thence moved to the neighbourhood of Augsburg, thoroughly and deliberately devastating the countryside so as to force the elector to make terms. The best that can be said of this barbarous

¹ Even Villeroy it appears rose to the situation thus far, but the king only allowed him to send 25,000 men to Tallard.

device, more or less legitimate in the days when the quarrel was the people's as much as the prince's, is that Louis XIV. had several times practised it. Its most effective condemnation is that military devastations, in these purely political contests, were entirely unprofitable. Louis had already found them so, and had given up the practice. In the present case the acts of the allies only confirmed the elector in his French sympathies, while at the same time Marlborough's own supplies ran short, his convoys were harassed and his reconnaissances impeded. The movements of the two armies were but trifling. Marlborough, though superior, was not decisively superior, and his opponents, well entrenched near Augsburg, waited for Tallard and (in vain) for Villeroy. Marlborough marked time until Eugene should join him.

There were now five armies in the field, two allied and three French. The centre of gravity was therefore in Villeroy's camp. If that marshal followed Tallard, even Eugene's junction with Marlborough would not give the latter enough force. If Tallard alone joined the elector and Eugene Marlborough, the game was in the hands of the allies. But none of the possible combinations of two armies against one were attempted by either side. Eugene did not venture to leave Villeroy's front to attack Tallard, who was marching by Kehl-Villingen-Ulm on Augsburg, but when he knew that Tallard was on the move he slipped away from Villeroy to join Marlborough. In turn, Tallard and the elector, aware of Eugene's march, could have left Marlborough to his sieges and combined against Eugene, but they were well content to join forces peaceably at Augsburg. Worst of all, Villeroy, in whose hands was the key of the situation, was the nearest to Versailles and the least capable of solving the knotty problem for himself. When the king bade him follow Tallard to Villingen he hesitated, and when he had made up his mind to try, Louis had changed his and ordered him to detain Eugene (who was already far away) in the Stollhofen lines. The last stage of the campaign was brief. Marlborough and Eugene had in mind a battle, Tallard and Marsin a war of manœuvre to occupy the few weeks now to be spun out before winter quarters were due. The two allied armies met in the Danube valley on the 6th of August. If the enemy remained on the south side Eugene was to cross, if they recrossed to the north bank Marlborough was to follow suit. The margrave Louis of Baden had been sent off to besiege Ingolstadt as soon as Eugene had come within a safe distance. The 18th-century general relied far more on himself than on the small surplus of force that his army, in the conditions of that time, could hope to have over its opponent. When therefore the French and Bavarians were reported opposite Eugene on the north side, Marlborough crossed at once, and without waiting for the margrave the two great soldiers went forward. On the 2nd of August (see *BLenheim*) they attacked and practically destroyed the armies of Tallard, Marsin and the elector.

The campaign of 1705 was uneventful and of little profit to either side. Marlborough's army had returned to the Low Countries, engaging *en route* in a small campaign in the Luxemburg and Thionville region, which was defended with skill and success by Villars. Villeroy had also returned to Brabant and retaken Huy. With him was the now exiled elector of Bavaria. On the 18th of July, after a series of skilful manœuvres, Marlborough forced the lines of Brabant at Elissem near Tirlemont, but not even the glory of *Blenheim* could induce the Dutch deputies to give him a free hand or the Dutch generals to fall in with his schemes. King Louis was thus able to reinforce Villeroy betimes from Villars's Lorraine army, and the campaign closed with no better work than the razing of the captured French entrenchments. On the Rhine Villars, with a force reduced to impotence by the losses of *Blenheim* and the detachments sent to Villeroy, carried on a spiritless campaign about Hagenau and Weissenburg against the margrave Louis. In Italy alone was there any serious encounter. Here Vendôme's army and a fresh corps from France were engaged in the attempt to subdue Victor Amadeus and his new Austrian allies (*Starhemberg's*, originally Eugene's army), and they were

Campaign of 1705.

so far successful that the duke implored the emperor to send a fresh army. Eugene commanded this army, opposed to which was a force under Vendôme's brother Philippe, called the Grand Prior. This man, a lazy diletante, let himself be surprised by Eugene's fierce attack on the line of the Adda. The day was restored however, and the Austrians beaten off, thanks to Vendôme's opportune arrival and dauntless courage (battle of Cassano, August 16). Nevertheless, the subjugation of Piedmont was put off until next year, by Louis's orders.

1706 was a bad year for the French. At the very outset of the campaign in the Netherlands, Villeroy, hearing that some of the allied contingents that composed Marlborough's army had refused to join, went forward from his new defensive lines along the Dyle and offered battle. Marlborough would probably have fought in any case, but being joined in time by the belated allied contingents, he was able (May 12) not only to win but also to profit by the glorious victory of Ramillies (*q.v.*) on the 12th of May. This was one of the few cases of thoroughly efficient and successful pursuit in the military history of the 17th and 18th centuries. The whole of Flanders and Brabant, except a few minor fortresses, fell into his hands within two weeks. These too fell one after the other in August and September, and the British cavalry crossed the French frontier itself. But on the Rhine the inactivity of Louis of Baden had allowed Villars to transfer the bulk of his army to the Netherlands. Vendôme, too, was sent to succeed Villeroy, and Marlborough made no further advance. Louis's two most brilliant commanders devoted themselves to organizing the defence of the French frontier, and did not venture to interrupt Marlborough's sieges.

In Italy the campaign had, as before, two branches, the contest for Piedmont and the contest between the French forces in Lombardy and the Austrian second army that sought to join Victor Amadeus and Starhemberg. The latter, repulsed by

Vendôme at Cassano, had retired to Brescia and Lake Garda, Vendôme following up and wintering about Castiglione and Mantua, and in April 1706, profiting by Eugene's temporary absence, Vendôme attacked the Imperialists' camp of Montechiaro-Calcinato. His intention was by a night march to surprise the post of Ponte San Marco on their extreme left, but when day came he noticed that he could give battle to the enemy's left wing at Calcinato before their right from Calcinato. Montechiaro could intervene. His onset broke up the defence completely (battle of Calcinato, April 19), and he hustled the fragments of the Imperialist army back into the mountains, where Eugene had the greatest difficulty in rallying them. Until the middle of June Vendôme completely baffled all attempts of Eugene to slip past him into Piedmont. He was then, however, recalled to supersede Villeroy in Belgium, and his feeble successors entirely failed to rise to the occasion. Philip of Orleans, with Marsin and the duc de la Feuillade as his advisers, was besieging Turin, trying in vain to remedy the errors of the engineers and the constant repulse of small storming parties by a savage bombardment of the town itself. As soon as he knew of Vendôme's departure Prince Eugene emerged afresh from the mountains, and, outmanœuvring the French in Lombardy without the least difficulty, hurried towards Turin. Victor Amadeus, leaving the defence to the Austrian and Piedmontese infantry, escaped through the besiegers' lines and joined his cousin with a large force of cavalry. On the 7th of September they attacked the French lines round Turin. Owing to the disagreements of their generals, the various corps of the defenders, though superior in total numbers, were beaten in detail by the well-concerted attacks of Eugene, Victor Amadeus and the Turin garrison. Marsin was killed, many of the boldest officers in the army lost heart, and Philip retreated ignominiously to Pinerolo. Although in the same week Lieut.-General Méday-Grancey inflicted a severe defeat on

Battle of Turin.

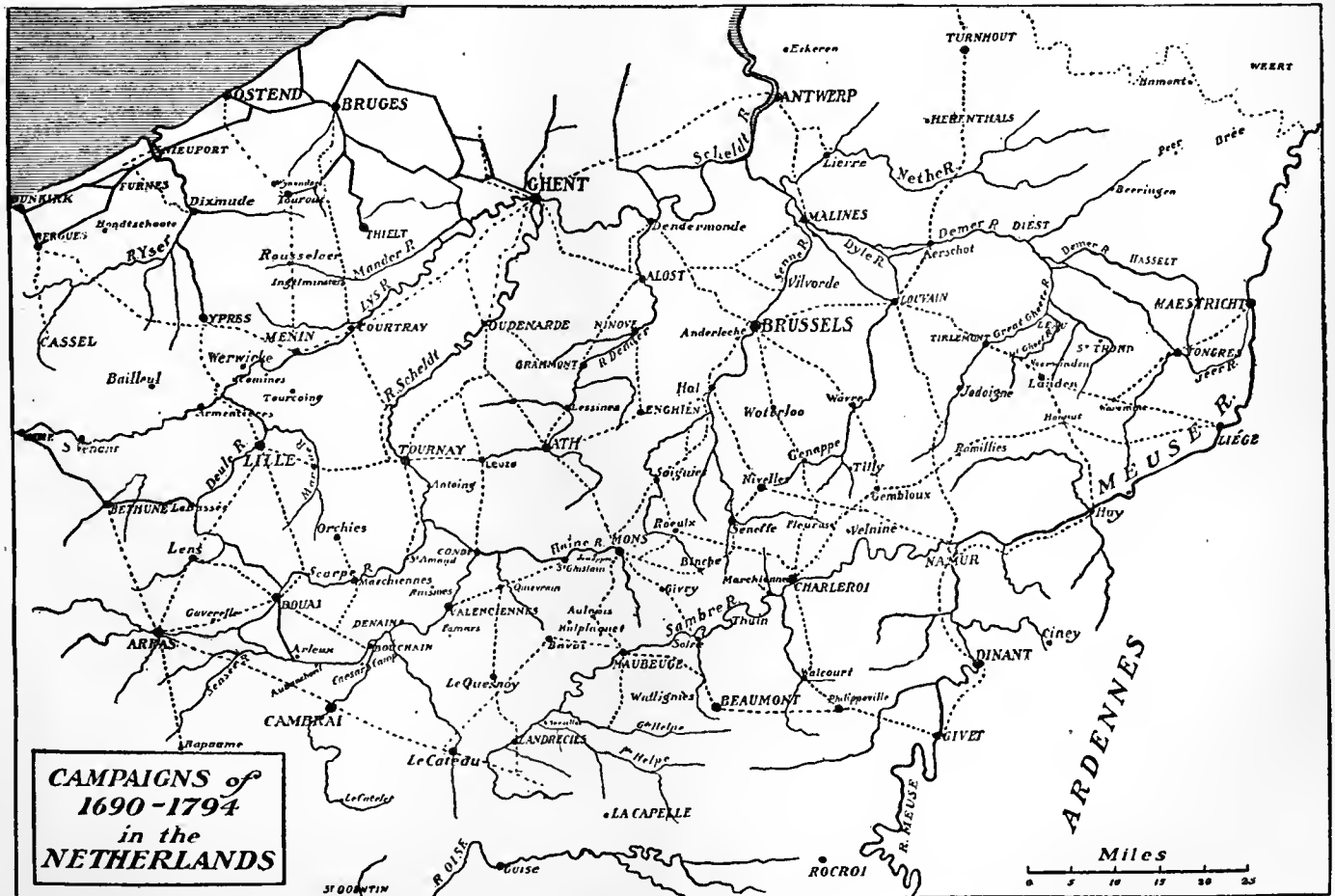

the Austrians who were still left in Lombardy (Castiglione, Sept. 9) the battle of Turin practically ended the war in Italy.

Both in the north and in the south the tide had now receded to the frontiers of France itself. Louis could now hope to gain

Changing Conditions of the War. the objects of the war only partially and by sheer endurance. But it is from this very point that the French operations cease (though only gradually it is true) to be the ill-defined and badly-joined patchwork of forays and cordons that they had hitherto been. In the place of Tallards, Marsins and Villeroys Louis made up his mind to put his Villars, Vendôme and Berwicks, and above all the approach of the allied armies roused in the French nation itself a spirit of national defence which bears at least a faint resemblance to the great uprisings of 1792 and 1870, and under the prevailing dynastic and professional conditions of warfare was indeed a startling phenomenon. For the gathering of this unexpected moral force 1707 afforded a year of respite. The emperor, desiring to occupy Naples and Lombardy with the least possible trouble, agreed to permit Médevy-Grancey to bring off all the Italian garrisons, and with these and the militia battalions of the Midi Marshal Tessé formed a strong army for the defence of the Alpine frontier. In Spain the campaign opened with the brilliant success of Berwick at Almanza. In Germany Villars not only pricked the bubble reputation of the lines of Stollhofen,¹ but raided into Bavaria, penetrating as far as Blenheim battlefield before he gave up the attempt to rouse the Bavarians again. The Imperialists and Piedmontese in the south succeeded in turning the Alpine barrier, but they were brought to a complete standstill by Tessé's gallant defence of Toulon (August) and having, like their predecessors in 1692, roused the peasantry against them they retired over the mountains. In Belgium the elector of Bavaria, who was viceroy there for King Philip, and was seconded by Vendôme, remained quiescent about Mons and Gembloux, while Marlborough, paralysed more completely than ever before by the Dutch, spent the summer inactive in camp on the Gheete.

The respite of 1707 had enabled Louis to gather his strength in Flanders. Henceforward operations on the Rhine and in Dauphiné are of quite secondary importance, so much so that Eugene and the main Austrian army are always found in the Low Countries fighting side by side with the Anglo-allied army of Marlborough.

In 1708 Eugene foresaw this shift of the centre of gravity and arranged with Marlborough to transfer the army which was **Campaign of 1708.** ostensibly destined for the Rhine campaign to

Brahant, repaying thus the debt of 1704. Indeed the main army of the French was markedly superior in numbers to Marlborough's and hardly inferior to Marlborough's and Eugene's combined. Placing the elector of Bavaria, with Berwick to advise him, at the head of the small army of Alsace, he put his young grandson and heir, the duke of Burgundy, at the head of the great army which assembled at Valenciennes, and gave him Vendôme as mentor. But the prince was pious, mild-mannered, unambitious of military glory and also obstinate, and to unite him with the fiery, loose-living and daring Vendôme, was, as Saint-Simon says, "mixing fire and water." At the end of May operations began. Vendôme advanced to engage Marlborough before Eugene, whose purpose had become known, should join him. As the French came on towards Brussels, Marlborough, who had concentrated at Hal, fell back by a forced march to Louvain. Vendôme having thus won the first move, there was a pause and then the French suddenly swung round to the west, and began to overrun Flanders, where their agents had already won over many of the officials who had been installed by the allies since 1706. Ghent and Bruges surrendered at once, and to regain for King Philip all the country west of the Scheldt it only remained to take Oudenarde. On the day of the surrender of Ghent Marlborough was in pursuit, and one long forced

¹ The Margrave Louis of Baden had died during the winter of 1706-1707. He was succeeded by the incompetent margrave of Bayreuth, who was soon displaced. This general's successor was the elector of Hanover, afterwards King George I. of England.

march brought his army almost within striking distance of the receding enemy. But though Eugene himself had joined him, Eugene's army was still far behind, and the duke was stopped by demands for protection from the officials of Brussels. Vendôme soon moved on Oudenarde. But scarcely had he begun this investment when Marlborough was upon him. The duke discussed the situation with Eugene, who had placed himself under his friend's orders. Marlborough was half inclined—another general would have been resolved—to wait for Eugene's troops before giving battle, for he knew that Vendôme was no ordinary opponent, but Eugene counselled immediate action lest the French should escape, and relying on his own skill and on the well-known disunion in the French headquarters, Marlborough went forward. As he approached, the French gave up the siege of Oudenarde and took up a position at Gavre, 7 m.

Oudenarde. lower down the Scheldt, so as to be able to act towards either Ghent or Oudenarde. Marlborough's advanced guard, boldly handled by Cadogan, slipped in between Gavre and Oudenarde. At once the dissensions in the French headquarters became flagrant. Vendôme began to place part of the army in position along the river while the duke of Burgundy was posting the rest much farther back as another line of defence. Cadogan was thus able to destroy the few isolated troops on the river. Thereupon Vendôme proposed to the duke to advance and to destroy Cadogan before the main body of the allies came up, but the young prince's hesitations allowed the chance to pass. He then proposed a retreat on Ghent. "It is too late," replied Vendôme, and formed up the army for battle as best he could. The allied main body, marching with all speed, crossed the Scheldt at all hazards and joined Cadogan. In the encounter-battle which followed (see OUDENARDE) Marlborough separated, cut off and destroyed the French right wing. The French retreated in disorder on Ghent (July 11) with a loss of 15,000 men. Nevertheless Oudenarde was in no way decisive, and for the rest of the campaign the two armies wandered to and fro in the usual way. Berwick, recalled from Alsace, manœuvred about Douay, while Vendôme remained near Ghent, and between **Siege of Lille.** them Marlborough's and Eugene's armies devoted themselves to the siege of Lille. In this town, one of Vauban's masterpieces of fortification, the old Marshal Boufflers had undertaken the defence, and it offered a long and unusually gallant resistance to Eugene's army. Marlborough covered the siege. Vendôme manœuvred gradually round and joined Berwick, but though 90,000 and later 120,000 strong, they did not attack him. Berwick was a new element of dissension in the distracted headquarters, and they limited their efforts first to attempting to intercept a hugh convoy of artillery and stores that the allies brought up from Brussels for the siege,² and secondly to destroy another convoy that was brought up from Ostend by the General Webb known to readers of *Esmond*. The futile attack upon the second convoy is known as the action of Wynendael (Sept. 28). The only other incident of the campaign in the open was an unsuccessful raid on Brussels by a small corps under the elector of Bavaria from the Moselle via Namur.

On the 8th of December the brave old marshal surrendered, Eugene complimenting him by allowing him to dictate the terms of capitulation. Ghent and Bruges were retaken by the allies without difficulty, and, to add to the disasters of Oudenarde and Lille, a terrible winter almost completed the ruin of France. In despair Louis negotiated for peace, but the coalition offered such humiliating terms that not only the king, but—what in the 18th century was a rare and memorable thing—his people also, resolved to fight to the end. The ruinous winter gave force to the spirit of defence, for fear of starvation, inducing something akin to the courage of despair, brought tens of thousands of recruits to the colours.

Of the three invasions of France attempted in this memorable year two were insignificant. On the Rhine the elector of

² An excellent illustration of 18th century views on war is afforded by the fact that the completely successful defence of this convoy was regarded by his contemporaries as Marlborough's greatest triumph.

Hanover (King George I.) was held in check by the duc d'Harcourt on the Lauter and finally retired to the lines of Stollhofen, while a smaller allied corps under the imperialist general Count Mercy was defeated with heavy loss by Harcourt's second in command, Du Bourg, at Rumersheim in Upper Alsace (Aug. 26). On the Alpine frontier Berwick, abandoning the fashionable method of "lines," prepared a remarkable system of mobile defence pivoted on Briançon, on which Victor Amadeus's feeble attacks made no impression. These affairs were little more than diversions. The main, indeed the only, attack was Marlborough's and Eugene's, and the Malplaquet campaign is one of the few episodes of 18th century warfare that retain a living and passionate interest.

Long before this Marlborough had proposed to dash straight forward into France, masking the fortresses, but this scheme was too bold even for Eugene, who preferred to reduce the strong places before going on. Lille having been successfully besieged, Tournai was the next objective, and—while Villars and his lieutenants Montesquiou and Albergotti lay inactive in their entrenchments at Béthune, Douai and Denain on the Scheldt, training their thousands of recruits and suffering severely from the famine that followed upon this bad winter—the allies suddenly and secretly left their camps before Lille as if for an attack on the Douai lines (June 26–27). But before noon on the 27th they had invested Tournai. A few days afterwards their siege guns came up from Menin by water (down the Lys and up the Scheldt) and the siege was pressed with intense vigour. But it was the 3rd of September before the citadel capitulated. Then Marlborough, free to move again, transferred his army secretly and by degrees to the river Haine, beyond Villars's right. East of St Ghislain Villars's long lines of earthworks were but thinly held, and after a march of 50 m. in 56 hours through rain-sodden country, the allied advanced guard passed through them unopposed (Sept. 6th). Mons, too, was weakly held, and Marlborough hoped by the rapidity of his operations to take it before Villars could interrupt him. Based on Mons and Brussels, he could then, leaving the maze of fortresses in the Arras-Valenciennes region to his right, push on (as eighty years afterwards Coburg attempted to push on) straight to the heart of France. But Villars also moved quickly, and his eager army was roused to enthusiasm by the arrival of Marshal Boufflers, who, senior as he was to Villars, had come forward again at the moment of danger to serve as his second in command. Thinking that the allies were somewhat farther to the east than they were in fact, the French marshal marched secretly, screened by the broken and wooded ground to the south of the fortress, and occupied the gap of Aulnois-Malplaquet (Sept. 9), one of the two¹ practicable passages, where he set to work feverishly to entrench himself. Marlborough at once realized what had happened, and giving up the siege of Mons brought his army to the south-east of the place. Preparing, as at Oudenarde, to attack as rapidly as his brigades came on the scene, he cannonaded the French working parties and drew the return fire of all Villars's guns. At this crisis the duke submitted the question of battle—unwillingly, as one may imagine—to a council of war, and Eugene himself was opposed to fighting an improvised battle when so much was at stake. Others thought the capture of the little fortress of St Ghislain was the best solution of the problem, and it was not until the 11th that the allies delivered their attack

on the now thoroughly entrenched position of the French. The battle of Malplaquet (*q.v.*) was by far the most desperately contested of the war. In the end Boufflers, who took command when Villars was wounded, acknowledged defeat and drew off in good order, the left to Valenciennes, the right to Bavay and Le Quesnoy. Eugene was wounded, and Marlborough, after the most terrible experience in any soldier's lifetime, had only enough energy remaining to take Mons before he retired into winter quarters. The loss of the French is given variously as 7000 and 12,000. The allies sacrificed no less, probably more, than 20,000 men, and if the English and Austrian survivors could count themselves the bravest soldiers alive, one

¹The other, scarcely less celebrated, is that of Jemappes.

considerable part of the allied army at least, the Dutch contingent, was ruined for ever. Even at Fontenoy, thirty-six years later, the memory of Malplaquet made them faint-hearted. From his bed the wounded Villars wrote triumphantly to Louis: "If God gives us another defeat like this, your majesty's enemies will be destroyed."

In 1710 Villars lay entrenched behind a new series of lines, which he called *Ne plus ultra* and which extended from Valenciennes to the sea. Marlborough made no attempt to invade France from the side of Mons, for Villars at the head of the army which had been through the ordeal of Malplaquet was too terrible an opponent to pass by with impunity. In England, too, the anti-Marlborough party was gaining the upper hand in the queen's council. So Marlborough took no risks, and returning to the Lille side, captured Douai (June 26) and Béthune (Aug. 26). No attack was attempted upon the lines. In Dauphiné, Berwick again repulsed the Austrians and Piedmontese.

1711 was Marlborough's last campaign, and it was remarkable for the capture of the *Ne plus ultra* lines by manœuvres that must be recorded as being the *ne plus ultra* of the 18th-century way of making war by stratagem. In May the sudden death of the emperor completely altered the political outlook, for his successor Charles was the coalition's claimant to the throne of Spain, and those who were fighting for the "balance of power" could no more tolerate a new Charles V. than they could see Louis XIV. become a Charlemagne. Before the allies could agree upon any concerted action, Eugene's army had departed for Germany, and Marlborough alone was left to face Villars's great army. But in pursuance of the policy of passive endurance the marshal remained on the defensive behind the lines, and Marlborough determined to dislodge him. What force could not achieve, the duke trusted to obtain by ruse. The lines extended from the sea along the Canche, thence to Arras, and along the Sensée to Bouchain on the Scheldt. Marlborough held Lille, Tournai, Béthune and, in front of these places, Douai, while Villars's strong places, other than those in the lines, were Valenciennes, Condé, Le Quesnoy, &c. As the western part of the lines, besides being strong, were worthless from the invaders' point of view because their capture could

not lead to anything, Marlborough determined to pass the barrier between Arras and Bouchain. Here the front was difficult of access, because of the inundations and swamps of the Sensée valley, but two causeways crossed this valley at Arleux and Aubanchoeil-au-Bac respectively. On the 6th of July Marlborough, who had encamped in the plain of Lens, sent a detachment to capture Arleux. He then marched away to the west as if to attack the lines between Arras and the headwaters of the Canche. Villars followed suit, but left a corps behind, as Marlborough had expected and desired, to retake Arleux. The commander of the garrison then sent urgent messages to say that he could not hold out, and Marlborough sent off Cadogan to relieve him. Cadogan, the only officer in the army in the duke's confidence, moved slowly, and the garrison had to surrender (July 22). Villars razed the defences of Arleux. The plot of the comedy now thickened. Marlborough lost his usual serenity, and behaved in so eccentric a manner that his own army thought him mad. He sent off one part of his forces to Béthune, another back to Douai, and ordered the small remainder to attack the lines between the Canche and Arras, where, as every one knew, Villars's whole army was massed.

On the 24th of August he personally reconnoitred the lines with a large staff, and calmly gave his generals instructions for the lines to be stormed. But Cadogan was hastening to give the duke's real orders to the corps at Béthune and Douai. In the night of the 4th–5th of August the main army set out for Aubanchoeil-au-Bac, at the highest possible speed. The Scarpe was crossed, the Béthune column came in punctually, and the word was passed down the ranks that Cadogan had crossed the lines at Arleux. Thereupon the pace was increased, though thousands of the infantry fell out and scores died from exhaustion. Five hours ahead of the French

Campaign of 1709.

Campaign of 1710.

The Ne Plus Ultra Lines.

Marlborough's Manœuvre.

army and level in the race with Villars and the cavalry, the redcoats crossed the rivers at Arleux, while Marlborough and the horse hurried on to Aubanchoeil-au-Bac, crossed there and turned back along the Sensée to meet the French squadrons. The army reassembled between Aubanchoeil-au-Bac and Cambrai, and its leader, declining Villars's offer of a battle in front of Cambrai, manoeuvred still farther to the east and invested Bouchain. The siege, covered by a strong "line of circumvallation" which Villars did not attempt to attack, ended with the surrender of the place on the 13th of September, and so terminated a series of manoeuvres which to the modern mind is so extraordinary as to be almost incredible. In December of this year, his party opponents in England being now triumphant, the man who was so consummate a master both of the 18th-century and the Ramillies-Oudenarde methods of making war was dismissed the service in disgrace. In June 1712 the British contingent, under the duke of Ormonde, withdrew from the Low Countries, the discontent of the men at Marlborough's disgrace breaking out in open mutiny, and thus ignominiously ended the career of the army of Blenheim and Malplaquet. The coalition practically dissolved.

But Holland and Austria determined to make one last effort to impose their own terms on Louis. Eugene's army, which had been used in 1711 to influence the imperial election instead of to beat Villars, was brought back to the Low Countries. Reading the meaning of Marlborough's fall, he quietly made preparations to take over the various allied contingents into Imperial or Dutch pay. Thus when England seceded, Ormonde only marched away with some 12,000 sullen men, and over 100,000 remained with the prince.

Misfortunes at Versailles helped Eugene in his first operations, for three members of Louis's family died within a week and all was in confusion, not to speak of the terrible misery that prevailed in the country. But the old king's courage rose with the danger and he told Villars that if the army were beaten he would himself join it and share in its fate. Villars, though suffering still from his Malplaquet wound, took command on the 20th of April, and spun out time on the defensive until the end of May, when Ormonde's contingent withdrew. Eugene, apparently with the intention of regaining the Mons line of operations, as the defection of England had made further operations near the sea unprofitable, neglected to besiege, not only Arras, but Valenciennes and Condé as well, and, based temporarily on Douai and Marchiennes and Bouchain he took Le Quesnoy (July 4) and moved thence on to Landrecies, which was closely invested. Then followed the last serious fight of the war, the battle of Denain, which saved the French monarch and completed the disintegration of the coalition.

In order to protect his camps around Landrecies, Prince Eugene constructed the usual lines of circumvallation with such speed that Villars, on coming up, found that they were too formidable to attack. Next, in order to guard the movements of his convoys between Marchiennes-on-Scarpe and the front against attacks from Cambrai or Valenciennes, he hedged in the route on both sides with continuous lines of breastworks, to the defence of which he assigned his Dutch corps. Villars anxiously looked out for an opportunity of breaking these modern "long walls." At Denain, the besiegers' route crossed the Scheldt. From this point to the front, streams and other

Denain.

obstacles reinforced the defence, but the marshal was told by a country priest that the lines were assailable north of Denain, and resolved to attack them there. The enterprise, like Marlborough's forcing of the *Ne plus ultra* lines, involved an extraordinary combination of resolution and skill—*i.e.* force and fraud—for the point of attack was far away and the opposing army almost within cannon-shot. Some days were spent by Villars in deceiving Eugene and his own army as well, as to his real intentions, and by various feints Eugene was induced to mass his main body about Landrecies and Le Quesnoy on the south side of the Scheldt. Then on the night of the 23rd of July the French army moved off silently, with its bridging train in the vanguard and cavalry posted everywhere along its

right flank to conceal the march. By 9 a.m. on the 24th Villars's army had completely deployed on the north bank of the Scheldt. Eugene himself saw them and galloped away to bring up his army from Landrecies. But, long before it arrived, Villars's troops, without wasting precious moments in formal preparations, stormed the lines. The Dutch—spiritless since Malplaquet—were huddled into the narrow avenue between the two entrenchments and forced back on Denain. Their generals were taken. The broken mob of fugitives proved too heavy a load for the bridges at Denain, and many were drowned, while the rest, pinned against the bank of the now impassable river, tamely surrendered. Eugene arrived on the other bank with some brigades of the imperial infantry, but after losing heavily gave up the attempt to reopen the passage. Villars followed up his victory at once. Montesquiou captured Marchiennes and Albergotti St Amand, and in these places all Eugene's reserve stores, pontoons and guns fell into the hands of the French. On the 2nd of August Eugene broke up the siege of Landrecies and retreated by a roundabout route to Mons, while Villars's lieutenants retook Douai and Bouchain (September-October). Before the next campaign opened the treaty of Utrecht had been signed, and although the emperor continued the struggle alone for another year, the enfeebled combatants were content to accept Villars's captures of Landau (July 22, 1713) and Freiburg (Nov. 21) as decisive. The treaty of Rastatt, between Austria and France, was signed on the 7th of March 1714, Eugene and Villars being the negotiators.

See J. W. Fortescue, *Hist. British Army*, vol. i. (London, 1899); lives of Marlborough; the Austrian official *Feldzüge des Prinzen Eugen* (Vienna, 1871-1892); Roder v. Diersburg's *Markgraf Ludwig von Baden* (Karlsruhe, 1850); Arneth's *Prinz Eugen; Mémoires militaires relatifs à la succession d'Espagne* (1835; ed. De Vault); detailed histories of the French army, and monographs in the French general staff's *Revue d'histoire*. (C. F. A.)

NAVAL OPERATIONS, AND MILITARY OPERATIONS IN SPAIN

The war of the Spanish succession affected all the nations of western, northern and central Europe in a greater or less degree, but that part of it which was fought out on the soil of Spain lay aside from the campaigns in Flanders, Germany and Italy. The purely Spanish campaigns had a close connexion with the movements of the fleets, and the two may be conveniently taken together. The naval war was superficially somewhat wanting in interest. Louis XIV., having to support armies of unprecedented size to contend with the forces of the Grand Alliance, and having also to meet the immense cost of the support of his court and the construction of palaces, was compelled to neglect his navy. Except therefore in 1704 he made no attempt to oppose the fleets of the allies with equal forces at sea. The honour of the French flag was chiefly maintained by the privateers who showed high courage and much skill. Some of their enterprises were undertaken with well-appointed squadrons, and attained to the dignity of regular operations of war.

When the Grand Alliance was formed on the 7th of September 1701 a French naval force under M. de Chateaurenault was in the West Indies. Its avowed purpose was to cover the arrival in Europe of the Spanish treasure ships. The secret intention of King Louis XIV. was that the treasure should be brought into a French port, and used by him for the general advantage of the house of Bourbon. On the 12th of September a British squadron of 10 ships commanded by Admiral Benbow was sent to the West Indies to intercept Chateaurenault, and carry out other attacks on the French and Spaniards. Benbow, who was reinforced in the West Indies, did not intercept Chateaurenault, and his cruise was rendered of no effect by the gross misconduct of most of his captains, who refused to support him in an action with a French squadron under M. Du Casse near St Martha on the 20th of August 1702 and subsequent days. He was himself mortally wounded, but lived long enough to bring his captains to court martial. Two of them were shot for cowardice. The treasure fleet sailed for Europe only to fall into the hands of the allies at Vigo. On the 1st of July 1702 a powerful combined fleet of 30 British sail-of-the-line under Sir George Rooke, and

20 Dutch under Admiral Allemonde sailed from Spithead carrying 5000 troops. The general command was given to the duke of Ormonde. The purpose of this expedition was to occupy Cadiz and encourage a rising in Andalusia on behalf of the Habsburg candidate. It reached Cadiz on the 22nd of August, but the inhabitants and the garrison remained loyal. The leaders of the expedition quarrelled with one another and the soldiers aroused the bitter indignation of the inhabitants by plundering the small towns of Santa Maria and Rota. On the 30th of September the expedition sailed away. Information sent by the British minister at Lisbon that Chateaufort had put into Vigo reached them at Lagos. The duke of Ormonde and his colleagues decided to attack the treasure fleet. On the 22nd of October they forced the boom laid by the enemy between the inner and outer harbours of Vigo, and the treasure fleet was destroyed, but the bullion had been landed.

During 1703 the "grand fleet" of the allies, *i.e.* their main force in European waters, entered the Mediterranean to carry help to the insurgent Protestants in the Cevennes, but effected nothing of importance. Portugal having now joined the Alliance, it was decided to make a serious effort in Spain. A combined fleet carrying 4000 Dutch and 8000 British troops, and conveying the archduke Charles, claimant of the Spanish throne, sailed from Spithead on the 11th of February 1704. Portugal undertook to provide 30,000 troops to co-operate with the British and Dutch who were landed at Lisbon on the 8th of March. The operations on land were for the most part languid. The duke of Berwick who commanded the Bourbon forces on the Spanish frontier formed a vigorous plan for the invasion of Portugal. One Spanish force under Don Francisco Ronquillo was to threaten Beira Alta at Almeida. He himself entered Beira Baixa by the north bank of the Tagus. The prince of Tzerclaes was to have advanced from the south to meet Berwick at Villa Velha. But though Berwick achieved some success, and though both the Dutch general Fagel who operated on the north of the Tagus, and the British general, the duke of Schomberg, who was stationed on the south, proved indolent and incapable, the invasion failed. Ronquillo and Tzerclaes failed to support Berwick, and the newly levied Spanish troops proved unsteady. Fagel was surprised and taken prisoner with 2000 men at Sobreira Ferosa, and some of the frontier posts remained in Berwick's hands when the heat from which the British and Dutch soldiers suffered severely suspended operations. At sea, however, a material success was gained. Sir George Rooke went on from Lisbon accompanied by Prince George of Hesse-Darmstadt, to Barcelona. The prince who had been governor of Catalonia, believed that he could bring about a rising in the province in favour of the Habsburg cause. As the fleet carried no considerable body of troops, Rooke and Hesse-Darmstadt failed to persuade the Catalans to act. They were embarrassed by the knowledge that the count of Toulouse, a natural son of Louis XIV., the admiral of France, who had sailed from Brest on the 6th of May with 23 sail-of-the-line had entered the Mediterranean, and had reached Toulon in June. In expectation of an attack by the united fleets of Brest and Toulon, the allies fell back to the straits. Having obtained information that Gibraltar (*g.v.*) was not sufficiently garrisoned, they attacked and took it on the 3rd of August. On the 24th the count of Toulouse, came to the relief of the fortress with 50 sail-of-the-line, and 24 galleys. He engaged the allies, 62 British and Dutch line of battleships in all, off Malaga. The engagement was a cannonade accompanied with great loss of life, but without manœuvring on either side. The French retired to Toulon, and the allies remained in possession of Gibraltar. An attempt of the Spaniards to retake it, made at the end of 1704 and beginning of 1705 was baffled by the resolute defence of the prince of Hesse-Darmstadt, and the relief afforded to the garrison by the squadron of Sir John Leake, who was left on the coast of Portugal, when Sir George Rooke returned to England.

The events of 1704 had persuaded the allies to make more serious efforts to push the war in Spain. The duke of Schomberg was removed from the command of the troops in Portugal

and replaced by the earl of Galway, a French Huguenot exile. But the main attack was made, and the first successes were achieved on the east coast of Spain. On the 3rd of June 1705 Charles Mordaunt, earl of Peterborough, was sent with a commission to command both the fleet and the army, and to promote a rising in favour of the Habsburg, or Austrian party. He was joined by the archduke at Lisbon, and by the prince of Hesse-Darmstadt at Gibraltar. The truth in regard to the operations which followed has been very much obscured. Peterborough, a man of much erratic cleverness, but vain, spiteful and absolutely indifferent to truth, successfully represented himself as a species of hero of romance who won the most astonishing victories in spite of want of means, and of the ill will or incapacity of his colleagues. Critical investigation has destroyed much of the showy edifice of fiction he contrived to erect. The substantial facts are that after some operations on the coast of Valencia, which led to an insurrectionary movement in favour of the archduke, Barcelona was attacked and taken between the 13th of September and the 9th of October. The prince of Hesse-Darmstadt was killed during the siege.

All the east of Spain, the former kingdom of Aragon, which was at all times restive under the supremacy of Castile, now pronounced more or less openly for the Austrian party. The fall of Barcelona gave a severe shock to the Bourbon king. He came in person with Marshal Tessé who had replaced the duke of Berwick, and endeavoured to retake the town early in April 1706. The brutality with which Tessé treated the people of Aragon and Catalonia raised the country against the Bourbon king. The British relieved Barcelona on the 9th of May, and Philip V. was compelled to retreat across the Pyrenees to Perpignan. In the meantime the withdrawal of troops from the Portuguese frontier for service in Catalonia, had opened the way for an invasion of Castile by the allies, British, Portuguese and Dutch. They occupied Madrid on the 25th of June 1706, and the queen who acted as regent in the absence of her husband retired to Burgos. But the success of the allies was merely apparent. The appearance in their midst of an invading army of Portuguese and heretics roused the national feeling of the Castilians. They rallied to the Bourbon cause. As in the later Peninsular War, guerrillero bands sprang up on all sides, and they found capable leaders in Vallejo and Bracamonte. The duke of Berwick, who was sent back to Spain, collected an army, and soon the allies, who were distressed by want of provisions and bad health, were forced to evacuate Madrid. They moved on Guadalajara to meet the archduke who was advancing from the east. Berwick outmanœuvred them, and forced them to retreat on Valencia. In February 1707 they were reinforced by troops brought by the fleet and advanced in April. On the 25th of the month they were defeated by the French and Spanish troops at Almansa in the province of Alicante, with the loss of all their infantry.

From this date till 1710, the land war in Spain remained stationary. The Bourbon king was master of the greater part of Spain, including Aragon. His generals retook Lérida on the Catalan frontier, and on the Portuguese frontier at La Gudiña near Badajoz, on the 7th of May 1709, a Spanish army under the Marques de Bay defeated an Anglo-Portuguese army under the earl of Galway. Yet the Austrian party held Catalonia and Valencia, and the financial distress of the Spanish government, aided by the disorganized state of the administration, rendered a vigorous offensive impossible. By 1710 the French king had been reduced to great distress, and was compelled to make at least a show of withdrawing his support from his grandson Philip V. The allies decided to advance from Catalonia, a course which was strongly urged by General Stanhope (afterwards Earl Stanhope), who commanded the British troops. He had served in subordinate rank from the beginning of the war, and had gained some reputation by the capture of Port Mahon in 1708. Stanhope's energy overcame the reluctance of the Imperialist general Guido Starhemberg, who commanded the German troops of the archduke. The allies advanced and for a time seemed to carry all before them. The Spaniards were defeated at Alméñara on the 27th of July 1710, and before Saragossa on the 20th of

August. On the 21st of September the archduke entered Madrid. But the invasion of 1710 was a repetition of the invasion of 1706. The 23,000 men of the allies, reduced by a loss of 2000 in the actions at Alménara and Saragossa, by casualties in constant skirmishes with the guerrilleros, and by disease, were absolutely incapable of occupying the two Castiles. The Portuguese gave no help. The Spaniards were reorganized by the duke of Vendôme, who was lent to King Philip V. by his grandfather, and were joined by soldiers of the Irish brigade, and by some Frenchmen who were allowed, or secretly directed, to enter the Spanish service. The position of the allies at Madrid, which was deserted by all except the poorest of its inhabitants, became untenable. On the 9th of November they evacuated the town, and began their retreat to Catalonia. The archduke left the army with 2000 cavalry, and hurried back to Barcelona. The rest of the army marched in two detachments, the division being imposed on them by difficulty of finding food. General Starhemberg with the main body of 12,000 men, was a day's march ahead of the British troops, 5000 men, under Stanhope. Such a disposition invited disaster in the presence of so capable a general as Vendôme. On the 9th of December he fell upon General Stanhope at Brihuega, and after hard fighting forced him to surrender. Starhemberg, who received tardy information of the peril of his colleague, marched back to support him, and fought a drawn battle at Villa Viciosa, on the 11th. The fruits of victory fell to Vendôme, for the Imperialist general was compelled to continue his retreat, harassed at every step by the Spanish cavalry and irregulars. His army was reduced to 7000 men when he reached Barcelona.

The disastrous result of the campaign of 1710 proved to demonstration that it was impossible to force the archduke on the Castilians by any effort the allies were prepared to make. They remained quiescent at Barcelona till they evacuated the country altogether on the Peace of Utrecht. The Catalans, though deserted by their allies, continued to fight for their local franchises which had been declared forfeited by the victorious Bourbon king. Barcelona was only subdued on the 12th of September 1714, after a siege of great length and extraordinary ferocity, by the united exertions of the French and Spanish troops under the command of the duke of Berwick.

The naval operations, apart from the transport and support of the troops in Spain, were more numerous than memorable. The overwhelming superiority of the allies alone enabled them to maintain the war in the Peninsula, but as they met no serious opposition except in 1704, there is nothing to record save their successive cruises. In 1707 a British and Dutch fleet under Sir Cloudesley Shovel aided the Imperialists in the unsuccessful siege of Toulon. The action of the allied navy was in fact as decisive as the naval strength of Great Britain was to be in the later struggle with Napoleon. But it was less brilliant. The many expeditions sent to the West Indies rarely did more than plunder coast towns or plantations in the French islands. An exception was indeed provided by the British admiral Sir Charles Wager, who in May 1708 destroyed or captured a whole squadron of Spanish treasure ships near Cartagena in South America. The loss of the treasure was a heavy blow to the government of Philip V. and had much to do with his inability to follow up the victory of Almansa. On the whole however neither the British nor the Dutch achieved any material success against the French in America. One powerful British combined force, which was sent against Quebec in 1711, was compelled to return by the shipwreck of a number of the vessels composing it at the mouth of the St Lawrence on the 21st of August. The French found some consolation for the weakness of the royal navy in the daring and the frequent success of their privateers. They were indeed the finest operations of the kind recorded in naval warfare. As the British and Dutch took measures to guard against capture of their merchant ships by sailing in well protected convoys, the French combined their privateers into squadrons and attacked the guard with great vigour. On the 20th of October 1708, a British squadron of 5 line of battleships, of which 2 were of 80 guns; conveying a number of store ships to Lisbon, was

attacked near the Lizard, and was almost wholly destroyed or captured by Duguay Trouin and Forbin with 12 smaller vessels. This was but one example of a number of operations of the same character by which the trade of Great Britain and Holland was hampered. The most signal single achievement of the privateers was the capture of Rio de Janeiro from the Portuguese in September 1711 by a fleet of 6 sail-of-the-line and 6 frigates with corsairs. The royal ships were equipped as a speculation by Duguay Trouin and the shipowners of St Malo. The booty taken gave a profit of 92% on the capital invested.

AUTHORITIES.—For the war on land *The History of the War of the Succession in Spain* (London, 1832) by Lord Mahon (Stanhope) is still of value. Lord Mahon was, however, misled into placing too much confidence in Peterborough. Colonel Parnell, *The War of Succession in Spain* (London, 1888), goes perhaps into the opposite extreme, but his history is full and is supported by copious references to original authorities. The naval operations are told for Great Britain by Lediard *Naval History* (London, 1735); for Holland by De Jonghe, *Geschiedenis van het nederlandsche zeezezen* (Haarlem, 1858); and for France by Tronde, *Batailles navales de la France* (Paris 1867). (D. H.)

SPARASSODONTA, a zoological name applied to a group of primitive carnivorous mammals from the Santa Cruz beds of Patagonia, represented by the genera *Borhyaena*, *Prothylacinus*, *Amphiprozivera*, &c. By their first describer, Dr F. Ameghino, they are regarded as nearly related to the marsupials. They are, however, more probably members of the creodont Carnivora (see CREODONTA).

SPARKS, JARED (1789-1866), American historian and educationalist, was born in Willington, Tolland county, Connecticut, on the 10th of May 1789. He studied in the common schools, worked for a time at the carpenter's trade, and then became a school-teacher. In 1809-1811 he attended Phillips Exeter Academy, where he met John G. Palfrey and George Bancroft, two schoolmates, who became his lifelong friends. He graduated at Harvard (A.B., in 1815 and A.M., in 1818); taught in a private school at Lancaster, Massachusetts, in 1815-1817; and studied theology and was college tutor in mathematics and natural philosophy at Harvard in 1817-1819. In 1817-1818 he was acting editor of the *North American Review*. He was pastor of the First Independent Church (Unitarian) of Baltimore, Maryland, in 1819-1823, Dr William Ellery Channing delivering at his ordination his famous discourse on "Unitarian Christianity." During this period Sparks founded the *Unitarian Miscellany and Christian Monitor* (1821), a monthly, and edited its first three volumes; he was chaplain of the national House of Representatives in 1821-1823; and he contributed to the *National Intelligencer* and other periodicals. In 1823 his health failed and he withdrew from the ministry. Removing to Boston, he bought and edited in 1824-1830 the *North American Review*, contributing to it about fifty articles. He founded and edited, in 1830 the *American Almanac and Repository of Useful Knowledge*, which was continued by others and long remained a popular annual. After extensive researches at home and (1828-1829) in London and Paris, he published the *Life and Writings of George Washington* (12 vols., 1834-1837; redated 1842), his most important work; and in 1839 he published separately the *Life of George Washington* (abridged, 2 vols., 1842). The work was for the most part favourably received, but Sparks was severely criticized by Lord Mahon (in the sixth volume of his *History of England*) and others for altering the text of some of Washington's writings. Sparks defended his methods in *A Reply to the Strictures of Lord Mahon and Others* (1852). The charges were not wholly justifiable, and later Lord Mahon (Stanhope) modified them. While continuing his studies abroad, in 1840-1841, in the history of the American War of Independence, Sparks discovered in the French archives the red-line map, which, in 1842, came into international prominence in connexion with the dispute over the north-eastern boundary of the United States. In 1842 he delivered twelve lectures on American history before the Lowell Institute in Boston. In 1839-1849 he was McLean professor of ancient and modern history at Harvard. His appointment to this position, says his biographer, was "the first academic encouragement of American history, and of

original historical research in the American field." In 1849 Sparks succeeded Edward Everett as president of Harvard. He retired in 1853 on account of failing health, and devoted the rest of his life to his private studies. For several years he was a member of the Massachusetts board of education. He died on the 14th of March 1866, in Cambridge, Mass. His valuable collection of manuscripts and papers went to Harvard; and his private library and his maps were bought by Cornell University. He was a pioneer in collecting, on a large scale, documentary material on American history, and in this and in other ways rendered valuable services to historical scholarship in the United States.

Among Sparks's publications not already mentioned, are *Memoirs of the Life and Travels of John Ledyard* (1828); *The Diplomatic Correspondence of the American Revolution* (12 vols., 1829-1830; redated 1854); *Life of Gouverneur Morris, with Selections from his Correspondence and Miscellaneous Papers* (3 vols., 1832); *A Collection of the Familiar Letters and Miscellaneous Papers of Benjamin Franklin* (1833); *The Works of Benjamin Franklin, with Notes and a Life of the Author* (10 vols., 1836-1840; redated 1850), a work second in scope and importance to his *Washington*; *Correspondence of the American Revolution; being Letters of Eminent Men to George Washington, from the Time of his taking Command of the Army to the End of his Presidency* (4 vols., 1853). He also edited the *Library of American Biography*, in two series (10 and 15 vols. respectively, 1834-1838, 1844-1847), to which he contributed the lives of Ethan Allen, Benedict Arnold, Marquette, La Salle, Count Pulaski, John Ribault, Charles Lee and John Ledyard, the last a reprint of his earlier work. In addition, he aided Henry D. Gilpin in preparing an edition of the *Papers of James Madison* (1840), and brought out an American edition of William Smyth's *Lectures on Modern History* (2 vols., 1841), which did much to stimulate historical study in the United States.

See Herbert B. Adams, *The Life and Writings of Jared Sparks* (2 vols., Boston, 1893); also Brantz Mayer, *Memoir of Jared Sparks* (1867), prepared for the Maryland Historical Society; and George E. Ellis, *Memoir of Jared Sparks* (1869), reprinted from the *Proceedings of the Massachusetts Historical Society* for May 1868.

(W. L. C. *)

SPARROW (O. Eng. *spearwa*; Icel. *spörr*; O.H.G. *Sparo*), a word perhaps (like the equivalent Latin *passer*) originally meaning almost any small bird, but gradually restricted in signification, and nowadays in common English applied to only four kinds, which are further differentiated as hedge-sparrow, house-sparrow, tree-sparrow and reed-sparrow—the last being a bunting (*q.v.*)—though when used without a prefix the second of these is usually intended.

1. The hedge-sparrow, called "duncock" in many parts of Britain, *Accentor modularis* of the sub-family Turdinae of the thrushes (*q.v.*), is the little brown-backed bird with an iron-grey head and neck that is to be seen in nearly every garden throughout the country, unobtrusively and yet tamely seeking its food, which consists almost wholly of insects, as it progresses over the ground in short jumps, each movement being accompanied by a slight jerk or shuffle of the wings. Though on the continent of Europe it regularly migrates, it is one of the few soft-billed birds that reside throughout the year with us, and is one of the earliest breeders—its well-known greenish-blue eggs, laid in a warmly built nest, being recognized by hundreds as among the surest signs of returning spring; but a second or even a third brood is produced later. The cock has a sweet but rather feeble song; and the species has long been accounted, though not with accuracy, to be the most common dupe of the cuckoo. Several other species are assigned to the genus *Accentor*; but all, except the Japanese *A. rubidus*, which is the counterpart of the British hedge-sparrow, inhabit more or less rocky situations, and one, *A. collaris*, or *alpinus*, is a denizen of the higher mountain-ranges of Europe, though it has several times strayed to England.

2. The house-sparrow, the *Fringilla domestica* of Linnaeus and *Passer domesticus* of modern authors, is far too well known to need any description of its appearance or habits, being found, whether in country or town, more attached to human dwellings than any other wild bird; nay, more than that, one may safely assert that it is not known to thrive anywhere far away from the habitations or works of men, extending its range in such countries as northern Scandinavia and many parts of the Russian Empire as new settlements are formed and land brought under

cultivation. Thus questions arise as to whether it should not be considered a parasite throughout the greater portion of the area it now occupies, and as to what may have been its native country. Moreover, it has been introduced to several of the large towns of North America and to many of the British colonies, in nearly all of which, as had been foreseen by ornithologists, it has multiplied to excess and has become an intolerable nuisance, being unrestrained by the natural checks which partly restrict its increase in Europe and Asia. Whether indeed in the older seats of civilization the house-sparrow is not decidedly injurious to the agriculturist and horticulturist has long been a matter of discussion, and no definite result that a fair judge can accept has yet been reached. It is freely admitted that the damage done to growing crops is often enormous, but as yet the service frequently rendered by the destruction of insect-pests cannot be calculated. In the south of Europe the house-sparrow is in some measure replaced by two allied species, *P. hispaniolensis* and *P. italiae*, whose habits are essentially identical with its own; and it is doubtful whether the sparrow of India, *P. indicus*, is specifically distinct; but Africa has several members of the genus which are decidedly so.

3. The tree-sparrow, the *Fringilla montana* of Linnaeus and *Passer montanus* of modern writers—both sexes of which much resemble the male house-sparrow, but are easily distinguishable by the reddish-brown crown, the black patch on the sides of the neck, and doubly-barred wings—is a much more local species, in England generally frequenting the rows of pollard-willows that line so many rivers and canals, in the holes of which it breeds; but in some Eastern countries, and especially in China, it frequents houses, even in towns, and so fills the place of the house-sparrow. Its geographical distribution is extensive and marked by some curious characters, among which may be mentioned that, being a great wanderer, it has effected settlements even in such remote islands as the Faeroes and some of the Outer Hebrides.

The genus *Passer* belongs to the Passerine family Fringillidae. The American birds called "sparrows" have little in common with the members of the genus *Passer*, and belong to the family Emberizidae, which is closely allied to the Fringillidae. (A. N.)

SPARTA (Gr. Σπάρτη or Λακεδαίμων), an ancient city in Greece, the capital of Laconia and the most powerful state of the Peloponnese. The city lay at the northern end of the central Laconian plain, on the right bank of the river Eurotas, a little south of the point where it is joined by its largest tributary, the Oenus (mod. Keleffna). The site is admirably fitted by nature to guard the only routes by which an army can penetrate Laconia from the land side, the Oenus and Eurotas valleys leading from Arcadia, its northern neighbour, and the Langáda Pass over Mt Taygetus connecting Laconia and Messenia. At the same time its distance from the sea—Sparta is 27 m. from its seaport, Gythium—made it invulnerable to a maritime attack.

I.—HISTORY

Prehistoric Period.—Tradition relates that Sparta was founded by Lacedaemon, son of Zeus and Taygete, who called the city after the name of his wife, the daughter of Eurotas. But Amyclae and Therapne (Therapnae) seem to have been in early times of greater importance than Sparta, the former a Minyan foundation a few miles to the south of Sparta, the latter probably the Achaean capital of Laconia and the seat of Menelaus, Agamemnon's younger brother. Eighty years after the Trojan War, according to the traditional chronology, the Dorian migration took place. A band of Dorians (*q.v.*) united with a body of Aetolians to cross the Corinthian Gulf and invade the Peloponnese from the north-west. The Aetolians settled in Elis, the Dorians **Dorian invasion.** pushed up to the headwaters of the Alpheus, where they divided into two forces, one of which under Cresphontes invaded and later subdued Messenia, while the other, led by Aristodemus or, according to another version, by his twin sons Eurysthenes and Procles, made its way down the Eurotas valley and gained Sparta, which became the Dorian capital

of Laconia. In reality this Dorian immigration probably consisted of a series of inroads and settlements rather than a single great expedition, as depicted by legend, and was aided by the Minyan elements in the population, owing to their dislike of the Achaean yoke. The newly founded state did not at once become powerful: it was weakened by internal dissension and lacked the stability of a united and well-organized community. The turning-point is marked by the legislation of Lycurgus (*q.v.*), who effected the unification of the state and instituted that training which was its distinguishing feature and the source of its greatness. Nowhere else in the Greek world was the pleasure of the individual so thoroughly subordinated to the interest of the state. The whole education of the Spartan was designed to make him an efficient soldier. Obedience, endurance, military success—these were the aims constantly kept in view, and beside these all other ends took a secondary place. Never, perhaps, in the world's history has a state so clearly set a definite ideal before itself or striven so consistently to reach it. But it was solely in this consistency and steadfastness that the greatness of Sparta lay. Her ideal was a narrow and unworthy one, and was pursued with a calculating selfishness and a total disregard for the rights of others, which robbed it of the moral worth it might otherwise have possessed. Nevertheless, it is not probable that without the training introduced by Lycurgus the Spartans would have been successful in securing their supremacy in Laconia, much less in the Peloponnese, for they formed a small immigrant band face to face with a large and powerful Achaean and autochthonous population.

The Expansion of Sparta.—We cannot trace in detail the process by which Sparta subjugated the whole of Laconia, but apparently the first step, taken in the reign of Archelaus and Charillus, was to secure the upper Eurotas valley, conquering the border territory of Aegys. Archelaus' son Teleclus is said to have taken Amyclae, Pharis and Geronthrae, thus mastering the central Laconian plain and the eastern plateau which lies between the Eurotas and Mt Parnon: his son, Alcamenes, by the subjugation of Helos brought the lower Eurotas plain under Spartan rule. About this time, probably, the Argives, whose territory included the whole east coast of the Peloponnese and the island of Cythera (Herod. i. 82), were driven back, and the whole of Laconia was thus incorporated in the Spartan state. It was not long before a further extension took place. Under Alcamenes and Theopompus a war broke out between the Spartans and the Messenians, their neighbours on the west, which, after a struggle lasting for twenty years, ended in the capture of the stronghold of Ithome and the subjection of the Messenians, who were forced to pay half the produce of the soil as tribute to their Spartan overlords. An attempt to throw off the yoke resulted in a second war, conducted by the Messenian hero Aristomenes (*q.v.*); but Spartan tenacity broke down the resistance of the insurgents, and Messenia was made Spartan territory, just as Laconia had been, its inhabitants being reduced to the status of helots, save those who, as perioeci, inhabited the towns on the sea-coast and a few settlements inland.

This extension of Sparta's territory was viewed with apprehension by her neighbours in the Peloponnese. Arcadia and Argos had vigorously aided the Messenians in their two struggles, and help was also sent by the Sicyonians, Pisatans and Triphylans: only the Corinthians appear to have supported the Spartans, doubtless on account of their jealousy of their powerful neighbours, the Argives. At the close of the second Messenian War, *i.e.* by the war 631 at latest, no power could hope to cope with that of Sparta save Arcadia and Argos. Early in the 6th century the Spartan kings Leon and Agasicles made a vigorous attack on Tegea, the most powerful of the Arcadian cities, but it was not until the reign of Anaxandridas and Ariston, about the middle of the century, that the attack was successful and Tegea was forced to acknowledge Spartan overlordship, though retaining its independence. The final struggle for Peloponnesian supremacy was with Argos, which had at an early period been the most powerful state of the peninsula, and even now,

though its territory had been curtailed, was a serious rival of Sparta. But Argos was now no longer at the height of its power: its league had begun to break up early in the century, and it could not in the impending struggle count on the assistance of its old allies, Arcadia and Messenia, since the latter had been crushed and robbed of its independence and the former had acknowledged Spartan supremacy. A victory won about 546 B.C., when the Lydian Empire fell before Cyrus of Persia, made the Spartans masters of the Cynuria, the borderland between Laconia and Argolis, for which there had been an age-long struggle. The final blow was struck by King Cleomenes I. (*q.v.*), who maimed for many years to come the Argive power and left Sparta without a rival in the Peloponnese. In fact, by the middle of the 6th century, and increasingly down to the period of the Persian Wars, Sparta had come to be acknowledged as the leading state of Hellas and the champion of Hellenism. Croesus of Lydia had formed an alliance with her. Scythian envoys sought her aid to stem the invasion of Darius; to her the Greeks of Asia Minor appealed to withstand the Persian advance and to aid the Ionian revolt; Plataea asked for her protection; Megara acknowledged her supremacy; and at the time of the Persian invasion under Xerxes no state questioned her right to lead the Greek forces on land and sea. Of such a position Sparta proved herself wholly unworthy. As an ally she was ineffective, nor could she ever rid herself of her narrowly Peloponnesian outlook sufficiently to throw herself heartily into the affairs of the greater Hellas that lay beyond the isthmus and across the sea. She was not a colonizing state, though the inhabitants of Tarentum, in southern Italy, and of Lyttus, in Crete, claimed her as their mother-city. Moreover, she had no share in the expansion of Greek commerce and Greek culture; and, though she bore the reputation of hating tyrants and putting them down where possible, there can be little doubt that this was done in the interests of oligarchy rather than of liberty. Her military greatness and that of the states under her hegemony formed her sole claim to lead the Greek race: that she should truly represent it was impossible.

Constitution.—Of the internal development of Sparta down to this time but little is recorded. This want of information was attributed by most of the Greeks to the stability of the Spartan constitution, which had lasted unchanged from the days of Lycurgus. But it is, in fact, due also to the absence of an historical literature at Sparta, to the small part played by written laws, which were, according to tradition, expressly prohibited by an ordinance of Lycurgus, and to the secrecy which always characterizes an oligarchical rule. At the head of the state stood two hereditary kings, of the Agiad and Eurypontid families, equal in authority, so that one could not act against the veto of his colleague, though the Agiad king received greater honour in virtue of the seniority of his family (Herod. vi. 51). This dual kingship, a phenomenon unique in Greek history, was explained in Sparta by the tradition that on Aristodemus's death he had been succeeded by his twin sons, and that this joint rule had been perpetuated. Modern scholars have advanced various theories to account for the anomaly. Some suppose that it must be explained as an attempt to avoid absolutism, and is paralleled by the analogous instance of the consuls at Rome. Others think that it points to a compromise arrived at to end the struggle between two families or communities, or that the two royal houses represent respectively the Spartan conquerors and their Achaean predecessors: those who hold this last view appeal to the words attributed by Herodotus (v. 72) to Cleomenes I.: "I am no Dorian, but an Achaean." The duties of the kings were mainly religious, judicial and military. They were the chief priests of the state, and had to perform certain sacrifices and to maintain communication with the Delphian sanctuary, which always exercised great authority in Spartan politics. Their judicial functions had at the time when Herodotus wrote (about 430 B.C.) been restricted to cases dealing with heiresses, adoptions and the public roads: civil cases were decided by the ephors,

criminal jurisdiction had passed to the council of elders and the ephors. It was in the military sphere that the powers of the kings were most unrestricted. Aristotle describes the kingship at Sparta as "a kind of unlimited and perpetual generalship" (*Pol.* iii. 1285a), while Isocrates refers to the Spartans as "subject to an oligarchy at home, to a kingship on campaign" (iii. 24). Here also, however, the royal prerogatives were curtailed in course of time: from the period of the Persian wars the king lost the right of declaring war on whom he pleased, he was accompanied to the field by two ephors, and he was supplanted also by the ephors in the control of foreign policy. More and more, as time went on, the kings became mere figure-heads, except in their capacity as generals, and the real power was transferred to the ephors and to the *gerousia* (*q.v.*). The reason for this change lay partly in the fact that the ephors, chosen by popular election from the whole body of citizens, represented a democratic element in the constitution without violating those oligarchical methods which seemed necessary for its satisfactory administration; partly in the weakness of the kingship, the dual character of which inevitably gave rise to jealousy and discord between the two holders of the office, often resulting in a practical deadlock; partly in the loss of prestige suffered by the kingship, especially during the 5th century, owing to these quarrels, to the frequency with which kings ascended the throne as minors and a regency was necessary, and to the many cases in which a king was, rightly or wrongly, suspected of having accepted bribes from the enemies of the state and was condemned and banished. In the powers exercised by the assembly of the citizens or *apella* (*q.v.*) we cannot trace any development, owing to the scantiness of our sources. The Spartan was essentially a soldier, trained to obedience and endurance: he became a politician only if chosen as ephor for a single year or elected a life member of the council after his sixtieth year had brought freedom from military service.

Shortly after birth the child was brought before the elders of the tribe, who decided whether it was to be reared: if defective or weakly, it was exposed in the so-called

Training of Citizens.

Apothetai (*αἱ Ἀποθῆται*, from *ἀπόθετος*, hidden). Thus was secured, as far as could be, the maintenance of a high standard of physical efficiency, and thus from the earliest days of the Spartan the absolute claim of the state to his life and service was indicated and enforced. Till their seventh year boys were educated at home: from that time their training was undertaken by the state and supervised by the *παιδονόμος*, an official appointed for that purpose. This training consisted for the most part in physical exercises, such as dancing, gymnastics, ball-games, &c., with music and literature occupying a subordinate position. From the twentieth year began the Spartan's liability to military service and his membership of one of the *ἀνδρεία* or *φιλῆτια* (dining messes or clubs), composed of about fifteen members each, to one of which every citizen must belong. At thirty began the full citizen rights and duties. For the exercise of these three conditions were requisite: Spartiate birth, the training prescribed by law, and participation in and contribution to one of the dining-clubs. Those who fulfilled these conditions were the *δμοῖοι* (peers), citizens in the fullest sense of the word, while those who failed were called *ὑπομείονες* (lesser men), and retained only the civil rights of citizenship.

Spartiates were absolutely debarred by law from trade or manufacture, which consequently rested in the hands of the *perioeci* (*q.v.*), and were forbidden to possess either gold or silver, the currency consisting of bars of iron: but there can be no doubt that this prohibition was evaded in various ways. Wealth was, in theory at least, derived entirely from landed property, and consisted in the annual return made by the helots (*q.v.*) who cultivated the plots of ground allotted to the Spartiates. But this attempt to equalize property proved a failure: from early times there were marked differences of wealth within the state, and these became even more serious after the law of Epitadeus, passed

at some time after the Peloponnesian War, removed the legal prohibition of the gift or bequest of land. Later we find the soil coming more and more into the possession of large landholders, and by the middle of the 3rd century B.C. nearly two-fifths of Laconia belonged to women. Hand in hand with this process went a serious diminution in the number of full citizens, who had numbered 8000 at the beginning of the 5th century, but had sunk by Aristotle's day to less than 1000, and had further decreased to 700 at the accession of Agis IV. in 244 B.C. The Spartans did what they could to remedy this by law: certain penalties were imposed upon those who remained unmarried or who married too late in life. But the decay was too deep-rooted to be eradicated by such means, and we shall see that at a late period in Sparta's history an attempt was made without success to deal with the evil by much more drastic measures.

The 5th Century B.C.—The beginning of the 5th century saw Sparta at the height of her power, though her prestige must have suffered in the fruitless attempts made to impose upon Athens an oligarchical régime after the fall of the Peisistratid tyranny in 510. But after the Persian Wars the Spartan supremacy could no longer remain unchallenged. Sparta had despatched an army in 490 to aid Athens in repelling the armament sent against it by Darius under the command of Datis and Artaphernes: but it arrived after the battle of Marathon had been fought and the issue of the conflict decided. In the second campaign, conducted ten years later by Xerxes in person, Sparta took a more active share and assumed the command of the combined Greek forces by sea and land. Yet, in spite of the heroic defence of Thermopylae by the Spartan king Leonidas (*q.v.*), the glory of the decisive victory at Salamis fell in great measure to the Athenians, and their patriotism, self-sacrifice and energy contrasted strongly with the hesitation of the Spartans and the selfish policy

Persian Wars.

which they advocated of defending the Peloponnese only. By the battle of Plataea (479 B.C.), won by a Spartan general, and decided chiefly by the steadfastness of Spartan troops, the state partially recovered its prestige, but only so far as land operations were concerned: the victory of Mycale, won in the same year, was achieved by the united Greek fleet, and the capture of Sestos, which followed, was due to the Athenians, the Peloponnesians having returned home before the siege was begun. Sparta felt that an effort was necessary to recover her position, and Pausanias, the victor of Plataea, was sent out as admiral of the Greek fleet. But though he won considerable successes, his overbearing and despotic behaviour and the suspicion that he was intriguing with the Persian king alienated the sympathies of those under his command: he was recalled by the ephors, and his successor, Dorcis, was a weak man who allowed the transference of the hegemony from Sparta to Athens to take place without striking a blow (see DELIAN LEAGUE). By the withdrawal of Sparta and her Peloponnesian allies from the fleet the perils and the glories of the Persian War were left to Athens, who, though at the outset merely the leading state in a confederacy of free allies, soon began to make herself the mistress of an empire. Sparta took no steps at first to prevent this. Her interests and those of Athens did not directly clash, for Athens included in her empire only the islands of the Aegean and the towns on its north and east coasts, which lay outside the Spartan political horizon: with the Peloponnese Athens did not meddle. Moreover, Sparta's attention was at this time fully occupied by troubles nearer home—the plots of Pausanias not only with the Persian king but with the Laconian helots; the revolt of Tegea (*c.* 473-71), rendered all the more formidable by the participation of Argos; the earthquake which in 464 devastated Sparta; and the rising of the Messenian helots, which immediately followed. But there was a growing estrangement from Athens, which ended at length in an open breach. The insulting dismissal of a large body of Athenian troops which had come, under Cimon, to aid the Spartans in the siege of the Messenian stronghold of Ithome, the consummation of the Attic democracy under Ephialtes and Pericles, the conclusion of an alliance between Athens

War with Athens.

and Argos, which also about this time became democratic, united with other causes to bring about a rupture between the Athenians and the Peloponnesian League. In this so-called first Peloponnesian War Sparta herself took but a small share beyond helping to inflict a defeat on the Athenians at Tanagra in 457 B.C. After this battle they concluded a truce, which gave the Athenians an opportunity of taking their revenge on the Boeotians at the battle of Oenophyta, of annexing to their empire Boeotia, Phocis and Locris, and of subjugating Aegina. In 449 the war was ended by a five years' truce, but after Athens had lost her mainland empire by the battle of Coronea and the revolt of Megara a thirty years' peace was concluded, probably in the winter 446-445 B.C. By this Athens was obliged to surrender Troezen, Achaea and the two Megarian ports, Nisaea and Pegae, but otherwise the *status quo* was maintained. A fresh struggle, the great Peloponnesian War (*q.v.*), broke out in 431 B.C. This may be to a certain extent regarded as a contest between Ionian and Dorian; it may with greater truth be called a struggle between the democratic and oligarchic principles of government; but at bottom its cause was neither racial nor constitutional, but economic.

Peloponnesian War.

The maritime supremacy of Athens was used for commercial purposes, and important members of the Peloponnesian confederacy, whose wealth depended largely on their commerce, notably Corinth, Megara, Sicyon and Epidaurus, were being slowly but relentlessly crushed. Materially Sparta must have remained almost unaffected, but she was forced to take action by the pressure of her allies and by the necessities imposed by her position as head of the league. She did not, however, prosecute the war with any marked vigour: her operations were almost confined to an annual inroad into Attica, and when in 425 a body of Spartiates was captured by the Athenians at Pylos she was ready, and even anxious, to terminate the war on any reasonable conditions. That the terms of the Peace of Nicias, which in 421 concluded the first phase of the war, were rather in favour of Sparta than of Athens was due almost entirely to the energy and insight of an individual Spartan, Brasidas (*q.v.*), and the disastrous attempt of Athens to regain its lost land-empire. The final success of Sparta and the capture of Athens in 405 were brought about partly by the treachery of Alcibiades, who induced the state to send Gylippus to conduct the defence of Syracuse, to fortify Decelea in northern Attica, and to adopt a vigorous policy of aiding Athenian allies to revolt. The lack of funds which would have proved fatal to Spartan naval warfare was remedied by the intervention of Persia, which supplied large subsidies, and Spartan good fortune culminated in the possession at this time of an admiral of boundless vigour and considerable military ability, Lysander, to whom much of Sparta's success is attributable.

The 4th Century.—The fall of Athens left Sparta once again supreme in the Greek world and demonstrated clearly her total unfitness for rule. Everywhere democracy was replaced by a philo-Laonian oligarchy, usually consisting of ten men under a harmost or governor pledged to Spartan interests, and even in Laconia itself the narrow and selfish character of the Spartan rule led to a serious conspiracy. For a short time, indeed, under the energetic rule of Agesilaus, it seemed as if Sparta would pursue a Hellenic policy and carry on the war against Persia. But troubles soon broke out in Greece, Agesilaus was recalled from Asia Minor, and his schemes and successes were rendered fruitless. Further, the naval activity displayed by Sparta during the closing years of the Peloponnesian War abated when Persian subsidies were withdrawn, and the ambitious projects of Lysander led to his disgrace, which was followed by his death at Haliartus in 395. In the following year the Spartan navy under Peisander, Agesilaus' brother-in-law, was defeated off Cnidus by the Persian fleet under Conon and Pharnabazus, and for the future Sparta ceased to be a maritime power. In Greece itself meanwhile the opposition to Sparta was growing increasingly powerful, and, though at Coronea Agesilaus had slightly

the better of the Boeotians and at Corinth the Spartans maintained their position, yet they felt it necessary to rid themselves of Persian hostility and if possible use the Persian power to strengthen their own position at home: they therefore concluded with Artaxerxes II. the humiliating Peace of Antalcidas (387 B.C.), by which they surrendered to the Great King the Greek cities of the Asia Minor coast and of Cyprus, and stipulated for the independence of all other Greek cities. This last clause led to a long and desultory war with Thebes, which refused to acknowledge the independence of the Boeotian towns under its hegemony: the Cadmeia, the citadel of Thebes, was treacherously seized by Phoebeidas in 382 and held by the Spartans until 379. Still more momentous was the Spartan action in crushing the Olynthiac Confederation (see OLYNTHUS), which might have been able to stay the growth of Macedonian power. In 371 a fresh peace congress was summoned at Sparta to ratify the Peace of Callias. Again the Thebans refused to renounce their Boeotian hegemony, and the Spartan attempt at coercion ended in the defeat of the Spartan army at the battle of Leuctra and the death of its leader, King Cleombrotus. The result of the battle was to transfer the Greek supremacy from Sparta to Thebes.

In the course of three expeditions to the Peloponnese conducted by Epaminondas, the greatest soldier and statesman Thebes ever produced, Sparta was weakened by the loss of Messenia, which was restored to an independent position with the newly built Messene as its capital, and by the foundation of Megalopolis as the capital of Arcadia. The invading army even made its way into Laconia and devastated the whole of its southern portion; but the courage and coolness of Agesilaus saved Sparta itself from attack. On Epaminondas' fourth expedition Sparta was again within an ace of capture, but once more the danger was averted just in time; and though at Mantinea (362 B.C.) the Thebans, together with the Arcadians, Messenians and Argives, gained a victory over the combined Mantinean, Athenian and Spartan forces, yet the death of Epaminondas in the battle more than counterbalanced the Theban victory and led to the speedy break-up of their supremacy. But Sparta had neither the men nor the money to recover her lost position, and the continued existence on her borders of an independent Messenia and Arcadia kept her in constant fear for her own safety. She did, indeed, join with Athens and Achaea in 353 to prevent Philip of Macedon passing Thermopylae and entering Phocis, but beyond this she took no part in the struggle of Greece with the new power which had sprung up on her northern borders. No Spartiate fought on the field of Chaeronea. After the battle, however, she refused to submit voluntarily to Philip, and was forced to do so by the devastation of Laconia and the transference of certain border districts to the neighbouring states of Argos, Arcadia and Messenia. During the absence of Alexander the Great in the East Agis III. revolted, but the rising was crushed by Antipater, and a similar attempt to throw off the Macedonian yoke made by Archidamus IV. in the troublous period which succeeded Alexander's death was frustrated by Demetrius Poliorcetes in 294 B.C. Twenty-two years later the city was attacked by an immense force under Pyrrhus, but Spartan bravery had not died out and the formidable enemy was repulsed, even the women taking part in the defence of the city. About 244 an Aetolian army overran Laconia, working irreparable harm and carrying off, it is said, 50,000 captives.

Decline of Sparta.

Rise of Macedon.

But the social evils within the state were even harder to combat than foes without. Avarice, luxury and the glaring inequality in the distribution of wealth, threatened to bring about the speedy fall of the state if no cure could be found. Agis IV. and Cleomenes III. (*qq.v.*) made an heroic and entirely disinterested attempt in the latter part of the 3rd century to improve the conditions by a redistribution of land, a widening of the citizen body, and a restoration of the old severe training and simple life. But the evil was too deep-seated to be remedied by these artificial means; Agis was assassinated, and the

reforms of Cleomenes seem to have had no permanent effect. The reign of Cleomenes is marked also by a determined effort to cope with the rising power of the Achaean League (*q.v.*) and to recover for Sparta her long-lost supremacy in the Peloponnese, and even throughout Greece. The battle of Sellasia (222 B.C.), in which Cleomenes was defeated by the Achaeans and Antigonos Doson of Macedonia, and the death of the king, which occurred shortly afterwards in Egypt, put an end to these hopes. The same reign saw also an important constitutional change, the substitution of a board of patronomi for the ephors, whose power had become almost despotic, and the curtailment of the functions exercised by the gerousia; these measures were, however, cancelled by Antigonos. It was not long afterwards that the dual kingship ceased and Sparta fell under the sway of a series of cruel and rapacious tyrants—Lycurgus, Machanidas, who was killed by Philopoemen, and Nabis, who, if we may trust the accounts given by Polybius and Livy, was little better than a bandit chieftain, holding Sparta by means of extreme cruelty and oppression, and using mercenary troops to a large extent in his wars.

The Intervention of Rome.—We must admit, however, that a vigorous struggle was maintained with the Achaean League and with Macedon until the Romans, after the conclusion of their war with Philip V., sent an army into Laconia under T. Quinctius Flamininus. Nabis was forced to capitulate, evacuating all his possessions outside Laconia, surrendering the Laconian seaports and his navy, and paying an indemnity of 500 talents (Livy xxxiv. 33-43). On the departure of the Romans he succeeded in recovering Gythium, in spite of an attempt to relieve it made by the Achaeans under Philopoemen, but in an encounter he suffered a crushing defeat at the hands of that general, who for thirty days ravaged Laconia unopposed. Nabis was assassinated in 192, and Sparta was forced by Philopoemen to enrol itself as a member of the Achaean League

(*q.v.*) under a phil-Achaean aristocracy. But this gave rise to chronic disorders and disputes, which led to armed intervention on the part of the Achaeans, who compelled the Spartans to submit to the overthrow of their city walls, the dismissal of their mercenary troops, the recall of all exiles, the abandonment of the old Lycurgan constitution and the adoption of the Achaean laws and institutions (188 B.C.). Again and again the relations between the Spartans and the Achaean League formed the occasion of discussions in the Roman senate or of the despatch of Roman embassies to Greece, but no decisive intervention took place until a fresh dispute about the position of Sparta in the league led to a decision of the Romans that Sparta, Corinth, Argos, Arcadian Orchomenus and Heraclea on Oeta should be severed from it. This resulted in an open breach between the league and Rome, and eventually, in 146 B.C., after the sack of Corinth, in the dissolution of the league and the annexation of Greece to the Roman province of Macedonia. For Sparta the long era of war and intestine struggle had ceased and one of peace and a revived prosperity took its place, as is witnessed by the numerous extant inscriptions belonging to this period. As an allied city it was exempt from direct taxation, though compelled on occasions to make "voluntary" presents to Roman generals. Political ambition was restricted to the tenure of the municipal magistracies, culminating in the offices of nomophylax, ephor and patronomus. Augustus showed marked favour to the city, Hadrian twice visited it during his journeys in the East and accepted the title of eponymous patronomus. The old warlike spirit found an outlet chiefly in the vigorous but peaceful contests held in the gymnasium, the ball-place, and the arena before the temple of Artemis Orthia: sometimes too it found a vent in actual campaigning, as when Spartans were enrolled for service against the Parthians by the emperors Lucius Verus, Septimius Severus and Caracalla. Laconia was subsequently overrun, like so much of the Roman Empire, by barbarian hordes.

Medieval Sparta.—In A.D. 396 Alaric destroyed the city and at a later period Laconia was invaded and settled by Slavonic

tribes, especially the Melings and Ezerits, who in turn had to give way before the advance of the Byzantine power, though preserving a partial independence in the mountainous regions. The Franks on their arrival in the Morea found a fortified city named Lacedaemonia occupying part of the site of ancient Sparta, and this continued to exist, though greatly depopulated, even after Guillaume de Villehardouin had in 1248-1249 founded the fortress and city of Misithra, or Mistra, on a spur of Taygetus some 3 m. north-west of Sparta. This passed shortly afterwards into the hands of the Byzantines, who retained it until the Turks under Mahommed II. captured it in 1460. In 1687 it came into the possession of the Venetians, from whom it was wrested in 1715 by the Turks. Thus for nearly six centuries it was Mistra and not Sparta which formed the centre and focus of Laconian history.

The Modern City.—In 1834, after the War of Independence had resulted in the liberation of Greece, the modern town of Sparta was built on part of the ancient site from the designs of Baron Jochmus, and Mistra decayed until now it is in ruins and almost deserted. Sparta is the capital of the prefecture (*νομός*) of Lacedaemon and has a population, according to the census taken in 1907, of 4456: but with the exception of several silk factories there is but little industry, and the development of the city is hampered by the unhealthiness of its situation, its distance from the sea and the absence of railway communication with the rest of Greece. As a result of popular clamour, however, a survey for a railway was begun in 1907, an event of great importance for the prosperity of Sparta and of the whole Eurotas Plain.

II.—ARCHAEOLOGY

There is a well-known passage in Thucydides which runs thus: "Suppose the city of Sparta to be deserted, and nothing left but the temples and the ground-plan, distant ages would be very unwilling to believe that the power of the Lacedaemonians was at all equal to their fame. . . . Their city is not built continuously, and has no splendid temples or other edifices; it rather resembles a group of villages, like the ancient towns of Hellas, and would therefore make a poor show" (i. 10, trans. Jowett). And the first feeling of most travellers who visit modern Sparta is one of disappointment with the ancient remains: it is rather the loveliness and grandeur of the situation and the fascination of Mistra, with its grass-grown streets, its decaying houses, its ruined fortress and its beautiful Byzantine churches, that remain as a lasting and cherished memory. Until 1905 the chief ancient buildings at Sparta were the theatre, of which, however, little shows above ground except portions of the retaining walls; the so-called Tomb of Leonidas, a quadrangular building, perhaps a temple, constructed of immense blocks of stone and containing two chambers; the foundation of an ancient bridge over the Eurotas; the ruins of a circular structure; some remains of late Roman fortifications; several brick buildings and mosaic pavements. To these must be added the inscriptions, sculptures and other objects collected in the local museum, founded by Stamatakis in 1872 and enlarged in 1907, or built into the walls of houses or churches. Though excavations were carried on near Sparta, on the site of the Amyclaeum in 1890 by Tsountas, and in 1904 by Furtwängler, and at the shrine of Menelaus in Therapne by Ross in 1833 and 1841, and by Kastriotis in 1889 and 1900, yet no organized work was tried in Sparta itself save the partial excavation of the "round building" undertaken in 1892 and 1893 by the American School at Athens; the structure has been since found to be a semicircular retaining-wall of good Hellenic work, though partly restored in Roman times.

In 1904 the British School at Athens began a thorough exploration of Laconia, and in the following year excavations were made at Thalamae, Geronthrae, and Angelona near Monemvasia, while several medieval fortresses were surveyed. In 1906 excavations began in Sparta itself with results of great value, which have been published in the *British School Annual*, vol. xii. sqq.

A "small circus" described by Leake, but subsequently almost lost to view, proved to be a theatre-like building constructed soon after A.D. 200 round the altar and in front of the temple of Artemis Orthia. Here musical and gymnastic contests took place as well as the famous flogging-ordeal (*diamastigosis*). The temple, which can be dated to the 2nd century B.C. rests on the foundation of an older temple of the 6th century, and close beside it were found the scanty remains of a yet earlier temple, dating from the 9th or even the 10th century. The votive offerings in clay, amber, bronze, ivory and lead found in great profusion within the precinct range from the 9th to the 4th century B.C. and supply invaluable evidence for early Spartan art; they prove that Sparta reached her artistic zenith in the 7th century and that her decline had already begun in the 6th. In 1907 the sanctuary of Athena "of the Brazen House" (*Χαλκίαικος*) was located on the Acropolis immediately above the theatre, and though the actual temple is almost completely destroyed, fragments of the capitals show that it was Doric in style, and the site has produced the longest extant archaic inscription of Laconia, numerous bronze nails and plates and a considerable number of votive offerings, some of them of great interest. The Greek city-wall, built in successive stages from the 4th to the 2nd century, was traced for a great part of its circuit, which measured 48 stades or nearly 6 m. (Polyb. ix. 21). The late Roman wall enclosing the Acropolis, part of which probably dates from the years following the Gothic raid of A.D. 262, was also investigated. Besides the actual buildings discovered, a number of points were fixed which greatly facilitate the study of Spartan topography, based upon the description left us by Pausanias. Excavations carried on in 1910 showed that the town of the "Mycenean" period which lay on the left bank of the Eurotas a little to the south-east of Sparta was roughly triangular in shape, with its apex towards the north: its area is approximately equal to that of Sparta, but denudation and destruction have wrought havoc with its buildings and nothing is left save ruined foundations and broken potsherds.

AUTHORITIES.—*History*: J. C. F. Manso, *Sparta* (3 vols., Leipzig, 1800–1805); G. Gilbert, *Studien zur altspartanischen Geschichte* (Göttingen, 1872); G. Busolt, *Die Lakedaimonier und ihre Bundesgenossen* (Leipzig, 1878), for the 6th century and the Persian wars; W. Herbst, *Zur Geschichte der auswärtigen Politik Spartas im Zeitalter des peloponnesischen Krieges* (Leipzig, 1853); E. von Stern, *Geschichte der spartan. u. thebanischen Hegemonie*, &c. (Dorpat, 1884), from 387 to 362 B.C.; J. Fesemair, *Sparta von der Schlacht bei Leuktra bis zum Verschwinden des Namens* (Munich, 1865); and the general Greek histories of G. Grote, E. Meyer, G. Busolt, J. Beloch, A. Holm, B. Niese, E. Abbott and J. B. Bury.

Constitution: C. O. Müller, *The History and Antiquities of the Doric Race* (2 vols., Eng. trans., 2nd ed., London, 1839); K. H. Lachmann, *Die spartanische Staatsverfassung in ihrer Entwicklung und ihrem Verfall* (Breslau, 1836); A. Solari, *Ricerche spartane* (Leghorn, 1907); H. Gabriel, *De magistratibus Lacedaemoniorum* (Berlin, n.d.); L. Auerbach, *De Lacedaemoniorum regibus* (Berlin, 1863); B. Niese, "Herodotstudien, besonders zur spart. Geschichte," in *Hermes* (1907), xlii. 419 sqq.; the constitutional histories of G. Gilbert, G. F. Schömann, G. Busolt and A. H. J. Greenidge, and the works cited under *APELLA*; *EPHOR*; *GEROUSIA* and *LYCURGUS*.

Land Tenure: M. Duncker, "Die Hufen der Spartiaten," in *Berichte der berl. Akademie* (1881), pp. 138 sqq.; K. F. Hermann, *De causis turbatae apud Lacedaemonios agrorum aequalitatis* (Marburg, 1834); C. Reuss, *De Lycurgea quae fertur agrorum divisione* (Pforzheim, 1878).

Army: G. Busolt, "Spartas Heer und Leuktra," in *Hermes* (1905), xl. 387 sqq.; J. Kromayer, "Die Wehrkraft Lakoniens u. seine Wehrverfassung," in *Beiträge zur alten Geschichte* (1903), iii. 173 sqq.; H. K. Stein, *Das Kriegswesen der Spartaner* (Konitz, 1863).

Topography and Antiquities: W. M. Leake, *Morca*, chs. iv. v.; E. Curtius, *Peloponnesos*, ii. 220 sqq.; C. Bursian, *Geographie*, ii. 119 sqq.; Pausanias, iii. 11–18; and the commentary in J. G. Frazer, *Pausanias*, iii. 322 sqq.; W. G. Clark, *Peloponnesus*, pp. 158 sqq.; E. P. Boblaye, *Recherches*, pp. 78 sqq.; W. Vischer, *Erinnerungen*, pp. 371 sqq.; Bory de Saint-Vincent, *Relation*, pp. 418 sqq.; G. A. Blouet, *Architecture*, ii. 61 sqq., pl. 44–52; for full titles and dates of publication of these works, see under *LACONIA*; H. K. Stein, *Topographie des alten Sparta* (Glatz, 1890); K. Nestorides, *Τοπογραφία τῆς ἀρχαίας Σπάρτης* (Athens, 1892); N. E. Crosby, "The Topography of Sparta," in *American Journal of Archaeology* (Princeton, 1893), viii. 335 sqq.; and various articles in the *British School Annual*, xii. sqq.

Inscriptions: M. N. Tod and A. J. B. Wace, *Catalogue of the Sparta Museum* (Oxford, 1906); *British School Annual*, xii. sqq., and the works cited under *LACONIA*.

Dialect: K. Müllensiefen, *De titulorum laconicorum dialecto* (Strasburg, 1882); R. Meister, *Dorier und Achäer* (Leipzig, 1904).

Art: M. N. Tod and A. J. B. Wace, *op. cit.*; H. Dressel and A. Milchhöfer, "Die antiken Kunstwerke aus Sparta u. Umgebung," in *Athenische Mitteilungen*, ii. 293 sqq.; E. Beulé, "L'Art à Sparte," in *Études sur le Péloponnèse* (Paris, 1855). (M. N. T.)

SPARTACUS, leader in the Slave or Gladiatorial War against Rome (73–71 B.C.), a Thracian by birth. He served in the Roman army, but seems to have deserted, for we are told that he was taken prisoner and sold as a slave. Destined for the arena, he, with a band of his fellow-gladiators, broke out of a training school at Capua and took refuge on Mt Vesuvius (73). Here he maintained himself as a captain of brigands, his lieutenants being two Celts named Crixus and Oenomaus, who like himself had been gladiators. A hastily collected force of 3000 men under C. Claudius Pulcher endeavoured to starve out the rebels, but the latter clambered down the precipices and put the Romans to flight. Swarms of hardy and desperate men now joined the rebels, and when the praetor Publius Varinius took the field against them he found them entrenched like a regular army on the plain. But they gave him the slip, and when he advanced to storm their lines he found them deserted. From Campania the rebels marched into Lucania, a country better suited for guerrilla warfare. Varinius followed, but was defeated in several engagements and narrowly escaped being taken prisoner. The insurgents reoccupied Campania, and by the defeat of C. Thoranius, the quaestor of Varinius, obtained possession of nearly the whole of southern Italy. Nola and Nuceria in Campania, Thurii and Metapontum in Lucania were sacked. The senate at last despatched both consuls against the rebels (72). The German slaves under Crixus were defeated at Mt Garganus in Apulia by the praetor Q. Arrius. But Spartacus overthrew both consuls, one after the other, and then pressed towards the Alps. Gaius Cassius, governor of Cisalpine Gaul, and the praetor Gnaeus Manlius, who attempted to stop him, were defeated at Mutina. Freedom was within sight, but with fatal infatuation the slaves refused to abandon Italy. Spartacus led them against Rome, but their hearts seem to have failed them; and instead of attacking the capital, he passed on again to Lucania. The conduct of the war was now entrusted to the praetor Marcus Licinius Crassus. In the next battle Spartacus was worsted and retreated towards the straits of Messina, intending to cross into Sicily, where he would have been welcomed by fresh hordes of slaves; but the pirates who had agreed to transport his army proved faithless. Crassus endeavoured to shut in the rebels by carrying a ditch and rampart right across the peninsula, but Spartacus forced the lines, and once more Italy lay at his feet. Disunion, however, was at work in the rebel camp. The Gauls and Germans, who had withdrawn from the main body, were attacked and destroyed. Spartacus now took up a strong position in the mountainous country of Petelia (near Strongoli in Calabria) and inflicted a severe defeat on the vanguard of the pursuing army. But his men refused to retreat farther, and in a pitched battle which followed soon afterwards the rebel army was annihilated. Spartacus, who had stabbed his horse before the battle, fell sword in hand. A body of the rebels which had escaped from the field was met and cut to pieces at the foot of the Alps by Pompey (the Great), who was returning from Spain. Pompey claimed the credit of finishing the war, and received the honour of a triumph, while only a simple ovation was decreed to Crassus. Spartacus was a capable and energetic leader; he did his best to check the excesses of the lawless bands which he commanded, and treated his prisoners with humanity. His character has been misrepresented by Roman writers, whom his name inspired with terror down to the times of the empire. The story has to be pieced together from the vague and somewhat discrepant accounts of Plutarch (*Crassus*, 8–11; *Pompey*, 21), Appian (*Bell. civ.* i. 116–120), Florus, (ii. 8), Livy (*Epit.* 95–97), and the fragments of the *Histories* of Sallust, whose account seems to have been full and graphic.

SPARTANBURG, a city and the county-seat of Spartanburg county, South Carolina, U.S.A., about 94 m. N.W. of Columbia. Pop. (1890), 5544; (1900), 11,395, of whom 4269 were negroes; (1906, estimate), 14,905. Spartanburg is served by the Southern, the Charleston & Western Carolina (controlled by the Atlantic Coast line), the Glenn Springs, the Carolina, Clinchfield & Ohio, and inter-urban (electric) railways. It is a thriving city in a cotton-growing and cotton-manufacturing region, about 800 ft. above the sea and 25 m. S.E. of the Blue Ridge. Spartanburg is the seat of Wofford College (Methodist Episcopal, South; founded in 1850 with a bequest of Benjamin Wofford, a local Methodist minister, and opened in 1854), which had, in 1908, 12 instructors and 286 students; also of Converse College (nonsectarian; for women), which was founded by D. E. Converse in 1889, opened in 1890, and in 1908 had 22 instructors and 355 students. An annual musical festival is held here under the auspices of the Converse College Choral Society. Four miles south of the city, at Cedar Spring, is the South Carolina Institution for the Education of the Deaf and Blind, founded as a private institution in 1849 and taken over by the state in 1857. There are gold-mines near the city; and Spartanburg county produces large crops of cotton. Cotton mills are the basis of the city's prosperity, and it has also a large wholesale trade, iron-working establishments, and various manufactures. The value of its factory product was \$2,127,702 in 1905, or 33.7% more than in 1900. Spartanburg was founded in 1787, and, although railway communication with Columbia and Charleston was opened in 1859, there was little growth until the establishment of the first cotton mill in the vicinity in 1880; it was chartered as a city in this year.

SPEAKER, a title of the presiding officer in the legislatures of various countries. In the English parliament the lord chancellor acts as Speaker of the House of Lords, but should his office be in commission the Crown usually appoints a Speaker to supply his place, a case in point being that of Sir L. Shadwell, vice-chancellor, who in 1835 was appointed Speaker during the time the Great Seal was in commission. Unlike the House of Commons, the Speaker of the House of Lords need not necessarily be a member of the House; Brougham in 1830 sat on the woolsack as Speaker in his capacity of lord chancellor, being then plain Mr Brougham, his patent of nobility not having yet been made out. The House of Lords has also deputy Speakers who are appointed by commission. The duties of the Speaker of the House of Lords are defined by a standing order as follows: "The lord chancellor, when he speaks to the House, is always to speak uncovered, and is not to adjourn the House, or to do anything else as mouth of the House, without the consent of the Lords first had, except the ordinary thing about bills, which are of course, wherein the Lords may likewise overrule; as for preferring one bill before another, and such-like; and in case of difference among the Lords, it is to be put to the question; and if the lord chancellor will speak to anything particularly he is to go to his own place as a peer." The Speaker of the House of Lords, as compared with the Speaker of the House of Commons, is an official without power; even his seat, the woolsack, is technically outside the House. Contrary to the practice in the Commons, he acts as a strong party man, making speeches on behalf of government measures from his place as a peer. Proposals have from time to time been made for augmenting the powers of the Speaker of the House of Lords, but it has been pointed out that, as he is a minister of the Crown, and not chosen by the House itself, and moreover is often the member of the least experience in the House, it would be inexpedient that he should exercise the same powers as the Speaker of the Commons.

The Speaker of the House of Commons is always a member of that House, and though chosen by the members themselves (subject to the approval of the sovereign) from one of the great political parties, he never either votes (except in the case of a tie) or speaks in his capacity as a member during the time he holds office. His duty is to enforce the observance of the rules laid down for preserving order in the proceedings of the

House; he puts every question and declares the determination thereon. As "mouth of the House" he communicates its resolutions to others, conveys its thanks, and expresses its censure, its reprimands or its admonitions. He issues warrants for executing the orders of the House, as the commitment of offenders, the issue of writs, the attendance of witnesses or prisoners in custody, &c. The symbol of his authority is the mace, which is borne before him by the serjeant-at-arms when he enters or leaves the House; it reposes on the table when he is in the chair, and it accompanies him on all state occasions. The Speaker takes precedence of all commoners in the kingdom both by ancient custom and by legislative declaration (1 Will. & Mary c. 21). His salary is £5000 a year. It is usual to create a retiring Speaker a peer of the realm, generally with the rank of viscount. The office is of great antiquity, and in the various conflicts between the Commons and the Crown was one of considerable difficulty, especially when, as mouthpiece of the House, he had to read petitions or addresses or deliver in the presence of the sovereign speeches on their behalf. The first to whom the title was definitely given was Sir Thomas Hungerford (d. 1398).

A list of Speakers, most of whom are separately noticed, from 1600 is appended. The date of election is given in brackets:—

- | | |
|----------------------------|---------------------------------|
| J. Croke (1601). | Sir T. Hanmer (1714). |
| Sir E. Phelps (1604). | *S. Compton (1715) |
| Sir R. Crewe (1614). | (<i>Earl of Wilmington</i>). |
| T. Richardson (1621). | *A. Onslow (1728). |
| *Sir T. Crewe (1624). | *Sir J. Cust (1761). |
| Sir H. Finch (1626). | *Sir Fletcher Norton (1770) |
| Sir J. Finch (1628). | (<i>Lord Granlyl</i>). |
| J. Glanville (1640). | *C. W. Cornwall (1780). |
| *W. Lenthall (1640). | W. W. Grenville (1789) |
| H. Pelham (1647). | (<i>Lord Grenville</i>). |
| F. Rous (1653). | *H. Addington (1789) |
| Sir T. Widdrington (1656). | (<i>Viscount Sidmouth</i>). |
| C. Chute (1659). | Sir J. Mitford (1801) |
| Sir L. Long (1659). | (<i>Lord Redesdale</i>). |
| T. Bampfylde (1659). | *C. Abbott (1802) |
| W. Say (1660). | (<i>Lord Cheshster</i>). |
| Sir H. Grimston (1660). | *H. C. M. Sutton (1817) |
| Sir E. Turnour (1661). | (<i>Viscount Canterbury</i>). |
| Sir J. Charlton (1673). | *J. Abercromby (1835) |
| *E. Seymour (1673). | (<i>Lord Dunfermline</i>). |
| Sir R. Sawyer (1678). | *C. Shaw Lefevre (1841) |
| Sir W. Gregory (1679). | (<i>Viscount Eversley</i>). |
| *W. Williams (1680). | *J. E. Denison (1857) |
| *Sir J. Trevor (1685). | (<i>Viscount Ossington</i>). |
| H. Powle (1689). | *H. B. Brand (1872) |
| P. Foley (1695). | (<i>Viscount Hampden</i>). |
| Sir T. Littleton (1698). | *A. W. Peel (1884) |
| *R. Harley (1701) | (<i>Viscount Peel</i>). |
| (<i>Earl of Oxford</i>). | *W. C. Gully (1895) |
| *J. Smith (1705). | (<i>Viscount Selby</i>). |
| Sir R. Onslow (1708). | *J. W. Lowther (1905). |
| W. Bromley (1710). | |

* Speaker in more than one parliament.

The title of Speaker is also applied to the presiding officer of the various legislative assemblies in the British colonies, that of president being applied to the presiding officer of the upper houses, legislative councils as they are usually called. In Canada, however, the presiding officer both of the Senate and the House of Commons is termed Speaker. In the United States the Speaker of the House of Representatives is an officer of considerable power (see UNITED STATES: *Constitution and Government*).

AUTHORITIES.—Stubbs, *Constitutional History*; J. A. Manning, *Lives of the Speakers* (1850); E. Lummis, *The Speaker's Chair*

¹ Brother of Sir R. Crewe.

² Speaker of the Long Parliament.

³ Convicted of bribery and expelled, 1695.

⁴ First Speaker of the Commons of Great Britain.

⁵ Nephew of Sir R. Onslow, Speaker in 1708 and great-great-grandson of R. Onslow, Speaker in the second parliament of Elizabeth. Arthur Onslow was the second Speaker to be elected five times; the first Speaker to be so elected was Thomas Chaucer in the reign of Henry V. Onslow also held the Speakership for the longest period (1727–1761).

⁶ Afterwards prime minister. Was first Speaker of the Commons of the United Kingdom.

⁷ First to be Speaker six times and seven times.

(1900); for the United States, J. Bryce, *American Commonwealth*, M. P. Follett's *The Speaker of the House of Representatives* (New York, 1896); H. B. Fuller, *Speakers of the House* (Boston, 1909).

SPEAR (O. Eng. *spere*, O. H. Ger. *spër*, mod. Ger. *speer*, &c., cf. Lat. *sparus*; probably related to "spar," a beam), a weapon of offence. Developed from a sharp-headed stake, the spear may be reckoned, with the club, as among the most ancient of weapons. All the prehistoric races handled the spear; all savage folk thrust with it or hurl it; civilized man still keeps it as the lance and the boar-spear; indeed, the bayonet is a spear-head with the rifle for a shaft.

The English before the Norman conquest were a spear-bearing race. The freeman's six-foot ashen spear was always near his hand; and its head is found beside the bones of every warrior. The casting javelin was commoner than the bow. Norman horsemen made the long lance, a dozen feet long, its pennon fluttering below the point, the knightly weapon. Throwing spears became rare, the Black Prince's English knights wondering at the Spanish fashion of casting darts. In the 14th century the vamplate came into use as a guard for the lance hand above the grip. At this time also the coronel head was devised for the better safeguard of the jousters, many of whom, however, preferred the blunted or "rebated" point. The next step in development gave the shaft a swell towards the hand on both sides of the grip, a swell exaggerated in the jousting lance of the 16th century, which, fluted and hollowed, is found weighing twenty pounds, with a girth of as much as 27½ in. at its broadest part. Leather "bures" were added below the grip and, before the end of the 14th century, the weight of the jousting lance called for the use of the lance-rest, a hook or catch screwed to the right breast of the harness.

The Scots, always weaker than the English in archery, favoured the long spear as the chief weapon of the infantry, and from Falkirk onwards held their own in their "schiltron" formation against all cavalry, until riddled and disarrayed by the arrow-flights. Their English enemy, when arquebusiers began to oust the archers, exchanged the old bills for those 18 and 20 ft. pikes which bristled from the squares protecting the "shot." At the same time, the English horsemen began to leave the lance for sword, pistol and musketoon. During the civil wars in the 17th century every man on foot was either pikeman or musketeer. After 1675 the long pike gave way to the bayonet in its first shape of a dagger whose hilt could be struck into the muzzle of the musket, and, some fourteen years later, the bayonet with a ring-catch gave the infantryman the last form of his pike. Sergeants, however, carried through the 18th century a "halbert" (*q.v.*) which, in its degenerate form, became a short pike, and infantry officers were sometimes armed with the spontoon. In 1816 certain dragoon regiments were given the lance which had been seen at work in the hands of Poles and Cossacks; and the weapon is still part of the service equipment although controversy is still hot over its value in action, its supporters urging the demoralizing effect of the lance against broken troops. Queen Victoria's navy gave up, in favour of the cutlass bayonet, the pikes which were once served out to repel attacks of boarders. At the present day the High Sheriff's party of javelin-men are the only Englishmen who march on foot with the ancient weapon. (See further LANCE.)

SPECIES, a term, in its general and once familiar significance, applied indiscriminately to animate and inanimate objects and to abstract conceptions or ideas, as denoting a particular phase, or sort, in which anything might appear. In logic it came to be used as the translation of the Gr. *εἶδος*, and meant a number of individuals having common characters peculiar to them, and so forming a group which with other groups were included in a higher group. The application of the term was purely relative, for the higher group itself might be one of the "species," or modes of a still higher group. In medicine it was used for the constituents of a prescription. In algebra it denoted the characters which represented quantities in an equation.

Early writers on natural history used the term in its vague logical sense without limiting it to a special category in the hierarchy of classification. To John Ray, the famous English naturalist, the credit is generally given of first making species a definite term in zoology and botany, but Ray owed much of his classification to Kaspar or Gaspard Bauhin (1550-1624), professor of Greek and of Anatomy and Botany at Basel, and much of his clear definition of terms to an unpublished MS. of Joachim Jung of Hamburg (1587-1657). Sir W. T. Thisleton Dyer (*Edinburgh Review*, 1902, p. 370) thinks that Ray's use of the word may be traced to the last-mentioned authors. It is clear, however, that through Ray's work in the 17th century the common biological application of species became fixed much in its modern form, as denoting a group of animals or plants capable of interbreeding, and although not necessarily quite identical, with marked common characters. Working on these lines, and attaching special importance to common descent, naturalists applied the term with more and more precision, until Linnaeus, in his *Philosophia botanica*, gave the aphorism, "species tot sunt diversae, quot diversae formae ab initio sunt creatae"—"just so many species are to be reckoned as there were forms created at the beginning." Linnaeus' invention of binomial nomenclature for designating species served systematic biology admirably, but at the same time, by attaching preponderating importance to a particular grade in classification, crystallized the doctrine of fixity. The lower grades in classification such as sub-species and varieties on the one hand, and the higher grades on the other, such as genera and families, were admitted to be human conceptions imposed on the living world, but species were concrete, objective existences to be discovered and named. G. L. L. Buffon and J. P. B. Lamarck practically conceded the objective existence of species in arguing that they might be modified by external conditions, and G. L. Cuvier proclaimed their fixity without reserve. Charles Darwin found the conception of species so definite and fixed that he chose for the title of his great book (1859) the words *On the Origin of Species by Means of Natural Selection*, although his exposition of evolution applied equally to every grade in classification. E. B. Poulton, in an admirable discussion of contemporary views regarding species (presidential address to the Entomological Society of London 1904), has shown that Darwin did not believe in the objective existence of species, not only because he was led to discard the hypothesis of special creation as the explanation of the polymorphism of life, but because in practice as a working systematist he could neither find for himself nor ascertain from other systematists any settled criteria by which a group of specimens could be elevated into a genus, accepted as a species, or regarded as a variety.

The vast advance in knowledge of the existing forms of living things that has been acquired and recorded since 1859 has accentuated the difficulty of finding any morphological criteria for species. A few writers have insisted that they are discontinuous, and that real gaps exist between them. Equally great gaps, however, may exist between males and females, between climatic phases or summer and winter forms. The attempt to find a physiological criterion has similarly failed; many forms that have been universally accepted as true species produce fertile hybrids (see HYBRIDISM). In modern practice (see ZOOLOGICAL NOMENCLATURE) systematists no longer regard species as more than as an artificial rank in classification, to be applied chiefly for reasons of convenience, so that the word is reverting to its older logical significance. The word "species" now signifies a grade or rank in classification assigned by systematists to an assemblage of organic forms which they judge to be more closely interrelated by common descent than they are related to forms judged to be outside the species, and of which the known individuals, if they differ amongst themselves, differ less markedly than they do from those outside the species, or, if differing markedly, are linked by intermediate forms. It is to be noted that the individuals may themselves be judged to fall into groups of minor rank, known as sub-species

or local varieties, but such subordinate assemblages are elevated to specific rank, if they appear not to intergrade so as to form a linked species, whilst on the other hand assemblages judged to be species are merged, or degraded to sub-species, if they are found to intergrade by discoveries of linking forms. A species, in short, is a subjective conception, and some writers, as for instance E. Ray Lankester, have urged that the word is so firmly associated with historical implications of fixity which are now incongruous with its application, that it ought to be discarded from scientific nomenclature.

In technical biology each species is designated by two words, one for the genus, printed with an initial capital, and one for the particular species, printed without an initial capital in Zoology, whilst in Botany the habit once common to both subjects is retained, and the specific name if derived from a proper name is printed with a capital. The two words are printed in italics, and may be followed by the name of the author who first described the species. Thus "*Canis vulpes* Linnaeus" is the specific designation of the common fox, *Canis* being the generic term common to dogs, wolves and so forth, and *vulpes* indicating the particular species, whilst the attached author's name indicates that Linnaeus first named the species in question. (P. C. M.)

SPECIFICATION (from Med. Lat. *specificatio, specificare*, to enumerate or mention in detail), any detailed statement, especially one on which an estimate or plan is based, as the specification of a builder or architect (see BUILDING). In patent law a specification is a description of an invention. An application for a patent must be accompanied by a specification, either provisional or complete. If a complete specification does not accompany the application, it must be forwarded usually within six months of the date of application, otherwise the application is deemed to be abandoned. A provisional specification declares the nature of the invention in general terms, while a complete specification describes the invention in detail, and shows the manner in which it is to be carried out (see further PATENTS).

In the civil law (see ACCESSION) specification was the working up of a thing into a new product; for example, the making of bread from grain. The effect of specification was that the original owner lost his title in favour of the creator of the new product, but had an action for the value of the materials.

SPECIFIC PERFORMANCE, an equitable doctrine under which a court of equity, in certain exceptional cases where the normal legal remedy, *i.e.* damages, would not be a sufficient compensation, orders from a defaulting party a specific or actual performance of the thing which he had contracted to do. The courts act on their own discretion in affording or refusing the relief of specific performance, and as a general rule will refuse that relief where the common law remedy is adequate, where the court would be unable to superintend or enforce the execution of its judgment, where the plaintiff has himself acted inequitably, or where the enforcement of specific performance would be unreasonable. Specific performance is usually confined to executory agreements, such as a conveyance or a lease of land; it is not usually enforced in the cases of personal acts or in those of contracts for personal service. In the case of a contract for the sale of a chattel the courts will only order specific performance when the chattel is of peculiar value to the purchaser and cannot be obtained elsewhere. The courts are guided considerably by precedent, and it is only by reference to a standard textbook that details can be obtained of the conditions and restrictions which hedge the jurisdiction of the courts. In Scots law specific performance, or "implement," is part of the ordinary jurisdiction of the courts.

See Fry on *Specific Performance*; *Ency. English Law*, tit. "Specific Performance"; and Story, *Equity Jurisprudence*.

SPECTACLES, the name given to flat glasses, prisms, spherical or cylindrical lenses, mechanically adjusted to the human eyes, so as to correct defects of vision (*q.v.*). They are made usually of crown glass or rock crystal ("pebbles"), the latter being somewhat lighter and cooler to wear. They are mounted in

rigid steel wire or gold frames, with fastening-pieces over the ears; single or double eye-glasses, and hand-glasses, or lorgnettes, being varieties of form, according to the circumstances and the wearer's taste.

Preserves.—Preserves are used to conceal deformities or to protect the eyes in the many conditions where they cannot tolerate bright light, such as ulceration and inflammation of the cornea, certain diseases of the iris, ciliary body, choroid, and retina. They are made of bluish, "smoked," or almost black coloured glass, and are of very various shapes, according to the amount of obscurity necessary.

Prisms.—Prisms are of great value in cases of double vision due to a slight tendency to squinting, caused by weakness or over-action of the muscular apparatus of the eyeball. Prisms deflect rays of light towards their bases. Hence, if a prism is placed in front of the eye with its base towards the nose, a ray of light falling upon it will be bent inwards, and seem to come from a point farther out from the axis of vision. Conversely, if the base of the prism is turned towards the temple, the ray of light will seem to come from a point nearer the axis, and will induce the eye to turn inwards, to converge towards its fellow. In cases of myopia or short-sight owing to weakness of the internal recti muscles, the eyes in looking at a near object, instead of converging, tend to turn outwards, and so double vision results. If a suitable prism is placed in front of the eyes the double vision may be prevented. These prisms may be combined with concave lenses, which correct the myopia, or, since a concave lens may be considered as composed of two prisms united at their apices, the same effect may be obtained by making the distance between the centres of the concave lenses greater than that between the centres of the pupils. Again, to obviate the necessity for excessive convergence of the eyes so common in hypermetropia, the centre of the pupil should be placed outside the centre of the corrective convex lenses; these will then act as prisms with their bases inwards. Where, on the other hand, there is no tendency to squinting, care must be taken in selecting spectacles that the distances between the centres of the glasses and the centres of the pupils are quite equal, otherwise squinting, or at any rate great fatigue, of the eyes may be induced.

Spherical Lenses.—Biconcave, biconvex and concavo-convex (meniscus) lenses are employed in ophthalmic practice in the treatment of errors of refraction. Until recently these spherical lenses were numbered in terms of their focal length, the inch being used as the unit. Owing principally to differences in the length of the inch in various countries this method had great inconveniences, and now the unit is the refractive power of a lens whose focal length is one metre. This unit is called a "dioptric" (usually written "D"). A lens of twice its strength has a refractive power of 2 D, and a focal length of half a metre, and so on.

Concave Lenses are used in the treatment of myopia or short-sight. In this condition the eye is elongated from before backwards, so that the retina lies behind the principal focus. All objects, therefore, which lie beyond a certain point (the conjugate focus of the dioptric system of the eye, the far point) are indistinctly seen; rays from them have not the necessary divergence to be focused in the retina, but may obtain it by the interposition of suitable concave lenses. Concave lenses should never be used for work within the far point; but they may be used in all cases to improve distant vision, and in very short-sighted persons to remove the far point so as to enable fine work such as sewing or reading to be done at a convenient distance. The weakest pair of concave lenses with which one can read clearly test types at a distance of 18 ft. is the measure of the amount of myopia, and this fully correcting glass may be worn in the slighter forms of short-sight. In higher degrees, where full correction might increase the myopia by inducing a strain of the accommodation, somewhat weaker glasses should be used for near work. In the highest degrees the complete correction may be employed, but lorgnettes are generally preferred, as they can be removed when the eyes become fatigued. It must be remembered that

short-sight tends to increase during the early, especially the school, years of life, and that hygienic treatment, good light, good type, and avoidance of stooping are important for its prevention.

Convex Lenses.—In hypermetropia the retina is in front of the principal focus of the eye. Hence in its condition of repose such an eye cannot distinctly see parallel rays from a distance and, still less, divergent rays from a near object. The defect may be overcome more or less completely by the use of the accommodation. In the slighter forms no inconvenience may result; but in higher degrees prolonged work is apt to give rise to aching and watering of the eyes, headache, inability to read or sew for any length of time, and even to double vision and internal strabismus. Such cases should be treated with convex lenses, which should be theoretically of such a strength as to fully correct the hypermetropia. Practically it is found that a certain amount of hypermetropia remains latent, owing to spasm of the accommodation, which relaxes only gradually. At first glasses may be given of such a strength as to relieve the troublesome symptoms; and the strength may be gradually increased till the total hypermetropia is corrected. Young adults with slighter forms of hypermetropia need glasses only for near work; elderly people should have one pair of weak glasses for distant and another stronger pair for near vision. These may be conveniently combined, as in Franklin glasses, where the upper half of the spectacle frame contains a weak lens, and the lower half, through which the eye looks when reading, a stronger one.

Anisometropia.—It is difficult to lay down rules for the treatment of cases where the refraction of the two eyes is unequal. If only one eye is used, its anomaly should be alone corrected; where both are used and nearly of equal strength, correction of each often gives satisfactory results.

Presbyopia.—When distant vision remains unaltered, but, owing to gradual failure of the accommodative apparatus of the eye clear vision within 8 in. becomes impossible, convex lenses should be used for reading of such a strength as to enable the eye to see clearly about 8 in. distance. Presbyopia is arbitrarily said to commence at the age of forty, because it is then that the need of spectacles for reading is generally felt; but it appears later in myopia and earlier in hypermetropia. It advances with years, requiring from time to time spectacles of increasing strength.

Cylindrical Lenses.—In astigmatism, owing to differences in the refractive power of the various meridians of the eye, great defect of sight, frequently accompanied by severe headache, occurs. This condition may be cured completely, or greatly improved, by the use of lenses whose surfaces are segments of cylinders. They may be used either alone or in combination with spherical lenses. The correction of astigmatism is in many cases a matter of considerable difficulty, but the results to vision almost always reward the trouble.

Convex spectacles were invented (see LIGHT) towards the end of the 13th century, perhaps by Roger Bacon. Concave glasses were introduced soon afterwards. Sir G. B. Airy, the astronomer, about 1827, corrected his own astigmatism by means of a cylindrical lens. Periscopic glasses were introduced by Dr W. H. Wollaston.

SPECTROHELIOGRAPH, an instrument for photographing the sun with monochromatic light. In its simplest form it consists of a direct-vision spectroscopy, having an adjustable slit (called "camera slit"), instead of an eyepiece, in the focal plane of the observing telescope. This slit is set in such a position as to transmit a single line of the spectrum, e.g. the K line of calcium. Suppose a fixed image of the sun to be formed on the collimator slit of this spectroscopy, and a photographic plate, with its plane parallel to the plane of the solar image, to be mounted almost in contact with the camera slit. The spectroscopy is then moved parallel to itself, admitting to the collimator slit light from all parts of the sun's disk. Thus a monochromatic image of the sun, formed of a great number of successive images of the spectral line employed, will be built up on the plate. As the only light permitted to reach the plate is that of the calcium

line, the resulting image will represent the distribution of calcium vapour in the sun's atmosphere. The calcium clouds or *floculi* thus recorded are invisible to the eye, and are not shown on direct solar photographs taken in the ordinary way.

The calcium *floculi*, on account of the brilliant reversals of the H and K lines to which they give rise, and the protection to the plate afforded by the diffuse dark bands in which these bright lines occur, are easily photographed with a spectroheliograph of low dispersion. In the case of narrower lines, however, higher dispersion is required to prevent the light of the continuous spectrum on either side of the dark line from blotting out the monochromatic image. A spectroheliograph which gives excellent results with the lines of calcium, hydrogen and iron is shown in the figure. This instrument, used since 1905 in conjunction with the Snow (horizontal) telescope of the Mount Wilson Solar Observatory, was constructed in the observatory instrument shop in Pasadena.

It consists of a heavy cast-iron platform (*a*) mounted on four steel balls (*b*) which run in V guides of hardened steel. Most of the weight of the instrument is floated on mercury contained in three troughs (*c, c, c*) which form part of the cast-iron base. The platform carries the two slits, the collimator and camera objectives and the prism-train. An image of the sun, about 6.7 in. in diameter, is formed by the Snow telescope on the collimator slit (*d*). This slit is long enough ($8\frac{1}{2}$ in.) to extend entirely across the solar image and across such prominences of ordinary height as may happen to lie at the extremities of a vertical diameter. After passing through the slit the diverging rays fall upon the 8 in. collimator objective (*e*), which is constructed in the manner of a portrait lens in order to give a sharp field of sufficient diameter to include the entire solar image. In the Snow telescope the ratio of aperture to focal length is 1 : 30. Hence light from any point on the slit will fill a circle about 2 in. in diameter on the collimator objective, as its focal length is 60 in. Since the diameter of the solar image is 6.7 in. there is a slight, but inappreciable loss of light from points in the image at the extremities of a vertical diameter.

The rays, rendered parallel by the collimator objective, meet a plane mirror (*f*) of silvered glass, which reflects them to the prisms (*g, g'*). These are of dense flint-glass (Schott 0.102), and each has a refracting angle of $63^{\circ} 29'$. Their width and height are sufficient to transmit (at the position of minimum deviation) the entire beam received from the collimator. After being deviated 180° from the original direction, the dispersed rays fall on the camera objective (*h*), which is exactly similar to the collimator objective. This forms an image of the solar spectrum in its focal plane on the camera slit (*i*). Beyond the camera slit, and almost in contact with it, the photographic plate-carrier (*j*) is mounted on a fixed support. In order to bring a spectral line upon the camera slit, the slit is widely opened and the plane mirror (*f*) rotated until the line is seen. A cross-hair, in the focal plane of an eyepiece, is then moved horizontally until it coincides with the line in question. The slit is narrowed down to the desired width, and moved as a whole by a micrometer screw, until it coincides with the cross-hair. The eyepiece is removed and the photographic plate (*k*) placed in position. An electric motor, belted to a screw (*l* or *l'*) connected with the spectroheliograph, is then started.¹ The screw moves the spectroheliograph at a perfectly uniform rate across the fixed solar image. Thus a monochromatic image of the sun is built up on the fixed photographic plate.

The spectroheliograph, originally designed for photographing the solar prominences, disclosed in its first application at the Kenwood Observatory (Chicago, 1892) a new and unexplored region of the sun's atmosphere. Photographs of the solar disk, taken with the H or K line, show extensive luminous clouds (*floculi*) of calcium vapour, vastly greater in area than the sun-spots. By setting the camera slit so as to admit to the photographic plate the light of the denser calcium vapour, which lies at low levels, or that of the rarer vapour at high levels, the phenomena of various superposed regions of the atmosphere can be recorded. The lower and denser vapour appears as bright clouds, but the cooler vapour, at higher levels, absorbs the light from below and thus gives rise to dark clouds.

The first photographs of the sun in hydrogen light were made with the spectroheliograph in 1903. These reveal dark hydrogen *floculi*, which appear to lie at a level above that of the bright calcium *floculi*. They also show less extensive bright *floculi*, usually in the immediate neighbourhood of sunspots, and frequently eruptive in character. These rise

¹Two screws, of different pitch, are provided, to give different speeds.

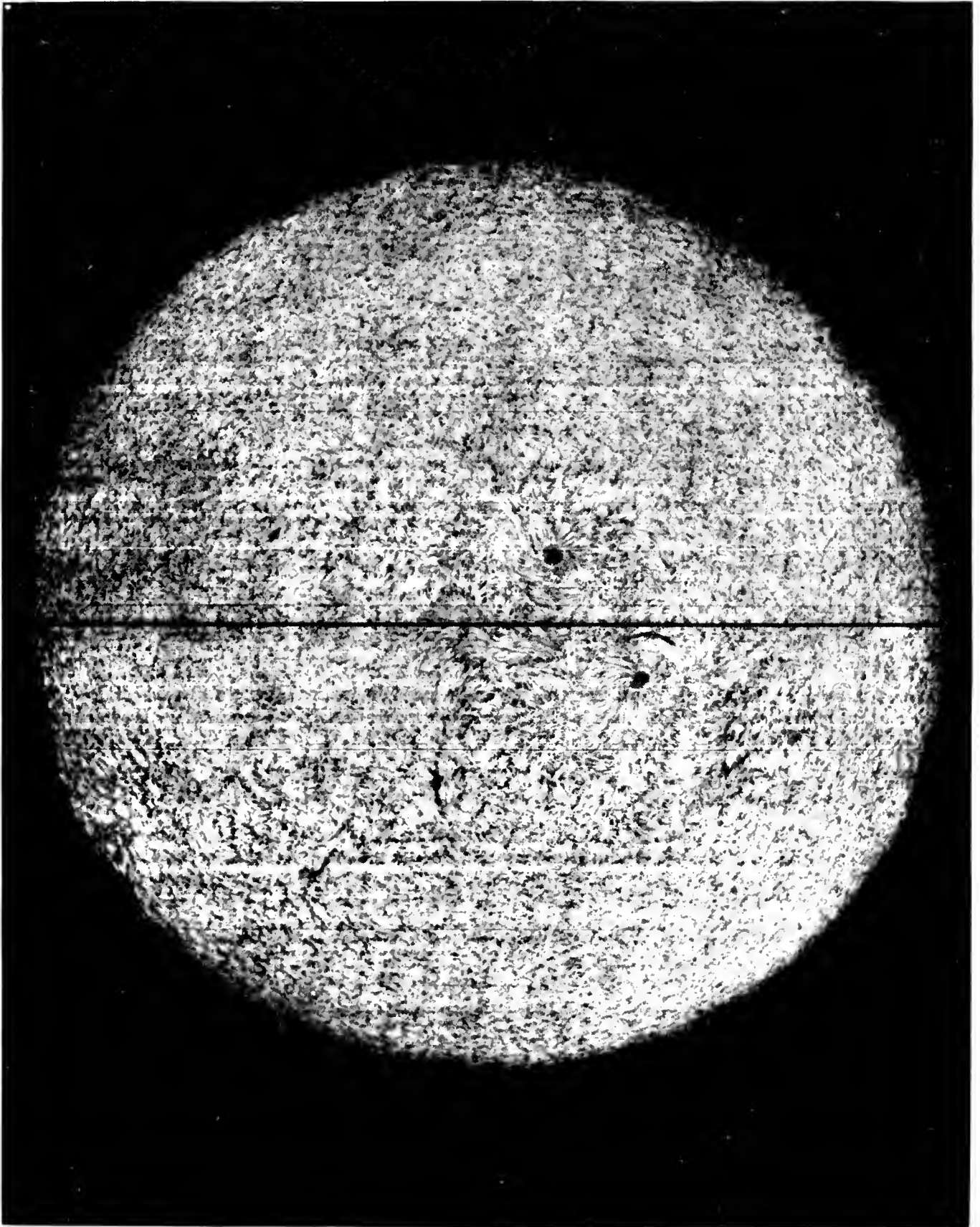

(By permission of the Carnegie Institution of Washington.)

THE SUN, 7TH OCTOBER 1908. Showing right and left-hand Sun-spot vortices.

from a low level, and sometimes reach considerable elevations in the form of eruptive prominences.

In such an exploration of the sun's atmosphere it might be anticipated that definite currents, or some evidences of atmospheric circulation analogous to those familiar in terrestrial meteorology, would be discovered. Neither the forms nor the motions of the calcium flocculi revealed the existence of such

SPECTROSCOPY (from Lat. *spectrum*, an appearance, and Gr. *σκοπεῖν*, to see), that branch of physical science which has for its province the investigation of spectra, which may, for our present purpose, be regarded as the product of the resolution of composite luminous radiations into more homogeneous components. The instruments which effect such a resolution are called spectroscopes.

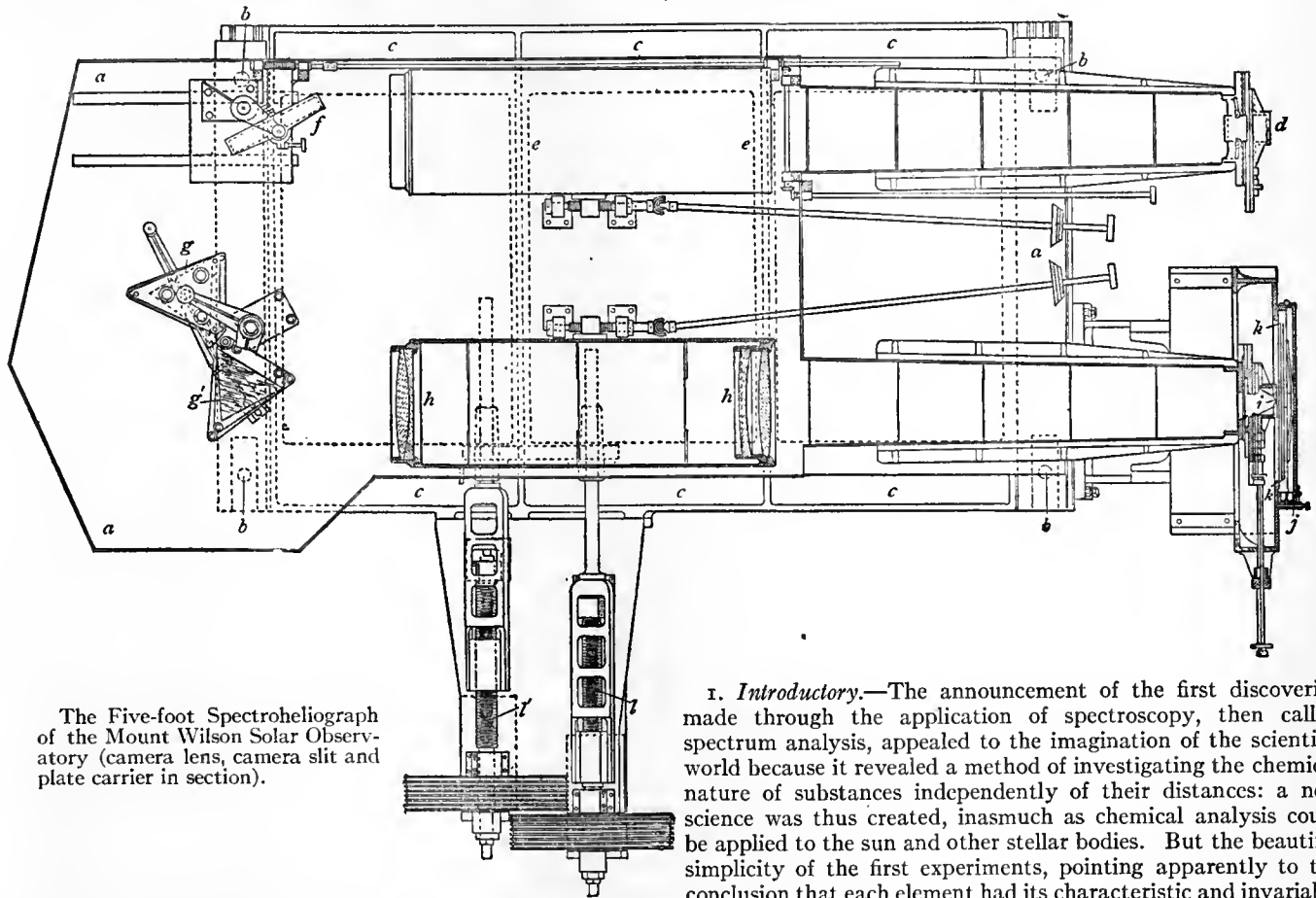

The Five-foot Spectroheliograph of the Mount Wilson Solar Observatory (camera lens, camera slit and plate carrier in section).

currents, but in the higher region shown by the hydrogen photographs the distribution of the dark flocculi suggested the operation of definite forces, though their nature remained obscure until the spring of 1908. At that time monochromatic photographs of the sun were first made on Mount Wilson with the red ($H\alpha$) line of hydrogen, previous hydrogen photographs having been taken with $H\beta$, $H\gamma$ or $H\delta$ in the blue or violet. On account of the relatively great strength of $H\alpha$ at a considerable distance from the photosphere, the new photographs recorded flocculi at high levels previously unexplored. The forms of these flocculi show that all sun-spots are vortical in nature, and are probably analogous to terrestrial cyclones or tornadoes. Most of the solar vortices indicate clockwise rotation in the southern hemisphere and counter-clockwise rotation in the northern, as in the case of terrestrial cyclones. But frequent exceptions have been observed in which the direction of rotation is reversed. The study of these vortices has led to the discovery of a magnetic field in sun-spots, apparently caused by electric convection in the vortices.

It is evident that by the use of a spectroheliograph of sufficiently high dispersion, photographs may be taken of vapours in the sun represented by lines narrower than those of calcium and hydrogen. Such work has been in progress both at Mount Wilson and at Meudon, and the erection of a spectroheliograph of 75 ft. focal length on Mount Wilson was at the end of 1908 contemplated for an early date.

Descriptions of spectroheliographs by Hale, Deslandres, Newall and others, may be found in various papers in *Astronomy and Astrophysics*, *Astrophysical Journal*, *Comptes rendus*, *Bulletin astronomique*, and other periodicals. (G. E. H.)

1. *Introductory.*—The announcement of the first discoveries made through the application of spectroscopy, then called spectrum analysis, appealed to the imagination of the scientific world because it revealed a method of investigating the chemical nature of substances independently of their distances: a new science was thus created, inasmuch as chemical analysis could be applied to the sun and other stellar bodies. But the beautiful simplicity of the first experiments, pointing apparently to the conclusion that each element had its characteristic and invariable spectrum whether in the free state or when combined with other bodies, was soon found to be affected by complications which all the subsequent years of study have not completely resolved. Compound bodies, we now know, have their own spectra, and only when dissociation occurs can the compound show the rays characteristic of the element: this perhaps was to be expected, but it came as a surprise and was not readily believed, that elements, as a rule, possess more than one spectrum according to the physical conditions under which they become luminous. Spectrum analysis thus passed quickly out of the stage in which its main purpose was "analysis" and became our most delicate and powerful method of investigating molecular properties; the old name being no longer appropriate, we now speak of the science of "Spectroscopy."¹ Within the limit of this article it is not possible to give a complete account of this most intricate branch of physics; the writer therefore confines himself to a summary of the problems which now engage scientific attention, referring the reader for details to H. Kayser's excellent and complete *Handbuch der Spectroscopie*.

2. *Instrumental.*—The spectroscope is an instrument which allows us to examine the vibrations sent out by a radiating source; it separates the component parts if they are homogeneous, *i.e.* of definite periodicity, and then also gives us the distribution of intensity along the homogeneous constituents. This resolution into simple periodic waves is arbitrary in the same sense as is the decomposition of forces along assumed

¹ The present writer believes that he was the first to introduce the word "Spectroscopy" in a lecture delivered at the Royal Institution in 1882 (*Proceedings*, vol. ix.).

axes; but, in the same way also the results are correct if the resolution is treated as an analytical device and in the final result account is taken of all the overlapping components. Spectroscopes generally consist of three parts: (1) the collimator; (2) the analysing appliance, (3) the telescope. The slit of the collimator confines the light to a nearly linear source, the beam diverging from each point of the source being subsequently made parallel by means of a lens. The parallelism, which is required to avoid aberrations, otherwise introduced by the prism or grating, may often be omitted in instruments of small power. The lens may then be also dispensed with, and the whole collimator becomes unnecessary if the luminous source is narrow and at a great distance, as for instance in the case of the crescent of the sun near the second and third contact of a total solar eclipse. The telescope serves to examine the image of the slit and to measure the angular separation of the different slit images; when photographic methods are employed the telescope is replaced by a camera.

The analysing appliance constitutes the main feature of a spectroscope. It may consist of one of the following:—

a. A prism or a train of prisms. These are employed in instruments of small power, especially when luminosity is a consideration; but their advantage in this respect is to a great extent lost, when, in order to secure increased resolving power, the size of the prisms, or their number, is unduly increased.

b. A grating. Through H. A. Rowland's efforts the construction of gratings has been improved to such an extent that their use is becoming universal whenever great power or accuracy is required. By introducing the concave grating which (see DIFFRACTION OF LIGHT, § 8) allows us to dispense with all lenses, Rowland produced a revolution in spectroscopic measurement. At present we have still to content ourselves with a much diminished intensity of light when working with gratings, but there is some hope that the efforts to concentrate the light into one spectrum will soon be successful.

c. An échelon grating. Imagine a horizontal section of a beam of light, and this section divided into a number of equal parts. Let somehow or other retardations be introduced so that the optical length of the successive parts increases by the same quantity $n\lambda$, n being some number and λ the wave-length. If on emergence the different portions be brought together at the focus it is obvious that the optical action must be in every respect similar to that of a grating when the n th order of spectrum is considered. A. Michelson produced the successive retardations by inserting step-by-step plates of glass of equal thicknesses of glass equal to $n\lambda$, $2n\lambda$, $3n\lambda$, . . . $N\lambda$. The optical effect as regards resolving power is the same as with a grating of N lines in the n th order, but, nearly all the light not absorbed by the glass may be concentrated in one or two orders.¹

d. Some other appliance in which interference with long difference of path is made use of, such as the interferometer of Fabry and Perot, or Lummer's plate (see INTERFERENCE OF LIGHT).

The échelon and interferometer serve only a limited purpose, but must be called into action when the detailed structure of lines is to be examined. For the study of Zeeman effects (see MAGNETO-OPTICS) the échelon seems specially adapted, while the great pliability of Fabry and Perot's methods, allowing a clear interpretation of results, is likely to secure them permanently an established place in measurements of precision.

The power of a spectroscope to perform its main function, which is to separate vibrations of different but closely adjacent frequencies, is called its "resolving power." The limitation of power is introduced as in all optical instruments, by the finiteness of the length of a wave of light which causes the image of an indefinitely narrow slit to spread out over a finite width in the focal plane of the observing telescope. The so-called "diffraction" image of a homogeneously illuminated slit shows a central band limited on either side by a line along which the

¹ Michelson, *Astrophys. Journ.* (1898), 8, p. 36; A. Schuster, *Theory of Optics*, p. 115.

intensity is zero, and this band is accompanied by a number of fainter images corresponding to the diffraction of a star image in a telescope. Lord Rayleigh, to whom we owe the first general discussion of the theory of the spectroscope, found by observation that if two spectroscopic lines of frequencies n_1 and n_2 are observed in an instrument, they are just seen as two separate lines when the centre of the central diffraction band of one coincides with the first minimum intensity of the other. In that case the image of the double line shows a diminution of intensity along the centre, just sufficient to give a clear impression that we are not dealing with a single line, and the intensity at the minimum is 0.81 of that at the point of maximum illumination. We may say therefore that if the difference between the frequencies n_1 and n_2 of the two waves is such that in the combined image of the slit the intensity at the minimum between the two maxima falls to 0.81, the lines are just resolved and $n_1/(n_1-n_2)$ may then be called the resolving power. There is something arbitrary in this definition, but as the practical importance of the question lies in the comparison between instruments of different types, the exact standard adopted is of minor importance, the chief consideration being simplicity of application. Lord Rayleigh's expression for the resolving power of different instruments is based on the assumption that the geometrical image of the slit is narrow compared with the width of the diffraction image. This condition is necessary if the full power of the instrument is to be called into action. Unfortunately considerations of luminosity compel the observer often to widen the slit much beyond the range within which the theoretical value of resolving power holds in practice. The extension of the investigation to wide slits was first made by the present writer in the article "Spectroscopy" in the 9th edition of the *Encyclopaedia Britannica*. Reconsideration of the subject led him afterwards to modify his views to some extent, and he has since more fully discussed the question.² Basing the investigation on the same criterion of resolution as in the case of narrow slits, we postulate for both narrow and wide slits that two lines are resolved when the intensity of the combined image falls to a value of 0.810 in the centre between the lines, the intensity at the maxima being unity. We must now however introduce a new criterion the "purity" and distinguish it from the resolving power: the purity is defined by $n_1/(n_1-n_2)$, where n_1 and n_2 are the frequencies of two lines such that they would just be resolved with the width of slit used. With an indefinitely narrow slit the purity is equal to the resolving power. As purity and resolving power are essentially positive quantities, n_1 in the above expression must be the greater of the two frequencies. With wide slits the difference n_1-n_2 depends on their width. If we write $P=pR$ where P denotes the purity and R the resolving power, we may call p the "purity-factor." In the paper quoted the numerical values of p are given for different widths of slit, and a table shows to what extent the loss of purity due to a widening of the slit is accompanied by a gain in luminosity. The general results may be summarized as follows: if the width of the slit is equal to $f\lambda/4D$ (where λ is the wave-length concerned, D the diameter of the collimator lens, and f its focal length) practically full resolving power is obtained and a further narrowing of the slit would lead to loss of light without corresponding gain. We call a slit of this width a "normal slit." With a slit width equal to twice the normal one we lose 6% of resolution, but obtain twice the intensity of light. With a slit equal in width to eight times the normal one the purity is reduced to 0.45R, so that we lose rather more than half the resolving power and increase the light 3.7 times. If we widen the slit still further rapid loss of purity results, with very little gain in light, the maximum luminosity obtainable with an indefinitely wide slit being four times that obtained with the normal one. It follows that for observations in which light is a consideration spectroscopes should be used which give about twice the resolving power of that actually required; we may then use a slit having a width of nearly eight times that of the normal one.

² *Astrophys. Journ.* (1905), 21, p. 197.

Theoretical resolving power can only be obtained when the whole collimator is filled with light and further (as pointed out by Lord Rayleigh in the course of discussion during a meeting of the "Optical Convention" in London, 1905) each portion of the collimator must be illuminated by each portion of the luminous source. These conditions may be generally satisfied by projecting the image of the source on the slit with a lens of sufficient aperture. When the slit is narrow light is lost through diffraction unless the angular aperture of this condensing lens, as viewed from the slit, is considerably greater than that of the collimator lens.

When spectroscopes are used for stellar purposes further considerations have to be taken account of in their construction; and these are discussed in a paper by H. F. Newall.¹

3. *Spectroscopic Measurements and Standards of Wave-Length.*—All spectroscopic measurement should be reduced to wave-lengths or wave-frequencies, by a process of interpolation between lines the wave-lengths of which are known with sufficient accuracy. The most convenient unit is that adopted by the International Union of Solar Research and is called an Ångström (Å); and is equal to 10^{-8} cms. A. Perot and C. Fabry, employing their interferometer methods, have compared the wave-length of the red cadmium line with the standard metre in Paris and found it to be equal to 6438.4696 Å, the observations being taken in dry air at 18° C and at a pressure of 76 cms. ($g = 980.665$). This number agrees singularly well with that determined in 1893 by Michelson, who found for the same line 6438.4700 . Perot's number is now definitely adopted to define the Ångström, and need never be altered, for should at some future time further researches reveal a minute error, it will be only necessary to change slightly the temperature or pressure of the air in which the wave-length is measured. A number of secondary standards separated by about 50 Å, and tertiary standards at intervals of from 5 to 10 Å have also been determined. By means of these, spectroscopists are enabled to measure by interpolation the wave-length of any line they may wish to determine. Interpolation is easy in the case of all observations taken with a grating. In the case of a prism some caution is necessary unless the standards used are very close together. The most convenient and accurate formula of interpolation seems to be that discovered by J. F. Hartmann. If D is the measured deviation of a ray, and D_0 , λ_0 , c and α are four constants, the equation

$$\lambda = \lambda_0 + \frac{c}{(D - D_0)^{1/\alpha}}$$

seems to represent the connexion between deviation and wave-length with considerable accuracy for prisms constructed with the ordinary media.

The constant α has the same value 1.2 for crown and flint glass, so that there are only three disposable constants left. In many cases it is sufficient to substitute unity for α and write

$$\lambda = \lambda_0 + \frac{c}{D - D_0}$$

which gives a convenient formula, which in this form was first used by A. Cornu. If within the range 5100 – 3700 Å, the constants are determined once for all, the formula seems capable of giving by interpolation results accurate to 0.2 Å, but as a rule the range to which the formula is applied will be much less with a corresponding gain in the accuracy of the results.

Every observer should not only record the resolving power of the instrument he uses, but also the purity-factor as defined above. The resolving power in the case of gratings is simply mn , where m is the order of spectrum used, and n the total number of lines ruled on the grating. In the case of prisms the resolving power is $-t (d\mu/d\lambda)$, where t is the effective thickness of the medium traversed by the ray. If t_2 and t_1 are thicknesses traversed by the extreme rays, $t = t_2 - t_1$, and if, as is usually the case, the prism is filled right up to its refraction cap, $t_1 = 0$, and t becomes equal to the greatest thickness of the medium which is made use of. When compound prisms are used in which,

¹ *Monthly Notices R.A.S.* (1905), 65, p. 605.

for the purpose of obtaining smaller deviation, one part of the compound acts in opposition to the other, the resolving power of the opposing portion must be deducted in calculating the power of the whole. Opticians should supply sufficient information of the dispersive properties of their materials to allow $d\mu/d\lambda$ to be calculated easily for different parts of the spectrum.

The determination of the purity-factor requires the measurement of the width of the slit. This is best obtained by optical means. The collimator of a spectroscope should be detached, or moved so as to admit of the introduction of an auxiliary slit at a distance from the collimator lens equal to its focal length. If a source of light be placed behind the auxiliary slit a parallel beam of light will pass within the collimator and fall on the slit the width of which is to be measured. With fairly homogeneous light the diffraction pattern may be observed at a distance, varying with the width of the slit from about the length of the collimator to one quarter of that length. From the measured distances of the diffraction bands the width of the slit may be easily deduced.

4. *Methods of Observation and Range of Wave-Lengths.*—Visual observation is limited to the range of frequencies to which our eyes are sensitive. Defining oscillation as is usual in spectroscopic measurement by wave-length, the visible spectrum is found to extend from about 7700 to 3900 Å. In importance next to visual observation, and in the opinion of some, surpassing it, is the photographic method. We are enabled by means of it to extend materially the range of our observation, especially if the ordinary kinds of glass, which strongly absorb ultra-violet light, are avoided, and, when necessary, replaced by quartz. It is in this manner easy to reach a wave-length of 3000 Å, and, with certain precautions, 1800 Å. At that point, however, quartz and even atmospheric air become strongly absorbent and the expensive fluorspar becomes the only medium that can be used. Hydrogen still remains transparent. The beautiful researches of V. Schumann² have shown, however, that with the help of spectroscopes void of air and specially prepared photographic plates, spectra can be registered as far down as 1200 Å. Lyman more recently has been able to obtain photographs as far down as 1030 Å with the help of a concave grating placed in vacuo.³ Although the vibrations in the infra-red have a considerably greater intensity, they are more difficult to register than those in the ultra-violet. Photographic methods have been employed successfully by Sir W. Abney as far as $20,000$ Å, but long exposures are necessary. Bolometric methods may be used with facility and advantage in the investigation of the distribution of intensities in continuous or semi-continuous spectra but difficulties are met with in the case of line spectra. Good results in this respect have been obtained by B. W. Snow⁴ and by E. P. Lewis,⁵ lines as far as $11,500$ having been measured by the latter. More recently F. Paschen⁶ has further extended the method and added a number of infra-red lines to the spectra of helium, argon, oxygen and other elements. In the case of helium one line was found with a wave-length of $20,582$ Å. C. V. Boys' microradiometer has occasionally been made use of, and the extreme sensitiveness of the Crookes' radiometer has also given excellent results in the hands of H. Rubens and E. F. Nichols. In the opinion of the writer the latter instrument will ultimately replace the bolometer, its only disadvantage being that the radiations have to traverse the side of a vessel, and are therefore subject to absorption. In order to record line spectra it is by no means necessary that the receiving instrument (bolometer or radiometer) should be linear in shape, for the separation of adjacent lines may be obtained if the linear receiver be replaced by a narrow slit in a screen placed at the focus of the condensing lens. The sensitive vane or strip may then be placed behind the slit; its width will not affect the resolving power though there may be a diminution of sensitiveness. The longest waves

² *Wied. Annalen* (1901), 5, p. 349.

³ *Astrophys. Journ.* (1906), 23, p. 181.

⁴ *Wied. Annalen* (1892), 47, p. 208.

⁵ *Astrophys. Journ.* (1895), 2, p. 1.

⁶ *Drude Annalen* (1908), 27, p. 537 and (1909), 29.

observed up to the present are those recorded by H. Rubens and E. Aschkinass¹ (0.061 cms. or 610,000 Å).

5. *Methods of Rendering Gases Luminous.*—The extreme flexibility of the phenomena shown by radiating gases renders it a matter of great importance to examine them under all possible conditions of luminosity. Gases, like atmospheric air, hydrogen or carbon dioxide do not become luminous if they are placed in tubes, even when heated up far beyond white heat as in the electric furnace. This need not necessarily be interpreted as indicating the impossibility of rendering gases luminous by temperature only, for the transparency of the gas for luminous radiations may be such that the emission is too weak to be detected. When there is appreciable absorption as in the case of the vapours of chlorine, bromine, iodine, sulphur, selenium and arsenic, luminosity begins at a red heat. Thus G. Salet² observed that iodine gives a spectrum of bright bands when in contact with a platinum spiral made white hot by an electric current, and J. Evershed³ has shown that in this and other cases the temperature at which emission becomes appreciable is about 700°. It is only recently that owing to the introduction of carbon tubes heated electrically the excitement of the luminous vibrations of molecules by temperature alone has become an effective method for the study of their spectra even in the case of metals. Hitherto we were entirely and still are generally confined to electrical excitation or to chemical action as in the case of flames.

In the ordinary laboratory the Bunsen flame has become universal, and a number of substances, such as the salts of the alkalis and alkaline earths, show characteristic spectra when suitably placed in it. More information may be gained with the help of the oxyhydrogen flame, which with its higher temperature has not been used as frequently as it might have been, but W. N. Hartley has employed it with great success, and in cyanite (a silicate of aluminium) has found a material which is infusible at the temperature of this flame, and is therefore suitable to hold the substance which it is desired to examine. An interesting and instructive manner of introducing salts into flames was discovered by A. Gouy, who forced the air before it entered the Bunsen burner, through a spray produce containing a salt in solution. By this method even such metals as iron and copper may be made to show some of their characteristic lines in the Bunsen burner. The spectra produced under these circumstances have been studied in detail by C. de Wateville.⁴

Of more frequent use have been electric methods, owing to the greater intensity of the radiations which they yield. Especially when large gratings are employed do we find that the electric arc alone seems sufficient to give vibrations of the requisite power. The metals may be introduced into the arc in various ways, and in some cases where they can be obtained in sufficient quantity the metallic electrodes may be used in the place of carbon poles.

The usual method of obtaining spectra by the discharges from a Ruhmkorff coil or Wimshurst machine needs no description. The effects may be varied by altering the capacity and self-induction of the circuit which contains the spark gap. The insertion of self-induction has the advantage of avoiding the lines due to the gas through which the spark is taken, but it introduces other changes in the nature of the spark, so that the results obtained with and without self-induction are not directly comparable. Count Gramont⁵ has been able to obtain spectroscopic evidence of the metalloids in a mineral by employing powerful condensers and heating the electrodes in an oxyhydrogen flame when these (as is often the case) are not sufficiently conducting.

When the substance to be examined spectroscopically is in solution the spark may be taken from the solution, which must then be used as kathode of air. The condenser is in this case

¹ *Wied. Annalen* (1898), 65, p. 241.

² *Ann. Chim. Phys.* (1873), 28.

³ *Phil. Mag.* (1895), 39, p. 460.

⁴ *Phil. Trans.* (1904), 204, A, p. 139.

⁵ *Comptes rendus*, vols. 121, 122, 124.

not necessary, in fact better results are obtained without it. Lecoq de Boisbaudran has applied this method with considerable success, and it is to be recommended whenever only small electric power is at the disposal of the observer. To diminish the resistance the current should pass through as small a layer of liquid as possible. It is convenient to place the liquid in a short tube, a platinum wire sealed in at the bottom to convey the current reaching to the level of the open end. If a thick-walled capillary tube is passed over the platinum tube and its length so adjusted that the liquid rises in it by capillary action just above the level of the tube, the spectrum may be examined directly, and the loss of light due to the passage through the partially wetted surface of the walls of the tube is avoided.

For the investigation of the spectra of gases at reduced pressures the so-called Plücker tubes (more generally but incorrectly called Geissler tubes) are in common use. When the pressure becomes very low, inconvenience arises owing to the difficulty of establishing the discharge. In that case the method introduced by J. J. Thomson might with advantage be more frequently employed. Thomson⁶ places spherical bulbs inside thick spiral conductors through which the oscillating discharge of a powerful battery is led. The rapid variation in the intensity of the magnetic field causes a brilliant electrodeless discharge which is seen in the form of a ring passing near the inner walls of the bulb when the pressure is properly adjusted. A variety of methods to render gases luminous should be at the command of the investigator, for nearly all show some distinctive peculiarity and any new modification generally results in fresh facts being brought to light. Thus E. Goldstein⁷ was able to show that an increase in the current density is capable of destroying the well-known spectra of the alkali metals, replacing them by quite a new set of lines.

6. *Theory of Radiation.*—The general recognition of spectrum analysis as a method of physical and chemical research occurred simultaneously with the theoretical foundation of the connexion between radiation and absorption. Though the experimental and theoretical developments were not necessarily dependent on each other, and by far the larger proportion of the subject which we now term "Spectroscopy" could stand irrespective of Gustav Kirchhoff's thermodynamical investigations, there is no doubt that the latter was, historically speaking, the immediate cause of the feeling of confidence with which the new branch of science was received, for nothing impresses the scientific world more strongly than just that little touch of mystery which attaches to a mathematical investigation which can only be understood by the few, and is taken on trust by the many, provided that the author is a man who commands general confidence. While Balfour Stewart's work on the theory of exchanges was too easily understood and therefore too easily ignored, the weak points in Kirchhoff's developments are only now beginning to be perceived. The investigations both of Balfour Stewart and of Kirchhoff are based on the idea of an enclosure at uniform temperature and the general results of the reasoning centre in the conclusion that the introduction of any body at the same temperature as the enclosure can make no difference to the streams of radiant energy which we imagine to traverse the enclosure. This result, which, accepting the possibility of having an absolutely opaque enclosure of uniform temperature, was clearly proved by Balfour Stewart for the total radiation, was further extended by Kirchhoff, who applied it (though not with mathematical rigidity as is sometimes supposed) to the separate wave-lengths. All Kirchhoff's further conclusions are based on the assumption that the radiation transmitted through a partially transparent body can be expressed in terms of two independent factors (1) an absorption of the incident radiation, and (2) the radiation of the absorbing medium, which takes place equally in all directions. It is assumed further that the absorption is proportional to the incident radiation and (at any rate approximately) independent of the temperature, while the radiation is assumed to be a function of the temperature

⁶ *Phil. Mag.* 32, pp. 321, 445.

⁷ *Vertr. d. phys. Ges.* (1904), 9, p. 321.

only and independent of the temperature of the enclosure. This division into absorption and radiation is to some extent artificial and will have to be revised when the phenomena of radiation are placed on a mechanical basis. For our present purpose it is only necessary to point out the difficulty involved in the assumption that the radiation of a body is independent of the temperature of the enclosure. The present writer drew attention to this difficulty as far back as 1881,¹ when he pointed out that the different intensities of different spectral lines need not involve the consequence that in an enclosure of uniform temperature the energy is unequally partitioned between the corresponding degrees of freedom. When the molecule is losing energy the intensity of each kind of radiation depends principally on the rapidity with which it can be renewed by molecular impacts. The unequal intensities observed indicate a difference in the effectiveness of the channels through which energy is lost, and this need not be connected with the ultimate state of equilibrium when the body is kept at a uniform temperature. For our immediate purpose these considerations are of importance inasmuch as they bear on the question how far the spectra emitted by gases are thermal effects only. We generally observe spectra under conditions in which dissipation of energy takes place, and it is not obvious that we possess a definition of temperature which is strictly applicable to these cases. When, for instance, we observe the relation of the gas contained in a Plücker tube through which an electric discharge is passing, there can be little doubt that the partition of energy is very different from what it would be in thermal equilibrium. In consequence the question as to the connexion of the spectrum with the temperature of the gas seems to the present writer to lose some of its force. We might define temperature in the case of a flame or vacuum tube by the temperature which a small totally reflecting body would tend to take up if placed at the spot, but this definition would fail in the case of a spark discharge. Adopting the definition we should have no difficulty in proving that in a vacuum tube gases may be luminous at very low temperatures, but we are doubtful whether such a conclusion is very helpful towards the elucidation of our problem. Radiation is a molecular process, and we can speak of the radiation of a molecule but not of its temperature. When we are trying to bring radiation into connexion with temperature, we must therefore take a sufficiently large group of molecules and compare their average energies with the average radiation. The question arises whether in a vacuum discharge, in which only a comparatively small proportion of the molecules are affected, we are to take the average radiation of the affected portion or include the whole lot of molecules, which at any moment are not concerned in the discharge at all. The two processes would lead to entirely different results. The problem, which, in the opinion of the present writer, is the one of interest and has more or less definitely been in the minds of those who have discussed the subject, is whether the type of wave sent out by a molecule only depends on the internal energy of that molecule, or on other considerations such as the mode of excitement. The average energy of a medium containing a mixture of dissimilar elements possesses in this respect only a very secondary interest.

We must now inquire a little more closely into the mechanical conception of radiation. According to present ideas, the wave originates in a disturbance of electrons within the molecules. The electrons responsible for the radiation are probably few and not directly involved in the structure of the atom, which according to the view at present in favour, is itself made up of electrons. As there is undoubtedly a connexion between thermal motion and radiation, the energy of these electrons within the atom must be supposed to increase with temperature. But we know also that in the complete radiation of a white body the radiative energy increases with the fourth power of the absolute temperature. Hence a part of what must be included in thermal energy is not simply proportional to temperature as is commonly assumed. The energy of radiation resides in the medium and not in the molecule. Even at the

¹ *Phil. Mag.* (1881), 12, p. 261.

highest temperatures at our command it is small compared with the energy of translatory motion, but as the temperature increases, it must ultimately gain the upper hand, and if there is anywhere such a temperature as that of several million degrees, the greater part of the total energy of a body will be outside the atom and molecular motion ultimately becomes negligible compared with it. But these speculations, interesting and important as they are, lead us away from our main subject.

Considering the great variety of spectra, which one and the same body may possess, the idea lies near that free electrons may temporarily attach themselves to a molecule or detach themselves from it, thereby altering the constitution of the vibrating system. This is most likely to occur in a discharge through a vacuum tube and it is just there that the greatest variety of spectra is observed.

It has been denied by some that pure thermal motion can ever give rise to line spectra, but that either chemical action or impact of electrons is necessary to excite the regular oscillations which give rise to line spectra. There is no doubt that the impact of electrons is likely to be effective in this respect, but it must be remembered that all bodies raised to a sufficient temperature are found to eject electrons, so that the presence of the free electrons is itself a consequence of temperature. The view that visible radiation must be excited by the impact of such an electron is therefore quite consistent with the view that there is no essential difference between the excitement due to chemical or electrical action and that resulting from a sufficient increase of temperature.

Chemical action has frequently been suggested as being a necessary factor in the luminosity of flame, not only in the sense that it causes a sufficient rise of temperature but as furnishing some special and peculiar though undefined stimulus. An important experiment by C. Günther² seems however to show that the radiation of metallic salts in a flame has an intensity equal to that belonging to it in virtue of its temperature.

If a short length of platinum wire be inserted vertically into a lighted Bunsen burner the luminous line may be used as a slit and viewed directly through a prism. When now a small bead of a salt of sodium or lithium is placed in the flame the spectrum of the white hot platinum is traversed by the dark absorption of the D lines. This is consistent with Kirchhoff's law and shows that the sodium in a flame possesses the same relative radiation and absorption as sodium vapour heated thermally to the temperature of the flames. According to independent experiments by Paschen the radiation of the D line sent out by the sodium flame of sufficient density is nearly equal to that of a black body at the same temperature.³ Other more recent experiments confirm the idea that the radiation of flames is mainly determined by their temperature.

The definition of temperature given above, though difficult in the case of a flame and perhaps still admissible in the case of an electric arc, becomes precarious when applied to the disruptive phenomena of a spark discharge. The only sense in which we might be justified in using the word temperature here is by taking account of the energy set free in each discharge and distributing it between the amount of matter to which the energy is supplied. With a guess at the specific heat we might then calculate the maximum temperature to which the substance might be raised, if there were no loss by radiation or otherwise. But the molecules affected by a spark discharge are not in any sense in equilibrium as regards their partition of energy and the word "temperature" cannot therefore be applied to them in the ordinary sense. We might probably with advantage find some definition of what may be called "radiation temperature" based on the relation between radiation and absorption in Kirchhoff's sense, but further information based on experimental investigation is required.

7. *Limits of Homogeneity and Structure of Lines.*—As a first approximation we may say that gases send out homogeneous

² *Wied. Ann.* (1877), 2, p. 477.

³ *Ibid.* (1894), 51, p. 40.

radiations. A homogeneous oscillation is one which for all time is described by a circular function such as $\sin(n\omega t + \alpha)$, t being the time and n and α constants. The qualification that the circular function must apply to all time is important, and unless it is recognized as a necessary condition of homogeneity, confusion in the more intricate problems of radiation becomes inevitable. Thus if a molecule were set into vibration at a specified time and oscillated according to the above equation during a finite period, it would not send out homogeneous vibrations. In interpreting the phenomena observed in a spectroscopy, it is necessary to remember that the instrument, as pointed out by Lord Rayleigh, is itself a producer of homogeneity within the limits defined by its resolving power. A spectroscopy may be compared to a mechanical harmonic analyser which when fed with an irregular function of one variable represented by a curve supplies us with the sine curves into which the original function may be resolved. This analogy is useful because the application of Fourier's analysis to the optical theory of spectroscopies has been doubted, and it may be urged in answer to the objections raised that the instrument acts in all respects like a mechanical analyser,¹ the applicability of which has never been called into question.

A limit to homogeneity of radiation is ultimately set by the so-called Doppler effect, which is the change of wave-length due to the translatory motion of the vibrating molecule from or towards the observer. If N be the frequency of a homogeneous vibration sent out by a molecule at rest, the apparent frequency will be $N(1 \pm v/V)$, where V is the velocity of light and v is the velocity of the line of sight, taken as positive if the distance from the observer increases. If all molecules moved with the velocity of mean square, the line would be drawn out into a band having on the frequency scale a width $2Nv/V$, where v is now the velocity of mean square. According to Maxwell's law, however, the number of molecules having a velocity in the line of sight lying between v and $v+dv$ is proportional to $e^{-\beta v^2} dv$, where β is equal to $3/2u^2$; for $v=u$, we have therefore the ratio in the number of molecules having velocity u to those having no velocity in the line of sight $e^{-\beta u^2} = e^{-\frac{3}{2}} = 0.22$. We may therefore still take $2Nu/V$ to be the width of the band if we define its edge to be the frequency at which its intensity has fallen to 22% of the central intensity. In the case of hydrogen rendered luminous in a vacuum tube we may put approximately u equal to 2000 metres per second, if the translatory motion of the luminous molecules is about the same as that at the ordinary temperature. In that case $\lambda u/V$ or the half width of the band measured in wave lengths would be $\frac{2}{3} \cdot 10^{-6} \lambda$, or, for the red line, the half width would be 0.044 \AA . Michelson, who has compared the theoretical widening with that found experimentally by means of his interferometer, had to use a somewhat more complicated expression for the comparison, as his visibility curve does not directly give intensities for particular frequencies but an integral depending on a range of frequency.² He finds a remarkable agreement between the theoretical and experimental values, which it would be important to confirm with the more suitable instruments which are now at our disposal, as we might in this way get an estimate of the energy of translatory motion of the luminous molecules. If the motion were that of a body at white heat, or say a temperature of 1000° , the velocity of mean square would be 3900 metres per second and the apparent width of the band would be doubled. Michelson's experiments therefore argue in favour of the view that the luminescence in a vacuum tube is similar to that produced by phosphorescence where the translatory energy does not correspond to the oscillatory energy—but further experiments are desirable. The experimental verification of the change of wave-length due to a source moving in the line of sight has been realized in the laboratory by A. Bépolsky and Prince Galitzin, who substituted for the source an image formed of a stationary object in a rapidly moving mirror.

¹ *Phil. Mag.* (1894), 37, p. 509.

² Cf. Rayleigh, *Phil. Mag.* (1899), 27, p. 298; Michelson, *Phil. Mag.* (1892), 34, p. 280.

The homogeneity of vibration may also be diminished by molecular impacts, but the number of shocks in a given time depends on pressure and we may therefore expect to diminish the width of a line by diminishing the pressure. It is not, however, obvious that the sudden change of direction in the translatory motion, which is commonly called a molecular shock, necessarily also affects the phase of vibration. Experiments which will be discussed in § 10 seem to show that there is a difference in this respect between the impacts of similar and those of dissimilar molecules. When the lines are obtained under circumstances which tend towards sharpness and homogeneity they are often found to possess complicated structures, single lines breaking up into two or more components of varying intensities. One of the most interesting examples is that furnished by the green mercury line, which when examined by a powerful échelon spectroscopy splits up into a number of constituents which have been examined by several investigators. Six companions to the main lines are found with comparative ease and certainty and these have been carefully measured by Prince Galitzin,³ H. Stansfield⁴ and L. Janicki.⁵ According to Stansfield there are three companion lines on either side of a central line, which consists of two lines of unequal brightness.

8. *Distribution of Frequencies in Line Spectra.*—It is natural to consider the frequencies of vibrations of radiating molecules as analogous to the different notes sent out by an acoustical vibrator. The efforts which were consequently made in the early days of spectroscopy to discover some numerical relationship between the different wave lengths of the lines belonging to the same spectrum rather disregard the fact that even in acoustics the relationship of integer numbers holds only in special and very simple cases. Some corroboration of the simple law was apparently found by Johnstone Stoney, who first noted that the frequencies of three out of the four visible hydrogen lines are in the ratios 20 : 27 : 32. In other spectra such "harmonic" ratios were also discovered, but their search was abandoned when it was found that their number did not exceed that calculated by the laws of probability on the supposition of a chance distribution.⁶ The next great step was made by J. J. Balmer, who showed that the four hydrogen lines in the visible part of the spectrum may be represented by the equation

$$n = A(1 - 4/s^2),$$

where n is the reciprocal of the wave-length and therefore proportional to the wave frequency, and s successively takes the values 3, 4, 5, 6. Balmer's formula received a striking confirmation when it was found to include the ultra-violet lines which were discovered by Sir William Huggins⁷ in the photographic spectra of stars. The most complete hydrogen spectrum is that measured by Evershed⁸ in the flash spectrum observed during a total solar eclipse, and contains thirty-one lines, all of which agree with considerable accuracy with the formula, if the frequency number n is calculated correctly by reducing the wave-length to vacuo.⁹

It is a characteristic of Balmer's formula that the frequency approaches a definite limit as s is increased, and it was soon discovered that in several other spectra besides hydrogen, series of lines could be found, which gradually come nearer and nearer to each other as they become fainter, and approach a definite limit. Such series ought all to be capable of being represented by a formula resembling that of Balmer, but so far the exact form of the series has not been established with certainty. The more important of the different forms suggested are as follow:

$$(1) \quad n = A + \frac{B}{s^2} + \frac{C}{s^4} \quad (\text{H. Kayser and C. Runge}).$$

$$(2) \quad n = A - \frac{N}{s(+\mu)^2} \quad (\text{J. R. Rydberg}).$$

³ *Bulletin Akad. St Petersburg* (1907), p. 159.

⁴ *Phil. Mag.* (September, 1909), 18, p. 371.

⁵ *Ann. d. Phys.* (1909), 29, p. 1833.

⁶ A. Schuster, *Proc. Roy. Soc.* (1881), 21, p. 337.

⁷ *Phil. Trans.* (1880), 171, p. 619.

⁸ *Ibid* (1891), 197, p. 381.

⁹ The table so corrected will be found in C. Baly's *Spectroscopy*, p. 472.

- (3) $n = A - \frac{N}{(s+\mu)^2 + a}$ (E. C. Pickering, generalized by T. N. Thiele).
- (4) $n = A - \frac{N}{(r+a+b/r^2)^2}$ (Ritz).
- (5) $n = A - \frac{N}{(s+\mu+a/s)^2}$ (Hicks).

In all cases s represents the succession of integer numbers. In the last case we must put for r either s or $s+\frac{1}{2}$ according to the nature of the series, as will be explained further on. The first of the forms which contains three disposable constants did good service in the hands of their authors, but breaks down in important cases when odd powers of s have to be introduced in addition to the even powers. The second form contains two or three constants according as N is taken to have the same value for all elements or not. Rydberg favours the former view, but he does not attempt to obtain any very close approximation between the observed and calculated values of the frequencies. Equation (3), which E. C. Pickering¹ used in a special case, presently to be referred to, was put into a more general form by Thiele,² who, however, assumes N to have the same value for all spectra, and not obtaining sufficient agreement, rejects the formula. J. Halm³ subsequently showed that if N may differ in different cases, the equation is a considerable improvement on Rydberg's. It then possesses four adjustable constants, and more can therefore be expected from it. All these forms are put into the shade by that which was introduced by Ritz, led thereto apparently by theoretical considerations. As he takes N to be strictly the same for all elements the equation has only three disposable constants A , a and b . It is found to be very markedly superior to the other equations. Its chief advantage appears, however, when the relationship between different series of the same element is taken into account. We therefore turn our attention to this relationship.

In the case of those elements in which we can represent the spectrum most completely by a number of series, it is generally found that they occur in groups of three which are closely related to each other. They were called by H. Kayser and F. Paschen "Haupt serie," "1st Nebenserie," "2nd Nebenserie," which is commonly translated "Principal series," "First subordinate series," "Second subordinate series." These names become inconvenient when, as is generally the case, each of the series splits into groups of two or three, and we have to speak of the second or third number of the first or second subordinate series. Moreover, a false impression is conveyed by the nomenclature, as the second subordinate series is much more closely related to the principal series than the first subordinate series. The present writer, therefore, in his *Theory of Optics*, adopted different names, and called the series respectively the "Trunk," the "Main Branch" and the "Side Branch," the main branch being identical with the second subordinate series; the limit of frequency for high values of s is called the "root" of the series, and it is found in all cases that the two branches have a common root at some point in the trunk. According to an important law discovered by Rydberg and shortly afterwards independently by the writer, the frequency of the common root of the two branches is obtained by subtracting the frequency of the root of the trunk from that of its least refrangible and strongest member. In the spectra of the alkali metals each line of the trunk is a doublet, and we may speak of a twin trunk springing out to the two branches are also doublets. According to the above law the least refrangible member of the trunk being double, there must be two roots for the branches, and this is found to be the case. In fact the lines of each branch are also doublets, with common difference of frequency. There are, therefore, two main branches and two side branches, but these are not twins springing out of the same root, but parallel branches springing out of different though closely adjacent roots. It will also be noticed that the least refrangible of the doublets of the

branches must according to the above law correspond to the most refrangible of the doublets of the trunk, and if the components of the doublets have different intensities the stronger components must lie on different sides in the trunk and branch series. This is confirmed by observation. Rydberg discovered a second relationship, which, however, involving the assumed equation connecting the different lines, cannot be tested directly as long as these equations are only approximate. On the other hand the law, once shown to hold approximately, may be used to test the sufficiency of a particular form of equation. These forms all agree in making the frequency negative when s falls below a certain value s_p . Rydberg's second law states that if the main branch series is taken, the numerical value of n_{p-1} corresponding to s_{p-1} is equal to the frequency of the least refrangible member of the trunk series.

The two laws are best understood by putting the equations in the form given them by Rydberg.

For the trunk series write

$$\frac{n_s}{N} = \frac{1}{(1+\sigma)^2} - \frac{1}{(s+\mu)^2}$$

and for the main branch series

$$\frac{n'_s}{N} = \frac{1}{(1+\mu)^2} - \frac{1}{(s+\sigma)^2}$$

Here μ , σ and N are constants, while s as before is an integer number.

The difference between the frequencies of the roots ($s=\infty$) is given by

$$n_{\infty} - n'_{\infty} = N \left[\frac{1}{(1+\sigma)^2} - \frac{1}{(1+\mu)^2} \right] = n_1.$$

This is the first law.

If further in the two equations we put $s=1$, we obtain:

$$n_1 = -n'_1.$$

This is the second law.

As has already been mentioned, the law is only verified very roughly, if Rydberg's form of equation is taken as correctly representing the series. The fact that the addition of the term introduced by Ritz not only gives a more satisfactory representation of each series, but verifies the above relationship with a much closer degree of approximation, proves that Ritz's equation forms a marked step in the right direction. According to him, the following equations represent the connexion between the lines of the three related series.

$$\text{Trunk series: } \pm \frac{n_s}{N} = \frac{1}{[s+a_1+b/s^2]^2} - \frac{1}{[1.5+a^1+b^1/(1.5)^2]^2}$$

$$\text{Main Branch Series: } \pm \frac{n'_s}{N} = \frac{1}{[2+a_1+b/2^2]^2} - \frac{1}{[r+a^1+b^1/r^2]^2}$$

$$\text{Side Branch Series: } \pm \frac{n''_s}{N} = \frac{1}{[2+a_1+b/2^2]^2} - \frac{1}{[s+c+d/s^2]^2}$$

Here s stands for an integer number beginning with 2 for the trunk and 3 for the main branch, and r represents the succession of numbers 1.5, 2.5, 3.5, &c. As Ritz points out, the first two equations appear only to be particular cases of the form

$$\frac{n}{N} = \frac{1}{(s+\alpha)^2} - \frac{1}{(r+\beta)^2}$$

in which s and r have the form given above. In the trunk series s has the particular value 1.5, and in the main branch series s has the particular value 2, but we should expect a weaker set of lines to exist corresponding to the trunk series with $r=2.5$ or corresponding to the main branch series with $s=3$, and in fact a whole succession of such series. Taking the Trunk and Main Branch Series, we find they depend altogether on the four constants: a_1 , b , a^1 , b^1 , while N is a universal constant identical with that deduced from the hydrogen series. As an example of the accuracy obtained we give in the following Table the figures for potassium. The lines of the trunk series are double but for the sake of shortness the least refrangible component is here omitted.

Spectrum of Potassium.

Trunk Series.			Main Branch.			Side Branch.		
S	n	Δ	r	n	Δ	s	n	Δ
2	13036.8	-0.24	1.5	12980.7	0.00	5	17199.5	0.00
3	24719.4	+0.00	2.5	—	—	6	18709.5	0.00
4	29006.7	+0.12	3.5	14465.3	0.00	7	19611.2	+0.16
5	31073.5	-0.05	4.5	17288.3	+0.20	8	20188.0	+0.70
6	32226.5	+0.40	5.5	18779.2	+0.22			
7	32939.4	-0.05	6.5	19662.3	+0.22			
8	33408.7	-0.08	7.5	20224.7	+1.10			
9	33736.2	-0.07						
10	33971.4	-0.23						

¹ *Astrophys. Journ.* (1896), 4, p. 369.

² *Ibid.* (1897), 6, p. 65.

³ *Trans. Ast. Soc. Edinburgh* (1905), 41, p. 551.

W. M. Hicks¹ has modified Rydberg's equation in a way similar to that of Ritz as shown by (5) above. This form has the advantage that the constants of the equation when applied to the spectra of the alkali metals show marked regularities. The most extensive series which has yet been observed is that of the trunk series of sodium when it is observed as an absorption spectrum; R. W. Wood has in that case measured as many as 50 lines belonging to this series.

The different series have certain characteristics which they seem to maintain wherever they have been obtained. Thus the trunk series consists of lines which are easily reversed while those of the side branch are nebulous. The lines of the trunk seem to appear at lower temperatures, which may account for the fact that it can be observed as absorption lines. If we compare together the spectra of the alkali metals, we find that the doublets of the branch series separate more and more as the wave-length increases. Roughly speaking the difference in frequency is proportional to the square of the atomic weight. Taking sodium and lithium we find in this way that the lithium lines ought to be double and separated by 7 Å. They have not, however, so far as we know, been resolved. The roots of the three series have frequencies which diminish as the atomic weight increases, but not according to any simple law.

In the case of other metallic groups similar series have also been found, but while in the case of the alkali group nearly the whole spectrum is represented by the combined set of three series, such is not the case with other metals. The spectra of magnesium, calcium, zinc, cadmium and mercury, give the two branch series, and each series is repeated three times with constant difference of frequency. In these elements the doublets of the alkali series are therefore replaced by triplets. Strontium also gives triplets, but only the side branch series has been observed. In the spectrum of barium no series has yet been recognized. The spectrum of helium has been very carefully studied by Runge and Paschen. All its lines arrange themselves in two families of series, in other words, the spectrum looks like that of the superposition of two spectra similar to those presented by the alkali metals. Each family consists of the trunk, main branch and side branch. The conclusion which was originally drawn from this fact that helium is a mixture of two gases has not been confirmed, as one of the spectra of oxygen is similarly constituted.

We must refer to Kayser and Runge's *Handbuch* for further details, as well as for information on other spectra such as those of silver, thallium, indium and manganese, in which series lines have been found.

Before leaving the subject, we return for a moment to the spectrum of hydrogen. In 1896, Professor E. C. Pickering discovered in the structure of the star ξ Puppis a series of lines which showed a remarkable similarity to that of hydrogen having the same root. Kayser on examining the spectrum recognized the fact that the two series were related to each other like the two branch series, and this was subsequently confirmed. If we compare Balmer's formula with the general equation of Ritz, we find that the two can be made to agree if the ordinary hydrogen spectrum is that of the side branch series and the constants a^1 , b , c and d are all put equal to zero. In that case the main branch is found to represent the new series if a^1 and b^1 are also put equal to zero, so that

$$+\frac{n^1 r}{N} = \frac{1}{4} - \frac{1}{r^2},$$

where r takes successively the values 1.5, 2.5, 3.5. A knowledge of the constants now determines the trunk series, which should be

$$\frac{n}{N} = \left(\frac{1}{(1.5)^2} - \frac{1}{s^2} \right).$$

The least refrangible of the lines of this series should have a wave-length 4687.88, and a strong line of this wave-length has indeed been found in the spectra of stars which are made up of bright lines, as also in the spectra of some nebulae. It seems remarkable, however, that we should not have succeeded yet in reproducing in the laboratory the trunk and main branch of the hydrogen spectrum, if the spectra in question really belong to hydrogen.

Considering the complexity of the subject it is not surprising that the efforts to connect theoretically the possible periods of the atom considered as a vibrating system have met with no considerable success. Two methods of investigation are available. The one endeavours to determine the conditions, which are consistent with our knowledge of atomic constitution derived from other sources, and lead to systems of vibration similar to those of the actual atom. We might then hope to particularize or modify these conditions so as to put them into more complete agreement. An attempt in that direction has been made with partial success by J. H. Jeans,² who showed that a shell-like constitution of the atom, the shells being electrically charged,

would lead to systems of periods not unlike those of a series of lines such as is given by observation. The other method starts from the observed values of the periods, and establishes a differential equation from which these periods may be derived. This is done in the hope that some theoretical foundation may then be found for the equation. The pioneer in this direction is E. Riecke,³ who deduced a differential equation of the 10th order. Ritz in the paper already mentioned follows in the footsteps of Riecke and elaborates the argument. On the whole it seems probable that the system of moving electrons, which according to a modern theory constitute the atom, is not directly concerned in thermal radiation which would rather be due to a few more loosely connected electrons hanging on to the atom. The difficulty that a number of spectroscopic lines seem to involve at least an equal number of electrons may be got over by imagining that the atom may present several positions of equilibrium to the electron, which it may occupy in turn. A collision may be able to throw the electrons from one of these positions to another. According to this view the different lines are given out by different molecules, and we should have to take averages over a number of molecules to obtain the complete spectrum just as we now take averages of energy to obtain the temperature.⁴ If it should be confirmed that the period called N in the above investigation is the same for all elements, it must be intimately connected with the structure of the electron. At present the quantity of electricity it carries, and also its mass, may be determined, and we can therefore derive units of length and of mass from our electrical measurements. The quantity N may serve to fix the third fundamental unit. One further point deserves notice. Lord Rayleigh,⁵ who has also investigated vibrating systems giving series of lines approaching a definite limit of "root," remarks that by dynamical reasoning we are always led to equations giving the square of the period and not the period, while in the equation representing spectral series the simplest results are obtained for the first power of the period. Now it follows from Rydberg's second law put on a more accurate basis by Ritz that in one case at any rate a *negative* period has reality and must be interpreted just as if it were positive. This looks indeed as if the *square* of the period were the determining quantity.

9. *Distribution of Frequencies in Band Spectra.*—In many cases the spectra of molecules consist of lines so closely ruled together in groups as to give the appearance of continuous bands unless high resolving powers are employed. Such spectra seem to be characteristic of complex molecular structure, as they appear when compounds are raised to incandescence without decomposition, or when we examine the absorption spectra of vapours such as iodine and bromine and other cases where we know that the molecule consists of more than one atom. The bands often appear in groups, and such spectra containing groups of bands when viewed through small spectroscopes sometimes give the appearance of the flutings of columns. Hence the name "fluted spectra," which is sometimes applied. Each band, as has been stated, is made up of lines indicating highly homogeneous vibrations. A systematic study of the distribution of frequencies in these bands was first made by H. Deslandres,⁶ who found that the successive differences in the frequencies formed an arithmetical progression.

If s represents the series of integer numbers the distribution of frequency may be represented by

$$n = C + Bs^2,$$

where C and B are constants. The brightest line, for which $s=0$, is called the "head" of the band; and as s increases the lines diminish in intensity. The band fades towards the red or violet according as A is positive or negative, and the appearance is sometimes complicated by the fact that several sets of lines start from identical or closely adjoining heads. The equation which expressed "Deslandres' law" was only given by its author as an approximate one. The careful measurements of Kayser and Runge of the carbon bands show that the successive differences in the frequencies do

³ *Drude's Annalen* (1900), I, p. 399.

⁴ *Nature* (1895), 51, p. 293.

⁵ *Phil. Mag.* (1897), 44, p. 356.

⁶ *Comptes rendus* (1885), 100, p. 1256.

¹ *Proc. Roy. Soc.* (1909), 83, p. 226 (abstract).

² *Phil. Mag.* (1901), 2, p. 421.

not quite keep up with the mathematical expression but tend to become more equal. The distances between the two first lines is A , and is small compared with the frequency itself, which is B .

If this is the case it is obvious that an equation of the form

$$n = A - \frac{N}{s^2 + a}$$

does, for small values of s , becomes identical with Deslandres' equation, a representing a constant which is large compared with unity. If we wish to be more general, while still adhering to Deslandres' law as a correct representation of the frequencies when s is small, we may write

$$n = A - \frac{N}{(s + \mu)^2 + a}$$

where μ is an additional constant.

We have now reduced the law for the bands to a form which we have found applicable to a series of lines, but with this important difference that while a in the case of line spectra is a small corrective term, it now forms the constant on which an essential factor in the appearance of the band depends. Halm,¹ to whom we owe a careful comparison of the above equation with the observed frequencies in a great number of spectra, attached perhaps too much weight to the fact that it is capable of representing both line and band spectra. It is no doubt important to recognize that the two types of spectra seem to represent two extreme cases of one formula, the significant difference being that in the line spectrum the distance between lines diminishes as we recede from the head, while in the case of the band it increases, at any rate to begin with. But, on the other hand, no one pretends to have found the rigorous expression for the law, and the appropriate approximation may take quite different forms when constants which are large in one case are small in the other. It would not therefore be correct to push this agreement against Ritz's expression which is not applicable to bands.

A discussion of band spectra on a very broad basis was given by Thiele,² who recommends a formula

$$n = \frac{q_0 + q_1(s+c) + \dots + q_r(s+c)^r}{p_0 + p_1(s+c) + \dots + p_r(s+c)^r},$$

where s as before represents the integer numbers and the other quantities involved are constants. If $r=1$, we obtain Pickering's equation, which is the one advocated by Halm. Equations of this form have received a striking observational verification in so far as they predict a tail or root towards which the lines ultimately tend when s is increased indefinitely. This fact bridges over the distinction between the band and line spectra. The distance between the lines measured on the frequency scale does not, according to the equation, increase indefinitely from the head downwards, but has a maximum which, in Pickering's form as written above, is reached when $(s + \mu)^2 = \frac{1}{3}a$. This gives a real value for s only when a is positive. If a is negative the frequency passes through infinity and the maximum distance between the lines occurs there. If we only assign positive values to n and a , the band fades away from the head, the lines at first increasing in distance. It appears from the observations of A. S. King,³ that in the case of the so-called spectrum of cyanogen these tails can be observed. If a negative value of the frequency is admitted, more complicated effects may be predicted. A band might in that case fade away towards zero frequencies, and as s increases, return again from infinity with diminishing distances, the head and the tail pointing in the same direction; or with a different value of constants a band might fade away towards infinite frequencies, then return through the whole range of the spectrum to zero frequencies, and once more return with its tail near its head. The same band may therefore cross its own head on the return journey. If we adopt Thiele's view that each band is accompanied by a second branch for which s has negative values the complication is still further increased, but there does not seem to be sufficient reason to adopt this view.

10. *Effects of Varying Physical Conditions.*—The same spectrum may show differences according to the physical conditions under which the body emitting the spectrum is placed. The main effects we have to discuss are (1) a symmetrical widening, (2) a shift of wave-length, which when it accompanies expansion in both directions may appear as an unsymmetrical widening, (3) a change in the relative intensities of the lines.

As typical examples illustrating the facts to be explained, the following may be mentioned. (a) When a sodium salt is placed in a Bunsen burner in sufficient quantity, the yellow lines are widened. When the amount of luminous matter is small the lines remain narrow. (b) If a spark be sent through a Plücker tube containing hydrogen the lines are widened when the pressure

is increased. (c) Under moderate pressures the lines of hydrogen may be widened by powerful sparks taken from a condenser. (d) If a spark be taken from an electric condenser through air, both the lines of oxygen and nitrogen are wide compared with what they would be at low pressures. But a mixture of nitrogen and oxygen containing only little nitrogen will show the nitrogen lines narrow and similarly narrow oxygen lines may be obtained if the quantity of oxygen is reduced. (e) If a spark be taken from a solution of a salt, e.g. lithium, the relative intensities of the lines are different according as the solution is concentrated or dilute. (f) The relative intensity of lines in the spark taken from metallic poles may be altered by the insertion of greater or smaller capacities, similarly the relative intensities are different in arc and spark spectra. (g) Increased pressure nearly always diminishes the frequency of vibration, but this effect is generally of a smaller order of magnitude than the widening which takes place in the other cases. In investigating the effects of mixture on the widening of lines in absorption spectrum, R. W. Wood discovered some interesting effects. The cadmium line having a wave-length of 2288 Å broadens by pressure equally in both directions, but if mercury be added the broadening is more marked on the less refrangible side.

The discussion as to the causes of this widening has turned a good deal on the question whether it is primarily due to changes of density, pressure or temperature, but some confusion has been caused by the want of proper definition of terms. For the cause of this the writer of the present article is jointly with others at any rate partly responsible, and clearness of ideas can only be re-established by investigating the mechanical causes of the effect rather than by applying terms which refer to a different order of physical conceptions.

The facts, as quoted, point to the closeness of the packing of molecules as the factor which always accompanies and perhaps causes the widening of lines. But is this alone sufficient to justify us in assigning the widening to increased density? Increased density at the same temperature means in the first place a reduction of the average distance between the molecules, but it means also a reduction in the mean free path and an increase in the number of impacts. The question is: which of these three factors is significant in the explanation of the widening? If it is the average distance irrespective of length of path and of number of impacts we should be justified in ascribing the effect to density, but if it is the number of impacts it would be more reasonable to ascribe it to pressure. The question could not be settled by experiments made at the same temperature, and if the temperature is altered the question is complicated by the distinction which would probably have to be drawn between the number of collisions and their intensity. Experimentally we should be confined to a strict investigation of absorption spectra, because in the electric discharge temperature has no definite meaning, and variations of pressure and density are not easily measured.

Assuming for a moment the change to be one of density and leaving out of account the pressure shift, the cases (e) and (f) point to the fact that it is the closeness of packing of similar molecules which is effective, e.g. the number of oxygen molecules per cubic centimetre determines the width of the oxygen lines, though nitrogen molecules may be mixed with them without materially affecting the appearance. Experiment (c) is, however, generally taken to mean that this closeness of packing cannot be the sole determining cause, for it is argued that if a closed vacuum tube can show both wide and narrow lines according to the mode of discharge, density alone cannot account for the change. But this argument is not conclusive, for though the total number of hydrogen molecules is fixed when the gas is enclosed, yet the number of luminous molecules may vary with the condition. Those that are not luminous may, if they do not contain the same vibrating system, behave like inert molecules. When an electric current from a battery is sent through a tube containing hydrogen, increase of current simply means increase in the number of ions which take part

¹ *Trans. Roy. Soc. Edin.* (1905), 41, p. 551.

² *Astrophys. Journ.* (1897), 6, p. 65; (1898), 8, p. 1.

³ *Ibid.* (1901), 14, p. 323.

in the discharge, except within the region of the cathode glow. Each molecule need not radiate with increased energy, but the more brilliant emission of light may be due to the greater number of particles forming similar vibrating systems.

When we compare together electric discharges the intensity of which is altered by varying the capacity, we are unable to form an opinion as to whether the effects observed are due to changes in the density of the luminous material or changes of temperature, but the experiments of Sir William and Lady Huggins¹ with the spectrum of calcium are significant in suggesting that it is really the density which is also the determining factor in cases where different concentrations and different spark discharges produce a change in the relative intensities of different lines.

The widening of lines does not lend itself easily to accurate measurements; more precise numerical data are obtainable by the study of the displacements consequent on increased density which were discovered and studied by W. J. Humphreys and J. F. Mohler. In the original experiments² the pressures could only be increased to 15 atmospheres, but in a more recent work Humphreys,³ and independently Duffield, were able to use pressures up to 100 atmospheres. The change of frequency (dn) for a series of lines which behave similarly is approximately proportional to the frequency (n) so that we can take the fraction dn/n as a measure of the shift. It is found that the lines of the same element do not all show the same shift, thus the calcium line at 4223 is displaced by 0.4 Å by 100 atmospheres pressure, while the H and K lines are only displaced through about half that amount. Duffield finds that the iron lines divide themselves into three groups with pressure shifts which are approximately in the ratio 1 : 2 : 4. Curiously enough this is also approximately the ratio of the displacements found by Humphreys in the trunk series, the side branch and main branch in the order named, in cases where these displacements have been measured. It was believed that band spectra did not show any pressure shift, until A. Dufour⁴ discovered that the lines into which the band spectra of the fluorides of the alkaline earths may be resolved widen towards the red under increased pressure.

Let us now consider the causes which may affect the homogeneity of radiation. We have first the Doppler effect, which, according to Michelson's experiment, is the chief cause of the limit at very low pressures, but it is too small to account for the widening which is now under discussion. We have further to consider the possibility of sudden changes of phase during an encounter between two molecules, and we can easily form an estimate of the amount of apparent widening due to this cause. It is found to be appreciable but smaller than the observed effects.

Shortly after the discovery of pressure shifts A. Schuster⁵ suggested that the proximity of molecules vibrating in the same period might be the cause of the diminished frequency, and suggested that according to this view the shifts would be similar if the increase of density were produced by the presence of molecules of a different kind from those whose lines are being examined. Though there is no absolutely conclusive evidence, no experiments hitherto have given any indication that the nature of the gas producing the pressure has any effect on the amount of shift. G. F. Fitzgerald⁶ suggested as an alternative explanation the change of inductive capacity of the medium due to increased density. J. Larmor⁷ developed the same idea, and arrived by a very simple method at an approximation estimate of the shift to be expected.

If the medium which contains the vibration is divided into a sphere equal to k times the molecular vibration outside of which the effects of these molecules may be averaged up, so that its

inductive capacity may be considered uniform and equal to K , the frequency of the vibration is increased in the ratio of the square root of $1 - k^{-2n+3}(1 - K^{-1})$ to 1. Here n represents an integer which is 3 if the vibration is a simple doublet, but may have a higher integer value. If K has a value nearly equal to unity, the pressure shift is $\frac{1}{2}k^{-2n+3}(K^{-1} - 1)$, and it is significant that for different values of n , the shifts should be in geometric ratio, because as stated above, the ratio occurring in the amounts observed with different lines of the same element are as 1 : 2 : 4. The question is complicated by the fact that in the cases which have been observed, the greater portion of the metallic vapour vibrates in an atmosphere of similar molecules, and the static energy of the field is determined by the value of K applicable to the particular frequency. It would therefore seem to be more appropriate to replace $1 - K^{-1}$ by $(\mu^2 - 1)/\mu^2$, where μ is the refractive index; but this expression involves the wave propagation for periods coinciding with free periods of the molecules. Close to and on either side of the absorptive band μ^2 has large positive and negative values, and if the above expression remains correct the change of frequency would, close to the centre of absorption, be $\frac{1}{2}k^{-2n+3}$, which for $n=3$ and $k=10$ is 1/2000, or 500 times greater than the observed shifts, but this represents now the *maximum* displacement and not the displacement of the most intense portion of the radiation. There is a region within the band where $\mu = 0$, and this would give an infinite shift in the opposite direction. We therefore should expect a band in place of the line, which is the case, but our calculation is not able to give the displacement of the most intense portion, which is what we require for comparison with experiment.

The effects of resonance have been studied theoretically by Prince Galitzin⁸ and later by V. W. Ekman.⁹ The latter obtains results indicating no displacement but a widening. He concludes an interesting and important investigation by giving reasons for believing that the centre of a widened line radiates with smaller energy than the adjacent parts. Hence the apparent reversals so frequently observed in the centre of a widened line may not be reversals at all but due to a reduction in luminosity. Ekman quotes in support an observation due to C. A. Young, according to which the dark line observed in the centre of each component of the sodium doublet in a Bunsen burner is *transparent* to a radiation placed behind. It should not be difficult to decide whether the reversals are real or fictitious.

Leaving the consideration of radical changes of a vibrating system out of account for the present, the minor differences which have been observed in the appearances of spectra under different sparking conditions are probably to a large extent due to differences in the quantities of material examined, though temperature must alter the violence of the impact and there is a possible effect due to a difference in the impact according as the vibrating system collides with an electron or with a body of atomic dimensions.

A. Schuster and G. A. Hemsalech have observed that the insertion of a self-induction in a condenser discharge almost entirely obliterates the air lines, and the same effect is produced by diminishing the spark gap sufficiently. The explanation of these facts presents no difficulty, inasmuch as during the sudden discharge which takes place in the absence of a self-induction, the metallic molecules have not sufficient time to diffuse through the spark gap; hence the discharge is carried by the gas in which it takes place. When, however, the time of discharge is lengthened, the conditions of the arc are more nearly approached. When the spark gap is small, the sudden evaporation of the metal has a better chance of filling the interval between the poles, even without the introduction of a self-induction.

Enhanced lines are lines which appear chiefly near the pole when strong spark discharges are used. Their presence indicates the characteristic difference between the spark and the arc. The name is due to Sir Norman Lockyer, who has studied these lines and drawn the attention of astronomers to their importance in interpreting stellar spectra. These lines in the case of the spark cannot be due entirely to the increased mass of vapour near the poles, but indicate a real change of spectrum probably connected with a higher temperature.

¹ *Proc. Roy. Soc.* (1897), 61, p. 433.

² *Astrophys. Journ.* (1876), 3, p. 114.

³ *Ibid.* (1907), 26, p. 18.

⁴ *Comptes rendus* (1908), 146, pp. 118, 229.

⁵ *Astrophys. Journ.* (1896), 3, p. 292.

⁶ *Ibid.* (1897), 5, p. 210.

⁷ *Ibid.* (1907), 26, p. 120.

⁸ *Wied. Ann.* (1895), 56, p. 78.

⁹ *Ann. d. Phys.* (1907), 24, p. 580.

11. *Molecular Velocities*.—A. Schuster and G. A. Hemsalech¹ have measured the velocity with which the luminous molecules are projected from metallic poles when a strong spark is passed through the air interval which separates the poles. The method adopted consisted in photographing the spectrum on a film which was kept in rapid motion by being attached to the front of a rotating disk. The velocities ranged from about 400 to 1900 metres, the metals of small atomic weight giving as a rule the higher velocities. In the case of some metals, notably bismuth, the velocity measured was different for different lines, which seems intelligible only on the supposition that the metal vapour consists of different vibrating systems which can differ with different velocities. C. C. Schenck² subsequently conducted similar experiments, using a rotating mirror, and though he put a different interpretation on the effects, the main conclusions of Schuster and Hemsalech were not affected. These have further been confirmed and extended by the experiments of J. T. Royds made with the same rotating disk, but with improved optical appliances. The photographs taken by Royds show the separate oscillations of each spark discharge even when the circuit only contained the unavoidable capacity of the leads. It was found that during the successive electrical oscillations the metallic lines can be observed to stretch farther and farther away from the poles, thus giving a measure of the gradual diffusion of the metal. The subject wants further investigation, especially with a view to deciding the connexion between the molecular rush and the discharge. While some of the phenomena seem to indicate that the projection of metallic vapours into the centre of the spark is a process of molecular diffusion independent of the mechanism of the discharge, the different velocities obtained with bismuth, and the probability that the vibrating systems are not electrically neutral, seem to indicate that the projected metallic particles are electrified and play some part in the discharge.

12. *The Zeeman Effect*.—The change of frequency of oscillation of radiating molecules placed in a magnetic field, which was discovered by P. Zeeman, and the observed polarization of the components, are all beautifully explained by the theory of H. A. Lorentz, and leave no manner of doubt that the radiating centres are negative electrons. The fact that in certain simple cases where a line when looked at equatorially splits into a triplet, the ratio of the charge to the mass is found by Lorentz's theory to be equal to that observed in the carrier of the cathode ray, shows that in these cases the electron moves as an independent body and is not linked in its motion to other electrons. On the other hand, most of the lines show a more complicated structure in the magnetic field, suggesting a system of electrons rather than a single free corpuscle. The question has been fully discussed by C. Runge in the second volume of Kayser's *Handbuch* (see also MAGNETO-OPTICS), and we may therefore content ourselves with the mention of the law discovered by Th. Preston that all the lines of the same series show identical effects when measured on the frequency scale, and the fact recently announced by Runge³ that even in the more complicated cases mentioned some simple relation between the distances of the components exists. If a is the distance shown by the normal triplets the type of separation observed in the line D_2 shows distances from the central line equal to $a/3$, $3a/3$, $5a/3$, while the type of D_1 gives $2a/3$, $4a/3$. In all observed cases the distances are multiples of some number which itself is a sub-multiple of a . The component lines of a band spectrum do not as a rule give the Zeeman effect, and this seems to be connected with their freedom from pressure shifts, for when Dufour had shown that the bands of the fluoride of calcium were sensitive to the magnetic field, R. Rossi⁴ could show that they were also sensitive to pressure.

13. *Identification of Spectra*.—The interpretation of spectroscopic observation seemed very simple when Kirchhoff and

Bunsen first announced their discovery, for according to their view every combination of an element showed the characteristic spectrum of its constituent atoms; it did not matter according to this view whether a salt, e.g. sodium chloride, introduced into a flame, was dissociated or not, as in either case the spectrum observed would be that of sodium. It was soon found, however, that compounds possess their own characteristic spectra, and that an element may give under special conditions of luminosity several different spectra. When we now speak of the identification of spectra we like to include, wherever possible, the identification of the particular compound which is luminous and even—though we have only begun to make any progress in that direction—the differentiation between the molecular or electronic states which yield the different spectra of the same element.

One preliminary question must first be disposed of. The fact that the gases with which we are most familiar are not rendered luminous by being heated in a tube to a temperature well above a white heat has often been a stumbling block and raised the not unreasonable doubt whether approximately homogeneous oscillations could ever be obtained by a mere thermal process. The experiment proves only the transparency of the gases experimented upon, and this is confirmed by the fact that bodies like bromine and iodine give on heating an emission spectrum corresponding to the absorption spectrum seen at ordinary temperatures. The subject, however, required further experimental investigation, which was supplied by Paschen. Paschen proved that the emission spectra of water vapour as observed in an oxyhydrogen flame and of carbon dioxide as observed in a hydrocarbon flame may be obtained by heating aqueous vapour and carbon dioxide respectively to a few hundred degrees above the freezing point. The same author proved that a sufficient thickness of layer raised the radiation to that of a black body in agreement with Kirchhoff's law. The spectra experimented on by Paschen were band spectra, but as these split up into fine lines the possibility of homogeneous radiation in pure thermal oscillation may be considered as established. Paschen's observations originated in the desire to decide the question raised by E. Pringsheim, who, by a series of experiments of undoubted merit, tried to establish that the emission of the line spectra of the alkali metals was invariably associated with a reduction of the metallic oxide. Pringsheim seems, however, to have modified his view in so far as he now seems to consider that the spectra in question might be obtained also in other ways, and to attach importance to the process of reduction only in so far as it forms an effective inciter of the particular spectra. In spite of the fact that C. Fredenhagen has recently attempted to revive Pringsheim's original views in a modified form—substituting oxidation for reduction—we may consider it as generally admitted that the origin of spectra lies with vibrating systems which are definite and not dependent on the method of incitement. These systems may only be semi-stable, but they must last a sufficient length of time to give a train of waves having a length corresponding to the observed homogeneity of the line.

In many cases there is a considerable difficulty in deciding whether a particular spectrum belongs to a compound body or to one of the elements composing the compound. Thus one of the most common spectra is that seen at the base of every candle and in every Bunsen burner. Everybody agrees that carbon is necessary for its appearance, but some believe it to be due to a hydrocarbon, others to carbon monoxide, and others to volatilized carbon. There is a vast amount of literature on the subject, but in spite of the difficulty of conceiving a luminous carbon vapour at the temperature of an ordinary carbon flame, the evidence seems to show that no other element is necessary for its production as it is found in the spectrum of pure carbon tetrachloride and certainly in cases where chlorine is excluded. Another much disputed spectrum is that giving the bands which appear in the electric arc; it is most frequently ascribed to cyanogen, but occasionally also to carbon vapour.

Compounds generally show spectra of resolvable bands, and

¹ *Phil. Trans.* (1899), 190, p. 189.

² *Astrophys. Journ.* (1901), 14, p. 116.

³ *Phys. Zeitschrift*, 8, p. 225.

⁴ *Proc. Roy. Soc.* (1909), 82, p. 518.

if an elementary body shows a spectrum of the same type we are probably justified in assuming it to be due to a complex molecule. But that it may be given by the ordinary diatomic molecule is exemplified by oxygen, which gives in thick layers by absorption one of the typical sets of bands which were used by Deslandres and others to investigate the laws of distribution of frequencies. These bands appear in the solar spectrum as we observe it, but are due to absorption by the oxygen contained in the atmosphere.

If oxygen is rendered luminous by the electric discharge, a series of spectra may be made to appear. Under different conditions we obtain (a) a continuous spectrum most intense in the yellow and green, (b) the spectrum dividing itself into two families of series, (c) a spectrum of lines which appears when a strong spark passes through oxygen at atmospheric pressure, (d) a spectrum of bands seen in the cathode glow. We have therefore five distinct spectra of oxygen apart from the absorption spectra of ozone. To explain this great variability of spectroscopic effects we may either adopt the view that molecular aggregates of semi-stable nature may be found in vacuum tubes, or that a molecule may gain or lose one or more additional electrons and thus form new vibrating systems. It seemed that an important guide to clear our notions in this direction could be obtained through the discovery of J. Stark, who examined the spectra of the so-called "canal-rays" (*Canalstrahlen*). These rays are apparently the trajectories of positively charged particles having masses of the order of magnitude of the gaseous molecules. Stark discovered that in the case of the series spectrum of hydrogen and of other similar spectra the lines were displaced indicating high velocities; in other cases no displacements could be observed. The conclusion seemed natural that the spectra which showed the Doppler effect were due to vibratory systems which had an excess of positive charge. More detailed examinations of the "canal-rays" by J. J. Thompson and others have shown however that they contain both neutral and charged molecules in a relative proportion which adjusts itself continuously, so that even neutral molecules may partake of the translatory motion which they gained while carrying a charge. No conclusion can therefore be drawn, as Stark¹ has more recently pointed out, respecting the charge of the molecule which emits the observed spectrum. Nevertheless, the subject is well worth further investigation.

Previous to Stark's investigation P. Lenard² had concluded that the carriers of certain of the lines of the flame spectra of the alkali metals are positively charged. He draws a distinction between the lines of the trunk series to which he assigns neutral, and the lines of carriers the two branch series of which are electrically charged. The numerical relations existing between the trunk series and the branch series make it somewhat difficult to believe that they belong to different vibrating systems. But while we should undoubtedly hesitate on this ground to adopt Fredenhagen's³ view that the two branch series belong to the element itself and the trunk series to a process of oxidation, we cannot press the argument against the view of Lenard, because the addition or subtraction of an electron introduces two vibrating systems which are still connected with each other and some numerical relationship is probable. Whatever ideas we may form on this point, the observations of Stark and Siegl⁴ have shown that there is a Doppler effect, and therefore a positive charge, for one of the lines of the trunk series of potassium, and E. Dorn⁵ has found the Doppler effect with a number of lines of helium, which contain representatives of the trunk series as well as of the two branch series. These facts do not countenance the view that there is an essential electric difference between the vibrating system of the three members of a family of series.

It is probable, however, that the above observations may

¹ *Phys. Zeitschrift* (1910), 11, p. 171.

² *Ann. d. Phys.* (1905), 17, p. 197.

³ *Phys. Zeitschrift* (1904), 8, p. 735.

⁴ *Ann. d. Phys.* (1906), 21, p. 457.

⁵ *Phys. Zeitschrift* (1907), 8, p. 589.

help to clear up some difficulties in the phenomena presented by flames. While we have seen that the radiation of sodium vapour has an intensity corresponding to that of the pure thermal radiation at the temperature of the flame, other flames not containing oxygen (e.g. the flames of chlorine in hydrogen) do not apparently emit the usual sodium radiation when a sodium salt is placed in them. In the light of our present knowledge we should look for the different behaviour in the peculiarity of the oxygen flame to ionize the metallic vapour.

14. *Fluorescence and Phosphorescence.*—When a simple periodic force acts on a system capable of oscillatory motion the ultimate forced vibration has a period equal to that of the impressed force, but the ultimate state is only reached theoretically after an infinite time, and if meanwhile the vibrating system suffers any perturbations its free periods will at once assert themselves. Applying the reasoning to the case of a homogeneous radiation traversing an absorbing medium, we realize that the mutual disturbances of the molecules by collision or otherwise must bring in the free period of the molecule whatever the incident radiation may be. It is just in this degradation of the original period that (according to the present writer) the main phenomenon of absorption consists.⁶ With most bodies the degradation goes on rapidly and the body mainly radiates according to its temperature, but there are cases in which these intermediate stages can be observed and the body seems then to be luminous under the influence of the incident radiation. Such bodies are said to be fluorescent, the degradation of motion towards that determined by its temperature gives rise to the law of Stokes, the fluorescent light being in nearly all cases of lower frequency than the incident light. With absorbing gases we should expect the degradation to proceed more slowly than with liquids, and hence the discovery of E. Wiedemann and Schmidt⁷ that the vapours of sodium and potassium are fluorescent, important as it was from an experimental point of view, caused no surprise. It is not possible here to enter into a detailed description of the phenomena of fluorescence (*q.v.*), though their importance from a spectroscopic point of view has been materially increased through the recent researches of Wood⁸ on the fluorescence of sodium vapour. After Wood and Moore had confirmed and extended the observations of Wiedemann and Schmidt and showed that the vibrating system of the fluorescent light seems identical with that observed by absorption in the fluted band spectrum, Wood excited the fluorescence by homogeneous radiation and discovered some remarkable facts. The fluorescent bands in this case appear to shift rapidly when the period of the incident vibration is altered, though the change may be small. The author, no doubt correctly, remarks that the shift does not indicate a change of frequency but a change of relative intensity, consisting of a great number of fine lines; when the maximum intensity of the distribution of light is altered, the appearance is that of a shift. It would probably not be difficult to imagine a mechanical system having a number of free periods which when set into motion by a forced vibration shows a corresponding effect. If the forced vibration is suddenly stopped, the free periods will appear but not necessarily with the same intensity when the period of the original forced vibration is altered. There cannot, however, be a question that, as R. W. Wood remarks, the careful investigation of these phenomena is likely to give us an insight into the mechanism of radiation.

Phosphorescence (*q.v.*) can only be here alluded to in order to draw attention to the phenomena studied by Sir William Crookes and others in vacuum tubes. When cathode rays strike certain substances, they emit a phosphorescent light, the spectroscopic investigation of which shows interesting effects which are important especially as indicating the influence of slight admixtures of impurities on the luminescence. It should be mentioned that the infra-red rays have a remarkable damping effect on the phenomena of phosphorescence, a fact which has

⁶ Schuster, *Theory of Optics*, p. 254.

⁷ *Wied. Ann.* (1896), 57, p. 447.

⁸ R. W. Wood and Moore, *Astrophys. Journ.* (1903), 18, p. 95; R. W. Wood and Moore, *Phil. Mag.* (1905), 10, p. 513.

been made use of by Becquerel in his investigations of infra-red radiations.

15. *Relationship between the Spectrum of an Element and that of its Compounds.*—In the present state of our knowledge we cannot trace any definite relationship between the spectrum of a compound body and that of its elements, and it does not even seem certain that such a relationship exists, but there is often a similarity between different compounds of the same element. The spectra, for instance, of the oxides and haloid salts of the alkaline earths show great resemblance to each other, the bands being similar and similarly placed. As the atomic weight of the haloid increases the spectrum is displaced towards the red.

It is in the case of the absorption spectra of liquids that we can most often discover some connexion between vibrations of a complex system and that of the simpler systems which form the complex. The most typical case in this respect is the effect of a solvent on the absorption spectrum of a solution. A. Kundt,¹ who initiated this line of investigation, came to the conclusion that the absorption spectra of certain organic substances like cyanin and fuchsin were displaced towards the red by the solvent, and that the displacement was the greater the greater the dispersive power of the solvent. This law cannot be maintained in its generality, but nevertheless highly dispersive substances like carbon bisulphide are always found to produce a greater shift than liquids of smaller dispersion like water and alcohol. In these cases the solvent seems to act like an addition to the mass of the vibrating system, the quasi-elastic forces remaining the same.

Dr J. H. Gladstone,² at an early period of spectroscopy, examined the absorption spectra of the solution of salts, each constituent of which was coloured. He concluded that generally but not invariably the following law held good: "When an acid and a base combine, each of which has a different influence on the rays of light, a solution of the resulting salt will transmit only those rays which are not absorbed by either, or, in other words, which are transmitted by both." He mentioned as an important exception the case of ferric ferrocyanide, which, when dissolved in oxalic acid, transmits the rays in great abundance, though the same rays be absorbed both by ferrocyanides and by ferric salts. Soret has confirmed, for the ultra-violet rays, Dr Gladstone's conclusions with regard to the identity of the absorption spectra of different chromates. The chromates of sodium, potassium and ammonium, as well as the bichromates of potassium and ammonium, were found to give the same absorption spectrum. Nor is the effect of these chromates confined to the blocking out simply of one end of the spectrum, as in the visible part, but two distinct absorption bands are seen, which seem unchanged in position if one of the above-mentioned chromates is replaced by another. Chromic acid itself showed the bands, but less distinctly, and Soret does not consider the purity of the acid sufficiently proved to allow him to draw any certain conclusions from this observation.

In many of these cases the observed facts might perhaps be explained by dissociation, the undissociated compound producing no marked effect on the spectra. In 1872 W. N. Hartley and A. K. Huntingdon examined by photographic methods the absorption spectra of a great number of organic compounds. The normal alcohols were found to be transparent to the ultra-violet rays, the normal fatty acids less so. In both cases an increased number of carbon atoms increases the absorption at the most refrangible end. The fact that benzene and its derivatives are remarkable for their powerful absorption of the most refrangible rays, and for some characteristic absorption bands appearing on dilution, led Hartley to a more extended examination of some of the more complicated organic substances. He determined that definite absorption bands are only produced by substances in which three pairs of carbon atoms are doubly linked together, as in the benzene ring. Subsequently³ he subjected the ultra-violet absorption of the alkaloids to a careful

investigation, and arrived at the conclusion that the spectra are sufficiently characteristic to "offer a ready and valuable means of ascertaining the purity of the alkaloids and particularly of establishing their identity."

We can only briefly refer to an important investigation of Sir William Abney and Colonel E. R. Festing, who examined the infra-red absorption of a number of substances. We may quote one of the principal conclusions at which they arrived:—

"An inspection of our maps will show that the radical of a body is represented by certain well-marked bands, some differing in position according as it is bonded with hydrogen, or a halogen, or with carbon, oxygen or nitrogen. There seem to be characteristic bands, however, of any one series of radicals between 1000 and about 1100, which would indicate what may be called the central hydrocarbon group, to which other radicals may be bonded. The clue to the composition of a body, however, would seem to lie between 700 and 1000. Certain radicals have a distinctive absorption about 700 together with others about 900, and if the first be visible it almost follows that the distinctive mark of the radical with which it is connected will be found. Thus in the ethyl series we find an absorption at 740, and a characteristic band, one edge of which is at 892 and the other at 920. If we find a body containing the 740 absorption and a band with the most refrangible edge commencing at 892, or with the least refrangible edge terminating at 920, we may be pretty sure that we have an ethyl radical present. So with any of the aromatic group; the crucial line is at 867. If that line be connected with a band we may feel certain that some derivative of benzene is present. The benzyl group shows this remarkably well, since we see that phenyl is present, as is also methyl. It will be advantageous if the spectra of ammonia, benzene, aniline and dimethyl aniline be compared, when the remarkable coincidences will at once become apparent, as also the different weighting of the molecule. The spectrum of nitrobenzene is also worth comparing with benzene and nitric acid. In our own minds there lingers no doubt as to the easy detection of any radical which we have examined, . . . and it seems highly probable by this delicate mode of analysis that the hypothetical position of any hydrogen which is replaced may be identified, a point which is of prime importance in organic chemistry. The detection of the presence of chlorine or bromine or iodine in a compound is at present undecided, and it may be well that we may have to look for its effects in a different part of the spectrum. The only trace we can find at present is in ethyl bromide, in which the radical band about 900 is curtailed in one wing. The difference between amyl iodide and amyl bromide is not sufficiently marked to be of any value."

The absorption spectra of cobalt and didymium salts also offer many striking examples of minor changes produced in spectra by combination and solution. (A. S.*)

Apparatus.—Spectroscopes may be divided into two classes: prism spectroscopes, with angular or direct vision, and grating spectroscopes; the former acting by refraction (*q.v.*), the latter by diffraction or interference. Angular prism spectroscopes are the commonest. Such an instrument consists of a triangular prism set with its refracting edge vertical on a rigid platform attached to a massive stand. The prism may be made of a dense flint glass or of quartz if the ultra-violet is to be explored, or it may be hollow and filled with carbon bisulphide, α -bromonaphthalene or other suitable liquid. Liquid prisms, however, suffer from the fact that any change of temperature involves a change in the refractive index of the prism. The stand carries three tubes: the collimator, observing telescope and scale telescope. The collimator has a vertical slit at its outer end, the width of which may be regulated by a micrometer screw; in some instruments one half of the slit is covered by a small total reflection prism which permits the examination of two spectra simultaneously. At the other end of the collimator there is a condensing lens for bringing the rays into parallelism. The observing telescope is of the ordinary terrestrial form. The scale telescope contains a graduated scale which is illuminated by a small burner; the scale is viewed by reflection from the prism face opposite the first refracting face. The power may be increased, but with a diminution of intensity, by using a train of prisms. Steinheil made an instrument of four prisms, each of which had, however, to be set in the position of minimum deviation by trial. In Browning's form the setting is automatic. The dispersion may be further increased by causing the rays to pass more than once through the prism or prisms. Thus, by means of a system of reflecting prisms, Hilger passed the dispersed rays six times through one prism, and, by similar means, Browning passed the rays first through the upper part of a train and then back through the lower part. Compound prisms are also employed. Rutherford devised one made of flint glass with two crown glass compensating prisms; whilst Thallon employed a hollow prism containing carbon bisulphide also compensated by flint glass prisms. In direct vision spectroscopes the refracting prisms and slit are in the observing

¹ *Wied. Ann.* (1878), 4, p. 34.

² *Phil. Mag.* (1857), 14, p. 418.

³ *Phil. Trans.* (1885), pt. ii.

telescope. The prisms are necessarily compound, and usually consist of flint glass with compensating prisms of crown. In all cases where compound prisms are used, the angles must be accurately calculated. Amici in 1860 devised such an instrument; an improved form by Jannsen was made up of two flint and three crown prisms, and in Browning's form there are three flint and four crown. Sorby and, later, Abbe, designed instruments on the same principle to be used in connexion with the microscope. By suitably replacing the ocular of the observing telescope in an angular vision spectroscopy by a photographic camera, it is possible to photograph spectra; such instruments are termed spectrographs. In grating spectroscopes both plane and concave gratings are employed in connexion with a collimator and observing telescope.

AUTHORITIES.—The standard work is H. Kayser, *Handbuch der Spectroscopie* (1900-1910, vol. v.). See also J. Landauer, *Spectrum Analysis* (Eng. trans. by J. B. Tingle, 1898); E. C. C. Baly, *Spectroscopy* (1905). For spectra see A. Hagerbach and H. Konin, *Atlas of Emission Spectra* (Eng. trans. by A. S. King, 1905); F. Exner and E. Haschek, *Wellenlängen-Tabellen* (1902-1904); W. M. Watts, *Index of Spectra*; also reports of B.A. Special Committee.

SPECULATION, a round game of cards at which any reasonable number can play. Each player contributes a stake to the pool, the dealer staking double. Three cards are dealt face downwards to each player; the top card of those left is turned up for trumps. Each player, beginning with the player on the dealer's left, turns up a card; if it is not a trump, or is a lower trump than the trump-card, the next player turns up one of his cards, and so on till a higher trump than the trump-card appears, the values being reckoned as at whist. The holder may sell this card to the highest bidder, or retain it. The turning-up proceeds till a still higher trump is found, but the holder of the original highest does not turn up till his card is beaten. The new card may then be sold. The dealer may not turn up till the trump-card has been beaten. The holder of the highest trump when all the hands have been exposed takes the pool. If the ace of trumps is the trump-card, the dealer takes the pool; if it is turned up during play, the hand is, of course, at an end. Variations of the game allow the purchase of unseen cards or hands, or of the trump-card, even before it is turned up. The cards used in one deal are not dealt again till the whole pack has been gradually dealt out; they are collected and shuffled by the "pone"—the player on the dealer's right—to be used when the pack is exhausted.

SPECULUM, the Latin word for a mirror, employed more particularly for a metallic mirror used in a reflecting telescope. In early instruments metallic mirrors, made from an alloy of copper and tin, with the addition of a little arsenic or other metals to increase the whiteness, were customarily employed, but they have now been displaced by the more convenient silver-on-glass mirror (see TELESCOPE). Various forms of specula are used in surgery for examining internal organs.

SPEEDING, JAMES (1808-1881), English author, editor of the works of Bacon, was born on the 26th of June 1808, in Cumberland, the younger son of a country squire. He was educated at Bury St Edmunds and Trinity College, Cambridge, where he took a second class in the classical tripos, and was junior optime in mathematics in 1831. In 1835 he entered the colonial office, but he resigned this post in 1841. In 1842 he was secretary to Lord Ashburton on his American mission, and in 1855 he became secretary to the Civil Service Commission; but from 1841 onwards he was constantly occupied in his researches into Bacon's life and philosophy. On the 1st of March 1881 he was knocked down by a cab in London, and on the 9th he died of erysipelas. His great edition of Bacon was begun in 1847 in collaboration with R. E. Ellis and D. D. Heath. In 1853 Ellis had to leave the work to Spedding, with the occasional assistance of Heath, who edited most of the legal writings. The *Works* were published in 1857-1859 in seven volumes, followed by the *Life and Letters* (1861-1874). Taken together these works contain practically all the material which exists in connexion with the subject, collected and weighed with the utmost care and impartiality. Spedding humorously emphasized his devotion to Bacon in the title of one of his non-Baconian works, *Reviews and Discussions, Literary, Political and Historical, not relating to Bacon* (1879); and his literary remains outside that one field are no longer of interest. But as a Baconian scholar he is not likely soon to be superseded.

SPEED, JOHN (1552-1629), English historian and cartographer, was born, according to Fuller, at Farringdon, Cheshire. He was the son of a London tailor, and followed his father's trade, being admitted member of the Merchant Taylors Company in 1580. He settled in Moorfields, where he built himself a house. He was enabled to give up his trade and to devote himself to antiquarian pursuits through the kindness of Sir Fulke Greville, whom Speed calls the "procurer of my present estate," and through his patron's interest he also received a "waiter's room in the custom-house." The results of the leisure thus secured to him appeared in 1611 in his *Theatre of the Empire of Great Britaine*, a series of fifty-four maps of different parts of England, which had already appeared separately, and in which he was helped by Christopher Saxton, John Norden and William White. To each map descriptive matter was attached. In 1611 also he published his *History of Great Britaine under the Conquests of the Romans . . . to . . . King James*. Speed acknowledges his obligations to the chief antiquaries and historians of his day. Sir Robert Cotton lent him manuscripts and coins, and is said to have revised the proofs for him; in heraldry he acknowledges the help of William Smith (1550?-1618); and he had valuable help from John Barkham (1572?-1642) and Sir Henry Spelman. Speed brought some historical skill to bear on the arrangement of his work, and although he repeated many of the errors of older chroniclers he added valuable material for the history of his country. He died in London on the 28th of July 1629.

Other maps of his, beside those in the *Theatre*, are in the British Museum. Another edition of the *Theatre* is *Theatrum Magnae Britanniae latine*, reddatum a P. Holland (London, folio, 1616). He wrote *Genealogies Recorded in Sacred Scriptures* (1611), and a similar work, *A Cloud of Witnesses* (1616). These passed through numerous editions, and were frequently prefixed to copies of the Bible. An account of Speed's descendants is to be found in Rev. J. S. Davies's *History of Southampton* (1883), which was founded on MS. material left by John Speed (1703-1781).

SPEETON BEDS, in English geology, a series of clays well exposed at Speeton, near Filey on the Yorkshire coast. Peculiar interest attaches to these beds for they are the principal representatives in Britain of the marine phase of the Lower Cretaceous system. The Speeton Clays pass downwards without break into the underlying Kimeridgian; they are capped by the Red Chalk, which may be regarded as the equivalent of the Upper Gault of southern England. These beds thus form a passage series between marine Jurassic strata and those belonging undoubtedly to the Cretaceous system; in this way they correspond with the Purbeck-Wealden rocks, which form a connecting link between *estuarine* Jurassic and Cretaceous strata.

Above the dark, bituminous, nodular shales with Kimeridge fossils at the base of the Speeton Clay comes the zone of *Belemnites lateralis* (34 ft.), with *Olcostephanus gravesiformis*, *O. rotula*, and species of *Hoplites* and *Oxynotoceras*; this is followed by the zone of *Belemnites jaculum*, with *B. cristatus*, *Olcostephanus (Astieria) astieri*, *O. (Simbirskites) inversus* and *O. (S.) Speetonensis* in ascending order; *Echinospatagus cordiformis*, a species found in the typical Neocomian area, also occurs in this zone. The next higher zone is that of *Belemnites brunsvicensis* (= *semicanaliculatus*) (100 ft.), with *B. Speetonensis*, *Hoplites deshayesii*, and *Amaltheus bicurvatus*. The topmost zone is characterized by *Belemnites minimus* with *Inoceramus concentricus* and *I. sulcatus*; it consists of a few feet of mottled clays. It appears, therefore, that while the lower portions of the Speeton Clay are the equivalents of the Wealden and perhaps of the Purbeck beds, the higher portions are the equivalents of the Lower Greensand and part of the Gault. In Lincolnshire the upper Speeton beds are represented by the Carstone and Tealby Limestone and Clay, and the lower Speeton by the Claxby Ironstone, Spilsby Sandstone and lower part of the Tealby clay. A similar faunal horizon is recognized in Heligoland and Russia.

See CRETACEOUS; NEOCOMIAN; KIMERIDGIAN; also G. W. Lamplugh, *Q.J.G.S.* (1889), xlv. (1896), lii.; *Rep. Brit. Assoc.* (1890); A. Pavlow and G. W. Lamplugh, *Bull. soc. imp. nat. Moscow* (1891), and *Q.J.G.S.* (1897), liii.

SPEKE, HUGH (1656-c. 1724), English writer and agitator, was a son of George Speke (d. 1690) of White Lackington, Somerset. The older Speke was a member of the Green Ribbon Club, the great Whig organization which was founded in 1675, and was a supporter of the duke of Monmouth, voting for the Exclusion Bill in 1681. Educated at St John's College, Oxford, Hugh Speke joined the Green Ribbon Club, and in 1683 he was put in prison for asserting that Arthur Capell, earl of Essex, another of Monmouth's supporters, had been murdered by the friends of the duke of York. He was tried and sentenced to pay a fine, but he refused to find the money, and remained in prison for three years, being in captivity during Monmouth's rebellion, in consequence of which his brother Charles was hanged at Ilminster. In prison Speke kept a printing-press, and from this he issued the *Address to all the English Protestants in the Present Army*, a manifesto written by the Whig divine Samuel Johnson (1649-1703), urging the soldiers to mutiny. In 1687 he was released, and in 1688 he served James II. as a spy in the camp of William of Orange. In December of this year a document, apparently official, was found by a London bookseller. This called upon the Protestants to disarm their Roman Catholic neighbours; it was freely circulated, and much damage was done to property in London before it was found that it was a forgery. It appears to have been the work of Speke, although this was not known until 1709, when he asserted his authorship in his *Memoirs of the Most Remarkable Passages and Transactions of the Revolution*. He afterwards issued these memoirs with modifications as *The Secret History of the Happy Revolution in 1688* (1715). After imploring both Anne and George I. to reward his past services, Speke died in obscurity before 1725.

SPEKE, JOHN HANNING (1827-1864), English explorer, discoverer of the source of the Nile, was born on the 4th of May 1827 at Jordans near Ilminster, Somersetshire. On his father's side he descended from the ancient Yorkshire family of Espec, a branch of which migrated to Somerset in the 15th century. His mother was a Miss Georgina Hanning, of Dillington Park, Somerset. Through his mother's influence with the duke of Wellington he obtained a commission in the Indian Army, which he entered in 1844. He served in Sir Colin Campbell's division in the Punjab campaigns, and acquired considerable repute both as a soldier and as a sportsman and naturalist. When on furlough Captain Speke had explored portions of the Himalayas, had crossed the frontier into Tibet and mapped part of its south-western districts; but his attention was at an early date turned to the great problems of African geography, and in 1854 he began his brief and brilliant African career by joining Captain (afterwards Sir) Richard Burton in an expedition into the interior of Somaliland, the incidents of which are narrated in *What led to the Discovery of the Source of the Nile* (London, 1864). In April 1854 the expedition was attacked by Somalis near Berbera, one officer being killed, Burton slightly, and Speke severely wounded. Invalided home, Speke shortly afterwards volunteered for the Crimea and served during the war with a regiment of Turks. In 1856 he accepted an invitation from Burton to join an expedition to verify the reports as to the existence of great lakes in east central Africa, and especially to try and find Lake Nyassa. The route to Nyassa was closed by the Arabs, and the travellers left Zanzibar in June 1857 by a more northerly route, which brought them by November to a place called Kazé in Unyamwezi. Here they learnt from an Arab trader that further inland were three great lakes—and Speke leapt to the conclusion that the most northerly of the three would prove to be the source of the Nile. Continuing westward in January 1858 the travellers reached Lake Tanganyika, of which they made a partial exploration, Speke marking on his map the mountains which close in the lake to the north, "Mountains of the Moon." By June they were back at Kazé, and here Speke induced his chief, who was ill, to allow him to attempt to reach the northern lake. Marching north for twenty-five days, on the 30th of July Speke reached a creek, along which he travelled till, on the 3rd of August, he saw it open up into the waters of a lake extending northward to the

horizon. He no longer doubted that this lake—the Victoria Nyanza—was the source of the Nile. Returning to Kazé (August 25) he made known his discovery to Burton, who did not believe Speke's theories. The explorers reached Zanzibar early in 1859, Speke hastened back to England in advance of his comrade, and at once made public his discoveries and conclusions. Despite the scepticism of his fellow traveller and many geographers, he secured the support of Sir Roderick Murchison, president of the Royal Geographical Society, under whose direction a new expedition, expressly intended to solve the Nile problem, was fitted out. Of this expedition Speke had the command, his only European companion being Captain (afterwards Colonel) J. A. Grant (*q.v.*). The expedition, over 200 men all told, started from Zanzibar in October 1860 and reached Kazé on the 24th of January 1861. Despite illness and the hostility and extortions of the natives the Victoria Nyanza was again reached, at its south-west corner, in October 1861. Following the western shores of the lake Speke crossed the Kagera on the 16th of January 1862, and arrived at the capital of Uganda on the 19th of February following. Here he was detained by the king, Mtesa, for some months, but at last prevailed on the chief to furnish him with guides, and on the 28th of July Speke stood at the spot where the Nile issued from the lake. The great discovery was made, the problem which had baffled all previous efforts—extending over 2000 years—was solved. The troubles of the travellers were, however, by no means over; with difficulty they obtained permission to enter Unyoro, and with difficulty were allowed to leave, without being permitted to visit another large lake (the Albert Nyanza) of whose existence and connexion with the Nile they learned. As far as possible Speke and Grant followed the course of the Nile, and on the 3rd of December came in touch with the outside world once more, striking in 3° 10' 37" N. an outpost established at the request of John Petherick, British consul at Khartum, who had been charged with a mission for the relief of the explorers. On the 15th of February 1863 they arrived at Gondokoro, the Egyptian post on the Nile marking the limit of navigability from the north. At Gondokoro they met Sir Samuel (then Mr) Baker, generously giving him the information which enabled him to discover the Albert Nyanza. From Khartum Speke telegraphed to London the great news that the Nile had been traced to its source, and on his return to England he was received with much enthusiasm. In the same year (1863) he published his *Journal of the Discovery of the Source of the Nile*, a work full of geographical, ethnological and zoological information, and written in a frank, attractive style. The accuracy of his observations and the correctness of his main deductions have been since abundantly justified. But as Speke had not been able to follow the Nile the whole way from the Victoria Nyanza to Gondokoro, and as the part played in the Nile régime by the Albert Nyanza was then unknown, Burton and others remained unconvinced, and Speke's conclusions were criticized in *The Nile Basin* (1864), a joint production of Burton and James McQueen; it being argued in this work that Tanganyika was the true Nile source. It was arranged that Speke should meet Burton at the meeting of the geographical section of the British Association at Bath on the 16th of September and publicly debate the question of the Nile source. On the previous afternoon Speke was out partridge shooting at Box, near Bath. In getting over a low stone wall he laid down his gun at half cock. Drawing the weapon towards him by the muzzle one barrel exploded and entered his chest, inflicting a wound from which Speke died in a few minutes. A granite obelisk to his memory was erected by public subscription in Kensington Gardens.

See, besides the works mentioned, Sir R. F. Burton, *The Lake Regions of Central Africa* (London, 1860); J. A. Grant, *A Walk across Africa* (London, 1864); T. D. Murray and A. S. White, *Sir Samuel Baker: a Memoir* (London, 1895); *The Times* (Sept. 17 and 19, 1864); Sir H. H. Johnston, *The Nile Quest* (London, n. d. [1903]).

SPELLING BEE, a match in which two sides contest in accuracy of spelling. The custom, an old one, was revived in the schools of the United States about the year 1873, and rapidly spread

throughout the country and to Great Britain, enjoying for a few years an extraordinary vogue, not only in schools, but in all classes and ages of society. In the United States inter-city and inter-state matches were not unknown. According to the generally recognized rules a competitor who misspelled a word retired, and the match was won by the side having the greatest number of survivors at the close. The use of the word "bee" as an assemblage of persons for the purpose of joint work or play originated in America in colonial times, and was taken from the labour of the bees of a hive. Familiar examples of it are *husking-bee* and *quilting-bee*, assemblages of villagers for the purpose of helping a neighbour with the husking of the corn or his wife with her quilt-making.

SPELLO (anc. *Hispellum*, *q.v.*), a town of Umbria, in the province of Perugia, from which it is 22 m. S.E. by rail, 1030 ft. above sea-level. Pop. (1901), 5571. It is picturesquely situated on the slope of a mountain. The Cappella Baglioni in the church of S. Maria Maggiore contains some of Pinturicchio's finest frescoes (1501), "The Annunciation," "The Adoration" and "Christ in the Temple." The rich background with gold decoration in relief is characteristic. There is also a late altarpiece by Perugino (1521) and a fine early Renaissance canopy by Rocco da Vicenza (1515). In the sacristy is a crucifix in silver by Paolo Vanni of Perugia (1398). The holy-water basin is formed of a sepulchral *cippus* of the Roman period. S. Andrea contains a large altarpiece by Pinturicchio (1508), upon which a letter from G. Baglioni to the artist is painted.

See G. Urbini, in *L'Arte* (1897), ii. 367 sqq., (1898), iii. 16 sqq.

SPELMAN, SIR HENRY (c. 1564–1641), English antiquary, was the eldest son of Henry Spelman, of Congham, Norfolk, and the grandson of Sir John Spelman (c. 1495–1544), judge of the king's bench. Born probably in 1564, he was educated at Walsingham School, and proceeded in 1580 to Trinity College, Cambridge, where he took his degree in 1583. His father had died in 1581, and on Spelman devolved the management of the family estates. He became a member of Lincoln's Inn, but in 1590 he returned to Norfolk, where he married Eleanor l'Estrange. He became guardian to his brother-in-law, Sir Hamon l'Estrange, on whose property at Hunstanton he resided for some time. He occupied himself with the history and antiquities of his native county, writing an account of Norfolk for John Speed's *Theatre of Great Britaine*. He belonged to the Society of Antiquaries, of which Sir Robert Cotton and William Camden were also members. The society gradually declined, and Spelman's efforts to revive it in 1614 were frustrated by James I. Having bought in 1594 the remainder of the two leases of two abbeys of which the Crown was the lessor, he became involved in prolonged litigation over them, and a judgment given against him by Bacon makes it interesting to find Spelman subsequently among the petitioners who alleged corruption against the lord chancellor. His experience in this process no doubt combined with a scandal connected with a church and parsonage in the possession of his uncle Francis Sanders to occasion his pamphlet *De non temerandis ecclesiis* (1613–1616), which induced many lay owners of ecclesiastical spoils to make restitution, and Spelman himself acted accordingly. This tract led up to his *History and Fate of Sacrilege*,¹ which was in the hands of the printer when the Great Fire broke out. The book was supposed to have perished, but Bishop Gibson discovered part of it in the Bodleian Library. It was printed, not, however, under his editorship, in 1698, with the statement on the title-page that it was "wrote in 1632." Spelman had conceived the idea of a work on the foundations of English law, based on early charters and records, but finding that there were no adequate means of determining the exact meaning of the Anglo-Saxon and Latin law terms employed in the documents, he began to compile a glossary, the first volume of which, *Archaeologus in modum glossarii*, was published at his own expense in 1626. He continued to work at the subject until 1638. A second volume, *Glossarium archaologicum* (1664), appeared after his death. His *Codex legum veterum statutorum*

¹ This was re-edited as late as 1895, with an appendix bringing the subject up to date, by C. F. S. Warren.

regni Angliae, quae ab ingressu Gulielmi I usque ad annum nonum Henry III. edita sunt was published by David Wilkins in his *Leges anglo-saxonicae* (1721). Spelman's most important work, *Concilia, decreta, leges, constitutiones in re ecclesiarum orbis britannici*, is an attempt to place English church history on a basis of genuine documents. The first volume, which occupied him seven years, came down to 1066 and was published in 1636. A second volume was edited by Sir William Dugdale in 1664. Spelman entered parliament as member for Castle Rising in 1597, and in 1604 was high sheriff of his county. In 1612 he settled in London near his friend Sir Robert Cotton. In 1617 he served on a commission to inquire into disputed Irish estates, and later took part in three legal inquiries into the exactions levied on behalf of the Crown in the civil and ecclesiastical courts. He was member of parliament for Worcester in 1625. In 1627 he became treasurer of the Guiana Company, and he was also an energetic member of the council for New England. His general services to the state were recognized in 1636 by a gift of money, and two years later by the offer of the mastership of Sutton's Hospital, Charterhouse. He died in London in October 1641, and was buried in Westminster Abbey. His later years had been spent in the house of his son-in-law, Sir Ralph Whitfield.

His son, Sir John Spelman (1594–1643), also gained a reputation as a scholar and antiquary. He was knighted in 1641 and served the king actively at the beginning of the Civil War. He edited from MSS. in his father's library *Psalterium Davidis latino-saxonicum vetus* (1640), and wrote a Life of Alfred the Great which was translated into Latin and published in 1678.

Edmund Gibson, bishop of London, published in 1723 *The English Works of Sir Henry Spelman, Kt., Published in his Lifetime; together with his Posthumous works relating to the Laws and Antiquities of England*. The first section contained *De non Temerandis Ecclesiis*, already mentioned; *The Larger Treatise concerning Tythes*, first published in 1646; *De sepultura*; and *Villare anglicum, or a View, of the Towns of England*; while the second included *The Original, Growth, Propagation and Condition of Feuds and Tenures by Knight-service in England*, written in 1639; *Two Discourses: i. Of the Ancient Government of England, ii. Of Parliaments*; *The Original of the Four Terms of the Year*, written in 1614 and first printed in 1684; *Icenia*: a Latin description of Norfolk, and some other treatises. This was a revised edition of an earlier collection (1698), and contained a life of the author, based chiefly on the autobiographical matter prefixed to the Glossary of 1626, and two additional papers, *Of the Admiral Jurisdiction, and the Officers thereof*, and *Of Antient Deeds and Charters*. Wilkins's edition of his *Concilia* was edited by A. W. Haddan and W. Stubbs in 1869–1873.

SPENCE, THOMAS (1750–1814), inventor of a system of land nationalization, was born at Newcastle-on-Tyne on the 21st of June 1750, the son of a Scottish netmaker and shoemaker. A dispute in connexion with common land rights at Newcastle impelled him to the study of the land question. His scheme was not for land nationalization proper, but for the establishment of self-contained parochial communities, in which rent paid to the corporation, in which the absolute ownership of the land was vested, should be the only tax of any kind. His pamphlet, *The Meridian Sun of Liberty*, which was first hawked in Newcastle, appeared in London in 1793; it was reissued by Mr H. M. Hyndman under the title of *The Nationalization of the Land in 1775 and 1882*. Spence presently left Newcastle for London, where he kept a bookstall in High Holborn. In 1784 he spent six months in Newgate gaol for the publication of a pamphlet distasteful to the authorities, and in 1801 he was sentenced to twelve months' imprisonment for seditious libel in connexion with his pamphlet entitled *The Restorer of Society to its Natural State*. He died in London on the 8th of September 1814. His admirers formed a "Society of Spencean Philanthropists," of which some account is given in Harriet Martineau's *England During the Thirty Years' Peace*.

See also Davenport, *Life, Writings and Principles of Thomas Spence* (London, 1836).

SPENCER, HERBERT (1820–1903), English philosopher, was born at Derby on the 27th of April 1820. His father, William George Spencer, was a schoolmaster, and his parents' religious convictions familiarized him with the doctrines of the

Methodists and Quakers. He declined an offer from his uncle, the Rev. Thomas Spencer, to send him to Cambridge, and so was practically self-taught. During 1837-1846 he was employed as an engineer on the London & Birmingham railway; 1848-1853 as sub-editor of the *Economist*. From about this time to 1860 he contributed a large number of articles to the *Westminster Review*, which contain the first sketches of his philosophic doctrines. He also published two larger works, *Social Statics* in 1850, and *Principles of Psychology* in 1855. In 1860 he sent out the syllabus of his *Synthetic Philosophy* in ten volumes, and in spite of frequent ill health had the satisfaction of completing it in 1896 with the third volume of the *Principles of Sociology*. He died on the 8th of December 1903.

Herbert Spencer's significance in the history of English thought depends on his position as the philosopher of the great scientific movement of the second half of the 19th century, and on the friendship and admiration with which he was regarded by men like Darwin, G. H. Lewes and Huxley. Spencer tries to express in a sweeping general formula the belief in progress which pervaded his age, and to erect it into the supreme law of the universe as a whole. His labours coincided in time with the great development of biology under the stimulus of the Darwinian theory, and the sympathizers with the new views, feeling the need of a comprehensive survey of the world as a whole, very widely accepted Spencer's philosophy at its own valuation, both in England and, still more, in America. In spite of this, however, his heroic attempt at a synthesis of all scientific knowledge could not but fall short of its aim. Living at the commencement of an epoch of unparalleled scientific activity, Spencer could not possibly sum up and estimate its total production. To the specialists in sciences which were advancing rapidly and in divergent directions to results which often reacted on and transformed their initial assumptions, Spencer has often appeared too much of a philosopher and defective in specialist knowledge. To the technical philosophers, who strictly confine themselves to the logical collation and criticism of scientific methods, he has, contrariwise, not seemed philosophic enough. Hence his doctrines were open to damaging attacks from both sides, the more so as he always stood aloof from the academic spirit and its representatives. It seems unlikely, therefore, that as a system the *Synthetic Philosophy* will prove long-lived; but this hardly detracts from its fruitfulness as a source of suggestion, or from the historic influence of many of its conceptions on the culture of the age.

This estimate of Spencerian philosophy may be substantiated by a brief survey of its origin and leading characteristics. Spencer claims, with some reason, that he was always an evolutionist. But his notions of what "evolution" is developed quite gradually. At first he seems to have meant by the word only the belief that progress is real, and that the existing order of nature is the result of a gradual process and not of a "special creation." In *Social Statics* (1850) he still regards the process teleologically, and argues after the fashion of Paley that "the greatest happiness is the purpose of creation" (ch. iii. § 1), and that to "gag the moral sentiment" is "to balk creative design" (ch. xxxii. § 7). But this phraseology soon disappears, without his considering how, in default of some sort of teleology, it is legitimate to treat the world's history as a process. In *The Development Hypothesis* (1852) he objects strongly to the incredibility of the special creation of the myriad forms of life, without, however, suggesting how development has been effected. In *Progress, its Law and Cause* (1857) he adopted Von Baer's law, that the development of the individual proceeds from the homogeneous to the heterogeneous. This is at once connected with the nebular hypothesis, and subsequently "deduced" from the ultimate law of the "persistence of force," and finally supplemented by a counter-process of dissolution, all of which appears to Spencer only as "the addition of Von Baer's law to a number of ideas that were in harmony with it." It is clear, however, that Spencer's ideas as to the nature of evolution were already pretty definite when Darwin's *Origin of Species* (1859) revolutionized the subject of organic evolution

by adding natural selection to the direct adaptation by use and disuse, and so suggesting an intelligible method of producing modifications in the forms of life. Spencer welcomed the Darwinian theory, and enriched it with the phrase "survival of the fittest"; but he did not give up the (Lamarckian) belief in the hereditary transmission of the modifications of organisms by the exercise of function. Shortly afterwards (1860) he sent out the prospectus of a systematic exposition of his *Synthetic Philosophy*, of which the first volume, *First Principles*, appeared in 1862. This work is divided into two parts; the first intended to show that while ultimate metaphysical questions are insoluble they compel to a recognition of an inscrutable Power behind phenomena which is called the Unknowable; the second devoted to the formulation and illustration of the Law of Evolution. In the first part Spencer's argument rests on Mansel's *Limits of Religious Thought* and Hamilton's "philosophy of the conditioned" (and so ultimately on Kant), and tries to show that alike in scientific and religious thought the ultimate terms are "inconceivable" (not by him distinguished from "unimaginable"). In science, the more we know the more extensive "the contact with surrounding nescience." In religion the really vital and constant element is the sense of mystery. This is illustrated by the difficulties inherent in the conception of Cause, Space, Time, Matter, Motion, the Infinite, and the Absolute, and by the "relativity of knowledge," which precludes knowledge of the Unknowable, since "all thinking is relating." Yet the Unknowable may exist, and we may even have an "indefinite knowledge" of it, positive, though vague and extralogical. Hence both science and religion must come to recognize as the "most certain of all facts that the Power which the Universe manifests to us is utterly inscrutable." Thus to be buried side by side in the Unknowable constitutes their final reconciliation, as it is the refutation of irreligion which consists of "a lurking doubt whether the Incomprehensible is really incomprehensible."

Such are the foundations of Spencer's metaphysic of the Unknowable, to which he resorts in all the fundamental difficulties which he subsequently encounters. Whatever its affinities with that version of "faith" which regards it as antagonistic to knowledge, it can hardly be deemed philosophically satisfactory. A failure to solve the problems of metaphysics must always remain a failure, in spite of all protestations that it was inevitable; and it in no wise justifies an advance to so self-contradictory an *asylum ignorantiae* as the Unknowable. In the edition of his *First Principles*, published in 1900, Spencer adds a "postscript" which shows some consciousness of the contradiction involved in his knowledge of the Unknowable, and finally contends that his account of the Knowable in part ii. will stand even if part i. be rejected. Even this, however, understates the case, seeing that a really inscrutable Unknowable would destroy all confidence in the order of nature and render all knowledge entirely precarious.

In part ii. Spencer recognizes successively likenesses and unlikenesses among phenomena (the effects of the Unknowable), which are segregated into manifestations, vivid (object, non-ego) or faint (subject, ego), and then into space and time, matter and motion and force, of which the last is symbolized for us by the experience of resistance, and is that out of which our ideas of matter and motion are built. Hence the Persistence of Force is the ultimate basis of knowledge. From it Spencer proceeds to deduce the indestructibility of matter and energy, the equivalence and transformation of forces, the necessity of a rhythm, of Evolution (*i.e.* integration of matter with concomitant dissipation of motion) and Dissolution, and finally reaches the statement of the Law of Evolution as "an integration of matter and concomitant dissipation of motion, during which the matter passes from an indefinite incoherent homogeneity to a definite coherent heterogeneity, and during which the retained motion undergoes a parallel transformation." This process of evolution is due to "the instability of the homogeneous," the "multiplication of effects" and their "segregation," continuing until it ceases in complete "equilibration." Sooner

or later, however, the reverse process of Dissolution, with its absorption of motion and disintegration of matter, which indeed has always been going on to some extent, must prevail, and these oscillations of the cosmic process will continue without end.

It appears, therefore, that Spencer ultimately describes the Knowable in terms of the mechanical conceptions of matter and motion, and that this must give a materialistic colouring to his philosophy. There are, however, other flaws also in his procedure. The presence of Force, *i.e.* his version of the methodological assumption of constancy in the quantitative aspects of phenomena, seems a very unsuitable basis for a philosophy of progress. To such a philosophy a consideration of the conditions, if any, under which progress can be conceived as ultimately real, seems a necessary preliminary, which Spencer omits. He also assumes that "Evolution" is a real, nay, an ultimate law of nature, but his evidence only goes to show that it is a result, in some cases, of the complex interaction of laws, which, like Rhythm, Segregation, &c., are in their turn only tendencies, and may be, and often are, counteracted. By the afterthought of a "dissolution" process (2nd ed. of *First Principles*) Spencer in a way admits this, but introduces fresh difficulties as to its relation to "Evolution." If the two processes go on together both are tendencies, and whether there is on the whole progress or not will depend on their relative strength; neither can be universal, nor the "law" of cosmic existence, unless its coexisting rival is regarded as essentially secondary. But if so it ceases to be available as evidence of a coming reversal of the dominant process. If, on the other hand, the processes are strictly alternative, a world which *ex hypothesi* exemplifies the one can never justify us in inferring the other. Spencer appeals alternately to the "instability of the homogeneous" and the impossibility of complete equilibration to keep up the cosmic see-saw, but he can do so only by confining himself to a *part* of the universe. A world *wholly* homogeneous or equilibrated could no longer change, while so long as a part only is in process, the process cannot be represented as universal. Again, an infinite world cannot be *wholly* engaged either in evolution or in dissolution, so that it is really unmeaning to discuss the universality of the cosmic process until it is settled that we have a universe at all, capable of being considered as a whole. In the last resort, therefore, Spencer fails to deduce philosophically not only the necessity of progress, but also its compatibility with the evolution-dissolution oscillation, and even the general possibility of conceiving the world as a process. In other words, in spite of his intentions he does not succeed in giving a metaphysic of evolutionism.

In the *Principles of Biology* the most notable points are the definition of life as the continuous adjustment of internal to external relations, and the consequent emphasis on the need of adapting the organism to its environment. This exaggerates the passivity of life, and does not sufficiently recognize that the higher organisms largely adjust external to internal relations and adapt their environment to their needs. His universal process of Evolution seems to give Spencer a criterion of "higher" and "lower" "progression" and "degeneration," independent of the accidents of actual history, and unattainable by strictly Darwinian methods. The higher (at least in times of "evolution") is the more complex and differentiated, whether it invariably survives or not. On the other hand, he advances too easily from the maxim that function is prior to, and makes, structure to the conclusion that the results of use and disuse are therefore immediately incarnated in structural adaptations capable of hereditary transmission. This inference has involved him in much controversy with the ultra-Darwinians of Weismann's school, who deny the possibility of the inheritance of acquired characteristics altogether. And though Spencer's general position—that it is absurd to suppose that organisms after being modified by their life should give birth to offspring showing no traces of such modifications—seems the more philosophic, yet it does not dispose of the facts which go to show that most of the evidence for the direct transmission of adaptations

is illusory, and that beings are organised to minimize the effects of life on the reproductive tissues, so that the transmission of the effects of use and disuse, if it occurs, must be both difficult and rare—far more so than is convenient for Spencer's psychology.

In his *Principles of Psychology* Spencer advocates the genetic explanation of the phenomena of the adult human mind by reference to its infant and animal ancestry. On the fundamental question, however, of the psychophysical connexion and the derivation of mind from matter, his utterances are neither clear nor consistent. On the one hand, his whole formulation of Evolution in mechanical terms urges him in the direction of materialism, and he attempts to compose the mind out of homogeneous units of consciousness (or "feeling") "similar in nature to those which we know as nervous shocks; each of which is the correlative of a rhythmical motion of a material unit or group of such units" (§ 62). On the other hand, when pressed by his disciple, Fiske (*Outlines of Cosmic Philosophy* ii. p. 444), he is ready to amend *nervous* into *psychical* shocks, which is no doubt what he ought to have meant but could not say without ruining the illusory bridge between the psychical and the physiological which is suggested in the phrase "nervous shock." And he admits (§ 63) that if we were compelled to choose between translating mental phenomena into physical and its converse, the latter would be preferable, seeing that the ideas of matter and motion, merely symbolic of unknowable realities, are complex states of consciousness built out of units of feeling. But easiest of all is it to leave the relation of the unknowable "substance of Mind" to the unknowable "substance of Matter" (substance he throughout conceives as the unknowable substrate of phenomena) to the Unknowable, as he finally does. To the theory of knowledge Spencer contributes a "transfigured realism," to mediate between realism and idealism, and the doctrine that "necessary truths," acquired in experience and congenitally transmitted, are a priori to the individual, though a posteriori to the race, to mediate between empiricism and apriorism. It has already been explained, however, that the biological foundations of the latter doctrine are questionable.

In the *Principles of Sociology* Spencer's most influential ideas have been that of the social organism, of the origination of religion out of the worship of ancestral ghosts, of the natural antagonism between nutrition and reproduction, industrialism and warfare. Politically, Spencer is an individualist of an extreme *laissez faire* type, and it is in his political attitude that the consequences of his pre-Darwinian conception of Evolution are most manifest. But for this he would hardly have established so absolute an antithesis between industrial and military competition, and have shown himself readier to recognize that the law of the struggle for existence, just because it is universal and equally (though differently) operative in every form of society, cannot be appealed to for guidance in deciding between the respective merits of an industrial or military and of an individualist or socialist organization of society.

In the *Principles of Ethics* Spencer, though relying mainly on the objective order of nature and the intrinsic consequences of actions for the guidance of conduct, conceives the ethical end in a manner intermediate between the hedonist and the evolutionist. The transition from the evolutionist criterion of survival—which in itself it is difficult to regard as anything but non-moral—to the criterion of happiness is effected by means of the psychological argument that pleasure promotes function and that living beings must, upon pain of extinction, sooner or later take pleasure in actions which are conducive to their survival. Hence pleasure is, on the whole, good, and asceticism reprehensible, although in man's case there has arisen (owing to the rapidity of evolution) a certain derangement and divergence between the pleasant and the salutary (§ 39). Nevertheless pleasure forms an "inexpugnable element" of the moral aim (§ 16). Conduct being the adjustment of acts to ends, and good conduct that which is conducive to the preservation of a pleasurable life in a society so adjusted that each attains his happiness without impeding that of others, life can be

considered valuable only if it conduces to happiness. On the other hand, life must in the long run so conduce, whatever its present value may appear to be, because a constant process of adjustment is going on which is bound sooner or later to lead to a complete adjustment which will be perfect happiness. This is the refutation of pessimism, which ultimately agrees with optimism in making pleasure the standard of value. In this reasoning Spencer appears to have overlooked the possibility of an expansion of the ethical environment. If this is as rapid as (or more rapid than) the rate of adaptation, there will be no actual growth of adaptation and so no moral progress. Complete adaptation to an infinitely receding ideal is impossible, and relative adaptation depends on the distance between the actual and the ideal. Spencer, however, considers that he can not only anticipate such a state of complete adjustment, but even lay down the rules obtaining in it, which will constitute the code of "Absolute Ethics" and the standard for discerning the "least wrong" actions of relative ethics. He conceives it as a state of social harmony so complete that in it even the antagonism between altruism and egoism will have been overcome. Both of these are original and indispensable, but egoism has the priority, since there must be egoistic pleasure somewhere before there can be altruistic sympathy with it. And so in the ideal state everyone will derive egoistic pleasure from doing such altruistic acts as may still be needed. In it, too, the sense of duty will have become otiose and have disappeared, being essentially a relic of the history of the moral consciousness. Originally the socially salutary action was in the main that which was enjoined on the individual by his political and religious superiors and by social sentiment; it was also in the main that to which his higher, more complex and re-representative feelings prompted. Hence the fear with which the political, religious and social controls were regarded came to be associated also with the specifically moral control of lower by higher feelings, and engendered the coercive element in the feeling of obligation. Its authoritativeness depends on the intrinsic salutariness of self-control, and must cease to be felt as the resistance of the lower feelings relaxes. Hence Spencer concludes that the sense of duty is transitory and must diminish as moralization increases. In the preface to the last part of his *Ethics* (1893) Spencer regrets that "the Doctrine of Evolution has not furnished guidance to the extent he had hoped," but his contributions to ethics are not unlikely to be the most permanently valuable part of his philosophy.

After completing his system (1896) Spencer continued to revise it, and brought out new editions of the *Biology* (1898-1899) and *First Principles* (1900). The dates of his chief works are as follows: 1842, *Letters to the Nonconformist*, "The Proper Sphere of Government." 1850, *Social Statics*. 1852, *The Theory of Population* (cf. part vi. of *Biology*); "The Development Hypothesis" (in *Essays*, vol. i.) 1853, *The Universal Postulate* (cf. *Psychology*, part vii.). 1854, "the Genesis of Science" (in *Essays*, vol. ii.). 1855, *Principles of Psychology* (1 vol.). 1857, *Progress, its Law and Cause* (*Essays*, vol. i.). 1858, *Essays* (containing most of his contributions to the *Westminster Review*; 1863, vol. ii.; 1885, vol. iii.). 1861, *Education: Intellectual, Moral, Physical*. 1862, *First Principles* (2nd ed., 1867; 6th, 1900). 1864-1867, *Principles of Biology* (2 vols.). 1872, *Principles of Psychology* (2nd ed., in 2 vols.). 1873, *The Study of Sociology*. 1876, vol. i., *The Principles of Sociology*; vol. ii., *Ceremonial Institutions*, 1879, *Political Institutions*, 1882; vol. iii., *Ecclesiastical Institutions*, 1885, completed 1896. 1879, *The Data of Ethics* (part i. of *Principles of Ethics* in 2 vols.; part iv., *Justice*, 1891; parts ii. and iii., *Inductions of Ethics and Ethics of Individual Life*, 1892; parts v. and vi., *Negative and Positive Beneficence*, 1893). 1884, *Man versus the State*. 1886, *Factors of Organic Evolution*. 1893, *Inadequacy of Natural Selection*. 1894, *A Rejoinder to Professor Weismann and Weismannism once more*. 1897, *Fragments*. 1902, *Facts and Comments*. An *Autobiography* in 2 vols. appeared posthumously in 1904. For a full bibliography of his works see W. H. Hudson's *Introduction to the Philosophy of Herbert Spencer* (up to 1895); and for a useful summary of his chief doctrines by Spencer himself, his preface to Collins's *Epitome of the Synthetic Philosophy*. He also supervised the compilation of a comprehensive series of volumes by various writers on *Descriptive Sociology*, of which by 1881 eight parts on different racial areas had been published (at a loss to him of £3250) as the result of fourteen years of labour. He then suspended this undertaking, but resolved that at his death it should be continued at the cost of his estate.

In his will he appointed trustees, who were to entrust the supervision to Mr. H. R. Tedder, librarian of the Athenaeum Club; and the work was resumed accordingly after his death, five more parts being arranged for, one of which was published in 1910. (F. C. S. S.)

SPENCER, JOHN CHARLES SPENCER, 3RD EARL (1782-1845), English statesman, better known by the courtesy title of Lord Althorp, which he bore during his father's lifetime, was the son of George John, 2nd Earl (1758-1834), grandson of John (1734-1783), created 1st Earl Spencer in 1765, and great-grandson of Charles Spencer, 3rd Earl of Sunderland. His father served in the ministries of Pitt, Fox and Grenville, and was first lord of the admiralty from 1794-1801; and his interest in literature was shown in his attention to the Althorp library, inherited from the 3rd Earl of Sunderland, which he developed into the finest private library in Europe; his wife, the eldest daughter of the 1st Earl Lucan, was conspicuous in London society for her gaiety and brightness. Their eldest son, John Charles, was born at Spencer House, London, on the 30th of May 1782. In 1800 he took up his residence at Trinity College, Cambridge, and for some time applied himself energetically to mathematical studies; but he spent most of his time in hunting and racing. Almost immediately after taking his degree in 1802, he set out on a continental tour, which was cut short, after he had passed some months in the chief cities in Italy, by the renewal of war. Through the influence of Pitt's government he was returned to parliament for the borough of Okehampton in Devonshire in April 1804, and, although he vacated his seat in February 1806, to contest the university of Cambridge against Lord Henry Petty and Lord Palmerston (when he was hopelessly beaten), he was elected in the same month for St Albans, and appointed a lord of the treasury. At the general election in November 1806, he was elected for Northamptonshire, and he continued to sit for the county until he succeeded to the peerage. His tastes were then, as ever, for country life, but his indignation at the duke of York's conduct at the Horse Guards led him to move a resolution of the House of Commons in 1809 for the duke's removal from his post. For the next few years after this speech Lord Althorp occasionally spoke in debate and always on the side of Liberalism, but from 1813 to 1818 he was only rarely in the House of Commons. His absence was partly due to a feeling that it was hopeless to struggle against the will of the Tory ministry, but more particularly to his marriage on the 14th of April 1814, to Esther, only daughter of Richard Acklom of Wiseton Hall, Northamptonshire, who died in childbirth 1818. In 1819, on his return to political life after her death, and for many years after that date he pressed upon the attention of the house the necessity of establishing a more efficient bankruptcy court, and of expediting the recovery of small debts; and he saw both these reforms accomplished before 1825. During the greater part of the reign of George IV. the Whigs lost their legitimate influence in the state from their want of cohesion, but this defect was soon remedied in 1830 when Lord Althorp was chosen their leader in the lower house, and his capacity for the position was proved by experience. When Lord Grey's administration was formed at the close of the year the chancellorship of the exchequer combined with the leadership of the House of Commons was entrusted to Lord Althorp, and to him more than to any other man, with the exception of the prime minister and the lord chancellor, may be attributed the success of the government measures. The budget, it is true, was a failure, but this misfortune was soon forgotten in the struggles over the Reform Bill. The consideration of the preliminaries of this measure was assigned to four ministers, two in the cabinet and two outside that body; but their proposals were, after careful examination, approved or rejected by Lord Grey and Lord Althorp before they were brought under the notice of the cabinet. When the Bill was ready for introduction to the House of Commons its principles were expounded by Lord John Russell; but from the commencement of the protracted discussion over its details he had the assistance of Lord Althorp, and after some

weeks of incessant toil, which the physique of Lord John Russell could not sustain any longer, the whole responsibility was cast on Lord Althorp. To combat the objections of three such pertinacious opponents as Croker, Sugden and Wetherell required both skill and courage, and in Lord Althorp these qualities were found. On one evening he made as many as twenty speeches. The Reform Bill was carried at last, and popular instinct was right in assigning to the leader of the house a credit only second to that earned by Lord John Russell. After the dissolution of 1833 the Whigs returned to power with augmented numbers; but differences soon showed themselves among both leaders and followers, and their majority crumbled away. Their position was strengthened for a time by triumphantly carrying a new poor law bill; and even their keenest critics would not allow that, had the Whig propositions on tithes and church rates been carried into effect, many years of passionate controversy would have been spared. The ministry of Lord Grey was shattered to pieces by difficulties over an Irish coercion bill. Although Lord Melbourne became premier (July 14, 1834), the fortunes of the ministry rested on Lord Althorp's presence in the House of Commons.

The death of the 2nd Earl Spencer in November 1834, called his son to the upper house, and William IV. took advantage of this event to summon a Tory cabinet to his side. The new Lord Spencer abandoned the cares of office and returned to country life with unalloyed delight. Henceforth agriculture, not politics, was his principal interest. He was the first president of the Royal Agricultural Society (founded 1838), and a notable cattle-breeder. Often as he was urged by his political friends to come to their assistance, he rarely quitted the peaceful pleasures which he loved. He died at Wiseton on the 1st of October 1845, being succeeded as 4th Earl, in default of issue, by his brother Frederick (d. 1857). He had held, as a statesman, a remarkable position. The Whigs required, to carry the Reform Bill, a leader of unstained character, one to whom party spirit could not attach the suspicion of greed of office, and against Lord Althorp malevolence was powerless. No stronger proof of his pre-eminence could be given than the oft-quoted saying of Lord Hardinge that one of Croker's ablest speeches was demolished by the simple statement of Lord Althorp that he had collected some figures which entirely refuted it, but had lost them. The trust which the house put in him then was never wanting.

SPENCER, JOHN POYNTZ SPENCER, 5th EARL (1835-1910), English statesman, was the son of the 4th Earl and his first wife, a daughter of William Stephen Poyntz, of Cowdray Park, Sussex. Born on the 27th of October 1835, and educated at Harrow and Trinity College, Cambridge, he was a member of parliament for a few months before he succeeded to the earldom in December 1857. His long career as a Liberal politician dates from his acceptance of the office of lord-lieutenant of Ireland under Gladstone in 1868, a post which he retained until 1874. When the Liberals returned to power in 1880 he was appointed lord president of the council, but in 1882 he entered upon a second term of office as lord-lieutenant of Ireland. The three years during which Earl Spencer now filled this position was a period of exceptional disorder in Ireland, marked by a long series of outrages and conspiracies associated with the "Invincibles," but the courage and firmness which he then displayed won the admiration of all, and made his adoption of the policy of Home Rule in 1885 an event of considerable interest. In the short Liberal administration of 1886 he was lord-president of the council, and from 1892 to 1895 he was a very capable first lord of the admiralty; it is on record that Gladstone, on retiring in 1904, would have recommended the Queen, if she had consulted him, to summon Lord Spencer to the premiership. From 1902 to 1905 he was the Liberal leader in the House of Lords, and early in 1905, when a change of government was seen to be probable, it was thought in some quarters that he would be the most suitable Liberal prime minister. But his health broke down just at this time, and he took no further part in political life, although he survived until the 13th of

August 1910, when he died at Althorp. For forty-five years the earl was a Knight of the Garter; he was lord-lieutenant of Northamptonshire for upwards of thirty years, and he had a reputation as a keen and daring rider to hounds. The fine library, collected at Althorp by the 2nd earl, was sold by him for £250,000 to Mrs Rylands, the widow of a Manchester merchant, and was by her presented to the city of Manchester.

Earl Spencer had no children, and his successor was his half-brother, Charles Robert Spencer (b. 1857), who became the 6th earl. As the Hon. Charles R. Spencer he was one of the parliamentary representatives for Northamptonshire from 1880 to 1895 and again from 1900 to 1905, and was vice-chamberlain of the royal household from 1892 to 1895. In 1905 he was appointed lord chamberlain, and in the same year he was raised to the peerage as Viscount Althorp.

SPENCER, WILLIAM ROBERT (1769-1834), English poet and wit, was the son of Lord Charles Spencer, second son of Charles Spencer, 3rd duke of Marlborough and 5th earl of Sunderland. He was educated at Harrow and Christ Church, Oxford, but left the university without taking a degree. Spencer's wit made him a popular member of society, but he took no part in public life although he numbered among his friends leading statesmen like Pitt, Fox and Sheridan. He was an accomplished writer of "occasional" verse, which was warmly praised by Scott, by Christopher North and by Byron, who placed him in the same rank as Moore, Rogers and Campbell. In 1796 he published an English version of Bürger's *Leonore*, and in 1802 he burlesqued German romance in his *Urania*, which was produced on the stage at Drury Lane. Among his best-known pieces, which were published in a collection of his poems in 1811, were "Beth Gelert" and "Too Late I Stayed." He died in poverty in Paris in 1834. In 1791 he married Susan, daughter of Count Jenison-Walworth, chamberlain to the elector palatine, by whom he had five sons and two daughters. One son, AUBREY GEORGE SPENCER (1795-1872), became first bishop of Newfoundland in 1839, being afterwards translated to the See of Jamaica. Another son, GEORGE TREVOR SPENCER (1799-1866), was in 1837 consecrated second bishop of Madras. He published several books relating to missionary work in India; on his return to England in 1849 he was appointed assistant to the bishop of Bath and Wells, and in 1860 became chancellor of St Paul's Cathedral. He married, in 1823, Harriet, daughter of Sir Benjamin Hobhouse and sister of Lord Broughton.

See W. R. Spencer, *Poems* (London, 1835), containing a biographical memoir; *The Annual Register* (1834); *Alumni Oxonienses 1715-1886*, annotated by J. Foster (4 vols., Oxford, 1891).

SPENCER, a township of Worcester county, Massachusetts, U.S.A., about 11 m. W. of Worcester. Pop. (1890), 8747; (1900), 7627, of whom 1614 were foreign-born; (1910, U.S. census), 6740. Area, about 34.1 sq. m. The township is served by the Boston & Albany railway and by inter-urban electric lines. The Richard Sugden Public Library, founded in 1889, had 12,000 volumes in 1908. Bemis Memorial Park and the Samuel Bemis Monument were dedicated in 1901 in honour of the first settler of Spencer. There are three other public parks. Among the township's manufactures are boots and shoes, woollens, muslin underwear, wire, and wooden and paper boxes. Spencer was a part of the Leicester grant; was first settled in 1721; was the "West Parish of Leicester" in 1744-1753; and in 1753 was incorporated as a township, under its present name. In one house in Spencer were born Elias Howe, jun., the inventor of the sewing-machine, and his uncles, William Howe, inventor of the "Howe truss" bridge (see BRIDGES), and Tyler Howe (1800-1880), inventor (in 1855) of the spring bed; in 1909 a memorial was dedicated to these three inventors.

See Henry M. Tower, *Historical Sketches Relating to Spencer, Mass.* (4 vols., Spencer, 1901-1909).

SPENER, PHILIPP JAKOB (1635-1705), German theologian, was born on the 13th of January 1635, at Rappoltswiler in Upper Alsace. After a brief stay in the grammar school of Colmar he went to Strassburg in 1651, where he devoted himself

to the study of philology, history and philosophy, and won his degree of master (1653) by a disputation against the philosophy of Hobbes. He then became private tutor to the princes Christian and Charles of the Palatinate, and lectured in the university on philology and history. From 1659 to 1662 he visited the universities of Basel, Tübingen and Geneva, and commenced the study of heraldry, which he pursued throughout his life. In Geneva especially his religious views and tendencies were turned in the direction of mysticism. He returned to Strassburg in 1663, where he was appointed preacher without pastoral duties, with the right of holding lectures. Three years afterwards he was invited to become the chief pastor in the Lutheran Church at Frankfort-on-Main. Here he published his two chief works, *Pia desideria* (1675) and *Allgemeine Gottesgelehrtheit* (1680), and began that form of pastoral work which resulted in the movement called *Pietism*. In 1686 he accepted the invitation to the first court chaplaincy at Dresden. But the elector John George III., at whose personal desire the post had been offered to him, was soon offended at the fearless conscientiousness with which his chaplain sought to discharge his pastoral duties. Spenser refused to resign his post, and the Saxon government hesitated to dismiss him. But in 1691 the Saxon representative at Berlin induced the court of Brandenburg to offer him the rectorship of St Nicholas in Berlin with the title of "Konsistorialrat." In Berlin Spenser was held in high honour, though the tendencies of the court and the government officials were rather rationalistic than pietistic. The university of Halle was founded under his influence in 1694. All his life long Spenser had been exposed to the attacks and abuse of the orthodox Lutheran theologians; with his years his opponents multiplied, and the movement which he had inaugurated presented increasingly matter for hostile criticism. In 1695 the theological faculty of Wittenberg formally laid to his charge 264 errors, and only his death on the 5th of February, 1705, released him from these fierce conflicts. His last important work was *Theologische Bedenken* (4 vols., 1700-1702), to which was added after his death *Letzte theologische Bedenken*, with a biography of Spenser by C. H. von Canstein (1711).

Though Spenser has been justly called "the father of Pietism," hardly any of the errors and none of the extravagances of the movement can be ascribed to him personally. So far was he from sharing them that A. Ritschl (*Geschichte des Pietismus*, ii. 163) maintains that "he was himself not a Pietist," as he did not advocate the quietistic, legalistic and semi-separatist practices of Pietism, though they were more or less involved in the positions he assumed or the practices which he encouraged or connived at. The only two points on which he departed from the orthodox Lutheran faith of his day were the requirement of regeneration as the *sine qua non* of the true theologian, and the expectation of the conversion of the Jews and the fall of Papacy as the prelude of the triumph of the church. He did not, like the later Pietists, insist on the necessity of a conscious crisis of conversion, nor did he encourage a complete breach between the Christian and the secular life.

Spenser was a voluminous writer. The list of his published works comprises 7 vols. folio, 63 quarto, 7 octavo, 46 duodecimo; a new edition of his chief writings was published by P. Grünberg in 1889. See W. Hossbach, *Philipp Jakob Spener und seine Zeit* (1828, 3rd ed., 1861); A. Ritschl, *Geschichte des Pietismus*, ii. (1884); E. Sachsse, *Ursprung und Wesen des Pietismus* (1884); P. Grünberg, *P. J. Spener* (3 vols., 1893-1906).

SPENNYMOOR, a market town in the Bishop Auckland parliamentary division of Durham, England, 6 m. S. of the city of Durham, on a branch of the North Eastern railway. Pop. of urban district, which includes several neighbouring parishes (1901), 16,665. It is in the midst of a populous coal-mining district, and its growth is modern.

SPENS, THOMAS DE (c. 1415-1480), Scottish statesman and prelate, received his education at Edinburgh, and by his exceptional abilities attracted the notice of the advisers of the Scottish king, James II., who sent him on errands to England and to France. About 1450 he became bishop of Galloway; soon afterwards he was made keeper of the privy seal, and in 1459 he was chosen bishop of Aberdeen. Much of his time, however, was passed in journeys to France and to England, and in 1464 he

and Alexander Stewart, duke of Albany, a son of James II., were captured at sea by some English sailors. Edward IV., to whom the bishop had previously revealed an assassination plot, set him at liberty, and he was partly responsible for the treaty of peace made about this time between the English king and James III. He also helped to bring about the meeting between Edward IV. and Louis XI. of France at Picquigny, and another treaty of peace between England and Scotland in 1474. Spens was a frequent attender at the Scottish parliaments, and contributed very generously to the decoration of his cathedral at Aberdeen. He died in Edinburgh on the 14th of April 1480.

SPENSER, EDMUND (c. 1552-1599), English poet, author of the *Faery Queen*, was born in London about the year 1552. The received date of his birth rests on a passage in sonnet lx. of the *Amoretti*. He speaks there of having lived forty-one years; the *Amoretti* was published in 1595, and described on the title-page as "written not long since"; this would make the year of his birth 1552 or 1553. We know from the *Prothalamion* that London was his birthplace. This at least seems the most natural interpretation of the words—

"Merry London, my most kindly nurse,
That to me gave this life's first native source."

In the same poem he speaks of himself as taking his name from "an house of ancient fame." Several of his pieces are addressed to the daughters of Sir John Spenser, head of the Althorp family; and in *Colin Clout's Come Home Again* he describes three of the ladies as—

"The honour of the noble family
Of which I meanest boast myself to be."

Mr R. B. Knowles, however, is of the opinion (see the *Spending of the Money of Robert Nowell*, privately printed, 1877) that the poet's kinsmen must be sought among the humbler Spencers of north-east Lancashire. Robert Nowell, a London citizen, left a sum of money to be distributed in various charities, and in the account-books of his executors among the names of other beneficiaries has been discovered that of "Edmund Spensore, scholar of the Merchant Taylor School, at his going to Pembroke Hall in Cambridge." The date of this benefaction is the 28th of April 1569. As the poet is known to have been a sizar of Pembroke, the identification is beyond dispute. Till this discovery it was not known where Spenser received his school education. The speculations as to the poet's parentage, started by the Nowell MS., are naturally more uncertain. Mr Knowles found three Spencers in the books of the Merchant Taylors, and concluded that the poorest of them, John Spenser, a "free journeyman" in the "art or mystery of clothmaking," might have been the poet's father, but he afterwards abandoned this theory. Dr Grosart, however, adhered to it, and it is now pretty generally accepted. The connexion of Spenser with Lancashire is also supported by the Nowell MS.—several Spencers of that county appear among the "poor kinsfolk" who profited by Nowell's bounty. The name of the poet's mother was Elisabeth, and he notes as a happy coincidence that it was borne by the three women of most consequence to him—wife, queen and mother (*Amoretti*, lxxiv.).

It is natural that a poet so steeped in poetry as Spenser should show his faculty at a very early age; and there is strong reason to believe that verses from his pen were published just as he left school at the age of sixteen or seventeen. Certain pieces, translations from Du Bellay and Petrarch, afterwards included in a volume of poems by Spenser published in 1591, are found in a miscellany, *Theatre for Worldings*, issued by a Flemish Protestant refugee, John van der Noodt, on the 25th of May 1569. The translations from Du Bellay appear in blank verse in the miscellany, and are rhymed in sonnet form in the later publication, but the diction is substantially the same; the translations from Petrarch are republished with slight variations. Poets were so careless of their rights in those days and publishers took such liberties that we cannot draw for certain the conclusion that would be inevitable if the facts were of more

modern date; but the probabilities are that these passages in Van der Noodt's *Theatre*, although the editor makes no acknowledgment, were contributed by the schoolboy Spenser.¹ As the exercises of a schoolboy writing before our poetic diction was enriched by the great Elizabethans, they are remarkable for a sustained command of expression which many schoolboys might exhibit in translation now, but which was a rarer and more significant accomplishment when Surrey and Sackville were the highest models in post-Chaucerian English.

Little is known of Spenser's Cambridge career, except that he was a sizar of Pembroke Hall, took his bachelor's degree in 1572, his master's in 1576, and left Cambridge without having obtained a fellowship. Dr Grosart's inquiries have elicited the fact that his health was not good—college allowances while he was in residence being often paid "Spenser aegrotanti." One of the fellows of Pembroke strongly influenced his destiny. This was Gabriel Harvey, a prominent figure in the university life of the time, an enthusiastic educationist, vigorous, versatile, not a little vain of his own culture and literary powers, which had gained him a certain standing in London society. The revival and advancement of English literature was a passion of the time, and Harvey was fully possessed by it. His fancy for reforming English verse by discarding rhyme and substituting unrhymed classical metres, and the tone of his controversy with Thomas Nash, have caused him to be regarded as merely an obstreperous and pragmatic pedant; but it is clear that Spenser, who had sense enough not to be led astray by his eccentricities, received active and generous help from him and probably not a little literary stimulus. Harvey's letters to Spenser² throw a very kindly light on his character. During his residence at the university the poet acquired a knowledge of Greek, and at a later period offered to impart that language to a friend in Ireland (see Ludowick Bryskett, *Discourse of Civil Life*, London, 1606—written twenty years previously). Spenser's affinity with Plato is most marked, and he probably read him in the original.

Three years after leaving Cambridge, in 1579, Spenser issued his first volume of poetry, the *Shepherd's Calendar*. Where and how he spent the interval have formed subjects for elaborate speculation. That most of it was spent in the study of his art we may take for granted. That he lived for a time in the "north parts" of England; that there or elsewhere he fell in love with a lady whom he celebrates under the anagram of "Rosalind," and who was most likely Rose, a daughter of a yeoman named Dyneley, near Clitheroe; that his friend Harvey urged him to return south, and introduced him to Sir Philip Sidney; that Sidney took to him, discussed poetry with him, introduced him at court, put him in the way of preferment—are ascertained facts in his personal history. Dr Grosart conjectures with considerable plausibility that he was in Ireland in 1577. The words "for long time far estranged" in E.K.'s preface to the *Shepherd's Calendar* point that way. Spenser undoubtedly entered the service of the earl of Leicester either in 1578 or a year earlier (*Carew Papers*).

The interest of the *Shepherd's Calendar* is mainly personal to Spenser. Its twelve poems continue to be read chiefly because they were the first published essays of the author of the *Faery Queen*, the poems in which he tried and disciplined his powers. They mark no stage in the history of pastoral poetry. The title, borrowed from a French almanack of the year 1496, which was translated into English in 1503 and frequently reprinted, is attractive but hardly tallies with the subject. It may have been an afterthought. Spenser had too strong a genius not to make his own individuality felt in any form that he attempted, and his buoyant dexterity in handling various schemes of verse must always afford delight to the connoisseur in such things. But a reader not already interested in Spenser, or not already familiar with the artificial eclogue, would find little to attract him in the *Shepherd's Calendar*. The poems need a special education; given this, they

¹ The first versions of the *Visions* of Petrarch and Du Bellay are reproduced by Dr Grosart in his *Complete Works of Spenser*, vol. iv. (London, 1882). The translations of Petrarch are imitated from Marot. Koepfel (*Englische Studien*, vol. xv.), questions whether they are by Spenser (see also J. B. Fletcher, *Modern Language Notes*, vol. xxii.).

² *Letter-Book of Gabriel Harvey* (Camden Society).

are felt to be full of charm and power, a fresh and vivid spring to the splendid summer of the *Faery Queen*. The diction is a studiously archaic artificial compound, partly Chaucerian, partly North Anglian, partly factitious; and the pastoral scenery is such as may be found in any country where there are sheep, hills, trees, shrubs, toadstools and running streams. That Spenser, having been in the north of England, should have introduced here and there a touch of north country colour is natural enough, but it is not sufficient to give a character to the poems as pastoral poems. As such they follow continuously and do not violently break away from Latin, Italian and French predecessors, and Professor George Saintsbury is undoubtedly right in indicating Marot as the most immediate model. At the same time one can quite understand on historical grounds why the *Shepherd's Calendar* was hailed with enthusiasm as the advent of a "new poet." Not only was it a complete work in a form then new to English literature, but the execution showed the hand of a master. There had been nothing so finished, so sustained, so masterful in grasp, so brilliant in metre and phrase, since Chaucer. It was felt at once that the poet for whom the age had been waiting had come. The little coterie of friends whose admiration the young poet had won in private were evidently concerned lest the wider public should be bewildered and repelled by the unfamiliar pastoral form and rustic diction. To put the public at the right point of view the poems were published with a commentary by "E.K."—supposed to be one Edward Kirke, who was an undergraduate with Spenser at Pembroke. This so-called "glosse" explained the archaic words, revealed the poet's intentions, and boasted that, as in the case of Virgil, the pastoral poetry of the "new poet" was but "a proving of the wings for higher and wider flights." The "new poet's" name was withheld; and the identification of the various "shepherds"—of Cuddie and Roffy and Diggon Davie, and the beauteous golden-haired "widow's daughter of the glen"—was fortunately reserved to yield delight to the ingenious curiosity of a later age.³ On the subject of Spenser's obligations the "glosse" is very misleading. An eclogue drawn almost entirely from Virgil is represented as jointly inspired by Virgil and Theocritus and chiefly by the latter. Marot is belittled and his claim to be a poet called in question. As regards the twelfth eclogue suggested by and in part translated from his poetry, his influence is ignored. The stanzas Professor Hales cites as autobiographical are actually taken from Marot's eclogue, *Au Roi sous les noms de Pan et Robin*. Dr Grosart falls into the same error.

The *Shepherd's Calendar* was published at Gabriel Harvey's instance, and was dedicated to Sir Philip Sidney. It was one out of many poetical schemes on which the young poet was busy in the flush of conscious power and high hopes excited by the admiration of the literary authorities whose approval was then most to be coveted. His letters to Harvey and Harvey's letters to him furnish hints for a very engaging fancy picture of Spenser at this stage of his life—looking at the world through rose-coloured spectacles, high in favour with Sidney and Leicester, dating his letters from Leicester House, gaily and energetically discussing the technicalities of his art, with some provision from his powerful friends—certain, but the form of it delightfully uncertain—going to court in the train of Leicester, growing pointed beard and mustachios of fashionable shape, and frightening his ever-vigilant friend and mentor Harvey by the light courtier-like tone of his references to women. The studious pastoral poet from "north parts" had blossomed with surprising rapidity in the image of the gay fortune-seeking adventurers who crowded the court of the virgin queen in those stirring times. Some of the poems which he mentions to Harvey as then completed or on the anvil—his *Dreams*, his *Nine Comedies*, his *Dying Pelican* and his *Stemmata dudleiana* (singing the praises of the noble family which was befriending him)—have not been preserved, at least in any form that can be certainly identified. Among the lost works was his *English Poet*—a contribution to literary criticism. He had sent Harvey a portion of the *Faery Queen*, which he was eager to continue; but Harvey did not think much of it—a judgment for which Harvey is often ridiculed as a dull pedant, as if we knew for certain that what was submitted to him was identical with what was published ten years later.

Spenser was appointed secretary to the lord-deputy of Ireland in 1580, and was one of the band of adventurers who, with mixed motives of love of excitement, patriotism, piety and hopes of forfeited estates, accompanied Lord Arthur Grey of Wilton to Ireland to aid in the suppression of Desmond's rebellion. Regret is sometimes expressed that the author of the *Faery Queen*, who ought to have been dreamy, meditative, gentle and refined, should have been found in such company, and should have taken part in the violent and bloody scenes of Lord Grey's two years' attempt at "pacification." But such things must be judged with reference to the circumstances and the spirit of the time, and it must be remembered that England was then

³ See Dr Grosart's *Complete Works of Spenser*, vol. i.

engaged in a fierce struggle for existence against the Catholic powers of the Continent. Of Lord Grey's character his secretary was an enthusiastic admirer, exhibiting him in the *Faery Queen* as Arthegal, the personification of justice; and we know exactly what were his own views of Irish policy, and how strongly he deplored that Lord Grey was not permitted to carry them out. Spenser's *View of the State of Ireland* drawn up after fourteen years' experience, but first printed in 1633 by Sir James Ware, who complains of Spenser's harshness and inadequate knowledge (*History of Ireland*, appendix), is not the work of a gentle dreamer, but of an energetic and shrewd public official.

The *View* is not a descriptive work; there is nothing in the style to indicate that it was written by a poet; it is an elaborate state paper, the exposition in the form of a dialogue of a minutely considered plan for the pacification of Ireland, written out of zeal for the public service for the eyes of the government of the day. A very thoroughgoing plan it is. After passing in review the history and character of the Irish, their laws, customs, religion, habits of life, armour, dress, social institutions and finding "evil usages" in every department, he propounds his plan of "reformation." Reformation can be effected only by the sword, by the strong hand. The interlocutor in the dialogue holds up his hands in horror. Does he propose extermination? By no means; but he would give the Irish a choice between submission and extermination. The government had vacillated too long, and, fearing the cost of a thorough operation, had spent twice as much without in any way mending matters. Let them send into Ireland 10,000 foot and 1000 horse, disperse them in garrisons—a complete scheme of localities is submitted—give the Irish twenty days to come in; if they did not come in then, give no quarter afterwards, but hunt them down like wild beasts in the winter time when the covert is thin; "if they be well followed one winter, ye shall have little work to do with them the next summer"; famine would complete the work of the sword; and in eighteen months' time peace would be restored and the ground cleared for plantation by English colonists. There must be no flinching in the execution of this plan—"no remorse or drawing back for the sight of any such rueful object as must thereupon follow, nor for compassion of their calamities, seeing that by no other means it is possible to recover them, and that these are not of will but of very urgent necessity." The government had "out of foolish compassion drawn back before when Lord Grey had brought the recalcitrant Irish to the necessary extremity of famine; the gentle poet warns them earnestly against a repetition of the blunder.

Such was Spenser's plan for the pacification of Ireland, propounded not on his own authority, but as having support in "the consultations and actions of very wise governors and counsellors whom he had sometimes heard treat thereof." He knew that it was "bloody and cruel"; but he contended passionately that it was necessary for the maintenance of English power and the Protestant religion. The method was repugnant to the kindly nature of average Englishmen; from the time of Lord Grey no English authority had the heart to go through with it till another remorseless zealot appeared in the person of Cromwell. That Cromwell knew the treatise of "the sage and serious Spenser," perhaps through Milton, is probable from the fact that the poet's Irish estates were secured to his grandson by the Protector's intervention in 1657. These estates had been granted to Spenser as his share in the redistribution of Munster—3000 acres of land and Kilcolman Castle, an ancient seat of the Desmonds, in the north of the county of Cork. The elaborate and business-like character of the *View* shows that the poet was no sinecurist, but received his reward for substantial political services. He ceased to be secretary to the lord-deputy when Lord Grey was recalled in 1582; but he continued in the public service, and in 1586 was promoted to the onerous position of clerk to the council of Munster.

Amidst all the distractions of his public life in Ireland Spenser kept up his interest in literature, and among proper subjects for reform included Irish poetry, of which he could judge only through the medium of translations. He allows it some merit—"sweet wit," "good invention," "some pretty flowers"—but laments that it is "abused to the gracing of wickedness and vice." Meanwhile he seems to have proceeded steadily with the composition of the *Faery Queen*, translating his varied experience of men and affairs into the picturesque forms of his allegory, and expressing through them his conception of the immutable principles that ought to regulate human conduct.

He had, as we have seen, conceived a work of the kind and made a beginning before he left England. The conception must have been very much deepened and widened and in every way enriched by his intimate daily contact with the actual struggle of conflicting individuals and interests and policies in a great crisis. Some four or five years later, being asked in a mixed company of English officials in Ireland (as recorded in Lodowick Bryskett's *Discourse of Civil Life*) to give off-hand a short sketch of "the ethical part of moral philosophy" and the practical uses of the study, Spenser explained to these simple-minded men that the subject was too intricate for an impromptu exposition, but that he had in hand a work called the *Faery Queen* in which an ethical system would be exhibited in action. The respect paid by his official brethren to Spenser as a man, "not only perfect in the Greek tongue, but also very well read in philosophy, both moral and natural," is an interesting item in his biography. Some years later still, when Spenser was settled at Kilcolman Castle, Sir Walter Raleigh found him with three books of the *Faery Queen* completed, and urged him to come with them to London. London accordingly he revisited in 1589, after nine years' absence. There is a very pretty record of this visit in *Colin Clout's Come Home Again*, published in 1595, but written in 1591, immediately after his return to Kilcolman. The incidents of the visit, by that time matters of wistful memory, are imaged as a shepherd's excursion from his quiet pastoral life into the great world. Colin Clout calls round him once again the masked figures of the *Shepherd's Calendar*, and describes to them what he saw, how he fared, and whom he met at the court of Cynthia, and how, through the influence of "the Shepherd of the Ocean," he was admitted at timely hours to play on his oaten pipe in the great queen's presence.

How much is pure fiction and how much veiled fact in this picture cannot now be distinguished, but it is undoubted that Spenser, though his chief patrons Leicester and Sidney were now dead, was very graciously received by the great world on his return to London. Not only did the queen grant him an audience, but many ladies of the court, several of whom he afterwards honoured with dedications, honoured him with their patronage. The first three books of the *Faery Queen*, which were entered at Stationers' Hall on the 1st of December 1589, were published in 1590, and he was proclaimed at once with remarkable unanimity by all the writers of the time as the first of living poets.

From the first week of its publication the literary world has continued unanimous about the *Faery Queen*, except on minor points. When romanticism was at its lowest ebb Pope read Spenser in his old age with as much delight as in his boyhood. Spenser speaks himself of having had his detractors, of having suffered from the venomous tooth of the Blatant Beast, and he seems to have had in more than ordinary share the poet's sensitiveness to criticism; but the detraction or indifference have generally been found among men who, like the lord high treasurer Burghley, have no liking for poetry of any kind. The secret of Spenser's enduring popularity with poets and lovers of poetry lies specially in this, that he excels in the poet's peculiar gift, the instinct for verbal music. Shakespeare, or the author of the sonnet usually assigned to him, felt and expressed this when he drew the parallel between "music and sweet poetry"—

"Thou lovest to hear the sweet melodious sound
That Phoebus' lute, the queen of music, makes;
And I in deep delight am chiefly drowned
Whenas himself to singing he betakes."

This is an early word in criticism of Spenser, and it is the last word about his prime and unquestionable excellence—a word in which all critics must agree. Whether he had imagination in the highest degree or only luxuriant fancy, and whether he could tell a story in the highest epic manner or only put together a richly varied series of picturesque incidents, are disputable points; but about the enchantment of his verse there can be no difference of opinion. It matters not in the least that he gains his melody often by archaic affectations and licences of diction; there, however purchased, the marvellously rich music is. In judging of the structure of the *Faery Queen* we must always remember that, long and diffuse as it is, what we have is but a fragment of the poet's design, and that the narrative is regulated by an allegorical purpose; but, however intricate, however confused, the reader may feel the succession of incidents to be, when he studies the succession of incidents, it is only at the call of duty that he is likely to occupy himself with such a study in reading Spenser.

The ethical value of the allegory has been very variously estimated. The world would probably never have divined that there was any allegory if he had not himself drawn attention to it in a prose dedication and in doggerel headings to the cantos. It was apparently at his friend Raleigh's suggestion that the poet descended to explain his ethical purpose in *A Letter of the Author's* addressed to Sir Walter and dated the 23rd of January 1589-1590; otherwise it would have been as problematical as the similar intention in the case of the *Idylls of the King* before that intention was expressly declared. It is almost to be regretted, as far as the allegory is concerned, that the friendly "E. K." was not employed to furnish a "glosse" to the *Faery Queen* as he had done to the *Shepherd's Calendar*. Undoubtedly the peculiar "poetic luxury" of the *Faery Queen* can be enjoyed without any reference to the allegory; even Professor Dowden, the most eloquent champion of Spenser's claims as a "teacher," admits that it is a mistake to look for minute correspondence between outward symbol and underlying sense, and that the poet is least enjoyable where he is most ingenious. Still the allegory governs the structure of the poem, and Spenser himself attached great importance to it as determining his position among poets. The ethical purpose is distinctive of the poem as a whole; it was foremost in Spenser's mind when he conceived the scheme of the poem, and present with him as he built up and articulated the skeleton; it was in this respect that he claimed to have "overpassed" his avowed models Ariosto and Tasso. If we wish to get an idea of Spenser's imaginative force and abundance, or to see his creations as he saw them, we must not neglect the allegory. It is obvious from all that he says of his own work that in his eyes the ethical meaning not only heightened the interest of the marvelously rich pageant of heroes and heroines, enchanters and monsters, but was the one thing that redeemed it from romantic commonplace. For the right appreciation of many of the characters and incidents a knowledge of the allegory is indispensable. For example, the slaughter of Error by the Red Cross knight would be merely disgusting but for its symbolic character; the iron Talus and his iron flail is a revolting and brutally cruel monster if he is not regarded as an image of the executioner of righteous law; the Blatant Beast, a purely grotesque and ridiculous monster to outward view, acquires a serious interest when he is known to be an impersonation of malignant detraction.

Notwithstanding its immense range, the *Faery Queen* is profoundly national and Elizabethan, containing many more or less cryptic allusions to contemporary persons and interests. It has never been popular abroad, as is proved by the fact that there is no complete translation of it in any of the Continental languages. This is doubtless on account of a certain monotony in the subject-matter, which is only partially relieved by subtle variations. The same objection applies to the famous "Spenserian stanza" (see below) with its concluding Alexandrine. It was by no means a happy invention, but its infelicity is disguised by its author's marvellous skill in rhythm, and thus recommended it was adopted by Byron and Keats. In his own day Spenser was criticized by Sidney, Ben Jonson, Daniel and others for the artificiality of his language, his "aged accents and untimely words," but Ben Jonson went further—"Spenser's stanza pleased him not, nor his matter." Milton, on the other hand, duly appreciated "our sage and serious poet," and he has been followed by a long line of distinguished judges. It was Charles Lamb who named Spenser "the poet's poet."

After the publication of the *Faery Queen* Spenser seems to have remained in London for more than a year, to enjoy his triumph. It might be supposed, from what he makes the Shepherd of the Ocean say in urging Colin Clout to quit his banishment in Ireland, that Raleigh had encouraged him to expect some permanent provision in London. If he had any such hopes, they were disappointed. The thrifty queen granted him a pension of £50, which was paid in February 1591, but nothing further was done for him. Colin Clout's explanation that the selfish scrambling and intriguing of court life were not suited to a lowly shepherd swain, and that he returned to country life with relief, may be pastoral convention, or it may have been an expression of the poet's real feelings on his return to Kilcolman, although as a matter of fact there seems to have been as much scrambling for good things in Munster as in London. Certain it is that he did return to Kilcolman in the course of the year 1591, having probably first arranged for the publication of *Daphnida* and *Complaints*. *Daphnida* is a pastoral elegy on the death of the niece of the mistress of the robes. The fact implied in the dedication that he was not personally known to

the lady has more than once provoked the solemn remark that the poet's grief was assumed. Of course it was assumed; and it is hardly less obvious that sincerity of personal emotion, so far from being a merit in the artificial forms of pastoral poetry, the essence of which lies in its dreamy remoteness from real life, would be a blemish and a discord. Any suggestion of the poet's real personality breaks the charm; once raise the question of the poet's personal sincerity, and the pastoral poem may at once be thrown aside. The remark applies to all Spenser's minor poetry, including his love-sonnets; the reader who raises the question whether Spenser really loved his mistress may have a talent for disputation, but none for the full enjoyment of hyperbolic poetry. *Complaints*, also published in 1591, is a miscellaneous collection of poems written at different periods. The volume contained *The Ruins of Time*; *The Tears of the Muses*; *Virgil's Gnat*; *Mother Hubbard's Tale*; *The Ruins of Rome*; *Muiopotmos*; *Visions of the World's Vanity*; *Bellay's Visions*; *Petrarch's Visions*. Some of these pieces are translations already alluded to and interesting only as the exercises of one of our greatest masters of melodious verse; but two of them, *The Tears of the Muses* and *Mother Hubbard's Tales*, have greater intrinsic interest. The first is the complaint of the decay of learning alluded to in *Midsummer Night's Dream*, v. i. 52—

"The thrice three Muses mourning for the death
Of Learning late deceased in beggary."

The lament, at a time when the Elizabethan drama was "mewing its mighty youth," was not so happy as some of Spenser's political prophecies in his *View of Ireland*; but it is idle work to try to trace the undercurrents and personal allusions in such an occasional pamphlet. *Mother Hubbard's Tale*, a fable in Chaucerian couplets, shows a keenness of satiric force not to be paralleled in any other of Spenser's writings, and suggests that he left the court in a mood very different from Colin Clout's.

Spenser returned to London probably in 1595. He had married in the interval a lady whose Christian name was Elizabeth—Dr Grosart says Elizabeth Boyle. The marriage, celebrated on the 11th of June 1594, was followed by a rapid succession of publications. The first was a volume (entered at Stationers' Hall, on the 19th of November 1594; published 1595) containing the *Amoretti*, a series of exquisite sonnets commemorative of the moods and incidents of his courtship, and the magnificent *Epithalamion*, incomparably the finest of his minor poems. As in the case of the *Complaints*, the publisher for obvious reasons issued this volume nominally without his authority. *Colin Clout's Come Home Again* was published in the same year, with a dedication to Sir Walter Raleigh, dated 1591. Early in 1596 the second three books of the *Faery Queen* were entered in the register of Stationers' Hall, and in the course of the same year were published his *Four Hymns*, his *Prothalamion*, and his *Astrophel*, a pastoral lament for Sir Philip Sidney, which he dedicated to the countess of Essex.

That Spenser wrote more of the *Faery Queen* during the last two years of his life, and that the MS. perished in the sack of Kilcolman Castle by the rebels, may plausibly be conjectured, but cannot be ascertained. During those years he would seem to have been largely occupied with political and personal cares. He describes himself in the *Prothalamion* as a disappointed suitor at court. He drew up his *View of Ireland* in 1596 when he was in London, and from various circumstances it is evident that he had hopes of some kind from the favour of Essex. The *View*, with its urgent entreaty that Essex should be sent to Ireland, was entered at Stationers' Hall in April 1598, but he did not obtain leave to publish it. Burghley, who had long stood in his way, died in August of that year, and next month Spenser, who seems to have returned to Ireland in 1597, was appointed sheriff of Cork. In October Tyrone's rebellion broke out, and Spenser's house was sacked and burned. The poet himself escaped, and in December was sent to London with despatches. Again he ventured to urge upon the queen his plan for the thorough "reformation" of Ireland. But his own

end was near. On the 16th of January 1599 he died at Westminster, ruined in fortune, if not heart-broken, and was buried in Westminster Abbey, near his master Chaucer. Ben Jonson asserted that he perished for lack of bread, and that when the earl of Essex, hearing of his distress, sent him "20 pieces," the poet declined, saying that he had no time to spend them.¹ This report of his end is mentioned also by the author of *The Return from Parnassus*, but, having regard to Spenser's position in the world, it is inherently improbable. Still there is an ugly possibility of its truth. The poet left three sons and a daughter. A pedigree of the family appeared in the *Gentleman's Magazine* for August 1842.

Editions by Todd (8 vols., 1805) and by A. B. Grosart (10 vols., 1882-1884); the Aldine edition, with Life by Collier, and the Globe edition, with Life by J. W. Hales; Dean Church's *Spenser*, in "English Men of Letters" series; Craik's *Spenser and his Poetry* (1845); Mrs C. M. Kirkland's *Spenser and the Faery Queen* (New York, 1847); J. S. Hart's *Essay on the Life and Writings of Edmund Spenser* (New York, 1847); Kitchin and Mayhew's *Spenser's Faery Queen*, bks. i.-ii., and Herford's *Spenser's Shepherd's Calendar* (Oxford, Clarendon Press); Roden Noel's preface to the Spenser volume in the *Canterbury Poets*; and F. I. Carpenter's *Guide to the Study of Spenser* (Chicago, 1894). (W. M.; F. J. S.)

SPENSER, JOHN (1559-1614), president of Corpus Christi College, Oxford, was educated at Merchant Taylors' School, London, and Oxford. After graduating he became Greek reader in Corpus Christi College, and held that office for ten years, resigning in 1588. He then left Oxford and held successively the livings of Alveley, Essex (1589-1592), Ardleigh, Essex (1592-1594), Faversham, Kent (1594-1599), and St Sepulchre's London (1599-1614). He was also presented to the living of Broxbourne, Hertfordshire, in 1592. In 1607 he was appointed president of Corpus Christi College. After the death of his friend Richard Hooker he edited the first five books of Hooker's *Ecclesiastical Politie* (London, 1604). The introduction to that work and *A Sermon at Paule's Crosse on Esay V., 2, 3* (London, 1615) are his only published writings. He was, however, one of the translators of the authorized version of the Bible, serving on the New Testament committee.

SPENSERIAN STANZA, a form of verse which derives its name from the fact that it was invented by the poet Edmund Spenser, and first used in his *Faery Queene* in 1590. The origin of this stanza has been matter for disagreement among critics of prosody. Schiffer has argued that it was adapted from the old French ballade-stanza (see BALLADE). But it is much more probable that it was of Italian origin, and that Spenser, who was familiar with *ottava rima* as it had long been employed in Italy, and was at that very time being used by the school of Tasso, added a line between the Italian fourth and fifth, modified slightly the arrangements of rhyme, and added a foot to the last line, which became an Alexandrine. The form of the pure Spenserian stanza can best be observed by the study of a specimen from the *Faery Queene*:—

Into the inmost temple thus I came,
Which fuming all with frankincense I found,
And odours rising from the altar's flame.
Upon a hundred marble pillars round
The roof up high was rear'd from the ground,
All decked with crowns and chains and garlands gay,
And thousand precious gifts worth many a pound,
The which sad lovers for their vows did pay,
And all the ground was strow'd with flowers as fresh as May."

It is necessary to preserve in all respects the characteristics of this example, and the number, regular sequences and identity of rhymes must be followed. It is a curious fact that, in spite of the very great beauty of this stanza and the popularity of Spenser, it was hardly used during the course of the 17th century, although Giles and Phineas Fletcher made for themselves adaptations of it, the former by omitting the eighth line, the latter by omitting the sixth and eighth. In the middle of the 18th century the study of Spenser led poets to revive the stanza which bears his name. The initiators of this reform were Akenside, in *The Virtuoso* (1737); Shenstone, in *The Schoolmistress* (1742); and

¹ See *Conversations with Drummond*, Shakespeare Society, pp. 7, 12.

Thomson, in *The Castle of Indolence* (1748). Mrs Tighe (1772-1810) used it for her once-famous epic of *Psyche*. It was a favourite form at the time of the romantic revival, when it was employed by Campbell, for his *Gertrude of Wyoming* (1809); by Keats, in *The Eve of St Agnes* (1820); by Shelley, in *The Revolt of Islam* (*Laon and Cylthna*) (1818); by Mrs Hemans; by Reginald Heber; but pre-eminently by Byron, in *Childe Harold* (1812-1817). Thomas Cooper, the Chartist, wrote his *Purgatory of Suicides* (1845) in Spenserian stanza, and Tennyson part of his *Lotus Eaters*. By later poets it has been neglected, but Worsley and Conington's translation of the *Iliad* (1865-1868) should be mentioned. The Spenserian stanza is an exclusively English form.

SPERANSKI, COUNT MIKHAIL MIKHAILOVICH (1772-1839), Russian statesman, the son of a village priest, spent his early days at the ecclesiastical seminary in St Petersburg, where he rose to be professor of mathematics and physics. His brilliant intellectual qualities attracted the attention of the government, and he became secretary to Prince Kurakin. He soon became known as the most competent of the imperial officials. The most important phase of his career opened in 1806, when the emperor Alexander I. took him with him to the conference of Erfurt and put him into direct communication with Napoleon, who described him as "the only clear head in Russia" and at the instance of Alexander had many conversations with him on the question of Russian administrative reform. The result of these interviews was a series of projects of reform, including a constitutional system based on a series of *dumas*, the cantonal assembly (*volost*) electing the *duma* of the district, the *dumas* of the districts electing that of the province or government, and these electing the *Duma* of the empire. As mediating power between the autocrat and the *Duma* there was to be a nominated council of state. This plan, worked out by Speranski in 1809, was for the most part stillborn, only the council of the empire coming into existence in January 1810; but it none the less, to quote M. Chesle,¹ dominated the constitutional history of Russia in the 19th century and the early years of the 20th. The *Duma* of the empire created in 1905 bears the name suggested by Speranski, and the institution of local self-government (the *zemstvos*) in 1864 was one of the reforms proposed by him. Speranski's labours also bore fruit in the constitutions granted by Alexander to Finland and Poland.

From 1809 to 1812 Speranski was all-powerful in Russia, so far as any minister of a sovereign so suspicious and so unstable as Alexander could be so described. He replaced the earlier favourites, members of the "unofficial committee," in the tsar's confidence, becoming practically sole minister, all questions being laid by him alone before the emperor and usually settled at once by the two between them. Even the once all-powerful war-minister Arakcheyev was thrust into the background. Speranski used his immense influence for no personal ends. He was an idealist; but in this very fact lay the seeds of his failure. Alexander was also an idealist, but his ideals were apt to centre in himself; his dislike and distrust of talents that overshadowed his own were disarmed for a while by the singular charm of Speranski's personality, but sooner or later he was bound to discover that he himself was regarded as but the most potent instrument for the attainment of that ideal end, a regenerated Russia, which was his minister's sole preoccupation. In 1810 and the first half of 1811 Speranski was still in high favour, and was the confidant of the emperor in that secret diplomacy which preceded the breach of Russia with Napoleon.² He had, however, committed one serious mistake. An ardent freemason himself, he conceived in 1809 the idea of reorganizing the order in Russia, with the special object of using it to educate and elevate the Orthodox clergy. The emperor agreed to the first steps being taken, namely the suppression of the existing lodges; but he was naturally suspicious of secret societies, even when ostensibly admitted to their secrets, and Speranski's abortive plan only resulted in adding the clergy to the number of his enemies.

¹ *Le Parlement russe* (Paris, 1910), p. 21

² Schiemann, *Gesch. Russlands*, i. 77.

On the eve of the struggle with Napoleon, Alexander, conscious of his unpopularity, conceived the idea of making Speranski his scape-goat, and so conciliating that Old Russian sentiment which would be the strongest support of the autocratic tsar against revolutionary France. Speranski's own indiscretions gave the final impulse. He was surrounded with spies who reported, none too accurately, the minister's somewhat sharp criticisms of the emperor's acts; he had even had the supreme presumption to advise Alexander not to take the chief command in the coming campaign. A number of persons in the *entourage* of the emperor, including the grand-duchess Catherine, Karamzin, Rostopchin and the Swedish general Baron Armfield, intrigued to involve him in a charge of treason.¹ Alexander did not credit the charge, but he made Speranski responsible for the unpopularity incurred by himself in consequence of the hated reforms and the still more hated French policy, and on the 17th-29th of March 1812 dismissed him from office. Reinstated in the public service in 1816, he was appointed governor-general of Siberia, for which he drew up a new scheme of government, and in 1821 entered the council of state. Under Nicholas I., he was engaged in the codification of the Russian law (published in 1830 in 45 vols.), on which he also wrote some important commentaries.

See the biography (in Russian) by M. Korff (St Petersburg, 1861). On his public life and constitutional reforms see Theodor Schieman, *Geschichte Russlands unter Kaiser Nikolaus I.*, Bd. i. *Kaiser Alexander I.* p. 75 seq. (Berlin, 1904); Pierre Chasles, *Le Parlement russe* p. 19 seq. (Paris, 1910), and the works of V. Vagin (St Petersburg, 1872 and Moscow, 1905). Count Nesselrode's letters to Speranski and many references are published in vol. iii. of the *Lettres et papiers du comte de Nesselrode*.

SPERMACETI (from Lat. *sperma*, seed, and *ctus*, a whale), a wax found in the head cavities and blubber of the sperm-whale (*Physeter macrocephalus*), where it is dissolved in the sperm oil while the creature is living; it also occurs in other Cetacea (see WHALE OILS). At a temperature of about 6° C. the solid matter separates in a crystalline condition, and when purified by pressure and treatment with weak solution of caustic alkali it forms brilliant white crystalline scales or plates, hard, but unctuous to the touch, and destitute of taste or smell. It is quite insoluble in water, very slightly affected by boiling alcohol, but easily dissolved in ether, chloroform, and carbon bisulphide. Spermaceti consists principally of cetin or cetyl palmitate, $C_{15}H_{31}CO_2C_{16}H_{33}$. The substance is used in making candles of standard photometric value, in the dressing of fabrics, and in medicine and surgery, especially in cerates, bougies, ointments, and in cosmetic preparations.

SPERM-WHALE, or CACHALOT (*Physeter macrocephalus*), the largest representative of the toothed whales, its length and bulk being about equal to, or somewhat exceeding those of the Arctic right-whale, from which, however, it is very different



The Sperm-Whale (*Physeter macrocephalus*).

in appearance and structure. The head is about one-third of the length of the body, very massive, high and truncated in front; and owing its size and form mainly to the accumulation of a peculiarly modified form of fatty tissue in the large hollow on the upper surface of the skull. The oil contained in cells in this cavity, when refined, yields spermaceti, and the thick covering of blubber, which everywhere envelops the body, produces the valuable sperm-oil of commerce. The single blowhole is a longitudinal slit, placed at the upper and anterior extremity of the head to the left side of the middle line. The opening of the mouth is on the under side of the head, considerably behind the end of the snout. The lower jaw is extremely narrow, and

¹ See Schieman, *op. cit.*, i. 81.

has on each side from twenty to twenty-five stout conical teeth, which furnish ivory of good quality, though not in sufficient bulk for most of the purposes for which that article is required. The upper teeth are rudimentary and buried in the gum. The flipper is short, broad, and truncated, and the dorsal fin a mere low protuberance. The general colour of the surface is black above and grey below, the colours gradually shading into each other. The sperm-whale is one of the most widely distributed of animals, being met with, usually in herds or "schools," in almost all tropical and subtropical seas, and occasionally visiting the northern seas, a number having been killed around the Shetlands a few years ago. The food of sperm-whales consists mainly of squid and cuttlefish, but also comprises fish of considerable size. The substance called "ambergris," formerly used in medicine and now in perfumery, is a concretion formed in the intestine of this whale, and found floating on the surface of the sea. Its genuineness is proved by the presence of the horny beaks of the cuttles on which the whale feeds. The one representative of the genus *Cogia* is called the lesser or pigmy sperm-whale, being only from 9 ft. to 13 ft. long.

SPES, in Roman mythology, the personification of Hope. Originally a nature goddess (like Venus the garden goddess, with whom she was sometimes identified), she represented at first the hope of fruitful gardens and fields, then of abundant offspring, and lastly of prosperity to come and good fortune in general, being hence invoked on birthdays and at weddings. Of her numerous temples at Rome, the most ancient was appropriately in the forum olitorium (vegetable market), built during the first Punic war, and since that time twice burnt down and restored. The day of its dedication (August 1) corresponded with the birthday of Claudius, which explains the frequent occurrence of Spes on the coins of that emperor. Spes is represented as a beautiful maiden in a long light robe, lifting up her skirt with her left hand, and carrying in her right a bud already closed or about to open. Sometimes she wears a garland of flowers on her head, ears of corn and poppy-heads in her hand, symbolical of a prosperous harvest. Like Fortune, with whom she is often coupled in inscriptions on Roman tombstones, she was also represented with the *cornu copiae* (horn of plenty).

See G. Wissowa, *Religion und Kultus der Römer* (1902), according to whom Spes was originally not a garden goddess, but simply the divinity to whom one prayed for the fulfilment of one's desires.

SPESSART, a highland forest country of Germany, belonging mainly to the Bavarian province of Lower Franconia, but in the north to the Prussian province of Hesse Cassel, and it is bounded on the S. and W. by the Main, on the E. by the Sinn and on the N. by the Kinzig and Joss. The main ridge of the formation, consisting of gneiss, granite and red sandstone, runs from a point opposite Miltenberg, in a north-westerly direction to the source of the Kinzig near Schlüchtern—a distance of 45 m.—and attains its highest elevation in the Geiersberg (1919 ft.), which lies north of the Rohrbrunn pass, through which runs the main road from Aschaffenburg to Würzburg. The forest, with which it is densely covered, consists of oak, beech, ash and fir, and the scenery, especially on the main side, between Gemünden and Lohr, is impressive. The climate is inclement in winter and oppressively hot in midsummer. The inhabitants are engaged chiefly in woodcutting, raft-making and quarrying, and most of the timber is floated down to Holland. Cobalt, silver, lead and copper are also worked, and the southern and western slopes yield wine of good quality. This beautiful tract of country until recent years was comparatively little known to the tourist, but a club (*Spessart Klub*) through the establishment of finger-posts and the issue of maps, has indicated the more interesting tours to be followed.

See Bücking, *Der nordwestliche Spessart, geologisch aufgenommen* (Berlin, 1893); Schober, *Führer durch den Spessart* (Aschaffenburg, 1904); Wolff, *Der Spessart, sein Wirtschaftsleben* (ibid., 1905).

SPEUSIPPUS (4th century B.C.), Greek philosopher, son of Eurymedon and Potone, sister of Plato, is supposed to have been born about 407 B.C. He was bred in the school of Isocrates;

but, when Plato returned to Athens about 387, yielded to his influence and became a member of the Academy. In 361, when Plato undertook his third and last journey to Sicily, Speusippus accompanied him. In 347 the dying philosopher nominated his nephew to succeed him as scholarch, and the choice was ratified by the school. Speusippus held the office for eight years, and died in 339 after a paralytic seizure. According to some authorities he committed suicide. There is a story that his youth was riotous, until Plato's example led him to reform his ways. In later life he was conspicuously temperate and amiable. He was succeeded by Xenocrates.

Of Speusippus's many philosophical writings nothing survives except a fragment of a treatise *On Pythagorean Numbers*. Nor have secondary authorities preserved to us any general statement or conspectus of his system. Incidentally, however, we learn the following details. (A) In regard to his theory of being: (1) whereas Plato postulated as the basis of his system a cause which should be at once Unity, Good, and Mind, Speusippus distinguished Unity, the origin of things, from Good, their end, and both Unity and Good from controlling Mind or Reason; (2) whereas Plato recognized three kinds of numbers—firstly, ideal numbers, *i.e.* the "determinants" or ideas; secondly, mathematical numbers, the abstractions of mathematics; and thirdly sensible numbers, numbers embodied in things—Speusippus rejected the ideal numbers, and consequently the ideas; (3) Speusippus traced number, magnitude and soul each to a distinct principle of its own. (B) In regard to his theory of knowledge: (4) he held that a thing cannot be known apart from the knowledge of all things besides; for, that we may know what a thing is, we must know how it differs from other things, which other things must therefore be known; (5) accordingly, in the ten books of a work called *Ὅμοια*, he attempted a classification of plants and animals; (6) the results thus obtained he distinguished at once from "knowledge" (*ἐπιστήμη*) and from "sensation" (*αἴσθησις*), holding that "scientific observation" (*ἐπιστημονικὴ αἴσθησις*), though it cannot attain to truth, may, nevertheless, in virtue of a certain acquired tact, frame "definitions" (*λόγοι*). (C) In regard to his theory of ethics: (7) he denied that pleasure was a good, but seemingly was not prepared to account it an evil.

In default of direct evidence, it remains for us to compare these scattered notices of Speusippus's teaching with what we know of its original, the teaching of Plato, in the hope of obtaining at least a general notion, firstly, of Speusippus's system, and, secondly, of its relations to the systems of Plato, of contemporary Platonists, such as Aristotle, and of the later Academy.

It has been suggested elsewhere (see SOCRATES) that the crude and unqualified "realism" of Plato's early manhood gave place in his later years to a theory of natural kinds founded upon a "thoroughgoing idealism," and that in this way he was led to recognize and to value the classificatory sciences of zoology and botany. More exactly, it may be said that the Platonism of Plato's maturity included the following principal doctrines: (i.) the supreme cause of all existence is the One, the Good, Mind, which evolves itself as the universe under certain eternal immutable forms called "ideas"; (ii.) the ideas are apprehended by finite minds as particulars in space and time, and are then called "things"; (iii.) consequently the particulars which have in a given idea at once their origin, their being, and their perfection may be regarded, for the purposes of scientific study, as members of a natural kind; (iv.) the finite mind, though it cannot directly apprehend the idea, may, by the study of the particulars in which the idea is revealed, attain to an approximate notion of it.

Now when Speusippus (1) discriminated the One, the Good, and Mind, (2) denied the ideas, and (3) abandoned the attempt to unify the plurality of things, he explicitly rejected the theory of being expressed in (i.) and (ii.); and the rejection of the theory of being, *i.e.* of the conception of the One evolving itself as a plurality of ideas, entailed consequential modifications in the theory of knowledge conveyed in (iii.) and (iv.). For, if the members of a natural kind had no common idea to unite them,

scientific research, having nothing objective in view, could at best afford a *λόγος* or definition of the appropriate particulars; and, as the discrimination of the One and the Good implied the progression of particulars towards perfection, such a *λόγος* or definition could have only a temporary value. Hence, though, like Plato, Speusippus (4) studied the differences of natural products (5) with a view to classification, he did not agree with Plato in his conception of the significance of the results thus obtained; that is to say, while to Plato the definition derived from the study of the particulars included in a natural kind was an approximate definition of the idea in which the natural kind originated, to Speusippus the definition was a definition of the particulars studied, and, strictly speaking, of nothing else. Thus while Plato hoped to ascend through classificatory science to the knowledge of eternal and immutable laws of thought and being, Speusippus, abandoning ontological speculation, was content to regard classificatory science not as a means but as an end, and (6) to rest in the results of scientific observation. In a word, Speusippus turned from philosophy to science.

It may seem strange that, differing thus widely from his master, Speusippus should have regarded himself and should have been regarded by others as a Platonist, and still more strange that Plato should have chosen him to be his successor. It is to be observed, however, firstly, that the scientific element occupied a larger place in Plato's later system than is generally supposed,¹ and, secondly, that other Academics who came into competition with Speusippus agreed with him in his rejection of the theory of ideas. Hence Plato, finding in the school no capable representative of his ontological theory, might well choose to succeed him a favourite pupil whose scientific enthusiasm and attainment were beyond question; and Speusippus's rivals, having themselves abandoned the theory of ideas, would not be in a position to tax him with his philosophical apostasy.

In abandoning the theory of ideas—that is to say, the theory of figures and numbers, the possessions of universal mind, eternally existent out of space and time, which figures and numbers when they pass into space and time as the heritage of finite minds are regarded as things—Speusippus had the approval, as of the Platonists generally, so also of Aristotle. But, whereas the new scholarch, confining himself to the detailed examination of natural kinds, attempted no comprehensive explanation of the universe, Aristotle held that a theory of its origin, its motions, and its order was a necessary adjunct to the classificatory sciences; and in nearly all his references to Speusippus he insists upon this fundamental difference of procedure. Conceiving that the motions of the universe and its parts are due to the desire which it and they feel towards the supreme external mind and its several thoughts, so that the cosmical order planned by the divine mind is realized in the phenomenal universe, Aristotle thus secures the requisite unification, not indeed of mind and matter, for mind and matter are distinct, but of the governing mind, the prime unmoved movent, since it and its thoughts are one. Contrariwise, when Speusippus distinguishes One, Good, and Mind, so that Mind, not as yet endowed with an orderly scheme, adapts the initial One to particular Goods or ends, his theory of nature appears to his rival "episodic," *i.e.* to consist of a series of tableaux wanting in dramatic unity, so that it reminds him of Homer's line—*οὐκ ἀγαθὸν πολυκοιρανίῃ ἕϊς κοίρανος ἔστω*.

Speusippus and his contemporaries in the school exercised an important and far-reaching influence upon Academic doctrine. When they, the immediate successors of Plato, rejected their master's ontology and proposed to themselves as ends mere classificatory sciences which with him had been means, they bartered their hope of philosophic certainty for the tentative and provisional results of scientific experience. Xenocrates indeed, identifying ideal and mathematical numbers, sought to

¹ That Plato did not neglect, but rather encouraged, classificatory science is shown, not only by a well-known fragment of the comic poet Epicrates, which describes a party of Academics engaged in investigating, under the eye of Plato, the affinities of the common pumpkin, but also by the *Timaeus*, which, while it carefully discriminates science from ontology, plainly recognizes the importance of the study of natural kinds.

shelter himself under the authority of Plato; but, as the Xenocratean numbers, though professedly ideal as well as mathematical, were in fact mathematical only, this return to the Platonic terminology was no more than an empty form. It would seem, then, that Academic scepticism began with those who had been reared by Plato himself, having its origin in their acceptance of the scientific element of his teaching apart from the ontology which had been its basis. In this way, and, so far as the present writer can see, in this way only, it is possible to understand the extraordinary revolution which converted Platonism, philosophical and dogmatic, into Academicism, scientific and sceptical. It is as the official representative of this scientific and sceptical departure that Speusippus is entitled to a place in the history of philosophy.

BIBLIOGRAPHY.—J. G. F. Ravaisson, *Speusippi de primis rerum principis placita* (Paris, 1838); Chr. Aug. Brandis, *Geschichte der griechisch-römischen Philosophie* (Berlin, 1853), II. ii. 1; Zeller, *Die Philosophie d. Griechen* (Leipzig, 1875), II. i.; Mullach, *Fragmenta philosophorum Graecorum*, iii. 62–69 (Paris, 1881). (H. J.A.)

SPEY, a river in the Highlands of Scotland. It rises in Mt Clach-a-Cheannaiche in the north of Lochaber, in Inverness-shire, at a height of 1497 ft. above the sea. A mile from its source it forms the small Loch Spey, and 31 m. lower down it expands into the larger Loch Inch. After crossing the boundary of Elginshire, below Grantown, it pursues an extremely serpentine course, as far as Craigellachie, where it begins to flow due northwards, becoming wholly a Moray stream as it approaches Fochabers, and falling by several mouths into the Moray Firth at Kingston. Its total length is about 110 m. It is the most rapid river in Scotland and is nowhere properly navigable, though at Speymouth in its lowest reaches some ship-building has been intermittently carried on. The strength of its current is due partly to its lofty origin, and partly to the volume of water contributed by numberless affluents from the mountainous regions of its birth. The more important tributaries are, on the left, the Markie, Calder, Dulnain, Tulchan, Ballintomb and Rothes and, on the right, the Mashie, Truim, Tromie, Feshie, Nethy, Avon, Fiddich and Mulben. Its area of drainage is 1300 sq. m. At certain points the stream attains a considerable width, as at Alvie, where it is 150 ft. wide, and at Kingussie, where its width is from 80 to 100 ft. From below Craigellachie, and especially on the low-lying coast-land, pools or stretches of fair size become frequent. For beauty of scenery Strathspey holds its own with any of the great valleys of Scotland. As a salmon river the Spey yields only to the Tay and Tweed. It passes many interesting spots in its long career, such as Laggan; Cluny Castle, the seat of Cluny Macpherson; Craig Dhu, the "black rock," and Kingussie. It flows past the pine forests of Rothiemurchus; Granton, the capital of Strathspey; Cromdale, where the clansmen suffered defeat at the hands of William III.'s troops in 1690; Ballindalloch, with a splendid Scottish baronial castle, the seat of the Macpherson-Grants; and Charlestown of Aberlour and its fine cataract.

SPEZIA, a city of Liguria, Italy, in the province of Genoa, 56 m. S.E. of that town by rail, 49 ft. above sea-level. Pop. (1906), 41,773 (town); 75,756 (commune); in 1861 only 11,556. It is the chief naval harbour of Italy, having been adopted as such in 1861. The Bay of Spezia is sheltered from all except southerly winds, and on its western shore are numerous openings, which afford perfectly safe anchorage in all weathers. The entrance is protected by forts, while a submarine embankment, 2 m. long, renders it secure. The arsenal consists of three departments, the principal of which is 3937 ft. long, with an average width of 2460 ft. The chief basin is 23 acres in extent, and the second—connected with the first by a canal 91 ft. wide—36 acres. Both basins have an average depth of between 33 and 35 ft. The second basin gives access to the docks, of which there are six; two 390 ft. long, two 420 ft. long, one 500 ft. long, and one 650 ft. long. The establishment of San Vito is devoted entirely to the production of artillery; that of San Bartolomeo is exclusively used for electrical works and the manufacture of submarine weapons, especially torpedoes. The arsenal was

constructed by General Chiodo (d. 1870), whose statue rises at the entrance, and near it are the naval barracks and hospital. Though the town itself, with the barracks and military hospital as its principal buildings, presents little to attract the foreign visitor, the beauty of the gulf and of the neighbouring country has brought Spezia into some repute as a winter resort, and it is also visited in summer for sea-bathing. The walls and gates of the old city are for the most part destroyed. The opening of a railway across the Apennines (there is a branch leaving the coast line at Vezzano, and joining the line from Sarzana at S. Stefano di Magra), placed Spezia in communication with Parma and the most fertile regions of the Po valley, and so stimulated commerce that a new commercial port to the east of the city was built. This harbour consists of a broad quay with 657 ft. of wharfage, and of a mole 1639 ft. long with 984 ft. of wharfage. The basin of the harbour is about 26 ft. deep. A branch railway connects the wharves directly with the main line. Since the opening of the new port the traffic has considerably increased, and it exports oil, pig-lead, silver, flour, wine, marble and sandstone for paving purposes, while it imports quantities of coal, iron, cereals, phosphates, timber, pitch, petroleum, and mineral oils. The import of coal in 1906 was 439,494 tons, being nearly double the average for 1901–1905. The tonnage of vessels entered was over 600,000, an increase of about 25% on that of 1905. Several important industrial establishments lie along the bay, including large lead and silver works at Pertusola (see LERIC), submarine cable works, a shipyard at Muggiano for the construction of mercantile vessels up to 10,000 tons, a branch of the Vickers Terni works for armour plate, several motorboat works, brick and tile works, &c.

The origin of Spezia is doubtful; but it probably rose after the destruction of Luna. Sold by one of the Fieschi in 1276 to Genoa, the town was fortified by its new possessors and made the seat of a governor of some importance. It became a city in the 16th century. The idea of making the Gulf of Spezia a great naval centre was first broached by Napoleon I.

SPHAERISTERIUM (Gr. *σφαιριστήριον*, *σφαῖρα*, ball), the term in Classic architecture given to a large open space connected with the Roman *thermae*, for exercise with balls after the bather had been anointed; they were also provided in the Roman villas.

SPHENE, a mineral consisting of calcium titanate-silicate, CaTiSiO_6 , crystallizing in the monoclinic system. The crystals vary considerably in habit, but are generally thin and wedge-shaped; hence the name *sphene*, from the Greek *σφήν* (a wedge), given by R. J. Haty in 1801. The earlier name *titanite*, given by M. H. Klaproth in 1795, is also in common use. Twinning on the ortho-pinacoid is not uncommon. The colour is green, yellow, brown or black, and the lustre resinous to adamantine; crystals are transparent to opaque. The hardness is $5\frac{1}{2}$, and the specific gravity 3.5. The refractive indices and the optic axial angle vary considerably with the colour of the light: the dispersion of the optic axes is inclined, and the interference figure seen in convergent light between crossed nicols is very characteristic of the mineral. *Sphene* is sometimes cut as a gem-stone, though it is rather too soft to stand much wear; owing to its high dispersive power it gives brilliant flashes of prismatic colours. As small embedded crystals, *sphene* has a wide distribution as an accessory constituent of many kinds of igneous rocks (granite, syenite, trachyte, phonolite, &c.), and also of gneiss, schist and crystalline limestone. Sharply-developed, transparent, pale green crystals are frequently associated with *adularia*, *asbestos* and *quartz* in the crystal-lined crevices of the schists of the Swiss and Tyrolean Alps. Large, rough and dark-coloured crystals are found at Arendal and Kragerö in Norway, and in granular limestone at Diana in New York and Eganville in Ontario. A greyish, compact and impure variety of *sphene*, known as

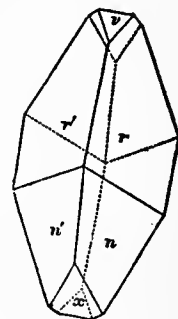

"leucoxene," frequently occurs in basic igneous rocks as an alteration product of ilmenite and rutile. (L. J. S.)

SPHENODON, or TUATARA. *Sphenodon* s. *Hatteria* (called by Gray after Hatter), with one species, *S. punctatum*, is the sole surviving member of the whole group of *Rhynchocephalia* (q.v. under REPTILES, *Fossil*). It is one of the few reptiles inhabiting New Zealand; formerly common on the main islands, now restricted to some of the small, uninhabited islands in the Bay of Plenty, where these last "living fossils" enjoy the protection of the government. The Maoris call it *ruatara*, *tuatete* or *tuatara*, the latter meaning "having spines." This creature represents an almost ideally generalized type of reptile. The total length of large males is more than two feet, but mature females are scarcely half this size. In general appearance they much resemble the *Agamidae*, especially *Uromastix*, or *Physignathus*, with the massive head, the chisel-shaped front teeth, short legs and erectile crest of cutaneous spines on the head and along the mid-line of the trunk and tail, whilst the rest of the dark olive-green skin is granular, with yellowish specks. But the Agamoid resemblance is only skin-deep, and only the tyro can confound them with any group of Lacertilia. At the same time it is probable that *Sphenodon* stands near the ancestral root of the Lacertilia, before these divided into geckos, chameleons, and lizards proper. The development of this animal has been first studied by G. B. Howes, who quotes the literature bearing upon the whole subject. A good account of the habits of the tuatara has been given by Newman. They live upon animals, but these are only taken when alive and moving about, e.g. fish, worms, insects. Sluggish in their habits, they sleep during the greater part of the day in their self-dug burrows, and are very fond of lying in the water, and they remain below for hours without breathing. Each individual excavates its own hole, a tunnel leading into a roomy chamber, lined with grass and leaves; part of the habitation is shared socially by a family of petrels, which is said to occupy usually the left side, whilst the tuatara itself lives a solitary life. The male croaks or grunts much during the pairing season; the hard-shelled, long-oval eggs, about 28 mm. long, are laid in holes in the sand, about ten in one nest, from November to January or February. They contain nearly ripe embryos in the following August, but they are not hatched until about thirteen months old; in the meantime they seem to undergo a kind of hibernation, their nasal chambers becoming blocked with proliferating epithelium, which is resolved shortly before hatching during the southern summer. In spite of their imposing, rather noble appearance, when, with their heads erect, they calmly look about with their large quiet eyes, they are dull creatures, but they bite furiously.

For life history see A. K. Newman, *Trans. New Zealand Inst.* (1878), x. 222; Von Haast, *ibid.* (1881), xiv. 276; Reischek, *ibid.* xiv. 274; A. Dendy, *ibid.* (1899), xxxi. 245; *Nature*, 59, 340. For development; G. B. Howes and H. H. Swinnerton, *Trans. Zool. Soc.* (1900), xv. 1-86, six plates; A. Dendy, *Quart. Journ. Mic. Sci.* (1899), 42, pp. 1-87, ten plates and *ibid.* pp. 111-153 (parietal eye); H. Schauinsland, *Arch. mikr. Anat.* (1900), 56, pp. 747-867, plates. For anatomy: A. Günther, *Phil. Trans.* (1867), 157, pp. 595-629, plates; A. K. Newman, quoted above; F. J. Knox, *Trans. New Zealand Inst.* (1869) ii. 17-20; G. Osawa, *Arch. mikr. Anat.* (1898), 51, pp. 481-690, and *ibid.* 52, pp. 268-366. (H. F. G.)

SPHERE (Gr. σφαῖρα, a ball or globe), in geometry, the solid or surface traced out by the revolution of a semicircle about its diameter; this is essentially Euclid's definition;¹ in the modern geometry of surfaces it is defined as the quadric surface passing through the circle at infinity. Every point is equidistant from a fixed point within the surface; this point is the "centre," the constant distance the "radius," and any line through the centre and intersecting the sphere is a "diameter." All sections of the

¹ The surfaces formed by revolving a circle about any chord also received attention at the hands of the Greeks. According to Heron and Geminus they were discussed under the name *spire* by Perseus (c. 200-100 B.C.), their sections were termed *spiral sections*, and are probably the same as the *hippopede* of Eudoxus. The surface and solid traced by the revolution of the lesser segment of a circle is termed a "spindle." An "anchor ring" or "tore" results when a circle revolves about an axis in its plane.

sphere are necessarily circles; if the cutting plane contains the centre, the section is said to be "meridional," the curve of intersection is a "great circle," and the solid cut off a "hemisphere." If the plane does not contain the centre, the curve of intersection is a "small circle," and the solid cut off is a "segment." "Great" circles may also be defined as circles on a sphere which pass through the extremities of a diameter; they are familiar as the meridians or lines of longitude of geographers; lines of latitude are "small circles." The shortest distance between two points on a sphere is the arc of the great circle containing the points. This proposition is the basis of the "great circle sailing" of navigators, and the arc of the great circle is called the "rumb-line" or "loxodromic curve." The determination of the shortest distance between two small circles on a sphere is given in the article VARIATIONS, CALCULUS OF. The extremities of the diameter perpendicular to a small circle are called the "poles" of that circle, and the distance from the pole to the circle, measured by the arc of the great circle through the pole, is the "polar distance" of the small circle. The solid enclosed by a small circle and the radii vectores from the centre of the sphere is a "spherical sector"; and the solid contained between two spherical sectors standing on copolar small circles is a "spherical cone." A "spherical sector" and "spherical cone" may be also regarded as the solids of revolution of a circular sector about one of its bounding radii, and about any other line through the vertex respectively. The solid intercepted between two parallel planes is a "zone."

The geometry of the sphere was studied by the Greeks; Euclid, in book xii. of his *Elements*, discusses various properties of the sphere, and in book xiii. he shows how to inscribe the five regular polyhedra within it. But with the sole exception of proving that the volumes of spheres are in the triplicate ratio of their diameters, a theorem probably due to Eudoxus, no mention is made of its mensuration. This subject was investigated by Archimedes, who, by his "method of exhaustions," derived the principal results. He showed that the surface of a segment is equal to the area of the circle whose radius equals the distance from the vertex to the base of the segment; that the surface of the entire sphere is equal to the curved surface of the circumscribing cylinder, and to four times the area of a great circle of the sphere; and that the volume is two-thirds that of the circumscribing cylinder. To Zenodorus (c. 200-100 B.C.) is due the important problem in maxima and minima that for a given surface the sphere is the solid of maximum volume. Calling the radius r , and denoting by π the ratio of the circumference to the diameter of a circle, the volume is $\frac{4}{3}\pi r^3$, and the surface $4\pi r^2$.

Archimedes gave his results in the treatise *Περὶ τῆς σφαίρας καὶ τοῦ κυλίνδρου*: he left unfinished the problem of dividing a sphere into segments whose volumes are in a given ratio. A solution by means of the parabola and hyperbola was given by Dionysodorus of Amisus (c. 1st century B.C.), and a similar problem—to construct a segment equal in volume to a given segment, and in surface to another segment—was solved by the Arabian mathematician and astronomer, Al Kuhi.

In analytical geometry, the equation to the sphere takes the forms $x^2 + y^2 + z^2 = a^2$, and $r = a$, the first applying to rectangular Cartesian co-ordinates, the second to polar, the origin being in both cases at the centre of the sphere. If the centre be (α, β, γ) , the Cartesian equation becomes $(x - \alpha)^2 + (y - \beta)^2 + (z - \gamma)^2 = a^2$; consequently the general equation is $x^2 + y^2 + z^2 + 2Ax + 2By + 2Cz + D = 0$, and it is readily shown that the co-ordinates of the centre are $(-A, -B, -C)$, and the radius $\sqrt{A^2 + B^2 + C^2 - D}$. A sphere can therefore be described so as to satisfy four given conditions. Systems of spheres have characters analogous to those of systems of circles. If r, r_1 be the radii of two spheres, d the distance between the centres, and ϕ the angle at which they intersect, then $d^2 = r^2 + r_1^2 + 2rr_1 \cos \phi$; hence $2rr_1 \cos \phi = d^2 - r^2 - r_1^2$. This function is named the "power" of the two spheres, and it is important in the investigation of systems of spheres. If the sphere r_1 degenerate to a point, the function $2rr_1 \cos \phi$ has the limit $d^2 - r^2$; this is the square of the tangent to the sphere from the point, and is named the "power of the sphere at the point," or the "power of the point with respect to the sphere." Two spheres intersect in a plane, and the equation to a system of spheres which intersect in a common circle is $x^2 + y^2 + z^2 + 2Ax + D = 0$, in which A varies from sphere to sphere, and D is constant for all the spheres, the plane yz being the plane of intersection, and the axis of x the line of centres. Corresponding to the radical centre of three circles, it may be shown that four spheres have a radical centre, i.e. that there exists a point such that the tangents from this point to the four spheres are equal, and that with this point as centre, and the length of the tangent as radius, a sphere may be described which

cuts the four spheres at right angles; this "orthotomic" sphere corresponds to the orthogonal circle of a system of circles.

The investigation of triangles and other figures drawn upon the surface of a sphere is all-important in the sciences of astronomy, geodesy and geography. In astronomy, we are principally concerned with the orientation of points on a sphere—the so-called celestial sphere—with regard to certain planes and points within the sphere; this subject is treated in the article ASTRONOMY (*Spherical*). In "geodesy," and the cognate subject "figure of the earth," the matter of greatest moment with regard to the sphere is the determination of the area of triangles drawn on the surface of a sphere—the so-called "spherical triangles"; this is a branch of trigonometry, and is studied under the name of spherical trigonometry. In mathematical geography the problem of representing the surface of a sphere on a plane is of fundamental importance; this subject is treated in the article MAP.

SPHERES, MUSIC OF THE, in Pythagorean philosophy, the harmony produced by the heavenly bodies in their orbits, inaudible to human ears. Pythagoras (cf. Arist. *de Caelo*, ii. 9) held that the movements of stars were governed by fixed laws which could be expressed in numbers according to the numbers which give the harmony of sounds (see PYTHAGORAS, *ad fin.*). It is this theory to which Shakespeare alludes in *The Merchant of Venice* (Act. v. i. seq.: "such harmony is in immortal souls, but . . . we cannot hear it"). According to Gomperz (*Greek Thinkers*, i. 118, Eng. trans.) "there was nothing fanciful in the Pythagorean doctrine except only the belief that the differences of velocity in the movements of the stars were capable of producing a harmonious orchestration and not merely sounds of varying pitch."

SPHERES OF INFLUENCE. "Spheres of influence," "spheres of action," "spheres of interest," "zones of influence," "field of operations," "Machtssphäre," "Interessensphäre," are phrases in international law which have come into use to describe regions as to which nations have agreed that one or more of them shall have exclusive liberty of action. These phrases became common after 1882, when the "scramble for Africa" began, to describe diplomatic arrangements with respect to it. Some definitions may be quoted—when secretary of state for the colonies, Lord Knutsford, replying to a deputation in 1890, said: "'Sphere of action' is a term I do not wish to define now; but it amounts to this: we should not allow the Portuguese, Germans, or any foreign nation or republic to settle down and annex the territory" (quoted in Keane's *Compendium of Geography*, i. 21). "The term 'sphere of influence' implies an engagement between two states that one of them will abstain from interfering or exercising influences within certain territories which, as between the contracting parties, are reserved for the operation of the other" (Ilbert, *Government of India*, 2nd ed., p. 370). "Unter 'Interessensphäre' oder 'Machtssphäre' versteht man nämlich das auf Grund von Vereinbarungen unter den beteiligten Kolonialstaaten abgegrenzte Gebiet, innerhalb dessen ein Staat ausschliesslich berechtigt ist, seine koloniale Herrschaft durch Besitzergreifung oder Abschluss von Protectoratsverträgen zu begründen, oder doch einen für die in diesem Gebiete vorhandenen Völkerschaften massgebenden politischen Einfluss auszuüben" (Stengel, *Die deutschen Schutzgebiete*, p. 18). "The term 'sphere of influence or sphere of interest' has been given an extended meaning by recent developments. Formerly it was used to signify a region wherein a nation, through its citizens, had acquired commercial or industrial interests without having asserted any political protectorate or suzerainty. To-day, as used in China and elsewhere, the term applies rather to a region pre-empted for further exploitation and possibly for political control" (Dr Reinisch's *Politics*, pp. 60, 61). "A portion of a non-Christian or uncivilized country which is the subject of diplomatic arrangements between European states, but has not yet developed into a protectorate" (Jenkin's *British Rule and Jurisdiction beyond the Seas*). See also Hall, 6th ed., 129.

The reasons for making these arrangements are to be explained partly by reference to the history of international law as to occupation. The Roman jurists recognized certain "natural modes" of acquiring property, in particular *traditio* and *occupatio*. The doctrines which the Roman jurists had worked

out as to acquisition of private property by occupation were applied to the appropriation by states or their subjects of vacant lands (*res nullius*), including lands in the possession of barbarous tribes. "Quod enim nullius est, id *Discoverer* ratione naturali occupanti conceditur" (*Institutes, and Occupation. domini*)—there must be seizure for and on behalf of the owner. There must be "*apprehensio*. Apiscimur possessionem corpore et animo, neque per se animo aut per se corpore" (*Dig.* xli. 2-3). Professing to act on these doctrines, and relying also on an assumed right on the part of Christian nations to subdue obdurate non-Christian communities, the navigators and explorers of the 15th and 16th centuries made exorbitant claims. Having occupied certain points on the coast-line, they claimed to have occupied a whole island or continent (De Martens i. 462). They made vast claims under Papal bulls; for example, under the bull of Nicholas V. of 1454, and the bull of Alexander VI. of 1494, which assigned to the Portuguese the empire of Guinea just discovered. It was one of Grotius's services to diffuse sounder ideas, and to point out that Roman law gave no support to these pretensions: "Invenire non illud est oculis usurpare, sed apprehendere" (*Mare liberum*, c. 2). He insisted that "occupatio autem publica eodem modo fit quo privata territoria sunt ex occupationibus populorum ut privata dominia ex occupationibus singulorum." In recent times the old doctrine that discovery without occupation confers an independent right to the land so discovered of any extent is discredited. The tendency is to insist on actual occupation as a condition of legitimate possession or sovereignty (see correspondence between Great Britain and Portugal, State Papers 79, p. 1062), and to treat the discoverer's right as merely inchoate. Thus, in opening the conference at Berlin in 1884, Prince Bismarck said: "Pour qu'une occupation soit considérée comme effective, il est, de plus, à désirer que l'acquéreur manifeste, dans délai raisonnable, par des institutions positives, la volonté et le pouvoir d'y exercer ses droits et de remplir les devoirs qui en résultent." This doctrine is recognized in articles 34 and 35 of the General Act of Berlin, the former of which states that "any Power which henceforth takes possession of a tract of land on the coast of the African continent outside its possessions, or which being hitherto without such possessions shall acquire them, as well as the Power which assumes a protectorate, shall accompany the respective act with a notification thereof, addressed to the other Signatory Powers of the present act, in order to enable them, if need be, to make good any claim of their own." To a similar effect wrote Lord Salisbury in 1887 with reference to the claims of Portugal in East Africa. "Great Britain considers that it has been admitted in principle by all the parties to the act of Berlin that a claim of sovereignty in Africa can only be maintained by real occupation of the territory claimed; and that the doctrine has been practically applied in the recent Zambezi delimitation (State Papers 79, p. 1063). No paper annexation of territory can pretend to validity as a bar to the enterprise of other nations." At its session at Lausanne, in 1889, the Institut de Droit International adopted the following principles:—

"Article 1.—L'occupation d'un territoire à titre de souveraineté ne pourra être reconnue comme effective que si elle réunit les conditions suivantes: 1° La prise de possession d'un territoire enfermé dans certaines limites, faite au nom du gouvernement. 2° La notification officielle de la prise de possession. La prise de possession s'accomplit par l'établissement d'un pouvoir local responsable, pourvu de moyens suffisants pour maintenir l'ordre et pour assurer l'exercice régulier de son autorité dans les limites du territoire occupé. Ces moyens pourront être empruntés à des institutions existantes dans le pays occupé. La notification de la prise de possession de fait, soit pour la publication dans la forme qui, dans chaque état, est en usage pour la notification des actes officiels, soit par la voie diplomatique. Elle contiendra la détermination approximative des limites du territoire occupé" (*Annuaire* x. 201).

This development of international law naturally led to arrangements as to "spheres of influence." Nations which had not yet settled or occupied, or established protectorates, in regions contiguous to their existing possessions, were desirous to retain a

hold over the former, and proceeded to enter into treaties defining the spheres of influence.

The following are some of the chief treaties by which such spheres are defined:—

Great Britain and Portugal as to Africa, August 20, 1890, November 14, 1890 and June 11, 1891. Great Britain and France as to Upper Niger, January 20, 1891; November 15, 1893, as to Lake Chad. Great Britain and France as to Siam, January 15, 1896. The two governments engage to one another "that neither of them will, without the consent of the other in any case or under any pretext, advance their armed forces into the regions, &c." They also engage not to acquire within this region any special privilege or advantage which shall not be enjoyed in common, or equally open to Great Britain and France or their nationals and dependants. Great Britain and Italy as to Africa, April 15, 1891; May 5, 1894, as to region of the Gulf of Aden. Congo and Portugal, May 25, 1891, as to "sphères de souveraineté et d'influence" in the region of Lunda. Great Britain, Belgium and Congo, May 12, 1894, as to the sphere of influence of the independent Congo State. Great Britain and Germany, July 1, 1890 and November 15, 1893, as to East and Central Africa. Great Britain and Russia as to the spheres of influence to the east of Lake Victoria in the region of the Pamirs, March 11, 1895.

As an example of the promises or engagements in such treaties may be quoted that between Great Britain and Portugal of the 20th of August 1890. Portugal engages that the territory of which the limits are defined in article 3 shall not, without the consent of Great Britain, be transferred to any other power. In the treaty between the same powers of the 14th of November 1890 it is stipulated that neither power will make, tender, accept protectorates, or exercise any act of sovereignty, &c. Sometimes a treaty defining spheres of influence declares that such and such territory shall be neutral.

In the treaty of delimitation between France and Germany of the 15th of March 1894, the line of demarcation of the zones of influence of the two states in the region of Lake Chad is drawn, and they agree to exercise no political influence in such spheres. Each of the states agrees (art. 2) to acquire no territory, to conclude no treaties, to accept no rights of sovereignty, or protectorate, and not "gêner ou de contester l'influence de l'autre Puissance dans la zone qui lui est réservée."

Being the result of treaties, arrangements as to spheres of influence bind only the parties thereto. As Mr Olney, in his correspondence with Lord Salisbury in regard to Venezuela, remarked: "Arrangements as to spheres of influence are new departures, which certain great European Powers have found necessary and convenient in the course of their division among themselves of great tracts of the continent of Africa, and which find their sanction solely in their reciprocal obligations" (United States No. 2, 1896, p. 27).

Some treaties expressly declare that the arrangement shall not affect the rights of other powers (Stoerck, *Recueil*, xvi. p. 932). No doubt, however, the tendency is for spheres of influence to become protectorates. It may be mentioned that Germany and Holland have concluded a treaty (Dec. 21, 1897) by which the latter agrees to extradite German criminals in spheres of influence. By an agreement of the 12th of May 1894 between Great Britain and the Congo State, the former granted to the latter a lease of territories comprised within the sphere of influence laid down in the Anglo-German agreement of the 1st of July 1890 (19 *Hertslet*, p. 179).

Somewhat akin to the rights of a state in a sphere of influence are those possessed by Germany in the zone surrounding the protectorate of Kiaochow under the treaty of the 6th of March 1898, and the rights obtained under treaties with China that certain provinces shall not be alienated.

Somewhat similar arrangements as to ports of the sea are not unknown. Grotius in his *Mare liberum* says: "Illud interim fatemur, potuisse inter gentes aliquas convenire, ut capti in maris hac vel illa parte, hujus aut illius reipublicae judicium subirent, atque ita ad commoditatem distinguendae jurisdictionis in mari fines describi, quod ipsos quidem eam sibi legem ferentes obligat, at alios populos non item; neque locum cujus proprium facit, sed in personas contrahentium jus constituit" (c. 5).

The best known example of a claim to a sphere of influence, which is not the result of any treaty, is the Monroe doctrine, first broached by President Monroe in 1823. The Romans had their equivalent to the Monroe doctrine; they forbade any Asiatic king entering Europe and conquering any part of it; the breach of this rule was their chief grievance against Mithradates (Montesquieu, *De la Grandeur et de la décadence des romains*, (c. 6).

Claims somewhat similar to those relating to spheres of influence have been put forward as against the whole world, in virtue of the right of continuity or the doctrine of the *Hinterland*. Sometimes it is called the "doctrine of contiguity," or "droit de vicinité, de priorité, de préemption ou d'enclave." He who occupies a part of a well-defined close or *fundus*, a parcel of land with artificial or natural boundaries, which enables him to control the whole area, may be said to occupy it. He need not be present everywhere, or enter on every part of it: "Sufficit quamlibet partem ejus fundi introire, dum mente et cogitatione hac sit, uti totum fundum usque ad terminum velit possidere" (*Dig.* xli. 2, 3). In virtue of a supposed analogy to such occupation, it has been said that the occupation of the mouth of a river is constructive occupation of all its basin and tributaries, and that the occupation of part of a territory extends to all the country of which it forms physically a part. A state, having actually occupied the coast, may claim to reserve to itself the right of occupying from time to time territory lying inland (hinterland). In the discussions as to the western boundary of Louisiana between the commissions of the United States and Spain, as to Oregon, as to the claims of the Portuguese in East Africa, and as to the boundaries of Venezuela, the question of the extent of the rights of the discoverer and occupier came up. Portugal actually claimed all territory lying between her African possessions. It has been urged that the subsequent settlement within a reasonable time of the mouth of a river, "particularly if none of its branches had been explored prior to such discovery, gave the right of occupation, and ultimately of sovereignty, to the whole country drained by such river and its several branches." Another form of the same doctrine is, that the occupier of a part of the sea-coast thereby acquires rights "extending into the interior of the country to the sources of the rivers emptying within that coast, to all their branches, and the country they cover" (Twiss, *Laws of Nations in Time of Peace*, p. 170; Twiss, *Oregon Question*, p. 245; Bluntschli, s. 282; Phillimore, *Commentaries*, p. 236; Westlake, *International Law*, pt. i. p. 128). Lord Salisbury referred to "the modern doctrine of hinterland with its inevitable contradictions" (United States, No. 2, 1896, p. 12). Certainly it is inconsistent with the doctrine, more and more received in recent times, that effective possession is necessary to found a title to sovereignty or control. It is akin to the extravagant claims of the early Portuguese and Spanish navigators to territory on which they had never set foot or eyes. The doctrine of the hinterland is likely to become less important, now that Africa has been parcelled out.

AUTHORITIES.—Twiss, *Laws of Nations in Time of Peace* (1855); Phillimore, *Commentaries on International Law*, s. 236; Salomon, *L'Occupation des territoires sans maître* (1889); *Correspondence as to Delagoa Bay* (Portugal, No. 1, 1875, p. 191); *British Counter Case, Venezuela*, No. 2 (1899), p. 135; *Annuaire de l'Institut de droit international*, ix. 243; x. 173; *Revue de droit international*, xviii. 113; xviii. 433; xix. 371; *Venezuelan Papers*, No. 4 (1896); J. B. Moore, *Digest of International Law* (1906), i. 268. (J. M.)

SPHERICAL HARMONICS, in mathematics, certain functions of fundamental importance in the mathematical theories of gravitation, electricity, hydrodynamics, and in other branches of physics. The term "spherical harmonic" is due to Lord Kelvin, and is primarily employed to denote either a rational integral homogeneous function of three variables x, y, z , which satisfies the differential equation

$$\nabla^2 V = \frac{\partial^2 V}{\partial x^2} + \frac{\partial^2 V}{\partial y^2} + \frac{\partial^2 V}{\partial z^2} = 0,$$

known as Laplace's equation, or a function which satisfies the differential equation, and becomes a rational integral homogeneous function when multiplied by a power of $(x^2 + y^2 + z^2)^{\frac{1}{2}}$.

Of all particular integrals of Laplace's equation, these are of the greatest importance in respect of their applications, and were the only ones considered by the earlier investigators; the solutions of potential problems in which the bounding surfaces are exactly or approximately spherical are usually expressed as series in which the terms are these spherical harmonics. In the wider sense of the term, a spherical harmonic is any homogeneous function of the variables which satisfies Laplace's equation, the degree of the function being not necessarily integral or real, and the functions are not necessarily rational in x, y, z , or single-valued; when the term spherical harmonic is used in the narrower sense, the functions may, when necessary, be termed ordinary spherical harmonics. For the treatment of potential problems which relate to spaces bounded by special kinds of surfaces, solutions of Laplace's equation are required which are adapted to the particular boundaries, and various classes of such solutions have thus been introduced into analysis. Such functions are usually of a more complicated structure than ordinary spherical harmonics, although they possess analogous properties. As examples we may cite Bessel's functions in connexion with circular cylinders, Lamé's functions in connexion with ellipsoids, and toroidal functions for anchor rings. The theory of such functions may be regarded as embraced under the general term harmonic analysis. The present article contains an account of the principal properties of ordinary spherical harmonics, and some indications of the nature and properties of the more important of the other classes of functions which occur in harmonic analysis. Spherical and other harmonic functions are of additional importance in view of the fact that they are largely employed in the treatment of the partial differential equations of physics, other than Laplace's equation; as examples of this, we may refer to the equation $\frac{\partial u}{\partial t} = k \nabla^2 u$, which is fundamental in the theory of conduction of heat and electricity, also to the equation $\frac{\partial^2 u}{\partial t^2} = k \nabla^2 u$, which occurs in the theory of the propagation of aerial and electro-magnetic waves. The integration under given conditions of more complicated equations which occur in the theories of hydro-dynamics and elasticity, can in certain cases be effected by the use of the functions employed in harmonic analysis.

1. *Relation between Spherical Harmonics of Positive and Negative Degrees.*—A function which is homogeneous in x, y, z , of degree n in those variables, and which satisfies Laplace's equation

$$\frac{\partial^2 V}{\partial x^2} + \frac{\partial^2 V}{\partial y^2} + \frac{\partial^2 V}{\partial z^2} = 0, \text{ or } \nabla^2 V = 0, \tag{1}$$

is termed a solid spherical harmonic, or simply a spherical harmonic of degree n . The degree n may be fractional or imaginary, but we are at present mainly concerned with the case in which n is a positive or negative integer. If x, y, z be replaced by their values $r \sin \theta \cos \phi, r \sin \theta \sin \phi, r \cos \theta$ in polar co-ordinates, a solid spherical harmonic takes the form $r^n f_n(\theta, \phi)$; the factor $f_n(\theta, \phi)$ is called a surface harmonic of degree n . If V_n denote a spherical harmonic of degree n , it may be shown by differentiation that $\nabla^2(r^m V_n) = m(2n + m + 1)r^{m-2}V_n$, and thus as a particular case that $\nabla^2(r^{2n-1}V_n) = 0$; we have thus the fundamental theorem that from any spherical harmonic V_n of degree n , another of degree $-n-1$ may be derived by dividing V_n by r^{2n+1} . All spherical harmonics of negative integral degree are obtainable in this way from those of positive integral degree. This theorem is a particular case of the more general inversion theorem that if $F(x, y, z)$ is any function which satisfies the equation (1), the function

$$\frac{1}{r} F\left(\frac{x}{r^2}, \frac{y}{r^2}, \frac{z}{r^2}\right)$$

also satisfies the equation.

The ordinary spherical harmonics of positive integral degree n are those which are rational integral functions of x, y, z . The most general rational integral function of degree n in three letters contains $\frac{1}{2}(n+1)(n+2)$ coefficients; if the expression be substituted in (1), we have on equating the coefficients separately to zero $\frac{1}{2}n(n-1)$ relations to be satisfied; the most general spherical harmonic of the prescribed type therefore contains $\frac{1}{2}(n+1)(n+2) - \frac{1}{2}n(n-1)$, or $2n+1$ independent constants. There exist, therefore, $2n+1$ independent ordinary harmonics of degree n ; and corresponding to each of these there is a negative harmonic of degree $-n-1$ obtained by dividing by r^{2n+1} . The three independent harmonics of degree 1 are x, y, z ; the five of degree 2 are $y^2 - z^2, z^2 - x^2, yz, zx, xy$. Every harmonic of degree n is a linear function of $2n+1$ independent harmonics of the degree; we proceed, therefore, to find the latter.

2. *Determination of Harmonics of given Degree.*—It is clear that a function $f(ax+by+cz)$ satisfies the equation (1), if a, b, c are constants which satisfy the condition $a^2+b^2+c^2=0$; in particular the equation is satisfied by $(z+\alpha x \cos a + \alpha y \sin a)^n$. Taking n to be a positive integer, we proceed to expand this expression in a series of cosines and sines of multiples of a ; each term will then satisfy (1) separately. Denoting e^{ia} by k , and $y+\alpha x$ by t , we have

$$(z+\alpha x \cos a + \alpha y \sin a)^n = \left(z + \frac{1}{2}kt + \frac{z^2}{2kt} - \frac{r^2}{2kt}\right)^n$$

which may be written as $(2kt)^{-n} \{(z+kt)^2 - r^2\}^n$. On expansion by Taylor's theorem this becomes

$$(2kt)^{-n} \sum_0^{2n} \frac{k^{2s}}{s!} \frac{\partial^s}{\partial z^s} (z^2 - r^2)^n,$$

the differentiation applying to z only as it occurs explicitly; the terms involving $\cos ma, \sin ma$ in this expansion are

$$\frac{1}{2^n} \cos ma \left\{ \frac{(y+\alpha x)^m}{(n+m)!} \frac{\partial^{n+m}}{\partial z^{n+m}} (z^2 - r^2)^n + \frac{(y+\alpha x)^{-m}}{(n+m)!} \frac{\partial^{n-m}}{\partial z^{n-m}} (z^2 - r^2)^m \right\}$$

$$i \frac{1}{2^n} \sin ma \left\{ \frac{(y+\alpha x)^m}{(n+m)!} \frac{\partial^{n+m}}{\partial z^{n+m}} (z^2 - r^2)^n - \frac{(y+\alpha x)^{-m}}{(n-m)!} \frac{\partial^{n-m}}{\partial z^{n-m}} (z^2 - r^2)^m \right\}$$

where $m = 1, 2, \dots, n$; and the term independent of a is

$$\frac{1}{2^n n!} \frac{\partial^n}{\partial z^n} (z^2 - r^2)^n.$$

On writing

$$(y+\alpha x)^m = i^{m-r} (\cos m\phi - i \sin m\phi) 2 \sin^m \theta, (y+\alpha x)^{-m} = i^{-m-r} (\cos m\phi + i \sin m\phi) \sin^{-m} \theta$$

and observing that in the expansion of $(z+\alpha x \cos a + \alpha y \sin a)^m$ the expressions $\cos ma, \sin ma$ can only occur in the combination $\cos m(\phi - a)$, we see that the relation

$$i^{m-r} \frac{\sin^m \theta}{(n+m)!} \frac{\partial^{n+m}}{\partial z^{n+m}} (z^2 - r^2)^n = i^{-m-r} \frac{\sin^{-m} \theta}{(n-m)!} \frac{\partial^{n-m}}{\partial z^{n-m}} (z^2 - r^2)^n$$

must hold identically, and thus that the terms in the expansion reduce to

$$\frac{1}{(n+m)!} \frac{i^m}{2^{n-1}} r^m \cos ma \cos m\phi \sin^m \theta \frac{\partial^{n+m}}{\partial z^{n+m}} (z^2 - r^2)^n$$

$$\frac{1}{(n+m)!} \frac{i^m}{2^{n-1}} r^m \sin ma \sin m\phi \sin^m \theta \frac{\partial^{n+m}}{\partial z^{n+m}} (z^2 - r^2)^n.$$

We thus see that the spherical harmonics of degree n are of the form

$$r^n \frac{\cos m\phi \sin^m \theta}{\sin^m \theta} \frac{d^{n+m}}{d\mu^{n+m}} (\mu^2 - 1)^n$$

where μ denotes $\cos \theta$; by giving m the values $0, 1, 2, \dots, n$ we thus have the $2n+1$ functions required. On carrying out the differentiations we see that the required functions are of the form

$$A \left\{ (x+\alpha y)^m \pm (x-\alpha y)^m \right\} \frac{z^{n-m} - \frac{(n-m)(n-m-1)}{2} z^{n-m-2} (x^2+y^2+z^2)}{2 \cdot 2n-1}$$

$$+ \dots + \frac{(n-m)(n-m-1)(n-m-2)(n-m-3)}{2 \cdot 4 \cdot 2n-1 \cdot 2n-3} z^{n-m-4} (x^2+y^2+z^2)^2 \tag{2}$$

where $m = 0, 1, 2, 3, \dots, n$.

3. *Zonal, Tesseral and Sectorial Harmonics.*—Of the system of $2n+1$ harmonics of degree n , only one is symmetrical about the z axis; this is

$$r^n \frac{1}{2^n n!} \frac{d^n}{d\mu^n} (\mu^2 - 1)^n;$$

writing

$$P_n(\mu) = \frac{1}{2^n n!} \frac{d^n}{d\mu^n} (\mu^2 - 1)^n,$$

we observe that $P_n(\mu)$ has n zeros all lying between ± 1 , consequently the locus of points on a sphere $r=a$, for which $P_n(\mu)$ vanishes is n circles all parallel to the meridian plane: these circles divide the sphere into zones, thus $P_n(\mu)$ is called the zonal surface harmonic of degree n , and $r^n P_n(\mu), r^{n-1} P_{n-1}(\mu)$ are the solid zonal harmonics of degrees n and $n-1$. The locus of points on a

sphere for which $\frac{\cos m\phi \sin^m \theta}{\sin^m \theta} \frac{d^{n+m}}{d\mu^{n+m}} (\mu^2 - 1)^n$ vanishes consists of

$n-m$ circles parallel to the meridian plane, and m great circles through the poles; these circles divide the spherical surface into quadrilaterals or $\tau\epsilon\sigma\sigma\epsilon\rho\alpha$, except when $n=m$, in which case the surface is divided into sectors, and the harmonics are therefore called tesseral, except those for which $m=n$, which are called

sectorial. Denoting $(1-\mu^2)^{\frac{1}{2}m} \frac{d^m P_n(\mu)}{d\mu^m}$ by $P_n^m(\mu)$, the tesseral

surface harmonics are $\frac{\cos m\phi}{\sin^m \theta} P_n^m(\cos \theta)$, where $m = 1, 2, \dots, n-1$,

and the sectorial harmonics are $\frac{\cos n\phi}{\sin^n \theta} P_n^n(\cos \theta)$. The functions

$P_n(\mu), P_n^m(\mu)$ denote the expressions

$$P_n(\mu) = \frac{(2n)!}{2^n n! n!} \left\{ \mu^n - \frac{n(n-1)}{2 \cdot 2n-1} \mu^{n-2} + \frac{n(n-1)(n-2)(n-3)}{2 \cdot 4 \cdot 2n-1 \cdot 2n-3} \mu^{n-4} \dots \right\} \quad (3)$$

$$P_n^m(\mu) = \frac{(2n)!}{2^n n! (n-m)!} (1-\mu^2)^{\frac{1}{2}m} \left\{ \mu^{n-m} - \frac{(n-m)(n-m-1)}{2 \cdot 2n-1} \mu^{n-m-2} + \dots \right\} \quad (4)$$

$$P_n^n(\mu) = \frac{(2n)!}{2^n n!} (1-\mu^2)^{\frac{1}{2}n}$$

Every ordinary harmonic of degree n is expressible as a linear function of the system of $2n+1$ zonal, tesseral and sectorial harmonics of degree n ; thus the general form of the surface harmonic is

$$a_0 P_n(\mu) + \sum_{m=1}^n (a_m \cos m\phi + b_m \sin m\phi) P_n^m(\mu) \quad (5)$$

In the present notation we have

$$(z + ix \cos a + iy \sin a)^n = r^n \left\{ P_n(\mu) + 2 \sum_{m=1}^n \frac{n!}{(n+m)!} P_n^m(\mu) \cos m(\phi-a) \right\}$$

if we put $a=0$, we thus have

$$(\cos \theta + i \sin \theta \cos \phi)^n = P_n(\cos \theta) + 2 \sum_{m=1}^n \frac{n!}{(n+m)!} P_n^m(\cos \theta) \cos m\phi,$$

from this we obtain expressions for $P_n(\cos \theta)$, $P_n^m(\cos \theta)$ as definite integrals

$$\left. \begin{aligned} P_n(\cos \theta) &= \frac{1}{\pi} \int_0^\pi (\cos \theta + i \sin \theta \cos \phi)^n d\phi \\ i^m \frac{n!}{(n+m)!} P_n^m(\cos \theta) &= \frac{1}{\pi} \int_0^\pi (\cos \theta + i \sin \theta \cos \phi)^n \cos m\phi d\phi \end{aligned} \right\} (6)$$

4. *Derivation of Spherical Harmonics by Differentiation.*—The linear character of Laplace's equation shows that, from any solution, others may be derived by differentiation with respect to the variables x, y, z ; or, more generally, if

$$f \left(\frac{\partial}{\partial x}, \frac{\partial}{\partial y}, \frac{\partial}{\partial z} \right)$$

denote any rational integral operator,

$$f \left(\frac{\partial}{\partial x}, \frac{\partial}{\partial y}, \frac{\partial}{\partial z} \right) V$$

is a solution of the equation, if V satisfies it. This principle has been applied by Thomson and Tait to the derivation of the system of any integral degree, by operating upon $1/r$, which satisfies Laplace's equation. The operations may be conveniently carried out by means of the following differentiation theorem. (See papers by Hobson, in the *Messenger of Mathematics*, xxiii. 115, and *Proc. Lond. Math. Soc.* vol. xxiv.)

$$f_n \left(\frac{\partial}{\partial x}, \frac{\partial}{\partial y}, \frac{\partial}{\partial z} \right) \frac{1}{r} = (-1)^n \frac{(2n)!}{2^n n!} \frac{1}{r^{2n+1}} \left\{ 1 - \frac{r^2 \nabla^2}{2 \cdot 2n-1} + \frac{r^4 \nabla^4}{2 \cdot 4 \cdot 2n-1 \cdot 2n-3} - \dots \right\} f_n(x, y, z) \quad (7)$$

which is a particular case of the more general theorem

$$f_n \left(\frac{\partial}{\partial x}, \frac{\partial}{\partial y}, \frac{\partial}{\partial z} \right) F(r) = \left\{ 2^n \frac{d^n F}{d(r^2)^n} + \frac{2^{n-2}}{1!} \frac{d^{n-1} F}{d(r^2)^{n-1}} \nabla^2 + \dots + \frac{2^{n-2s}}{s!} \frac{d^{n-2s} F}{d(r^2)^{n-2s}} \nabla^{2s} + \dots \right\} f_n(x, y, z) \quad (7'),$$

where $f_n(x, y, z)$ is a rational integral homogeneous function of degree n . The harmonic of positive degree n corresponding to that of degree $-n-1$ in the expression (7) is

$$\left\{ 1 - \frac{r^2 \nabla^2}{2 \cdot 2n-1} + \frac{r^4 \nabla^4}{2 \cdot 4 \cdot 2n-1 \cdot 2n-3} - \dots \right\} f_n(x, y, z).$$

It can be verified that even when n is unrestricted, this expression satisfies Laplace's equation, the sole restriction being that of the convergence of the series.

5. *Maxwell's Theory of Poles.*—Before proceeding to obtain by means of (7), the expressions for the zonal, tesseral and sectorial harmonics, it is convenient to introduce the conception, due to Maxwell (see *Electricity and Magnetism*, vol. i. ch. ix.), of the poles of a spherical harmonic. Suppose a sphere of any radius drawn with its centre at the origin; any line whose direction-cosines are l, m, n drawn from the origin, is called an axis, and the point where this axis cuts the sphere is called the pole of the axis. Different axes will be denoted by suffixes attached to the direction-cosines; the cosine $(lx+my+nz)/r$ of the angle between the radius vector r to a point (x, y, z) and the axis (l, m, n) , will be denoted by λ_l ; the cosine of the angle between two axes is $l_l m_m + m_l m_m + n_l n_m$, which will be denoted by μ_{lm} . The operation

$$l_l \frac{\partial}{\partial x} + m_l \frac{\partial}{\partial y} + n_l \frac{\partial}{\partial z}$$

performed upon any function of x, y, z , is spoken of as differentiation with respect to the axis (l, m, n) , and is denoted by $\partial/\partial h_l$. The potential function $V_0 = e_0/r$ is defined to be the potential due to a singular point of degree zero at the origin; e_0 is called the strength

of the singular point. Let a singular point of degree zero, and strength e_0 , be on an axis h_1 , at a distance a_0 from the origin, and also suppose that the origin is a singular point of strength $-e_0$; let e_0 be indefinitely increased, and a_0 indefinitely diminished, but so that the product $e_0 a_0$ is finite and equal to e_1 ; the origin is then said to be a singular point of the first degree, of strength e_1 , the axis being h_1 . Such a singular point is frequently called a doublet. In a similar manner, by placing two singular points of degree, unity and strength, $e_1, -e_1$, at a distance a_1 along an axis h_2 , and at the origin respectively, when e_1 is indefinitely increased, and a_1 diminished so that $e_1 a_1$ is finite and $=e_2$, we obtain a singular point of degree 2, strength e_2 at the origin, the axes being h_1, h_2 . Proceeding in this manner we arrive at the conception of a singular point of any degree n , of strength e_n at the origin, the singular point having any n given axes h_1, h_2, \dots, h_n . If $e_{n-1} \phi_{n-1}(x, y, z)$ is the potential due to a singular point at the origin, of degree $n-1$, and strength e_{n-1} , with axes h_1, h_2, \dots, h_{n-1} , the potential of a singular point of degree n , the new axis of which is h_n , is the limit of

$$e_{n-1} \phi_{n-1}(x-l_n a, y-m_n a, z-n_n a) - e_{n-1} \phi_{n-1}(x, y, z);$$

when

$$L a = 0, L e_{n-1} = \alpha, L a e_{n-1} = e_n;$$

this limit is

$$-e_n \left(l_n \frac{\partial \phi_{n-1}}{\partial x} + m_n \frac{\partial \phi_{n-1}}{\partial y} + n_n \frac{\partial \phi_{n-1}}{\partial z} \right), \text{ or } -e_n \frac{\partial}{\partial h_n} \phi_{n-1}.$$

Since $\phi_0 = 1/r$, we see that the potential V , due to a singular point at the origin of strength e_n , and axes h_1, h_2, \dots, h_n is given by

$$V_n = (-1)^n e_n \frac{\partial^n}{\partial h_1 \partial h_2 \dots \partial h_n} \frac{1}{r} \quad (8)$$

6. *Expression for a Harmonic with given Poles.*—The result of performing the operations in (8) is that V_n is of the form

$$n! e_n \frac{Y_n}{r^{n+1}}$$

where Y_n is a surface harmonic of degree n , and will appear as a function of the angles which r makes with the n axes, and of the angles these axes make with one another. The poles of the n axes are defined to be the poles of the surface harmonics, and are also frequently spoken of as the poles of the solid harmonics $Y_n r^n, Y_{n-1} r^{n-1}$. Any spherical harmonic is completely specified by means of its poles.

In order to express Y_n in terms of the positions of its poles, we apply the theorem (7) to the evaluation of V_n in (8). On putting

$$f_n(x, y, z) = \Pi(l_r x + m_r y + n_r z), \text{ we have}$$

$$Y_n = \frac{(2n)!}{2^n n! n!} \cdot \frac{1}{r^n} \left(1 - \frac{r^2 \nabla^2}{2 \cdot 2n-1} + \frac{r^4 \nabla^4}{2 \cdot 4 \cdot 2n-1 \cdot 2n-3} \dots \right) \times \frac{1}{\Pi(l_r x + m_r y + n_r z)}$$

By $\Sigma(\mu^s \lambda^{n-2s})$ we shall denote the sum of the products of s of the quantities μ , and $n-2s$ of the quantities λ ; in any term each suffix is to occur once, and once only, every possible order being taken. We find

$$\Pi(lx+my+nz) = \Sigma(\lambda^n) r^n, \Delta^2 \Pi(lx+my+nz) = 2 \Sigma(\mu^1 \lambda^{n-2}) r^{n-2},$$

and generally

$$\Delta^{2m} \Pi(lx+my+nz) = 2^m m! \Sigma(\mu^m \lambda^{n-2m}) r^{n-2m};$$

thus we obtain the following expression for Y_n , the surface harmonic which has given poles h_1, h_2, \dots, h_n ;

$$Y_n = r^{n+1} \frac{(-1)^n}{n!} \frac{\partial^n}{\partial h_1 \partial h_2 \dots \partial h_n} \cdot \frac{1}{r} = \sum_{m=0}^n \left\{ (-1)^m \frac{(2n-2m)!}{2^{n-m} n! (n-m)!} \Sigma(\lambda^{n-2m} \mu^m) \right\} \quad (9)$$

where S denotes a summation with respect to m from $m=0$ to $m=\frac{1}{2}n$, or $\frac{1}{2}(n-1)$, according as n is even or odd. This is Maxwell's general expression (*loc. cit.*) for a surface harmonic with given poles.

If the poles on a sphere of radius r are denoted by A, B, C, \dots , we obtain from (9) the following expressions for the harmonics of the first four degrees:—

$$Y_1 = \cos PA, Y_2 = \frac{1}{2}(3 \cos PA \cos PB - \cos AB),$$

$$Y_3 = \frac{1}{2}(15 \cos PA \cos PB \cos PC - \cos PA \cos BC - \cos PB \cos CA - \cos PC \cos AB),$$

$$Y_4 = \frac{1}{8}(35 \cos PA \cos PB \cos PC \cos PD - 5 \Sigma \cos PA \cos PB \cos CD + \Sigma \cos AB \cos CD).$$

7. *Poles of Zonal, Tesseral and Sectorial Harmonics.*—Let the n axes of the harmonic coincide with the axis of z , we have then by (8) the harmonic

$$\frac{(-1)^n r^{n+1}}{n!} \frac{\partial^n}{\partial z^n} \frac{1}{r};$$

applying the theorem (7) to evaluate this expression, we have

$$\frac{(-1)^n r^{n+1}}{n!} \frac{\partial^n}{\partial z^n} \frac{1}{r} = \frac{(2n)!}{2^n n! n!} \frac{1}{r^n} \left\{ 1 - \frac{r^2 \nabla^2}{2 \cdot 2n-1} + \frac{r^4 \nabla^4}{2 \cdot 4 \cdot 2n-1 \cdot 2n-3} - \dots \right\} z^n$$

$$= \frac{(2n)!}{2^n n! n!} \left\{ \mu^n - \frac{n(n-1)}{2 \cdot 2n-1} \mu^{n-2} + \dots \right\},$$

the expression on the right side is $P^n(\mu)$, the zonal surface harmonic; we have therefore

$$P_n(\mu) = \frac{(-1)^n r^{n+1}}{n!} \frac{\partial^n}{\partial z^n} \frac{1}{r}.$$

The zonal harmonic has therefore all its poles coincident with the z axis. Next, suppose $n-m$ axes coincide with the z axis, and that the remaining m axes are distributed symmetrically in the plane of x, y at intervals π/m , the direction cosines of one of them being $\cos \alpha, \sin \alpha, 0$. We have

$$\prod_0^{m-1} \left\{ \cos \left(\alpha + \frac{r\pi}{m} \right) \frac{\partial}{\partial x} + \sin \left(\alpha + \frac{r\pi}{m} \right) \frac{\partial}{\partial y} \right\} = \frac{1}{2^m \Pi} \left\{ e^{i \left(\alpha + \frac{r\pi}{m} \right)} \left(\frac{\partial}{\partial x} - \frac{\partial}{\partial y} \right) + e^{-i \left(\alpha + \frac{r\pi}{m} \right)} \left(\frac{\partial}{\partial x} + \frac{\partial}{\partial y} \right) \right\}.$$

Let $\xi = x + iy, \eta = x - iy$, the above product becomes

$$\prod_0^{m-1} \left\{ e^{i \left(\alpha + \frac{r\pi}{m} \right)} \frac{\partial}{\partial \xi} + e^{-i \left(\alpha + \frac{r\pi}{m} \right)} \frac{\partial}{\partial \eta} \right\},$$

which is equal to

$$e^{(m-1)\frac{r\pi}{2}} \left\{ e^{m i \alpha} \left(\frac{\partial}{\partial \xi} \right)^m - e^{-m i \alpha} \left(-\frac{\partial}{\partial \eta} \right)^m \right\}; \text{ when } \alpha = 0, \frac{\pi}{2m},$$

this becomes

$$e^{(m-1)\frac{r\pi}{2}} \left\{ \left(\frac{\partial}{\partial \xi} \right)^m - (-1)^m \left(\frac{\partial}{\partial \eta} \right)^m \right\} \text{ and}$$

$$e^{(m-1)\frac{r\pi}{2}} \left[\left(\frac{\partial}{\partial \xi} \right)^m + (-1)^m \left(\frac{\partial}{\partial \eta} \right)^m \right].$$

From (7), we find

$$\frac{\partial^{n-m}}{\partial z^{n-m}} \left(\frac{\partial}{\partial x} \pm \frac{\partial}{\partial y} \right)^m \frac{1}{r} = \frac{(2n)!}{2^n n!} \frac{1}{r^{2n+1}} \left[1 - \frac{r^2 \Delta^2}{2 \cdot 2n-1} + \dots \right] z^{n-m} (x \pm iy)^m$$

$$= (-1)^n \frac{(2n)!}{2^n n!} \frac{1}{r^{n+1}} (\cos m\phi \pm i \sin m\phi) \sin^m \theta \left\{ \cos^{n-m} \theta \right.$$

$$\left. - \frac{(n-m)(n-m-1)}{2 \cdot 2n-1} \cos^{n-m-2} \theta + \dots \right\},$$

hence

$$\frac{\partial^{n-m}}{\partial z^{n-m}} \left(\frac{\partial}{\partial x} \pm \frac{\partial}{\partial y} \right)^m \frac{1}{r} = (-1)^n \frac{(n-m)!}{r^{n+1}} (\cos m\phi \pm i \sin m\phi) P_n^m(\cos \theta),$$

as we see on referring to (4); we thus obtain the formulae

$$\left. \begin{aligned} \frac{\partial^{n-m}}{\partial z^{n-m}} \left\{ \left(\frac{\partial}{\partial \xi} \right)^m + \left(\frac{\partial}{\partial \eta} \right)^m \right\} \frac{1}{r} &= (-1)^n \frac{(n-m)!}{2^{m-1} r^{n+1}} \cos m\phi \cdot P_n^m(\cos \theta) \\ \frac{\partial^{n-m}}{\partial z^{n-m}} \left\{ \left(\frac{\partial}{\partial \xi} \right)^m - \left(\frac{\partial}{\partial \eta} \right)^m \right\} \frac{1}{r} &= (-1)^n \frac{(n-m)!}{2^{m-1} r^{n+1}} \sin m\phi \cdot P_n^m(\cos \theta) \end{aligned} \right\} \quad (10)$$

It is thus seen that the tesseral harmonics of degree n and order m are those which have $n-m$ axes coincident with the z axis, and the other m axes distributed in the equatorial plane, at angular intervals π/m . The sectorial harmonics have all their axes in the equatorial plane.

8. *Determination of the Poles of a given Harmonic.*—It has been shown that a spherical harmonic $Y_n(x, y, z)$ can be generated by means of an operator

$$f_n \left(\frac{\partial}{\partial x}, \frac{\partial}{\partial y}, \frac{\partial}{\partial z} \right) \text{ acting upon } \frac{1}{r},$$

the function f_n being so chosen that

$$Y_n(x, y, z) = (-1)^n \frac{(2n)!}{2^n n!} \left\{ 1 - \frac{r^2 \nabla^2}{2 \cdot 2n-1} + \dots \right\} f_n(x, y, z);$$

this relation shows that if an expression of the form

$$(x^2 + y^2 + z^2) f_{n-2}(x, y, z)$$

is added to $f_n(x, y, z)$, the harmonic $Y_n(x, y, z)$ is unaltered; thus if Y_n be regarded as given, $f_n(x, y, z) = 0$, is not uniquely determined, but has an indefinite number of values differing by multiples of $x^2 + y^2 + z^2$. In order to determine the poles of a given harmonic, f_n must be so chosen that it is resolvable into linear factors; it will be shown that this can be done in one, and only one, way, so that the poles are all real.

If x, y, z are such as to satisfy the two equations $Y_n(x, y, z) = 0, x^2 + y^2 + z^2 = 0$, the equation $f_n(x, y, z) = 0$ is also satisfied; the problem of determining the poles is therefore equivalent to the algebraical one of reducing Y_n to the product of linear factors by means of the relation $x^2 + y^2 + z^2 = 0$, between the variables. Suppose

$$Y_n(x, y, z) = \prod_{s=1}^m (l_s x + m_s y + n_s z) + (x^2 + y^2 + z^2) V_{n-2}(x, y, z),$$

we see that the plane $l_s x + m_s y + n_s z = 0$ passes through two of the $2n$ generating lines of the imaginary cone $x^2 + y^2 + z^2 = 0$, in which that cone is intersected by the cone $Y_n(x, y, z) = 0$. Thus a pole (l_s, m_s, n_s) is the pole with respect to the cone $x^2 + y^2 + z^2 = 0$, of a plane passing through two of the generating lines; the number of systems of poles is therefore $n(2n-1)$, the number of ways of taking the $2n$ generating lines in pairs. Of these systems of poles, however, only one is real, viz. that in which the lines in each pair correspond to conjugate complex roots of the equations $Y_n = 0, x^2 + y^2 + z^2 = 0$. Suppose

$$\frac{x}{a_1 + i\beta_1} = \frac{y}{a_2 + i\beta_2} = \frac{z}{a_3 + i\beta_3}$$

gives one generating line, then the conjugate one is given by

$$\frac{x}{a_1 - i\beta_1} = \frac{y}{a_2 - i\beta_2} = \frac{z}{a_3 - i\beta_3},$$

and the corresponding factor $lx + my + nz$ is

$$\left[\begin{array}{ccc} x & y & z \\ a_1 + i\beta_1 & a_2 + i\beta_2 & a_3 + i\beta_3 \\ a_1 - i\beta_1 & a_2 - i\beta_2 & a_3 - i\beta_3 \end{array} \right],$$

which is real. It is obvious that if any non-conjugate pair of roots is taken, the corresponding factor, and therefore the pole, is imaginary. There is therefore only one system of real poles of a given harmonic, and its determination requires the solution of an equation of degree $2n$. This theorem is due to Sylvester (*Phil. Mag.* (1876), 5th series, vol. ii., "A Note on Spherical Harmonics").

9. *Expression for the Zonal Harmonic with any Axis.*—The zonal surface harmonic, whose axis is in the direction

$$\frac{x'}{r'}, \frac{y'}{r'}, \frac{z'}{r'}, \text{ is } P_n \left(\frac{xx' + yy' + zz'}{rr'} \right)$$

or $P_n(\cos \theta \cos \theta' + \sin \theta \sin \theta' \cos \phi - \phi')$; this is expressible as a linear function of the system of zonal, tesseral, and sectorial harmonics already found. It will be observed that it is symmetrical with respect to (x, y, z) and (x', y', z') , and must thus be capable of being expressed in the form

$$a_0 P_n(\cos \theta) P_n(\cos \theta') + \sum_{\substack{1 \\ I}} a_m P_n^m(\cos \theta) P_n^m(\cos \theta') \cos m(\phi - \phi'),$$

and it only remains to determine the co-efficients $a_0, a_1, \dots, a_m, \dots, a_n$. To find this expression, we transform $(xx' + yy' + zz')^n$, where x, y, z satisfy the condition $x^2 + y^2 + z^2 = 0$; writing $\xi = x + iy, \eta = x - iy, \xi' = x' + iy', \eta' = x' - iy'$, we have

$$(xx' + yy' + zz')^n = \left(\frac{1}{2} \eta' \xi + \frac{1}{2} \xi' \eta + zz' \right)^n$$

which equals

$$(zz')^n + \sum \sum \frac{n!}{a! b! (n-a-b)!} \left\{ \frac{\eta'^a \xi'^b \xi^a \eta^b}{2^{a+b}} \right\} (zz')^{n-a-b},$$

the summation being taken for all values of a and b , such that $a+b \leq n, a > b$; the values $a=0, b=0$ corresponding to the term $(zz')^n$. Using the relation $\xi \eta = -z^2$, this becomes

$$(xx' + yy' + zz')^n = (zz')^n + \sum \sum \frac{(-1)^b}{2^{a+b}} \frac{n!}{a! b! (n-a-b)!} (\xi' \eta')^b z^{n-a-b} \{ (\eta' \xi)^{a-b} + (\xi' \eta)^{a-b} \} z^{n-a-b},$$

putting $a-b=m$, the coefficient of $\xi^m z^{n-m}$, on the right side is

$$\sum \frac{(-1)^b}{2^{m+2b}} \frac{n!}{b! (m+b)! (n-m-2b)!} (\xi' \eta')^b \eta'^m z^{n-m-2b},$$

from $b=0$ to $b=\frac{1}{2}(n-m)$, or $\frac{1}{2}(n-m-1)$, according as $n-m$ is even or odd. This coefficient is equal to

$$\frac{n!}{2^m m! (n-m)!} (x' - iy')^m \left\{ z^{n-m} - \frac{(n-m)(n-m-1)}{2 \cdot 2m+2} z^{n-m-2} (x'^2 + y'^2) \right.$$

$$\left. + \frac{(n-m)(n-m-1)(n-m-2)(n-m-3)}{2 \cdot 4 \cdot 2m+2 \cdot 2m+3} z^{n-m-4} (x'^2 + y'^2)^2 - \dots \right\};$$

in order to evaluate this coefficient, put $z=1, x' = i \cos \alpha, y' = i \sin \alpha$, then this coefficient is that of $(i \cos \alpha + i \sin \alpha)^m$, or of $i^m e^{m i \alpha}$ in the expansion of $(z' + i x' \cos \alpha + i y' \sin \alpha)^n$ in powers of $e^{-i \alpha}$ and $e^{i \alpha}$, this has been already found, thus the coefficient is

$$\frac{n!}{(n+m)!} e^{-i m \phi'} P_n^m(\cos \theta') \cdot r'^n.$$

Similarly the coefficient of $\eta^m z^{n-m}$ is

$$\frac{n!}{(n+m)!} e^{+i m \phi'} P_n^m(\cos \theta') \cdot r'^n;$$

hence we have

$$\frac{1}{r'^n} (xx' + yy' + zz')^n = z^n P_n(\cos \theta') + n! \sum_{\substack{1 \\ I}} P_n^m(\cos \theta') \{ \cos m\phi' (\xi^m + \eta^m) + i \sin m\phi' (\eta^m - \xi^m) \} \frac{z^{n-m}}{(n+m)!}.$$

In this result, change x, y, z into

$$\frac{\partial}{\partial x'}, \frac{\partial}{\partial y'}, \frac{\partial}{\partial z'}$$

and let each side operate on $1/r$, then in virtue of (10), we have

$$(rr')^n P_n \left(\frac{xx' + yy' + zz'}{rr'} \right) = P_n(\cos \theta \cos \theta' + \sin \theta \sin \theta' \cos \phi - \phi')$$

$$= P_n(\cos \theta) P_n(\cos \theta') + 2 \sum_{m=1}^n \frac{(n-m)!}{(n+m)!} P_n^m(\cos \theta) P_n^m(\cos \theta') \cos m(\phi - \phi') \quad (11)$$

which is known as the addition theorem for the function P_n .

It has incidentally been proved that

$$P_n^m(\cos \theta) = \frac{(n+m)!}{2^m (n-m)!} \sin^m \theta \left\{ \cos^{n-m} \theta - \frac{(n-m)(n-m-1)}{2 \cdot 2m+2} \cos^{n-m-2} \theta \sin^2 \theta + \dots \right\} \quad (12)$$

which is an expression for $P_n^m(\cos \theta)$ alternative to (4).

10. *Legendre's Coefficients.*—The reciprocal of the distance of a point (r, θ, ϕ) from a point on the z axis distant r' from the origin is

$$(r^2 - 2rr'\mu + r'^2)^{-\frac{1}{2}}$$

which satisfies Laplace's equation, μ denoting $\cos \theta$. Writing this expression in the forms

$$\frac{1}{r'} \left\{ 1 - 2\frac{r}{r'}\mu + \frac{r^2}{r'^2} \right\}^{-\frac{1}{2}}, \quad \frac{1}{r} \left\{ 1 - 2\frac{r'}{r}\mu + \frac{r'^2}{r^2} \right\}^{-\frac{1}{2}},$$

it is seen that when $r < r'$, the expression can be expanded in a convergent series of powers of r/r' , and when $r' < r$ in a convergent series of powers of r'/r . We have, when $h^2(2\mu - h)^2 < 1$

$$(1 - 2h\mu + h^2)^{-\frac{1}{2}} = 1 + h(2\mu - h) + \frac{1 \cdot 3}{2 \cdot 4} h^2(2\mu - h)^2 + \dots$$

$$+ \frac{1 \cdot 3 \cdot 5 \dots 2n-1}{2 \cdot 4 \dots 2n} h^n (2\mu - h)^n + \dots$$

and since the series is absolutely convergent, it may be rearranged as a series of powers of h , the coefficient of h^n is then found to be

$$\frac{1 \cdot 3 \cdot 5 \dots 2n-1}{1 \cdot 2 \cdot 3 \dots n} \left\{ \mu^n - \frac{n(n-1)}{2 \cdot 2n-1} \mu^{n-2} + \frac{n(n-1)(n-2)(n-3)}{2 \cdot 4 \cdot 2n-1 \cdot 2n-3} \mu^{n-4} - \dots \right\}$$

this is the expression we have already denoted by $P_n(\mu)$; thus

$$(1 - 2h\mu + h^2)^{-\frac{1}{2}} = P_0(\mu) + hP_1(\mu) + \dots + h^n P_n(\mu) + \dots, \quad (13)$$

the function $P_n(\mu)$ may thus be defined as the coefficient of h^n in this expansion, and from this point of view is called the Legendre's coefficient or Legendre's function of degree n , and is identical with the zonal harmonic. It may be shown that the expansion is valid for all real and complex values of h and μ , such that $\text{mod. } h$ is less than the smaller of the two numbers $\text{mod. } (\mu \pm \sqrt{\mu^2 - 1})$. We now see that

$$(r^2 - 2rr'\mu + r'^2)^{-\frac{1}{2}}$$

is expressible in the form

$$\sum_0^{\infty} \frac{r^n}{r'^{n+1}} P_n(\mu)$$

when $r < r'$, or

$$\sum_0^{\infty} \frac{r'^n}{r^{n+1}} P_n(\mu)$$

when $r' < r$; it follows that the two expressions $r^n P_n(\mu)$, $r'^{n-1} P_n(\mu)$ are solutions of Laplace's equation.

The values of the first few Legendre's coefficients are

$$P_0(\mu) = 1, P_1(\mu) = \mu, P_2(\mu) = \frac{1}{2}(3\mu^2 - 1), P_3(\mu) = \frac{1}{2}(5\mu^3 - 3\mu)$$

$$P_4(\mu) = \frac{1}{8}(35\mu^4 - 30\mu^2 + 3), P_5(\mu) = \frac{1}{8}(63\mu^5 - 70\mu^3 + 15\mu)$$

$$P_6(\mu) = \frac{1}{16}(231\mu^6 - 315\mu^4 + 105\mu^2 - 5), P_7(\mu) = \frac{1}{16}(429\mu^7 - 693\mu^5 + 315\mu^3 - 35\mu).$$

We find also

$$P_n(1) = 1, P_n(-1) = (-1)^n$$

$$P_n(0) = 0, \text{ or } (-1)^{\frac{1}{2}n} \frac{1 \cdot 3 \cdot 5 \dots n-1}{2 \cdot 4 \dots n}$$

according as n is odd or even; these values may be at once obtained from the expansion (13), by putting $\mu = 1, 0, -1$.

11. *Additional Expressions for Legendre's Coefficients.*—The expression (3) for $P_n(\mu)$ may be written in the form

$$P_n(\mu) = \frac{(2n)!}{2^n n! n!} \mu^n F \left(-\frac{n}{2}, \frac{1-n}{2}, \frac{1}{2} - n, \frac{1}{\mu^2} \right)$$

with the usual notation for hypergeometric series.

On writing this series in the reverse order

$$P_n(\mu) = (-1)^{\frac{1}{2}n} \frac{n!}{2^n \left(\frac{1}{2}n\right)! \left(\frac{1}{2}n\right)!} F \left(-\frac{n}{2}, \frac{n+1}{2}, \frac{1}{2}, \mu^2 \right)$$

or

$$(-1)^{\frac{n-1}{2}} \frac{n!}{2^{n-1} n-1, n-1!} F \left(-\frac{n-1}{2}, \frac{n}{2} + 1, \frac{3}{2}, \mu^2 \right)$$

according as n is even or odd.

From the identity

$$(1 - 2h \cos \theta + h^2)^{-\frac{1}{2}} = (1 - h e^{i\theta})^{-\frac{1}{2}} (1 - h e^{-i\theta})^{-\frac{1}{2}},$$

it can be shown that

$$P_n(\cos \theta) = \frac{1 \cdot 3 \cdot 5 \dots 2n-1}{2 \cdot 4 \cdot 6 \dots 2n} \left\{ \cos n\theta + \frac{1 \cdot n}{1 \cdot 2n-1} \cos(n-2)\theta + \frac{1 \cdot 3 \cdot n(n-1)}{1 \cdot 2 \cdot (2n-1)(2n-3)} \cos(n-4)\theta + \dots \right\} \quad (14)$$

By (13), or by the formula

$$P_n(\mu) = \frac{1}{2^n n!} \frac{d^n}{d\mu^n} (\mu^2 - 1)^n$$

which is known as Rodrigue's formula, we may prove that

$$P^n(\cos \theta) = 1 - \frac{(n+1)n}{1^2} \sin^2 \frac{\theta}{2} + \frac{(n+2)(n+1)n(n-1)}{1^2 \cdot 2^2} \sin^4 \frac{\theta}{2} \dots$$

$$= F \left(n+1, -n, 1, \sin^2 \frac{\theta}{2} \right). \quad (15)$$

Also that

$$P_n(\cos \theta) = \cos^{2n} \frac{\theta}{2} \left\{ 1 - \frac{n^2}{1^2} \tan^2 \frac{\theta}{2} + \frac{n^2(n-1)^2}{1^2 \cdot 2^2} \tan^4 \frac{\theta}{2} - \dots \right\}$$

$$= \cos^{2n} \frac{\theta}{2} F \left(-n, -n, 1, -\tan^2 \frac{\theta}{2} \right). \quad (16)$$

By means of the identity

$$(1 - 2h\mu + h^2)^{-\frac{1}{2}} = (1 - h\mu)^{-1} \left\{ 1 + \frac{h^2(1-\mu^2)}{(1-h\mu)^2} \right\}^{-\frac{1}{2}},$$

it may be shown that

$$P_n(\cos \theta) = \cos^n \theta \left\{ 1 - \frac{n(n-1)}{2^2} \tan^2 \theta + \frac{n(n-1)(n-2)(n-3)}{2^2 \cdot 4^2} \tan^4 \theta - \dots \right\}$$

$$= \cos^n \theta F \left(-\frac{1}{2}n, \frac{1}{2} - \frac{1}{2}n, 1, -\tan^2 \theta \right). \quad (17)$$

Laplace's definite integral expression (6) may be transformed into the expression

$$\frac{1}{\pi} \int_0^\pi \frac{d\phi}{0(\mu - \sqrt{\mu^2 - 1} \cos \psi)^{n+1}}$$

by means of the relation

$$(\mu + \sqrt{\mu^2 - 1} \cos \phi)(\mu - \sqrt{\mu^2 - 1} \cos \psi) = 1.$$

Two definite integral expressions for $P_n(\mu)$ given by Dirichlet have been put by Mehler into the forms

$$P_n(\cos \theta) = \frac{2}{\pi} \int_0^\theta \frac{\cos(n + \frac{1}{2})\phi}{\sqrt{2} \cos \phi - 2 \cos \theta} d\phi = \frac{2}{\pi} \int_0^\pi \frac{\sin(n + \frac{1}{2})\phi}{\theta \sqrt{2} \cos \theta - 2 \cos \phi} d\phi.$$

When n is large, and θ is not nearly equal to 0 or to π , an approximate value of $P_n(\cos \theta)$ is $\frac{1}{2} \{ 2/n\pi \sin \theta \}^{\frac{1}{2}} \sin \{ (n + \frac{1}{2})\theta + \frac{1}{4}\pi \}$.

12. *Relations between successive Legendre's Coefficients and their Derivatives.*—If $(1 - 2h\mu + h^2)^{-\frac{1}{2}}$ be denoted by u , we find

$$(1 - 2h\mu + h^2) \frac{\partial u}{\partial h} + (h - \mu)u = 0;$$

on substituting $\sum h^n P_n$ for u , and equating to zero the coefficient of h^n , we obtain the relation

$$nP_n - (2n-1)\mu P_{n-1} + (n-1)P_{n-2} = 0.$$

From Laplace's definite integral, or otherwise, we find

$$(\mu^2 - 1) \frac{dP_n}{d\mu} = n(\mu P_n - P_{n-1}) = -(n+1)(\mu P^n - P^{n+1}).$$

We may also show that

$$\mu \frac{dP_n}{d\mu} - \frac{dP_{n-1}}{d\mu} = nP_n$$

$$(n+1)P_n = -\mu \frac{dP_n}{d\mu} + \frac{dP_{n+1}}{d\mu}$$

$$(2n+1)P_n = \frac{dP_{n+1}}{d\mu} - \frac{dP_{n-1}}{d\mu}$$

$$(2n+1)\mu \frac{dP_n}{d\mu} = (n+1) \frac{dP_{n-1}}{d\mu} + n \frac{dP_{n+1}}{d\mu}$$

$$(2n+1)(\mu^2 - 1) \frac{dP_n}{d\mu} = n(n+1)(P_{n+1} - P_{n-1})$$

$$\frac{dP_n}{d\mu} = (2n-1)P_{n-1} + (2n-5)P_{n-3} + (2n-9)P_{n-5} + \dots$$

the last term being $3P_1$ or P_0 according as n is even or odd.

13. *Integral Properties of Legendre's Coefficients.*—It may be shown that if $P_n(\mu)$ be multiplied by any one of the numbers $1, \mu, \mu^2, \dots, \mu^{n-1}$ and the product be integrated between the limits $1, -1$ with respect to μ , the result is zero, thus

$$\int_{-1}^1 \mu^k P_n(\mu) d\mu = 0, \quad a=0, 1, 2, \dots, n-1. \quad (18)$$

To prove this theorem we have

$$\int_{-1}^1 \mu^k P_n(\mu) d\mu = \frac{1}{2^n n!} \int_{-1}^1 \mu^k \frac{d^n}{d\mu^n} (\mu^2 - 1)^n d\mu,$$

on integrating the expression k times by parts, and remembering that $(\mu^2-1)^n$ and its first $n-1$ derivatives all vanish when $\mu = \pm 1$, the theorem is established. This theorem derives additional importance from the fact that it may be shown that $AP_n(\mu)$ is the only rational integral function of degree n which has this property; from this arises the importance of the functions P_n in the theory of quadratures.

The theorem which lies at the root of the applicability of the functions P_n to potential problems is that if n and n' are unequal integers

$$\int_{-1}^1 P_n(\mu)P_{n'}(\mu)d\mu = 0, \tag{19}$$

which may be stated by saying that the integral of the product of two Legendre's coefficients of different degree taken over the whole of a spherical surface with its centre at the origin is zero; this is the fundamental harmonic property of the functions. It is immediately deducible from (18), for if $n' < n$, $P_{n'}(\mu)$ is a linear function of powers of μ , whose indices are all less than n .

When $n' = n$, the integral in (19) becomes $\int_{-1}^1 \{P_n(\mu)\}^2 d\mu$; to evaluate this we write it in the form

$$\frac{1}{2^{2n}n!n!} \int_{-1}^1 \frac{d^n}{d\mu^n}(\mu^2-1)^n \frac{d^n}{d\mu^n}(\mu^2-1)^n d\mu;$$

on integrating n times by parts, this becomes

$$\frac{(-1)^n}{2^{2n}n!n!} \int_{-1}^1 (\mu^2-1)^n \frac{d^{2n}}{d\mu^{2n}}(\mu^2-1)^n d\mu, \text{ or } \frac{(2n)!}{2^{2n}n!n!} \int_{-1}^1 (1-\mu^2)^n \mu,$$

which on putting

$$u = \frac{1}{2}(1-\mu), \text{ becomes } \frac{(2n)!}{2^n n!} \int_0^1 u^n (1-u)^n du,$$

hence

$$\int_{-1}^1 \{P_n(\mu)\}^2 d\mu = \frac{2}{2n+1}. \tag{20}$$

14. *Expansion of Functions in Series of Legendre's Coefficients.*—If it be assumed that a function $f(\mu)$ given arbitrarily in the interval $\mu = -1$ to $+1$, can be represented by a series of Legendre's coefficients $a_0 + a_1 P_1(\mu) + a_2 P_2(\mu) + \dots + a_n P_n(\mu) + \dots$ and it be assumed that the series converges in general uniformly within the interval, the coefficient a can be determined by using (19) and (20); we see that the theorem (19) plays the same part as the property

$\int_0^\pi \cos n\theta \sin n'\theta d\theta = 0, (n \neq n')$ does in the theory of the expansion of functions in series of circular functions. On multiplying the series by $P_n(\mu)$, we have

$$a_n \int_{-1}^1 \{P_n(\mu)\}^2 d\mu = \int_{-1}^1 f(\mu) P_n(\mu) d\mu$$

hence

$$a_n = \frac{2n+1}{2} \int_{-1}^1 f(\mu) P_n(\mu) d\mu,$$

hence the series by which $f(\mu)$ is in general represented in the interval is

$$\sum \frac{2n+1}{2} P_n(\mu) \int_{-1}^1 f(\mu') P_n(\mu') d\mu'. \tag{21}$$

The proof of the possibility of this representation, including the investigation of sufficient conditions as to the nature of the function $f(\mu)$, that the series may in general converge to the value of the function requires an investigation, for which we have not space, similar in character to the corresponding investigations for series of circular functions (see *FOURIER'S SERIES*). A complete investigation of this matter is given by Hobson, *Proc. Lond. Math. Soc.*, 2nd series, vol. 6, p. 388, and vol. 7, p. 24. See also Dini's *Serie di Fourier*.

The expansion may be applied to the determination at an external and an internal point of the potential due to a distribution of matter of surface density $f(\mu)$ placed on a spherical surface $r = a$. If

$$V_i = \Sigma A_n \frac{r^n}{a^{n+1}} P_n(\mu), \quad V_0 = \Sigma A_n \frac{a^n}{r^{n+1}} P_n(\mu),$$

we see that V_i, V_0 have the characteristic properties of potential functions for the spaces internal to, and external to, the spherical surface respectively; moreover, the condition that V_i is continuous with V_0 at the surface $r = a$, is satisfied. The density of a surface distribution which produces these potentials is in accordance with a known theorem in the potential theory, given by

$$\sigma = \frac{1}{4\pi} \left(\frac{\partial V_i}{\partial r} - \frac{\partial V_0}{\partial r} \right) r = a,$$

hence

$$\sigma = \frac{1}{4\pi a^2} \Sigma (2n+1) A_n P_n(\mu); \text{ on comparing this with the series (21),}$$

we have $A_n = 2\pi a^2 \int_{-1}^1 f(\mu) P_n(\mu) d\mu$,

hence

$$\begin{cases} V_i = 2\pi a \Sigma \frac{r^n}{a^{n+1}} P_n(\mu) \int_{-1}^1 f(\mu') P_n(\mu') d\mu' \\ V_0 = 2\pi a \Sigma \frac{a^{n+1}}{r^{n+1}} P_n(\mu) \int_{-1}^1 f(\mu') P_n(\mu') d\mu' \end{cases}$$

are the required expressions for the internal and external potentials due to the distribution of surface density $f(\mu)$.

15. *Integral Properties of Spherical Harmonics.*—The fundamental harmonic property of spherical harmonics, of which property (19) is a particular case, is that if $Y_n(x, y, z), Z_{n'}(x, y, z)$ be two (ordinary) spherical harmonics, then,

$$\iint Y_n(x, y, z) Z_{n'}(x, y, z) dS = 0, \tag{22}$$

when n and n' are unequal, the integration being taken for every element dS of a spherical surface, of which the origin is the centre.

Since $\nabla^2 Y_n = 0, \nabla^2 Z_{n'} = 0$, we have

$$\iiint (Y_n \nabla^2 Z_{n'} - Z_{n'} \nabla^2 Y_n) dx dy dz = 0,$$

the integration being taken through the volume of the sphere of radius r ; this volume integral may be written

$$\iiint \left\{ \frac{\partial}{\partial x} \left(Y_n \frac{\partial Z_{n'}}{\partial x} - Z_{n'} \frac{\partial Y_n}{\partial x} \right) + \frac{\partial}{\partial y} \left(Y_n \frac{\partial Z_{n'}}{\partial y} - Z_{n'} \frac{\partial Y_n}{\partial y} \right) + \frac{\partial}{\partial z} \left(Y_n \frac{\partial Z_{n'}}{\partial z} - Z_{n'} \frac{\partial Y_n}{\partial z} \right) \right\} dx dy dz = 0;$$

by a well-known theorem in the integral calculus, the volume integral may be replaced by a surface integral over the spherical surface; we thus obtain

$$\iint \left\{ \frac{x}{r} \left(Y_n \frac{\partial Z_{n'}}{\partial x} - Z_{n'} \frac{\partial Y_n}{\partial x} \right) + \frac{y}{r} \left(Y_n \frac{\partial Z_{n'}}{\partial y} - Z_{n'} \frac{\partial Y_n}{\partial y} \right) + \frac{z}{r} \left(Y_n \frac{\partial Z_{n'}}{\partial z} - Z_{n'} \frac{\partial Y_n}{\partial z} \right) \right\} dS = 0;$$

on using Euler's theorem for homogeneous functions, this becomes

$$\frac{n'-n}{r} \iint Y_n Z_{n'} dS = 0,$$

whence the theorem (22), which is due to Laplace, is proved.

The integral over a spherical surface of the product of a spherical harmonic of degree n , and a zonal surface harmonic P_n of the same degree, the pole of which is at (x', y', z') is given by

$$\iint Y_n(x, y, z) P_n dS = \frac{4\pi}{2n+1} a^{n+2} Y_n(x', y', z'); \tag{23}$$

thus the value of the integral depends on the value of the spherical harmonic at the pole of the zonal harmonic.

This theorem may also be written

$$\int_0^{2\pi} \int_{-1}^1 V_n(\theta, \phi) P_n(\cos \theta \cos \theta' + \sin \theta \sin \theta' \cos \phi - \phi') d\mu d\phi = \frac{4\pi}{2n+1} V_n(\theta', \phi').$$

To prove the theorem, we observe that V_n is of the form

$$a_0 P_n(\mu) + \Sigma_{\mu=1}^n (a_m \cos m\phi + b_m \sin m\phi) P_n^m(\mu);$$

to determine a_0 we observe that when $\mu = 1$,

$$P_n(\mu) = 1, P_n^m(\mu) = 0;$$

hence a_0 is equal to the value $V_n(0)$ of $V_n(\theta, \phi)$ at the pole $\theta = 0$ of $P_n(\mu)$. Multiply by $P_n(\mu)$ and integrate over the surface of the sphere of radius unity, we then have

$$\begin{aligned} \int_0^{2\pi} \int_{-1}^1 V_n(\theta, \phi) P_n(\mu) d\mu d\phi &= a_0 \int_0^{2\pi} \int_{-1}^1 \{P_n(\mu)\}^2 d\mu d\phi \\ &= \frac{4\pi}{2n+1} a_0 = \frac{4\pi}{2n+1} V_n(0), \end{aligned}$$

if instead of taking $\mu = 1$ as the pole of $P_n(\mu)$ we take any other point (μ', ϕ') we obtain the theorem (23).

If $f(x, y, z)$ is a function which is finite and continuous throughout the interior of a sphere of radius R , it may be shown that

$$\iint Y_n(x, y, z) f(x, y, z) dS = 4\pi R^{2n+2} \frac{2^n n!}{(2n+1)!} \left\{ 1 + \frac{R^2 \nabla^2}{2 \cdot 2n+3} + \frac{R^4 \nabla^4}{2 \cdot 4 \cdot 2n+3 \cdot 2n+5} + \dots \right\} Y_n \left(\frac{\partial}{\partial x}, \frac{\partial}{\partial y}, \frac{\partial}{\partial z} \right) f(x, y, z)$$

where x, y, z are put equal to zero after the operations have been performed, the integral being taken over the surface of the sphere of radius R (see Hobson, "On the Evaluation of a certain Surface Integral," *Proc. Lond. Math. Soc.* vol. xxv.).

The following case of this theorem should be remarked: If $f_n(x, y, z)$ is homogeneous and of degree n

$$\iint Y_n(x, y, z) f_n(x, y, z) dS = 4\pi R^{2n+2} \frac{2^n n!}{(2n+1)!} Y_n \left(\frac{\partial}{\partial x}, \frac{\partial}{\partial y}, \frac{\partial}{\partial z} \right) f_n(x, y, z)$$

if $f_n(x, y, z)$ is a spherical harmonic, we obtain from this a theorem, due to Maxwell (*Electricity*, vol. i. ch. ix.),

$$\iint Y_n(x, y, z) f_n(x, y, z) dS = \frac{4\pi R^{2n+2}}{2n+1} \frac{1}{n!} \frac{\partial^n}{\partial h_1 \partial h_2 \dots \partial h_n} f_n(x, y, z)$$

where h_1, h_2, \dots, h_n are the axes of Y_n . Two harmonics of the same degree are said to be conjugate, when the surface integral of their product vanishes; if Y_n, Z_n are two such harmonics, the addition of conjugacy is

$$Y_n \left(\frac{\partial}{\partial x}, \frac{\partial}{\partial y}, \frac{\partial}{\partial z} \right) Z_n(x, y, z) = 0.$$

Lord Kelvin has shown how to express the conditions that $2n+1$ harmonics of degree n form a conjugate system (see *B. A. Report*, 1871).

16. *Expansion of a Function in a Series of Spherical Harmonics.*—It can be shown that under certain restrictions as to the nature of a function $F(\mu, \phi)$ given arbitrarily over the surface of a sphere, the function can be represented by a series of spherical harmonics which converges in general uniformly. On this assumption we see that the terms of the series can be found by the use of the theorems (22), (23). Let $F(\mu, \phi)$ be represented by

$$V_0(\mu, \phi) + V_1(\mu, \phi) + \dots + V_n(\mu, \phi) + \dots;$$

change μ, ϕ into μ', ϕ' and multiply by

$$P_n(\cos \theta \cos \theta' + \sin \theta \sin \theta' \cos \overline{\phi - \phi'}),$$

we have then

$$\begin{aligned} & \int_0^{2\pi} \int_{-1}^1 F(\mu', \phi') P_n(\cos \theta \cos \theta' + \sin \theta \sin \theta' \cos \overline{\phi - \phi'}) d\mu' d\phi' \\ &= \int_0^{2\pi} \int_0^1 V_n(\mu', \phi') P_n(\cos \theta \cos \theta' + \sin \theta \sin \theta' \cos \overline{\phi - \phi'}) d\mu' d\phi' \\ &= \frac{4\pi}{2n+1} V_n(\theta, \phi), \end{aligned}$$

hence the series which represents $F(\mu, \phi)$ is

$$\frac{1}{2} \pi \sum_0^\infty (2n+1) \int_0^{2\pi} \int_{-1}^1 F(\mu', \phi') P_n(\cos \theta \cos \theta' + \sin \theta \sin \theta' \cos \overline{\phi - \phi'}) d\mu' d\phi'. \quad (24)$$

A rational integral function of $\sin \theta \cos \phi, \sin \theta \sin \phi, \cos \theta$ of degree n may be expressed as the sum of a series of spherical harmonics, by assuming

$$f_n(x, y, z) = Y_n + r^2 Y_{n-2} + r^4 Y_{n-4} + \dots$$

and determining the solid harmonics Y_n, Y_{n-2}, \dots and then letting $r=1$, in the result.

$$\begin{aligned} \text{Since } \nabla^2(r^{2s} Y_{n-2s}) &= 2s(2n-2s+1)r^{2s-2} Y_{n-2s}, \text{ we have} \\ \nabla^2 f_n &= 2(2n-1)Y_{n-2} + 4(2n-3)r^2 Y_{n-4} + 6(2n-5)r^4 Y_{n-6} + \dots \\ \nabla^4 f_n &= 2 \cdot 4(2n-3)(2n-5)Y_{n-4} + 4 \cdot 6(2n-5)(2n-7)r^2 Y_{n-6} + \dots \end{aligned}$$

the last equation being

$$\nabla^n f_n = n(n+1)(n-2)(n-1) \dots Y_0, \text{ if } n \text{ is even,}$$

or

$$\nabla^{n-1} f_n = (n-1)(n+2)(n-3) \dots Y_1, \text{ if } n \text{ is odd}$$

from the last equation Y_0 or Y_1 is determined, then from the preceding one Y_2 or Y_3 , and so on. This method is due to Gauss (see *Collected Works*, v. 630).

As an example of the use of spherical harmonics in the potential theory, suppose it required to calculate at an external point, the potential of a nearly spherical body bounded by $r=a(1+\epsilon u)$, the body being made of homogeneous material of density unity, and u being a given function of θ, ϕ , the quantity ϵ being so small that its square may be neglected. The potential is given by

$$\int_0^{2\pi} \int_{-1}^1 \int_0^{a(1+\epsilon u)} \{r^2 + r'^2 - 2rr' \cos \gamma\}^{-\frac{1}{2}} dr' d\mu' d\phi',$$

where γ is the angle between r and r' ; now let u' be expanded in a series

$$Y_0(\mu', \phi') + Y_1(\mu', \phi') + \dots + Y_n(\mu', \phi') + \dots$$

of surface harmonics; we may write the expression for the potential

$$\begin{aligned} & \int_0^{2\pi} \int_{-1}^1 \int_0^{a(1+\epsilon u')} \left\{ \frac{1}{r} + \frac{r'}{r^2} P_1(\cos \gamma) + \dots \right. \\ & \left. + \frac{r'^n}{r^{n+1}} P_n(\cos \gamma) + \dots \right\} r'^2 dr' d\mu' d\phi' \end{aligned}$$

which is,

$$\begin{aligned} & \int_0^{2\pi} \int_{-1}^1 \left\{ \frac{a^3}{3r} (1+3\epsilon u') + \frac{1}{4} \frac{a^4}{r^2} (1+4\epsilon u') P_1 + \dots \right. \\ & \left. + \frac{1}{n+3} \frac{a^{n+3}}{r^{n+1}} (1+n\epsilon u') P_n(\cos \gamma) \right\} d\mu' d\phi' \end{aligned}$$

on substituting for u' the series of harmonics, and using (22), (23), this becomes

$$4\pi a^2 \left[\frac{1}{3} \frac{a}{r} + \epsilon \left\{ \frac{a^3}{3r^2} Y_1(\mu, \phi) + \frac{a^3}{5r^2} Y_2(\mu, \phi) + \dots + \frac{a^{n+1}}{(2n+1)r^{n+1}} Y_n(\mu, \phi) + \dots \right\} \right]$$

which is the required potential at the external point (r, θ, ϕ) .

17. *The Normal Solutions of Laplace's Equation in Polars.*—If h_1, h_2, h_3 be the parameters of three orthogonal sets of surfaces, the length of an elementary arc ds may be expressed by an equation of the form $ds^2 = \frac{1}{H_1^2} dh_1^2 + \frac{1}{H_2^2} dh_2^2 + \frac{1}{H_3^2} dh_3^2$, where H_1, H_2, H_3 are

functions of h_1, h_2, h_3 , which depend on the form of these parameters; it is known that Laplace's equation when expressed with h_1, h_2, h_3 as independent variables, takes the form

$$\frac{\partial}{\partial h_1} \left(\frac{H_1}{H_2 H_3} \frac{\partial V}{\partial h_1} \right) + \frac{\partial}{\partial h_2} \left(\frac{H_2}{H_1 H_3} \frac{\partial V}{\partial h_2} \right) + \frac{\partial}{\partial h_3} \left(\frac{H_3}{H_1 H_2} \frac{\partial V}{\partial h_3} \right) = 0. \quad (25)$$

In case the orthogonal surfaces are concentric spheres, co-axial circular cones, and planes through the axes of the cones, the parameters are the usual polar co-ordinates r, θ, ϕ , and in this case

$$H_1 = 1, H_2 = \frac{1}{r}, H_3 = \frac{1}{r \sin \theta}, \text{ thus Laplace's equation becomes}$$

$$\frac{\partial}{\partial r} \left(r^2 \frac{\partial V}{\partial r} \right) + \frac{1}{\sin \theta} \frac{\partial}{\partial \theta} \left(\sin \theta \frac{\partial V}{\partial \theta} \right) + \frac{1}{\sin^2 \theta} \frac{\partial^2 V}{\partial \phi^2} = 0.$$

Assume that $V = R\Theta\Phi$ is a solution, R being a function of r only, Θ of θ only, Φ of ϕ only; we then have

$$\frac{1}{R} \frac{d}{dr} \left(r^2 \frac{dR}{dr} \right) + \frac{1}{\Theta \sin \theta} \frac{d}{d\theta} \left(\sin \theta \frac{d\Theta}{d\theta} \right) + \frac{1}{\sin^2 \theta} \frac{d^2 \Phi}{d\phi^2} = 0.$$

This can only be satisfied if $\frac{1}{R} \frac{d}{dr} \left(r^2 \frac{dR}{dr} \right)$ is a constant, say

$$n(n+1), \frac{1}{\Theta} \frac{d^2 \Theta}{d\theta^2} \text{ is a constant, say } -m^2, \text{ and } \Theta \text{ satisfies the equation}$$

$$\frac{1}{\sin \theta} \frac{d}{d\theta} \left(\sin \theta \frac{d\Theta}{d\theta} \right) + \left\{ n(n+1) - \frac{m^2}{\sin^2 \theta} \right\} \Theta = 0,$$

if we write u for Θ , and μ for $\sin \theta$, this equation becomes

$$\frac{d}{d\mu} \left\{ (1-\mu^2) \frac{du}{d\mu} \right\} + \left\{ n(n+1) - \frac{m^2}{1-\mu^2} \right\} u = 0. \quad (26)$$

From the equations which determine R, Θ, u , it appears that Laplace's equation is satisfied by

$$\frac{r^n \cos^m \theta}{r^{n-1} \sin^m \theta} \cdot u_n^m$$

where u is any solution of (26); this product we may speak of as the normal solution of Laplace's equation in polar co-ordinates; it will be observed that the constants n, m may have any real or complex values.

18. *Legendre's Equation.*—If in the above normal solution we consider the case $m=0$, we see that

$$\frac{r^n}{r^{n-1} u_n}$$

is the normal form, where u_n satisfies the equation

$$\frac{d}{d\mu} \left\{ (1-\mu^2) \frac{du}{d\mu} \right\} + n(n+1)u = 0, \quad (27)$$

known as Legendre's equation; we shall here consider the special case in which n is a positive integer. One solution of (27) will be the Legendre's coefficient $P_n(\mu)$, and to find the complete primitive we must find another particular integral; in considering the forms of solution, we shall consider μ to be not necessarily real and between ± 1 . If we assume

$$u = \mu^m + a_2 \mu^{m-2} + a_4 \mu^{m-4} + \dots$$

as a solution, and substitute in the equation (27), we find that $m=n$, or $-n-1$, and thus we have as solutions, on determining the ratios of the coefficients in the two cases,

$$a \left\{ \mu^n - \frac{n(n-1)}{2 \cdot 2n-1} \mu^{n-2} + \dots \right\}$$

and

$$\beta \left\{ \frac{1}{\mu^{n+1}} + \frac{(n+1)(n+2)}{2 \cdot 2n+3} \frac{1}{\mu^{n+3}} + \frac{(n+1)(n+2)(n+3)(n+4)}{2 \cdot 4 \cdot 2n+3 \cdot 2n+5} \frac{1}{\mu^{n+5}} + \dots \right\}$$

the first of these series is (n integral) finite, and represents $P_n(\mu)$, the second is an infinite series which is convergent when $\text{mod } \mu > 1$.

If we choose the constant β to be $\frac{1 \cdot 2 \cdot 3 \dots n}{3 \cdot 5 \dots 2n+1}$, the second

solution may be denoted by $Q_n(\mu)$, and is called the Legendre's function of the second kind, thus

$$\begin{aligned} Q_n(\mu) &= \frac{1 \cdot 2 \cdot 3 \dots n}{3 \cdot 5 \dots 2n+1} \left\{ \frac{1}{\mu^{n+1}} + \frac{(n+1)(n+2)}{2 \cdot 2n+3} \frac{1}{\mu^{n+3}} + \dots \right\} \\ &= \frac{1 \cdot 2 \cdot 3 \dots n}{3 \cdot 5 \dots 2n+1} \frac{1}{\mu^{n+1}} F \left(\frac{n+1}{2}, \frac{n+2}{2}, \frac{2n+3}{2}, \frac{1}{\mu^2} \right). \quad (28) \end{aligned}$$

This function $Q_n(\mu)$, thus defined for $\text{mod } \mu > 1$, is of considerable importance in the potential theory. When $\text{mod } \mu < 1$, we may in a similar manner obtain two series in ascending powers of μ , one of which represents $P_n(\mu)$, and a certain linear function of the two series represents the analytical continuation of $Q_n(\mu)$ as defined above. The complete primitive of Legendre's equation is

$$u = AP_n(\mu) + BQ_n(\mu).$$

By the usual rule for obtaining the complete primitive of an ordinary differential equation of the second order when a particular integral is known, it can be shown that (27) is satisfied by

$$P_n(\mu) = \int^\mu \frac{d\mu}{(\mu^2-1) \{P_n(\mu)\}^2},$$

the lower limit being arbitrary.

From this form it can be shown that

$$Q_n(\mu) = \frac{1}{2} P_n(\mu) \log \frac{\mu+1}{\mu-1} - W_{n-1}(\mu),$$

where $W_{n-1}(\mu)$ is a rational integral function of degree $n-1$ in μ ; it can be shown that this form is in agreement with the definition of $Q_n(\mu)$ by series, for the case $\text{mod } \mu > 1$. In case $\text{mod } \mu < 1$ it is convenient to use the symbol $Q_n(\mu)$ for

$$\frac{1}{2} P_n(\mu) \log \frac{1+\mu}{1-\mu} - W_{n-1}(\mu),$$

which is real when μ is real and between ± 1 , the function $Q_n(\mu)$ in this case is not the analytical continuation of the function $Q_n(\mu)$ for $\text{mod } \mu > 1$, but differs from it by an imaginary multiple of $P_n(\mu)$. It will be observed that $Q_n(1)$, $Q_n(-1)$ are infinite, and $Q_n(\infty) = 0$. The function $W_{n-1}(\mu)$ has been expressed by Christoffel in the form

$$\frac{2n-1}{1 \cdot n} P_{n-1}(\mu) + \frac{2n-5}{3 \cdot n-1} P_{n-3}(\mu) + \frac{2n-9}{5 \cdot n-2} P_{n-5}(\mu) + \dots,$$

and it can also be expressed in the form

$$\frac{1}{n} P_0(\mu) P_{n-1}(\mu) + \frac{1}{n-1} P_1(\mu) P_{n-2}(\mu) + \dots + P_{n-1}(\mu) P_0(\mu).$$

It can easily be shown that the formula (28) is equivalent to

$$Q_n(\mu) = 2^n n! \int_{\mu}^{\infty} \int_{\mu}^{\infty} \dots \int_{\mu}^{\infty} \frac{(d\mu)^{n+1}}{(\mu^2-1)^{n+1}}$$

which is analogous to Rodrigue's expression for $P_n(\mu)$.

Another expression of a similar character is

$$Q_n(\mu) = (-1)^n \frac{2^n n!}{(2n)!} \frac{d^n}{d\mu^n} \left\{ (\mu^2-1)^n \int_{\mu}^{\infty} \frac{d\mu}{(\mu^2-1)^{n+1}} \right\}.$$

It can be shown that under the condition $\text{mod } \{u - \sqrt{(\mu^2-1)}\} > \text{mod } \{\mu - \sqrt{(\mu^2-1)}\}$, the function $1/(\mu-u)$ can be expanded in the form $\Sigma(2n+1)P_n(u)Q_n(\mu)$; this expansion is connected with the definite integral formula for $Q_n(\mu)$ which was used by F. Neumann as a definition of the function $Q_n(\mu)$, this is

$$Q_n(\mu) = \frac{1}{2} \int_{-1}^1 \frac{P_n(u)}{\mu-u} du,$$

which holds for all values of μ which are not real and between ± 1 .

From Neumann's integral can be deduced the formula

$$Q_n(\mu) = \int_1^{\infty} \frac{d\psi}{\{\mu + \sqrt{(\mu^2-1)} \cdot \cosh \psi\}^{n+1}},$$

which holds for all values of μ which are not real and between ± 1 , provided the sign of $\sqrt{(\mu^2-1)}$ is properly chosen; when μ is real and greater than 1, $\sqrt{(\mu^2-1)}$ has its positive value.

By means of the substitution

$$\{\mu + \sqrt{(\mu^2-1)} \cdot \cosh \psi\} \{\mu - \sqrt{(\mu^2-1)} \cdot \cosh \chi\} = 1,$$

the above integral becomes

$$Q_n(\mu) = \int_0^{\chi_0} \{\mu - \sqrt{(\mu^2-1)} \cdot \cosh \chi\}^n d\chi, \text{ where } \chi_0 = \frac{1}{2} \log_e \frac{\mu+1}{\mu-1}.$$

This formula gives a simple means of calculating $Q_n(\mu)$ for small values of n ; thus

$$Q_0(\mu) = \int_0^{\chi_0} d\chi = \frac{1}{2} \log_e \frac{\mu+1}{\mu-1}.$$

$$Q_1(\mu) = \mu \chi_0 - \sqrt{(\mu^2-1)} \cdot \sinh \chi_0 = \mu \cdot \frac{1}{2} \log_e \frac{\mu+1}{\mu-1} - 1.$$

Neumann's integral affords a means of establishing a relation between successive Q functions, thus

$$\begin{aligned} nQ_n - (2n-1)\mu Q_{n-1} + (n-1)Q_{n-2} \\ = \frac{1}{2} \int_{-1}^1 \frac{nP_n(u) + (n-1)P_{n-2}(u) - (2n-1)\mu P_{n-1}(u)}{\mu-u} du \\ = -\frac{1}{2} \int_{-1}^1 (2n-1)P_{n-1}(u) du. \end{aligned}$$

Again, it may similarly be proved that

$$\frac{dQ_{n+1}}{d\mu} - \frac{dQ_{n-1}}{d\mu} = (2n+1)Q_n.$$

19. Legendre Associated Functions.—Returning to the equation

(26) satisfied by u_n^m the factor in the normal forms $r^{n-1} \frac{\cos m\phi}{\sin m\phi} u_n^m$,

we shall consider the case in which n, m are positive integers, and $n \geq m$. Let $u = (\mu^2-1)^{\frac{1}{2}}v$, then it will be found that v satisfies the equation

$$(1-\mu^2) \frac{d^2v}{d\mu^2} - 2(m+1)\mu \frac{dv}{d\mu} + (n-m)(n+m+1)v = 0.$$

If, in Legendre's equation, we differentiate m times, we find

$$(1-\mu^2) \frac{d^{m+2}u}{d\mu^{m+2}} - 2(m+1)\mu \frac{d^{m+1}u}{d\mu^{m+1}} + (n-m)(n+m+1) \frac{d^m u}{d\mu^m} = 0;$$

it follows that $v = \frac{d^m u}{d\mu^m}$; hence $u_n^m = (\mu^2-1)^{\frac{1}{2}} \frac{d^m u}{d\mu^m}$.

The complete solution of (26) is therefore

$$u = (\mu^2-1)^{\frac{1}{2}} \left\{ A \frac{d^m P_n(\mu)}{d\mu^m} + B \frac{d^m Q_n(\mu)}{d\mu^m} \right\};$$

when μ is real and lies between ± 1 , the two functions

$$(1-\mu^2)^{\frac{1}{2}} \frac{d^m P_n(\mu)}{d\mu^m}, (1-\mu^2)^{\frac{1}{2}} \frac{d^m Q_n(\mu)}{d\mu^m}$$

are called Legendre's associated functions of degree n , and order m , of the first and second kinds respectively. When μ is not real and between ± 1 , the same names are given to the two functions

$$(\mu^2-1)^{\frac{1}{2}} \frac{d^m P_n(\mu)}{d\mu^m}, (\mu^2-1)^{\frac{1}{2}} \frac{d^m Q_n(\mu)}{d\mu^m};$$

in either case the functions may be denoted by $P_n^m(\mu), Q_n^m(\mu)$.

It can be shown that, when μ is real and between ± 1

$$\begin{aligned} P_n^m(\mu) &= \frac{(-1)^m}{2^n(n-m)!} \left(\frac{1+\mu}{1-\mu} \right)^{\frac{1}{2}m} \frac{d^m}{d\mu^m} \{ (\mu-1)^{n+m} (\mu+1)^{n-m} \} \\ &= \frac{1}{2^n(n-m)!} \left(\frac{1-\mu}{1+\mu} \right)^{\frac{1}{2}m} \frac{d^m}{d\mu^m} \{ (\mu-1)^{n-m} (\mu+1)^{n+m} \}. \end{aligned}$$

In the same case, we find

$$\begin{aligned} P_n^{m+2}(\cos \theta) - 2(m+1) \cot \theta P_n^{m+1}(\cos \theta) \\ + (n-m)(n+m+1) P_n^m(\cos \theta) = 0, \\ (n-m+2) P_n^m(\cos \theta) - (2n+3) \mu P_n^{m+1}(\cos \theta) \\ + (n+m+1) P_n^m(\cos \theta) = 0. \end{aligned}$$

20. Bessel's Functions.—If we take for three orthogonal systems of surfaces a system of parallel planes, a system of co-axial circular cylinders perpendicular to the planes, and a system of planes through the axis of the cylinders, the parameters are z, ρ, ϕ , the cylindrical co-ordinates; in that case $H_1=1, H_2=1, H_3=1/\rho$, and the equation (25) becomes

$$\frac{\partial^2 V}{\partial z^2} + \frac{\partial^2 V}{\partial \rho^2} + \frac{1}{\rho} \frac{\partial V}{\partial \rho} + \frac{1}{\rho^2} \frac{\partial^2 V}{\partial \phi^2} = 0.$$

To find the normal functions which satisfy this equation, we put $V = ZR\Phi$, when Z is a function of z only, R of ρ only, and Φ of ϕ , the equation then becomes

$$\frac{1}{Z} \frac{d^2 Z}{dz^2} + \frac{1}{R} \left(\frac{d^2 R}{d\rho^2} + \frac{1}{\rho} \frac{dR}{d\rho} \right) + \frac{1}{\rho^2} \frac{1}{\Phi} \frac{d^2 \Phi}{d\phi^2} = 0.$$

That this may be satisfied we must have $\frac{1}{Z} \frac{d^2 Z}{dz^2}$ constant, say $=k^2$,

$\frac{1}{R} \frac{d^2 R}{d\rho^2}$ constant, say $=-m^2$, and R , for which we write u , must satisfy the differential equation

$$\frac{d^2 u}{d\rho^2} + \frac{1}{\rho} \frac{du}{d\rho} + \left(k^2 - \frac{m^2}{\rho^2} \right) u = 0,$$

it follows that the normal forms are $e^{\pm k z \cos \phi} \frac{1}{\sin m\phi} u(k\rho)$, where $u(\rho)$ satisfies the equation

$$\frac{d^2 u}{d\rho^2} + \frac{1}{\rho} \frac{du}{d\rho} + \left(1 - \frac{m^2}{\rho^2} \right) u = 0. \tag{29}$$

This is known as Bessel's equation of order m ; the particular case

$$\frac{d^2 u}{d\rho^2} + \frac{1}{\rho} \frac{du}{d\rho} + u = 0, \tag{30}$$

corresponding to $m=0$, is known as Bessel's equation.

If we solve the equation (29) in series, we find by the usual process that it is satisfied by the series

$$\rho^m \left\{ 1 - \frac{\rho^2}{2 \cdot 2m+2} + \frac{\rho^4}{2 \cdot 4 \cdot 2m+2 \cdot 2m+4} - \dots \right\};$$

the expression

$$\frac{\rho^m}{2^m \Pi(m)} \left\{ 1 - \frac{\rho^2}{2 \cdot 2m+2} + \frac{\rho^4}{2 \cdot 4 \cdot 2m+2 \cdot 2m+4} - \dots \right\}$$

or

$$\sum_{n=0}^{\infty} \frac{(-1)^n \rho^{m+2n}}{2^{m+2n} \Pi(m+n) \Pi(n)}$$

is denoted by $J_m(\rho)$.

When $m=0$, the solution

$$1 - \frac{\rho^2}{2^2} + \frac{\rho^4}{2^2 \cdot 4^2} - \dots$$

of the equation (30) is denoted by $J_0(\rho)$ or by $J(\rho)$.

The function $J_m(\rho)$ is called Bessel's function of order m , and $J_0(\rho)$ simply Bessel's function; the series are convergent for all finite values of ρ .

The equation (29) is unaltered by changing m into $-m$, it follows that $J_{-m}(\rho)$ is a second solution of (29), thus in general

$$u = AJ_m(\rho) + BJ_{-m}(\rho)$$

is the complete primitive of (29). However, in the most important case, that in which m is an integer, the solutions $J_{-m}(\rho)$, $J_m(\rho)$ are not distinct, for $J_{-m}(\rho)$ may be written in the form

$$\left(\frac{\rho}{2}\right)^{-m} \sum_{n=0}^{m-1} \frac{(-1)^n}{\Pi(n-m)\Pi(n)} \left(\frac{\rho}{2}\right)^{2n} + (-1)^m \left(\frac{\rho}{2}\right)^m \sum_{p=0}^{\infty} \frac{(-1)^p}{\Pi(m+p)\Pi(p)} \left(\frac{\rho}{2}\right)^{2p}$$

now $\Pi(n-m)$ is infinite when m is an integer, and $n < m$; thus the first part of the expression vanishes, and the second part is $(-1)^m J_m(\rho)$, hence when m is an integer $J_{-m}(\rho) = (-1)^m J_m(\rho)$, and the second solution remains to be found.

Bessel's Functions of the Second Kind.—When m is not a real integer, we have seen that any linear function of $J_m(\rho)$, $J_{-m}(\rho)$ satisfies the equation of order m . The Bessel's function of the second kind of order m is defined as the particular linear function

$$\frac{\pi e^{m\pi i} J_{-m}(\rho) - \cos m\pi \cdot J_m(\rho)}{\sin 2m\pi},$$

and may be denoted by $Y_m(\rho)$. This definition has the advantage of giving a meaning to $Y_m(\rho)$ in the case in which m is an integer, for it may be evaluated as a limiting form 0/0, and the limit will satisfy the equation (29). The only failing case is when m is half an odd integer; in that case we take $\cos m\pi \cdot Y_m(\rho)$ as a second finite solution of the differential equation.

When m is an integer, we have

$$Y_m(\rho) = (-1)^m \frac{\pi}{2} \left\{ \frac{dJ_{-m-\epsilon}}{d\epsilon} - (-1)^m \frac{dJ_{m+\epsilon}}{d\epsilon} \right\} \epsilon = 0$$

on carrying out the differentiations, and proceeding to the limit we find

$$Y_m(\rho) = J_m(\rho) \log \frac{\rho}{2} + \frac{1}{2} \left(\frac{\rho}{2}\right)^m \sum_{n=0}^{\infty} \frac{\dagger(n) + \dagger(m+n)}{\Pi(n)\Pi(m+n)} \frac{(-1)^n}{\Pi(n)} \left(\frac{\rho}{2}\right)^{2n} + \frac{1}{2} \left(\frac{\rho}{2}\right)^{-m} \sum_{n=0}^{m-1} \frac{\Pi(m-n-1)}{\Pi(n)} \left(\frac{\rho}{2}\right)^{2n}$$

where $\dagger(n)$ denotes $\Pi'(n)/\Pi(n)$.

When $m=0$ we have the second solution of (30) given by

$$Y_0(\rho) = J_0(\rho) \log \frac{\rho}{2} + \sum_{n=0}^{\infty} \frac{(-1)^{n+\dagger(n)}}{\Pi(n)\Pi(n)} \left(\frac{\rho}{2}\right)^{2n}.$$

21. Relations between Bessel's Functions of Different Orders.—Since $e^{\pm i\phi} \cos m\phi \cdot u_m(\rho)$ satisfies Laplace's equation, it follows that $\frac{\cos m\phi \cdot u_m(\rho)}{\sin m\phi}$ satisfies the differential equation

$$\frac{\partial^2 u}{\partial x^2} + \frac{\partial^2 u}{\partial y^2} + u = 0. \tag{31}$$

The linear character of this equation shows that if u is any solution

$$f \left(\frac{\partial}{\partial x}, \frac{\partial}{\partial y} \right) u$$

is also one, f denoting a rational integral function of the operators. Let ξ, η denote $x+iy, x-iy$, then since $\rho^{-m} \xi^m u_m(\sqrt{\xi\eta})$ satisfies the differential equation, so also does

$$\xi^m \frac{\partial^p}{\partial \eta^p} \{ \rho^{-m} u_m(\sqrt{\xi\eta}) \},$$

or

$$\xi^{m+p} \frac{d^p}{d(\rho^2)^p} \{ \rho^{-m} u_m(\rho) \},$$

thus we have

$$u_{m+p} = C \rho^{m+p} \frac{d^p}{d(\rho^2)^p} \left\{ \frac{u_m(\rho)}{\rho^m} \right\}$$

where C is a constant. If $u_m(\rho) = J_m(\rho)$, we have $u_{m+p} = J_{m+p}(\rho)$, and by comparing the coefficients of ρ^{m+p} , we find $C = (-2)^p$, hence

$$J_{m+p}(\rho) = (-2)^p \rho^{m+p} \frac{d^p}{d(\rho^2)^p} \{ \rho^{-m} J_m(\rho) \},$$

and changing m into $-m$, we find

$$J_{p-m}(\rho) = (-2)^p \rho^{p-m} \frac{d^p}{d(\rho^2)^p} \{ \rho^m J_{-m}(\rho) \}.$$

In a similar manner it can be proved that

$$J_{m-p}(\rho) = 2^p \rho^{p-m} \frac{d^p}{d(\rho^2)^p} \{ \rho^m J_m(\rho) \}.$$

From the definition of $Y_m(\rho)$, and applying the above analysis, we prove that

$$Y_{m+p}(\rho) = (-2)^p \rho^{m+p} \frac{d^p}{d(\rho^2)^p} \{ \rho^{-m} Y_m(\rho) \}$$

and

$$Y_{m-p}(\rho) = 2^p \rho^{p-m} \frac{d^p}{d(\rho^2)^p} \{ \rho^m Y_m(\rho) \}.$$

As particular cases of the above formulae, we find

$$J_p(\rho) = (-2)^p \frac{d^p}{d(\rho^2)^p} J_0(\rho), \quad Y_p(\rho) = (-2)^p \frac{d^p}{d(\rho^2)^p} Y_0(\rho)$$

$$J_1(\rho) = -\frac{dJ_0(\rho)}{d\rho}, \quad Y_1(\rho) = -\frac{dY_0(\rho)}{d\rho}.$$

22. Bessel's Functions as Coefficients in an Expansion.—It is clear that $e^{\nu\phi} \cos \phi = e^{\nu x}$ or $e^{\nu\phi} \sin \phi = e^{\nu y}$ satisfy the differential equation (31), hence if these exponentials be expanded in series of cosines and sines of multiples of ϕ , the coefficients must be Bessel's functions, which it is easy to see are of the first kind. To expand $e^{\nu\phi} \sin \phi$, put $e^{\nu\phi} = t$, we have then to expand $e^{\frac{1}{2}\rho t(t^{-1})}$ in powers of t . Multiplying together the two absolutely convergent series

$$e^{\frac{1}{2}\rho t} = \sum \frac{1}{m!} \left(\frac{\rho}{2}\right)^m t^m, \quad e^{-\frac{1}{2}\rho t^{-1}} = \sum \frac{(-1)^m}{m!} \left(\frac{\rho}{2}\right)^m t^{-m},$$

we obtain for the coefficient of t^m in the product

$$\frac{\rho^m}{2^m m!} \left\{ 1 - \frac{\rho^2}{2 \cdot 2m+2} + \frac{\rho^4}{2 \cdot 4 \cdot 2m+2 \cdot 2m+4} - \dots \right\} \text{ or } J_m(\rho),$$

hence

$$e^{\frac{1}{2}\rho(t-t^{-1})} = J_0(\rho) + tJ_1(\rho) + \dots + t^m J_m(\rho) + \dots \tag{32}$$

$$= \sum_{-\infty}^{\infty} t^m J_m(\rho)$$

the Bessel's functions were defined by Schlömilch as the coefficients of the powers of t in the expansion of $e^{\frac{1}{2}\rho(t-t^{-1})}$, and many of the properties of the functions can be deduced from this expansion. By differentiating both sides of (32) with respect to t , and equating the coefficients of t^{m-1} on both sides, we find the relation

$$J_{m-1}(\rho) + J_{m+1}(\rho) = \frac{2m}{\rho} J_m(\rho),$$

which connects three consecutive functions. Again, by differentiating both sides of (32) with respect to ρ , and equating the coefficients of corresponding terms, we find

$$2 \frac{dJ_m(\rho)}{d\rho} = J_{m-1}(\rho) - J_{m+1}(\rho).$$

In (32), let $t = e^{i\phi}$, and equate the real and imaginary parts, we have then

$$\cos(\rho \sin \phi) = J_0(\rho) + 2J_2(\rho) \cos 2\phi + 2J_4(\rho) \cos 4\phi + \dots$$

$$\sin(\rho \sin \phi) = 2J_1(\rho) \sin \phi + 2J_3(\rho) \sin 3\phi + \dots$$

we obtain expansions of $\cos(\rho \cos \phi)$, $\sin(\rho \cos \phi)$, by changing ϕ into $\frac{1}{2}\pi - \phi$. On comparing these expansions with Fourier's series, we find expressions for $J_m(\rho)$ as definite integrals, thus

$$J_0(\rho) = \frac{1}{\pi} \int_0^\pi \cos(\rho \sin \phi) d\phi, \quad J_m(\rho) = \frac{1}{\pi} \int_0^\pi \cos(\rho \sin \phi) \cos m\phi d\phi \quad (m \text{ even})$$

$$J_m(\rho) = \frac{1}{\pi} \int_0^\pi \sin(\rho \sin \phi) \sin m\phi d\phi \quad (m \text{ odd}).$$

It can easily be deduced that when m is any positive integer

$$J_m(\rho) = \frac{1}{\pi} \int_0^\pi \cos(m\phi - \rho \sin \phi) d\phi.$$

23. Bessel's Functions as Limits of Legendre's Functions.—The system of orthogonal surfaces whose parameters are cylindrical co-ordinates may be obtained as a limiting case of those whose parameters are polar co-ordinates, when the centre of the spheres moves off to an indefinite distance from the portion of space which is contemplated. It would therefore be expected that the normal forms $e^{\pm \lambda z} J_m(\lambda \rho) \cos m\phi$ would be derivable as limits of $r^{m-n-1} P_n^m(\cos \theta) \cos m\phi$, and we shall show that this is actually the case. If O be the centre of the spheres, take as new origin a point C on the axis of z , such that $OC = a$; let P be a point whose polar co-ordinates are r, θ, ϕ referred to O as origin, and cylindrical co-ordinates ρ, z, ϕ referred to C as origin; we have

$$\rho = r \sin \theta, \quad z = r \cos \theta - a, \quad \text{hence } \left(\frac{r}{a}\right)^n P_n(\cos \theta) = \sec^m \theta \left(1 + \frac{z}{a}\right)^n P_n(\cos \theta).$$

Now let O move off to an infinite distance from C , so that a becomes

infinite, and at the same time let n become infinite in such a way that n/a has a finite value λ . Then

$$L \sec^n \theta = L \left(\sec \frac{\rho}{a} \right)^{\lambda a} = I, \quad L \left(1 + \frac{z}{a} \right)^n = e^{\lambda z},$$

and it remains to find the limiting value of $P_n(\cos \theta)$. From the series (15), it may be at once proved that

$$P_n(\cos \theta) = I - \frac{(n+1)n}{I^2} \left(\sin \frac{\theta}{2} \right)^2 + \dots \\ + (-1)^m \frac{(n+m)\dots(n-m+1)}{I^2 \cdot 2^2 \cdot m^2} \left(\sin \frac{\theta}{2} \right)^{2m}$$

where δ is some number numerically less than unity and m is a fixed finite quantity sufficiently large; on proceeding to the limit, we have

$$LP_n \left(\cos \frac{\lambda \rho}{n} \right) = I - \frac{\lambda^2 \rho^2}{2^2} + \frac{\lambda^4 \rho^4}{2^2 \cdot 4^2} - \dots + (-1)^m \delta_1 \frac{\lambda^{2m} \rho^{2m}}{2^2 \cdot 4^2 \cdot (2m)^2}$$

where δ_1 is less than unity.

Hence

$$L_{n \rightarrow \infty} P_n \left(\cos \frac{\lambda \rho}{n} \right) = J_0(\lambda \rho).$$

Again, since

$$P_n^m(\cos \rho) = \sin^m \theta \frac{d^m P_n(\cos \theta)}{d(\cos \theta)^m},$$

we have

$$Ln^{-m} P_n^m \left(\cos \frac{\rho}{n} \right) = L \frac{\rho^m}{n^{2m}} \frac{d^m P_n \left(\cos \frac{\rho}{n} \right)}{d \left(\frac{\rho^2}{2n^2} \right)^m} \\ = (-2)^m \rho^m \frac{d^m J_0(\rho)}{d(\rho^2)^m}$$

hence

$$L_{n \rightarrow \infty} n^{-m} P_n^m \left(\cos \frac{\rho}{n} \right) = J_m(\rho).$$

It may be shown that $Y_0(\rho)$ is obtainable as the limit of $Q_n \left(\cos \frac{\rho}{n} \right)$ the zonal harmonic of the second kind; and that

$$Y_m(\rho) = Ln^{-m} Q_n^m \left(\cos \frac{\rho}{n} \right).$$

24. *Definite Integral Solutions of Bessel's Equation.*—Bessel's equation of order m , where m is unrestricted, is satisfied by the

expression $\rho^m \int e^{\rho t} (t^2 - 1)^{m-\frac{1}{2}} dt$, where the path of integration is either

a curve which is closed on the Riemann's surface on which the integrand is represented, or is taken between limits, at each of which $e^{\rho t} (t^2 - 1)^{m+\frac{1}{2}}$ is zero. The equation is also satisfied by the expression

$\int e^{\frac{1}{2}\rho(t-t^{-1})} t^{-m-1} dt$ where the integral is taken along a closed

path as before, or between limits at each of which $e^{\frac{1}{2}\rho(t-t^{-1})} t^{-m-1}$ vanishes.

The following definite integral expressions for Bessel's functions are derivable from these fundamental forms.

$$J_m(\rho) = \frac{1}{\Pi(-\frac{1}{2})\Pi(m-\frac{1}{2})} \left(\frac{\rho}{2} \right)^m \int_0^\pi e^{\rho \cos \phi} \sin 2^m \phi d\phi$$

where the real part of $m + \frac{1}{2}$ is positive.

$$Y_m(\rho) + \frac{1}{2}\pi \epsilon \cdot e^{m\pi i} \sec m\pi \cdot J_m(\rho)$$

$$= \frac{\Pi(-\frac{1}{2}-m)}{\Pi(-\frac{1}{2})} \left(\frac{\rho}{2} \right)^m \int_0^{\infty+\frac{1}{2}\pi} e^{\rho \cosh \phi} \sinh 2^m \phi d\phi$$

where the real parts of $m + \frac{1}{2}$, ρ are positive; if ρ is purely imaginary and positive the upper limit may be replaced by ∞ .

$$Y_m(\rho) - \frac{1}{2}\pi \epsilon \cdot e^{m\pi i} \sec m\pi \cdot J_m(\rho)$$

$$= e^{2m\pi i} \frac{\Pi(-\frac{1}{2}-m)}{\Pi(-\frac{1}{2})} \left(\frac{\rho}{2} \right)^m \int_0^{\infty-\frac{1}{2}\pi} e^{-\rho \cosh \phi} \sinh 2^m \phi d\phi$$

under the same restrictions as in the last case; if ρ is a negative imaginary number, we may put ∞ for the upper limit.

If ρ is real and positive

$$J_0(\rho) = \frac{2}{\pi} \int_0^\infty \sin(\rho \cosh \phi) d\phi$$

$$Y_0(\rho) = \int_0^\infty \cos(\rho \cosh \phi) d\phi.$$

25. *Bessel's Functions with Imaginary Argument.*—The functions with purely imaginary argument are of such importance in connexion with certain differential equations of physics that a special notation

has been introduced for them. We denote the two solutions of the equation

$$\frac{d^2 u}{dr^2} + \frac{1}{r} \frac{du}{dr} - u = 0$$

by $I_0(r)$, $K_0(r)$ when

$$I_0(r) = J_0(ir) = 1 + \frac{r^2}{2^2} + \frac{r^4}{2^2 \cdot 4^2} + \dots \\ = \frac{1}{\pi} \int_0^\pi \cosh(r \cos \phi) d\phi,$$

and

$$K_0(r) = Y_0(ir) + \frac{1}{2}i\pi J_0(ir) = \int_0^\infty e^{-r} \cos h\phi d\phi = \int_0^\infty \cos(r \sinh \psi) d\psi.$$

The particular integral $K_0(r)$ is so chosen that it vanishes when r is real and infinite; it is also represented by

$$\int_0^\infty \frac{\cos v}{\sqrt{(v^2+r^2)}} dv,$$

and by

$$\int_1^\infty \frac{e^{-ru}}{\sqrt{(u^2-1)}} du.$$

The solutions of the equation

$$\frac{du^2}{dr^2} + \frac{1}{r} \frac{du}{dr} - \left(1 + \frac{m^2}{r^2} \right) u = 0$$

are denoted by $I_m(r)$, $K_m(r)$, where

$$I_m(r) = \frac{r^m}{2^m \Pi(m)} \left\{ 1 + \frac{\rho^2}{2 \cdot 2m+2} + \frac{\rho^4}{2 \cdot 4 \cdot 2m+2 \cdot 2m+4} + \dots \right\} \\ = (2r)^m \frac{d^m}{d(r^2)^m} I_0(r),$$

when m is an integer, and

$$K_m(r) = (2r)^m \frac{d^m}{d(r^2)^m} K_0(r) = e^{-\frac{1}{2}m\pi i} \left\{ Y_m(ir) + \frac{1}{2}i\pi J_m(ir) \right\}.$$

We find also

$$I_m(r) = \frac{r^m}{1 \cdot 3 \cdot 5 \dots (2m-1)} \frac{1}{\pi} \int_0^\pi \cosh(r \cos \phi) \sin^{2m} \phi d\phi$$

$$K_m(r) = \frac{(-1)^m r^m}{1 \cdot 3 \cdot 5 \dots (2m-1)} \int_0^\infty e^{-r \cosh \phi} \sinh 2^m \phi d\phi$$

$$= (-1)^m 3 \cdot 5 \dots 2m-1 r^m \int_0^\infty \frac{\cos u}{(u^2+r^2)^{m+\frac{1}{2}}} du.$$

26. *The Asymptotic Series for Bessel's Functions.*—It may be shown, by means of definite integral expressions for the Bessel's functions, that

$$J_m(\rho) = \sqrt{\frac{2}{\pi\rho}} \left\{ P \cos \left(\frac{m\pi}{2} + \frac{\pi}{4} - \rho \right) + Q \sin \left(\frac{m\pi}{2} + \frac{\pi}{4} - \rho \right) \right\}$$

$$Y_m(\rho) = \sqrt{\frac{2}{\pi\rho}} e^{m\pi i} \sec m\pi \left\{ P \sin \left(\frac{m\pi}{2} + \frac{\pi}{4} - \rho \right) - Q \cos \left(\frac{m\pi}{2} + \frac{\pi}{4} - \rho \right) \right\}$$

where P and Q denote the series

$$P = 1 - \frac{(4m^2-1^2)(4m^2-3^2)}{1 \cdot 2 \cdot (8\rho)^2} \\ + \frac{(4m^2-1^2)(4m^2-3^2)(4m^2-5^2)(4m^2-7^2)}{1 \cdot 2 \cdot 3 \cdot 4 \cdot (8\rho)^4} - \dots$$

$$Q = \frac{4m^2}{1 \cdot 8\rho} - \frac{(4m^2-1^2)(4m^2-3^2)(4m^2-5^2)}{1 \cdot 2 \cdot 3 \cdot (8\rho)^3} + \dots$$

These series for P , Q are divergent unless m is half an odd integer, but it can be shown that they may be used for calculating the values of the functions, as they have the property that if in the calculation we stop at any term, the error in the value of the function is less than the next term; thus in using the series for calculation, we must stop at a term which is small. In such series the remainder after n terms has a minimum for some value of n , and for greater values of n increases beyond all limits; such series are called semi-convergent or asymptotic.

We have as particular cases of such series:—

$$J_0(\rho) = \sqrt{\frac{2}{\pi\rho}} \cos \left(\frac{\pi}{4} - \rho \right) \left\{ 1 - \frac{1^2 \cdot 3^2}{1 \cdot 2 \cdot (8\rho)^2} + \frac{1^2 \cdot 3^2 \cdot 5^2 \cdot 7^2}{1 \cdot 2 \cdot 3 \cdot 4 \cdot (8\rho)^4} - \dots \right\}$$

$$- \sqrt{\frac{2}{\pi\rho}} \sin \left(\frac{\pi}{4} - \rho \right) \left\{ \frac{1^2}{1 \cdot 8\rho} - \frac{1^2 \cdot 3^2 \cdot 5^2}{1 \cdot 2 \cdot 3 \cdot (8\rho)^3} + \dots \right\}$$

when m is an integer,

$$K_m(r) = (-1)^m \sqrt{\frac{\pi}{2r}} e^{-r} \left\{ 1 + \frac{4m^2-1^2}{1 \cdot 8r} + \frac{(4m^2-1^2)(4m^2-3^2)}{1 \cdot 2 \cdot (8r)^2} + \dots \right\}$$

$$I_m(r) = \frac{1}{\sqrt{2\pi r}} e^r \left\{ 1 - \frac{4m^2-1^2}{1 \cdot 8r} + \frac{(4m^2-1^2)(4m^2-3^2)}{1 \cdot 2 \cdot (8r)^2} - \dots \right\}$$

27. *The Bessel's functions of degree half an odd integer* are of special

importance in connexion with the differential equations of physics. The two equations

$$\frac{\partial u}{\partial t} = k \nabla^2 u, \quad \frac{\partial^2 u}{\partial t^2} = k^2 \nabla^2 u,$$

are reducible by means of the substitutions $u = e^{-kt}v$, $u = e^{kt}v$ to the form $\nabla^2 v + v = 0$. If we suppose v to be a function of r only, this last differential equation takes the form

$$\frac{d^2(vr)}{dr^2} + vr = 0,$$

so that v has the values

$$\sin r/r, \cos r/r;$$

in order to obtain more general solutions of the equation $\nabla^2 v + v = 0$, we may operate on

$$\sin r/r, \cos r/r$$

with the operator

$$Y_n \left(\frac{\partial}{\partial x}, \frac{\partial}{\partial y}, \frac{\partial}{\partial z} \right),$$

where $Y_n(x, y, z)$ is any spherical solid harmonic of degree n . The result of the operation may be at once obtained by taking $Y_n(x, y, z)$ for $f_n(x, y, z)$ in the theorem (7'), we thus find as solutions, of $\nabla^2 v + v = 0$, the expressions

$$Y_n(x, y, z) \frac{d^n}{d(r^2)^n} \frac{\sin r}{r}, \quad Y_n(x, y, z) \frac{d^n}{d(r^2)^n} \frac{\cos r}{r}$$

By recurring to the definition of the function $J_m(r)$, we see that

$$J_{\frac{1}{2}}(r) = \sqrt{\frac{2r}{\pi}} \left\{ 1 - \frac{r^2}{2 \cdot 3} + \frac{r^4}{2 \cdot 3 \cdot 4 \cdot 5} - \dots \right\} = \sqrt{\frac{2}{\pi}} \frac{\sin r}{\sqrt{r}};$$

thus

$$r^{-\frac{1}{2}} J_{\frac{1}{2}}(r) = \sqrt{\frac{2}{\pi}} \frac{\sin r}{r}.$$

Using the relation between Bessel's functions whose orders differ by an integer, we have

$$J_{n+\frac{1}{2}}(r) = (-2)^n r^{n+\frac{1}{2}} \frac{d^n}{d(r^2)^n} \frac{J_{\frac{1}{2}}(r)}{\sqrt{r}} = (-2)^n \sqrt{\frac{2}{\pi}} r^{n+\frac{1}{2}} \frac{d^n}{d(r^2)^n} \frac{\sin r}{r}$$

It may be shown at once that

$$r^{n+\frac{1}{2}} \frac{d^n}{d(r^2)^n} \frac{\cos r}{r}$$

is a second solution of Bessel's equation of order $n + \frac{1}{2}$; thus the differential equation $\nabla^2 v + v = 0$ is satisfied by the expression

$$Y_n(x, y, z) \frac{J_{n+\frac{1}{2}}(r)}{r^{n+\frac{1}{2}}},$$

and by the corresponding expression with a second solution of Bessel's equation instead of $J_{n+\frac{1}{2}}(r)$; if $S_n(\mu, \phi)$ denotes a surface harmonic of degree n , the expression

$$S_n(\mu, \phi) \frac{1}{\sqrt{r}} J_{n+\frac{1}{2}}(r)$$

is a solution of the equation $\nabla^2 v + v = 0$.

The Bessel's functions of degree half an odd integer are the only ones which are expressible in a closed form involving no transcendental functions other than circular functions. It will be observed that in this case the semi-convergent series for J_m becomes a finite one as the expressions P, Q then break off after a finite number of terms.

28. *The Zeros of Bessel's Functions.*—The determination of the position of the zeros of the Bessel's functions, and the values of the argument at which they occur, have been investigated by Hurwitz (*Math. Ann.* vol. xxxiii.), and more completely by H. M. Macdonald (*Proc. Lond. Math. Soc.* vols. xxix., xxx.). It has been shown that the zeros of $J_n(z)/z^n$ are all real and associated with the singular point at infinity when n is real and > -1 , and that all the real zeros of $J_n(z)/z^n$ when n is real and < -1 , and not an integer, are associated with the essential singularity at infinity. When n is a negative integer $-m$, $J_n(z)/z^n$ has, in addition, $2m$ real zeros coincident at the origin. When $n = -m - v$, m being a positive integer, and $1 > v > 0$, $J_n(z)/z^n$ has a finite number $2m$ of zeros which are not associated with the essential singularity. If n is real, and starts with any positive value, the zeros nearest the origin approach it as n diminishes, two of them reaching it when $n = -1$, and two more reach it whenever n passes through a negative integral value; these zeros then become complex for values of n not integral. The zeros of $J_n(z)/z^n$ are separated by those of $J_{n+1}(z)/z^n$, one zero of the latter, and one only, lies between two consecutive zeros of $J_n(z)/z^n$. When n is real and > -1 , all the zeros of $J_n(z)/z^n$ are given by a formula due to Stokes; the m^{th} positive zero in order of magnitude is given by

$$\alpha = \frac{4n^2 - 1}{8\alpha} - \frac{4(4n^2 - 1)(28n^2 - 31)}{3 \cdot (8\alpha)^2} - \&c.,$$

where $\alpha = \frac{1}{2}\pi(2n + 4m - 1)$. It has been shown by Macdonald

that the function $K_n(z)$ has no real zeros unless $n = 2k + \frac{1}{2}$ where k is an integer, when it has one real negative zero; and that $K_n(z)$ has no purely imaginary zeros, and no zero whose real part is positive, other than those at infinity. When $1 > n > 0$, $K_n(z)$ has no zeros other than those at infinity, when $2 > n > 1$, it has one zero whose real part is negative, and when $m + 1 > n > m$ where m is an integer, there are m zeros whose real parts are negative. When n is an integer, $K_n(z)$ has n zeros with negative real parts.

29. *Spheroidal Harmonics.*—For potential problems in which the boundary is an ellipsoid of revolution, the co-ordinates to be used are r, θ, ϕ where in the case of a prolate spheroid

$$x = c\sqrt{r^2 - 1} \sin \theta \cos \phi, \quad y = c\sqrt{r^2 - 1} \sin \theta \sin \phi, \quad z = cr \cos \theta,$$

the surfaces $r = r_0, \theta = \theta_0, \phi = \phi_0$ are confocal prolate spheroids, confocal hyperboloids of revolution, and planes passing through the axis of revolution. We may suppose r to range from 1 to ∞ , θ from 0 to π , and ϕ from 0 to 2π , every point in space has then unique co-ordinates r, θ, ϕ .

For oblate spheroids, the corresponding co-ordinates are r, θ, ϕ given by

$$x = c\sqrt{r^2 + 1} \sin \theta \cos \phi, \quad y = c\sqrt{r^2 + 1} \sin \theta \sin \phi, \quad z = cr \cos \theta,$$

where

$$0 \leq r \leq \infty, \quad 0 \leq \theta \leq \pi, \quad 0 \leq \phi \leq 2\pi;$$

these may be obtained from those for the prolate spheroid by changing c into $-c$, and r into ir .

Taking the case of the prolate spheroid, Laplace's equation becomes

$$\frac{\partial}{\partial r} \left\{ (r^2 - 1) \frac{\partial V}{\partial r} \right\} + \frac{1}{\sin \theta} \frac{\partial}{\partial \theta} \left(\sin \theta \frac{\partial V}{\partial \theta} \right) + \frac{r^2 - \cos^2 \theta}{(r^2 - 1) \sin^2 \theta} \frac{\partial^2 V}{\partial \phi^2} = 0,$$

and it will be found that the normal solutions are

$$\begin{matrix} P_n^m(r) \left\{ P_n^m(\cos \theta) \right\} \cos m\phi. \\ Q_n^m(r) \left\{ Q_n^m(\cos \theta) \right\} \sin m\phi. \end{matrix}$$

For the space inside a bounding spheroid the appropriate normal

forms are $P_n^m(r) P_n^m(\cos \theta) \cos m\phi$, where n, m are positive integers,

and for the external space

$$Q_n^m(r) P_n^m(\cos \theta) \cos m\phi.$$

For the case of an oblate spheroid, $P_n^m(ir), Q_n^m(ir)$, take the place of $P_n^m(r), Q_n^m(r)$.

30. *Toroidal Functions.*—For potential problems connected with the anchor-ring, the following co-ordinates are appropriate: If A, B are points at the extremities of a diameter of a fixed circle, and P is any point in the plane PAB which is perpendicular to the plane of the fixed circle, let $P = \log(AP/BP)$, $\theta = \angle APB$, and let ϕ be the angle the plane APB makes with a fixed plane through the axis of the circle. Let θ be restricted to lie between $-\pi$ and π , a discontinuity in its value arising as we pass through the circle, so that within the circumference θ is π on the upper side of the circle, and $-\pi$ on the lower side; θ is zero in the plane of the circle outside the circumference; ρ may have any value between $-\infty$ and ∞ , and ϕ any value between 0 and 2π . The position of a point is then uniquely represented by the co-ordinates ρ, θ, ϕ , which are the parameters of a system of tori with the fixed circle as limiting circle, a system of bowls with the fixed circle as common rim, and a system of planes through the axis of the tori. If x, y, z are the co-ordinates of a point referred to axes, two of which x, y are in the plane of the circle and the third along its axis, we find that

$$\left\{ x = \frac{a \sinh \rho}{\cosh \rho - \cos \theta} \cos \phi, \quad y = \frac{a \sinh \rho}{\cosh \rho - \cos \theta} \sin \phi, \quad z = \frac{a \sin \theta}{\cosh \rho - \cos \theta} \right\}$$

where a is the radius of the fixed circle.

Laplace's equation reduces to

$$\frac{\partial}{\partial \rho} \left\{ \frac{\sinh \rho}{P^2} \frac{\partial V}{\partial \rho} \right\} + \frac{\partial}{\partial \theta} \left\{ \frac{\sinh \rho}{P^2} \frac{\partial V}{\partial \theta} \right\} + \frac{1}{P^2 \sinh \rho} \frac{\partial^2 V}{\partial \phi^2} = 0,$$

when P denotes $\sqrt{(\cosh \rho - \cos \theta)}$. It can be shown that this equation is satisfied by

$$\sqrt{(\cosh \rho - \cos \theta)} \frac{P_{n-\frac{1}{2}}^m(\cosh \rho) \cos m\phi}{Q_{n-\frac{1}{2}}^m(\cosh \rho) \sin n\theta} \sin n\theta \cos m\phi,$$

the functions $P_{n-\frac{1}{2}}^m(\cosh \rho), Q_{n-\frac{1}{2}}^m(\cosh \rho)$ required for the potential problems, are associated Legendre's functions of degree $n - \frac{1}{2}$, half an odd integer, of integral order m , and of argument real and greater than unity; these are known as toroidal functions. For the space external to a boundary tori the function $Q_{n-\frac{1}{2}}^m(\cosh \rho)$ must be used, and for the internal space $P_{n-\frac{1}{2}}^m(\cosh \rho)$.

The following expressions may be given for the toroidal functions:—

$$P_{n-\frac{1}{2}}^m(\cosh \rho) = \frac{(-1)^m}{\pi} \frac{\Pi(n-\frac{1}{2})}{\Pi(n-m-\frac{1}{2})} \int_0^\pi \frac{\cos m\phi}{(\cosh \rho + \sinh \rho \cos \phi)^{n+\frac{1}{2}}} d\phi$$

$$= \frac{1}{\pi} \frac{\Pi(n+m-\frac{1}{2})}{\Pi(n-\frac{1}{2})} \int_0^\pi (\cosh \rho + \sinh \rho \cos \phi)^{n-\frac{1}{2}} \cos m\phi d\phi.$$

$$P_{n-\frac{1}{2}}(\cosh \rho) = \frac{2}{\pi} \int_0^\rho \frac{\cosh n\phi}{\sqrt{2 \cosh \rho - 2 \cosh \phi}} d\phi.$$

$$Q_{n-\frac{1}{2}}(\cosh \rho) = (-1)^m \frac{\Pi(n+m-\frac{1}{2})}{\Pi(n-\frac{1}{2})} \int_0^{\log \coth \frac{1}{2}\rho} (\cosh \rho - \sinh \rho \cosh w)^{n-\frac{1}{2}} \cosh mw dw$$

$$= (-1)^m \frac{1}{\pi} 2^m \Pi(m-\frac{1}{2}) \Pi(-\frac{1}{2}) \sinh^m \rho \int_0^\pi \frac{\cos n\phi}{(2 \cosh \rho - 2 \cos \phi)^{m+\frac{1}{2}}} d\phi.$$

The relations between functions for three consecutive values of the degree or the order are

$$2n \cosh \rho P_{n-\frac{1}{2}}^m(\cosh \rho) - (n-m+\frac{1}{2}) P_{n+\frac{1}{2}}^m(\cosh \rho) - (n+m-\frac{1}{2}) P_{n-\frac{1}{2}}^m(\cosh \rho) = 0.$$

$$P_{n-\frac{1}{2}}^{m+2}(\cosh \rho) + 2(m+1) \coth \rho P_{n-\frac{1}{2}}^{m+1}(\cosh \rho) - (n-m-\frac{1}{2})(n+m+\frac{1}{2}) P_{n-\frac{1}{2}}^m(\cosh \rho) = 0,$$

with relations identical in form for the functions $Q_{n-\frac{1}{2}}^m(\cosh \rho)$.

The function $Q_{n-\frac{1}{2}}(\cosh \rho)$ is expansible in the form

$$\frac{\Pi(n-\frac{1}{2}) \Pi(-\frac{1}{2})}{\Pi(n)} e^{-(n+\frac{1}{2})\rho} F(\frac{1}{2}, n+\frac{1}{2}, n+1, e^{-2\rho}),$$

which is useful for calculation of the function when ρ is not small. $P_{n-\frac{1}{2}}(\cosh \rho)$ can also be expressed in terms of $e^{-\rho}$ by a somewhat complicated formula.

31. *Ellipsoidal Harmonics.*—In order to treat potential problems in which the boundary surface is an ellipsoid, Lamé took as co-ordinates the parameters ρ, μ, ν of systems of confocal ellipsoids, hyperboloids of one sheet, and of two sheets; these co-ordinates are three roots of the equation

$$\frac{x^2}{\rho^2} + \frac{y^2}{\rho^2 - h^2} + \frac{z^2}{\rho^2 - k^2} = 1, \quad (k > h);$$

we thence find that

$$x = \frac{\rho \mu \nu}{h k}, \quad y = \frac{\sqrt{\rho^2 - h^2} \sqrt{\mu^2 - h^2} \sqrt{k^2 - \nu^2}}{h \sqrt{k^2 - h^2}}, \quad z = \frac{\sqrt{\rho^2 - k^2} \sqrt{k^2 - \mu^2} \sqrt{k^2 - \nu^2}}{k \sqrt{k^2 - h^2}}$$

where $\infty \geq \rho^2 \geq h^2, k^2 \leq \mu^2 \leq h^2,$ and $k^2 \geq \nu^2 \geq 0.$

We find from these values of x, y, z

$$(dx)^2 + (dy)^2 + (dz)^2 = \frac{(\rho^2 - \mu^2)(\rho^2 - \nu^2)}{(\rho^2 - h^2)(\rho^2 - k^2)} (d\rho)^2 + \frac{(\rho^2 - \mu^2)(\mu^2 - \nu^2)}{(\mu^2 - h^2)(k^2 - \mu^2)} (d\mu)^2 + \frac{(\rho^2 - \nu^2)(\mu^2 - \nu^2)}{(h^2 - \nu^2)(k^2 - \nu^2)} (d\nu)^2,$$

and on applying the general transformation of Laplace's equation that equation becomes

$$(\mu^2 - \nu^2) \frac{\partial^2 V}{\partial \xi^2} + (\rho^2 - \nu^2) \frac{\partial^2 V}{\partial \eta^2} + (\rho^2 - \mu^2) \frac{\partial^2 V}{\partial \zeta^2} = 0,$$

where ξ, η, ζ are defined by the formulae

$$\xi = \int_0^\rho \frac{d\rho}{h \sqrt{\rho^2 - h^2} \sqrt{\rho^2 - k^2}}, \quad \eta = \int_h^\mu \frac{d\mu}{\sqrt{\mu^2 - h^2} \sqrt{k^2 - \mu^2}},$$

$$\zeta = \int_0^\nu \frac{d\nu}{\sqrt{h^2 - \nu^2} \sqrt{k^2 - \nu^2}},$$

which are equivalent to

$$\rho = kdn(k\xi, k_1), \quad \mu = kdn(K - k\eta, k_1), \quad \nu = ksn(k\xi, k_1'),$$

where k_1, k_1' denote the quantities $1 - h^2/k^2, h^2/k^2$ and K denotes the complete elliptic integral

$$\int_0^{\frac{1}{2}\pi} \frac{d\psi}{\sqrt{1 - k^2 \sin^2 \psi}}$$

It can now be shown that Laplace's equation is satisfied by the product $E(\rho)E(\mu)E(\nu)$, where $E(\rho)$ satisfies the differential equation

$$\frac{d^2 E(\rho)}{d\rho^2} - [n(n+1)\rho^2 - (h^2 + k^2)\rho] E(\rho) = 0;$$

and $E(\mu), E(\nu)$ satisfy the equations

$$\frac{d^2 E(\mu)}{d\mu^2} + [n(n+1)\mu^2 - \rho(h^2 + k^2)] E(\mu) = 0,$$

$$\frac{d^2 E(\nu)}{d\nu^2} - [n(n+1)\nu^2 - \rho(h^2 + k^2)] E(\nu) = 0,$$

where n and ρ are arbitrary constants. On substituting the values

of the parameters ξ, η, ζ in terms of ρ, μ, ν , we find that the equation satisfied by $E(\rho)$ becomes

$$(\rho^2 - h^2)(\rho^2 - k^2) \frac{d^2 E(\rho)}{d\rho^2} + \rho(2\rho^2 - h^2 - k^2) \frac{dE(\rho)}{d\rho} + \{(\rho^2 + k^2)\rho - n(n+1)\rho^2\} E(\rho) = 0,$$

and $E(\mu), E(\nu)$ satisfy equations in μ, ν respectively of identically the same form; this equation is known as Lamé's equation.

If n be taken to be a positive integer, it can be shown that it is possible in $2n+1$ ways so to determine ρ that the equation in $E(\rho)$ is satisfied by an algebraical function of degree n , rational in $\rho, \sqrt{(\rho^2 - h^2)}, \sqrt{(\rho^2 - k^2)}$. The functions so determined are called Lamé's functions, and the $2n+1$ functions of degree n are of one of the four forms.

$$K(\rho) = a_0 \rho^n + a_1 \rho^{n-2} + \dots,$$

$$L(\rho) = \sqrt{\rho^2 - h^2} (a_0' \rho^{n-1} + a_1' \rho^{n-3} + \dots),$$

$$M(\rho) = \sqrt{\rho^2 - k^2} (a_0'' \rho^{n-1} + a_1'' \rho^{n-3} + \dots),$$

$$N(\rho) = \sqrt{\rho^2 - k^2} \sqrt{\rho^2 - h^2} (a_0''' \rho^{n-2} + a_1''' \rho^{n-4} + \dots).$$

These are the four classes of Lamé's functions of degree n ; of the functions K there are $1 + \frac{1}{2}n$, or $\frac{1}{2}(n+1)$, according as n is even or odd; of each of the functions L, M , there are $\frac{1}{2}n$, or $\frac{1}{2}(n-1)$, and of the functions N , there are $\frac{1}{2}n$, or $\frac{1}{2}(n+1)$.

The normal forms of solution of Laplace's equation, applicable to the space inside the ellipsoid, are the $2n+1$ products $E(\rho)E(\mu)E(\nu)$. It can be shown that the $2n+1$ values of ρ are real and unequal.

It can be shown that, subject to certain restrictions, a function of μ and ν , arbitrarily given over the surface of the ellipsoid $\rho = \rho_1$, can be expressed as the sum of products of Lamé's functions of μ and ν , in the form

$$\sum_{\nu} \sum_{\mu} c_n^{2n+1} E_n^*(\mu) E_n^*(\nu);$$

the potential function for the space inside the ellipsoid, which has the arbitrarily given value over the surface of the ellipsoid, is consequently

$$\sum \sum c_n \frac{E_n^*(\rho) E_n^*(\mu) E_n^*(\nu)}{E_n^*(\rho_1)}$$

It can be shown that a second solution of Lamé's equation is $F_n(\rho)$ where

$$F_n(\rho) = (2n+1) E_n(\rho) \int_\rho^\infty \frac{d\rho}{\{E_n(\rho)\}^2 \sqrt{\rho^2 - h^2} \sqrt{\rho^2 - k^2}};$$

this function $F_n(\rho)$ vanishes at infinity as ρ^{-n-1} , and is therefore adapted to the space outside the bounding ellipsoid. The external potential which has at the surface $\rho = \rho_1$, the value

$$\sum \sum c_n^* E_n^*(\mu) E_n^*(\nu) \text{ is } \sum \sum c_n^* \frac{F_n^*(\rho)}{F_n^*(\rho_1)} E_n^*(\mu) E_n^*(\nu).$$

32. *History and Literature.*—The first investigator in the subject was Legendre, who introduced the functions known by his name, and at present also called zonal surface harmonics; he applied them to the determination of the attractions of solids of revolution. Legendre's investigations are contained in a memoir of the Paris Academy, *Sur l'attraction des sphéroïdes*, published in 1785, and in a memoir published by the Academy in 1787, *Recherches sur la figure des planètes*; his investigations are collected in his *Exercices*, and in his *Traité des fonctions elliptiques*. The potential function was introduced by Laplace, who also first obtained the equation which bears his name; he applied spherical surface harmonics to the determination of the potential of a nearly spherical solid, in his memoir, *Théorie des attractions des sphéroïdes et de la figure des planètes*, published by the Paris Academy in 1785. Laplace was the first to consider the functions of two angles, which functions have consequently been known as Laplace's functions; his investigations on these functions are given in the *Mécanique céleste*, tome ii. livre iii., tome v. livre xi., and in the supplement to vol. v. The notation $P_n^{(m)}$ was introduced by Dirichlet (see Crelle's *Journal*, vol. xvii., "sur les séries dont le terme général dépend de deux angles" &c.; see also his memoir, "Ueber einen neuen Ausdruck zur Bestimmung der Dichtigkeit einer unendlich dünnen Kugelschale," in the *Abhandlungen* of the Berlin Academy, 1850). The name "Kugelfunctionen" was introduced by Gauss (see *Collected Works*, vi. 648). A direct investigation of the expression for the reciprocal of the distance between two points in spherical surface harmonics was given by Jacobi (Crelle's *Journal*, vol. xxvi., see also vol. xxxii.). The functions of the second kind were first introduced by Heine (see his "Theorie der Anziehung eines Ellipsoides," Crelle's *Journal*, vol. xlii., 1851). The above-mentioned investigators employed almost entirely polar co-ordinates; the use of Cartesian co-ordinates for the expression of spherical harmonics was introduced by Kelvin in his theory of the equilibrium of an elastic spherical shell (see

Phil. Trans. Roy. Soc., 1862), and also independently by Clebsch (see his paper, "Ueber die Reflexion an einer Kugelfläche," *Crelle's Journal*, vol. lxi., 1863). The general theory of spherical harmonics of unrestricted degree, order and argument has been treated by Hobson (*Phil. Trans.*, 1896); see also a paper by Barnes in the *Quar. Journ. Math.* 39, p. 97. The functions which bear the name of Bessel were first introduced by Fourier in his investigations on the conduction of heat (see his *Théorie analytique de la chaleur*, 1822); they were employed by Bessel in the theory of planetary motion (see the *Abhandlungen* of the Berlin Academy, 1824). The functions which are now known as Bessel's functions of degree half an odd integer were employed by Poisson in the theory of the conduction of heat in a solid spherical body (see the *Journ. de l'école polyt.*, 1823, cah. 19). The toroidal functions were introduced by C. Neumann (*Theorie der Elektrizitäts- und Wärmevertheilung in einem Ringe*, Halle, 1864), and independently by Hicks (*Phil. Trans. Roy. Soc.*, 1881). The ellipsoidal harmonics were first investigated by Lamé in connection with the stationary motion of heat in an ellipsoidal body (see Liouville's *Journal*, 1839, pt. iv. The external ellipsoidal harmonics were introduced by Liouville and Heine (see Liouville's *Journal*, vol. x., and Crelle's *Journal*, vol. xxix.). The ellipsoidal harmonics have been considered as expressed in Cartesian co-ordinates by Green (see *Collected Works*), by Ferrers (see his treatise), and by W. D. Niven (*Phil. Trans. Roy. Soc.*, 1892). A method of representing ellipsoidal harmonics in a form adapted for actual use in certain physical problems has been developed by G. H. Darwin (*Phil. Trans.*, vol. 197).

The following treatises may be consulted: Heine, *Theorie der Kugelfunctionen* (2nd ed., 1878, vol. i.; 1881, vol. ii.); this treatise gives much information as to the history and literature of the subject; Ferrers, *Spherical Harmonics* (Cambridge, 1881); Todhunter, *The Functions of Laplace, Lamé and Bessel* (Cambridge, 1875); Thomson and Tait, *Natural Philosophy* (1879), App. B: Haentzschel, *Reduction der Potentialgleichung auf gewöhnliche Differentialgleichungen* (Berlin, 1893); F. Neumann, *Beiträge zur Theorie der Kugelfunctionen* (Leipzig, 1878); C. Neumann, *Theorie der Besselschen Functionen* (Leipzig, 1867); *Ueber die nach Kreis-, Kugel- und Cylinder-functionen fortschreitenden Entwicklungen* (Leipzig, 1881); Lommel, *Studien über die Besselschen Functionen* (Leipzig, 1868); Mathieu, *Cours de physique mathématique* (Paris, 1873); Pockels, *Ueber die partielle Differentialgleichung $\Delta u + k^2 u = 0$* (Berlin, 1891); Bôcher, *Ueber die Reihenentwickelungen der Potentialtheorie* (Leipzig, 1894); Gray and Mathews, *Treatise on Bessel's Functions*; Dini, *Serie di Fourier e altre rappresentazione . . .* (Pisa, 1880); Graf and Gubler, *Einleitung in die Theorie der Besselschen Functionen* (Berne, 1898); Nielsen, *Handbuch der Theorie der Cylinderfunctionen* (Leipzig, 1904); Whittaker, *A Course of Modern Analysis* (Cambridge, 1902); H. Weber, *Die partiellen Differentialgleichungen der Physik* (Bremen, 1900); W. E. Byerly, *Fourier's Series and Spherical, Cylindrical and Ellipsoidal Harmonics* (Boston, 1893). (E. W. H.)

SPHEROID (Gr. σφαῖρα-ειδής, like a sphere), a solid resembling, but not identical with, a sphere in shape. In geometry, the word is confined to the figures generated by an ellipse revolving about a diameter. If the axis of revolution be the major axis of the ellipse, the spheroid is "prolate"; if the minor axis, "oblate"; if any other, "universal."

If the generating ellipse has for its equation $x^2/a^2 + y^2/b^2 = 1$, and revolves about the major axis, i.e. the axis of x , the volume of the solid generated is $\frac{4}{3}\pi ab^2$, and its surface is $2\pi\{b^2 + (ab/e) \sin^{-1}e\}$, where e denotes the eccentricity. If the curve revolve about the minor axis, the volume is $\frac{4}{3}\pi a^2 b$, and the surface is $\pi\{2a^2 + (b^2/e) \log(1+e)/(1-e)\}$. The figure of the earth is frequently referred to as an oblate spheroid; this, however, is hardly correct, for the geoid has three unequal axes. The Cartesian equation to a spheroid assumes the forms $x^2/a^2 + (y^2+z^2)/b^2 = 1$, for the prolate, and $(x^2+z^2)/a^2 + y^2/b^2 = 1$, for the oblate, the origin being the centre and the co-ordinate axes the axes of the original ellipse, $x^2/a^2 + y^2/b^2 = 1$, and the line perpendicular to the plane containing them.

In physics, the term "spheroidal state" is given to the following phenomenon. If drops of a liquid be placed on a highly heated surface, for example, the top of a stove, the liquid forms a number of tremulous globules which continually circulate internally. There is no visible boiling, although the globule diminishes slowly in size. The theory of the experiment is that the liquid is surrounded by an elastic envelope of its vapour which acts, as it were, as a cushion preventing actual contact of the drop with the plate. On the formation of a similar protective cushion of vapour depends the immunity of such experiments as plunging a hand into a bath of molten metal.

SPHEROMETER (Gr. σφαῖρα, a sphere, μέτρον, a measure), an instrument for the precise measurement of the radius of a sphere or the thickness of a thin plate. The usual form consists of a fine screw moving in a nut carried on the centre of a small three-legged table; the feet forming the vertices of an equilateral triangle (see figure).

The lower end of the screw and those of the table legs are finely tapered and terminate in hemispheres, so that each rests on a point.

If the screw has two turns of the thread to the millimetre the head is usually divided into 500 equal parts, so that differences of 0.001 millimetre may be measured without using a vernier. A lens, however, may be fitted, in order to magnify the scale divisions. A vertical scale fastened to the table indicates the number of whole turns of the screw and serves as an index for reading the divisions on the head. In order to measure the thickness of a plate the instrument is placed on a perfectly level plane surface and the screw turned until the point just touches; the exact instant when it does so is defined by a sudden diminution of resistance succeeded by a considerable increase. The divided head and scale are read; the screw is raised; the thin plate slipped under it; and the process is repeated. The difference between the two readings gives the required thickness. A contact-lever, delicate level or electric contact arrangement may be attached to the spherometer in order to indicate the moment of touching more precisely than is possible by the sense of touch. To measure the radius of a sphere—e.g. the curvature of a lens—the spherometer is levelled and read, then placed on the sphere, adjusted until the four points exert equal pressure, and read again. The difference gives the thickness of that portion of the sphere cut off by a plane passing through the three feet. Calling this distance h , and the distance between the feet a , the radius R is given by the formula $R = (a^2 + 3h^2)/6h$.

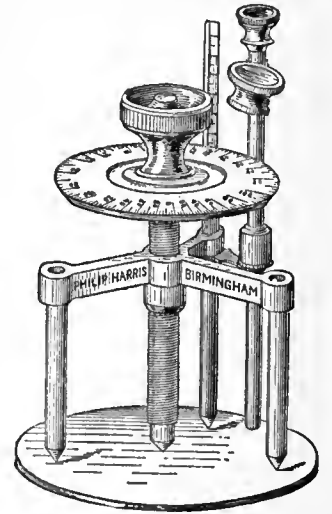

SPHERULITES (Gr. σφαῖρα, sphere, λίθος, stone), in petrology small rounded bodies which commonly occur in vitreous igneous rocks. They are often visible in specimens of obsidian, pitchstone and rhyolite as globules about the size of millet seed or rice grain, with a duller lustre than the surrounding glassy base of the rock, and when they are examined with a lens they prove to have a radiate fibrous structure. Under the microscope the spherulites are of circular outline and are composed of thin divergent fibres, which are crystalline and react on polarized light. Between crossed nicols a black cross appears in the spherulite; its axes are usually perpendicular to one another and parallel to the crossed wires; as the stage is rotated the cross remains steady; between the black arms there are four bright sectors. This shows that the spherulite consists of radiate, doubly refracting fibres which have a straight extinction; the arms of the black cross correspond to those fibres which are extinguished. The aggregate is too fine grained for us to determine directly of what minerals it is composed.

Spherulites are commonest in acid glassy rocks like those above mentioned, but they occur also in basic glasses such as tachylyte. Sometimes they compose the whole mass; more usually they are surrounded by a glassy or felsitic base. When obsidians are devitrified the spherulites are often traceable, though they may be more or less completely recrystallized or silicified. In the centre of a spherulite there may be a crystal (e.g. quartz or feldspar) or sometimes a cavity. Occasionally spherulites have zones of different colours, and while most frequently spherical they may be polygonal, or irregular in outline. In some New Zealand rhyolites the spherulites send branching "cervicorn" processes (like stags' horns) outwards through the surrounding glass of the rock. The name axiolites is given to long, elliptical or band-like spherulites.

Occasionally spherulites are met with which are half an inch or more in diameter. If the rock be pounded up fragments of these can be picked out by hand and subjected to analysis, and it is found that from their composition they may be regarded as a mixture of quartz and acid feldspar. Direct microscopic evidence as to the presence of these minerals is rarely obtainable. Some authors describe spherulites as consisting of felsite or microfelsite, which also is supposed to be a cryptocrystalline quartzofeldspathic substance.

Very large and cavernous spherulites have been called *lithophysae*; they are found in obsidians at Lipari, the Yellowstone Park, &c. The characteristic radiate fibrous structure is usually conspicuous, but the fibres are interrupted by cavities which are often arranged as to give the spherulite a resemblance to a rosebud with folded petals separated by arching interspaces. Some of these lithophysae are an inch or more in diameter. In the crystallization of a glass there must be contraction, and it is supposed that thus the concentric cavities arise. The steam and other vapours in the magma would fill these empty spaces and exert a powerful mineralizing action on the warm rock. The presence of garnet, tridymite, fayalite and other minerals, very abnormal in rhyolites in these cavities, in the lithophysae is accounted for in this way. The fibres of these coarse spherulites are often broad and seem to belong to alkali feldspar (sanidine or anorthoclase) embedded in tridymite and glass; by analogy it is often inferred that the extremely tenuous fibres of ordinary spherulites have the same composition.

Artificial glass which has not the right composition, or is retained for too long a time in a furnace, sometimes crystallizes, and contains spherulites which may be as large as a marble. As the glass has little similarity in chemical composition to volcanic obsidians these spherulites when analysed throw little light on the mineral nature of spherulites in rocks. They show, however that in viscous semi-solid glasses near their fusion point crystallization tends to originate at certain centres and to spread outwards, producing spherulitic structures. Many salts and organic substances exhibit the same tendency, yielding beautiful spherulite crystallizations when melted and cooled rapidly on a microscopic slide.

There are many structures in rocks which are allied to spherulites and usually grouped with them, though probably they are not exactly of the same nature. Some are more vitreous, while others are more perfectly crystalline than the true spherulites. Of the former we mention the doubly refracting glassy spheroids common in rhyolites and obsidians. They differ in no respect from the surrounding hyaline base in ordinary light, but between crossed nicols appear as rounded bodies faintly lighted, with a black cross like that of the spherulites. They are portions of the glass which are in a state of compression or strain and hence no longer isotropic. In gelatin, celluloid and artificial glasses similar appearances are occasionally seen. Opal, especially the variety known as hyalite, exhibits the same phenomenon.

In the group of porphyries known as granophyres crystals of quartz and feldspar occur surrounded by a ground-mass which has a radiate fibrous or spherulitic structure. The fibres consist of quartz and feldspar, usually in graphic intergrowth over considerable areas, and often sufficiently coarse to be easily distinguishable by means of the microscope. Often the quartz or the feldspar of the spherulite extinguishes simultaneously with a crystal of either of these minerals lying in the centre of the aggregate. Exactly what the relationships of the spherulites are to those of the obsidians has never been cleared up; they are probably analogous growths but not identical. The name granospheres has been given to these bodies. Another group of radiate fibrous growths resembling spherulites in many respects consists of minute feathery crystals spreading outwards through a fine grained or glassy rock. In the variolites there are straight or feathery feldspar crystals (usually oligoclase) forming pale coloured spherulites, a quarter to half an inch in diameter. The same rocks often contain similar aggregates of plumose skeleton crystals of augite. Many volcanic rocks have small lath-shaped crystals of feldspar or augite diverging from a common centre. To distinguish these radiate crystal groups from the cryptocrystalline spherulites they have been called sphaerocrystals. They are commonest in those rocks which contain a fine ground-mass and have been rapidly consolidated. Stellate groupings are frequent also in secondary minerals, being very characteristic of natrolite, chlorite and chalcedony; often the component prisms are very narrow and regularly arranged so that in microscopic sections they give a black cross exactly like that of the spherulites. (J. S. F.)

SPHINX (Gr. σφιγγειν, to draw tight, squeeze), the Greek name for a compound creature with lion's body and human head. The Greek sphinx had wings and female bust, and the male sphinx of Egypt (wingless) is distinguished as "androsphinx" by Herodotus. The type perhaps originated in Egypt, where figures of gods with human bodies and animal heads, and compound animal forms like the gryphon were numerous from very early times. The sphinx, however, is a perfectly clear and well-defined type there, and is usually recumbent. The most

celebrated example is the Great Sphinx of Giza, 189 ft. long, a rock carved into this shape, and from its situation likely to be a work of the IVth Dynasty. The pattern of the wig-lappets has been quoted to prove that it dates from the XIIth Dynasty, but it is said that the peculiar disposition of the uraeus on its forehead agrees with that in the earliest sculptures. The face looks out due eastward from the pyramid field over the Nile valley, and, according to the inscriptions of the XVIIIth Dynasty in the shrine between the paws, it represented the sun-god Harmachis. Sphinxes of granite, &c., occur of the XIIth Dynasty and later. A pair from Tanis are attributed by Flinders Petrie to Pepi I. of the VIth Dynasty. The heads of the sphinxes are royal portraits, and apparently they are intended to represent the power of the reigning Pharaoh. The king as a sphinx, in certain religious scenes, makes offerings to deities; and elsewhere he tears his enemies in pieces. In the Saite period accordingly the figure of the sphinx was used as a hieroglyph for *neb*, "master," "lord." Recumbent sphinxes were especially used in pairs to guard the approach to a temple, and it may be conjectured that the Great Sphinx was sculptured at Giza to guard the entrance of the Nile valley. The name of the sphinx in Egyptian was Hu.

The great temple avenues at Thebes are lined with recumbent rams, true sphinxes (a few late instances), and with the so-called criosphinxes or ram-sphinxes, having lion bodies and heads of the sacred animal of Ammon. A falcon-headed sphinx was dedicated to Harmachis in the temple of Abu Simbel, and is occasionally found in sculptures representing the king as Horus, or Mont, the war-god. It is distinguishable from the gryphon only by the absence of wings.

W. M. F. Petrie, *History of Egypt from the Earliest Times to the XVIIth Dynasty*, p. 51, &c.; L. Borchardt, "Das Alter der grossen Sphinx," in *Sitzungsberichte* of the Berlin Academy (1897), p. 752. Baedeker's *Egypt*; Prisse d'Avennes, *Histoire de l'art égyptien* (Paris, 1878), vol. ii. pl. 26, 35, text, pp. 405, 410. (F. LL. G.)

From Egypt the figure of the sphinx passed to Assyria, where it appears with a bearded male head on cylinders; the female sphinx, lying down and furnished with wings, is first found in the palace of Esar-haddon (7th cent. B.C.). Sphinxes have been found in Phoenicia, one at least being winged and another bearded. They are copies of the Egyptian, both in form and posture, wearing the pschent and the uraeus, but distinguished by having the Assyrian wings. The sphinx is common on Persian gems, and the representations are finely executed. On a Persian intaglio are two sphinxes face to face, each wearing a tiara and guarding a sacred plant which is seen between them; but the sphinx, whether of the Egyptian or the Assyrian type, is not found in Persian sculptures (Perrot and Chipiez, *History of Art in Persia*, Eng. trans., London, 1892). In Asia Minor the oldest examples are the "Hittite" sphinxes of Euyuk. They are Egyptian sphinxes treated in the Assyrian style. They are not recumbent, and the hair falling from the head is curled, not straight, as in the true Egyptian sphinx. An ancient female sphinx, but wingless, stands on the sacred road near Miletus. Sphinxes of the usual Greek type are represented seated on each side of two doorways in an ancient frieze found by Sir Charles Fellows at Xanthus in Lycia, and now in the British Museum. The same type appears on the early sculptures of the half-Greek, half-Oriental temple at Assus. In the early art of Cyprus—the half-way house between Asia and Greece—sphinxes of this type are not uncommon. On the other hand, on a gem of Phoenician style found at Curium in Cyprus there appear two male (bearded) sphinxes, with the tree of life between them. With regard to Greece proper, in the third tomb on the acropolis of Mycenae were found six small golden sphinxes; they are beardless, but the sex is doubtful. The bust is not that of a woman, though the head and face are distinctly feminine. A shallow cap covers the head, and from the middle of it there is always a sort of tail or plume, blown back by the wind. It is curious that, though the sphinx (as also the gryphon) were thus common in the Mycenaean period, the words σφιγγίξ and γρύψω do not occur in Homer. Helbig suggested that the word κίων (dog), which is

connected with the sphinx in the tragedians, was used by Homer for the sphinx, but this theory has not met with general acceptance. In the ancient tomb discovered in 1877 at Spata near Athens (which represents a kindred but somewhat later art than the tombs at Mycenae) were found female winged sphinxes carved in ivory or bone. Sphinxes on glass plates have been found in graves at Camirus in Rhodes and on gold plates in Crimean graves. Sphinxes were represented on the throne of Apollo at Amyclae and on the metopes at Selinus; in the best period of Greek art a sphinx was sculptured on the helmet of the statue of Athena in the Parthenon at Athens; and sphinxes carrying off children were sculptured on the front feet of the throne of Zeus at Olympia. There is also an Athenian vase from Capua in the form of a sphinx painted white. It is winged, and the face is smooth and delicate in contour. Though Greek sphinxes are in general winged, there have been found in Boeotia terra-cotta figures of wingless sphinxes. Roman sphinxes of a late period have sometimes a man's, sometimes a woman's head with an asp on the forehead. An indefinable man-lion (*nara sinha*) represents the fourth *avatar* of the Indian Vishnu, and is found also among the Tibetans.

In Greek mythology the most famous sphinx was that of Thebes in Boeotia, first mentioned by Hesiod (*Theog.* 326), who calls her the daughter of Orthus and Chimaera. According to Apollonius (iii. 5, 8), she was the daughter of Typhon and Echidna, and had the face of a woman, the feet and tail of a lion and the wings of a bird. She dwelt at the south-east corner of Lake Copais on a bald rocky mountain called Phicium (mod. Fagas), which was derived from Φίξ, the Aeolic form of σφίγξ. The Muses taught her a riddle and the Thebans had to guess it. Whenever they failed she carried one of them off and devoured him. The riddle was this: "What is that which is four-footed, three-footed, and two-footed?" At last Oedipus guessed correctly that it was man; for the child crawls on hands and feet, the adult walks upright, and the old man supports his steps with a stick. Then the sphinx threw herself down from the mountain.

The story of the sphinx's riddle first occurs in the Greek tragedians. Milchhöfer believes that the story was a mere invention of Greek fancy, an attempt to interpret the mysterious figure which Greek art had borrowed from the East. On the other hand, he holds that the destroying nature of the sphinx was much older, and he refers to instances in both Egyptian and Greek art where a sphinx is seen seizing and standing upon a man. And, whereas the Theban legend is but sparingly illustrated in Greek art, the figure of the sphinx appears more commonly on tombs, sculptured either in the round or in relief. From this Milchhöfer seems to infer that the sphinx was a symbol of death.

Among the remains of the Mayan culture in Yucatan are found examples of sphinxes, male and female, which are not unlike those of Egypt and Asia Minor.

Milchhöfer, in *Mitth. d. deutsch. archäol. Instit. in Athen* (1879), p. 46 seq.; J. Ilberg, *Die Sphinx in der griechischen Sage und Kunst* (1895); Sir R. C. Jebb's edition of Sophocles, *Oed. Tyrann.*, app., note 12. (J. M. M.)

SPIDER-MONKEY, the English title of a group of tropical American monkeys known to the natives of Brazil by the name *coaíta*, and to zoologists as *Ateles*, in allusion to the imperfectly-developed thumb. They take their English name from the slimmness of the body, the elongated limbs, and the long tail, the under surface of the prehensile extremity of which is naked. The thumb is either rudimentary or wanting, so that the hands act merely as hooks in climbing. The absence of woolly under-fur, the less compressed nails, and the broader partition between the nostrils distinguishes them from the woolly spider-monkeys (*Brachyteles*). The species are numerous, and the most active and thoroughly arboreal of all American monkeys. The prehensile tail is employed not only as a means of suspension, but also to convey food to the mouth. These monkeys generally go about in small parties, high up in the trees; and, like the other members of the group, are comparatively silent. Their food consists chiefly of fruits and leaves. (See PRIMATES.)

SPIDERS, the common English name of Arachnida (*q.v.*) of the order Araneae, resembling the Pedipalpi in many structural points, but differing from them as well as from all other Arachnida in retaining short abdominal appendages known from their silk-manipulating function as spinnerets or spinning mamillae, with which are associated silk glands. It is probably owing to the possession of such glands and the varied purposes for which the silk is used that spiders as a group far surpass the other orders of Arachnida, with the possible exception of the Acari (mites and ticks), in diversity of form and of size, in numbers of genera and species, in extent of geographical distribution, and in adaptation to varied habitats. Except in the extreme north and south, and on the tops of the highest mountains, where there is no insect life as food supply, spiders are found all over the world, even in isolated oceanic islands. They occur up mountain slopes as far as vegetation extends, in tropical valleys and forests, in open grassy plains, in sandy deserts, and even in fresh-water ponds and between tide-marks on the seashore. Some are nocturnal, some diurnal; some catch their prey by speed of foot, some by cunningly lying hid, some by means of silken nets. The phenomena known as "protective resemblance," or similarity to inanimate objects or vegetation, and the kindred phenomenon of "mimicry," or beneficial likeness to certain protected species of animals, are common in the group. In these particulars, considered in their entirety, spiders show a marked contrast to other Arachnida, such as the scorpions, pedipalps, book-scorpions and so-called harvest spiders, which by comparison are remarkably uniform, within the limits of the orders, in structure, habits and other respects. Spiders, in short, must be regarded as the most highly organized and the most successful members of the class Arachnida.

Their success in the struggle for existence, as already indicated, must be assigned in a great measure to the possession of silk glands and to their power of manipulating the silk for a variety of purposes. Several facts point to the conclusion that the primary use of this secretion was the formation of egg-cases or cocoons by the female, for this is the only constant use for which the silk is employed, without exception, by all species. The second step in the evolution of spinning instincts was probably the making of a silken chamber for the reception of the cocoon itself and for the protection of the mother while guarding it and her newly-hatched young. If an aperture for ingress and egress, for purposes of feeding, were left in the wall of such a chamber, there would arise in a rudimentary form what is known as the tubular nest or web; and the next important step was possibly the adoption of such a nest as a permanent abode for the spider. Some spiders, like the *Drassidae* and *Salticidae*, have not advanced beyond this stage in architectural industry; but next to the cocoon this simple tubular retreat—whether spun in a crevice or burrow or simply attached to the lower side of a stone—is the most constant feature to be observed in the spinning habits of spiders. From this starting-point the evolution of web-making seems to have proceeded along two main divergent lines. Along one line there was a gradual elaboration of the tube until it culminated, so far as structural complexity is concerned, in the so-called trap-door nests or burrows of various families; along the other line the tubular retreat either retains its primitive simplicity in association with a new structure, the snare or net, or is entirely superseded by the latter.

Trap-door nests are made by spiders belonging to two widely different groups, namely the *Lycosidae* or wolf-spiders, to which the true tarantula (*q.v.*) belongs, and the Mygalomorphae, containing the species which construct the best-known types of this style of burrow. Although there is no direct genetic affinity between the spiders of these two groups, an interesting parallelism in their habits may be traced. In both there are species which form no nest or burrow, others which construct a simple silk-lined tunnel in the soil, and others which close the aperture of the burrow with a hinged door; while both share the habit of lining the burrow with silk to prevent the infall of loose sand or mould; and the species which make an open burrow close the aperture with a sheet of silk in the winter during

hibernation and open it again in the spring. Possibly from this habit was developed the instinct to build a door with a movable hinge. In the trap-door species of *Lycosidae*, like, for instance, *Lycosa opifex* of the Russian steppes, the hinge is weak and the lid of the burrow is kept normally shut by being very much thicker and heavier at its free margin opposite the hinge so that it readily falls by its own weight. In the burrows made by the Mygalomorphae, on the contrary, the hinge is strong and highly elastic, its component silken threads being laid on in such a way that the door shuts with a snap when the occupant has passed in or out. The lid is sometimes thin and wafer-like as in the burrow of the species of *Nemesia*, sometimes thick and cord-like as in that of the species of *Cleniza* or *Pachylomerus*. Its upper side is always covered by the spider with pieces of the vegetation growing hard by, so that, when the door is closed, the position of the burrow is completely concealed. If an attempt be made by any enemy to lift the lid, the spider seizes its inner side with his fangs and striking his claws into the walls of the burrow offers the greatest possible resistance to the efforts of the intruder. When on the watch for prey the spider slightly raises the lid and, peeping through the chink, darts like a flash upon any beetle or fly that unwittingly passes within reach. Quite commonly the burrow has a second passage running obliquely upwards from the main passage to the surface of the soil, and this subsidiary track may itself be shut off from the main branch by an inner door, so that when an enemy has forced an entrance through the main door, the spider retreats behind the second, leaving the intruder to explore the seemingly empty burrow.

There is no doubt that the primary influence that has guided the evolution of the architecture of the burrowing spiders has been that great necessity for the preservation of life, avoidance of enemies and protection from adverse physical conditions like rain, cold or drought. And when we turn to the other line along which the web-building instinct has been developed we find that the primary guiding influence has been that second great vital necessity, namely the necessity of getting food. Reference has already been made to the silken tube or tent, of simple structure, with an orifice at one or both ends, as the possible origin of all snares, however complex they may be. Perhaps the most rudimentary form of snare arose from the spinning of threads round the mouth of the tube to hold it in place. Be that as it may, the snare in many instances, as in that of the *Agalenidae* (*Tegenaria*, *Agalena*), a family closely allied to the *Lycosidae*, is a horizontal sheet of webbing, upon which the spider runs, continuous with the lower half of the aperture of the tube, of which it is simply an extension. A very similar sheet is spun by a species of *Linyphia*, one of the *Argyropidae*, but in this case there is no tube connected with the web and the spider hangs suspended beneath the horizontal netting. Snares of another type consisting of a tangled mass of threads amongst which the spiders pick their way with ease, but which are impassable to insects, are spun by members of the *Theridiidae* and *Pholcidae*; but by common consent the so-called orbicular web, so characteristic of the *Argyropidae* but by no means confined to them, is regarded as manifesting the greatest perfection of instinct in snare-spinning. These webs, which are typically subcircular in form, consist of a system of threads radiating from a common centre and crossed at intervals, and approximately at right angles, by a series of concentric lines, the whole being suspended in a triangular, quadrangular or polygonal framework formed of so-called foundation lines, attached to the branches or leaves of trees or other firm objects in the neighbourhood. Passing back from the centre of the web to the underside of an adjoining leaf or some other sheltered spot runs a single thread, the trap line affording passage to the spider to and from the sheltered spot and the snare itself. At whatever spot an insect becomes entangled in the frame, the vibration set up by its struggles is transmitted along the nearest radiating thread to the centre and thence up the trap line to the shelter where the occupant lurks awaiting the signal. No sooner is the vibration perceived than the spider descends with all speed to the centre, and by feeling the ends of the radiating lines learns which is ashake

and rapidly, without the possibility of mistake, makes its way to the entangled insect. The probable reason for the wall-lines being concentric is that lines passing over the radii as nearly as possible at right angles are the shortest that can be laid on; they therefore use up a smaller quantity of silk and take a shorter time to spin than threads crossing the radii in any other direction; and at the same time they afford them the greatest possible support compatible with delicacy and strength of construction. On account of its delicacy no web is more difficult to see than one of the orbicular type above described. Its whereabouts is thus, to a great extent, concealed both from enemies searching for spiders and from insects suitable for food; and its open meshwork of strong threads makes it much less liable to be beaten down by rain or torn to shreds by winds than if it were a flat sheet of closely woven silk. In constructing, therefore, a snare of radiating and concentric lines, it seems that a spider economizes both time and silk and in addition renders the web as strong and as serviceable and yet as delicate and invisible as possible.

Perfect orbicular webs are made by many genera of *Argyropidae* (*Zilla*, *Meta*, *Gasteracantha*), the best-known example being that of the common garden spider of England, *Aranea* or *Epeira diademata*; but these webs are not associated with any tubular retreat except such as are made under an adjoining leaf or in some nook hard by. Some tropical members of the family belonging to the genus *Nephela*, however, spin a web which is intermediate in structure between that of *Aranea* and the complete sheet-like web of *Agalena*. It covers an area of about one-third of a circle and its radiating threads diverge from the mouth of a funnel-shaped tube resembling in every respect the tube of the last-mentioned genus. Again some species of *Dictyna*, belonging to the *Amaurobiidae*, also have a tubular retreat opening on to the surface of a snare in which a crude attempt at a radial and concentric arrangement of the threads is perceptible. The interest of these two types of web lies in the fact that they bridge over the structural gap between the simple sheet-web of *Agalena* and the perfected orb-web of *Aranea*.

Dictyna may be cited as an example of a group of spiders, sometimes called the Cribellata, which have certain spinning glands and appliances not possessed by others. These glands are represented externally by a special plate, the *cribellum*, which lies in front of the ordinary spinning mamillae, and by a comb of short bristles, the *calamistrum*, placed in the penultimate segment of the left of the last pair. By means of the calamistrum the silk secreted by the cribellum is teased into a fine thread which is twisted round the main threads of the web, giving it a very characteristic woolly or flocculent appearance.

There are many other uses to which silk is put, besides those mentioned above. By trailing a thread behind them spiders are able to drop from any height to the ground and to retrace their steps with certainty to a particular spot. The possession of silk-glands has also profoundly influenced the geographical distribution of spiders and has enabled them to cross arms of the sea and establish themselves on isolated oceanic islands which most of the orders of Arachnida are unable to reach. This is effected by the so-called habit of "ballooning" practised by very young spiders, which float through the air, often at great altitudes, in the direction of the prevalent winds. It was formerly supposed that this custom was peculiar to a single species, which was called the "gossamer" spider from the fact that the floating webs, when brought to the earth by rain or intercepted by bushes and trees, coat the foliage or grass with a sheeting of gossamer-like silk; but the habit is now known to be practised by the newly-hatched young of a great variety of species belonging to several distinct families.

As a commercial product spider-silk has been found to be equal, if not superior, to the best silk spun by lepidopterous larvae; but the cannibalistic propensities of spiders, making it impossible to keep more than one in a single receptacle, coupled with the difficulty of getting them to spin freely in a confined space, have hitherto prevented the silk being used on any extensive scale for textile fabrics.

The methods of catching prey adopted by spiders are extremely varied. The nets or snares are highly efficient for this purpose. Amongst the threads, which entangle the wings and legs of intercepted prey, the spiders are perfectly at home and can pounce on the struggling victim at once if it be small and harmless or keep at a respectful distance, checking all efforts at escape, if it be poisonous or strong. If in the latter case the spider be afraid to come to close quarters, various devices for securing it are resorted to. The *Theridiidae* eject on to the insect from their spinning mamillae drops of liquid adhesive silk; the *Argyropidae*, steadying it with the tips of their long front legs, sweep additional strands of silk over it with the legs of the hinder pair; the *Agelenidae*, attaching a long thread to a point hard by, run round and round the victim in circles, gradually winding it up beyond all hope of breaking loose. Two genera of *Argyropidae* (*Hyptiotes* and *Theridiosoma*) construct spring-nets out of their incomplete webs of the orbicular type. To the web is attached a trap-line which when drawn taut holds the snare stretched and tight, and when relaxed loosens the whole structure so that the threads fall together. When an insect strikes the web the spider loosens his hold of the trap-line, thus enveloping the victim in a tangle of threads which would otherwise not come into contact with it. Spiders which spin no snare are dependent for capturing prey for the most part upon their quickness or powers of lying concealed. Many *Thomisidae* lurk amongst the stamens and petals of flowers, which they closely match in colour, waiting to seize the insects which visit the blossoms for nectar. Examples of *Selenops* (*Clubionidae*) lie flat and absolutely still on the bark of trees, to which their coloration assimilates, and spring like a flash of light upon any insect that touches their legs; the *Lycosidae* dart swiftly upon their prey; and the *Salticidae*, which compared with other spiders have keen powers of vision, stealthily stalk it to within leaping distance, then, gathering their legs together, cover the intervening space with a spring and with unerring aim seize it and bury their fangs in its body. One genus of *Thomisidae* (*Phognarachne*), which inhabits the Oriental region, adopts the clever device of spinning on the surface of a leaf a sheet of web resembling the fluid portions of a splash of bird's dung, the more solid central portions being represented by the spider itself, which waits in the middle of the patch to seize the butterflies or other insects that habitually feed on birds' excrement and are attracted to the patch mistaking it for their natural food.

The sexes of spiders are distinct. Except in the case of the water-spider (*Argyroneta*) the males are smaller, sometimes very much smaller, than the females, but have proportionately longer legs and smaller bodies. When adult the males may always be distinguished from the females by the presence of a pair of horny intromittent organs, one of which is lodged in the terminal segment of each palpus or appendage of the second pair. In its simplest form this is a hollow flask-shaped horny piece, consisting of a dilated basal portion and a terminal spiniform portion with an orifice at the apex; but its structure is frequently complicated by accessory processes and outgrowths which aid copulation and serve to protect the delicate point from injury. In the breeding season the male deposits drops of sperm on a sheet of webbing, picks it up in these flasks by means of capillary attraction and carries it about until he falls in with a female. During pairing he thrusts the tip of these organs into the seminal vesicles of the female and the eggs are fertilized as they pass out of the oviduct. Cases of parthenogenetic reproduction, or reproduction without the intervention of the male, have been recorded in the case of two genera (*Filistata* and *Tegenaria*), and may be commoner than is usually supposed. All spiders are oviparous. The number of eggs produced at a time varies enormously according to the species, from about half a dozen, more or less, in some ant-mimicking *Atidae* or jumping spiders to many hundreds in the larger orbicular-webbed spiders of the family *Argyropidae*. The first act of the female after oviposition is to wrap her eggs in a casing of silk commonly called the cocoon. The cocoon varies greatly in size, shape and consistency according to the nature of the spider that makes it. Sometimes, as in *Pholcus*, it is

merely a thin network of silk just sufficient to hold the eggs together. More often it consists of a thick felting of silk, either spun in one continuous piece into a globular form, as in the *Aviculariidae*, or composed of two plate-like pieces, an upper and a lower, united at the edges and lenticular in shape, as in some of the *Lycosidae*. Sometimes it is woolly and flocculent, sometimes smooth like parchment, and its shape depends in a large measure upon the habits of the female towards her offspring. As a rule terrestrial spiders guard the cocoon in the permanent burrow, as in the trap-door spiders, or in the silken retreat which acts as a temporary nursery, as in the *Salticidae*. Other species of wandering habits carry the cocoon about with them, sometimes attached to the spinnerets, as in the *Lycosidae*, sometimes tucked under the thorax, as in the large tropical house-spider, *Heteropoda regia*, one of the *Clubionidae*. The females of some snare-spinning species, like the *Pholcidae*, carry it in their jaws; but in the case of the *Argyropidae* the females usually leave the cocoon to its fate as soon as it is constructed, sometimes rolling it in a leaf, sometimes attaching it by a stalk to a branch. It is in this and related families that the greatest diversity in the colour and form of the cocoon is found. In these spiders, too, the newly-hatched young shift for themselves as soon as they emerge from the cocoon; in others that guard the cocoon the young stay for a longer or shorter time under their mother's protection, those of the wandering *Lycosidae* climbing on her back to be carried about with her wherever she goes. There is no metamorphosis during growth such as occurs in some insects, the young being hatched with its full complement of appendages and only differing from its parents in characters of comparatively minor importance. Growth is accompanied by a succession of moults, the spider emerging from its old skins by means of a fracture which extends along the front and sides of the cephalothorax just beneath the edge of the carapace. It is only at the final moult that the sexual organs are mature, the two sexes being alike in the earlier stages of growth. Until maturity is reached the spider has the power to repair lost or damaged limbs. If a limb be lost at an early stage it may be re-grown in perfection; but at later stages it is only imperfectly reproduced and is shorter and thinner than the other limbs. Rapidity of growth and longevity vary greatly according to circumstances and to the species. In northern and temperate latitudes where insects disappear in the winter, species of *Argyropidae* like *Aranea diademata*, live only for a single season. The young emerge from the cocoon in the early spring, grow through the summer, and reach maturity in the early autumn. The sexes then pair and perish soon after the female has constructed her cocoon. Species of other families (*Lycosidae*, *Clubionidae*) may live for a few seasons, hibernating in the soil or amongst dead leaves; and examples of the larger spiders (*Aviculariidae*) have been kept alive in captivity for several years.

Owing to the smaller size of the male and the greater voracity of the female, the male makes his advances to his mate at the risk of his life and is not infrequently killed and eaten by her either before or after pairing has been effected. Fully aware of the danger, he pays his addresses with extreme caution, frequently waiting for hours in her vicinity before venturing to come to close quarters. Males of the *Argyropidae* hang on the outskirts of the webs of the females and signal their presence to her by jerking the radial threads in a peculiar manner. Other web-spinning spiders (*Tegenaria*) have somewhat similar habits; and the male of the park-web spider (*Atypus*), one of the *Mygalomorphae*, taps the walls of the tubular web of the female before daring to bite a hole in it and descend into her burrow. Most curious of all is the courtship of the males of some species of *Salticidae*, or jumping spiders, which are decorated with plumes or coloured stripes or iridescent patches. These they display before her, posing and performing extraordinary antics in her presence exactly as cock birds behave towards their hens. Lastly, the males of some species of spiders differ from the females in possessing stridulating organs consisting of horny ridges and spikes and lodged either between the mandible and palpus as in some species allied to *Linyphia*, one of the *Argyropidae*, or between

the cephalo-thorax and abdomen as in *Steatoda*, one of the *Theridiidae* and *Cambridgea*, one of the *Agelenidae*. It is believed that the males of these species signal to their females by means of the sound these organs emit. The greatest disparity in size between the sexes is met with in the tropical genus *Nephila*, the females of which are gigantic representatives of the *Argyropidae*. The male, however, is a veritable pigmy beside the female, and during copulation presents the appearance of a parasite attached to her abdomen. It has been suggested that the diminutive size of the male is of great advantage to him during courtship, because he is enabled to move easily thereby to escape from her clutches should she turn upon him with hostile intent.

All spiders possess a pair of poison-glands, one in each of the chelicerae or mandibles and opening by means of a duct at the tip of the fang. The primary function of this poison is to kill the prey upon which they feed, its action being very rapid upon insects. In a great majority of cases, however, it is comparatively innocuous to human beings, despite legends to the contrary that have arisen in connexion with certain species like the tarantula. The bite, however, of any spider, strong enough to pierce the skin, may give rise to a certain amount of local inflammation and pain depending principally upon the amount of poison injected. The bite, for example, of large species of the family *Aviculariidae*, sometimes called Mygales, and sometimes, but erroneously, known as tarantulas, species which have fangs half an inch long and as sharp as needles and a considerable quantity of poison, may be very painful, though seldom serious provided the health of the patient be good. There is one possible exception, however, to the innocuous nature of the poison and this is supplied by the species of the genus *Lathrodectus*, one of the *Theridiidae*. There is no actual proof that this spider is more poisonous than others, but it is a significant fact that its species, inhabiting countries as widely separated as Chile, Madagascar, Australia, New Zealand and South Europe are held in great fear by the indigenous population, and many stories are current of serious or fatal results following their bites. Many of the species of these spiders, moreover, are very conspicuously coloured, being either wholly black or black relieved by fiery red spots, forcibly suggesting that they are warningly coloured. Some of the species of *Aviculariidae* also appear to be warningly coloured with black or black and red, and their coloration is associated with the urticating nature of their bristles, which makes them highly unpalatable to vertebrate foes. So far as is known, however, only the large spiders belonging to this group possess this special means of defence, and in many other species this is accompanied by highly-developed stridulating organs resembling those of rattlesnakes and scorpions in function. Others again, like *Gasteracantha* and *Acrosoma*, belonging to the *Argyropidae*, are armed with sharp and strong abdominal spines, and these spiders are hard-shelled like beetles and are spotted with black on a reddish or yellow ground, their spines shining with steel-blue lustre. The majority of spiders, however, are soft-skinned and succulent, and are tasty morsels for insectivorous reptiles, birds and mammals. Hence as a very general rule the coloration makes for concealment under natural conditions of existence, and the instincts which lead to concealment are very highly developed. As instances of procrystic or relative coloration may be mentioned that of the species of the genus *Dolomedes*, one of the *Lycosidae*, which lives amongst reeds and is marked with a pair of longitudinal yellow lines which harmonize with the upright stalks of the vegetation, and *Lycosa picta*, which lives on the sand, can scarcely be seen on account of its mottled pattern: *Sparassus smargdulus* and the species of *Pecucetia*, which are found amongst grass or low green herbage, are mostly green in colour, and *Salicicus scenicus* is banded with white and black to match the grey tint of the rocks and stone walls on which it hunts its prey. Similar instances of protective coloration could be cited without end. Sometimes the shape of the spider combines with the colour to produce the same effect, as in the species of *Uloborus*, which as they hang in thin shabby-looking webs exactly resemble fragments of wind-blown rubbish. The success of procrystic coloration depends, however, very largely

upon stillness, and the instinct to keep stationary without moving a limb is a marked characteristic of all spiders unless engaged in hunting or fleeing from imminent danger. The instinct reaches its highest development in the phenomenon miscalled "death feigning." Spiders of various families will, when alarmed, lie absolutely still with legs tucked up and allow themselves to be pushed and rolled, and handled in various ways without betraying that they are alive by the slightest movement. But it would be absurd to suppose that they are in reality pretending to be dead, because there is no reason to think they can have any knowledge of death. They are merely practising the inherited instinct to lie motionless, movement being the only indication of the presence of living prey known to many insectivorous animals. When concealment is no longer possible terrestrial species, like the *Lycosidae*, dart swiftly to the nearest shelter afforded by crevices in the soil, stones, fallen leaves or logs of wood, while those that live in bushes, like the *Argyropidae*, drop straight to the ground and lie hidden in the earth or in the fallen vegetation beneath.

The extent to which procrystic coloration and instincts favouring concealment are developed indicates that generation after generation spiders have been subjected to persecution from enemies. No doubt large numbers are devoured by insectivorous birds, mammals and reptiles, but the mortality due to them and other foes sinks into insignificance beside that caused by the persecution of hymenopterous insects of the families *Ichneumonidae* and *Pompilidae*, especially of the latter, many species of which systematically ransack the country for spiders wherewith to feed their young in the breeding season. It is no exaggeration to say that countless thousands of spiders of all families are annually destroyed by these insects, and there is no reason to doubt that destruction on at least as great a scale has been going on for centuries, too many even to guess at. Hence it is probable that no factor has had a greater influence than these wasps in moulding the protective instincts and habits of spiders. One interesting phenomenon in spider-life seems to be directly and certainly traceable to this influence, and that is mimicry of ants. In several families of spiders, but principally in those like the *Clubionidae* and *Salticidae*, which are terrestrial in habits, there are species which not only live amongst ants, but so closely resemble them in their shape, size, colour and actions that it requires a practised eye to distinguish the Arachnid from the insect. Now the *Pompilidae* or mason wasps provision their cells with insects of many different kinds, as well as with spiders; but, of the hundreds of species of these wasps that have been described from different parts of the world, only one is known to use ants for this purpose; and this species is not one that preys upon spiders. On the other hand it has been specially recorded of two of the species of spider-destroyers that they have great dislike and apparent fear of these little poisonous Hymenoptera. So, too, does it appear that ants are entirely immune to the attacks of *Ichneumonidae*, which destroy hosts of other insects and of spiders by laying their eggs upon their bodies. But since ants are not persecuted by these two families of Hymenoptera, the greatest enemies spiders have to contend with, it is evident that mimicry of ants is of supreme advantage to spiders. Ants, however, are not the only animals mimicked by spiders. Some members of the *Argyropidae* (*Cyclosa*) are exactly like small snails; others (*Cyrtarachne*) resemble *Coccinellidae* in shape and colour. Now, *Coccinellidae* (ladybirds) are known to be highly distasteful to most insectivorous mammals and birds, and snails would be quite unfit food for the Pompilid or Ichneumonid larvae, so that the reason for the mimicry in these cases is also perfectly clear. The exact extent, however, to which each particular class of enemy has affected the protective habits and attributes of spiders is by no means always evident; and it is impossible to discuss the question in detail within the limits of a short article. But two instances of extreme deviation from the ordinary mode of life due, apparently, like ant-mimicry, solely, if not wholly, to the persecution of Hymenoptera, may be cited as illustrations of the profound effect upon habit brought about by long-continued persecution from enemies of this kind.

This deviation is the adoption of an aquatic mode of life by the European fresh-water spider (*Argyroneta*) and by the marine spider *Desis*, which is found on the shores of the Indian and Pacific Oceans from Cape Colony to eastern Australia. *Desis* lives invariably between tide-marks upon the rocks and coral reefs, and may be found at low tide either crawling about upon them or swimming in tidal pools and feeding upon small fish or crustaceans. As the tide rises the spiders take refuge in crevices and spin over their retreat a sheet of silk, impervious to water, beneath which they lie in safety with a supply of air until the ebb exposes the site again to the sun. The fresh-water spider (*Argyroneta*) lives amongst the weeds of lakes and ponds and, like *Desis*, is quite at home beneath the water either swimming from spot to spot or crawling amongst the stems of aquatic plants. As a permanent home the spider makes beneath the surface a thimble-shaped web, with inverted mouth, anchoring it to the weeds. He then ascends to the surface, carries down a bubble of air and releases it inside the mouth of the silk-thimble, thus replacing a certain amount of water. This action is repeated until the domicile is filled with air, when the spider takes possession of it. The spider owes its name *Argyroneta* or the silver swimmer to its silvery appearance as it swims about under water enveloped in air, and its power to retain an envelope of air on its sternum and abdomen depends upon the circumstance that these areas are beset with hairs which prevent the water reaching the integument; but the air retained by these hairs can be released when the spider wishes to fill its subaqueous home with that element. *Argyroneta* feeds principally upon flies or gnats, which it seizes from below as they light upon the surface of the water. In the breeding season the male spins a bell or thimble near that of the female and joins the two by means of a silken passage. The female attaches her eggs to the inner wall of her own home, and the young when large enough to shift for themselves have the bell-making instinct fully developed. Since the adoption of an aquatic mode of life by *Desis* and *Argyroneta* involves no increased facilities in getting food, and merely substitutes for ordinary terrestrial enemies fishes and crustaceans in the former case, and fishes, amphibians, and insectivorous water-insects in the latter, the supposition is justified that the change in environment is due to the unremitting persecution of *Pompilidae* and *Ichneumonidae*, which would not venture to pursue their prey beneath the water's surface. The habits of certain other spiders suggest the origin of the perfect adaptation to aquatic conditions exhibited by *Desis* and *Argyroneta*. The nature of the integument and its hairy clothing in all spiders enables them to be plunged under water and withdrawn perfectly dry, and many species, even as large as the common English house-spider (*Tegenaria*), are so lightly built that they can run with speed over the surface of standing water, and this faculty has been perfected in genera like *Pirata*, *Dolomedes* and *Triclaria*, which are always found in the vicinity of lakes or on the edges of rivers and streams, readily taking to the water or running down the stems of water plants beneath its surface when pursued. Some species of *Dolomedes*, indeed, habitually construct a raft by spinning dead leaves together and float over the water upon it watching for an opportunity to dash upon any insect that alights upon its surface.

Geologically, spiders date from the Carboniferous Period, *Arthrolycosa* and others from the coal beds of Europe and North America being closely allied to the existing genus *Liphistius*. Remains of spiders from the Baltic amber beds of Oligocene age and from nearly coeval fluviatile or lacustrine deposits of North America belong to forms identical with or closely related to existing genera, thus proving the great antiquity of our present spider fauna. (R. I. P.)

SPIELHAGEN, FRIEDRICH VON (1820–), German novelist, was born at Magdeburg on the 24th of February 1820. He was brought up at Stralsund, where his father was in 1835 appointed government architect; he attended the gymnasium there, and studied law, and subsequently literature and philosophy, at the universities of Berlin, Bonn and Greifswald. On leaving the university he became a master in a gymnasium at Leipzig, but upon his father's death in 1854 devoted himself

entirely to writing. After publishing *Klara Vere* (1857) and *Auf der Düne* (1858), he obtained a striking success with *Problematische Naturen* (1860–1861), one of the best novels of its time; it was followed by *Die von Hohenstein* (1863), *In Reih' und Glied* (1866), *Hammer und Amboss* (1869), *Deutsche Pioniere* (1870), *Allzeit voran!* (1872), *Sturmflut* (1876), *Plattland* (1878), *Quisisana* (1880), *Angeia* (1881), *Uhlenhans* (1884), *Ein neuer Pharao* (1889), *Faustulus* (1897) and *Freigeboren* (1900). Spielhagen's best work was produced between the years 1860 and 1876; he wrote nothing after *Sturmflut* which can be compared with that powerful romance. His novels combine two elements of especial power, the masculine assertion of liberty which renders him the favourite of the intelligent and progressive citizen, and the ruthless war he wages against the self-indulgence of the age. His love of the sea, derived from an early residence at Stralsund, introduces an element of poetry into his novels which is somewhat rare in German fiction. Spielhagen's dramatic productions, *Hans und Grete* (1868) and *Liebe für Liebe* (1875), and others, cannot compare with his novels. From 1878–1884 he was editor of *Westermann's Monatshefte*.

Spielhagen's *Sämtliche Werke* were published in 1871 in sixteen volumes, in 1878 in fourteen volumes; his *Sämtliche Romane* in 1898 (22 vols.), and these were followed by a new series in 1902. See his autobiography, *Finder und Erfinder* (2 vols., 1890); also G. Karpeles, *F. Spielhagen* (1889), and H. and J. Hart, *Kritische Waffengänge* (1886).

SPIESS, CHRISTIAN HEINRICH (1755–1799), German writer of romances, was born at Freiberg in Saxony on the 4th of April 1755. For a time an actor, he was appointed in 1788 controller on the estate of a certain Count Künigl at Betzdikau in Bohemia, where he died, almost insane, the result of his weird fancies, on the 17th of August 1799.

Spieß, in his *Ritter-, Räuber- und Geister-Romane*, as they are called—stories of knights, robbers and ghosts of the "dark" ages—the idea of which he borrowed from Goethe's *Götz von Berlichingen* and Schiller's *Räuber* and *Geisterseher*, was the founder of the German *Schauerroman* (shocker), a style of writing continued, though in a finer vein, by Karl Gottlob Cramer (1758–1817) and by Goethe's brother-in-law, Christian August Vulpius. These stories, though appealing largely to the vulgar taste, made Spieß one of the most widely read authors of his day. The most popular was a ghost story of the 13th century, *Das Petermännchen* (1793); among others were *Der alte Überall und Nirgends* (1792); *Die Löwenritter* (1794), and *Hans Heiling, vierter und letzter Regent der Erd-Feuer- und Wasser-Geister* (1798). Beside numerous comedies, Spieß wrote, anticipating Schiller, a tragedy *Maria Stuart* (1784), which was in the same year performed at the court theatre in Vienna.

See Karl Goedeke, *Grundriss*, v. 506 sqq.; Müller-Fraureuth, *Die Ritter- und Räuberromane* (Halle, 1894).

SPIKENARD, or **NARD** (O. Fr. *spiquenard*, Lat. *spica nardi*, from *spica*, ear of corn, and Gr. *νάρδος*, Pers. *nard*, Skt. *nalada*, Indian spikenard, from Skt, *nal*, to smell), a celebrated perfume which seems to have formed one of the most durable aromatic ingredients in the costly unguents used by the Romans and Eastern nations. The ointment prepared from it ("ointment of pistic nard"¹) is mentioned in the New Testament (Mark xiv. 3–5; John xii. 3–5) as being "very costly," a pound of it being valued at more than 300 denarii (over £10). This appears to represent the prices then current for the best quality of nard, since Pliny (*H.N.* xii. 26) mentions that nard spikes reached as much as 100 denarii per lb, and, although he does not mention the price of nard ointment, he states (xiii. 2) that the "unguentum cinnamominum," a similar preparation, ranged from 25 to 300 denarii according to its quality. Nard ointment also varied considerably in price from its liability to sophistication (*Ibid.* xii. 26, 27; xiii. 2). The genuine ointment²

¹ The meaning of the word "pistic" is uncertain, some rendering it "genuine," others "liquid," and others taking it for a local name.

² The use of alabaster vessels for preserving these fragrant unguents was customary at a very early period. Theophrastus (c. 314 B.C.) states that vessels of lead and alabaster were best for the purpose, on account of their density and coolness, and their power

(*unguentum nardinum sive foliatum*) contained costus (the root of *Saussurea lappa*), amomum (the fruits of *Amomum cardamomum*), balm (the oleoresin of *Balsamodendron opobalsamum*) and myrrh, with Indian nard (Ibid. xiii. 2).

The exact botanical source of the true or Indian nard was long a matter of uncertainty, the descriptions given by ancient authors being somewhat vague, but it is now identified as *Nardostachys jatamansi*, a plant of the valerian order, the fibrous root-stocks or "spikes" of which are still collected in the mountains of Bhotan and Nepal. The name "spike" is applied apparently from its resemblance in shape to a spike or ear of bearded corn. The root is crowned by the bases of several stems, each about 2 in. or more in length and as thick as the finger. To these the fibrous tissue of former leaves adheres and gives them a peculiar bristly appearance. It is this portion that is chiefly collected.

Other and inferior varieties of nard are mentioned by Dioscorides and subsequent writers. Celtic nard, obtained from the Ligurian Alps and Istria, consisted of the roots of plants also belonging to the valerian order (*Valeriana celtica* and *V. saxatilis*). This was exported to the East and thence to Egypt, and was used in the preparation of baths. Mountain nard was collected in Cilicia and Syria, and is supposed to have consisted of the root of *Valeriana tuberosa*. The false nard of Dauphiné, used in later times, and still employed as a charm in Switzerland, is the root-stock of *Allium victorialis*. It presents a singular resemblance to the spikes of Indian nard, but is devoid of fragrance. It is remarkable that all the nards belong to the natural order *Valerianaceae*, the odour of valerian being considered disagreeable at the present day; that of *Nardostachys jatamansi* is intermediate between valerian and patchouli, although more agreeable than either.

The name "spikenard" has also been applied in later times to several plants. The spikenard of the United States is *Aralia racemosa*, and another species of the same genus, *A. nudicaulis*, or wild sarsaparilla, is known as "wild spikenard." In the West Indies *Hyphis suaveolens* is called "spikenard," and in Great Britain the name "ploughman's spikenard" is given to *Inula conuza*.

SPILLIKINS (M.D., *spelleken*, little pin), or **JACKSTRAW**s (originally "jerk-straws"), a game of some antiquity played with a set of slender sticks of wood, bone or ivory, from 3 to 6 in. long, generally carved to represent weapons and utensils of various kinds, which are thrown in a heap haphazard upon the table. The players then endeavour in turn to extricate from the heap, one at a time, as many straws as possible, without moving any except the one angled for. The player obtaining the most straws wins. The game is called in French *jonchets* and in German *Federspiel*.

SPINA (Lat. for a thorn, or prickle, also backbone, whence spine), in architecture, the term given to the low podium wall which divided the circus of the Romans and round which the chariots ran; at each end of it was the *meta* or goal. On coins, gems and bas-reliefs it is shown with numerous other features on it, such as obelisks (of which those from the spina of the Circus Maximus are now in the piazzas of the Lateran and del Popolo), small aedicula or pairs of columns carrying an entablature, altars, statues, trophies, &c.

SPINACH (*Spinacia oleracea*), an annual plant, a member of the natural order *Chenopodiaceae*, which has been long cultivated for the sake of its succulent leaves. It is probably of Persian origin, being introduced into Europe about the 15th century. It should be grown on good ground, well worked and well manured; and for the summer crops abundant watering will be necessary.

The first sowing of winter spinach should be made early in August, and another towards the end of that month, in some sheltered but not shaded situation, in rows 18 in. apart—the plants, as they advance, being thinned, and the ground hoed. By the beginning of winter the outer leaves will have become fit for use, and if the weather is mild successive gatherings may be obtained up to the beginning of May. The prickly-seeded and the Flanders are the best for winter; and these should be thinned out early in the autumn to about 2 in. apart, and later

of resisting the penetration of the ointment into their substance. Pliny also recommends alabaster for ointment vases. For small quantities onyx vessels seem to have been used (Horace, *Carm. iv.* 12, lines 10, 17).

on to 6 in. The lettuce-leaved is a good succulent winter sort, but not quite so hardy. To afford a succession of summer spinach, the seeds should be sown about the middle of February, and again in March; after this period small quantities should be sown once a fortnight, as summer spinach lasts but a very short time. They are generally sown in shallow drills, between the lines of peas. If a plot of ground has to be wholly occupied, the rows should be about 1 ft. apart. The round-seeded is the best sort for summer use.

The *Orach* or *Mountain Spinach* (*Atriplex hortensis*), a member of the same order, is a tall-growing hardy annual, whose leaves, though coarsely flavoured, are used as a substitute for spinach, and to correct the acidity of sorrel. The white and the green are the most desirable varieties. The plant should be grown quickly in rich soil. It may be sown in rows 2 ft. apart, and about the same distance in the row, about March, and for succession again in June. If needful, water must be freely given, so as to maintain a rapid growth.

The *New Zealand Spinach* (*Tetragonia expansa*), natural order *Ficoideae*, is a half-hardy annual, native of New Zealand, sometimes used as a substitute for spinach during the summer months, but in every way inferior to it. The seeds should be sown in March, on a gentle hot-bed, having been previously steeped in water for several hours. The seedlings should be potted, and placed under a frame till the end of May, and should then be planted out in light rich soil. The young leaves are those which are gathered for use, a succession being produced during summer and autumn.

SPINAL CORD, in anatomy, that part of the central nervous system in man which lies in the spinal canal formed by the vertebrae, and reaches from the foramen magnum to the lower margin of the first lumbar vertebra. It is about 18 in. long, and only occupies the upper two-thirds of the spinal canal. The cord is protected by the same three membranes which surround the brain. Outside is the *dura mater*, which differs from that of the brain in not forming a periosteum

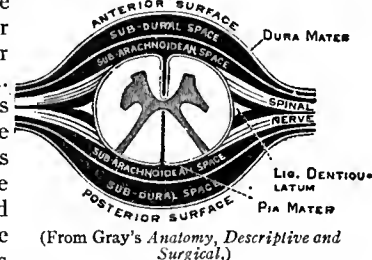

(From Gray's *Anatomy, Descriptive and Surgical*.)
FIG. 1.—Transverse Section of the Spinal Cord and its Membranes.

to the bones, in sending no processes inward, and in having no blood sinuses enclosed within its walls. In other words the spinal dura mater is the continuation of only the inner or cerebral layer of the dura mater of the skull. Inside the dura mater is the *arachnoid*, which is delicate and transparent, while between the two lies the *sub-dural space*, which reaches down to the second or third sacral vertebra. The *pia mater* is the innermost covering, and is closely applied to the surface of the cord into the substance of which it sends processes. Between it and the arachnoid is the *sub-arachnoid space*, which is much larger than the sub-dural and contains the cerebro-spinal fluid. Across this space, on each side of the cord, run a series of processes of the pia mater arranged like the teeth of a saw; by their apices they are attached to the dura mater, while their bases are continuous with the pia mater surrounding the cord. These ligaments, each consisting of twenty-one teeth, are the *ligamenta denticulata*, and by them the spinal cord is moored in the middle of the cerebro-spinal fluid.

The spinal cord itself is a cylinder slightly flattened from before backward. In the cervical region it is enlarged where the nerves forming the *brachial plexus* come off, while opposite the lower thoracic vertebrae the lumbar enlargement marks the region whence the lumbo-sacral nerves are derived. (See fig. 2.) Opposite the second lumbar vertebra the cylindrical cord becomes pointed and forms the *conus medullaris*, from the apex of which a glistening membranous thread runs down among the nerves which form the *cauda equina*, and, after blending with the termination of the dural sheath, is attached to the back of the coccyx.

In a transverse section of the cord two median fissures are seen; the antero-median (see fig. 3, A) is wide, and reaches about a third of the way along the antero-posterior diameter of the cord; it is lined by the pia mater, which, at its orifice, is thickened to form a

glistening band, known as the *linea splendens*; in front of this lies the single anterior spinal artery.

The postero-median fissure (fig. 3, P.) is much deeper and narrower, and has no reflection of the pia mater into it. Where the posterior nerve roots emerge (fig. 3, P.R.) is a depression which is called the *postero-lateral fissure*, while between this and the postero-median a slight groove is seen in the cervical region, the *paramedian fissure* (fig. 3, P.M.; see also fig. 2). On looking at fig. 3 it will be seen that the anterior nerve roots (A.R.) do not emerge from a definite fissure.

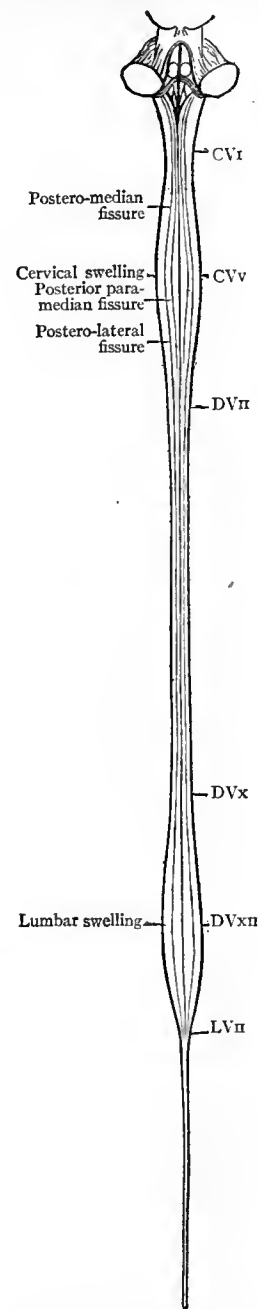

The spinal cord, like the brain, consists of grey and white matter, but, as there is here no representative of the cortical grey matter of the brain, the white matter entirely surrounds the grey. In section the grey matter has the form of an H, the cross bar forming the *grey commissure*. In the middle of this the *central canal* can just be made out by the naked eye (see fig. 4). The anterior limbs of the H form the *anterior cornua*, while the posterior, which in the greater part of the cord are longer and thinner, are the *posterior cornua*. At the tips of these is a lighter-coloured cap (fig. 3, S.G.) which is known as the *substantia gelatinosa Rolandi*. On each side of the H is a slighter projection, the *lateral cornu*, which is best marked in the thoracic region (see fig. 4).

On referring to fig. 4 it will be seen that the grey matter has different and characteristic appearances in different regions of the cord, and it will be noticed that in the cervical and lumbar enlargements, where the nerve to the limbs comes off, the anterior horns are broadened.

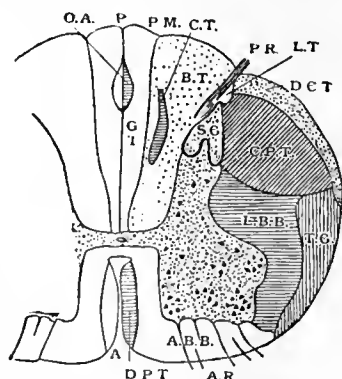

FIG. 3.—Diagram to show the Tracts in the Spinal Cord.

- A. Antero-median fissure.
- P. Postero-median fissure.
- A.R. Anterior nerve roots.
- P.R. Posterior nerve roots.
- P.M. Paramedian fissure.
- S.G. Substantia gelatinosa.
- G.T. Tract of Goll.
- B.T. Tract of Burdach.
- C.T. Comma tract.
- O.A. Oval area.
- L.T. Lissauer's tract.
- D.C.T. Direct cerebellar tract.
- T.G. Gowers' tract.
- C.P.T. Crossed pyramidal tract.
- L.B.B. Lateral basis bundle.
- A.B.B. Anterior basis bundle.
- D.P.T. Direct pyramidal tract.

(From D. J. Cunningham, in Cunningham's Text-Book of Anatomy.)

FIG. 2.—Diagram of the Spinal Cord as seen from behind.

CVI shows the level of the 1st cervical vertebra; CVV of the 5th cervical vertebra; DVII of the 2nd dorsal vertebra; DVX of the 10th dorsal vertebra; DVXII of the 12th dorsal vertebra; LVII of the 2nd lumbar vertebra.

Histologically the grey matter is made up of neuroglia, medullated and non-medullated nerve fibres, and nerve cells (for details see NERVOUS SYSTEM). The nerve cells are arranged in three main columns, ventral, intermedio-lateral and posterior vesicular. The *ventral cell column* has the longest cells, and these are again subdivided into antero-mesial, antero lateral, postero-lateral and central groups. The *intermedio lateral cell column* is found in the lateral horn of the thoracic region.

The *posterior vesicular* or *Clarke's column* is also largely confined to the thoracic region, and lies in the mesial part of the posterior cornu. It is the place to which the sensory fibres of the sympathetic system (visceral afferents) run. The white matter, as has been shown, surrounds the grey, and passes across the middle line to form the *white commissure*, which lies in front of the grey. It is composed of neuroglia and medullated nerve fibres, which are arranged in definite tracts, although in a section of a healthy cord these tracts cannot be distinguished even with the microscope. They have been and are still being gradually mapped out by pathologists, physiologists and embryologists.

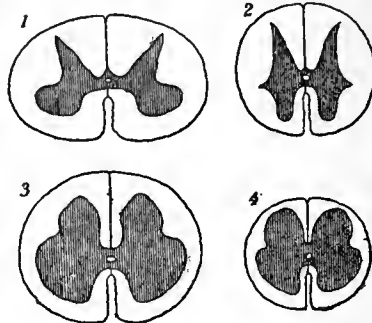

FIG. 4.—Sections of Spinal Cord, twice scale of nature.

1. Cervical enlargement.
2. Thoracic region.
3. Lumbar enlargement.
4. Sacral region.

On tracing a sensory nerve into the cord (fig. 3, P.R.) through the posterior nerve root it will be seen to lie quite close to the mesial side of the posterior horn of grey matter, where most of it runs upward. The next root higher up takes the same position and pushes the former one toward the middle line, so that the lower nerve fibres occupy an area close to the postero-median fissure known as the *tract of Goll* (fig. 3, G.T.), while the higher lie more externally in the *tract of Burdach* (B.T.). The greater part of each nerve sooner or later enters the grey matter and comes into close relation with the cells of Clarke's column, but some fibres run right up to the nucleus gracilis and cuneatus in the medulla (see BRAIN), while a few turn down and form a descending tract, which, in the upper part of the cord, is situated in the inner part of the tract of Burdach and is known as the *comma tract* (fig. 3, C.T.), but lower down gradually shifts quite close to the postero-median fissure and forms the oval area of Flechsig (fig. 3, O.A.). It will be obvious that both these tracts could not be seen in the same section, and that fig. 3 is only a diagrammatic outline of their position.

A few fibres of each sensory nerve ascend in a small area known as *Lissauer's tract* (fig. 3, L.T.) on the outer side of the posterior nerve roots, and eventually enter the substantia gelatinosa.

To the outer side of Lissauer's tract and lying close to the lateral surface of the cord is the *direct cerebellar tract* (fig. 3, D.C.T.), the fibres of which ascend from the cells of Clarke's column to the cerebellum. As Clarke's column is only well developed in the thoracic region this tract obviously cannot go much lower.

In front of the last and also close to the lateral surface of the cord is another ascending tract, the *tract of Gowers* (fig. 3, T.G.), or, as it is sometimes called, the lateral sensory fasciculus. It probably begins in the cells of the posterior horn, and runs up to join the fillet and also to reach the cerebellum through the superior cerebellar peduncle. The *crossed pyramidal tract* (fig. 3, C.P.T.) lies internal to the direct cerebellar tract, between it and the posterior cornu. It is the great motor tract by which the fibres coming from the Rolandic area of the cerebral cortex are brought into touch with the motor cells in the anterior cornu of the opposite side. This tract extends right down to the fourth sacral nerve.

In front of the crossed pyramidal tract is the lateral basis bundle (fig. 3, L.B.B.), which probably consists of association fibres linking up different segments of the cord.

The *anterior basis bundle* (fig. 3, A.B.B.) lies in front and on the mesial side of the anterior cornu, and through it pass the anterior nerve roots. Like the lateral bundle it consists chiefly of association fibres, but it is continued up into the medulla as the posterior longitudinal bundle to the optic nuclei.

The *direct pyramidal tract* (fig. 3, D.P.T.) is a small bundle of the motor fibres from the Rolandic area, which, instead of crossing to the other side at the decussation of the pyramids in the medulla, runs down by the side of the antero-median fissure. Its fibres, however, keep on gradually crossing to the opposite side through the anterior white commissure of the cord, and by the time the mid-thoracic region is reached it has usually disappeared.

The roots of the spinal nerves in the upper part of the canal rise from the cord nearly opposite the points at which they emerge between the vertebrae, but the farther one passes down the higher the origin of each root becomes above its point of emergence. Consequently the lumbar and sacral nerves run a long way down from the lumbar enlargement to their spinal foramina and are enclosed in the dural and arachnoid sheaths to form a mass like a horse's tail, which is therefore known as the *cauda equina*. The relation between the origin of each nerve and the spinous processes of the vertebrae has been worked out by R. W. Reid (*Journ. Anat. and Phys.*, xxiii. 341).

Embryology.—The early development of the neural tube from the ectoderm is outlined in the article on the BRAIN. When the neural groove becomes a tube it is oval in section with a very large laterally

compressed central canal (see fig. 5). The original ectodermal cells elongate and, radiating outward from the canal, are now known as spongioblasts, while the inner ends of some of them bear cilia and so the canal becomes ciliated. A number of round cells, known as germinal cells, now appear close to the central canal, except at the thin mid-dorsal and mid-ventral laminae (roof-plate and floor-plate). From the division of these the primitive nerve cells or neuroblasts are formed and these later on migrate from the region

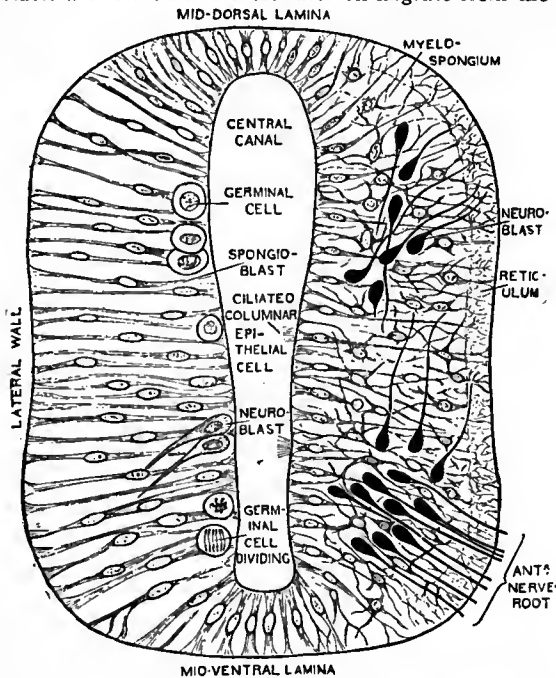

(From D. J. Cunningham in Cunningham's *Text-Book of Anatomy*.)

FIG. 5.—Schema of a Transverse Section through the Early Neural Tube (Young).

The left side of the section shows an earlier stage than the right side.

of the canal and shoot out long processes—the axons. The permanent central canal of the cord was formerly said only to represent the ventral end of the large embryonic canal, the dorsal part being converted into a slit by the gradual closing in of its lateral walls, thus forming the postero-median fissure. A. Robinson, however, does not believe that the posterior fissure is any remnant of the central canal, and there are many points which bear out his contention (*Studies in Anatomy*, Owens College, 1891). The most modern view (1908) is that the fissure is formed partly by an infolding and partly from the original central canal. The antero-median fissure is caused by the ventral part of the cord growing on each side, but not in the mid-line where no germinal cells are.

The anterior nerve roots are formed by the axons of the neuroblasts in the developing anterior cornua, but the posterior grow into the cord from the posterior root ganglia (see NERVE: *Spinal*), and, as they grow, form the columns of Goll and Burdach. That part of the grey matter from which the ventral, anterior or motor nerve roots rise is known as the basal lamina of the cord, while the more dorsal part into which the posterior nerve roots enter is the *alar lamina*. These parts are important in comparing the morphology of the spinal cord with that of the brain.

In the embryo up to the fifth month there is little difference in the appearance of the grey and white matter of the cord, but at that time the fibres in the columns of Burdach acquire their medullary sheaths or white substance of Schwann, the fatty matter of which is probably abstracted from the blood. Very soon after these the basis bundles myelinate and then, in the sixth month, the columns of Goll. Next follow the direct cerebellar tracts and, in the latter half of the eighth month the tracts of Gowers, while the fibres of the pyramidal and Lissauer's tracts do not gain their medullary sheaths until just before or after birth. At first the spinal cord extends as far as the last mesodermal somite, but neuroblasts are only formed as far as the first coccygeal somite, so that behind that the cord is non-nervous and degenerates later into the filum terminale. After the fourth month the nervous portion grows more slowly than the rest of the body and so the long cauda equina and filum terminale are produced. At birth the lower limit of the cord is opposite the third lumbar vertebra, but in post-natal development it recedes still farther to the lower level of the first.

For further details see Quain's *Anatomy*, vol. i. (London, 1908); J. P. McMurrich, *Development of the Human Body* (1906). Most modern descriptions are founded on the writings of W. His, references to which and to other literature will be found on p. 463 of McMurrich's book.

Comparative Anatomy.—In the Amphioxus there is little difference between the spinal cord and the brain; the former reaches the whole length of the body and is of uniform calibre. It encloses a central canal from which a dorsal fissure extends to the surface of the cord and it is composed of nerve fibres and nerve cells; most of the latter being grouped round the central canal or neurocoele, as they are in the human embryo. Some very large multipolar ganglion cells are present, and there are also large fibres known as *giant fibres*, the function of which is not clear.

When the reptiles are reached the cord shows slight enlargements in the regions of the limbs and these become more marked in birds and mammals.

In the lumbar region of birds the dorsal columns diverge and open up the central canal, converting it into a diamond-shaped space which is only roofed over by the membranes of the cord, and is known as the *sinus rhomboidalis*.

In all these lower vertebrates except the Anura (frogs and toads), the cord fills the whole length of the spinal canal, but in the higher mammals (Primates, Chiroptera and Insectivora) it grows less rapidly, and so the posterior part of the canal contains the cauda equina within its sheath of dura mater. In mammals below the anthropoid apes there are no direct pyramidal tracts in the cord, since the decussation of the pyramids in the medulla is complete. Moreover, the crossed tracts vary very much in their proportional size to the rest of the cord in different animals. In man, for example, they form 11.87% of the total cross area of the cord, in the cat 7.76%, in the rabbit 5.3%, in the guinea-pig 3%, and in the mouse 1.14%. In the frog no pyramidal tract is found. It is obvious, therefore, that in the lower vertebrates the motor fibres of the cord are not so completely gathered into definite tracts as they are in man.

A good deal of interest has lately been taken in a nerve bundle which in the lower vertebrates runs through the centre of the central canal of the cord, and takes its origin in the optic reflex cells in close relation to the posterior commissure of the brain. More posteriorly (caudad) it probably acquires a connexion with the motor cells of the cord and is looked upon as a means by which the muscles can be made to actively respond to the stimulus of light. It is known as *Reissner's fibre*, and its morphology and physiology have been studied most carefully in cyclostomes and fishes. It is said to be present in the mouse, but hitherto no trace of it has been found in man. It was discovered in 1860, but for forty years has been looked upon as an artifact.

See P. E. Sargent, "Optic Reflex Apparatus of Vertebrates," *Bull. Mus. Comp. Zool. Harvard*, vol. xlv. No. 3 (July, 1904); also for general details R. Wiedersheim, *Comparative Anatomy of Vertebrates* (London, 1907); Lenhossek, *Bau des Nervensystems* (1895). (F. G. P.)

SURGERY OF THE SPINE AND SPINAL CORD

Fracture of the spine may occur from indirect violence, as when a man falls from a height upon his head, or in a sitting position; or it may result from direct violence, as when he is hanged, or as when he is run over by a loaded van, or in a fall from a height across a beam. The vertebrae above the fracture being displaced from those below it, the spinal cord is generally torn across, and the parts of the trunk, or the limbs, which are supplied by the spinal nerves passing out from the cord below the seat of injury are of necessity cut off from their connexion with the brain, and at once deprived of sensation and of the power of voluntary movement. In some cases of fracture of the spine there is at the time marvellously little constitutional disturbance. The higher up the column that the fracture occurs the more quickly does death ensue. If the fracture is in the middle of the back the patient may linger for several weeks, but even if he is lying upon a water-bed, and even if every care is taken of him, inflammation of the bladder and intractable bed-sores are apt to make their appearance, and his existence becomes truly miserable. Operative surgery is unable to effect much in these cases on account of the spinal cord being generally torn across or hopelessly crushed.

Curvature of the spine may be due to deformity of the bodies of the vertebrae caused by irregular pressure, or to the disintegration of their anterior parts by tuberculous ulceration, known as Pott's disease or spinal caries. Thus the causes of spinal curvature are very different, and it is necessary that the actual condition be clearly recognized or treatment may prove harmful. Briefly, the curvature which is due to tuberculous disease requires absolute and continuous rest; the other calls for well-regulated exercises.

Lateral or rotatory curvature of the spine is a deformity which comes on during the developing period of life, before the bodies of the vertebrae are solidly formed. In young people who are

growing rapidly, and whose muscular system is weak, the bad habit of standing, and throwing the weight of the body constantly on one leg, gives rise to a serious tilting of the trunk; or, if, when writing at a desk, they sit habitually in a twisted position, a lateral curvature of the spine is apt to take place. By constant indulgence in these bad habits the spinal column gets permanently set in a faulty position. Sometimes the tilting of the base of the trunk is due to a congenital or acquired difference in the length of the legs. In the concavity of the curve there is increased pressure, and, necessarily, diminished growth; in the convexity of the curve there is diminished pressure with increased growth. The patient's friends probably notice that one shoulder is higher than the other, or that "the hip is growing out," and unless means are taken to alter the abnormal distribution of pressure, the condition becomes worse, until complete ossification checks the further progress of the deformity. The growth of the subject being completed, the deformity ceases to increase. And when the growth is completed and the bones are solid and misshapen the condition is quite incapable of improvement. The usual curvature is one in which there is a convexity of the spine in the chest-region towards the right, with the right shoulder higher than the left. Compensatory curves in the opposite direction form in the loins and neck. Along with the lateral bending of the spine a rotation of the bodies of the vertebrae towards the convexity of the curve takes place, the spinous processes turning towards the concavity of the curve. Since the line of the spinous processes of the vertebrae can be easily traced through the skin, their deviation may mislead the superficial observer as to the actual amount of the curvature.

To counteract this deformity in the earliest stages (and it is in the early stage that treatment effects most), the patient (generally a girl) should be encouraged to walk perfectly erect. Systematic exercises, to strengthen the muscles of the back, ought to be strictly and persistently carried out under the direction of a surgeon with the assistance of a skilled instructor of gymnastics. During the intervals of rest the child should lie upon her back on a firm board, and should avoid taking exercise which gives rise to weariness of the muscles; for whenever the muscles become wearied she will attempt to take up a position which throws the strain on to her ligamentous and bony structures. One of the best exercises is to lay the patient on her face, fix her feet, and encourage her to raise herself by using the muscles of the back. Whilst she hangs from a trapeze the weight of the lower limbs and pelvis will help to straighten the spine as a whole, necessarily diminishing the increased pressure upon the cartilaginous bodies of the vertebrae towards the concavity, and increasing the pressure between the sides of the bodies towards the convexity. It is often a good thing to remove a girl with commencing lateral curvature from the sedentary life of school or town and to let her run wild in the country, exercising her muscles to the full.

If the deformity is due to inequality in the length of the legs, a high boot on the short leg may correct it. In some cases of lateral curvature a tilted seat is useful. Mechanical "spinal supports" are as expensive as they are inefficient. As a rule, indeed, they are positively harmful, in that they add to the weight of the trunk and hinder needful muscular development.

By *kyphosis* is meant an exaggerated degree of roundness of the shoulders. It can be effaced only by constant drillings and exercises whilst the spinal column is still plastic. When once the bones are solid no great improvement is possible. The deformity is sometimes due to short sight. It is well, therefore, to have the child's vision duly tested.

Lordosis is an exaggeration of the normal concavity of the loin-region of the spine. It is most often met with in those cases in which from congenital displacement of the head of the thigh bone, or from old disease of the hip-joint, the subject has acquired the habit of throwing the shoulders back in order to preserve the balance.

Tuberculous disease of the spine (Pott's disease), is the result of a deposit of tubercle-germs in the body of the vertebra.

Inflammation having thus been set up, ulceration (caries) of the vertebra, or of several vertebrae, occurs, and if the case runs on unchecked extensive abscesses may form in the thigh, loin or groin. The trouble is often begun by a blow or by a sprain of the spine, which, by lowering the power of resistance of the delicate bone, prepares it for the bacillary invasion. The earliest symptoms are likely to be a dull aching in the back with stiffness of the spine. The child complains of being tired, and is anxious to lie down and be left quiet whilst his little companions are running about. If the disease is in the middle part of the spine, pains are complained of in the front of the chest or at the pit of the stomach. Unfortunately such pains are often ascribed to indigestion. If the disease is in the upper part of the spine the pains may be in the head, the shoulders or the arms. If in the loin-region of the spine they are in the lower part of the trunk, the thighs or the legs. (These obscure peripheral pains are often misunderstood and are apt to be attributed to rheumatism). The back is stiff so that the child cannot stoop. In trying to pick up anything from the floor he keeps his back straight and bends his knees. If the disease is in the neck-region he cannot easily look upwards, and, instead of turning his head to look sideways, he wheels round his whole body. In some cases, though the disease is far advanced, there have been no complaints of pain in the back. As the bodies of the vertebrae crumble away, the spine bends forwards under the influence of the weight of the head and of the upper part of the trunk, and a projection may appear in the middle line of the back. In the neck, and in the loin-region, the projection is rarely well marked, but in the chest-region a conspicuous boss may make its appearance—the "hump-back." The projection is often spoken of as an *angular curvature*—a contradiction in terms, for a thing which is angular is not curved. When the deformity is great there may be pressure upon the spinal cord with more or less paralysis in the parts below.

The treatment of tuberculous disease of the spine demands absolute and uninterrupted rest. The best thing is to put the patient flat on his back for as many months as may be found necessary, but not in a close bedroom. If he is compelled to lie in a bedroom the windows should be open night and day. If the patient is a child, he should be laid flat in a box-splint, or upon a thin horsehair mattress, and should be carried out of doors every day—but always lying flat. When the pressure-symptoms, such as the pains in the legs, thighs or arms, the "belly-ache," or the pains in the chest or neck have passed away, a firm leather splint may be moulded on to keep the parts quiet until consolidation has taken place, or a cuirass of poroplastic felt or of plaster of Paris may be applied. The danger in these cases is of leaving off treatment too soon: they must not be hurried, or the trouble will be likely to come back again with, perhaps, increased deformity. If the disease is in the upper part of the dorsal spine, or in the neck-region, a cervical collar of leather, or a double Thomas's hip-splint may be found useful.

In cases of advanced tuberculous disease of the spine, in which the spinal cord is compressed within its bony canal either by the posterior parts of the vertebral bodies or by inflammatory products, or in which, after severe injury, the cord is pressed upon by a displaced piece of bone, the surgeon may think it expedient to open the spinal canal from behind, removing in the procedure the posterior arches (laminae) of the vertebrae. The operation is called by the hybrid word *laminectomy*. Sometimes in the case of tuberculous disease, where the propriety of resorting to the operation is being discussed, the symptoms of the compression begin to clear off and the child makes a complete recovery without being operated on; the moral is that we should wait patiently and give Nature a full chance of doing her work in her own way. The operative treatment of these cases is not highly satisfactory. Still, there are a certain small number of cases in which it may be given a trial.

The treatment of spinal abscess has been greatly influenced by the Listerian method. The collection of broken-down tuberculous material or fluid is not an *abscess* in the usual sense, for it does not contain "pus" or "matter," being, as a rule, destitute of septic micro-organisms. A spinal abscess is therefore no longer drained: it is incised, scraped, washed out, and swabbed dry, the opening being carefully and permanently sewn up. In this way septic germs are effectually excluded from the cavity, and the patient is spared the depressing and tedious discharging of the cavity which so often followed the old methods of treatment. It must be clearly understood, however, that every spinal abscess does not undergo cure after being subjected to the evacuation and closure treatment mentioned

above, but that the surgeon is sometimes compelled to use irrigation and drainage.

In 1897 Dr Calot of Berk-sur-Mer reintroduced the method of straightening out the hump of the back, so often left after disease of the spine, by stretching the child on a flat table and dealing with the hump, under chloroform, with what is commonly known as "brute force." A considerable number of hump-backed children on the Continent as well as in England and America were thus dealt with, but it is doubtful whether the records of those cases, could they all be collected and published, would be found to justify the enthusiasm and publicity with which the method was inaugurated and its details were spread abroad. It is scarcely necessary to say that the forcible straightening of a spine which has developed a hump because tuberculous disease has wrecked the front of the vertebral segments is in no sense a *curative* operation. Diminishing the size of the projection does not cure the tuberculous ulceration of the bones; indeed, it may increase the ulcerative process or determine a scattering of the germs of tubercle throughout the body. The operation has not been accepted by British and American surgeons. In the practice of the foreign surgeon death ensued in three cases out of thirteen that were operated on, and an English surgeon reported fourteen cases "in all of which the deformity had recurred although the spines had been fixed in plaster of Paris after the straightening."

Being deeply placed in the mass of the muscles of the back, and, moreover, being jealously locked within the bony canal of the vertebral column, the spinal marrow or spinal cord was, until the last few years, generally considered to be beyond the reach even of the most enterprising surgeon. Still, like other tissues, it was liable to diseases and injuries. The exact situation of a tumour pressing upon the spinal cord can now be located with great precision by noting the areas of pain and numbness, and the height in the limbs or trunk to which loss of power of voluntary movement ascends, and by noting also whether these effects are symmetrical upon the two sides or appear more upon one side than on the other. By cutting away the posterior parts of certain segments of the vertebral column, tumours of various sorts have been successfully removed from the interior of the canal. Displaced fragments of bone in tuberculous affection of the spine, abscess-contents and inflammatory tissue have also been similarly dealt with. Sir William Macewen of Glasgow and Sir Victor Horsley of London have been pioneers in this development of surgery. In cases of fracture of the spine, with displacement of the vertebrae and compression of the spinal cord, surgeons have also been trying what relief can be afforded by the adoption of bold operative measures, but as in most of these cases of fracture-dislocation the spinal cord is torn right across or crushed beyond hope of repair, active measures cannot be undertaken with much prospect of success.

"*Concussion of the Spine.*"—Occasionally one hears persons, whose professional education should have taught them better, speaking or writing of concussion of the spine as if that were in itself a disease. It is an expression which is not infrequently used in an equally comprehensive and incorrect way when the ill-informed person is speaking of the injuries, real or imaginary, of which an individual makes complaint after having met with a severe shake when travelling on a railway. One might as well speak of concussion of the skull as of concussion of the spine, for the spine is but the bony envelope of the spinal cord, as the skull is of the brain. The violent shaking of the spinal cord and the spinal nerves in a serious accident may, however, be followed by some functional disturbance, which may be associated with pains in the back, by numbness and tingling in the limbs, or with muscular weakness. In some cases the disturbance is due to slight haemorrhages into the nerve sheaths, which may clear up with rest and quiet. But when the presence of these obscure symptoms, after a railway accident for instance, becomes the subject of an action-at-law, there is a great chance that they will not pass off until the case is settled in one way or the other. Not, perhaps, that the individual concerned is dishonest in his estimation of them, but because the anxiety of the overhanging lawsuit has so grievously disturbed his mind and altered his perspective that his sense of proportion is for a time in abeyance. After the action-at-law the symptoms may clear up with a rapidity which to some people appears surprising. (E. O.)*

PHYSIOLOGY OF THE SPINAL CORD

The name spinal cord, given by early morphologists to the nervous mass lying in the tubular chamber enclosed by the vertebral column, was doubtless given under the supposition that the organ so named could be treated as an entity. Scientifically, however, it cannot be so treated, either as regards its

structure or its function. It is merely a part of that great nervous structure which throughout the length of the body forms the central meeting-place of the nerve-paths arriving from and issuing to all regions with which nerve fibres are in touch. To separate from the rest of this system the part which lies within the spine is an artificial and in many ways misleading provision. This artificial treatment is the outcome of crude ideas drawn from the study of merely the gross form of the bodily parts. But crude as the distinction is, its historic priority has influenced the study of the vertebrate nervous system, not only in regard to morphological description but also in regard to exposition of the functional reactions of the nervous system and even up to the present day. Hence it is still customary arbitrarily to detach certain of the reactions of the nervous system into a separate group and describe that group by itself, simply because they occur in nervous arcs whose central courses in the great central nervous organ lie within that part of it extending along the spine. An additional inconvenience attaching to the mode of description of the nervous system customary in works on human anatomy, is that in such works the parts of the nervous arcs outside the central organ are described apart from it under the term peripheral nerves. This severs artificially structures which are functionally indissolubly united. The study and description of the working of the nervous system is hampered by this unphilosophic subdivision of its structural parts.

To gain a broader and truer point of view as starting-point for understanding the working of the spinal cord one must prepare the exposition by a short reference to the general function of the nervous system in the bodily economy.

Relation to General Nervous System.—An animal of microscopic size may continue throughout its life to be constituted entirely by one single cell. Animals of larger bulk, although each begins its existence as a single cell, attain their development by the multiplication of the original single cell, so that from it there comes to be formed a coherent mass of cells very many millions in number. In these multicellular animals each of the constituent cells is a minute self-centred organism, individually born, leading its own life and destined for individual death. The corporate power of the complex animal is the sum of the powers of those manifold individual existences, its cells. In the complex animal the several organs, even the most homogeneous, such as muscles or glands, are each composed of many thousands of cells similarly specialized but living each *per se*. The solidarity of action which a complex animal thus built up exhibits is the result of the binding together of the units which compose the complex organism. Of the agencies which integrate the complex animal, one of the most potent is nervous action. A certain number of the unit cells composing the animal are specially differentiated from the rest to bind the whole together by nervous action. These specially differentiated cells are called "neurons." They constitute living threads along which waves of physico-chemical disturbance are transmitted to act as releasing forces for the energy in distant cells, where they finally impinge.

It is characteristic of this nervous system, the system of neurons, that, although ramifying far and wide through the body, it is a continuum from end to end. The peripheral nerves are formed of bundles of neurons lying side by side, but these, although packed close together, are strictly isolated one from another as conductors and remain isolated throughout the whole length of the nerve. The points of functional nexus of the neurons one with another are confined to one region only of the whole system. All their conductive connexions one with another take place solely in the central nervous mass which constitutes the so-called central nervous system, a nervous organ extending axially along the length of the body midway between the body's lateral halves. Thither the neurons converge in vast numbers, those of each body segment converging to that fraction of the central organ which belongs to their body segment. The central nervous organ thus receiving these neurons is, where it lies in the head, called

the brain, the rest of it is called in vertebrates the "spinal cord," in vermes and arthropods the "nerve-cord." The central organ not only receives neurones which converge to it from outside, but many of its own neurones thrust out their conductive arms from it as nerve fibres carrying nervous influence outwards to regulate the activity of glands and muscles. In the vertebrata the ingoing neurones for each segment and similarly the out-going neurone fibres are collected into a segmental nerve. To the spinal cord these are each attached by two roots, one dorsal, consisting of the afferent fibres, the other ventral, consisting of the efferent fibres.

The Reflex.—Analysis of function of this nervous system leads to what is termed "the reflex" as the unit of its action. The simplest complete reaction of the system is a reflex. There are many reflexes which are extremely complex, being built up of a number of simpler reflexes combined together. A reflex is a reaction started by the environment acting as a stimulus upon some nerve which communicates the excitement thus started in itself to other nerves by means of its connexions with these in the central nervous organ. The excitement so generated and transmitted finally travels outward from the central organ by one or more of the efferent nerves and through these reaches muscles or glands producing in them its final effect. The muscles and glands are from this point of view termed effector organs. The reaction is therefore "reflected" from the central organ. The nerve structures along which it runs in its trajectory are spoken of as a nervous arc. The whole purpose of the central nervous organ is therefore to bring afferent neurones into touch with efferent neurones. The whole purpose of reflex arcs is to bind one part of the organism to another part in such a way that what the environment is doing to the organism at one place may appropriately call forth or restrain movement or secretion in the muscles or glands possessed by the organism.

Receptor Cells.—There is one condition for the due performance of these reactions which is not provided by the nervous system itself. The afferent neurones are not in most cases so constituted as to be excitable themselves directly by the environment—for instance, they cannot be stimulated by light. Their amenability to the environment, their sensitization to environmental agencies, is effected by special cells adjunct to their peripheral ends. These cells from organs are called *receptors*. They are delicately adapted to be stimulated by this or that particular agent and are classifiable into various species, so that each species is easily excited by a particular agent which is "adequate" for it, and is quite inexcitable or only excitable with difficulty by agencies of other kinds. Thus in the skin some receptors are adapted for mechanical stimuli (touch) and not for thermal stimuli, while others (cold spots, warm spots) are adapted for thermal stimuli and not for mechanical. As far as it is known each afferent neurone is connected with receptors of one species only. The receptors thus confer upon the reflex arcs selective excitability. Each arc is thus tuned to respond to certain stimuli, while other arcs not having that kind of receptor do not respond. The receptors, therefore, while increasing the responsiveness of the organism to the environment, prevent confusion of reactions (inco-ordination) by limiting to particular stimuli a particular reaction.

Proprioceptors.—The system of neurones is thus made accessible to the play of the external world acting on the body. And in addition to those receptors which are stimulated directly by the external world, are others lying within the mass of the organism itself, which are excitable by actions occurring in the organism itself. These are called *proprioceptors*. They are distributed preponderantly in the muscles and structures functionally adjunct to muscle, such as joints, ligaments, fasciae, &c. The reactions induced in such motor structures reflexly in response to environmental stimuli tend therefore secondarily to be followed and accompanied by reflex reactions initiated from proprioceptors.

Conduction.—The process by which the excitement generated in the afferent neurone travels along the reflex arc is known as *conduction*. Conduction along afferent and efferent nerves

differs in some important respects from that obtaining in the nerve centre, *i.e.* in the piece of the central nervous system connecting the afferent nerve with the efferent nerve. In a nerve-trunk the excited state set up in it by a stimulus travels along its fibres as wave-like disturbance at a speed of about thirty-three metres per second, and does not alter in intensity or speed in its travel. A nerve-trunk when excited (artificially) at some point along its length transmits the "impulse," *i.e.* the wave-like excited state in both directions, *i.e.* both up and down each fibre, from the point stimulated. This is true whether the fibre is afferent or efferent. The speed of travel of the nervous impulse along the nerve-trunk is practically the same whether the state of excitement, *i.e.* nervous impulse, is weak or intense. The nerve-trunk shows practically no delay in its response to an effective even though weak stimulus and its response ceases practically at once on cessation of the exciting stimulus. When excited by repeated brief stimuli the rhythm of the response corresponds closely with that of the stimuli, even when the frequency of the latter is as high as 100 per second. With momentary stimuli a response even so brief as 2σ can be given by the nerve-trunk. Finally, nerve-trunk conduction is singularly resistant to fatigue, to impoverished blood supply, and to many drugs which powerfully affect reflex actions.

In conduction through the central nervous organ the travel of the nervous impulse exhibits departure from these features. Its intensity is liable to be altered in transit. Its time of transit, especially if it be weak, is much longer than for a similar length of nerve-trunk. Its direction of transmission becomes polarized, that is, confined to one direction along the nervous path. The state of excitement engendered does not subside immediately on cessation of the stimulus, and may outlast the stimulus by many seconds. The rhythm of response to a rhythmic stimulus does not change in correspondence with change in the stimulus-rhythm. A response, however brief the stimulus, is probably never shorter than 50 in duration.

These are striking differences, and morphological study of the structural features of the central organ does not at present suggest how they for the most part arise. It seems certain, however, that in the central organ it is that part which consists of so-called grey matter which forms the place of their occurrence. There the spread of the impulse from one nerve-fibre to others seems clearly due to the fact that each afferent fibre breaks up into branching threadlets which ramify in various directions and terminate in close apposition with other neurones. There has been much dispute as to whether the termination is one of contiguity with the next neurone or of actual continuity with it. The result of recent investigation seems to show that in the vast majority of cases contiguity and not actual homogeneous continuity is the rule in the spinal cord. The point of nexus of one neurone with another is termed the synapse. If synopsis occurs by contiguity and not homogeneous continuity, it is fair to suppose that at it the transmission of nervous impulses must be different from that observable in the homogeneous conducting threads of nerve fibres. The conduction must traverse something of the nature of a membrane. To the properties of synaptic membranes many of the features peculiar to conduction in the grey matter may be due, for instance, the feature of irreversible direction of conduction.

Reflex Reactions.—When the spinal cord is severed at any point the reflex arcs of the portion of the body behind the transection are quite cut off from the rest of the nervous system in front, including the brain. The reflex reactions elicited from the thus isolated region cannot therefore be modified by the action of the higher nervous centres. It is important to see what character these reflexes possess. The higher centres in the brain exercise powers over the motor machinery of the body and in doing so make use of the simpler nervous centres that belong to the segments severally, that is the local nervous centres existing for and in each body segment itself. In the head the local centres are overlaid by higher centres which cannot by any simple severance be separated from them. By studying, therefore, the powers of the cord behind a complete

spinal transection we can obtain in a comparatively simple way information as to the powers of the purely local or segmental reflex mechanisms.

The so-called "flexion-reflex" of the limb is one of the most accessible of the local reflex reactions which can thus be studied with an isolated portion of the spinal cord as its centre.

Let it be supposed that the limb observed is the hind limb. The three main joints of the limb are the hip, the knee and the ankle. Each of these joints is provided with muscles which flex or bend it, and others which extend or straighten it. It is found that the reflex throws into contraction the flexor muscles of each of these joints. It matters little which of all the various afferent nerves of the limb is stimulated, whichever of these the afferent nerve may be, the centrifuged discharge from the cord goes to practically the same muscles, namely, always to the flexors of the joints.

The centrifuged discharge does not go to the extensor muscles of the limb. However strong the stimulus and however powerful the afferent nerve chosen the spinal centre does not discharge impulses into the extensor muscles, though these muscles receive motor nerves issuing from the very same region of the cord as that supplying motor nerves to the flexor muscles. Not only does the reflex action not discharge motor impulses into the nerves of the extensor muscles, but if the spinal cord happens to be discharging impulses into these nerves when the reflex is evoked this discharge is suppressed or diminished (*inhibited*). The result is that when the reflex occurs not only are the flexor muscles made to contract, but their antagonists, the extensors, are, if in contraction at the same time, thrown out of contraction, that is, relaxed. In this way the latter muscles are prevented from impeding the action of the contracting flexors. This inhibition occurs at the beginning of the reflex action which excites the muscles and continues so long as the flexion-reflex itself continues. It thus prevents other reflexes from upsetting for the time being the due action of the flexion-reflex, for it renders the muscles opposing that reflex less accessible to motor discharge through the spinal cord whatever the quarter whence incitation to that discharge may come.

A feature of this reflex is its graded intensity. A weak stimulus evokes in the flexor muscles a contraction which is weak and in the extensor muscles a relaxation which is slight. Not only is the contraction weak in the individual flexor muscles, but it is limited to fewer of them, and in large muscles seems to involve only limited portions of them.

The duration of the reflex similarly varies directly with the duration of the exciting stimulus applied to the afferent nerve. The time relations of electrical stimuli can be controlled by the experimenter with much precision. In the single induction shock he has at command a stimulus of extreme brevity, lasting only a few millionths of a second. With such stimulus a lower limit is soon found to the brevity of the reflex effect as expressed by muscles. It is found difficult to evoke with brief stimuli reflex contractions so brief as those evoked from the muscle by similar stimuli applied direct to the motor nerve of the muscle. There is reason to think that such stimuli applied to a nerve may evoke one single nerve-impulse. A single nerve impulse generated in a motor nerve causes in the muscle a brief contraction which is called a twitch, and lasts a tenth of a second. A single nerve impulse generated in an afferent nerve sometimes fails on arriving at the spinal centre to evoke any observable reflex effect at all, but if it is effective the muscle contraction tends to be longer than a "twitch," often much longer. It is therefore questioned whether the spinal centre when excited even most briefly ever discharges one single centrifugal impulse only; it seems usually to discharge a short series of such impulses.

Allied to this character is the tendency which even simple spinal reflexes exhibit to continue discharging for a certain time after their exciting stimulus has ceased to be applied. This after-discharge succeeding a strong stimulus may persist even for several seconds.

Refractory Phase.—Besides characters common to all or many

spinal reflexes certain spinal reflexes have features peculiar to themselves or exhibited by them in degrees not obvious in other reflexes. One of these features is refractory phase. The scratch-reflex exemplifies this. In the dog, cat, and many other animals the hind limb often performs a rapid scratching movement, the foot being applied to the skin of the shoulder or neck as if to groom the hairy coat in that region. This movement is in the intact animal under control of the brain, and can be executed or desisted from at will. When certain of the higher centres in the brain have been destroyed, this scratching action occurs very readily and in, as it were, an uncontrolled way. When the spinal cord has been severed in the neck this scratching movement of the hind limb can be elicited with regularity as a spinal reflex by merely rubbing the skin of the side of the neck or shoulder, applying there a weak electric current to the skin. In this reflex the stimulus excites afferent nerves connected with the hairs in the skin and these convey impulses to the spinal centres in the neck or shoulder segments, and these in turn discharge impulses into nerve fibres entirely intraspinal passing backward along the cord to reach motor centres in the hind limb region. These motor centres in turn discharge centrifugal impulses into the muscles of the hind limb of the same side of the body as the shoulder which is the seat of irritation. The motor discharge is peculiar in that it causes the muscles of the hind limb to contract rhythmically at a rate of about four contractions per second, and the discharge is peculiar further in that it excites the flexor and extensor muscles of the joints alternately so that at the hip for instance the limb is alternately flexed and extended, each single phase of the movement lasting about an eighth of a second. Now this rhythmic discharge remains the same in rate whether the exciting stimulus applied to the skin be continuous or one of many various rates of repetition. Evidently at some point in the reflex arc there is a mechanism which after reacting to the impulses reaching it remains for a certain brief part of a second unresponsive, and then becomes once more for a brief period responsive, and so on. And this phasic alternation of excitability and inexcitability repeats itself through the continuance of the reflex even when that endures for minutes. The phase of inexcitability is termed the refractory phase. It is important as an essential element in the co-ordination; without it the scratching movement would obviously not be obtained for alternation of flexion and extension is essential to the act. A similar element almost certainly forms part of the co-ordinating mechanism for many other cyclic reflexes, including those of the stepping of the limbs, the movement of the jaw in mastication, the action of the eyelids in blinking, and perhaps the respiratory movements of the chest and larynx.

Fatigue.—Nerve trunks do not easily tire out under stimulation even most prolonged. Reflex actions on the other hand relatively soon tire. Some are more resistant, however, than are others. The flexion-reflex may be continued for ten minutes at a time and the scratch-reflex can be maintained so long. As a reflex tires, the muscular contraction which it causes tends to become less intense and less steady. The relatively rapid onset of fatigue in reflexes is counterbalanced by speedy recovery in repose. A long flexion-reflex, when from fatigue it has become weak, tremulous and irregular, will recommence after 30 seconds' repose with almost the same vigour and steadiness as if it had not recently been tired out.

This character of reflexes is in accordance with their executing movements which for the most part are not under natural circumstances required to last long. Such movements are the taking of a step by a limb, the movement of the jaw in mastication, the descent of the diaphragm in breathing, the withdrawal of the foot or the pinion from a noxious stimulus or the movement of the eyelids to wash off a particle touching the cornea, in all these no very prolonged reflex discharge is required. These natural movements to which the artificially provoked reflexes seem to correspond do not demand prolonged motor activity, or when they do, demand it in rhythmic repetition with intervening pauses which allow repose.

Reflex Postures.—But there are certain reflexes which do persist for long periods at a stretch. These are reflex postures. The hind limbs of the "spinal" frog assume an attitude which is reflex, for it ceases on severance of the afferent spinal roots. This attitude is one of flexion at hip, knee and ankle, resembling the well-known natural posture of the frog as it squats when quiet in the tank. Similarly in the "spinal" dog or cat certain muscles exhibit a slight but persistent contraction. This is seen well in the extensor muscles of the knee. These tonic reflexes are related to attitudes. In the dog and cat they are exhibited by those muscles whose action antagonizes gravity in postures which are usual in the animal, thus the extensors of the knee and hip and shoulder and elbow are in tonic contraction during standing. The reflex arcs concerned in reflex maintenance of this tonic contraction of muscles have been shown in several cases to arise within those muscles, and in those very muscles which themselves exhibit the tonic contraction. It is not, however, certain that all muscles exhibit a reflex tonus; for instance, it is not certain that in the dog the tail muscles exhibit such a tonus. And in those muscles which do exhibit the spinal reflex tonus attempts to obtain a similar untiring slight steady reflex contraction by artificial stimuli applied to receptive organs or nerves have failed.

The Spinal Reflex Arcs of the Hind Limb.—When the skin of the limb is stimulated the flexion-reflex already described is evoked. The reflex is excited by nocuous stimuli such as a prick or squeeze applied to the skin anywhere in the limb, but most easily when applied to the foot. Electrical stimuli wherever applied evoke the same reflex. Similarly electrical stimuli applied to any afferent nerve of the limb evoke this reflex, whether the afferent nerve be from skin or from the muscles. Since the reflex always provokes excitation of the flexor muscles and inhibition of the extensor muscles, the result is that central stimulation of the afferent nerve of a flexor muscle excites its own muscle and inhibits its antagonist (reciprocal innervation), while similar stimulation of the afferent nerve of an extensor muscle inhibits its own muscle and excites its antagonist (reciprocal innervation). The reflex flexion of the ipsilateral hind limb is commonly accompanied by reflex extension of the opposite hind limb. If the reflex spreads to the fore limb, it produces extension of the same side fore limb with flexion of the crossed fore limb sometimes, but sometimes extension of both fore limbs.

In the dog and cat extension of the ipsilateral hind limb can, however, be excited by stimulation of the skin in three limited regions. One of these is the sole of the foot; smooth pressure between the pads excites a strong brief extension. This is called the extensor thrust. It is accompanied by a similar sudden brief extension of all three other limbs. This reflex may be related to the action of galloping, and the pressure which excites resembles that which the weight of the body bears on the pads against the ground.

The two other regions are the skin of the front of the groin supplied by the crural branch of the genito-crural nerve, and the skin just below and mesial to the buttock. These always excite the extensor muscles, not the flexors. They may be concerned with sexual acts.

Reflexes of the Fore Limb.—These resemble those obtainable from the hind limb. The ipsilateral reflex is flexion at shoulder, elbow and wrist. The contra lateral fore limb at the same time is extended at shoulder, elbow and wrist. When the reflex spreads to the hind limbs the hind limb of the same side is extended at hip, knee and ankle, that of the crossed side is sometimes flexed at hip, knee and ankle, but sometimes is instead extended at hip, knee and ankle. The reflex sometimes spreads to the neck, causing the head to be turned toward the fore limb, which is the seat of the stimulation.

The Scratch Reflex.—This has already been partly described above. The area from which it can be excited by appropriate stimulation is a large one, namely, a field of skin which is somewhat saddle-shaped having its greatest width transversely across the shoulders. It extends from close behind the pinna

back to the loin. The stimuli which are effective are rubbing the skin or lightly pricking it, or lightly pulling on the hairs: also faradisation by a needle electrode whose point is only just inserted among the hairs but not deeper than their roots. If the stimulus be applied to the right hand of the mid-line the right hind limb is flexed at hip and performs the rapid scratching movement described above, and the left hind limb is thrown into steady extension. And conversely, when the stimulus is to the left side of the mid-line.

Each of these reflexes is a co-ordinate reaction. It is seen, therefore, that through the medium of the spinal cord the body behind the head has at command a certain number of reflexes and that each of these manages the skeletal musculature in a co-ordinate way. It will also be clear from the facts mentioned above about these separate reflexes that the fields of muscles worked by these several reflexes is to a large extent common to them all. Thus the reflex excited from the skin of the right hind limb acts on the muscles of that limb and also on those of the three other limbs. So similarly the reflex excited from the left hind limb, and from each fore limb. Study of the inter-relationship between these reflexes shows that by means of the spinal cord not only is co-ordinate action of the muscles ensured for each reflex, but that also the separate reflexes are co-ordinated one with another.

When we examine the relationship holding between individual reflexes we find that some resemble one another in regard to their action upon a particular muscle or group of muscles. On the other hand, some act in opposite ways upon a particular muscle or muscle group. In order to follow the co-ordination effected by the spinal cord in corresponding reflexes together we have to turn to a certain feature in the scheme of construction of the nervous system. This feature is embodied in what is termed the principle of the common path.

Interaction between Reflexes.—At the commencement of every reflex-arc is a receptive neurone extending from the receptive surface to the central nervous organ. This neurone forms the sole avenue which impulses generated at its receptive point can use whithersoever be their destination. This neurone is therefore a path exclusive to the impulses generated at its own receptive point, and other receptive points than its own cannot employ it. A single receptive point may play reflexly upon quite a number of different effector organs. It may be connected through its reflex path with many muscles and glands in many different regions. Yet all its reflex arcs spring from the one single shank or stem, *i.e.* from the one afferent neurone which conducts from the receptive point at the periphery into the central nervous organ.

But at the termination of every reflex arc we find a final neurone, the ultimate conductive link to an effector organ, (muscle or gland). This last link in the chain, *e.g.* the motor neurone, differs obviously in one important respect from the first link of the chain. It does not subserve exclusively impulses generated at one single receptive source, but receives impulses from many receptive sources situate in many and various regions of the body. It is the *sole* path which all impulses, no matter whence they come, must travel if they are to act on the muscle fibres to which it leads.

Therefore, while the receptive neurone forms a private path exclusively serving impulses of one source only, the final or efferent neurone is, so to say, a public path, *common* to impulses arising at any of many sources of reception. A receptive field, *e.g.* an area of skin, is analysable into receptive points. One and the same effector organ stands in reflex connexion not only with many individual points, but even with many various receptive *fields*. Reflexes generated in manifold sense-organs can pour their influence into one and the same muscle. Thus a limb muscle is the *terminus ad quem* of many reflex arcs arising in many various parts of the body. Its motor nerve is a path common to all the reflex arcs which reach that muscle.

Reflex arcs show, therefore, the general features that the initial neurone of each is a *private* path exclusively belonging to a single receptive point (or small group of points); and that

finally the arcs embouch into a path leading to an effector organ; and that their final path is common to all receptive points where-soever they may lie in the body, so long as they have connexion with the effector organ in question. Before finally converging upon the motor neurone the arcs converge to some degree. Their private paths embouch upon *internuncial* paths common in various degree to groups of private paths. The terminal path may, to distinguish it from internuncial common paths, be called *the final common path*. The motor nerve to a muscle is a collection of final common paths.

Certain consequences result from this arrangement. One of these is the preclusion of essential qualitative difference between nerve-impulses arising in different afferent nerves. If two conductors have a tract in common there can hardly be essential qualitative difference between their modes of conduction; and the final common paths must be capable of responding with different rhythms which different conductors impress upon it. It must be to a certain degree aperiodic. If its discharge be a rhythmic process, as from many considerations it appears to be, the frequency of its own rhythm must be capable of being at least as high as that of the highest frequency of any of the afferent arcs that play upon it; and it must be able also to reproduce the characters of the slowest.

A second consequence is that each receptor being dependent for final communication with its effector organ upon a path not exclusively its own but common to it with certain other receptors, such nexus necessitates successive and not simultaneous use of the common path by various receptors using it to *different or opposed* effect. When two receptors are stimulated simultaneously, each of the receptors tending to evoke reflex action that for its end-effect employs the same final common path but employs it in a different way from the other, one reflex appears without the other. The result is *this* reflex or *that* reflex, but not the two together.

In the simultaneous correlation of reflexes some reflexes combine harmoniously, being reactions that mutually reinforce. These may be termed *allied reflexes*, and the neural arcs which they employ *allied arcs*. On the other hand, some reflexes, as mentioned above, are antagonistic one to another and incompatible. These do not mutually reinforce, but stand to each other in inhibitory relation. One of them inhibits the other, or a whole group of others. These reflexes may in regard to one another be termed *antagonistic*; and the reflex or group of reflexes which succeeds in inhibiting its opponents may be termed "prepotent" for the time being.

Allied Reflexes.—The action of the principle of the final common path may be instanced in regard to "allied arcs" in the scratch-reflex as follows. If, while the scratch-reflex is being elicited from a skin point at the shoulder, a second point distant 10 mm. from the other point but also in the receptive field of skin, be stimulated, the stimulation at this second point favours the reaction from the first point. This is well seen when the stimulus at each point is of subminimal intensity. The two stimuli, though each unable separately to invoke the reflex, yet do so when applied both at the same time. This is not due to overlapping spread of the feeble currents about the stigmatic poles of the two circuits used. Weak cocainization of either of the two skin poles annuls it. Moreover, it occurs when localized mechanical stimuli are used. It therefore seems that the arcs from the two points, e.g. R_a and R have such mutual relation that reaction of one of them reinforces reaction of the other, as judged by the effect on the final common path.

This reinforcement is really an instance of summation in the final common path. So also is the effect to which Exner has given the name of "bahnung" a phenomenon of frequent occurrence in reflex reactions. Suppose a stimulus (A) be applied which is too weak to elicit the reflex which were it stronger it could evoke. It is found that a second stimulus (B) also of itself too weak to evoke the reflex, will evoke the reflex if applied at a short interval after the application of (A). The two stimuli sum in their effect upon the final common path. The "receptive field" of a reflex is really the common area of

commencement of a number of allied arcs. And reflexes whose arcs commence in receptive fields even widely apart may also have "allied" relation. In the bulbo-spinal dog stimulation of the outer digit of the hind foot will evoke reflex flexion of the leg, and stimulation of each of the other digits evokes practically the same reflex; and if stimulation of several of these points be simultaneously combined the same reflex as a result is obtained more readily than if one only of these points is stimulated. And to these stimulations may be added simultaneously stimulation of points in the crossed fore foot; stimulation there yields by itself flexion of the hind leg; and under the simultaneous stimulation of fore and hind foot the flexion of the leg goes on as before, though perhaps more readily; that is, the several individual reflexes harmonize in their effect on the hind limb. Further, to these may be added simultaneous stimulation of the tail and of the crossed pinna; and the reflexes of these stimulations all coalesce in the same way in flexion of the hind limb. Exner has shown that, in exciting different points of the central nervous system itself, points widely apart exert "bahnung" for one another's reactions and for various reflex reactions induced from the skin. Thus reflexes originated at different distant points, and passing through paths widely separate in the brain, converge to the same motor mechanism (final common path) and act harmoniously upon it. Reflex arcs from widely different parts conjoin and pour their influence harmoniously into the same muscle. The motor neurones of a muscle of the knee are the *terminus ad quem* of reflex arcs arising in receptors not only of its own foot, but from the crossed fore foot and pinna and tail, also undoubtedly from the otic labyrinth, olfactory organs and eyes. Thus, if we take as a standpoint any motor nerve to a muscle it consists of a number of motor neurones which are more or less bound into a unit mechanism among the reflex actions of the organism a number can all be brought together as a *group*, because they all in their course converge together upon this motor mechanism, this *final common path*, activate it, and are in harmonious mutual relation with regard to it. They are in regard to it what were termed above "allied" reflexes.

Antagonistic Reflexes.—But not all reflexes connected to one and the same common final path stand to one another in the relation of "allied reflexes." Suppose during the scratch-reflex a stimulus be applied to the foot not of the scratching side, but of the opposite side. The left leg, which is executing the scratch-reflex in response to stimulation of the *left* shoulder skin is cut short in its movement by the stimulation of the *right* foot, although the stimulus at the shoulder to provoke the scratch movement is maintained unaltered all the time. The stimulus to the right foot will temporarily interrupt a scratch-reflex, or will cut it short or will delay its onset; which it does of these depends on the time-relations of the stimuli. The inhibition of the scratch-reflex occurs sometimes when the contraction of the muscles innervated by the reflex conflicting with it is very slight. There is interference between the two reflexes and the one is inhibited by the other. The final common path used by the left scratch-reflex is also common to the reflex elicitable from the right foot. This latter reflex evokes at the opposite (left) knee extension; in doing this it causes steady excitation of extensor neurones of that knee and steadily inhibits the flexor neurones. But the scratch-reflex causes rhythmic excitation of the flexor neurones. Therefore these flexor neurones in this conflict lie as a final common path under the influence of two antagonistic reflexes, one of which would excite them to rhythmical discharge four times a second, while the other would continually repress all discharge in them. There is here an antagonistic relation between reflexes embouching on one and the same final common path.

In all these forms of interference there is a competition, as it were, between the excitatory stimulus used for the one reflex and the excitatory stimulus for the other. Both stimuli are in progress together, and the one in taking effect precludes the other's taking effect as far as the final common path is concerned; and the precise form in which that occurs depends greatly on

the time-relations of application of the two stimuli competing against each other.

Again, if, while stimulation of the skin of the shoulder is evoking the scratch-reflex, the skin of the hind foot of the *same* side is stimulated, the scratching may be arrested. Stimulation of the skin of the hind foot by any of various stimuli that have the character of threatening the part with damage causes the leg to be flexed, drawing the foot up by steady maintained contraction of the flexors of the ankle, knee and hip. In this reaction the reflex arc is (under schematic provisions similar to those mentioned in regard to the scratch reflex schema)

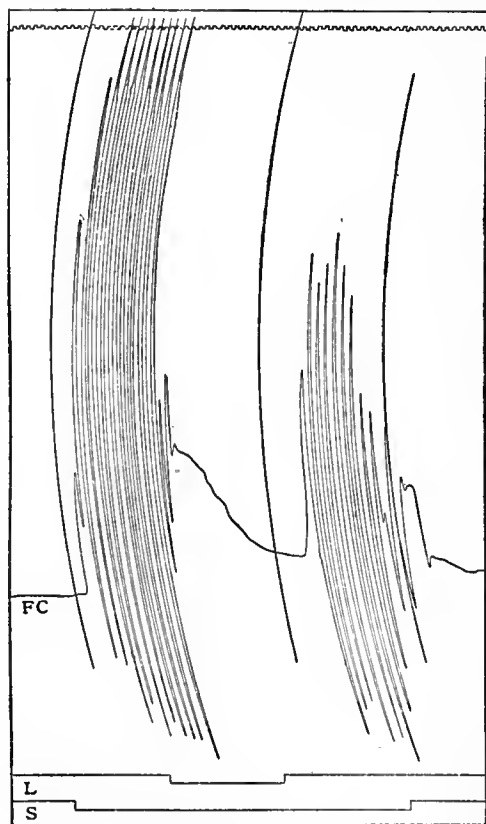

Antagonistic Reflexes.

(i.) the receptive neurone, noci-ceptive, from the foot to the spinal segment, (ii.) the motor neurone to the flexor muscle, e.g. of hip (a short intra-spinal neurone); a Schalt-zelle (v. Monakow) is probably existent between (i.) and (ii.) but omitted for simplicity. Here, therefore, there is an arc which embouches into the same final common path, FC. The motor neurone FC is a path common to it and to the scratch-reflex arc; both these arcs employ the same effector organ, namely, the knee-flexor, and employ it by the common medium of the final path FC. But though the channels for both reflexes embouch upon the same final common path, the excitatory flexor effect specific to each differs strikingly in the two cases. In the scratch-reflex the flexor effect is an intermittent effect; in the noci-ceptive flexion-reflex the flexor effect is steady and maintained. The accompanying tracing shows the result of conflict between the two reflexes. The one reflex displaces the other at the common path. Compromise is not evident. The scratch-reflex is set aside by that of the noci-ceptive arc from the homonymous foot. The stimulation which previously sufficed to provoke the scratch-reflex is no longer effective, though it is continued all the time. But when the stimulation of the foot is discontinued the scratch-reflex returns. In that respect, although there is no enforced inactivity, there is an *interference* which is tantamount to, if not the same thing as, inhibition. Though there is no cessation of activity in the motor neurone, one form of activity that was being impressed upon it is cut short and another takes its place. A stimulation of the foot too weak to cause more than a minimal

reflex will often suffice to completely interrupt, or cut short, or prevent onset of, the scratch-reflex.

The kernel of the interference between the homonymous flexion-reflex and the scratch-reflex is that both employ the same final common path FC to different effect—just as in the interference between the crossed extension-reflex and the scratch-reflex. Evidently, the homonymous flexion-reflex and the crossed extension-reflex both use the same final common path FC. And they *use it to different effect*. The motor neurone to the flexor of the knee being taken as a representative of the final common path, the homonymous flexion-reflex inhibits it from discharging. Hence if, while the direct flexion-reflex is in progress, the crossed foot is stimulated, the reflex of the knee-flexor is inhibited. The crossed extension-reflex therefore inhibits not only the scratch-reflex, but also the homonymous flexion-reflex.

Further, in all these interferences between reflexes the direction taken by the inhibition is *reversible*. Thus, the scratch-reflex is not only liable to be inhibited by, but is itself able to inhibit either the homonymous flexion-reflex or the crossed extension-reflex; the homonymous flexion-reflex is not only capable of being inhibited by the crossed extension-reflex, but conversely in its turn can inhibit the crossed extension-reflex. These interferences are therefore reversible in direction. Certain conditions determine which reflex among two or more competing ones shall obtain mastery over the final common path and thus obtain expression.

Therefore, in regard to the final common path FC, the reflexes that express themselves in it can be grouped into sets, namely, those which excite it in one way, those which excite it in another way, and those which inhibit it. The reflexes composing each of these sets stand in such relation to reflexes of the same set that they are with them "allied reflexes." But a reflex belonging to any one of these sets stands in such relation to a reflex belonging to one of the other sets that it is in regard to the latter an "antagonistic" reflex. This correlation of reflexes about the flexor neurone in the leg, so that some reflexes are mutually allied and some are mutually antagonistic in regard to that neurone, may serve as a paradigm of the correlation of reflexes about every final common path, e.g. about every motor nerve to skeletal muscle.

As to the intimate nature of the mechanism which thus, by summation or by interference, gives co-ordination where neurones converge upon a common path, it is difficult to surmise. In the central nervous system of vertebrates, afferent neurones A and B in their convergence toward and impingement upon another neurone Z, towards which they conduct, do not make any lateral connexion directly one with the other—at least, there seems no clear evidence that they do. It seems, then, that the only structural link between A and B is neurone Z itself. Z itself should therefore be the field of coalition of A and B if they transmit "allied" reflexes.

It was argued, from the morphology of the perikaryon, that it must form, in numerous cases, a nodal point in the conductive lines provided by the neurone. The work of Ramón-y-Cajal, van Gehuchten, v. Lenhossek and others, with the methods of Golgi and Ehrlich, establishes as a concept of the neurone in general that it is a conductive unit wherein a number of branches (dendrites) converge towards, meet and coalesce in a single out-going stem (axone). Through this tree-shaped structure the nervous impulses flow, like the water in a tree, from roots to stem. The conduction does not normally run in the reverse direction. The place of junction of the dendrites with one another and with the axone is commonly the perikaryon. This last is therefore a nodal point in the conductive system. But it is a nodal point of particular quality. It is not a nodal point where lines meet to cross one another, nor one where one line splits into many. It is a nodal point where conductive lines run together into one which is the continuation of them all. It is a reduction point in the system of lines. The perikaryon with its convergent dendrites is therefore just such a structure as spatial summation and immediate induction would demand.

The neurone Z may well, therefore, be the field of coalition, and the organ where the summational and inductive processes occur. And the morphology of the neurone as a whole is seen to be just such as we should expect, arguing from the principle of the common path.

With the phenomenon of "interference" the question is more difficult. There it is not clear that the field of antagonism is within the neurone Z itself. The field may be synaptic. We have the demonstration by Verworn that the interference produced by A at Z for impulses from B is not accompanied by any obvious change in excitability of the axone of Z. Z, if itself the seat of inhibition, might have been expected to exhibit that inhibition throughout its extent. This, as tested by its axone, it does not. There exist, it is true, older experiments by Uspensky, Belmondo and Oddi, &c., according to which the threshold of direct excitability of the motor root is lowered by stimulation of the afferent root. This points to an extension of the facilitation effect through the whole motor neurone, conversely to Verworn's demonstration for central inhibition. Verworn's experiment and its result is very clear. It leads us to search for some other mechanism common to A and B to which might be attributable their mutual influence on each other's reactions. But if we admit the conception, argued above, that at the nexus between A and Z, *i.e.* at synapse A Z, and similarly between B and Z, *i.e.* at synapse B Z, there exists a surface of separation, a membrane in the physical sense, a further consequence seems inferable. Suppose a number of different neurones A, B, C, &c., each conducting through its own synapse upon a neurone Z. The synapses A Z, B Z, C Z, &c. are all surfaces or membranes into which Z enters as a factor common to them all. A change of state induced in neurone Z might be expected to affect the surface condition or membrane at all of the synapses, since the condition of Z is a factor common to all those membranes. Therefore a change of state (excitatory or inhibitory) induced in Z by any of the neurones A, B, C, &c., playing upon it would enter as a condition into the nervous transmission at the other synapses from the other collateral neurones. In harmony with this is the spread of refractory state in the neurones as mentioned above. A change in neurone Z induced by neurone A playing upon it, in that case seems to effect its point of nexus with the other neurones B, C, &c., also. It is conceivable that the phenomena of interference may be based in part at least on such a condition. The neurone threshold of Z for stimulation through B will be to some extent a function of events at synapses A Z.

Factors Determining the Sequence.—The formation of a common path from tributary converging afferent arcs is important because it gives a co-ordinating mechanism. There the dominant action of one afferent arc, or set of allied arcs in condominium, is subject to supercession by another afferent arc, or set of allied arcs, and the supercession normally occurs without intercurrent confusion. Whatever be the nature of the physiological process occurring between the competing reflexes for dominance over the common path, the issue of their competition namely, the determination of which one of the competing arcs shall for the time being reign over the common path, is largely conditioned by four factors. These are spinal induction, relative fatigue, relative intensity of stimulus, and the functional species of the reflex.

1. The first of these occurs in two forms, one of which has already been considered, namely, *immediate induction*. It is a form of "bahnung." The stimulus which excites a reflex tends by central spread to facilitate and lower the threshold for reflexes, allied to that which it particularly excites. A constellation of reflexes thus tends to be formed which reinforce each other, so that the reflex is supported by allied accessory reflexes, or if the prepotent stimulus shifts, allied arcs are by the induction particularly prepared to be responsive to it or to a similar stimulus.

Immediate induction only occurs between allied reflexes. Its tendency in the competition between afferent arcs is to fortify the reflex just established, or, if transition occur, to favour

transition to an allied reflex. Immediate induction seems to obtain with highest intensity at the outset of a reflex, or at least near its commencement. It does not appear to persist long.

The other form of spinal induction is what may be termed *successive induction*. It is in several ways the reverse of the preceding.

In peripheral inhibition, exemplified by the vagus action on the heart, the inhibitory effect is followed by a rebound after-effect opposite to the inhibitory (Gaskell). The same thing is obvious in various instances of the reciprocal inhibition of the spinal centres. Thus, if the crossed-extension reflex of the limb of the "spinal" dog be elicited at regular intervals, say once a minute, by a carefully adjusted electrical stimulus of defined duration and intensity, the resulting reflex movements are repeated each time with much constancy of character, amplitude and duration. If in one of the intervals a strong prolonged (*e.g.* 30") flexion-reflex is induced from the limb yielding the extensor-reflex movement, the latter reflex is found intensified after the intercurrent flexion-reflex. The intercalated flexion-reflex lowers the threshold for the aftercoming extension-reflexes, and especially increases their after-discharge. This effect may endure, progressively diminishing, through four or five minutes, as tested by the extensor reflexes at successive intervals. Now, as we have seen, *during* the flexion-reflex the extensor arcs were inhibited: *after* the flexion-reflex these arcs are in this case evidently in a phase of exalted excitability. The phenomenon presents obvious analogy to visual contrast. If visual brightness be regarded as analogous to the activity of spinal discharge, and visual darkness analogous to absence of spinal discharge, this reciprocal spinal action in the example mentioned has a close counterpart in the well-known experiment where a white disk used as a prolonged stimulus leaves as visual after-effect a grey image surrounded by a bright ring (Hering's "Lichthof"). This bright ring has for its spinal equivalent the discharge from the adjacent reciprocally correlated spinal centre. The exaltation after-effect may ensue with such intensity that simple discontinuance of the stimulus maintaining one reflex is immediately followed by "spontaneous" appearance of the antagonistic reflex. Thus the flexion-reflex, if intense and prolonged, may, directly its own exciting stimulus is discontinued, be succeeded by a "spontaneous" reflex of extension, and this even when the animal is lying on its side and the limb horizontal—a pose that does not favour the tonus of the extensor muscles. Such a "spontaneous" reflex is the spinal counterpart of the visual "Lichthof." To this spinal induction, as it may be termed, seems attributable a phenomenon commonly met in a flexion-reflex of high intensity when maintained by very prolonged excitation. The reflex flexion is then frequently broken at irregular intervals by sudden extension movements. It would seem, therefore, that some process in the flexion-reflex leads to exaltation of the activity of the arcs of the opposed extension-reflex. An electrical stimulation of the proximal end of the severed nerve of the extensor muscles of the knee (cat), though it does not, in the present writer's experience, directly excite contraction of the extensors of the knee is on cessation often immediately followed by contraction of them.

As examples of the rebound exaltation following on inhibition the following may also serve. The so-called "mark-time" reflex of the "spinal" dog is an alternating stepping movement of the hind limbs which occurs on holding the animal up so that its limbs hang pendent. It can be inhibited by stimulating the skin of the tail. On cessation of that stimulus the stepping movement sets in more vigorously and at quicker rate than before. The increase is chiefly in the amplitude of the movement, but the writer has also seen the rhythm quickened even by 30% of the frequency.

This after-increase might be explicable in either of two ways. It might be due to the mere repose of the reflex centre, the repose so recruiting the centre as to strengthen its subsequent action. But a similar period of repose obtained by simply supporting one limb—which causes cessation of the reflex in both limbs, the

stimulus being stretch of the hip-flexors under gravity—is not followed by after-increase of the reflex.

Or the after-increase might result from the inhibition being followed by a rebound to superactivity. This latter seems to be the case. The after-increase occurs even when both hind limbs are passively lifted from below during the whole duration of the inhibitory stimulus applied to the tail. It is the depression of inhibition, and not the mere freedom from an exciting stimulus, that induces a later superactivity. And the reflex inhibition of the knee-extensor by stimulation of the central end of its own nerve is especially followed by marked rebound to superactivity of the extensor itself.

Again, the knee jerk, after being inhibited by stimulation of the hamstring nerve, returns, and is then more brisk than before the inhibition.

By virtue of this spinal contrast, therefore, the extension-reflex predisposes to and may actually induce a flexion-reflex, and conversely the flexion-reflex predisposes to and may actually induce an extension-reflex. This process is qualified to play a part in linking reflexes together in a co-ordinate sequence of successive combination. If a reflex arc A during its own activity temporarily checks that of an opposed reflex arc B, but as a subsequent result induces in arc B a phase of greater excitability and capacity for discharge, it predisposes the spinal organ for a second reflex opposite in character to its own in immediate succession to itself. The writer has elsewhere pointed out the peculiar prominence of "alternating reflexes" in prolonged spinal reactions. It is significant that they are usually cut short with ease by mere passive mechanical interruption of the alternating movement in progress. It seems that each step of the reflex movement tends to excite by spinal induction the step next succeeding itself.

Much of the reflex action of the limb that can be studied in the "spinal" dog bears the character of adaptation to locomotion. This has been shown recently with particular clearness by the observations of Phillipson. In describing the extensor thrust of the limb the writer drew attention at the time to its significance for locomotion. Spinal induction obviously tends to connect to this extensor-thrust flexion of the limb as an after-effect. In the stepping of the limb the flexion that raises the foot and carries it clear of the ground prepares the antagonistic arcs of extension, and, so to say, sensitizes them to respond later in their turn by the supporting and propulsive extension of the limb necessary for progression. In such reflex sequences an antecedent reflex would thus not only be the means of bringing about an ensuing stimulus for the next reflex, but would predispose the arc of the next reflex to react to the stimulus when it arrives, or even induce the reflex without external stimulus. The reflex "stepping" of the "spinal" dog does go on even without an *external skin* stimulus: it will continue when the dog is held in the air. The cat walks well when anaesthetic in the soles of all four feet.

Each reflex movement must of itself generate stimuli to afferent apparatus in many parts and organs—muscles, joints, tendons &c. This probably reinforces the reflex in progress. The reflex obtainable by stimulation of the afferent nerve of the flexor muscles of the knee excites those muscles to contraction and inhibits their antagonists: the reflex obtainable from the afferent nerve of the extensor muscles of the knee excites the flexors and inhibits their antagonists.

Where a reflex by spinal induction tends to eventually bring about the opposed reflex, the process of spinal induction is therefore probably reinforced by the operation of any reflex generated in the movement. This would help to explain how it is that a reflex reaction, when once excited in a "spinal" animal, ceases on cessation of the stimulus as quickly as it generally does. Such a reaction must generate in its progress a number of further stimuli and throw up a shower of centripetal impulses from the moving muscles and joints into the spinal cord. Squeezing of muscles and stimulation of their afferent nerves and those of joints, &c., elicit reflexes. The primary reflex movement might be expected, therefore, of itself to initiate further reflex

movement, and that secondarily to initiate further still, and so on. Yet on cessation of the external stimulus to the foot in the flexion-reflex the whole reflex comes usually at once to an end. The scratch-reflex, even when violently provoked, ceases usually within two seconds of the discontinuance of the external stimulus that provoked it.

We have as yet no satisfactory explanation of this. But we remember that such reflexes are intercurrent reactions breaking in on a condition of neural equilibrium itself reflex. The successive induction will tend to induce a *compensatory* reflex, which brings the moving parts back again to the original position of equilibrium.

2. Another condition influencing the issue of competition between reflexes of different source for possession of one and the same final common path is *fatigue*. A spinal reflex under continuous excitation or frequent repetition becomes weaker, and may cease altogether. This decline is progressive, and takes place earlier in some kinds of reflexes than it does in others. In the "spinal" dog the scratch-reflex under ordinary circumstances tires much more rapidly than does the flexion-reflex.

A reflex as it tires shows other changes besides decline in amplitude of contraction. Thus in the flexion-reflex, the original steadiness of the contraction decreases; it becomes tremulous, and the tremor becomes progressively more marked and more irregular. The rhythm of the tremor in the writer's observations has often been about 10 per second. Then phases of greater tremor tend to alternate with phases of improved contraction as indicated by some regain of original extent of flexion of limb and diminished tremor. Apart from these partial evanescent recoveries the decline is progressive. Later, the stimulation being maintained all the time, brief periods of something like complete intermission of the reflex appear, and even of a replacement of flexion by extension. These lapses are recovered from, but tend to recur more and more. Finally, an irregular phasic tremor of the muscles is all that remains. It is not the flexor muscles themselves which tire out, for these, when under fatigue of the flexion-reflex they contract no longer for that reflex, contract in response to the scratch-reflex which also employs them.

Similar results are furnished by the scratch-reflex, with certain differences in accord with the peculiar character of its individual charge. One of these latter is the feature that the individual beats of the scratch-reflex usually become slower and follow each other at slower frequency. Also the beats, instead of remaining fairly regular in amplitude and frequency, tend to succeed in somewhat regular groups. The beats may disappear altogether for a short time, and then for a short time reappear, the stimulus continuing all the while. Here, again, the phenomena are not referable to the muscle, for when excited through other reflex channels, or through its motor nerve directly, the muscle shows its contraction well. Part of the decline of these reflexes under electrical stimulation in the "spinal" dog may be due to reduction of the intensity of the stimulus itself by physical polarization. That does not account in the main for the above described effects. The graphic record of fatigue of the flexion of the scratch-reflex obtained by continued *mechanical* stimulation does not appreciably differ from that yielded under electrical stimulation. The different speed of the decline due to fatigue proceeds characteristically in different kinds of reflex, and in the same kind of reflex under different physiological conditions, *e.g.* "spinal shock": this indicates its determination by other factors than electrical polarization. Polarization has in a number of cases been deferred as far as possible by using equalized alternate shocks applied in opposite directions through the same gilt needle; this precaution has not yielded results differing appreciably from those given by ordinary double shocks or by series of make or break shocks of the same direction. The slowing of the beat in fatigue is also against the explanation by polarization, since merely weakening the stimulus does not lead to a slower beat.

When the scratch-reflex elicited from a spot of skin is fatigued,

the fatigue holds for that spot, but does not implicate the reflex as obtained from the surrounding skin. The reflex is, when tired out to stimuli at that spot, easily obtainable by stimulation two or more centimetres away. This is seen with either mechanical or electrical stimuli. When the spot stimulated second is close to the one tired out, the reflex shows some degree of fatigue, but not that degree obtaining for the original spot. This fatigue may be a local fatigue of the nerve-endings in the spot of skin stimulated, to which in experiments making use of electric stimuli some polarization may be added. Yet its local character does not at all necessarily imply its reference to the skin. It may be the expression of a spatial arrangement in the central organ by which reflex arcs arising in adjacent receptors are partially confluent in their approach toward the final common path, and are the more confluent the closer together lie their points of origin in the receptive field. The resemblance between the distribution of the incidence of this fatigue and that of the spatial summation previously described argues that the seat of the fatigue is intraspinal and central more than peripheral and cutaneous; and that it affects the afferent part of the arc inside the spinal cord, probably at the first synapse. Thus, its incidence at the synapse R_a-P_a and at $R-P$ would explain its restrictions, as far as we know them, in the scratch-reflex.

The local fatigue of a spinal reflex seems to be recovered from with remarkable speed, to judge by observations on the reflexes of the limbs of the "spinal" dog. A few seconds' remission of the stimulus suffices for marked though incomplete restoration of the reaction. In a few instances there may be seen return of a reflex even during the stimulation under which the waning and disappearance of the reflex occurred. The exciting stimulus has usually in such cases been of rather weak intensity. In the writer's experience these spinal reflexes fade out sooner under a weak stimulus than under a strong one. This seeming paradox indicates that under even feeble intensities of stimulation the threshold of the reaction gradually rises, and that it rises above the threshold value of the weaker stimulus before it reaches that of a stronger stimulus. The scratch-reflex which has ceased to be elicited by a weak stimulus is immediately evoked—often without any sign of fatigue in its motor response—by increasing the intensity of the stimulus applied at the same electrode. The occurrence of fatigue earlier under the weaker stimulus than under the stronger also shows that the fatigue consequent under the weaker stimulus may often be, relatively to the *production of the natural discharge*, greater than when a stronger stimulus is employed. This, which has been of frequent occurrence in the writer's observations on the leg of the "spinal" dog, if obtaining widely in reflex actions, has evident practical importance.

It is easy to avoid in some degree the local fatigue associated with excitation of the scratch-reflex from one single spot in the skin by taking advantage of the spatial summation of stimuli applied at different points in the receptive field. When this was done, a curious result met the writer. The provocation of the reflex has been made through ten separate points in the receptive field, the distance between each member of the series of points and the point next to it being about four centimetres. Each point is stimulated by a double-induction shock delivered twice a second. When this is done a series of scratch movements is elicited, and continues longer than when the stimuli are applied at the same interval, not to succeeding series of skin points but to one point. Thus three or four hundred beats can be elicited in unbroken series. But the series tends somewhat abruptly to cease. If, then, in spite of the cessation of the response, the stimulation be *continued* without alteration during three or four minutes or more, the scratching movement breaks out again from time to time and gives another series of beats, perhaps longer than the first. These experiments indicate that physical polarization at the stigmatic electrode is not answerable for the fading out of the scratch-reflex. It shows also the complexity of the central mechanisms involved in the reflex. The phenomenon recalls Lombard's phases of briskness and fatigue in series of records obtained with the ergograph.

It is interesting to note certain differences between the cessation of a reflex under fatigue and under inhibition. The reflex ceasing under inhibition is seen to fade off without obvious change in the frequency of repetition of the beats, or in the duration of the individual beats. The reflex ceasing under fatigue is seen to show a slower rhythm and a sluggish course for the latter beats, especially for the terminal ones.

Among the signs of fatigue of a reflex action are several suggesting that in it the command over the final common path exercised for the time being by the receptors and afferent path in action becomes less strong, less steady and less accurately adjusted. Under prolonged excitation their hold upon the final common path becomes loosened. This view is supported by the fact that its connexion with the final common path is then more easily cut short and ruptured by other rival arcs competing with it for the final common path in question. The scratch-reflex interrupts the flexion-reflex more readily when the latter is tired out than when it is fresh.

In the hind limb of the "spinal" dog the extensor-thrust is inelicitable during the flexion-reflex. That is to say, when the flexion-reflex is evoked with fair or high intensity the writer has never succeeded in evoking the extensor-thrust, though the flexed posture of the limb is itself a favouring circumstance for the production of the thrust if the flexion be a passive one. But when the flexion-reflex is kept up by appropriate stimulation of a single point over a prolonged time, so that it shows fatigue, the extensor-thrust becomes again elicitable. Its elicibility is, then, not regular nor facile, but it does become obtainable, usually in quite feeble degree at first, later more powerfully. In other words, it can dispossess the rival reflex from a common path when that rival is fatigued, though it cannot do so when the rival action is fresh and powerful.

Again, the crossed extension-reflex cannot inhibit the reflexion of the flexor-reflex under ordinary circumstances if the intensity of the stimulation of the competing arcs be approximately equal; but it can do so when the flexion-reflex is tired.

The waning of a reflex under long-maintained excitation is one of the many phenomena that pass in physiology under the name of fatigue. It may be that in this case the so-called fatigue is really nothing but a negative induction. Its place of incidence may lie at the synapse. It seems a process elaborated and preserved in the selective evolution of the neural machinery. One obvious use attaching to it is the prevention of the too prolonged continuous use of a common path by any one receptor. It precludes one receptor from occupying for long periods an effector organ to the exclusion of all other receptors. It prevents long continuous possession of a common path by any one reflex of considerable intensity. It favours the receptors taking turn about. It helps to ensure serial variety of reaction. The organism, to be successful in a million-sided environment, must in its reaction be many sided. Were it not for such so-called fatigue, an organism might, in regard to its receptivity, develop an eye, or an ear, or a mouth, or a hand or leg, but it would hardly develop the marvellous congeries of all those various sense-organs which it is actually found to possess.

The loosening of the hold upon the common path by so-called fatigue occurs also in paths other than those leading to muscle and effector organs. If instead of motor effects sensual are examined, analogous phenomena are observed. A visual image is more readily inhibited by a competing image in the same visual field when it has acted for some time than when it is first perceived (W. Macdougall).

One point, on a priori grounds, is a natural corollary from the "principle of the common path," as indicated by the experimental findings relative to the incidence of fatigue. The reflex arcs, each a chain of neurones, converge in their course so as to impinge upon and conjoin in links (neurones) common to whole varied groups—in other words, they conjoin to *common paths*. This arrangement culminates in the convergence of many separately arising arcs in the final efferent-root neurone. This neurone thus forms the instrument for many different reflex arcs and acts. It is responsive to them in various rhythm and in

various grades of intensity. In accordance with this, it seems from experimental evidence to be *relatively indefatigable*. It thus satisfies a demand that the principle of the common path must make regarding it.

3. In the transition from one reflex to another a final common path changes hands and passes from one master to another. A

fresh set of afferent arcs becomes dominant on the *Intensity*. supersession of one reflex by the next. Of all the conditions determining which one of competing reflexes shall for the time being reign over a final common path, the *intensity* of reaction of the afferent arc itself relatively to that of its rivals is probably the most powerful. An afferent arc that strongly stimulates is *caeteris paribus* more likely to capture the common path than is one excited feebly. A stimulus can only establish its reflex and inhibit an opposed one if it have intensity. This explains why, in order to produce examples of spinal inhibition, recourse has so frequently been made in past times to *strong* stimuli. A strong stimulus will inhibit a reflex in progress, although a weak one will fail. Thus in Goltz's inhibition of micturition in the "spinal" dog a *forcible* squeeze of the tail will do it, but not, in the present writer's experience, a weak squeeze. So, likewise, any condition which raises the excitability and responsiveness of a nervous arc will give it power to inhibit other reflexes, just as it would if it were excited by a strong stimulus. This is much as in the heart of the Tunicate. There the prepotent spot whence starts the systole lies from time to time at one end and from time to time at the other. The prepotent region at one end which usually dominates the common path is from time to time displaced by local increase of excitability at the other under local distension of the blood-sinuses there.

In judging of intensity of stimulus the situation of the stimulus in the receptive field of the reflex has to be remembered. One and the same physical stimulus will be weak if applied near the edge of the field, though strong if applied to the focus of the field.

Crossed reflexes are usually less easy to provoke, less reliable of obtainment, and less intense than are direct reflexes. Consequently we find crossed reflexes usually more easily inhibited and replaced by direct reflexes than are these latter by those former. Thus the crossed stepping-reflex is easily replaced by the scratch-reflex, though its stimulus be continued all the time, and though the scratch-reflex itself is not a very potent reflex. But the reverse can occur with suitably adjusted intensity of stimuli.

Again, the flexion-reflex of the dog's leg is, when fully developed, accompanied by extension in the opposite leg. This crossed extensor movement, though often very vigorous, may be considered as an accessory and weaker part of the whole reflex, of which the prominent part is flexion of the homonymous limb. When the flexion-reflex is elicitable poorly, as, for instance, in spinal shock or under fatigue or weak excitation, the crossed extension does not accompany the homonymous flexion and does not appear. But, where the flexion-reflex is well developed, if not merely one but *both* feet be stimulated simultaneously with stimuli of fairly equal intensity, steady flexion at knee, hip and ankle results in *both* limbs, and extension occurs in neither limb. The contralateral part of each reflex is inhibited by the homolateral flexion of each reflex. In other words, the more intense part of each reflex obtains possession of the final common paths at the expense of the less intense portion of the reflex. But if the intensity of the stimuli applied to the right and left feet be not closely enough balanced, the crossed extension of the reflex excited by the stronger stimulus is found to exclude even the homonymous flexion that the weaker stimulus should and would otherwise evoke from the leg to which it is applied.

It was pointed out above that in a number of cases the transference of control of the final common path FC from one afferent arc to another is *reversible*. The direction of the transference can *caeteris paribus* be easily governed by making the stimulation of this receptor or that receptor the more intense.

A factor largely determining whether a reflex succeed another or not is therefore intensity of stimulus.

4. A fourth main determinant for the issue of the conflict between rival reflexes seems the functional species of the reflexes. Reflexes initiated from a species of receptor appa- *Species of* ratus that may be termed *noci-ceptive* appear to *Reflex*. particularly dominate the majority of the final common paths issuing from the spinal cord. In the simpler sensations we experience from various kinds of stimuli applied to our skin there can be distinguished those of touch, of cold, of warmth and of pain. The adequate stimuli for the first-mentioned three of these are certainly different; mechanical stimuli, applied above a certain speed, which deform beyond a certain degree the resting contour of the skin surface, seem to constitute *adequate* stimuli for touch. Similarly the cooling or raising of the local temperature, whether by thermal conduction, radiation, &c., are *adequate* for the cold and warmth sensations. The organs for these three sensations have by stigmatic stimuli been traced to separate and discrete tiny spots in the skin. In regard to skin-pain it is held by competent observers, notably by V. Frey and Kiesow, that skin-pain likewise is referable to certain specific nerve-endings. In evidence of this it is urged that mechanical stimuli applied at certain places excite sensations which from their very threshold upward possess unpleasantness, and as the intensity of the stimulus is increased, culminate in "physical pain." The sensation excited by a mechanical stimulus applied to a touch-spot does not evoke pain, however intensely applied, so long as the stimulation is confined to the touch-spot. The threshold value of mechanical stimuli for touch-spots is in general lower than it is for pain-spots; and conversely the threshold value of electrical stimuli for touch-spots is in general higher than it is for the spots yielding pain. Similarly it is said that stimulation of a cold spot or of a warm spot does not, however intense, evoke, so long as confined to them, sensations of painful quality. But pain can be excited not only by strong mechanical stimuli and by electrical stimuli, but by cold and by warmth, though the threshold value of these latter stimuli is higher for pain than for cold and warm spots. If these observations prove correct there exist, therefore, numerous specific cutaneous nerve-fibres evoking pain.

A difficulty here is that sensory nerve-endings are usually provided with sense organs which lower their threshold for stimuli of one particular kind while raising it for stimuli of all other kinds; but these pain-endings in the skin seem almost equally excited by stimuli of such different modes as mechanical, thermal conductive, thermal radiant, chemical and electrical. That is, they appear *anelective* receptors. But it is to be remarked that these agents, regarded as excitants of skin-pain, have all a certain character in common, namely this, that they become *adequate* as excitants of pain when they are of such intensity as *threatens damage to the skin*. And we may note about these excitants that they are *all able to excite nerve* when applied to naked nerve *directly*. Now there are certain skin surfaces from which, according to most observers, pain is the only species of sensation that can be evoked. This is alleged, for instance, of the surface of the cornea—a modified piece of skin. The histology of the cornea reveals in its epithelium nerve-endings of but one morphological kind; that is, the ending by naked nerve-fibrils that pass up among the epithelial cells. Similar nerve-endings exist also in the epidermis generally. It may therefore be that the nerve-endings subserving skin-pain are free naked nerve-endings, and the absence of any highly evolved specialized end-organ in connexion with them may explain their fairly equal amenability to an unusually wide range of different kinds of stimuli. Instead of but one kind of stimulus being their adequate excitant, they may be regarded as adapted to a whole group of excitants, a group of excitants which has in relation to the organism one feature common to all its components, namely, a *nocuous* character.

With its liability to various kinds of mechanical and other damage, in a world beset with dangers amid which the individual and species have to win their way in the struggle for existence,

we may regard nocuous stimuli as part of a normal state of affairs. It does not seem improbable, therefore, that there should under selective adaptation attach to the skin a so-to-say *specific sense of its own injuries*. As psychological adjunct to the reactions of that apparatus we find a strong displeasurable effective quality in the sensations they evoke. This may perhaps be a means for branding upon memory, of however rudimentary kind, a feeling from past events that have been perilously critical for the existence of the individuals of the species. In other words, if we admit that damage to such an exposed sentient organ as the skin must in the evolutionary history of animal life have been sufficiently frequent in relation to its importance, then the existence of a specific set of nerves for skin-pain seems to offer no genetic difficulty, any more than does the clotting of blood or innate immunity to certain diseases. That these nerve-endings constitute a distinct species is argued by their all evoking not only the same species of sensation, but the same species of reflex movement as regards "purpose," intensity, resistance to "shock," &c. And their evolution may well have been unaccompanied by evolution of any specialized end-organ, since the naked free nerve-endings would better suit the wide and peculiar range of stimuli, reaction to which is in this case required. A low threshold was *not* required because the stimuli were all intense, intensity constituting their harmfulness; but response to a wide range of stimuli of *different* kinds was required, because harm might come in various forms. That responsive *range* is supplied by naked nerve itself, and would be cramped by the specialization of an end-organ. Hence these nerve-endings remained free.

It is those areas, stimulation of which, as judged by analogy, can excite pain most intensely, and it is those stimuli which, as judged by analogy, are most fitted to excite pain which, as a general rule, excite in the "spinal" animal—where pain is of course non-existent—the *prepotent* reflexes. If these are reactions to specific pain-nerves, this may be expressed by saying that the nervous arcs of pain-nerves, broadly speaking, dominate the spinal centres in peculiar degree. Physical pain is thus the psychological adjunct of an imperative protective reflex. It is preferable, however, since into the merely spinal and reflex aspect of the reaction of these nerves no sensation of any kind can be shown to enter, to avoid the term "pain-nerves." Remembering that the feature common to all this group of stimuli is that they threaten or actually commit damage to the tissue to which they are applied, a convenient term for application to them is *nocuous*. In that case what from the point of view of *sense* are cutaneous pain-nerves are from the point of view of *reflex-action* conveniently termed *noci-ceptive* nerves.

In the competition between reflexes the noci-ceptive as a rule dominate with peculiar certainty and facility. This explains why such stimuli have been so much used to evoke reflexes in the spinal frog, and why, judging from them, such "fatality" belongs to spinal reflexes.

One and the same skin surface will in the hind limb of the spinal dog evoke one or other of two diametrically different reflexes according as the mechanical stimulus applied be of noxious quality or not, a harmful insult or a harmless touch. A needle-prick to the planta causes invariably the drawing up of the limb—the flexion-reflex. A harmless smooth contact, on the other hand, causes extension—the extensor-thrust above described. This flexion is therefore a noci-ceptive reflex. But the scratch-reflex—which is so readily evoked by simple light irritation of the skin of the shoulder—is relatively mildly noci-ceptive. When the scratch-reflex and the flexion-reflex are in competition for the final neurone common to them, the flexion-reflex more easily dispossesses the scratch-reflex from the final neurone than does the scratch-reflex the flexion-reflex. If both reflexes are fresh, and the stimuli used are such as, when employed separately, evoke their reflexes respectively with some intensity, in my experience it is the flexion-reflex that is usually prepotent. Yet if, while the flexion-reflex is being moderately evoked by an appropriate stimulus of weak intensity, a strong stimulus suitable for producing the scratch-

reflex is applied, the steady flexion due to the flexion-reflex is replaced by the rhythmic scratching movement of the scratch-reflex, and this occurs though the stimulus for the flexion-reflex is maintained unaltered. When the stimulus producing the scratch is discontinued the flexion-reflex reappears as before. The flexion-reflex seems more easily to dispossess the scratch-reflex from the final common paths than can the scratch-reflex dispossess the flexion-reflex. Yet the relation is reversible—by heightening the intensity of the stimulus for the scratch-reflex or lowering that of the stimulus for the flexion-reflex.

In decerebrate rigidity, where a tonic reflex is maintaining contraction in the extensor muscles of the knee, stimulation of the noci-ceptive arcs of the limb easily breaks down that reflex. The noci-ceptive reflex dominates the motor neurone previously held in activity by the postural reflex. And noci-ceptive reflexes are relatively little depressed by "spinal shock."

Noci-ceptive arcs are, however, not the only spinal arcs which in the intact animal, considered from the point of view of sensation, evoke reactions rich in affective quality. Beside those receptors attuned to react to direct *noxa*, the skin has others, concerned likewise with functions of vital importance to the species and colligate with sensations similarly of intense affective quality; for instance, those concerned with sexual functions. In the male frog the sexual clasp is a spinal reflex. The cord may be divided both in front and behind the brachial region without interrupting the reflex. Experiment shows that from the spinal male at the breeding season, and also at other times, this reflex is elicited by any object that stimulates the skin of the sternal and adjacent region. In the intact animal, on the contrary, other objects than the female are, when applied to that region, at once rejected, even though they be wrapped in the fresh skin of the female frog and in other ways made to resemble the female. The development of the reflex is not prevented by removal of the testes, but removal of the seminal reservoirs is said to depress it, and their distension, even by indifferent fluids, to exalt it. If the skin of the sternal region and arms is removed the reflex does not occur. Severe mutilation of the limbs and internal organs does not inhibit the reflex, neither does stimulation of the sciatic nerve central to its section. The reflex is, however, depressed or extinguished by strong chemical and pathic stimuli to the sternal skin, at least in many cases. The tortoise exhibits a similar sexual reflex of great spinal potency.

It would seem a general rule that *reflexes arising in species of receptors which considered as sense-organs provoke strongly affective sensation caeteris paribus prevail over reflexes of other species when in competition with them for the use of the "final common path."* Such reflexes override and set aside with peculiar facility reflexes belonging to touch organs, muscular sense-organs, &c. As the sensations evoked by these arcs, e.g. "pains," exclude and dominate concurrent sensations, so do the reflexes of these arcs prevail in the competition for possession of the common paths. They seem capable of *pre-eminent intensity* of action.

Of all reflexes it is the tonic reflexes, e.g. of ordinary posture, that are in the writer's experience the most *easily* interrupted by other reflexes. Even a weak stimulation of the noci-ceptive arcs arising in the foot often suffices to lower or abolish the knee-jerk or the reflex extensor tonus of the elbow or knee. If various *species* of reflex are arranged, therefore, in their order of potency in regard to power to interrupt one another, the reflexes initiated in receptors which considered as sense-organs excite sensations of strong affective quality lie at the upper end of the scale, and the reflexes that are answerable for the postural tonus of skeletal muscles lie at the lower end of the scale. One great function of the tonic reflexes is to maintain habitual attitudes and postures. They form, therefore, a nervous background of active equilibrium. It is of obvious advantage that this equilibrium should be easily upset, so that the animal may respond agilely to the passing events that break upon it as intercurrent stimuli.

Results.—Intensity of stimulation, fatigue and freshness,

spinal induction, functional species of reflex, are all, therefore, physiological factors influencing the result of the interaction of reflex-arcs at a common path. It is noticeable that they all resolve themselves ultimately into *intensity of reaction*. Thus, intensity of stimulus means as a rule intensity of reaction. Those species of reflex which are habitually prepotent in interaction with others are those which are habitually intense; those specially impotent in competition are those habitually feeble in intensity, e.g. skeletal muscular tone. The tonic reflexes of attitude are of habitually low intensity, easily interfered with and temporarily suppressed by intercurrent reflexes, these latter having higher intensity. But these latter suffer fatigue relatively early, whereas the tonic reflexes of posture can persist hour after hour with little or no signs of fatigue. Fatigue, therefore, in the long run advantageously redresses the balance of an otherwise unequal conflict. We can recognize in it another agency working toward that plastic alternation of activities which is characteristic of animal life and increases in it with ascent of the animal scale.

The high variability of reflex reactions from experiment to experiment, and from observation to observation, is admittedly one of the difficulties that has retarded knowledge of them. Their variability, though often attributed to general conditions of nutrition, or to local blood-supply, &c., seems far more often due to changes produced in the central nervous organ by its own functional conductive activity apart from fatigue. This functional activity itself causes from moment to moment the temporary opening of some connexions and the closure of others. The chains of neurones, the conductive lines, have been, especially in recent years, by the methods of Golgi, Ehrlich, Apathy, Cajal and others, richly revealed to the microscope. Anatomical tracing of these may be likened, though more difficult to accomplish, to tracing the distribution of blood vessels after Harvey's discovery had given them meaning, but before the vasomotor mechanism was discovered. The blood vessels of an organ may be turgid at one time, constricted almost to obliteration at another. With the conductive network of the nervous system the temporal variations are even greater, for they extend to absolute withdrawal of nervous influence. Under reflex inhibition a skeletal muscle may relax to its post-mortem length, *i.e.* there may then be no longer evidence of even a tonic influence on it by its motor neurone. The direction of the stream of liberation of energy along the pattern of the nervous web varies from minute to minute. The final common path is handed from some group of a *plus* class of afferent arcs to some group of a *minus* class, or of a rhythmic class, and then back to one of the previous groups again, and so on. The conductive web changes its functional pattern with certain limits to and fro. It changes its pattern at the entrances to common paths. The changes in its pattern occur there in virtue of interaction between rival reflexes, "interference." As a tap to a kaleidoscope, so a new stimulus that strikes the receptive surfaces causes in the central organ a shift of functional pattern at various synapses. The central organ is a vast network whose lines of conduction follow a certain scheme of pattern, but within that pattern the details of connexion are, at the entrance to each common path, mutable. The grey matter may be compared with a telephone exchange, where, from moment to moment, though the end-points of the system are fixed, the connexions between starting-points and terminal points are changed to suit passing requirements, as the functional points are shifted at a great railway junction. In order to realize the exchange at work, one must add to its purely spatial plan the temporal datum that within certain limits the connexions of the lines shift to and fro from minute to minute. An example is the "reciprocal innervation" of antagonistic muscles—when one muscle of the antagonistic couple is thrown into action the other is thrown out of action. This is only a widely spread case of the general rule that antagonistic reflexes interfere where they embouch upon the same final common paths. And that general rule is part of the general principle of the mutual interaction of reflexes that impinge

upon the same common path. *Unlike reflexes have successive but not simultaneous use of the common path; like reflexes mutually reinforce each other on their common path.* Expressed teleologically, *the common path, although economically subservient for many and various purposes, is adapted to serve but one purpose at a time. Hence it is a co-ordinating mechanism and prevents confusion by restricting the use of the organ, its minister, to but one action at a time.*

In the case of simple antagonistic muscles, and in the instances of simple spinal reflexes, the shifts of conductive pattern due to interaction at the mouths of common paths are of but small extent. The co-ordination covers, for instance, one limb or a pair of limbs. But the same principle extended to the reaction of the great arcs arising in the projective receptor organs of the head, e.g. the eye, which deal with wide tracts of musculature *as a whole*, operates with more multiplex shift of the conductive pattern. Releasing forces acting on the brain from moment to moment shut out from activity whole regions of the nervous system, as they conversely call vast other regions into play. *The resultant singleness of action from moment to moment is a keystone in the construction of the individual whose unity it is the specific office of the nervous system to perfect.* The interference of unlike reflexes and the alliance of like reflexes in their action upon their common paths seem to lie at the very root of the great psychical process of "attention."

The spinal cord is not only the seat of reflexes whose "centres" lie wholly within the cord itself; it supplies also conducting paths for nervous reactions initiated by impulses derived from afferent spinal nerve, but involving mechanisms situate altogether headward of the cord, that is to say, in the brain. Many of these reactions affect consciousness, occasioning sensations of various kinds. In regard to the part played by spinal conduction in subserving these sensual reactions a question of practical rather than theoretical importance has been as yet the chief aim of inquiry. The inquiry has been in fact whether the impulses concerned in evoking the various species of sensations follow in their headward course along the cord certain discrete paths occupying separable fractions of the cross-area of the cord, and if they are thus confined to discrete paths in what parts of the cross-area of the cord do these parts lie. This "localization" problem has as yet been almost the sole problem attacked, and therefore, despite its limited scope and interest, the results attained in it may be briefly mentioned here.

Localization.—The sensations usually grouped under the name of touch may with advantage, as shown by Head, be distinguished from the point of view of their practical elicitation into superficial and deep. The former of these are referable to stimulation of afferent nerve-fibres distributed actually to the skin, the latter to stimulation of deeper afferents subjacent to the skin. The touch-fibres belonging to the skin proper are further subdivisible, as Head has shown, into two kinds. One kind, the *protopathic*, yield sensations so suffused with disagreeable affective tone (skin-pain) that they may for the present purpose be considered pain-nerves, and the description of their spinal connexions be relegated to the paragraph dealing with the spinal path for pain. The other kind, the *epicritic*, are those which react to tangible stimuli lightly applied, such as stroking the skin with a loose pledget of cotton wool or the light touching of the skin with a pin's head or a blunt pencil point. Deep touch, on the other hand, involves afferent nerve fibres supplied by nerve-trunks not classed as cutaneous, but probably largely muscular in the sense that they run to muscles and contain side by side the afferent fibres in question and the efferent nerve-fibres causing muscular contraction. Head has brought forward clear evidence that though the afferent fibres subserving the epicritic tactual sense of the skin and deep touch of subcutaneous origin run so separate a course in the peripheral nerves, the spinal fibres constituting the intraspinal headward-running paths from these two kinds of peripheral touch-fibres, the epicritic and the deep, to the brain, lie together and are implicated together by injuries of the spinal cord. In this sense there is, therefore, in the cord a tactual path. The question

is, therefore, what course does this path follow in the cord? In the first place it must be noted that the path contains a synapse for the peripheral neurone whether belonging to the epicritic tactual group or to the deep tactual group ends in the cord, probably not far, *i.e.* not more than four or five segments, from its place of entrance. The rest of the headward path must therefore run through one secondary neurone at least, it may be through a series of such arranged as a headward running line of relays. It is, however, more probable that one long secondary neurone reaching the bulb covers the whole of the remaining spinal part of the trajectory. The part of the headward-running path formed by the intraspinal part of the peripheral neurone (primary afferent neurone) lies certainly in the dorsal column of the cord of the same lateral half as the side from which the neurone entered, *i.e.* in the right dorsal column if the neurone entered by a spinal root of the right side. The secondary neurone continuing the path lies, however, in the ventral column of the crossed half of the cord. The junction or synapse between the primary and secondary neurone lies, of course, in the grey matter of the spinal cord.

The spinal path of impulses which when they reach the brain occasion pain has been determined chiefly in regard to pain referred to the skin. The primary afferent neurones bringing these impulses to the cord are the protopathic of Head mentioned above. These, there is much evidence to show, terminate in the grey matter of the cord not far from their point of entrance into the cord, that is, they terminate intraspinally nearer their point of entrance than do the corresponding primary afferent neurones for touch. From the local spinal grey matter the pain-path is continued headward in the lateral white columns of the cord by secondary afferent neurones. These secondary afferent neurones run chiefly in the lateral column of the opposite half of the cord from that which the primary afferent neurones entered; but some run up the lateral column of the same side as that by which the primary neurones entered. The synapse between the primary afferent neurone and the secondary afferent neurone of this path lies probably in the grey matter called *substantia gelatinosa* of the dorsal horn.

The spinal path taken by the impulses concerned with sensations of heat and cold seems to agree closely with that taken by the impulses subserving skin pain. The position of the nerve-fibres belonging to the secondary afferent neurones of the pain and temperature path has been fairly successfully identified with that of the spinal tract called Gowers' tract. The uncrossed portion of the temperature path appears, however, to be relatively smaller as compared with its crossed portion than is that of pain.

There is much evidence that impulses contributory to "muscular sense" pass headward along the spinal cord and in their course remain for the most part uncrossed. This course would in so far agree with the course taken by the intraspinal continuations of the primary afferent neurones which form the long fibres of the dorsal columns. These are known to run to the bulb without transgressing the median plane at all. In addition to this uncrossed tract there is another, namely, that offered by the dorsal cerebellar tract, a tract of secondary neurones connected through the grey matter of the vesicular column of Clarke with primary afferent neurones of the ipsilateral side. Either or both of these uncrossed tracts may be the path taken by the impulses subserving muscular sense, and there is experimental evidence in favour of such a possibility, but the question cannot be considered as definitely answered at present.

Besides the paths followed by headward-running impulses the spinal cord contains paths for impulses passing along it backwards from the brain. These paths lie almost entirely in the ventrolateral columns of the cord. The fibres of which they are composed cross but little in the cord. Their sources are various, some come from the hind brain and some from the mid brain, and in the higher mammalia, especially in man and in the anthropoid apes, a large tract of fibres in the lateral column (the crossed pyramidal tract) comes from the cortex of the neopallium of the fore brain. This last tract is

the main medium by which impulses initiated by electrical stimulation of the motor cortex reach the moto-neurones of the cord and through them influence the activity of the skeletal muscles. Of the function of the other tracts descending from the brain into the cord little is known except that mediately or immediately they excite or inhibit the spinal moto-neurones by various levels. How they harmonize one with another in their action or what their purpose in normal life may be is at present little more than conjecture. Such terms, therefore, as "paths for volition," &c., are at present too schematic in their basis to warrant their discussion here. (C. S. S.)

SPINEL, a name now given to a group of minerals, of which the typical member is a magnesium aluminate, sometimes used as a gem-stone, to which the term "spinel" was originally restricted. The name comes from the French *spinelle* (diminutive of Lat. *spina*), perhaps suggested by the sharp angles of the crystals. All spinels crystallize in the cubic system, usually in octahedra, and often twinned as in the accompanying figure, which is a form so characteristic as to be called the "spinel twin." The hardness of spinel is about that of topaz (8) and its specific gravity near that of diamond. Professor A. H. Church gives the range in variously coloured spinels as 3.582 to 3.715. Pure spinel is colourless, but most varieties are coloured, no doubt in many cases with iron and probably in some with chromium. The deep red spinel is known as "spinel-ruby," or "ruby-spinel," and has often been taken for true ruby, from which it is distinguished, however, by being singly refracting and therefore not dichroic, as well as by its inferior hardness and density. The "balas ruby" is a rose-red spinel, said to derive its name from Balkh, the capital of Badakshan (Balaxia), where it occurs with rubies, and was formerly worked, chiefly in the Shighnan valley, in the upper Oxus basin. Rubicelle is a spinel in which the red colour tends to orange, whilst in almandine-spinel it passes into violet. Stones of the colour of vinegar are called vinegar-spinel. When the colour is blue the mineral is known as sapphire-spinel, and when green as chloro-spinel.

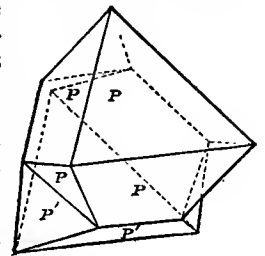

The spinels used in jewelry are found mostly in gem-gravels, where, however, the octahedral form is often well preserved. The chief localities are Ceylon, Siam and Upper Burma. In all these localities the spinels accompany the coloured corundums, and their close association with true rubies led Tavernier to call spinel "the mother of ruby." Formerly there was much confusion between the two minerals, and probably many stones described as monster rubies have been spinels. The great historic "ruby" set in the Maltese cross in front of the Imperial state crown of England is really a spinel. This fine stone was given to Edward the Black Prince by Pedro the Cruel, king of Castile, on the victory of Najera in 1367, and it was afterwards worn by Henry V. at the battle of Agincourt, when it narrowly escaped destruction. V. Ball described, in 1894, a spinel weighing 133½ carats, engraved with a Persian inscription, then in the possession of Lady Carew.

All the isomorphous minerals known as the group of spinellids, of which spinel is the type, crystallize in regular octahedra and have a composition conforming to the general formula $R''R_2''O_4$ ($=R''O \cdot R_2''O_3$). Ordinary spinel is $MgAl_2O_4$. A black opaque spinel in which Fe partly replaces Mg is known as pleonaste (*πλεονάστος*, abundant, from the number of faces on certain crystals) or ceylonite, from the island of Ceylon, but sometimes written ceylanite. It occurs in gneiss, often with cordierite, and is found also in the ejected blocks of Monte Somma, Vesuvius. Large crystals come from Warwick and Amity, Orange county, New York, U.S.A. The black spinels are generally green or brown when viewed in thin sections by transmitted light. In some cases spinel is evidently a result of contact metamorphism, whilst in others it has crystallized out of a molten magma, as illustrated by the experiments of J. Morozewicz. A chrome-spinel with the formula $(Mg,Fe)(Al,Fe,Cr)_2O_4$ is named picotite, after Picot de la Peyrouse, who described it. Picotite occurs in the form of black grains and crystals in certain olivine rocks and in serpentine. A black iron-spinel ($FeAl_2O_4$),

found in the granulites of Saxony and Bohemia, is known as hercynite from the Hercynian Forest. A zinc-spinel ($ZnAl_2O_4$), occurring in talcose slate near Falun in Sweden, is named gahnite, after its discoverer J. G. Gahn; whilst it has also been termed automolite from Gr. *αὐτόμολος*, a deserter, in allusion to the occurrence of zinc in a mineral where it was unexpected. The group of spinellids includes, as its extreme members, magnetite ($Fe''Fe'''O_4$) and chromite ($FeCr_2O_4$) (*q.v.*) (F. W. R.*)

SPINELLO ARETINO (c. 1330–c. 1410), Italian painter, the son of a Florentine named Luca, who had taken refuge in Arezzo in 1310 when exiled with the rest of the Ghibelline party, was born at Arezzo about 1330. Spinello was a pupil of Jacopo di Casentino, a follower of Giotto, and his own style was a sort of link between the school of Giotto and that of Siena. In the early part of his life he worked in Florence as an assistant to his master Jacopo while painting frescoes in the church of the Carmine and in Sta Maria Novella. Between 1360 and 1384 he was occupied in painting many frescoes in and near Arezzo, almost all of which have now perished. After the sack of Arezzo in 1384 Spinello returned to Florence, and in 1387–1388 with some assistants covered the walls and vault of the sacristy of S. Miniato near Florence with a series of frescoes, the chief of which represent scenes from the life of St Benedict. These still exist, though in a sadly restored condition; they are very Giotto-like in composition, but have some of the Siena decorative brilliance of colour. In 1391–1392 Spinello was painting six frescoes, which still remain on the south wall of the Pisan Campo Santo, representing miracles of St Potitus and St Ephesus. For these he received 270 gold florins. Among his later works the chief are the very fine series of frescoes painted in 1407–1408 on the walls and vault of a chapel in the municipal buildings of Siena; these also have suffered much from repainting, but still are the finest of Spinello's existing frescoes. Sixteen of these represent the war of Frederick Barbarossa against the republic of Venice. Spinello died at Arezzo about 1410.

Spinello's frescoes are all strong and highly decorative works, drawn with much spirit, and are very superior in style to his panel pictures, many of which appear to be mere *bottega* productions. The academy of Florence possesses a panel of the "Madonna and Saints," which is chiefly interesting for its signature—"Hoc opus pinxit Spinellus Luce Aritio D.I.A.(1391)." The easel pictures which are to be found in the various galleries of Europe give little or no notion of Spinello's power as a painter.

SPINET, or SPINETT (Fr. *espinette* or *épinette*; Ger. *Spinett*; Ital. *spinetta*), names given in England to all small keyboard instruments irrespective of shape, having one string to a note, plucked by means of a quill or plectrum of leather. The earliest name recorded for this instrument is *clavicymbalum*, which occurs in the rules of the Minnesingers (1404), and also in the *Wunderbuch* (1440), a MS. preserved in the grand-ducal library at Weimar. This is enriched with pen and ink sketches, amongst which is a series of musical instruments comprising a *clavicymbalum*, not represented as the rectangular instrument figured by Virdung and Luscinius, but harp- or wing-shaped like the larger and more perfect instrument afterwards known as harpsichord in England (*clavecin*, *clavicymbel*).

In Italy the usual early model of spinet was pentagonal or heptagonal, and was generally enclosed in an outer case, from which it was taken for performance. Some of the oldest rectangular specimens merely contain a pentagonal spinet, the corners not being filled in. In the 16th century the rectangular spinets were modelled in Italy on the *cassone* or wedding coffers, and the keyboard, until the middle of that century, stood out from the case, Rosso of Milan being the first to recess it. Both forms were in use in England until the Restoration, when the transverse or wing form became popular in England, Haward, Stephen Keene and Thomas Hitchcock being the most celebrated English makers¹ at the end of the 17th and beginning of the 18th century.

The mechanism of all spinets, virginals and harpsichords is the same in principle, the principal variation being in the number of strings to each note and the manner in which they

¹ See A. J. Hipkins, *The History of the Pianoforte*, pp. 71–73 (London, 1896).

are disposed over the soundboard. In the spinets they run parallel or at an obtuse angle to the keyboard. The jack rests on the back of the key-lever, and works through a rectangular hole cut through the soundboard as the key is depressed. The quill or plectrum is embedded in a pivoted tongue near the top of the jack in such a manner that when the tongue is at rest the quill protrudes at right angles just under the string. As the jack rises the quill catches the string and twangs it, causing the tongue, kept in place by a bristle spring, to fall back and thus avoid the string on the return of the jack. A little piece of cloth acting as a damper and attached to the jack rests on the string whenever the key returns to its normal position.

For the history of the spinet, see PIANOFORTE.

(K. S.)

SPINNING (from O. Eng. *spinnan*, to spin, cf. Ger. *spinnen*, &c., the Teut. root is *spen*, to draw out, cf. span, spider), the forming of threads by drawing out and twisting various fibres. There is ample evidence of the great antiquity and wide diffusion of the art of spinning, for spinning necessarily precedes weaving (*q.v.*) whenever short fibrous materials have to be made into threads, and weaving is one of the primal and most universal employments of mankind. Either remains of implements employed in spinning, or spun threads, are found wherever traces of prehistoric man make their appearance. The simple spinning apparatus which was used in the earliest ages continued to be used by civilized communities till comparatively recent times, and it may therefore be said that no art which has been so long and widely practised remained so unprogressive as that of spinning. On the other hand, since about the middle of the 18th century, when human ingenuity bent itself in earnest to improve the art, there have not been developed in the whole range of mechanical industries machines of greater variety, delicacy of action, and manifold productive capacity than those now in use for spinning.

The primitive thread-making implement consisted of a wooden spindle, from 9 to 15 in. long, which was rounded and tapered at both extremities, as in the accompanying figure. Near the

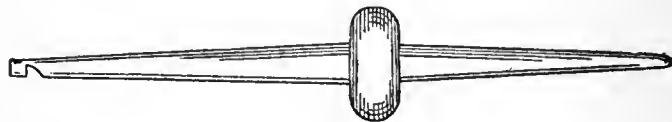

Primitive Spindle.

top there was usually a notch in which the yarn was caught while undergoing the operation of twisting, and lower down a whorl, or wharve, composed of a perforated disk of clay, stone, wood, or other material was secured to give momentum and steadiness to a rotating spindle. Long fibres were commonly attached to a distaff of wood, which was held under the left arm of the operator, but short fibres were spun from carded rolls. After attaching some twisted fibres to the spindle, a rotatory motion was given to the latter either by rolling it by hand against one thigh, or by twirling it between the fingers and thumb of the right hand, after which the fibres were drawn out in a uniform strand by both hands and converted into yarn. When the thread was of sufficient strength, the spindle was suspended by it until a full stretch had been drawn and twisted, after which that portion was wound upon the body of the spindle, and the operation continued until the spindle was filled. The quantity thus rolled up gives the name to a now definite measure of linen yarn, namely "the spindle," or 14,400 yards. Simple as was this primitive apparatus, a dexterous spinner could produce yarn of an evenness, strength and delicacy such as has scarcely been exceeded by elaborate modern appliances. The yarns for the gossamer-like Dacca muslins of India were so fine that 1 lb weight of cotton was spun into a thread nearly 253 m. long. This was accomplished with the aid of a bamboo spindle not much bigger than a darning needle, and which was lightly weighted with a pellet of clay. Since such a tender thread could not support even the weight of so slight a spindle, the apparatus was rotated upon a piece of hollow shell. The spindle as here described was, so far as is

known, the sole apparatus with which yarn was spun until comparatively recent times.

The changes in modern spinning have had for their object: (1) the providing of mechanical means to rotate the spindle, (2) an automatic method of drawing out the fibres, and (3) devices for working a large group of spindles together, at speeds before unattainable.

The first improvement consisted in cutting a ring groove in the wharve, mounting the spindle horizontally in a frame, and passing a band from a large wheel round the wharve. A rotatory motion was then given to the spindle by turning the wheel with the left hand. After attaching the filaments to the spindle they were attenuated with the right hand, and when fully twisted the thread was moved to form a right angle with the spindle and coiled upon it. Such a wheel has long been known in India, and from a drawing in a 14th-century manuscript in the British Museum it is obvious that it was not unknown, although far from being in general use, in Europe at that early date. It came ultimately to be known in England as the "bobbing wheel," and was in constant use down to the beginning of the 19th century for spinning coarse and fine yarns. But fine yarns received two spinnings; the first consisted in drawing out and slightly twisting the fibres into what is still known as a roving, and by the second spinning the roving was fully attenuated and twisted. In 1533, a citizen of Brunswick is said to have cranked the axis of the large wheel and added a treadle, by which the spinner was enabled to rotate her spindle with one foot and have both hands free to manipulate the fibres.

It is not possible accurately to fix the dates at which all improvements in spinning appliances were made; it is certain that many were known and used long before they were generally adopted. Thus the flyer, which twists yarn before winding it upon a bobbin, is shown in a drawing by Leonardo da Vinci, together with a device for moving the bobbin up and down the spindle so as to effect an even distribution of the yarn. During the 16th century a machine of the foregoing type was widely used, and came to be known as the Saxony wheel. It changed spinning from an intermittent to a continuous operation. The spindle had affixed upon its outer end a wooden flyer, whose forked legs were far enough apart to enclose a double-flanged spool, and at short intervals bent wires, known as the heck, were inserted in each leg for the purpose of guiding the thread evenly upon the spool. This spool was loosely threaded upon the spindle and one of its flanges was grooved to take a driving band from the large wheel, hence the spindle and the spool were separately driven, but the former at a higher speed than the latter. The twisted filaments were drawn through an eye in the flyer, led along one of its legs, and made fast to the spool. By operating the treadle the flyer twisted all the fibres about a common axis once for each revolution, and the spool wound up the length thus spun: the thread being slipped from tooth to tooth of the heck at regular intervals to direct it evenly across the spool. During the 17th century a second and similar spindle and flyer were added, and these left the spinner free to manipulate one thread with her right, and another with her left hand. It was in this condition that the most advanced form of yarn-making was carried on until a great series of inventions revolutionized spinning, and laid the foundations of the factory system which now prevails.

The remaining part of the problem which lay before inventors was to draw out masses of parallel fibrous material, and twist them into uniform strands by mechanical means. The first stage in the evolution of mechanical spinning was effected by the invention of Lewis Paul, of Birmingham, who obtained a patent in 1738, and who was assisted by John Wyatt. The essential features of this invention consisted in passing carded slivers between pairs of parallel rollers, each succeeding pair of which moved faster than the preceding pair, to attenuate the sliver to the required extent. From Paul's specification it would appear that he attempted to turn the rollers about their horizontal and vertical axes simultaneously, in order to draw out the fibres and twist them at one operation. But he

also mentions a plan for which he procured a patent twenty years later, namely, the use of only one pair of rollers working in conjunction with a bobbin which drew off the thread faster than the rollers delivered the sliver, and coiled the thread about itself. The bobbin, therefore, attenuated, twisted and wound the material. Neither plan proved a commercial success. Thomas Highs, of Leigh, and others, laboured upon the problem, but it was left to Richard Arkwright, a barber, of Preston and Bolton, to achieve what his predecessors vainly struggled for. He obtained patents, in 1769 and 1775, for a machine which was subsequently known as the water-twist frame by reason of water-power being applied to drive it. Arkwright's first machine did not contain any really new feature, for it consisted of Paul's drawing rollers, and the spindle, flyer and spool from the Saxony wheel, but the spindles and rollers were grouped in sets of four. Later the water-twist frame was changed into the "throstle" frame, which in turn has almost ceased to be used. In 1829 C. Danforth (1797-1876), an American spinner, invented a dead spindle, on the top of which he placed a hollow cap to serve as the winding point, and inside the cap he rotated a spool: a plan still used by worsted spinners. In 1828 Mr Thorpe, also an American, invented the ring spinning frame, whose principal feature consisted in the substitution for the flyer of a flanged annular ring, and a light C-shaped traveller. By means of the traveller a thread was held in the best position for winding upon a spool, as well as put under the necessary tension. Later inventors have so altered the construction of the ring, traveller and spindle that a speed of upwards of 11,000 revolutions per minute can now be attained. This represents the highest development of continuous spinning.

Whilst endeavours were being made to perfect continuous spinning, attention was also directed to perfecting the intermittent process as represented by the bobbing wheel. Between the years 1764 and 1767, James Hargreaves, of Standhill, invented the spinning jenny, by the aid of which sixteen, or more, threads could be spun simultaneously by one person. All the spindles were placed vertically and rotated from a drum, but the rovings were mounted in a movable carriage and passed between a clamp that opened and shut like a parallel ruler. After securely clamping the rovings and attaching them to the spindles, the carriage was drawn out slowly by one hand and the spindles revolved by the other. The rovings were thus stretched to the proper degree of tenuity, and sufficiently twisted. This was followed by the inward run of the carriage, when the stretch of spun threads was wound upon the spindles, and the operation repeated. Hargreaves therefore returned to the first principles of spinning, namely, simultaneous drawing and twisting. But although the jenny gave a greatly increased output, it was ill adapted for fine spinning. During the years 1774 to 1779, Samuel Crompton, of Bolton, combined, in the mule, the drawing rollers of Paul with the stretching of Hargreaves. But his rollers did not fully attenuate the rovings before twisting them, as is the case with continuous spinning, neither was stretching alone relied upon. From its introduction this machine was able to spin finer and more elastic threads than any of its rivals, but for a time the preparation of suitable rovings was a source of great trouble. The immediate consequence of the decision of the court of King's Bench, in 1785, to throw open to the public Arkwright's preparatory machinery, was to enormously increase the usefulness of the mule. Since Crompton's time a host of inventors have laboured to render all parts of the mule thoroughly automatic; this has led to many changes and additions, but none of its essential features have been discarded. The inventions of Paul, Arkwright, Hargreaves and Crompton are at the foundations of all modern systems of spinning; details regarding them are given in the article on COTTON-SPINNING MACHINERY. (T. W. F.)

SPINOLA, AMBROSE, MARQUIS DE LOS BALBASES (1569-1630), Spanish general, was born in Genoa in 1569. He was the eldest son of Philip Spinola, marquis of Sesto and Benafro, and his wife Policena, daughter of the prince of Salerno. The family of Spinola was of great antiquity, wealth and power in Genoa.

In the 16th century the republic was practically a protected state under the power of Spain, the Genoese being the bankers of the monarchy and having entire control of its finances. Several of the younger brothers of Ambrose Spinola sought their fortune in Spain, and one of them, Frederick, distinguished himself greatly as a soldier in Flanders. The eldest brother remained at home to marry and continue the family. In 1592 he was married to Joanna Bacciadonna, daughter of the count of Galerrata. The houses of Spinola and Doria were rivals for authority within the republic. Ambrose Spinola continued the rivalry with the count of Tursi, then the chief of the Dorias. He was not successful, and having lost a lawsuit into which he had entered to enforce a right of pre-emption of a palace belonging to the Salerno family which the Dorias wished to purchase, he decided to withdraw from the city and advance the fortunes of his house by serving the Spanish monarchy in Flanders. In 1602 he and his brother Frederick entered into a contract with the Spanish government—a "condotta" on the old Italian model. It was a speculation on which Spinola risked the whole of the great fortune of his house. Ambrose Spinola undertook to raise 9000 men for land service, and Frederick to form a squadron of galleys for service on the coast. Several of Frederick's galleys were destroyed by English war-ships on his way up channel. He himself was slain in an action with the Dutch on the 24th of May 1603. Ambrose Spinola marched overland to Flanders in 1602 with the men he had raised at his own expense. During the first months of his stay in Flanders the Spanish government played with schemes for employing him on an invasion of England, which came to nothing. At the close of the year he returned to Italy for more men. His actual experience as a soldier did not begin till as general, and at the age of thirty-four, he undertook to continue the siege of Ostend on the 29th of September 1603. The ruinous remains of the place fell into his hands on the 22nd of September 1604. The archduke Albert and the infanta Clara Eugenia, daughter of Philip II., who then governed Flanders and had set their hearts on taking Ostend, were delighted at his success, and it won him a high reputation among the soldiers of the time. On the close of the campaign he went to Spain to arrange with the court, which was then at Valladolid, for the continuance of the war. At Valladolid he insisted on being appointed commander-in-chief in Flanders. By the 9th of April he was back at Brussels, and entered on his first campaign. The wars of the Low Countries consisted at that time almost wholly of sieges, and Spinola made himself famous by the number of places he took in spite of the efforts of Maurice of Nassau to save them. In 1606 he again went to Spain. He was received with much outward honour, and entrusted with a very secret mission to secure the government of Flanders in case of the death of the archduke or his wife, but he could not obtain the grandeeship which he desired, and was compelled to pledge the whole of his fortune as security for the expenses of the war before the bankers would advance funds to the Spanish government. As he was never repaid, he was in the end utterly ruined. The Spanish government began now to have recourse to devices for keeping him away from Spain. Until the signing of the twelve years' truce in 1609 he continued to command in the field with general success. After it was signed he retained his post, and had among other duties to conduct the negotiations with France when the prince of Condé fled to Flanders with his wife in order to put her beyond the reach of the senile admiration of Henry IV. of France. By 1611 Spinola's financial ruin was complete, but he obtained the desired "grandeza." In 1614 he had some share in the operations connected with the settlement of Cleves and Juliers. On the outbreak of the Thirty Years' War he made a vigorous campaign in the lower Palatinate and was rewarded by the grade of captain-general. After the renewal of the war with Holland in 1621 he gained the most renowned victory of his career—the capture of Breda after a long siege (Aug. 28, 1624–June 5, 1625) and in spite of the most strenuous efforts of the prince of Orange (Frederick Henry) to save it. The surrender of Breda is the subject of the great

picture by Velasquez, known as "Las Lanzas"; the portrait of Spinola is from memory.

The taking of Breda was the culmination of Spinola's career. Utter want of money paralysed the Spanish government, and the new favourite, Olivares, was jealous of the general. Spinola could not prevent Frederick Henry of Nassau from taking Groll, a good set-off for Breda. In January 1628 he left for Spain, resolved not to resume the command in Flanders unless security was given him for the support of his army. At Madrid he had to endure much insolence from Olivares, who endeavoured to make him responsible for the loss of Groll. Spinola was resolute not to return to Flanders. Meanwhile the Spanish government added a war over the succession to the duchy of Mantua to its other burdens. Spinola was appointed as plenipotentiary and general. He landed at Genoa on the 19th of September 1629. In Italy he was pursued by the enmity of Olivares, who caused him to be deprived of his powers as plenipotentiary. Spinola's health broke down, and, having been robbed of his money, grudged the compensation he asked for his children and disgraced in the presence of the enemy, he died on the 25th of September 1630 at the siege of Casale, muttering the words "honour" and "reputation." The title of marquis of Los Balbases, still borne by his representatives in Spain, was all that his family received for the vast fortune they spent in the service of Philip III. and IV.

Don A. Rodriguez Villa has published a biography well supplied with original documents—*Ambrosio Spinola, primer marques de los Balbases* (Madrid, 1905). (D. H.)

SPINOLA, CRISTOVAL ROJAS DE (d. 1695), Spanish ecclesiastic, was general of the Franciscan order in Madrid. He went to Vienna as confessor to the Spanish wife of Leopold I., and became bishop of Wienerisch-Neustadt in 1685. He endeavoured to reconcile the Protestant churches with the Roman Catholic, and at a conference at Hanover in 1683 presented his *Regulae circa Christianorum omnium ecclesiasticum reunionem*. The Helmstädt theologians, represented by Gerhard Molanus (1633–1722), at the same time put forward their *Methodus reducendae unionis*. The discussions were approved by the pope and the emperor, but had no popular feeling behind them, and though the negotiations were continued for ten years, especially between Molanus on the one side and Bossuet on the other, no agreement was reached, for the Protestants could not accept the Council of Trent as authoritative or surrender the matter of communion under both species. Spinola died on the 12th of March 1695.

SPINOZA, BARUCH (1632–1677), or, as he afterwards signed himself, Benedict de Spinoza, Dutch philosopher, was born at Amsterdam on the 24th of November 1632. His parents belonged to the community of Jewish emigrants from Portugal and Spain who, fleeing from Catholic persecution in the Peninsula, had sought refuge in the nearly emancipated Netherlands. The name, variously written Espinoza, De Spinoza, D'Espinoza and Despinoza, probably points to the province of Leon as the previous home of the family; there are no fewer than five townships so called in the neighbourhood of Burgos. The philosopher's grandfather appears to have been the recognized head of the Jewish community in Amsterdam in 1628, and his father, Michael Espinoza, was repeatedly warden of the synagogue between 1630 and 1650. The father was a merchant in fair circumstances. He was thrice married and had six children, all of whom predeceased him save a daughter Rebekah, born of the first marriage, and Baruch, the son of his second wife. Spinoza's mother died in 1638 when the boy was barely six years old, and his father in 1654 when he was in his twenty-second year. Spinoza received his first training under the senior rabbi, Saul Levi Morteira, and Manasseh ben Israel, a theological writer of some eminence whose works show considerable knowledge of philosophical authors. Under these teachers he became familiar with the Talmud and, what was probably more important for his own development, with the philosophical writings of Ibn Ezra and Maimonides, Levi ben Gerson, Hasdai Crescas, and other representatives of Jewish

medieval thought, who aim at combining the traditional theology with ideas got from Aristotle and his Neoplatonic commentators. Latin, still the universal language of learning, formed no part of Jewish education; and Spinoza, after learning the elements from a German master, resorted for further instruction to a physician named Franz van den Ende, who eked out an income by taking pupils. Van den Ende appears to have been distinctly a man of parts, though of a somewhat indiscreet and erratic character. He was eventually hanged in Paris as a conspirator in 1674. His enthusiasm for the natural sciences may have been the only ground for the reputation he had acquired of instilling atheistic notions into the minds of his pupils along with the Latin which he taught them. But it is quite possible that his scientific studies had bred in him, as in many others at that time, a materialistic, or at least a naturalistic, turn of mind; indeed, we should expect as much in a man of Van den Ende's somewhat rebellious temperament. We do not know whether his influence was brought to bear in this sense upon Spinoza; but it has been suggested that the writings of Bruno, whose spirit of enthusiastic naturalism and fervid revolt against the Church would be especially dear to a man of Van den Ende's leanings, may have been put into the pupil's hand by the master. Latin, at all events, Spinoza learned to use with correctness, freedom and force, though his language does not, of course, conform to classical canons.

A romance has woven itself round Spinoza's connexion with Van den Ende's household. The physician had an only daughter, Clara Maria by name, who, besides being proficient in music, understood Latin, it is said, so perfectly that she was able to teach her father's pupils in his absence. Spinoza, the story goes, fell in love with his fair instructress; but a fellow-student, called Kerckering, supplanted him in his mistress's affections by the help of a valuable necklace of pearls which he presented to the young lady. Chronology unfortunately forbids us to accept this little episode as true. Recent investigation has proved that, while the marriage with Kerckering, or rather Kerckrink, is a fact, it did not take place till 1671, in which year the bride, as appears by the register, was twenty-seven years of age. She cannot, therefore, have been more than eleven, or twelve in 1656, the year in which Spinoza left Amsterdam; and as Kerckrink was seven years younger than Spinoza, they cannot well have been simultaneous pupils of Van den Ende's and simultaneous suitors for his daughter's hand. But, though the details of the story thus fall to pieces, it is still possible that in the five years which followed his retirement from Amsterdam Spinoza, who was living within easy distance and paid visits to the city from time to time, may have kept up his connexion with Van den Ende, and that the attachment may have dated from this later period. This would at least be some explanation for the existence of the story; for Colerus expressly says that Spinoza "often confessed that he meant to marry her." But there is no mention of the Van den Endes in Spinoza's correspondence; and in the whole tenor of his life and character there is nothing on which to fasten the probability of a romantic attachment.

The mastery of Latin which he acquired from Van den Ende opened up to Spinoza the whole world of modern philosophy and science, both represented at that time by the writings of Descartes. He read him greedily, says Colerus, and afterwards often declared that he had all his philosophical knowledge from him. The impulse towards natural science which he had received from Van den Ende would be strengthened by the reading of Descartes; he gave over divinity, we are told, to devote himself entirely to these new studies. His inward break with Jewish orthodoxy dated, no doubt, further back—from his acquaintance with the philosophical theologians and commentators of the middle ages; but these new interests combined to estrange him still further from the traditions of the synagogue. He was seldom seen at its services—soon not at all. The jealousy of the heads of the synagogue was easily roused. An attempt seems to have been made to draw from him his real opinions on certain prominent points of divinity. Two so-called friends

endeavoured, on the plea of doubts of their own, to lead him into a theological discussion; and, some of Spinoza's expressions being repeated to the Jewish authorities, he was summoned to give an account of himself. Anxious to retain so promising an adherent, and probably desirous at the same time to avoid public scandal, the chiefs of the community offered him a yearly pension of 1000 florins if he would outwardly conform and appear now and then in the synagogue. But such deliberate hypocrisy was abhorrent to Spinoza's nature. Threats were equally unavailing, and accordingly on the 27th of July 1656 Spinoza was solemnly cut off from the commonwealth of Israel. The curses pronounced against him may be read in most of the biographies. While negotiations were still pending, he had been set upon one evening by a fanatical ruffian, who thought to expedite matters with the dagger. Warned by this that Amsterdam was hardly a safe place of residence for him any longer, Spinoza had already left the city before the sentence of excommunication was pronounced. He did not go far, but took up his abode with a friend who lived some miles out on the Old Church road. His host belonged to the Collegiants or Rhijsburgers, a religious society which had sprung up among the proscribed Arminians of Holland. The pure morality and simple-minded piety of this community seem early to have attracted Spinoza, and to have won his unfeigned respect. Several of his friends were Collegiants, or belonged to the similarly minded community of the Mennonites, in which the Collegiants were afterwards merged. In this quiet retreat Spinoza spent nearly five years. He drew up a protest against the decree of excommunication, but otherwise it left him unmoved. From this time forward he disused his Hebrew name of Baruch, adopting instead the Latin equivalent, Benedictus. Like every Jew, Spinoza had learned a handicraft; he was a grinder of lenses for optical instruments, and was thus enabled to earn an income sufficient for his modest wants. His skill, indeed, was such that lenses of his making were much sought after, and those found in his cabinet after his death fetched a high price. It was as an optician that he was first brought into connexion with Huygens and Leibnitz; and an optical *Treatise on the Rainbow*, written by him and long supposed to be lost, was discovered and reprinted by Dr Van Vloten in 1862. He was also fond of drawing as an amusement in his leisure hours; and Colerus had seen a sketch-book full of such drawings representing persons of Spinoza's acquaintance, one of them being a likeness of himself in the character of Masaniello.

The five years which followed the excommunication must have been devoted to concentrated thought and study. Before their conclusion Spinoza had parted company from Descartes, and the leading positions of his own system were already clearly determined in his mind. A number of the younger men in Amsterdam—many of them students of medicine or medical practitioners—had also come to regard him as their intellectual leader. A kind of philosophical club had been formed, including among its members Simon de Vries, John Bresser, Louis Meyer, and others who appear in Spinoza's correspondence. Originally meeting in all probability for more thoroughgoing study of the Cartesian philosophy, they looked naturally to Spinoza for guidance, and by and by we find him communicating systematic drafts of his own views to the little band of friends and students. The manuscript was read aloud and discussed at their meetings, and any points remaining obscure were referred to Spinoza for further explanation. An interesting specimen of such difficulties propounded by Simon de Vries and resolved by Spinoza in accordance with his own principles, is preserved for us in Spinoza's correspondence. This Simon de Vries was a youth of generous impulses and of much promise. Being in good circumstances, he was anxious to show his gratitude to Spinoza by a gift of 2000 florins, which the philosopher half-jestingly excused himself from accepting. De Vries died young, and would fain have left his fortune to Spinoza; but the latter refused to stand in the way of his brother, the natural heir, to whom the property was accordingly left, with the condition that he should pay to Spinoza an annuity sufficient for his maintenance. The heir

offered to fix the amount at 500 florins, but Spinoza accepted only 300, a sum which was regularly paid till his death. The written communications of his own doctrine referred to above belong to a period after Spinoza had removed from the neighbourhood of Amsterdam; but it has been conjectured that the *Short Treatise on God, on Man, and his Wellbeing*, which represents his thoughts in their earliest systematic form, was left by him as a parting legacy to this group of friends. It is at least certain, from a reference in Spinoza's first letter to Oldenburg, that such a systematic exposition was in existence before September 1661.¹ There are two dialogues somewhat loosely incorporated with the work which probably belong to a still earlier period. The short appendix, in which the attempt is made to present the chief points of the argument in geometrical form, is a forerunner of the *Ethics*, and was probably written somewhat later than the rest of the book. The term "Nature" is put more into the foreground in the *Treatise*, a point which might be urged as evidence of Bruno's influence—the dialogues, moreover, being specially concerned to establish the unity, infinity and self-containedness of Nature²; but the two opposed Cartesian attributes, thought and extension, and the absolutely infinite substance whose attributes they are—substance constituted by infinite attributes—appear here as in the *Ethics*. The latter notion—of substance—is said to correspond exactly to "the essence of the only glorious and blessed God." The earlier differs from the later exposition in allowing an objective causal relation between thought and extension, for which there is substituted in the *Ethics* the idea of a thoroughgoing parallelism. The *Short Treatise* is of much interest to the student of Spinoza's philosophical development, for it represents, as Martineau says, "the first landing-place of his mind in its independent advance." Although the systematic framework of the thought and the terminology used are both derived from the Cartesian philosophy, the intellectual *milieu* of the time, the early work enables us, better than the *Ethics* to realize that the inspiration and starting-point of his thinking is to be found in the religious speculations of his Jewish predecessors. The histories of philosophy may quite correctly describe his theory as the logical development of Descartes's doctrines of the one Infinite and the two finite substances, but Spinoza himself was never a Cartesian. He brought his pantheism and his determinism with him to the study of Descartes from the mystical theologians of his race.

Early in 1661 Spinoza's host removed to Rhijnsburg near Leiden, the headquarters of the Collegiant brotherhood, and Spinoza removed with him. The house where they lived at Rhijnsburg is still standing, and the road bears the name of Spinoza Lane. Very soon after his settlement in his new quarters he was sought out by Henry Oldenburg, the first secretary of the Royal Society.³ Oldenburg became Spinoza's most

¹ Various manuscript copies were apparently made of the treatise in question, but it was not printed, and dropped entirely out of knowledge till 1852, when Edward Böhmer of Halle lighted upon an abstract of it attached to a copy of Colerus's *Life*, and shortly afterwards upon a Dutch MS. purporting to be a translation of the treatise from the Latin original. This was published in 1862 by Van Vloten with a retranslation into Latin. Since then a superior Dutch translation has been discovered, which has been edited by Professor Schaarschmidt and translated into German. Another German version with introduction and notes has been published by Sigwart based on a comparison of the two Dutch MSS. A scholarly English translation similarly equipped was published by A. Wolf in 1910.

² The fact that Spinoza nowhere mentions Bruno would not imply, according to the literary habits of those days, that he was not acquainted with his speculations and even indebted to them. There is no mention, for example, of Hobbes throughout Spinoza's political writing, and only one casual reference to him in a letter, although the obligation of the Dutch to the English thinker lies on the surface. Accordingly, full weight must be allowed to the internal evidence brought forward by Sigwart, Avernarius and others to prove Spinoza's acquaintance with Bruno's writings. But the point remains quite doubtful and is in any case of little importance.

³ Heinrich Oldenburg (c. 1626–1678) was a native of Bremen, but had settled in England in the time of the commonwealth. Though hardly a scientific man himself, he had a genuine interest in science, and must have possessed social gifts. He was the friend of

regular correspondent—a third of the letters preserved to us are to or from him; and it appears from his first letter that their talk on this occasion was "on God, on infinite extension and thought, on the difference and the agreement of these attributes, on the nature of the union of the human soul with the body, as well as concerning the principles of the Cartesian and Baconian philosophies." Spinoza must, therefore, have unbosomed himself pretty freely to his visitor on the main points of his system. Oldenburg, however, was a man of no speculative capacity, and, to judge from his subsequent correspondence, must have quite failed to grasp the real import and scope of the thoughts communicated to him. From one of Oldenburg's early letters we learn that the treatise *De intellectus emendatione* was probably Spinoza's first occupation at Rhijnsburg. The nature of the work also bears out the supposition that it was first undertaken. It is, in a manner, Spinoza's "organon"—the doctrine of method which he would substitute for the corresponding doctrines of Bacon and Descartes as alone consonant with the thoughts which were shaping themselves or had shaped themselves in his mind. It is a theory of philosophical truth and error, involving an account of the course of philosophical inquiry and of the supreme object of knowledge. It was apparently intended by the author as an analytical introduction to the constructive exposition of his system, which he presently essayed in the *Ethics*. But he must have found as he proceeded that the two treatises would cover to a large extent the same ground, the account of the true method merging almost inevitably in a statement of the truth reached by its means. The *Improvement of the Understanding* was therefore put aside unfinished, and was first published in the *Opera posthuma*. Spinoza meanwhile concentrated his attention upon the *Ethics*, and we learn from the correspondence with his Amsterdam friends that a considerable part of book i. had been communicated to the philosophical club there before February 1663. It formed his main occupation for two or three years after this date. Though thus giving his friends freely of his best, Spinoza did not cast his thoughts broadcast upon any soil. He had a pupil living with him at Rhijnsburg whose character seemed to him lacking in solidity and discretion. This pupil (probably Albert Burgh, who afterwards joined the Church of Rome and penned a foolishly insolent epistle to his former teacher) was the occasion of Spinoza's first publication—the only publication indeed to which his name was attached. Not deeming it prudent to initiate the young man into his own system, he took for a textbook the second and third parts of Descartes's *Principles*, which deal in the main with natural philosophy. As he proceeded he put Descartes's matter in his own language and cast the whole argument into a geometric form. At the request of his friends he devoted a fortnight to applying the same method to the first or metaphysical part of Descartes's philosophy, and the sketch was published in 1663, with an appendix entitled *Cogitata metaphysica*, still written from a Cartesian standpoint (defending, for example, the freedom of the will), but containing hints of his own doctrine. The book was revised by Dr Meyer for publication and furnished by him, at Spinoza's request, with a preface in which it is expressly stated that the author speaks throughout not in his own person but simply as the exponent of Descartes. A Dutch translation appeared in the following year.⁴

In 1663 Spinoza removed from Rhijnsburg to Voorburg, a suburban village about 2 m. from the Hague. His reputation had continued to spread. From Rhijnsburg he had paid frequent visits to the Hague, and it was probably the desire

Boyle, and acquainted with most of the leaders of science in England as well as with many on the Continent. He delighted to keep himself in this way *au courant* with the latest developments, and lost no opportunity of establishing relations with men of scientific reputation. It was probably at the suggestion of Huygens that he bent his steps towards Spinoza's lodging.

⁴ The title of the Latin original ran—*Renati des Cartes principiorum philosophiae pars i. et ii. more geometrico demonstratae per Benedictum de Spinoza Amstelodamensem. Accesserunt ejusdem cogitata metaphysica.*

to be within reach of some of the friends he had made in these visits—among others the De Witts—that prompted his changed residence. He had works in hand, moreover, which he wished in due time to publish; and in that connexion the friendly patronage of the De Witts might be of essential service to him. The first years at Voorburg continued to be occupied by the composition of the *Ethics*, which was probably finished, however, by the summer of 1665. A journey made to Amsterdam in that year is conjectured to have had reference to its publication. But, finding that it would be impossible to keep the authorship secret, owing to the numerous hands through which parts of the book had already passed, Spinoza determined to keep his manuscript in his desk for the present. In September 1665 we find Oldenburg twitting him with having turned from philosophy to theology and busying himself with angels, prophecy and miracles. This is the first reference to the *Tractatus theologico-politicus*, which formed his chief occupation for the next four years. The aim of this treatise may be best understood from the full title with which it was furnished—*Tractatus theologico-politicus, continens dissertationes aliquot, quibus ostenditur libertatem philosophandi non tantum salva pietate et reipublicae pace posse concedi sed eandem nisi cum pace reipublicae ipsaque pietate tolli non posse*. It is, in fact, an eloquently reasoned defence of liberty of thought and speech in speculative matters. The external side of religion—its rites and observances—must of necessity be subject to a certain control on the part of the state, whose business it is to see to the preservation of decency and order. But, with such obvious exceptions, Spinoza claims complete freedom of expression for thought and belief; and he claims it in the interests alike of true piety and of the state itself. The thesis is less interesting to a modern reader—because now generally acknowledged—than the argument by which it is supported. Spinoza's position is based upon the thoroughgoing distinction drawn in the book between philosophy, which has to do with knowledge and opinion, and theology, or, as we should now say, religion, which has to do exclusively with obedience and conduct. The aegis of religion, therefore, cannot be employed to cover with its authority any speculative doctrine; nor, on the other hand, can any speculative or scientific investigation be regarded as putting religion in jeopardy. Spinoza undertakes to prove his case by the instance of the Hebrew Scriptures. Scripture deals, he maintains, in none but the simplest precepts, nor does it aim at anything beyond the obedient mind; it tells nought of the divine nature but what men may profitably apply to their lives. The greater part of the treatise is devoted to working out this line of thought; and in so doing Spinoza consistently applies to the interpretation of the Old Testament those canons of historical exegesis which are often regarded as of comparatively recent growth. The treatise thus constitutes the first document in the modern science of Biblical criticism. It was published in 1670, anonymously, printer and place of publication being likewise disguised (*Hamburgi apud Heinrichum Kunraht*). The storm of opposition which it encountered showed that these precautions were not out of place. It was synodically condemned along with Hobbes's *Leviathan* and other books as early as April 1671, and was consequently interdicted by the states-general of Holland in 1674; before long it was also placed on the *Index* by the Catholic authorities. But that it was widely read appears from its frequent reissue with false title-pages, representing it now as an historical work and again as a medical treatise. Controversialists also crowded into the lists against it. A translation into Dutch appears to have been proposed; but Spinoza, who foresaw that such a step would only increase the commotion which was so distasteful to him, steadily set his face against it. No Dutch translation appeared till 1693.

The same year in which the *Tractatus* was published Spinoza removed from his suburban lodging at Voorburg into the Hague itself. He took rooms first on the Veerkay with the widow Van de Velde, who in her youth had assisted Grotius to escape from his captivity at Loewenstein. This was the house afterwards occupied by Colerus, the worthy Lutheran minister who became Spinoza's biographer. But the widow

insisted on boarding her lodger, and Spinoza presently found the expense too great for his slender purse. He accordingly removed to a house on the Pavelioen Gracht near at hand, occupied by a painter called Van der Spijck. Here he spent the remaining years of his life in the frugal independence which he prized. Colerus gives particulars which enable us to realize the almost incredible simplicity and economy of his mode of life. He would say sometimes to the people of the house that he was like the serpent which forms a circle with its tail in its mouth, meaning thereby that he had nothing left at the year's end. His friends came to visit him in his lodgings, as well as others attracted by his reputation—Leibnitz among the rest—and were courteously entertained, but Spinoza preferred not to accept their offers of hospitality. He spent the greater part of his time quietly in his own chamber, often having his meals brought there and sometimes not leaving it for two or three days together when absorbed in his studies. On one occasion he did not leave the house for three months. "When he happened to be tired by having applied himself too much to his philosophical meditations, he would go downstairs to refresh himself, and discoursed with the Van der Spijcks about anything that might afford matter for an ordinary conversation, and even about trifles. He also took pleasure in smoking a pipe of tobacco; or, when he had a mind to divert himself somewhat longer, he looked for some spiders and made them fight together, or he threw some flies into the cobweb, and was so well pleased with the result of that battle that he would sometimes break into laughter" (Colerus). He also conversed at times on more serious topics with the simple people with whom he lodged, often, for example, talking over the sermon with them when they came from church. He occasionally went himself to hear the Lutheran pastor preach—the predecessor of Colerus—and would advise the Van der Spijcks not to miss any sermon of so excellent a preacher. The children, too, he put in mind of going often to church, and taught them to be obedient and dutiful to their parents. One day his landlady, who may have heard strange stories of her solitary lodger, came to him in some trouble to ask him whether he believed she could be saved in the religion she professed. "Your religion is a good one," said Spinoza; "you need not look for another, nor doubt that you will be saved in it, provided that, while you apply yourself to piety, you live at the same time a peaceable and quiet life." Only once, it is recorded, did Spinoza's admirable self-control give way, and that was when he received the news of the murder of the De Witts by a frantic mob in the streets of the Hague. It was in the year 1672, when the sudden invasion of the Low Countries by Louis XIV. raised an irresistible clamour for a military leader and overthrew the republican constitution for which the De Witts had struggled. John De Witt had been Spinoza's friend, and had bestowed a small pension upon him; he had Spinoza's full sympathy in his political aims. On receiving the news of the brutal murder of the two brothers, Spinoza burst into tears, and his indignation was so roused that he was bent upon publicly denouncing the crime upon the spot where it had been committed. But the timely caution of his host prevented his issuing forth to almost certain death. Not long after Spinoza was himself in danger from the mob, in consequence of a visit which he paid to the French camp. He had been in correspondence with one Colonel Stoupe, a Swiss theologian and soldier, then serving with the prince of Condé, the commander of the French army at Utrecht. From him Spinoza received a communication enclosing a passport from the French commander, who wished to make his acquaintance and promised him a pension from the French king at the easy price of a dedication to his majesty. Spinoza went to Utrecht, but returned without seeing Condé, who had in the meantime been called elsewhere; the pension he civilly declined. There may have been nothing more in the visit than is contained in this narrative; but on his return Spinoza found that the populace of the Hague regarded him as no better than a spy. The town was full of angry murmurs, and the landlord feared that the mob would storm his house and drag Spinoza out. Spinoza

quieted his fears as well as he could, assuring him that as soon as the crowd made any threatening movement he would go out to meet them, "though they should serve me as they did the poor De Witts. I am a good republican and have never had any aim but the honour and welfare of the state." Happily the danger passed off without calling for such an ordeal.

In 1673 Spinoza received an invitation from the elector palatine to quit his retirement and become professor of philosophy in the university of Heidelberg. The offer was couched in flattering terms, and conveyed an express assurance of "the largest freedom of speech in philosophy, which the prince is confident that you will not misuse to disturb the established religion." But Spinoza's experience of theological sensitiveness led him to doubt the possibility of keeping on friendly terms with the established religion, if he were placed in a public capacity. Moreover, he was not strong; he had had no experience of public teaching; and he foresaw that the duties of a chair would put an end to private research. For all these reasons he courteously declined the offer made to him. There is little more to tell of his life of solitary meditation. In 1675 we learn from his correspondence that he entertained the idea of publishing the *Ethics*, and made a journey to Amsterdam to arrange matters with the printer. "But, whilst I was busy with this," he writes, "the report was spread everywhere that a certain book of mine was in the press, wherein I endeavoured to show that there was no God; and this report found credence with many. Whereupon certain theologians (themselves perhaps the authors of it) took occasion to complain of me to the prince and the magistrates; moreover, the stupid Cartesians, because they are commonly supposed to side with me, desiring to free themselves from that suspicion, were diligent without ceasing in their execrations of my doctrines and writings, and are as diligent still." As the commotion seemed to grow worse instead of subsiding, Spinoza consigned the manuscript once more to his desk, from which it was not to issue till after his death. His last literary work was the unfinished *Tractatus politicus* and the preparation of notes for a new edition of the *Tractatus theologico-politicus*, in which he hoped to remove some of the misunderstandings which the book had met with. The *Tractatus politicus* develops his philosophy of law and government on the lines indicated in his other works, and connects itself closely with the theory enunciated by Hobbes a generation before. Consumption had been making its insidious inroads upon Spinoza for many years, and early in 1677 he must have been conscious that he was seriously ill. On Saturday, the 20th of February, he sent to Amsterdam for his friend Dr Meyer. On the following day, the Van der Spijcks, having no thought of immediate danger, went to the afternoon service. When they came back Spinoza was no more; he had died about three in the afternoon with Meyer as the only witness of his last moments. Spinoza was buried on the 25th of February "in the new church upon the Spuy, being attended," Colerus tells us, "by many illustrious persons and followed by six coaches." He was little more than forty-four years of age.

Spinoza's effects were few and realized little more than was required for the payment of charges and outstanding debts. "One need only cast one's eyes upon the account," says his biographer, "to perceive that it was the inventory of a true philosopher. It contains only some small books, some engravings, a few lenses and the instruments to polish them." His desk, containing his letters and his unpublished works, Spinoza had previously charged his landlord to convey to Jan Rieuwertz, a publisher in Amsterdam. This was done, and the *Opera posthuma* appeared in the same year, without the author's name, but with his initials upon the title-page. They were furnished with a preface written in Dutch by Jarig Jellis, a Mennonite friend of Spinoza's, and translated into Latin by Dr Meyer. Next year the book was proscribed in a violently worded edict by the states of Holland and West Friesland. The obloquy which thus gathered round Spinoza in the later years of his life remained settled upon his memory for a full hundred years after his death. Hume's casual allusion to "this famous atheist" and his "hideous hypothesis" is a fair specimen of the tone in which he is usually referred to; people talked about Spinoza, Lessing said, "as if he were a dead dog." The change of opinion in this respect may be dated from Lessing's famous conversation with Jacobi in 1780. Lessing, Goethe, Herder, Novalis and

Schleiermacher, not to mention philosophers like Schelling and Hegel, united in recognizing the unique strength and sincerity of Spinoza's thought, and in setting him in his rightful place among the speculative leaders of mankind. Transfused into their writings, his spirit has had a large share in moulding the philosophic thought of the 19th century, and it has also been widely influential beyond the schools. Instead of his atheism Hegel speaks of his acosmism, and Novalis dubs him a God-intoxicated man. Schleiermacher's fine apostrophe is well known, in which he calls upon us to "offer a lock of hair to the manes of the holy and excommunicated Spinoza."

Spinoza's personal appearance is described by Colerus from the accounts given him by many people at the Hague who knew him familiarly. "He was of a middle size, and had good features in his face, the skin somewhat dark, black curled hair, and the long eyebrows of the same colour, so that one might easily know from his looks that he was descended from the Portuguese Jews." Leibnitz also gives a similar description: "The celebrated Jew Spinoza had an olive complexion and something Spanish in his face." These characteristics are preserved in a portrait in oil in the Wolfenbüttel library, which was probably the original of the (in that case unsuccessfully rendered) engraving prefixed to the *Opera posthuma* of 1677. This portrait was photographed for Dr Martineau's *Study of Spinoza*. In 1880 a statue was erected to Spinoza at the Hague by international subscription among his admirers, and more recently the cottage in which he lived at Rhijnsburg has been restored and furnished with all the discoverable Spinoza relics.

Spinoza's philosophy is a thoroughgoing pantheism, which has both a naturalistic and a mystical side. The foundation of the system is the doctrine of one infinite substance, of which all finite existences are modes or limitations (modes of thought or modes of extension). God is thus the immanent cause of the universe; but of creation or will there can be no question in Spinoza's system. God is used throughout as equivalent to Nature (*Deus sive natura*). The philosophical standpoint comprehends the necessity of all that is—a necessity that is none other than the necessity of the divine nature itself. To view things thus is to view them, according to Spinoza's favourite phrase, *sub specie aeternitatis*. Spinoza's philosophy is fully considered in the article **CARTESIANISM**.

LITERATURE.—The contents of the *Opera posthuma* included the *Ethics*, the *Tractatus politicus* and the *De intellectus emendatione* (the last two unfinished), a selection from Spinoza's correspondence, and a *Compendium of Hebrew Grammar*. The *Treatise on the Rainbow*, supposed to be lost, was published anonymously in Dutch in 1687. The first collected edition of Spinoza's works was made by Paulus in 1802; there is another by Gfrörer (1830), and a third by Bruder (1843-1846) in three volumes. Van Vloten's volume, published in 1862, *Ad Benedicti de Spinoza opera quae supersunt omnia supplementum*, is uniform with Bruder's edition, and contains the early treatise *De deo et homine*, the *Treatise on the Rainbow*, and several fresh letters. A complete edition undertaken by Dr Van Vloten and Professor J. P. N. Land for the Spinoza Memorial Committee formed in Holland to celebrate the bicentenary of the philosopher's death appeared in 1882 and was reissued in three volumes in 1895. An English translation of *The Chief Works of Spinoza*, by R. H. M. Elwes, appeared in 1883, and translations of the *Ethics* and the *De intellectus emendatione* were published in 1883 and 1895 by W. Hale White; A. Wolf's translation of the *Short Treatise* appeared in 1910; previous translations were unscholarly in execution.

The main authority for Spinoza's life is the sketch published in 1705, in Dutch, with a controversial sermon against Spinozism, by Johannes Colerus. The French version of this *Life* (1706) has been several times reprinted as well as translated into English and German. The English version, also dating from 1706, was reprinted by Sir Frederick Pollock at the end of his *Spinoza, his Life and Philosophy* (1880). This book, Dr Martineau's *Study of Spinoza* (1882) and Dr John Caird's *Spinoza* (1888), are all admirable pieces of work, and, as regards the philosophical estimate, complement one another. H. H. Joachim's *Study of the Ethics of Spinoza* (1901) and R. A. Duff's *Spinoza's Political and Ethical Philosophy* (1903) are important contributions of more recent date. Careful research by Professor Freudenthal, Dr W. Meyer and Dr K. O. Meinsma has recently brought to light a number of fresh details connected with Spinoza's life and increased our knowledge of his Jewish and Dutch environment. The earliest lives and all the available documents have been edited by Freudenthal in a single volume, *Die Lebensgeschichte Spinozas* (1899), on the basis of which he has since rewritten the *Life, Spinozas Leben und Lehre*, vol. i., *Das Leben* (1904). Meinsma's *Spinoza und en zijn Kring* (1896) appeared in a German translation in 1909. The new material has been judiciously used by A. Wolf in the "Life" prefixed to his translation of the *Short Treatise* (1910), and the greater part of it also in the second edition of Sir Frederick Pollock's *Spinoza* (1899). (A. S. P.-P.)

SPINY SQUIRREL, a book-name for a group of African ground squirrels, characterized by the spiny nature of the fur of the more typical forms. They form the genus *Xerus*, which is split up into a number of subgenera; *Xerus rutilus* of Abyssinia and East Africa belonging to the typical group, while the striped

North African *X. getulus* represents the sub-genus *Atlantoxerus*. The more typical species are characterized by the coarse spiny hair, the small size, or even absence of the ears, and the long, nearly straight, claws. The skull is narrower and longer than in typical squirrels, and there are distinctive features in the cheek-teeth; but the more aberrant types come much closer to squirrels. Typical spiny squirrels differ from true squirrels in being completely terrestrial in their habits, and live either in clefts or holes of rocks, or in burrows which they dig themselves. (See RODENTIA.)

SPION KOP, a mountain in Natal on the north side of the Tugela River, and 24 m. W.S.W. of Ladysmith. It is celebrated as the scene of a battle (Jan. 24, 1900) in the Transvaal War, in which the British forces under Sir Redvers Buller were defeated by the Boers (see TRANSVAAL and LADYSMITH). The Spion Kop incident led to much controversy; for an admirable elucidation of the facts see *The Times History of the War in South Africa*. The name itself (Dutch for "Look-out Hill") is fairly common as a place-name in South Africa.

SPIRAL, in mathematics, the locus of the extremity of a line (or radius vector) which varies in length as it revolves about a fixed point (or origin). Here we consider some of the more important plane spirals. Obviously such curves are conveniently expressed by polar equations, *i.e.* equations which directly state a relation existing between the radius vector and the vector angle; another form is the "*p, r*" equation, wherein *r* is the radius vector of a point, and *p* the length of the perpendicular from the origin to the tangent at that point.

The equiangular or logarithmic spiral (fig. 1) is such that as the vector angle increases arithmetically, the radius vector increases

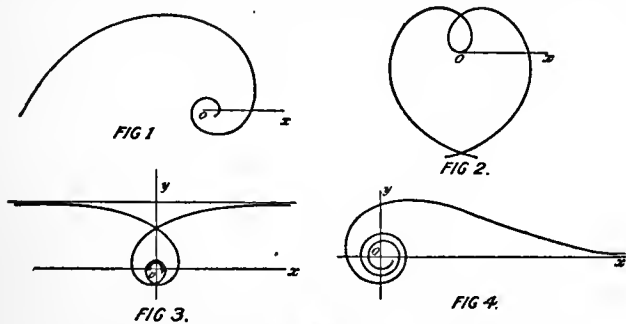

geometrically; this definition leads to an equation of the form $r = Ae^{B\theta}$, where *e* is the base of natural logarithms and *A, B* are constants. Another definition is that the tangent makes a constant angle (α , say) with the radius vector; this leads to $p = r \sin \alpha$. This curve has the property that its positive pedals, inverse, polar reciprocal and evolutes are all equal equiangular spirals. A group of spirals are included in the "parabolic spirals" given by the equation $r = a\theta^n$; the more important are the Archimedean spiral, $r = a\theta$ (fig. 2); the hyperbolic or reciprocal spiral, $r = a\theta^{-1}$ (fig. 3); and the lituus, $r = a\theta^{-2}$ (fig. 4). The first-named was discovered by Conon, whose studies were completed by Archimedes. Its "*p, r*" equation is $p = r^2/\sqrt{a^2 + r^2}$, and the angle between the radius vector and the tangent equals the vector angle. The second, called hyperbolic on account of the analogy of its equation (polar) to that (Cartesian) of a hyperbola between the asymptotes, is the inverse of the Archimedean. Its *p, r* equation is $p^2 = r^2 + a^2$, and it has an asymptote at the distance *a* above the initial line. The lituus has the initial line as asymptote. Another group of spirals—termed Cotes's spirals—appear as the path of a particle moving under the influence of a central force varying as the inverse cube of the distance (see MECHANICS). Their general equation is $p^2 = Ar^{-2} + B$, in which *A* and *B* can have any values. If *B* = 0, we have $p = r\sqrt{A}$, and the locus is the equiangular spiral. If *A* = 1 we have $p^2 = r^2 + B$, which leads to the polar equation $r\theta = 1/\sqrt{B}$, *i.e.* the reciprocal spiral. The more general investigation is as follows: Writing $u = r^{-1}$ we have $p^2 = Au^2 + B$, and since $p^2 = u^2 + (du/d\theta)^2$ (see INFINITESIMAL CALCULUS), then $Au^2 + B = u^2 + (du/d\theta)^2$, *i.e.* $(du/d\theta)^2 = (A-1)u^2 + B$. The right-hand side may be written as $C^2(u^2 + D^2)$, $C^2(u^2 - D^2)$, $C^2(D^2 - u^2)$ according as *A* - 1 and *B* are both positive, *A* - 1 positive and *B* negative, and as *A* - 1 negative and *B* positive. On integration these three forms yield the polar equations $u = C \sin hD\theta$, $u = C \cos hD\theta$, and $u = C \sin D\theta$. Of interest is the spiral $r = a\theta^2/(\theta^2 - 1)$, which has the circle $r = a$ as an asymptote in addition to a linear asymptote.

SPIRE (O. Eng. *spir*, a blade of grass, and so anything tapering to a point), the architectural term (Fr. *flèche*, Ital. *guglia*, Ger.

spitze) given to the lofty roofs in stone or wood covered with lead or slate, which crown the towers of cathedrals, churches, &c. In their origin, as in the church of Thaon in Normandy, they were four-sided roofs of slight elevation, but soon began to be features of great importance, becoming lofty pyramids generally of octagonal form, and equal in height sometimes to the towers themselves. The junction, however, of an octagonal spire and a square tower involved a distinct architectural problem, and its solutions in English, French and German spires are of infinite variety. One of the earliest treatments is that of the south-west tower of Chartres Cathedral, where, on the four projecting angles are lofty spire lights which, with others on the four faces and the octagonal spire itself, form a fine composition; at the abbey of St Denis the spire light at each angle was carried on three columns which filled better the three-cornered space at the angles and gave greater lightness to the structure; long vertical slits in the spire lights and the spire increased this effect, leading eventually to the introduction of tracery throughout the spire; the ultimate results of this we see in the lace-work spires of Strassburg, Antwerp, St Stephen's at Vienna, Freiberg, Ulm and other examples, which in some cases must be looked upon as the *tours de force* of the masons employed. In England the spires were far less pretentious but of greater variety of form. The spire of the cathedral at Oxford (1220) is perhaps the earliest example; it is of comparatively low elevation, of octagonal form with marked entasis, and is decorated with spire lights on each face and pinnacled turrets at the angles. Those which are peculiar to England are the broach-spires, in which the four angles of the tower are covered with a stone roof which penetrates the central, octagonal spire. In the best examples the spire comes down on the tower with dripping eaves, and is carried on a corbel table, of which the finest solution is St Mary's at Stamford. The angles of the octagonal spire have a projecting moulding which is stopped by a head just above the corbel table, and at the top of the broach is a small niche with a figure in it; the spire lights are in three stages alternately in the front and diagonal faces. At St Mary, Kelton, and St Nicholas, Walcot, are similar designs. Seen, however, on the diagonal, the void space at the angles of these broach-spires is noticeable, so that an octagonal pinnacle was erected, of which the earliest example is that of the cathedral at Oxford, where the broach was of very low pitch. Of later date St Mary's, Wollaston, All Saints, Leighton Buzzard, and St Mary's, Witney, are good examples. As a rule the broach penetrates the octagonal spire about one-sixth or one-seventh up its height, but there is one instance in St Nicholas, Cotsmere, in Rutlandshire, where it rises nearly half the way up the octagonal spire. When the parapet or battlement (the latter being purely decorative) took the place of the dripping eaves, the broach disappeared, and octagonal turrets occupy the corners, as in St Peter's at Kettering and Oundle, Northamptonshire, and in All Saints, Stamford, Lincolnshire. The next combination perhaps followed from this; in order to connect the angle tower or pinnacle with the spire, a flying buttress was thrown across, thus filling the gap between them; of this St James's, at Louth, in Lincolnshire, may be taken as a fine type; it belongs to the Perpendicular period and is further enriched with crockets up each angle of the spire; the same is found in St Mary's, Whittlesea, Cambridgeshire. At St Michael's, Coventry, the lower part of the octagonal spire is made vertical with a battlemented cresting round it. In St Patrick's, Partington, Yorkshire, the lower part of the spire, which otherwise is plain, is enclosed with an open gallery like the cresting of a crown. Sometimes the upper storey of the tower is made octagonal, and is set back so as to allow of a passage round with parapet or battlement, as at St Mary's, Bloxham, St Peter and St Paul, Seton, and St Mary, Castlegate, York. The most important groupings are those which surmount the towers of the English cathedrals; at Lichfield square turrets of large size with richly crocketed pinnacles; at Peterborough, a peculiar but not happy arrangement where a lofty spire covers over the buttress between angle turret and spire; and at

Salisbury an octagonal pinnacle at the angle and a triangular spire light against the spire. The happiest combination of all, however, is perhaps the spire of St Mary's, Oxford, with three ranges of angle niche-groups set one behind the other, forming with the centre spire a magnificent cluster of spires; the niche gables and pinnacles are all enriched with crockets and the ball flower in the arch mouldings.

Reference has already been made to two of the French spires, at Chartres and St Denis; there is nothing like the diversity of design in France, however, when compared with those in England, and there are but few on the crossing of nave and transept; the towers were built to receive them, as at Amiens, Reims and Beauvais, but for some reason not carried above the roof, possibly from some doubt as to the expediency of raising stone lanterns and spires of great weight on the four piers of the crossing; on the other hand their places were taken by constructions in timber covered with lead, of immense height and fine design. There was a 13th-century flèche on the crossing of Notre-Dame, Paris, taken down soon after the beginning of the 19th century, of which the existing example by Viollet-le-Duc is a copy. The same fate befell that over the Sainte Chapelle, Paris, being reconstructed about 1850 by Lassus. The flèche at Amiens, though of late date (c. 1500), is still in good preservation and is a remarkable work; above the ridges of the roofs of nave and transept, and octagonal in plan, are two stages, the upper one set back to allow of a passage round, and, above the cresting of the latter, a lofty octagonal spire with spire lights at the base on each side, crockets up the angles, and other decorations in the lead work with which it is covered. Including the vane, from the ridge of roof the height is 182 ft. Of timber flèches covered with slates there are many examples in the north of France, those at Orbais (Marne) and the abbey at Eu (Seine Inférieure) being the best known. Returning to stone spires, those on the west front of St Stephen's, Caen (Abbaye-aux-Hommes), are good examples with lofty octagonal turrets and pinnacles at west angle and spire light between, and among others are those of St Pierre at Caen, Senlis, Coutances, Bayeux, and many others in Calvados, and at Soissons, Noyon and Laon in Picardy. One of the most beautiful spires in France, though of late date, is that of the north-west tower to Chartres Cathedral. In the south of France, in the Charente and Périgord, the stone spire takes quite another form, being of much less height, of convex form, and studded with small scales, giving somewhat the appearance of a pine cone, with small pinnacles also with scales, and carried on a group of shafts at the angles of the tower. The west tower of Angoulême Cathedral, the central towers of Saintes Le Palud, and Plassac in the Charente, and the tower of St Front, Périgueux, and Brantôme in Périgord, have all spires of this kind, of which a small example crowns the Lanterne des Morts at Cellefrouin. The German towers are generally covered with roofs only, of varied form, but at Ulm, Strassburg, Freiburg and Cologne is a remarkable series of traceried spires in stone, of great elaboration and showing great masonic ability, but wanting in repose and solidarity, and the same applies to the spire at Antwerp. In Spain there are not many examples of note, the spire at Burgos suggesting in its outline and want of height the influence of the Périgordian spires, and that at Salamanca the influence of those in the north of France.

Looking upon the spire as the crowning feature of a tower, those of the Renaissance period must be included here, though as a compromise they are often termed "steeple." Of these the finest and most varied are those by Wren in London, among which that of Bow Church and St Bride's, Fleet Street, are the best known, the former with two stages of lanterns with detached columns round, and the latter octagonal on plan with five stages, set one behind the other, with arches in centre of each face and pilasters at the angles. St Antholin, now destroyed, was the only example based on a Gothic prototype; it consisted of an octagonal spire with Renaissance spire lights and angle finials resting on the upper octagonal storeys of the tower. St Margaret Pattens somewhat resembles it, but the

tower has a balustrade round and the angle pinnacles are in the form of obelisks, a favourite Renaissance interpretation of the Gothic finial, which is found in other churches, as in those of St Martins-in-the-Fields by Gibbs and St Giles-in-the-Fields by Flitcroft. Hawksmoor apparently based his spire of St George's, Bloomsbury, which consists of a series of lofty steps, and is crowned with a statue of George I., on that of the mausoleum at Halicarnassus. In France, Italy and Spain, lanterns usually terminate the towers. The spire of the Seo at Saragossa in design somewhat resembles those of Wren, being one of the few examples worth noting. (R. P. S.)

SPIRE LIGHT (Fr. *lucarne*), the term given to the windows in a spire which are found in all periods of English Gothic architecture, and in French spires form a very important feature in the composition. There is an early example in the spire of the cathedral at Oxford; they are not glazed, and have occasionally, if of large size, transoms to strengthen the mullions.

SPIRES (Ger. *Speyer* or *Speier*), a town and episcopal see of Germany, capital of the Bavarian palatinate, situated on the left bank of the Rhine, at the mouth of the Speyerbach, 16 m. S. of Mannheim by rail. Pop. (1905), 21,823. The principal streets are broad but irregular, and the general appearance of the town little corresponds to its high antiquity, owing to the fact that it was burned by the French in 1689. The only important ancient building that survived the flames is the cathedral, a very large and imposing basilica of red sandstone, and one of the noblest examples of Romanesque architecture now extant. Beyond the general interest attaching to it as one of the old Romanesque churches of the Rhineland, Spire Cathedral has a peculiar importance in the history of architecture as probably the earliest Romanesque basilica in which the nave as well as the side arcades was vaulted from the first (see ARCHITECTURE: *Romanesque in Germany*). Built in 1030-1061 by Conrad II. and his successor, this church has had a chequered history, its disasters culminating in 1689, when the soldiers of Louis XIV. burned it to the bare walls, and scattered the ashes of the eight German emperors who had been interred in the king's choir. Restored in 1772-1784 and provided with a vestibule and façade, it was again desecrated by the French in 1794; but in 1846-1853 it was once more thoroughly restored and adorned in the interior with gorgeous frescoes at the expense of the king of Bavaria. The large cathedral bowl (Domnapf) in front of the west façade formerly marked the boundary between the episcopal and municipal territories. Each new bishop on his election had to fill the bowl with wine, while the burghers emptied it to his health. The heathen tower to the east of the church, on foundations supposed to be Roman, was probably part of the town-wall built in 1080 by Bishop Rudger. Of the Retscher, or imperial palace, so called because built after the model of the Hradschin at Prague, only a mouldering fragment of wall remains. It was in this palace that the famous Diet of Spire met in 1529, at which the Reformers first received the name of Protestants. The Altpörtel (*alta porta*), a fine old gateway of 1246, is a relic of the free imperial city. Among the modern buildings are several churches and schools, a museum and picture gallery, &c. Spire, although rebuilt in 1697, has never recovered from the injuries inflicted by the French in 1689. Its trade is insignificant, although it still has a free harbour on the Rhine. Its manufactures include cloth, paper, tobacco and cigars, sugar, sugar of lead, vinegar, beer and leather. Vines and tobacco are grown in the neighbourhood.

* Spire, known to the Romans as *Augusta Nemeturum* or *Nemetæ*, and to the Gauls as *Noviomagus*, is one of the oldest towns on the Rhine. The modern name appears first under the form of Spira, about the 7th century. Captured by Julius Caesar in 47 B.C., it was repeatedly destroyed by the barbarian hordes in the first few centuries of the Christian era. The town had become an episcopal seat in the 4th century; but heathenism supervened, and the present bishopric dates from 610. In 830 Spira became part of the Frankish Empire, the emperors having a "palatium" here; and it was especially favoured by the Salic imperial house. The contentions between the bishops and the

citizens were as obstinate and severe as in any other city of Germany. The situation of the town opposite the mouths of several roads through the Rhine valley early fostered its trade; in 1294 it rose to be a free imperial city, although it owned no territory beyond its walls and had a population of less than 30,000. It enjoyed great renown as the seat of the imperial supreme court from 1527 till 1689; it was fifth among the free cities of the Rhine, and had a vote in the Upper Rhenish Diet. Numerous imperial diets assembled here. From 1801 till 1814 it was the capital of a department of France; but it was restored to Bavaria in the latter year. By the Peace of Spire in 1544 the Habsburgs renounced their claims to the crown of Sardinia.

SPIRITS.¹ The original meaning of the word spirit (Lat. *spiritus*, from *spirare*) was wind in motion, breath, the soul, and hence it came to denote that which gives life or vigour to the human body and other objects, and it is, therefore, synonymous with everything eminently pure, ethereal, refined or distilled. In popular chemical nomenclature the term "spirit" in its former sense is still occasionally encountered, for instance, "spirits of salts" for hydrochloric acid. The spirits of the British Pharmacopoeia (e.g. *sp. aetheris nitrosi*; *sp. chloroformi*; *sp. camphorae*) are solutions of various substances obtained either by distilling these with, or dissolving them in, the rectified spirit of the Pharmacopoeia, which latter is pure alcohol with 16% by weight of water.

In the modern sense, spirits may be broadly defined as the products resulting from the distillation of saccharine liquids which have undergone alcoholic fermentation. Spirits of wine means rectified spirit of a strength of 43 degrees over proof and upwards. By rectified spirit is meant spirit rectified at a licensed rectifier's premises. Proof spirit, which is the standard spirit of the United Kingdom, is legally defined (58 Geo. III. c. 28) as a spirit which at 51° F. weighs exactly twelve-thirteenths of the weight of an equal volume of distilled water. The strength of proof spirit at 60° F.—the temperature now generally employed for official calculations—is now officially regarded as being equal to a spirit containing 57.06% by volume, or 49.24% by weight, of absolute alcohol. Spirit which possesses a greater or smaller alcoholic strength than proof is described as being so many degrees over or under proof, as the case may be. The strength is legally estimated by Sykes's hydrometer, which was legalized in 1816 by 56 Geo. III. c. 40. The degrees "over" or "under" proof as ascertained by Sykes's hydrometer are arbitrary percentages by volume of a standard spirit contained in the spirit under examination. This standard spirit is proof spirit. For example, by a spirit of strength 75.25 degrees over proof (absolute alcohol) is meant a spirit of such a strength that 100 volumes of the same contain an amount of spirit equal to 175.25 volumes of the standard (proof) spirit. A spirit of 25 degrees under proof is one of which 100 volumes contain only as much alcohol as do 75 (i.e. 100-25) volumes of proof spirit. According to Nettleton, "proof spirit" would appear to be the outcome of an attempt to produce a mixture of pure alcohol and water, containing equal weights of the constituents. The term "proof" probably originated from a rough test for spirituous strength formerly employed, which consisted in moistening gunpowder with the spirit and applying a light. If the gunpowder did not ignite, but the spirit merely burned away, the spirit was regarded as being under proof, i.e. it contained so much water that the gunpowder became moist and refused to deflagrate. The basis of the standard of other countries is almost invariably the unit volume of absolute alcohol, the hydrometers, or rather "alcoholometers"—such as those of Gay-Lussac and of J. G. Tralles—employed indicating the exact quantity of alcohol in a mixture at a standard temperature, in percentages by volume. In the United States the term "proof" is also employed, American proof spirit being a spirit which contains 50% of alcohol by volume at 60° F. American "proof" spirit is, therefore, considerably weaker than British "proof." Allowing for this difference and also for the fact that the American standard

¹ For the sense of disembodied persons, see SPIRITUALISM.

gallon (which is really the old English wine-gallon) is equal to 0.833 of an imperial gallon, the American "proof" gallon roughly equals 0.73 of a British proof gallon.

Historical.—The art of distillation, more particularly the preparation of distilled alcoholic fluids for beverage and medicinal purposes, is of very ancient origin. It is probable that the art of making spirits was well known many centuries before



FIG. 1.—Ancient form of Still, used in China.

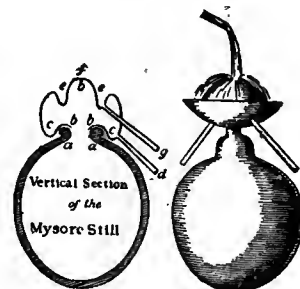

FIG. 2.—Ancient form of Still, used in Central India.

the advent of the Christian era. According to T. Fairley, the Chinese distilled liquor "sautchoo" was known long before the Christian era, and "arrack" was made in India at a date as remote as 800 B.C. Aristotle in his *Meteorology* (lib. ii. ch. ii.) says "Sea-water can be rendered potable by distillation: wine and other liquids can be submitted to the same process. After they have been converted into humid vapours they return to liquids." There is, on the whole, little doubt that spirits were manufactured in Egypt, India, China, and the Far East generally, as far back as 2000 B.C. Figs. 1-4 (from Morewood's *Inebriating Liquors*, published in 1838) show very ancient forms of stills in use in China, India, Tibet and Tahiti.

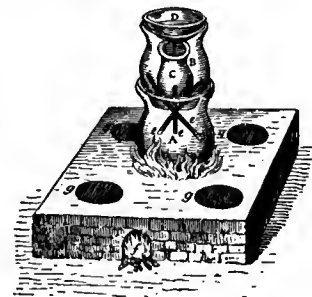

FIG. 3.—Ancient form of Still, used in Tibet.

As far as can be ascertained the oldest reference to the preparation of a distilled spirituous liquor in the British Isles is contained in the "Mead Song" written by the Welsh bard, Taliesin, in the 6th century. He said "Mead distilled I praise, its eulogy is everywhere," &c. (Fairley, *The Analyst*, 1905, p. 300). The same authority points out that the knowledge of distillation in the British Isles was independent of the art of distillation from wine, seeing that distillation from grain was known in Ireland before the art of making wine came to Europe. An Irish legend states that St Patrick first taught the Irish the art of distillation; but, however that may be, it is certain that at the time of the first English invasion of Ireland (1170-72) the manufacture of a spirit distilled from grain (i.e. whisky) was known to the inhabitants of that country. It is probable that grain spirit was first prepared in the Far East, inasmuch as a spirit distilled from rice and other grains was made in India before the Christian era. The establishment of regular distilleries in England appears to date back to the reign of Henry VIII., and they are said to have been founded by Irish settlers who came over at that time. It is difficult to obtain exact data

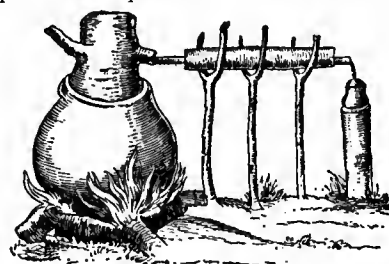

FIG. 4.—Ancient form of Still, used in Tahiti.

regarding the origin of the distilling industry in Scotland, but, as Fairley says, it is probable that distilling was carried on there almost as early as in Ireland. At the time of the Tudors Scotch whisky was held in great repute in England. The production of a spirit from wine (*i.e.* brandy) appears to have been known in the 9th century; but, according to Morewood, the first attempt at the distillation of wine in France is attributed to Arnaldus de Villa Nova, in the 13th century. As a manufacturing industry the distillation of brandy in France began in the 14th century. The history of the spirit industry in the United Kingdom is, as Nettleton has well pointed out, inseparably connected with questions of taxation. According to one writer, it was not until 1660 that an excise duty was first imposed on the consumption of spirit ("aqua vitæ") in the United Kingdom, but it appears probable that the industry generally was taxed in one form or another in the reign of Elizabeth, when it first began to assume considerable importance. No record, however, of the quantity of spirit on which duty was charged was kept until 1684. In that year duty was paid on 527,492 gallons. At the end of the century the consumption reached 1,000,000 gallons, and in 1745 it had risen to a quantity equivalent to about 5,000,000 gallons at proof. Cromwell imposed a tax of 8d. per gallon, but this was soon lowered to 2d. In 1751 a tax equivalent to 1s. per proof gallon was imposed, and in 1766 this was further increased to 2s. After this various changes and complex methods of assessing the duty were introduced (see Nettleton, *The Manufacture of Spirit*, Marcus Ward, 1893) until, in more modern times, a more rational and uniform system was introduced.

Conditions of Manufacture.—The principal act now governing and regulating the manufacture of spirits and the working of distilleries in Great Britain is the Spirits Act of 1880. The provisions of this and of the other acts bearing on the subject are exceedingly numerous and complicated, and, therefore, only a few of the chief points can be set forth here, so that an adequate appreciation may be gained of the arduous and rigid conditions under which the spirit manufacturer is, in order to ensure the safeguarding of the revenue, constrained to carry out his operations. A distillery must not, without permission, be carried on at a greater distance than half a mile from a market town, nor may it be situated within a quarter of a mile from a rectifying establishment. A distiller must give notice of the erection of new plant or apparatus, of the time of brewing, of the removing of sugar from store or of yeast from wort or wash, of the making of "bub," of the locking of the spirit receiver supply pipe, &c. He may use any material he pleases, provided that the gravity of the wort can be ascertained by the saccharometer, but he may not brew beer nor make cider, wine nor sweet wines. When the worts are collected in the wash-back (fermenting vessel) a declaration must be made at once, specifying the original gravity and the number of dry inches remaining in the back. At the end of every distilling period a return must be delivered showing (a) the quantity of brewing materials used, (b) the quantity of wort or wash attenuated and distilled,

out of store, the number and size of vessels, the locking of the latter, and the painting of the pipes carrying various liquids in certain colours. The methods of assessing the duty are three-fold, and whichever of these methods gives the highest return is the one adopted. The first is the "attenuation charge." This consists of levying the charge due on one gallon of proof spirit for every hundred gallons of worts collected and for every five degrees of attenuation observed, the latter being calculated by taking the difference between the highest specific gravity of the worts and the lowest gravity of the wash after complete fermentation. Secondly, there is the "low-wines charge," calculated upon the bulk-quantity at proof-strength of the low wines produced by the distillation of the wash; and lastly, the "feints and spirits charge." This is the method usually adopted, as it generally gives the highest results; it is assessed on the number of bulk gallons at proof of the feints and spirits produced by the final distilling operations. The duty, which was fixed at 10s. per proof gallon in 1860, remained at that rate until 1890, when an addition of 6d. was made, but a further increase to the like amount made in 1894 was remitted in the next year owing to the unsatisfactory results obtained. The rate remained at 10s. 6d. until 1900 when it was raised to 11s., a further increase being made in 1909-1910.

Legally, the word "spirit" implies spirit of any description, and all liquors, mixtures and compounds made with the same. In the same way plain spirit is any British spirit which has not been artificially flavoured, and to which no ingredient has been added subsequent to distillation.

The extremely severe and inelastic provisions of the acts governing the manufacture of spirit in the United Kingdom have proved to be a very serious impediment to the development of the spirit industry on modern lines, and have placed the British manufacturer at a considerable disadvantage as compared with his foreign competitors. There is little doubt that the enormous revenue derived from the spirit industry could be adequately safeguarded in a manner more consistent with the development of the industry on sound commercial and technological lines than it is at present.

Production and Consumption.—The production of spirit in the United Kingdom amounted in 1907 to roughly 50,000,000 proof gallons, the consumption to a gallon per head of population. In the decade 1880-1890 the quantity of spirits distilled remained practically stationary at about 40,000,000 gallons, but during the ten years 1890-1900 there was a rapid increase, the maximum being attained in 1898, when nearly 64,000,000 gallons were produced. A point had then been reached at which the production had considerably outstripped the consumption, due in part to the desire of the spirit trade to meet the increased demand for "matured" spirits, and in part to the fact that an excessive amount of capital had, owing to the increased popularity of Scotch whisky, been attracted to the distilling industry. This over-production led to a vast increase in the quantity of spirit remaining in warehouse. In 1906 production and consumption were about equal, and the quantity of spirit in warehouse represented roughly a five years' supply.

The following figures regarding production, consumption, duty, &c., need no explanation:—

UNITED KINGDOM

1. Statistics regarding Home-made Spirits.

Year.	Total quantity distilled (proof gallon).	Total consumption of potable spirit (proof gallon).	Consumption of potable spirit per head of population (proof gallon).	Exports (proof gallon).	Retained for methylation (proof gallon).	Remaining in warehouse (proof gallon).	Duty paid (Excise). £
1895-1896	49,324,875	31,088,448	0.79	4,254,883	3,838,082	114,110,701	16,380,134
1898-1899	63,437,884	34,334,084	0.85	5,090,290	4,781,369	151,732,539	17,967,142
1900-1901	57,020,847	36,703,728	0.89	5,773,718	5,070,713	161,502,829	20,124,003
1903-1904	51,816,600	34,103,111	0.80	6,334,971	5,054,586	167,155,504	18,667,818
1905-1906	49,214,165	32,486,958	0.75	7,049,798	5,663,429	163,519,957	17,765,352
1906-1907	50,317,908	32,511,316	0.74	7,341,077	6,055,285	161,648,409	17,745,125

(c) the quantity of spirits produced at proof-strength, and (d) the quantity of "feints" remaining. Regulations also exist with regard to the amount of "bub" (see below) that may be added to the worts, or the quantity of yeast that may be removed from the wash, concerning the time permissible for drawing over spirit at the various stages, as to placing in and taking spirit

The importation of foreign potable spirits into the United Kingdom has fallen off materially since 1870-1875, during which period it stood at 16,000,000 to 17,000,000 gallons. This is chiefly due to the decreased consumption of brandy, and, to a smaller extent, to the diminishing importance of rum and other foreign spirits. The most remarkable change in this connexion is in the case of foreign methylated spirit. At one time (1891) the quantity of this article imported

2. Statistics regarding Imported Spirits.

Year.	Total imports (proof gallon).	Consumption per head of population (proof gallon).	Nature of spirits (proof gallon).	Retained for methylation.
1895-1896	10,821,518	0.20	Rum . . . 6,217,469 Brandy . . . 2,668,616 Other sorts. 1,935,433	91,990
1902-1903	13,130,182	0.20	Rum . . . 6,719,452 Brandy . . . 3,081,525 Other sorts. 2,617,090	1,212,001
1905-1906	8,228,435	0.16	Rum . . . 4,879,958 Brandy . . . 2,456,773 Other sorts. 891,704	nil.
1906-1907	8,129,503	0.17	Rum . . . 5,110,345 Brandy . . . 1,942,415 Other sorts. 1,076,743	nil.

was almost equal to the amount manufactured in the United Kingdom, the figures being 1,995,782 gallons for the home produce and 1,456,108 for the foreign. For various reasons—chiefly owing to the surtax of 4d. per gallon on all foreign spirit—the quantity imported has gradually dwindled away, and at the present time is practically negligible. The principal spirit-producing countries are Russia and Germany, the United States coming next, and then France, Austria and the United Kingdom in succession, followed by Hungary, Holland and Belgium. The following are the figures for 1905:—

	Proof gallons.	(1904)
Russian Empire	161,366,000	
Germany	146,014,000	
United States	125,042,000	
France	160,584,000	
Austria	55,682,000	
United Kingdom	48,520,000	
Hungary	40,216,000	
Holland	13,552,000	
Belgium	11,924,000	

If we except Canada and the Cape (which make roughly 6,000,000 and 1,500,000 gallons respectively), the production of the British Empire, apart from the United Kingdom, is very small. British Guiana exports 3,000,000 to 4,000,000 and Jamaica about 1,500,000 gallons of rum.

With regard to the consumption in gallons per head, Denmark stands first with 2.4, then follows the Austro-Hungarian Empire, with 1.98, Germany with 1.43, Holland with the same figure, France with 1.37, Sweden with 1.36, the United States with 1.26, Belgium with 1.10, and last the United Kingdom with 0.91. The consumption in Russia is about equal to that of the United Kingdom. The figures given are for the year 1905. In the British colonies Western Australia comes first with a consumption per head of 1.33 gallons; and then in order Queensland 1.32 gallons; Canada 0.94 gallon; New South Wales 0.77 gallon; New Zealand 0.73 gallon; Victoria 0.64 gallon; the Cape 0.68 gallon, and South Australia 0.47 gallon. Of the spirits distilled in the United Kingdom, Scotland produces roughly one half, England and Ireland about one quarter each. Although the number of distilleries in England and Ireland has varied but little of recent years, the number in Scotland increased from 120 in 1880 to 161 in 1899. In 1906 the actual numbers were—Scotland 150; Ireland 28; England 8. The apparent anomaly between the number of distilleries and the quantity of spirit produced in different parts of the kingdom is explained by the fact that the great majority of the distilleries in Scotland and Ireland are small, pot-still distilleries, whereas the English works are all of considerable capacity. It is difficult to arrive at any satisfactory figure with regard to the amount of capital invested in British and Irish distilleries, but it probably exceeds twenty millions.

Illicit distillation has almost ceased to exist in Great Britain, but in Ireland the number of annual seizures under this heading is still considerable. In 1906-1907, out of a total of 974 detections and seizures, 968 were in Ireland.

The spirit produced in the United Kingdom is made almost exclusively from malt, unmalted grain (chiefly maize, rye, barley, wheat and oats) and molasses. The relative proportion of malt to unmalted grain has shown a slight tendency to increase during the past twenty years, but the quantity of molasses employed has increased very largely in the same period, owing mainly to the fact that home-made spirit has largely displaced the foreign article for several industrial purposes and particularly for methylation. The estimated quantities of the various materials employed in 1883 and 1906 respectively were as under:—

Year.	Malt (quarters).	Unmalted grain (quarters).	Molasses and sugar (cwt.)
1883	859,363	1,054,081	165,529
1906	1,151,199	1,090,286	985,808

With regard to the materials employed in the manufacture of spirits in France, roughly 80-90% now consist of maize (and other starchy substances), beetroot and molasses, whereas in 1840 nine-tenths of the alcohol produced was derived from the grape and other fruits. This change is due in part to the ravages of the oïdium disease (1850-1857) and the phylloxera (1876-1890), which destroyed an immense number of vines, but chiefly to the increased demand for commercial spirit in the arts and manufactures, and also to the improved methods for obtaining a high-class spirit from practically any starchy or saccharine material. In 1905 the number of alcohol units (the unit=1000 hectolitres of pure alcohol) distilled from maize and other starchy materials was 589, from molasses 516, from beetroot 1002, from wine, cider, lees and

fruits 499. In Germany roughly 75% of the spirit manufactured is derived from potatoes. In 1905 the total spirit distilled amounted to 3786 units (of 1000 hectolitres of pure alcohol), of which 2877 units were obtained from potatoes, 765 units from grain and 144 units from molasses and other material. In Russia spirits are distilled chiefly from potatoes and rye, in the United States from maize.

Manufacture.—The manufacture of spirits consists broadly in converting starchy or saccharine matter into alcohol, the latter product being subsequently separated, concentrated and rectified. When spirits are made from a purely saccharine material the process of conversion into alcohol is a relatively simple one, but where farinaceous raw products are employed it is primarily necessary to transform the starch contained in them into sugar. The main varieties of spirits manufactured from sugar, or from sugar-containing materials, are:—

SUGAR-DERIVED SPIRITS

Raw Material.	Product.
Wine.	Brandy.
Sugar-cane and cane molasses.	Rum.
Beetroot; beet molasses.	Industrial alcohol.

Occasionally wine, cider, perry and cane molasses are also employed for making either plain potable spirit or industrial alcohol, and at times cane molasses (chiefly obtained from Cuba and the West Indies) are used somewhat extensively in England for the manufacture of plain spirit. Occasionally, also, plain potable spirit is derived from beets, but rarely from beet molasses, the spirit derived from the latter being somewhat difficult of rectification.

The chief spirits derived from starchy materials, and their corresponding raw materials, are as follows:—

STARCH-DERIVED SPIRITS

Raw Material.	Product.
Cereal grains: chiefly barley, rye, oats, wheat and maize	Whisky, "corn brandy," "vodka," plain spirit; industrial alcohol.
Potatoes	Industrial alcohol.

A. Spirits Derived from Saccharine Materials.—The manufacture of the finer brandies, such as those of Cognac, is, as far as the processes involved are concerned, by no means a complex matter. The excellence of this class of spirit is due mainly to the character of the wine employed and to the great experience of the distillers in selecting and blending the raw materials and finished products. The character of the wine is, of course, chiefly due to the peculiar soil and climatic conditions, and in some degree to the methods of cultivation. The latter, it may be added, have since the reconstitution of the Charente vineyards subsequent to their partial destruction by the phylloxera (see BRANDY) been much improved. In the pre-phylloxera days the vineyards were planted and cultivated in a very rough and ready fashion, without any attempt at regularity of planting. The result was that the vines spread practically unrestrained in every and any direction. In consequence there was a great irregularity of growth, feeble and hardy plants being found side by side, and the yield was poor. In vineyards constructed in the modern style the vines are planted in regular rows, and the bushes are, with a view to obtaining regular and rapid

ripening, methodically supported by wire. The wines produced by the Charente vineyards are of a light (white) character and possess no marked "bouquet," but they nevertheless produce a spirit of a peculiarly fine and delicate character. It is remarkable that the fuller and more aromatic wines of the Gironde and of Burgundy, for instance, are not so suitable for the manufacture of brandy as the relatively poor growths of the Charente. The apparatus employed for the distillation of the fine Cognac brandies is generally of a very simple pot-still type. Fig. 5 depicts the still-room of a Charente distillery

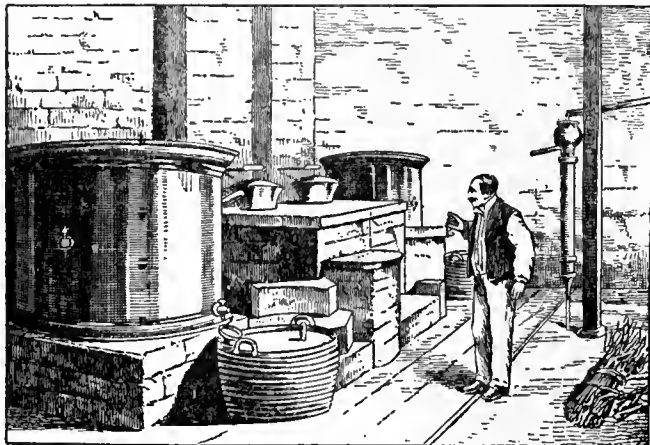

FIG. 5.—Old Cognac Pot-still.

of former times, and fig. 6 shows one of Messrs Martell's distilleries in Cognac, equipped on modern lines. It will be seen that, in principle, there is very little difference between

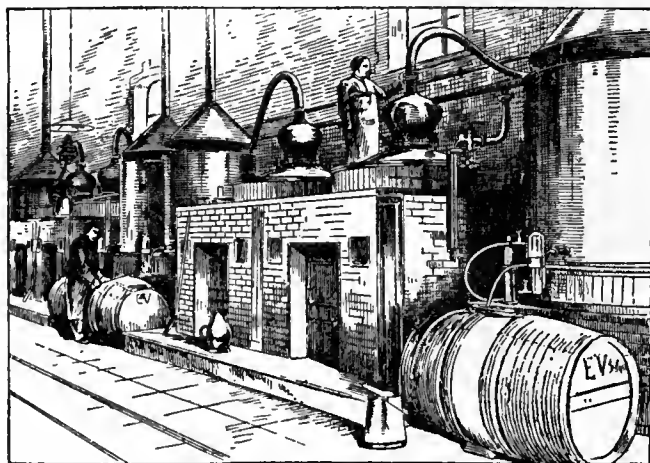

FIG. 6.—Modern Cognac Pot-still (Martell & Co.)

the two sets of plant, the reason being that experience has shown that for wines producing the finest brandies, the simplest form of still is also the best. For the distillation of wines not of the highest quality (from the brandy distillers' point of view) more complicated apparatus is employed, as the spirit from these wines must be more highly rectified than is the case with the finest brandies. Broadly speaking, it may be said that the type of still is suited to the production in the most economical manner of the best spirit to be obtained from the wine of a particular district. In Cognac, brandy is generally, but not universally, made by the "brouillis et repasse" system, this being a double distillation in a simple pot-still. The stills are (compared with whisky pot-stills) very small, holding roughly one hundred gallons, and the distillation is conducted very slowly and carefully, lasting about eight hours. Sometimes the whole of the spirit is collected in one receiver (corresponding to the low wines of Scotch whisky), but frequently the "brouillis," as the results of the first distillation are termed, are divided into several fractions. The "brouillis" which contain about 25 to 35% of alcohol are redistilled, this second distillation

being called the "bonne chauffe" or "repasse." The first runnings—which vary in quality according to the quality of the wine, the manner of heating, &c.—are termed "produit de tête" or "têtes," and are separately collected and mixed with the "brouillis" of the following operation. The spirit which next comes over (starting at a strength of about 80% and running down to about 55%) is the "cœur," and as a whole, marks roughly 66 to 70% of absolute alcohol by volume. The residue in the still is then run down to water, and the spirit so obtained, which shows 20 to 25%, is called "seconde," and is either mixed with a fresh charge of wine or rectified separately, the stronger portion being mixed with the "brouillis," the weaker with a charge of wine (see BRANDY).

There are two main kinds of rum, namely, Jamaica rum and rum of the type prepared principally in Demerara and Trinidad (see RUM). There are two varieties of Jamaica rum (a) the common clear rum, and (b) flavoured, **Rum.** or "German" rum. (a) "Common clear" rum is prepared from a mixture of sugar-cane molasses, "skimmings" (the scum from the boiling cane juice) and "dunder," this last name being given to the spent lees from previous distillations. Previous to use the "skimmings" are subjected to acid fermentation either alone or in conjunction with "trash" (crushed cane). The wort, which on the average contains about 10 to 15% of sugar, ferments very slowly, owing to the fact that very little yeast—the latter being derived from the cane rind—is present. Roughly five to ten days are occupied by this operation. At first the fermentation is mainly alcoholic, but it rapidly assumes an acid character, owing to the presence of a great number of acidifying bacteria derived from the "dunder" and "skimmings." The distillation of the fermented wort is carried out in pot stills heated by fire or steam, either of a simple type or provided with rectifiers. In the former case two distillations are necessary, the first resulting in the production of a weak alcoholic liquid termed "low wines," the second, which consists in a rectification of the low wines, producing "high wines" or strong rum. The other type of still is provided with two rectifiers, which are interposed between the still and the condensing worm. These are charged with low and high wines respectively. The first runnings of the still (25 to 40 o.p.) constitute the rum proper, the next fraction the high wines, and the final distillate the low wines. (b) Flavoured or "German" rum is prepared from the same materials as the "common clear" variety, with the addition of "acid" and "flavour." "Acid" is obtained by acidifying fermented cane juice by means of cane "trash" and refuse from the wash backs. "Flavour" is prepared in much the same way as "acid," except that "dunder" sediment is also added. The fermentation, which is to a very great extent bacterial, results in the formation of large quantities of acid, including much butyric acid and compound esters. The distillation of "flavoured" rum is carried out in much the same manner as that of the "common clear." The manufacture of "Demerara rum" is differentiated from that of the Jamaica varieties mainly by the fact that the fermentation in the former case is practically purely saccharomycetic (*i.e.* yeast), whereas the latter is largely schizomycetic (*i.e.* bacterial). For the distillation of the Demerara rums, which are much lighter in flavour than the Jamaica varieties, stills of the "patent" (see below) or rectifying type are frequently employed (see RUM and ARRACK).

For the manufacture of industrial spirit from saccharine materials see below, under *Industrial Alcohol*.

B. *Spirits Derived from Starchy Materials.*—The manufacture of spirit from saccharine materials is, as we have seen, a relatively simple operation, the sugar being transformed into alcohol by fermentation, and the latter then distilled off. To convert starchy matter into alcohol is a much more complicated matter. To the operations necessary for the transformation of sugar into spirit, must, in the case of starchy materials, be added that of converting the starch into sugar. This is accomplished either by the action of a diastatic ferment, such

as that present in malted grain (see BREWING) or secreted by certain living organisms, or by an acid such as sulphuric acid. The latter process is little employed at the present time. The materials employed by the distiller, and the methods of preparation and treatment to which they are subjected before and after entering the distillery, are in some respects similar, in others materially different, from those employed by the brewer. The materials most frequently employed are maize, rye, barley malt, raw barley, oats, wheat and potatoes. Comparing the main operations (apart from the actual process of distillation) of the brewer with those of the distiller, it is true that these are identical in the sense that they consist in the conversion of starch into sugar and of the latter into alcohol; but whereas the object of the brewer is to produce beer, of which alcohol forms only a relatively small proportion, the distiller, broadly speaking, desires to produce alcohol, and it is this fact which is responsible for the differences alluded to above.

Distillery Malting.—Where malt is employed as the main raw material, as, for instance, in the case of Scotch pot-still whiskies, and also, but to a minor degree, in Irish pot-still whiskies and patent-still whiskies, the process of preparation does not, except in some specific particulars, differ very widely from that used in making brewer's malt (see MALT). With regard to the barley employed for this purpose, certain qualities which are of the greatest importance to the brewer, such as the nature of the husk, colour, and friability of the starch, are of little interest to the distiller, and providing that the grain is sound and that it contains a high percentage of starch and malts as well, it will pass muster as an average distillery material. It is usual to give barley intended for patent-still work a rather longer period in the steep and on the floors than in brewery malting, and it is well to treat the steep-water with some anti-septic, preferably lime, as the distiller has not the opportunity of lessening the dangers of bacterial infection at subsequent stages which is afforded to the brewer by the boiling and hopping of the wort. In distilleries where barley malt is not used as the main raw material, but mainly or chiefly as a diastatic agent (for instance, in potato and maize distilleries on the continent of Europe), the so-called "long" malt process is widely employed. This consists essentially in subjecting the grain first to a somewhat lengthy steep (until the increase in weight due to the absorbed water is about 40 to 45%), and secondly to a very prolonged "flooring" at a moderate temperature, great attention being paid to the conditions of ventilation and humidity. It was formerly believed that the germinating barley grain attains its maximum of diastatic power after a very short period, and that when the acrospire is three-quarters "up" and the rootlets say one and a half times the length of the grain, the malt is ready for removal from the floor. M. Delbruck, Hayduck and others have, however, shown that this is not the case, and the practical results obtained by adopting the twenty days' "flooring" period (and its attendant conditions) have amply confirmed the scientific researches on this subject.

Hayduck has shown that the relative diastatic strengths of "short" (seven to ten days) and "long" (twenty days) malt are, (1) for heavy barleys as 100: 128.5 (average), (2) for light barleys as 100: 160.5 (average). In contradistinction to the brewer (who can only use it on exceptional occasions and for special purposes), the distiller prefers, whenever this is feasible, to use green malt rather than kilned malt. One of the principal objects of kilning brewing malt is to restrict the diastatic power; but this is the very factor which the distiller desires to preserve, as the green malt possesses roughly twice the diastatic activity of high kilned malt. It is obvious that the distiller, who regards his malt merely as a starch-converting agent, will, *ceteris paribus*, use as little kilned malt as possible. The malt whisky distiller cannot, however, use green malt, as he relies to a great extent on the kilning process for the development of the peculiar flavour characteristic of the article he produces. Moreover, it is frequently difficult during hot weather to obtain a satisfactory green malt supply, especially as the latter will not bear

carriage for any distance, and distillers who make pressed yeast (commonly called "German" yeast) find that a proportion of kilned malt is necessary for the satisfactory manufacture of this article. When the distiller is unable to use green malt he will, by preference, use a malt which has been kilned at as low a temperature as possible. Under these conditions the kilning is little more than a drying operation, and the temperature is rarely raised above 130° F.

Although green or low-dried barley malt is the saccharifying agent usually employed both in the United Kingdom and on the continent of Europe, malts prepared from other cereals are not infrequently employed for this purpose. According to Glaser and Moransky the relative starch-transforming capacities of the various malted grains, taking barley as the unit, are as follows:—

Barley malt	1.00
Rye malt	0.93
Wheat malt	1.08
Oat malt	0.30
Maize malt	0.28

Oat malt, notwithstanding its low transforming power, possesses certain advantages, inasmuch as it is easily and rapidly prepared, it acts very quickly in the mash tun, and its diastatic power is well maintained during fermentation. Rye is best malted in conjunction with a little barley or oats, as it otherwise tends to superheat and to grow together in a tangled mass.

Distillery Mashing.—Distillery mashing, although outwardly very similar to the process employed in brewing, differs very widely in some important particulars. In brewing all the necessary fermentable matter is formed from the starch by the mashing operation. The wort so obtained is then hopped and sterilized. This method of working, however, cannot be adopted by the distiller. The brewer must have a certain proportion of dextrinous, non-fermentable carbohydrate matter in his wort; the distiller, on the contrary, desires to convert the starch as completely as possible into fermentable, that is, alcohol-yielding, material. This result is obtained in two ways: first, by mashing at low temperatures, thus restricting the action of the diastase less than is the case in the brewer's mash; and, secondly, by permitting the diastatic action to continue during the fermentation period. Low temperature mashing alone will not have the desired effect, for part of the dextrinous bodies resulting from diastatic starch-transformation are not further degraded by diastase alone, but are rendered completely fermentable by the combined action of diastase and yeast. Hence the distiller is unable to boil, that is, to sterilize his wort, as he would thereby destroy the diastase entirely. In this he is at a serious disadvantage compared with the brewer, as an unsterilized wort is very liable to bacterial infection. The latter danger prevents the distiller from taking full advantage of the benefits of low-temperature mashing, and he is obliged to heat his mash to a temperature which will, at any rate, be a partial safeguard against the bacterial evil. The method employed varies according to the nature of the mash and the quality of the spirit that it is desired to obtain, but in principle it consists, or should consist, in bringing the mash as rapidly as possible to the temperature of maximum saccharification, keeping the whole at this point for some little time, then heating to the temperature of maximum liquefaction, and subsequently to as high a temperature as is consistent with the thickness of the mash and the preservation of sufficient diastase for the fermenting period.

The Fermenting Operations.—The conditions and methods of distillery fermentation vary considerably, and in some respects radically, from those employed in the brewery. In order to obtain the maximum alcohol yield the distiller is obliged to work with unsterilized wort, and at relatively high temperatures. The necessity for the former condition has already been explained, but the latter is due to the fact that the optimum working capacity of distillery yeast is reached at a temperature markedly above that most favourable to brewing types. Apart from this, if the distiller worked at brewing temperatures the

brewing yeasts would predominate, and these produce less alcohol than the distillery types. Thus at 75° F. (and above) distillery yeasts tend to predominate. The conditions of fermentation which are more or less forced upon the distiller are unfortunately also very favourable to the development of bacteria, and if special methods are not adopted to check their development, the result would seriously affect not only the quantity but also the quality of alcohol produced. The micro-organisms chiefly to be feared are those belonging to the class of fission fungi (schizomycetes), such as the butyric, the lactic, the mannitic, and mucic ferments.

Souring.—It has long been known to practical distillers that in order to avoid irregular (bacterial) fermentations it is necessary either to let the wort "sour" naturally, or to add a small quantity of acid (formerly sulphuric acid was frequently employed) to it before pitching with yeast. The reason for this necessity was until recent times by no means clear. It has, however, now been demonstrated that a slightly acid wort is a favourable medium for the free development of the desirable types of distillery yeasts, but that the growth of brewery yeasts, and especially of bacteria, is very much restricted, if not entirely suppressed, in a "soured" liquid. The acid which is the result of a properly conducted souring is lactic acid, formed by the decomposition of the sugar in the wort, by bacterial action, and according to the equation $C_6H_{12}O_6 = 2C_3H_6O_3$.

For various reasons (one being that in order to restrict the lactic fermentation when sufficient acid has formed it is necessary to heat the soured liquid to a higher temperature than is desirable in the case of the main wort) it is inexpedient to allow the souring process to take place in the main wort. It is usual to make a small mash, prepared on special lines, for the production of the "bub" (German *Hefegut*), as the soured wort is termed. This is allowed either to "sour" spontaneously, or, better, is inoculated with a pure culture of *B. acidificans longissimus*, which for this purpose is undoubtedly the best variety of the lactic acid bacteria. The optimum developing temperature of this organism is about 104° F., but it is better to keep the wort at 122° F., for at the latter temperature practically no other bacteria are capable of development. When the lactification is completed the wort is raised to 165° F. in order to cripple the lactifying bacteria—otherwise souring would go on in the main fermentation—and after cooling to the proper point it is pitched with yeast. When a good crop of the latter is formed the whole is added to the main wort. The beneficial effects of souring are not due to any specific action of the lactifying bacteria, but purely to the lactic acid formed. It has been found that excellent—and in some respects better—results can be obtained by the use of lactic acid as such in place of the old souring process. Some success has also attended the introduction of hydrofluoric acid and its salts as a substitute for lactic acid. Hydrofluoric acid is poisonous to bacteria in doses which do not affect distillery yeasts, and the latter can be cultivated in such a manner as to render them capable of withstanding as much as 0.2% of this acid. Bacteria, apparently, cannot be "acclimatized" in this fashion. Wort treated with hydrofluoric acid produce practically no side fermentation, and it seems a fact that this substance stimulates diastatic action, and thus permits of the use of relatively low mashing temperatures. The yeast employed in British and Irish pot-still and in some patent-still distilleries is still generally obtained from breweries, but it is now generally recognized that—at any rate for the production of industrial alcohol and for "plain" spirit—a special type of yeast such as the so-called "German" yeast, a good deal of which comes from Holland, but which is now also produced in the United Kingdom on a considerable scale, is desirable in the distillery. This variety of yeast, although closely allied botanically to that used in brewing (belonging as it does to the same class, namely *Saccharomyces cerevisiae*), is capable of effecting a far more rapid and far more complete fermentation than the latter. Probably the most widely known and best "pure-culture" distillery yeast is the one called "Species II," first produced in the laboratories of the

Berlin Distillers' Association. The optimum working temperature of distillery yeast is at about 81.5° F.; but it would be inexpedient to start the main fermentation at this temperature, as the subsequent rise may be as much as 36°. It is, therefore, usual to pitch at about 80° F., and then, by means of the attemperator, to cool down very slowly until the temperature reaches 60° F. The temperature subsequently rises as fermentation goes on, but should not exceed 85° F. Pot-still malt whisky distillers frequently work at somewhat higher temperatures. Fermentation is carried on until practically all the saccharine matter is converted into alcohol; and when this is the case, the gravity of the mash is about equal to, or even a little below, that of water. In malt whisky distilleries the original gravity of the wort is usually from 1.050 to 1.060, occasionally lower, but in grain and potato distilleries the worts are often made up to a higher gravity. In Germany gravities as high as 1.11 are employed; but in that country "thick" mashes, owing to the method employed to raise the duty, are a matter of necessity rather than of choice.

It will be seen from the above that the employment of malt for the purpose of rendering starch soluble and fermentable leaves a good deal to be desired in regard to both the mashing and fermenting operations in the production of spirit. The use of acid for this purpose is also attended by serious drawbacks inasmuch as a considerable proportion of the starch is converted into "reversion" products which are practically unfermentable and thus considerable caramelization is brought about by the action of the acid. In the case of the production of potable spirits such as whisky, where the alcohol yield is not the only object, and the conservation of a specific flavour is desired, it is doubtful whether any material improvement can be made in this connexion, as it seems probable that part of the flavour may be due to some of the circumstances which from the point of view of alcoholic yield alone are most undesirable. For the production of industrial alcohol, however, and for the preparation of spirit intended to be used in compound potable spirits and liqueurs, these difficulties have now been surmounted. The older methods at the disposal of the distiller have of late years been enriched by the discovery that certain micro-organisms (or rather the enzymes contained in them) possess the power of converting starch into sugar, and also of splitting up saccharine materials into the ordinary products of alcoholic fermentation. It is possible to inoculate a sterilized wort with a pure culture of a micro-organism of this description and subsequently with a pure culture of yeast, and so to avoid all undesirable features of the older processes.

Details concerning the practical application of this discovery will be found below under *Industrial Alcohol*.

Distillation.—The primary object of the distillation of all fermented liquids is that of separating, as far as possible, alcohol from the non-volatile constituents of the wash. In the second place the object of the distiller is to rectify and concentrate the dilute alcoholic liquid obtained by simple distillation. The degree and manner of rectification and concentration vary in accordance with the type of spirit to be produced, and it will be better therefore to discuss methods of distillation under the headings of the different types of spirit concerned.

1. *Scotch Pot-still Whisky*.—The raw material employed in the manufacture of Scotch pot-still whisky is practically without exception malted barley only. The malt is prepared **Whisky** in much the same way as brewery malt, except that it is generally cured (dried) with a peat, or mixed peat and coke, fire. It is to this peat drying that the so-called smoky flavour of most Scotch pot-still whisky is due. The malt is mashed in a mash-tun on lines similar to those obtaining in the brewery, except that the mashing heats are somewhat different. They should be so regulated as to obtain the maximum yield consistent with the preservation of the proper flavour. In order to obtain as high a yield as possible four separate mashes are as a rule made with the same lot of grist, the temperature of each successive mash being somewhat higher than that preceding it. The worts obtained from the first three mashes are united prior to

fermentation. The liquor from the last mash is used as mashing liquor for the next lot of malt. The general scheme of operations subsequent to mashing is illustrated by fig. 7, which depicts the process at one of Messrs Buchanan's distilleries.

After the wort has been drawn off it is run through a refrigerator, and then passes to the wash backs. The latter are large wooden vessels corresponding to the fermenting backs of the brewer. Here the wort is pitched with yeast, the fermentation starting as a rule

in the low wines still is termed "spent lees." Both these liquors are run to waste, or where local circumstances make it necessary are destroyed, or modified by means of a purification process. In some cases the solid matter contained is converted into manure. The mixed feints and foreshots contained in the feints receiver are worked up in the subsequent operation, being mixed with the next lot of low wines in the proportion of roughly one third mixed feints and foreshots, and two-thirds low wines. The object of the double distillation as described is in the first place to concentrate the alcohol

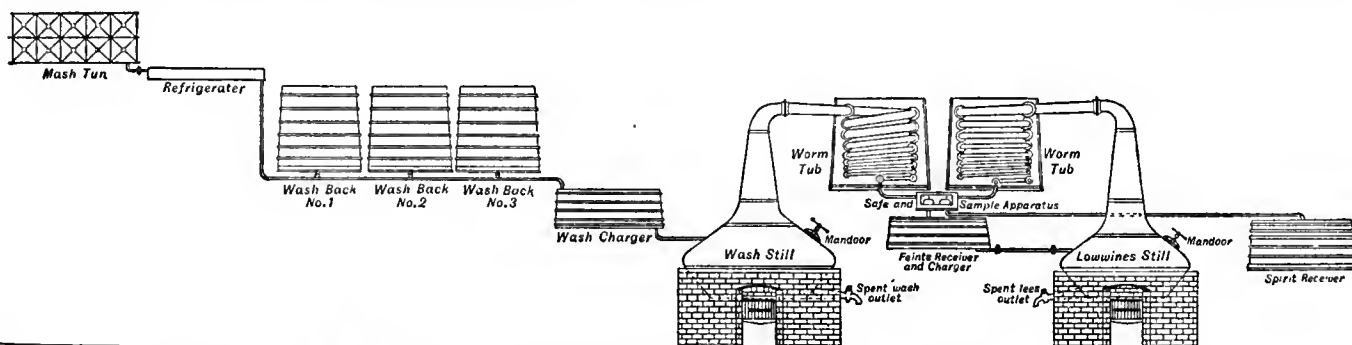

FIG. 7.—Diagram of Malt-whisky Pot-still Plant. (Messrs J. Buchanan's Glentaucher's Distillery, Speyside, N.B.)

at something over 70° F. The maximum temperature attained at some distilleries frequently exceeds 90° F., but in the opinion of the author this is excessive. Fermentation proceeds until the whole of the saccharine matter is converted into alcohol, and when this is the case the gravity of the fermented wort—now termed wash—should be equal to, or a little lower than that of water. The wash from the various wash backs is now collected in the wash charger, which is an intermediary vessel serving for the mixing of the contents of the different wash backs, and also for the purpose of enabling the revenue officer to ascertain the total volume and strength of the wash. In this way he obtains a check on the quantity and gravity of the wort as taken prior to fermentation. From the wash charger the wash passes to the wash still, which is a copper vessel varying in size in Scotland from about 3000 to 8000 gallons. The usual size is about 5000 to 6000 gallons. This still is heated either by direct fire (as shown in the illustration), or frequently by means of a steam jacket or steam coil. The wash still is provided with rakes or chains actuated from outside for the purpose of preventing the solid contents of the wash from being charred. The whole of the spirit is drawn off in one fraction from this still, and is condensed by means of a copper coil cooled by running water. The distillate so obtained is termed "low wines," and the strength is generally about 50 u.p. The next stage in the process is the redistillation of the low wines. This takes place in the low wines still, which is a vessel similar to the wash still, except that it is rather smaller. The distillate from the low wines still is collected in three separate fractions termed respectively and in the order of their collection, (a) foreshots, (b) clean spirit or whisky, (c) feints. The quantity of each of these three fractions collected will vary somewhat according to the nature of the spirit being made, the quality of the material employed, and to other circumstances into which it is not necessary to enter. As a rule the foreshots will be run from the starting of the still down to 25 to 30 o.p. Whisky will be collected from about 25 to 30 o.p. to proof, the remainder, namely the residual fraction, from proof down to water, being feints. In collecting the various fractions the distiller is mainly guided by the alcoholic strength of the spirit coming over, by its flavour, and by its behaviour on mixing with water. It is the object of the distiller to obtain a clean spirit or whisky which gives as little "blueing," that is opalescence, when mixed with water as possible. The foreshots and feints are run into the feints receiver, the whisky to the spirit receiver. The distiller is able to divert the spirit coming over into either of these receivers at will by means of a movable arm contained in the spirit safe. The spirit safe is a closed vessel containing two or more broad funnels each of which is connected with a pipe leading to a feints or spirit receiver as the case may be. The movable arm fixed on to the pipe leading from the condensing coil can be actuated from without by the distiller. In this way the distiller is able to regulate the distillation at will without having access to the spirit. The quality of the spirit coming over is judged by means of the apparatus contained in the sampling safe. This is another closed vessel containing hydrometer jars fitted with hydrometers, and with a water supply. A small part of the spirit coming from the coil passes through this box into the hydrometer jars, where its strength is taken by means of the hydrometers and its behaviour towards water ascertained by mixing with a known volume of the same. The strength of the whisky collected varies at different distilleries, but it is generally from 25 to 30 o.p. The quantity and strength of the spirit are gauged in the spirit receiver by the revenue officer, and the spirit is then run into casks and placed in store. The residue in the wash still is termed "pot ale" or "spent wash," the residue

contained in the wash, and secondly to rectify it. Part of the volatile by-products pass out in the spent wash and spent lees; another part is eliminated by the modification which some of these products undergo during storage in the feints receiver.

2. *Irish Pot-still Whisky.*—Both as regards the raw material employed and the manner of manufacture, Irish pot-still whisky differs very appreciably from the Scotch variety. There are a few distillers who work with malted barley only, but the great majority employ a mixture of from (generally) 25 to 50% of malted barley and 50 to 75% of a mixed grist of "raw" (i.e. unmalted) rye, wheat, barley and oats. The malt is not peat cured. The distillation is carried out in a type of still radically different from the Scotch pot-still. The stills (of which there are generally three as against two in the Scotch process) are very large, ranging up to 20,000 gallons. A characteristic feature of the Irish pot-still is the great length and height of the "lyne-arm," i.e. the pipe connecting the still with the condensing coil. This lyne-arm generally runs up vertically from the still for a distance of 10 to 20 ft., then horizontally for another 30 or 40 ft., again vertically for 10 to 20 ft., and is then connected to the condenser. The horizontal portion of the lyne-arm lies in a shallow trough fitted with a water supply, and the temperature of the spirit vapours prior to their passing to the condenser may thus be regulated at will. According to the length and height of the lyne-arm and the temperature of the water jacket, more or less of the vapours condense and are carried back to the still by means of a pipe running back from the horizontal portion

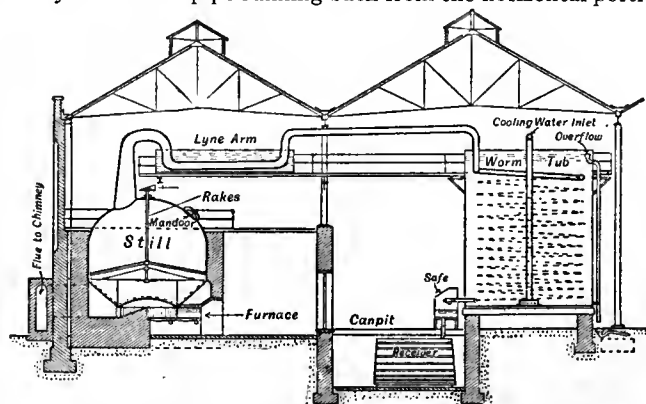

FIG. 8.—Diagram of single type of Irish Pot-still Plant. (Messrs John Jameson's Distillery, Dublin.)

of the lyne-arm to the still. The return pipe is fitted with a cock, which enables the distiller to regulate the return flow. Occasionally there is a further return pipe for the condensing coil, but this is not usual. The result of this form of plant is that it is possible to work up far greater quantities of wash and

to obtain a much higher rectification in a single operation than is possible in the case of the Scotch pot-still.

A single type of Irish pot-still plant as employed at Messrs J. Jameson's, Dublin, is shown in fig. 8. It will be noticed that in this case there is no return pipe from the lyne-arm. The method of collection and of working the Irish pot-stills is a great deal more complicated than that described under the Scotch variety. Three stills are employed and strong low wines and weak low wines, strong feints and weak feints are collected, and mixed in varying proportions according to the discretion of the distiller.

3. *American Pot-still Whisky*.—There are two main varieties of American pot-still whisky, namely, rye whisky, in which rye is the predominant raw material, and Bourbon whisky, in which maize or Indian corn is the chief substance employed. There are different varieties of these whiskies.

"Sour mash" whisky is made by scalding the raw material with pot ale (*i.e.* the residue left in the stills from the previous operation), then cooling down to mashing temperature and saccharifying by means of malt. The distillation is sometimes carried out with naked fire, but more generally by means of steam which is passed into the wash (termed "beer" in America), either in a free state or by means of a coil, and then collecting the spirit, after condensing and subsequently rectifying by means of a second distillation (termed "doubling"). "Sweet mash" whisky is made by mashing the raw material in the ordinary way by means of malt. The stills generally employed for making whisky by this process contain three compartments situated above one another and connected by means of a curve pipe. Live steam blown into the lower compartment causes the wash to boil. The vapours go up through the curved pipe into the next compartment and so cause the contents of the latter to boil. The vapour from the second compartment then passes up to the third in the same manner. The vapour from the third compartment passes into a vessel charged with low wines, and the vapours so obtained are finally condensed, forming whisky, or "high wines."

4. *Patent-still Whisky*.—Scotch and Irish patent-still or "grain" whiskies are manufactured usually with a mixed grist of raw and malted grain, and by means of an apparatus usually termed the "patent," but more properly called Coffey's still. For the manufacture of patent-still whisky a grist containing generally 25% or more of malted barley is employed. The balance consists of maize together with malted and unmalted rye, oats and wheat, and the mixture of grains employed varies at different distilleries. The mashing takes place as a general rule in an ordinary mash-tun, and calls for no special mention. The fermentation is conducted in much the same way as at pot-still distilleries, except that at some patent-still distilleries where bakers' yeast is made it is conducted on somewhat different lines, the conditions being adjusted so as to suit the propagation of a healthy type of yeast of a particular type. For fermentation of this description it is well recognized that the use of selected or pure yeast is necessary. The fermenting vessels, wash chargers, &c., are much the same as in the pot-still distillery except that they are of much larger size. The "patent" still was invented by Aeneas Coffey in the early part of the 19th century with a view of accomplishing in one operation that which necessitates several operations in the pot-still, of economizing time, fuel, and material, and also of obtaining at will a spirit of a higher purity than that which can be got by the pot-still. It is sometimes stated that the patent still does not produce whisky, but merely plain spirit or alcohol, but as a matter of fact this is not the case. It can be so worked by selecting the proper materials and by running the still in a particular way as to produce an article which is most distinctly a potable spirit of the character of whisky. It can also be employed by altering the proportion of the materials and by running the still differently to produce a spirit which may be used for purposes of methylation, or which may pass through the hands of the rectifier and emerge as plain spirit or alcohol pure and simple. It is, however, quite impossible to obtain from the Coffey still a really plain or silent spirit such as that produced by some of the stills on the continent of Europe; in order to obtain this type of spirit,

the product of the patent still is treated by the rectifier in a special rectifying still with charcoal and potash. In certain details the Coffey still has been modified since it was devised by the inventor, but in principle it has been very little altered. Although it does not in some respects compare with some of the modern continental rectifying stills, it must be remembered that it is not made for the purpose of obtaining pure alcohol, and from this point of view it is a remarkable tribute to the ingenuity of Coffey that he should at so early a date have designed so perfect an apparatus.

The still shown in fig. 9 is one of the type designed by Messrs Robert Willison of Alloa for Scotch grain whisky distilleries. The Coffey still is a double still consisting of two adjacent columns, termed respectively the rectifier and analyser. Both columns are subdivided into a number of chambers by perforated copper plates. The main structure is of wood firmly braced with iron. Each compartment communicates with the next by means of a drop pipe standing slightly above the level of the plate and passing downwards into a cup, which forms a water seal or joint. Each compartment is also fitted with a safety valve in case of the plates choking or of the pressure rising unduly. At the beginning of the operation both columns are filled with steam at a pressure of about 5 lb. The steam at the base of the analyser passes upwards through it, and then to the bottom of the rectifier by means of the pipe B (termed the low-wines vapour pipe), and then up through the rectifier. When both columns are filled with steam the wash is pumped up from the wash charger through the copper pipe A to near the top of the rectifier, which it enters at the point A'. The pipe A runs from the top to the bottom of the rectifier forming a double bend in each compartment, and the wash (contained in the pipe) travels down in a zigzag course until it reaches the base of the rectifier at the point C. From here (still remaining in pipe A) it is pumped to the top of the analyser, where it emerges from the pipe and covers the plate of the top compartment. As there is an upward pressure of steam the wash is not able to pass through the perforations of the copper plate forming the base of the compartment, but collects until its level reaches the top of the first drop pipe. Through this it passes into the cup on the plate below and so out on to the next plate. The drop pipes being trapped by the cups the steam cannot pass upwards through the former. In this way the wash passes through compartment to compartment of the analyser until it reaches the bottom, and then passes out by means of the spent wash siphon. The steam on its passage up through the analyser carried with it the alcoholic vapours and other volatile matters contained in the wash. The alcoholic vapours pass from the top of the analyser to the bottom of the rectifier, and then upwards through the latter from compartment to compartment. In so doing they are gradually cooled by the wash flowing down through the pipe A. This gradual cooling causes the less volatile constituents to condense and so to flow downwards through the column until they reach the base of the rectifier. At a certain point in the upper part of the rectifier (marked S in the illustration) the bottom of the compartment in question is formed not of a perforated plate, but of a stout copper sheet, pierced by a fairly wide pipe, which stands up about two inches above the level of the former. This is termed the spirit plate. It is so placed that the alcoholic vapours condense either on or immediately above it. The alcohol passes out from the spirit plate chamber from one of the two pipes shown in the illustration (either to the spirits or to the feints receiver as the case may be), and is then further cooled, in order to complete the condensation, by means of coils immersed in flowing water, as shown in the illustration. In order to render the condensation still more perfect the upper chambers of the rectifier are fitted with coils through which cold water is passed. The vapours condensed by this fall upon the spirit plate. The vapours which have an appreciably lower boiling-point than ethylic alcohol, such as the aldehydes, together with a large volume of carbonic acid gas derived from the wash, pass out of the top of the rectifier by means of the "incondensable gas" pipe E, and thence to a separate condensing coil. The spirit obtained is of high strength, generally about 64 o.p. The less volatile constituents of the wash, generally termed "fusel oil," which pass out of the base of the rectifier, are cooled and then passed to the oil vessel. After the apparatus has been worked for some time the fusel oil which floats in a layer on the top of the contents of the oil vessel is skimmed off. The watery layer from the oil vessel, which still contains a little alcohol, is again passed through the apparatus to remove the last trace of the latter. By employing the cold wash to cool the alcoholic vapours much condensing water is saved as compared with the ordinary pot-still apparatus. Conversely, as the hot alcohol vapours heat the cold wash to boiling-point, there is a great economy of coal as compared with the older process.

The distillation is controlled by an operator standing on the platform P. The operator is able by means of the sampling apparatus X to determine the quality and strength of the spirit and of the wash. He is able, by regulating the quantity of steam admitted to the apparatus, by modifying the rate of pumping, and by running

the spirit either to the spirit or to the feints receiver, as the case may be, to control the strength and quality of the product in much the same manner as does the pot-still distiller.

of alcohol 95 parts and wood naphtha 5 parts, and they may also, under certain conditions and restrictions, employ pure alcohol. It is generally considered that the most satisfactory way of methylating or "denaturing" spirit intended for technical purposes is that which consists in adding one of the ingredients which would ordinarily be used in the course of manufacture, or some other ingredient which does not interfere with the manufacture of the specific article in question. In the year 1906 the total quantity of "industrial methylated spirit" employed in the United Kingdom was 2,041,373 proof gallons. The quantity of pure alcohol employed in the same year was 435,915 gallons; for the same period the total quantity of ordinary methylated spirit produced was 6,055,285 gallons. On the continent of Europe and in America alcohol is used in the industries to a greater extent than is the case in the United Kingdom.

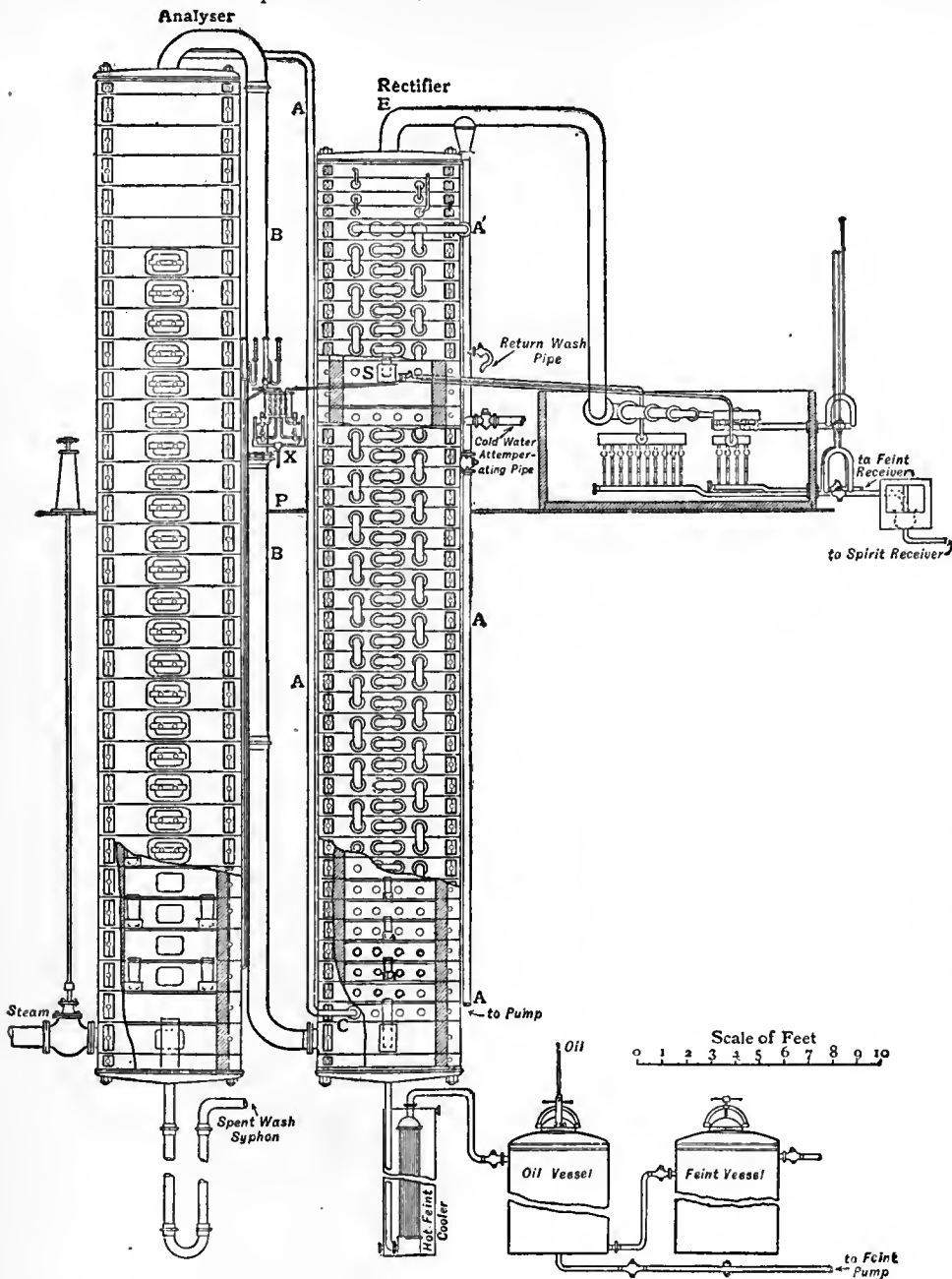

FIG. 9.—Diagram of a Coffey Still. (Messrs R. Willison & Co., Alloa.)

Industrial Alcohol.—By industrial alcohol is understood spirit which is employed for other than potable purposes. Alcohol is largely employed in the industries and arts, and for domestic purposes. It is chiefly used for the manufacture of varnish, fine chemicals and dye-stuffs, for pharmaceutical purposes, and in the form of ordinary methylated spirit for lighting and heating. Ordinary methylated spirit for domestic purposes is prepared in the United Kingdom by adding 10 parts of wood naphtha and a small quantity of mineral naphtha to 90 parts of strong spirit. This spirit may be employed duty free for any purpose, except that it may not be purified in such a manner as to produce pure alcohol or a potable spirit. Up to the year 1906 British manufacturers were forced either to use this spirit or to pay the full duty if they wished to use any other variety. As a result of the recommendations of the industrial alcohol committee of 1904-1905 the Revenue Act of 1906 contained provisions modifying this undesirable state of affairs. Manufacturers may now use a special "industrial methylated spirit," which consists

the preparation of potato mashes has been employed. The sugar present in the beet and in molasses is not directly fermentable. It is generally rendered so by the addition of a small quantity of mineral acid. The saccharine solution is then pitched with yeast and fermented in the ordinary way. Potatoes, maize, rice and other starchy materials are generally treated under pressure with steam in a close vessel termed a converter. This method entirely disrupts the starch cells, and so renders the starch very readily convertible. When the pressure "cooking" is completed the mash is run out of the converter into the mash tun proper, where it is treated with a minimum quantity of malt at the most suitable temperature. The wort obtained is, after (as a rule) removing a part of the husks and skins by means of special machinery, pitched with yeast and fermented.

We have seen above in the paragraphs dealing with the general features of distillery operations that the method of converting starch into sugar by means of malt possesses very serious

drawbacks. Of late years a process has been discovered whereby these disadvantages, as far as industrial spirit is concerned, are entirely overcome. It has been known for some time that certain micro-organisms (or rather the enzymes contained in them) possess the power of converting the starch directly into fermentable sugar, and further of splitting up the latter into the usual products of alcoholic fermentation. Among the organisms of this description first known may be mentioned the moulds, *Aspergillus Oryzae* and *Eurotium Oryzae*. Later A. L. C. Calmette discovered a mould to which he gave the name *Amylomyces Rouxii*, which was employed by A. Collette and A. Boidin for producing alcohol on an industrial scale. Since then Boidin has discovered another mould to which he gave the name of *Mucor β*, which possesses advantages over the other micro-organisms named inasmuch as it works more rapidly and in a more concentrated wort. The amylo process, as this method of producing alcohol is termed, is now worked on a very large scale in many countries. The process consists in inoculating a sterile (mostly maize or rice) mash in a closed vessel with a very small quantity of the spores of the mould, passing filtered air through the liquid for a certain time, thus causing the material to develop very rapidly, and subsequently inducing fermentation by the addition of a pure yeast culture. The mould is of itself capable of fermenting the sugar produced, but it is found that the yeast acts more quickly, and will stand a greater percentage of alcohol, than the former. The whole process occupies about five days. The advantages accruing from operating, as is the case in the amylo process, with sterile worts are enormous, inasmuch as undesirable bacterial and side fermentations are impossible. The quality and yield of the alcohol is, owing to this fact, considerably improved. The fact that no malt is employed leads to a further very considerable economy. The general course of operations in the amylo process may be gathered from fig. 10. The maize or other raw

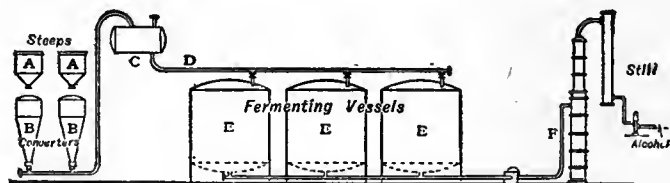

FIG. 10.—Diagram of the Amylo Process.

material is steeped in the vessels AA with a sufficient quantity of dilute acid to convert the secondary into primary phosphates. When the steeping operations are complete the material passes into the converters BB. After conversion is completed the disintegrated material passes into the vessel C, and thence by means of the pipe D to the fermenting vessels EEE. After fermentation is completed the wash passes to the still F.

It is impossible at present to employ the amylo process in its most satisfactory form in the United Kingdom owing to the fact that it is necessary in order to take full advantage of the process to employ a thick wort, *i.e.* one from which the husks have not been removed. The gravity of a wort of this description cannot be taken by the saccharimeter prescribed by the spirit Acts, but no doubt this difficulty will in time be overcome. The average yield by the amylo process is from one to one and a half gallons a cwt. of raw material more than is the case with the processes ordinarily employed in the United Kingdom.

Distillation of Industrial Alcohol.—A still intended for the distillation of industrial alcohol should be so devised as to yield a spirit of the greatest strength and purity in the most economical manner. Stills are now constructed which yield in one operation a spirit containing up to 98% of absolute alcohol, and free from all but the merest traces of aldehyde, fusel oil, &c. (foreshots and tailings). An excellent still of this kind is that of R. Ilges. He takes advantage of the fact that if a liquid containing 15% of alcohol is boiled, the quantity of fusel oil in the vapour is equal to the amount in the remanent fluid, and that if the percentage of alcohol is less than 15% the amount of fusel oil in the vapour is greater than that in the liquid. It is therefore

possible, by working on proper lines, to remove the whole of the fusel from the mash by a single operation. By subjecting the vapours so obtained to a carefully regulated dephlegmation, the fusel oil condenses, together with the steam and a certain proportion of alcohol—in practice 15%. By further cooling the liquid so obtained the fusel separates out, and, being specifically lighter, rises to the surface of the watery spirit, and is then easily removed. This form of still is so arranged that any change from the correct temperature necessary for the adequate separation of the concentrated "feints" into two layers is automatically corrected by the admission of more or less cooling liquor to the refrigerating pipe coiled round the dephlegmating column. The "foreshots" (aldehyde, &c.) are removed by submitting the alcoholic vapour passing through the main dephlegmator to further purification. The Ilges apparatus yields three continuous streams of fine spirit, fusel oil, and foreshots respectively.

By-products of Fermentation and Distillation.—The main constituent of spirits is, of course, ethyl alcohol—spirit of wine—but all spirits contain small but varying quantities of by-products and it is by these that the character of a spirit is determined. The by-products are mainly formed during fermentation, but are also to a certain extent pre-existent in the raw materials, or may be formed during the operations preceding and succeeding fermentation. The nature of the by-products is complex, and varies sensibly according to the raw materials employed and the methods of malting, mashing, fermentation and distillation.

The by-products may be classified as follows: (a) higher alcohols—usually going under the name of fusel oil; (b) esters; (c) fatty acids; (d) fatty aldehydes and acetals; (e) furfuryl aldehyde; (f) terpene, terpene hydrate and ethereal oils; and (g) volatile bases. The *higher alcohols* consist of mixtures of fatty alcohols ($C_nH_{2n+1}OH$), containing three or more atoms of carbon in which, as a rule, amyl alcohol ($C_5H_{11}OH$) predominates. The fusel oil of British pot-still spirits is chiefly composed of amyl and butyl alcohols, whereas in patent spirits propyl alcohol preponderates, that is, in the finished or fine spirit, since the fusel oil separated from patent spirit in the course of distillation consists mainly of amyl and butyl alcohols. Broadly speaking, the higher alcohols present in pot are of higher molecular weight than those in patent spirits. Potato fusel contains a high proportion of isobutyl alcohol, grain fusel of *n*-butyl alcohol. The *acid* present in spirits is chiefly acetic acid, but small quantities of other acids are also found. The esters, formed by the interaction of alcohols and acids chiefly during the fermenting and distilling operations, consist almost entirely of fatty acid radicles in combination with ethyl and, to a minor extent, amyl alcohol. Ethyl acetate (acetic ester) is the main constituent of the esters, the others being mainly ethyl valerate, butyrate and propionate. Oenanthic ether (ethyl pelargonate) is one of the characteristic esters of brandy. *Furfuryl aldehyde* (furfural) is a characteristic product in pot-still spirits, although it occurs to a greater or less extent in patent spirits according to the degree of rectification. It is probable that the furfural is formed by the splitting up of a part of the pentoses contained in the wort. It was formerly thought that its occurrence in relatively large quantities in pot-still spirits was due to the charring effect of the action of the fire gases on the carbonaceous matter adhering to the bottom and sides of the still, but the author has shown that this is not the case, inasmuch as he has found that spirits distilled by means of a steam jacket instead of direct fire contain quite as much furfural as those distilled in the old way. *Terpene* and *terpene hydrate* are characteristic constituents of grain fusel. Although the *ethereal oils* appear to play an important part in determining the character of a spirit, too little is at present known of these substances to warrant any closer description.

Effect of Maturing on the By-products.—That potable spirits (excepting, of course, pure alcohol) and wine are greatly improved by age is an undeniable fact, and one that has been recognized for many hundreds, and even thousands, of years. Thus in the gospel of St Luke we have the statement "that no man having drunk old wine, straightway desireth new: for he saith,

The old is better." And again in the Apocrypha, "New friends are like new wine: when it is old, thou shalt drink it with pleasure." There is little doubt that the beneficial effect of age on the character of spirits is due to the changes effected in the character and quantity of the by-products, but the exact nature of these changes is by no means clear. Such improvement as takes place is apparently connected in some way with the free access of air to, or rather the satisfactory ventilation of, the containing vessel; for spirits preserved entirely in glass undergo relatively little change, either in taste or in chemical composition, whereas cask storage materially affects both these factors.

Concerning the changes which take place during maturation, it was formerly believed that the higher alcohols decreased with age, and that the main reason of the improvement noticeable in mature spirits was due to this fact. The author has, however, shown conclusively that this is not the case, but that on the contrary the higher alcohols generally increase during maturation. This decrease is not absolute, but only relative, and may be due to the fact that the higher alcohols are less volatile than ethyl alcohol. There is a decided increase during maturation of both the volatile and non-volatile acids. On the whole also the esters and aldehydes generally tend to increase, but not to so great an extent as was formerly believed to be the case. There is, however, a marked decrease in regard to furfural. The type of cask exercises a marked influence on the course of maturation; and, as regards whisky, spirit stored in a sherry cask undoubtedly matures more quickly than that contained in a plain wood cask. The relative humidity of the cellar in which spirit is stored has a very great effect on the course of maturation. In a very damp cellar the spirit will lose alcohol very rapidly and as a result all those changes which are favoured by these conditions will take place with relative rapidity. On the other hand, in a very dry cellar the loss of alcohol is relatively smaller than that of water (cf. Schidrowitz and Kaye, *Journ. Soc. Chem. Ind.*, June 1905).

Physiological Effects of Spirit By-products.—The nature of the physiological effects produced by the ingestion of spirits varies considerably, not only according to the class of spirit (*i.e.* whether whisky, brandy, rum, &c.) consumed, but also with its condition (*i.e.* whether new or old, and so on); and there is no doubt that the causation of these phenomena is intimately connected with the nature and quantity of the by-products, to which, as has been already said, the character of the spirit is due. Commenting on a statement in Bailey's *Book of Sports* to the effect that wine and brandy had a tendency to make a man fall on his side, whisky to make him fall forward, and cider and perry to make him fall on his back, Sir T. Lauder Brunton (*Evidence, Spirits Committee*, 1891) suggests that these statements—if correct—might indicate definite injury to various parts of the cerebellum. Thus, if the anterior part of the middle lobe of the cerebellum is injured, the animal tends to fall forward; when the posterior part is affected, the head is drawn backwards, &c. Brunton is inclined to believe that the varying action of different spirits may be due to the specific action of specific products on the separate nerve centres. Thus the cause of the epileptic convulsions produced by the injection of absinthe has been traced to the specific action of the chief flavouring agent of this liqueur.

In view of the doubt which modern research has thrown on the older theories, to the effect that the improved character of a mature, as compared with a new, spirit is due to the decrease in the quantity of the higher alcohols (*i.e.* the fusel oil), a discussion of the specific action and relative toxicity of these bodies may seem superfluous, more especially as they occur in quantities which are apparently incapable of producing serious effects. As, however, there is considerable reason for believing that the higher alcohols do influence, at any rate, the flavour of the spirit a brief reference to their physiological action seems to the author not out of place. Broadly speaking, the toxicity of the fatty alcohols increases with their molecular weight. Dujardin-Beaumez and Audigé found that the lethal dose for dogs was 5–6 grammes per kilo-body-weight for ethyl (ordinary) alcohol; 3.75 grammes for propyl alcohol; 1.8 grammes for butyl; and

1.5 grammes for n-amyl alcohol. It is interesting to note that the experiments of these investigators were conducted chiefly with the pig, as the digestive organs of the latter animal are very similar to those of man, and also because the pig is apparently the only animal which willingly takes alcohol with its food. With regard to the action of spirits generally, the investigators named above found that the digestive organs of pigs fed for thirty months with pure alcohol alone were not affected, whereas the animals treated with similar quantities of imperfectly purified spirit (whether derived from the beet, the potato or from grain) suffered considerably.

Of late years the attention of pharmacologists has been directed to furfural especially, and the aldehydes generally, as being, at any rate in part, the cause of the unpleasant after or by-effects of certain spirits. Curci and others showed that furfural in certain doses is poisonous to animals. Brunton and F. W. Tunnicliffe demonstrated a poisonous action of this substance upon man, and, comparing the after-effects upon animals of spirits containing, and freed from, aldehydes, found certain important physiological differences between them. I. Guareschi and A. Mosso first drew attention to the fact that numerous samples of reputedly pure spirits contained small quantities of certain volatile bases of an alkaloidal nature. They apparently belong to the pyridine series, and have effects similar to those of strychnine. E. Bamberger and Einhorn discovered the presence of pyridine, dimethylpyridine and other bodies belonging to the same series, in commercial fusel oil. It is possible that the existence of these volatile bases in spirit may have given rise to the—on the face of it absurd—suggestion that tar bases have been used as adulterants of whisky. It appears likely that the formation of the bases in question is connected with the use of inferior or decaying grain or maize. Thus the spirit produced in Sweden in 1879 was particularly bad and had very curious effects, and it was found, on investigation by M. Husz, that it had actually been largely prepared from decomposing grain. Moreover, C. Lombroso discovered an alkaloidal body in decayed maize, the action of which was not unlike that of strychnine. The quantities of these bases which have been found in spirits are very small, but it must be remembered that substances are known—such as abrine, for instance—which have marked effects in practically unweighable quantities. It is possible that these volatile bases may be responsible for some of the effects—very similar to alkaloidal poisoning—produced by crude spirits such as Cape "smoke" and the cheap Portuguese liqueurs.

Having described the nature and effects of spirit by-products, and the changes occurring in them during storage, the question that arises is: How is the knowledge gained by scientific research in this direction applied in practice? It may be said that the old adage "prevention is better than cure" holds good in the spirit industry as elsewhere, and the distiller, therefore, tries as far as possible to avoid the formation of those by-products which are objectionable, or at any rate to remove them during the course of manufacture. These methods for obtaining a satisfactory potable spirit are so far, however, only successful up to a certain point, and the distiller is therefore bound to have recourse to prolonged storage or to one of the many artificial processes of purification and maturing, the majority of which have been devised—with varying success—during recent years. Referring, in the first place, to what may be called the natural or "preventive" methods for the production of a well-flavoured spirit, it is necessary (a) that the water supply (for steeping, mashing, &c.) be a good one; (b) that no mouldy or inferior material be used; (c) that mashing heats be kept within reasonable limits; (d) that refrigerators be constructed so as to avoid bacterial infection; (e) that the "souring" of the wort be conducted on proper lines; (f) that a favourable and vigorous type of yeast be used; and (g) that stills, &c., be kept perfectly clean. Coming next to the methods ordinarily or frequently employed by distillers for eliminating the undesirable by-products, which, despite all care, are formed in the course of manufacture, the most important undoubtedly is purification by rational fractional distillation. By properly regulating the distilling heats, by

using a well-devised still, both in the first instance and also for rectifying, a product very free from fusel oil, and especially from fatty aldehydes and volatile ethers, may be obtained. The removal of acids—objectionable chiefly on account of the unpleasant decomposition products which they form in still—is carried out by neutralizing the still contents with an alkaline medium. The alkali so used also decomposes undesirable esters, and retains some of the aldehydes. For the elimination of fusel oil, treatment with charcoal is the most common method. Luck has suggested for this purpose the passing of the alcoholic vapours through petroleum, which is said to absorb the higher alcohols much more easily than it does ordinary spirit; and some distillers have successfully tried the method of V. Traube, which consists in treating the spirit with a saturated aqueous solution of various inorganic salts. This causes the formation of a supernatant layer, which is said to contain practically all the fusel oil as well as the greater part of the foreshot by-products, *i.e.* fatty aldehydes, &c.¹

Finally, there remain for consideration the *artificial maturing processes*. These are exceedingly numerous, but it may be said at once that the great majority of them are hardly to be taken seriously. Thus one inventor, acting on the alleged fact that spirits are improved by lengthy journeys, suggests that a miniature railway, with numerous obstacles to augment the rolling and shaking action, be laid down in the distiller's warehouse. Of the methods worthy of consideration may be mentioned, first, those depending solely on the action of currents of air, oxygen and ozone. They exist in numerous modifications, but the principle involved, broadly speaking, is to pass a current of hot or cold air or oxygen, or alternate currents of hot and cold air, or a current of ozonized air, through the liquid, with or without pressure, as the case may be. According to the patents of E. Mills and J. Barr, new whisky rapidly acquires the character of the mature sherry-cask stored spirit if the action of alternate hot and cold air currents be assisted by the addition of a little sherry and a minute trace of sulphuric acid, the latter being subsequently neutralized by lime. Secondly, there are the processes which make direct or indirect use of the electric current. Of the indirect methods in this class may be mentioned that of Hermite, which consists essentially in adding an electrolysed solution of common salt to the spirit, and subsequently redistilling. Thirdly, the processes which rely on accelerating natural cask action by artificially reproducing the conditions attendant on the latter in a purposely exaggerated or heightened form. One method strives to obtain this object by heating the spirit under pressure in an atmosphere of oxygen in a vessel containing a quantity of oak shavings. This process certainly seems calculated to remove a portion of the by-products, for the "grog" obtained in A. H. Allen's experiments by steaming the staves of an old whisky cask contained appreciably more fusel oil and esters than commercial whisky. Fourthly, we have the methods chiefly dependent on the action of cold. R. P. Pictet, by cooling a new brandy to -80° C., is said to have obtained a liquid which had apparently acquired the properties of a twelve-year-old spirit. R. C. Scott's process consists in energetically treating spirit which has been cooled down to 0° C. with dry filtered air, and the operations are so conducted, it is said, that there is no loss of alcohol or of the important aromatic esters. According to the published data, the quantity of the fusel oil is materially reduced by this method, and the quality of the spirit much improved. None of the above processes has apparently (although in practice they may give satisfactory results) been devised with a view to effecting the direct removal of those specific substances (furfural, other aldehydes and volatile bases) which later research has shown to be present to a greater extent in new or inferior spirits than in the matured or superior article, and to some of which, at any rate, owing to their acknowledged toxicity in very small quantities, it is more than reasonable (as Lauder

¹ The above chiefly applies to industrial spirit, in the manufacture of which a product which is practically pure alcohol is desired. These methods can only be used to a limited extent by whisky and brandy distillers, for a complete removal of by-products also entails destruction of the spirit's character.

Brunton and Tunnicliffe have pointed out) to suppose that at least a part of the evil effects by drinking new or inferior spirit may be ascribed. In this connexion a patent taken out by J. T. Hewitt is of interest, inasmuch as it deals with the problem of spirit purification on seemingly rational scientific lines. This patent takes advantage of the fact that furfural and similar aldehydes can be removed from spirits by distillation with phenylhydrazine-sulphonate of soda, which salt forms non-volatile products with the substance in question. (P. S.)

SPIRITUALISM, a term used by philosophical writers to denote the opposite of materialism, and also used in a narrower sense to describe the belief that the spiritual world manifests itself by producing in the physical world effects inexplicable by the known laws of nature. It is in the latter sense that it is here discussed. The belief in such occasional manifestations has probably existed as long as the belief in the existence of spirits apart from human bodies (see ANIMISM; MAGIC, &c.), and a complete examination into it would involve a discussion of the religions of all ages and nations. In 1848, however, a peculiar form of it, believed to be based on abundant experimental evidence, arose in America and spread there with great rapidity, and thence over the civilized world. To this movement, which has been called "modern spiritualism," the present article is confined.

The movement began in a single family. In 1848 a Mr and Mrs J. D. Fox and their two daughters, at Hydesville (Wayne county), New York, were much disturbed by unexplained knockings. At length Kate Fox (b. 1839) discovered that the cause of the sounds was intelligent and would make raps as requested, and, communication being established, the rapper professed to be the spirit of a murdered pedlar. An investigation into the matter was thought to show that none of the Fox family was concerned in producing the rappings; but the evidence that they were not concerned is insufficient, although similar noises had been noticed occasionally in the house before they lived there. It was, however, at Rochester, where Kate and her sister Margaret (1836–1893) went to live with a married sister (Mrs Fish) that modern spiritualism assumed its present form, and that communication was, as it was believed, established with lost relatives and deceased eminent men. The presence of certain "mediums" was required to form the link between the worlds of the living and of the dead, and Kate Fox and her sister were the first mediums. Spiritualists do not as yet claim to know what special qualities in mediums enable spirits thus to make use of them. The earliest communications were carried on by means of "raps," or, as Sir William Crookes calls them, "percussive sounds." It was agreed that one rap should mean "no" and three "yes," while more complicated messages were—and are—obtained in other ways, such as calling over or pointing to letters of the alphabet, when raps occur at the required letters.

The idea of communicating with the departed was naturally attractive even to the merely curious, still more to those who were mourning for lost friends, and most of all to those who believed that this was the commencement of a new revelation. The first two causes have attracted many inquirers; but it is the last that has chiefly given to modern spiritualism its religious aspect. Many came to witness the new wonder, and the excitement and interest spread rapidly. It should be noted that expectations favourable to the new idea had already been created by the interest in mesmerism and the phenomena of hypnotic trance (see HYPNOTISM), widely diffused at this time both in America and Europe. It was believed that information about other worlds and from higher intelligences could be obtained from persons in the sleep-waking state. Andrew Jackson Davis (*q.v.*) was in America the most prominent example of such persons; his work, *The Principles of Nature, Her Divine Revelations* (New York, 1847), was alleged to have been dictated in "clairvoyant" trance, and before 1848 his followers were expecting a new religious revelation. Many reputed "clairvoyants" developed into mediums (*q.v.*). The "spiritualistic" movement spread like an epidemic. "Spirit circles" were soon formed in many families. There is very little evidence to show that mediumship

arose anywhere spontaneously,¹ but those who sat with the Foxes were often found to become mediums themselves and then in their turn developed mediumship in others. The mere reading of accounts of séances developed the peculiar susceptibility in some persons, while others, who became mediums ultimately, did so only after prolonged and patient waiting.

There seems to have been little practical interest in spiritualism in England till 1852, when its first development took the form of a mania for table-turning (*q.v.*). This seems to have prevailed all over Europe in 1853. In England it was greatly stimulated by the visit of Mrs Hayden, a professional medium from Boston, in the winter of 1852-1853. Daniel Dunglas Home, the next medium of importance who appeared in London, came over from America in 1855; and for many years almost all the chief mediums for physical phenomena known in England came from the United States. It was at Keighley in Yorkshire—where also the first English periodical, the *Yorkshire Spiritual Telegraph*, was published in 1855 and onwards—that spiritualism as a religious movement first made any mark in England; but this movement, though it spread rather widely, cannot be said to have attained at any time very vigorous proportions. It had taken more hold in its original home in the United States of America, and thence it has spread in some degree to most Christian countries. Nowhere, however, has there been much religious organization in connexion with it, and the force of the movement seems to have declined rather than increased.

In the present article it is impossible to give an exhaustive catalogue of the phenomena and modes of communication of modern spiritualism.² The greater part of the phenomena may be divided into two classes. To the first belong what may be called the *physical phenomena* (*q.v.*) of spiritualism—those, namely, which, if correctly observed and due neither to conscious or unconscious trickery nor to hallucination or illusion on the part of the observers, exhibit a force acting in the physical world hitherto unknown to science. The earliest of these phenomena were the raps already spoken of and other sounds occurring without apparent physical cause, and the similarly mysterious movements of furniture and other objects; and these were shortly followed by the ringing of bells and playing of musical instruments. Later followed the appearance of lights; quasi-human voices; musical sounds, produced, it is said, without instruments; the “materialization” or presence in material form of what seemed to be human hands and faces, and ultimately of complete figures, alleged to be not those of any person present, and sometimes claimed by witnesses as deceased relatives; “psychography,” or “direct writing and drawing,” asserted to be done without human intervention; “spirit-photography,” or the appearance on photographic plates of human and other forms when no counterpart was visible before the camera to any but specially endowed seers;³ unfastening of cords and bonds; elongation of the medium’s body; handling of red-hot coals; and the apparent passage of solids through solids without disintegration.

The second class of phenomena, which we may call the automatic, consists in table-tilting and turning with contact; writing, drawing, &c., through the medium’s hand; convulsive movements and involuntary dancing; entrancement, trance-speaking, and personation by the medium of deceased persons attributed to temporary “possession” (*q.v.*); seeing spirits and visions and hearing phantom voices. This class bears affinity to some of the phenomena of hypnotism and of certain nervous

¹ It is possible that the family of Dr Phelps were unaware of the “Rochester knockings” when the disturbances began in his house at Stratford, Connecticut, in 1850 (see Capron’s *Modern Spiritualism, its Facts, &c.*); but these disturbances, as recorded, have no closer resemblance to the ordinary occurrences at a spiritualistic séance than those which took place at Tedworth in 1661 (see Glanvill’s *Sadducismus Triumphatus*) and at Slawensik in 1806 (see Kerner’s *Seherin von Prevorst*), and others too numerous to mention.

² See the articles on PSYCHICAL RESEARCH; MAGIC; CONJURING; AUTOMATISM; DIVINATION; CRYSTAL GAZING; HYPNOTISM; APPARITIONS; HALLUCINATIONS; HAUNTINGS, &c.

³ There have been several professional photographers (all detected in fraud sooner or later) who made it their business to take photo-

complaints, to certain epidemics of the middle ages,⁴ and to phenomena that have occurred at some religious revivals.

In a third class must be placed the cure of disease by healing mediums. This belongs to medical psychology, and cannot well be studied apart from hypnotic treatment of disease, from the now well-recognized power of suggestion (*q.v.*), from “faith cures,” “mind cures,” “Christian Science” and cures connected with other forms of religious belief (see FAITH-HEALING).

Phenomena falling into the automatic class are much the most common. The investigation of Carpenter on unconscious cerebration and of Faraday on unconscious muscular action⁵ showed early in the movement that it was not necessary to look outside the medium’s own personality for the explanation of even intelligent communications unconsciously conveyed through table-tilting, automatic writing and trance-speaking—provided the matter communicated was not beyond the range of the medium’s own knowledge or powers. And the whole subject of the action of the subconscious personality—the “subliminal self”—has since been more fully worked out by psychologists and notably by F. W. H. Myers.⁶ No one conversant with the facts now doubts that what looks like possession or inspiration by an external intelligence may generally be accounted for by subconscious mentation, so that in all cases where no material effects are produced except such as can be attributed to the muscular action of the medium, the evidence for a supernormal interpretation must depend on the content of the communication. Spiritualists maintain that true information is received, which is provably unknown to the medium or other persons present, or which at least is expressed in a manner obviously beyond their powers; and they attribute this to extra-corporeal intelligences. Others, while not going so far as this, admit that the content of the communications does occasionally exceed the medium’s knowledge and affords evidence of telepathic communication (see TELEPATHY) between living persons. Probably most persons who have studied the subject would now be inclined to go this length; and there is some evidence, notably in connexion with the trances of an American medium, Mrs Piper,⁷ which has convinced some good observers that the hypothesis of occasional communication from deceased persons must be seriously entertained.⁸ Recently the Society of Psychical Research has obtained from various persons automatic script affording important new material for investigation and which *prima facie* supports the spiritualistic hypothesis. Whether or not further study of the scripts of these writers confirms this hypothesis, it cannot fail to throw light on the nature of the intelligence involved. The scripts contain some matter unknown to the writers, and in particular show interconnexions with each other not to be accounted for by knowledge normally possessed by the writers.⁹

At no period of the spiritualistic movement has the class of physical phenomena been accepted altogether without criticism. Most spiritualists know that much fraud in connexion with them has been discovered—frequently by spiritualists themselves—and that the conditions favourable to obtaining them are often such as favour fraud. It is with a full knowledge of these difficulties in the way of investigation that they maintain that unmistakably genuine phenomena are of constant occurrence. Many volumes containing accounts of such phenomena have been printed, and appeal is often made to the mass of evidence so accumulated. “No physical science can array a title of the mass of evidence by which psychism” (*i.e.* what is usually called spiritualism) “is supported,” says Serjeant Cox.¹⁰ But the

graphs which should contain, besides the normal sitter, representations of deceased friends. For an account of these see *Proceedings of the Society for Psychical Research*, vii. 268.

⁴ See Hecker, *Epidemics of the Middle Ages* (1859).

⁵ *Athenaeum* (July 2, 1853); see also on this subject Chevreul, *De la baguette divinatoire, &c.* (1854).

⁶ *Human Personality and its Survival of Bodily Death* (2 vols., 1903).

⁷ See *Proceedings of the Society for Psychical Research*, vi. 436; viii. 1; xiii. 284; xxiv. 351.

⁸ See F. W. H. Myers, *op. cit.*

⁹ See *Proceedings of the Society for Psychical Research*, xx., xxi. 166; xxii. 19; xxiv. 2-328.

¹⁰ *Mechanism of Man: What am I?* (1879), ii. 313.

majority of these accounts have scarcely any scientific value. Spiritualists have, as a rule, sought to convince not by testimony but by ocular demonstration. Yet, if there is not a mass of scientific evidence, there are a number of witnesses—among them distinguished men of science and others of undoubted intelligence—who have convinced themselves by observation that phenomena occur which cannot be explained by known causes; and this fact must carry weight, even without careful records, when the witnesses are otherwise known to be competent and trustworthy observers.

Among proposed normal explanations of these phenomena that of hallucination (*q.v.*), including illusion as to what is seen almost amounting to hallucination, deserves careful consideration. Sensory hallucination of several persons together who are not in a hypnotic state is, however, a rare phenomena outside the séance room and must not therefore be lightly assumed within it; nor is it in most cases a plausible explanation where there is general agreement not only of all the witnesses but of more than one sense as to what is perceived, as distinguished from what is inferred. Nevertheless something of the kind seems occasionally to have happened, especially at some of the séances with Home.¹

What may broadly be called "conjuring" is a much more probable explanation of most of the recorded phenomena; and in the vast majority of cases the witnesses do not seem to have duly appreciated the possibilities of conjuring, and have consequently neither taken sufficient precautions to exclude it nor allowed for the accidental circumstances which may on any particular occasion favour special tricks or illusions. The experiments of S. J. Davey and R. Hodgson should be studied in this connexion.² At a spiritualistic séance the medium has the privilege of failing whenever he pleases and there is seldom any settled programme—circumstances very favourable to deception. As it was put by Mr Stainton Moses, a leading spiritualist and himself a medium, who wrote under the *nom de plume* of "M.A. (Oxen)": "In 99 out of every 100 cases people do not get what they want or expect. Test after test, cunningly devised, on which the investigator has set his mind, is put aside, and another substituted."³ In other words, the evidence is rarely strictly experimental, and this not only gives facilities for fraud, but makes it necessary to allow a large margin for accidents, mistakes and mal-observation. It may be urged that if none of the phenomena is genuine we have to assume a large amount of apparently aimless trickery in non-professional mediums. But it must be borne in mind that the most excellent moral character in the medium is no guarantee against trickery, unless it can be proved that he was in no abnormal mental condition when the phenomena occurred; and extraordinary deceptions are known to have been carried on by hysterical patients and others with no apparent motive.

One of the possibilities to be allowed for is that of exceptional muscular endowment or anatomical peculiarity in the medium. For instance, it is not very uncommon to find persons who can make loud sounds by partially dislocating and restoring the toe, knee, or other joints, and some experiments made with the Fox girls in 1851 supported the view that they made raps by this method.

Besides the general arguments for supposing that the physical phenomena of spiritualism may be due to conjuring, there are two special reasons which gain in force as time goes on. (1) Almost every medium who has been prominently before the public has at some time or other been detected in fraud, or what cannot be distinguished from fraud except on some violently improbable hypothesis; and (2) although it is easy to devise experiments of various kinds which, by eliminating the necessity for continuous observation on the part of the investigator, would place certain phenomena above the suspicion of conjur-

¹ See, e.g., *Report on Spiritualism of the Committee of the London Dialectical Society* (1871), pp. 207, 367–369. See also Guldenstubbe, *De la réalité des esprits* (1857), p. 66; also Maxwell, *Les Phénomènes psychiques* (1903).

² See *Proceedings of the Society for Psychical Research*, iv. 371; viii. 253.

³ *Human Nature*, for 1876, p. 267.

ing, there is no good evidence that such experiments have ever succeeded.

Nevertheless there does exist evidence for the genuineness of the physical phenomena which deserves consideration. Count Agénor de Gasparin, in his *Tables tournantes* (Paris, 1854), gives an account of what seem to have been careful experiments, though they are hardly described in sufficient detail to enable us to form an independent judgment. They convinced him that by some unknown force tables could be got to move without contact. The experiments were conducted with his own family and friends without professional mediums, and in some of them he was assisted by M. Thury, professor of physics at Geneva, who was also convinced of the operation of an unknown force.⁴ The minutes of the sub-committee No. 1 of the committee of the Dialectical Society (*op. cit.*, pp. 373–391) report that tables moved without contact, whilst all the persons present knelt on chairs (the backs of which were turned to the table) with their hands on the backs. The report, however, would be of greater value if the names of the medium and of the working members of the committee were given—we only know that of Serjeant Cox—and if they had written independent accounts of what they witnessed. Sir William Crookes has published accounts of striking experiments and observations with D. D. Home, which have left him convinced of the genuineness of the wide range of physical phenomena which occurred through Home's mediumship.⁵ Of considerable interest again are the experiences of Mr Stainton Moses between 1870 and 1880, of which the best account has been compiled from contemporary records by F. W. H. Myers in two papers published in the *Proceedings of the Society for Psychical Research*.⁶ More recently several men of science, including Sir Oliver Lodge in England, Professor Charles Richet in France, and Professors Schiaparelli and Morselli in Italy, have convinced themselves of the supernormal character (though not of any spiritualistic explanation) of certain physical phenomena that have occurred in the presence of a Neapolitan medium, Eusapia Palladino, though it is known that she frequently practises deception.⁷ M. Joseph Maxwell, of Bordeaux, has published accounts⁸ of raps and movements of objects without contact, witnessed with private and other mediums, which he appears to have observed with care, though he does not describe the conditions sufficiently for others to form any independent judgment about them.

The interest in spiritualism, apart from scientific curiosity and mere love of the marvellous, is partly due to the belief that trustworthy information and advice about mundane matters can be obtained through mediums—to the same impulse in fact which has in all ages attracted inquirers to fortune-tellers. The more thoughtful spiritualists, however, are chiefly interested in the assurance of life and progress after death, and the moral and religious teaching, which they obtain through automatic writing and trance-speaking. It was discovered very early in the movement that the accuracy of these communications could not always be relied on; but it is maintained by spiritualists that by the intelligent exercise of the reason it is possible to judge whether the communicating intelligence is trustworthy, especially after prolonged acquaintance with particular intelligences, or where proofs are given of identity with persons known to have been trustworthy on earth. Such intelligences are not supposed to be infallible, but to have the knowledge of spirit life superadded to their earthly experience. Still the agreement between communications so received has not been sufficiently

⁴ See Thury, *Les Tables tournantes considérées au point de vue de la question de physique générale qui s'y rattache* (Geneva, 1855).

⁵ *Quart. Journ. of Science* (July and Oct. 1871; republished with other papers by Crookes, under the title of *Researches on the Phenomena of Spiritualism* (1874–1876)). See also his "Notes of Séances with D.D. Home," *Proceedings of the Society for Psychical Research*, vi. 98.

⁶ *Proceedings of the Society for Psychical Research*, ix. 245; xi. 24.

⁷ See E. Morselli, *Psicologia e spiritismo* (Turin, 1908); cf. also *Bulletin de l'institut général psychologique* (Nov.–Dec., 1908), and *Proceedings of the Society for Psychical Research*, xxiii. 306.

⁸ Maxwell, *Les Phénomènes psychiques* (1st ed., Paris, 1903). There is also an English translation entitled *Metapsychical Phenomena* (London, 1905).

great for anything like a universal spiritualistic creed to have been arrived at. In France the doctrine of successive reincarnations with intervals of spirit life promulgated by Allan Kardec (L. H. D. Rivail) forms a prominent element of spiritualistic belief. This view has, however, made but little way in England and America, where the opinions of the great majority of spiritualists vary from orthodox Christianity to Unitarianism of an extreme kind. Probably it would be impossible to unite spiritualists in any creed, which, besides the generally accepted belief in God and immortality, should postulate more than the progress of the spirit after death, and the power of some of the dead to communicate with the living by means of mediums.

Spiritualism has been accused of a tendency to produce insanity, but spiritualistic sittings carried on by private persons do not appear to be harmful provided those who find in themselves "mediumistic" powers do not lose their self-control and exercise these powers when they do not desire to do so, or against their better judgment. Public sittings are apt to be means of obtaining money by false pretences, and the great scandal of spiritualism is undoubtedly the encouragement it gives to the immoral trade of fraudulent mediumship.

BIBLIOGRAPHY.—In addition to the works already mentioned, the student, for a general idea of the whole subject, should consult the following: F. Podmore, *Modern Spiritualism* (2 vols., London, 1902), and *The Newer Spiritualism* (1910); F. W. H. Myers, *Human Personality and its Survival of Bodily Death* (2 vols., 1903); E. W. Capron, *Modern Spiritualism, its Facts, &c.* (Boston, 1855), for the early history of the movement in America; J. W. Edmonds and G. T. Dexter, *Spiritualism* (New York, 1853-1855); R. Hare, *Experimental Investigations of the Spirit Manifestations* (New York, 1856); Allan Kardec, *Le livre des esprits* (1st ed., 1853); Mrs De Morgan, *From Matter to Spirit* (London, 1863), with preface by Professor De Morgan; Alfred Russel Wallace, *Miracles and Modern Spiritualism* (1876); W. Stainton Moses [M.A. (Oxon.)], *Spirit Identity and Spirit Teaching*; Zöllner, *Wissenschaftliche Abhandlungen* (the part relating to spiritualism has been translated into English under the title *Transcendental Physics* by C. C. Massey); *Report of the Seybert Commission on Spiritualism* (Philadelphia, 1887); Professor Th. Flournoy, *Des Indes à la Planète Mars* (Geneva, 1900; there is an English translation published in London); *Proceedings of the Society for Psychical Research*, passim. A succinct account of typical frauds of spiritualism is contained in D. D. Home's *Lights and Shadows of Spiritualism* (2nd ed., 1877-1878), and also in Hereward Carrington's *The Physical Phenomena of Spiritualism, Fraudulent and Genuine* (Boston 1907). (E. M. S.)

SPIT, a rotating bar for roasting meat, game or poultry. A spit usually has one or more prongs to which the meat is fixed; in the case of a basket-spit it is enclosed in an oblong basket of iron wire. The old form of spit was fixed on hooks or upon ratchets on the fire-dogs; at one end of the bar is a grooved wheel for a chain connected with a smoke-jack in the chimney, or some similar contrivance for turning the spit so that every surface of the meat is exposed to the fire in turn. The jack was sometimes turned by a boy or a small dog trained for the purpose, the boy and the dog were equally known as turn-spits. The spits, when not in use, were placed in a spit-rack over the fireplace. These primitive arrangements eventually gave place to a combined spit and mechanical roasting-jack, which was fixed to a small crane projecting from the mantelpiece. The jack, which was largely of brass, rotated when wound up, and the meat was hung below it immediately in front of the fire, and the gravy and dripping were caught in a large shallow metal pan with a high screen to prevent the diffusion of heat. The almost universal employment in England of closed kitcheners has thrown all forms of spits and jacks into disuse, but in old-fashioned kitchens they are still sometimes seen. The more ancient forms of roasting apparatus are now much sought after by collectors.

SPITALFIELDS, a district of London, England, in the western part of the metropolitan borough of Stepney. The name is derived from the fact that the land belonged to a priory of St Mary Spital, founded in 1197. Excavations have revealed a Roman burial-place here. The name is well known in connexion with the silk industry established here by French refugees after the revocation of the Edict of Nantes, in 1685.

SPITHEAD, a strait of the English Channel, between the mainland (the coast of Hampshire, England) and the north-eastern coast of the Isle of Wight, forming the eastern entrance to Southampton Water, the Solent being the western. Its length is about 12 m., and its general breadth about 4 m., though the distance between Ryde and Gilkicker Point is almost exactly 3 m. The Spit Sand, extending south-east from this promontory, gives name to the strait. On the north side opens the narrow entry to Portsmouth Harbour, with the towns of Portsmouth and Gosport east and west of it. On the south the coast of Wight rises sharply though to no great elevation; it is well wooded, and studded with country residences. Here is also the favourite watering-place of Ryde. Spithead, which as an anchorage is exposed only to the south-east, shares in the fortifications of Portsmouth Harbour, the principal station of the British navy. In this connexion the strait has been the scene of many splendid naval pageants, such as those attendant upon the jubilee in 1897, and the funeral in 1901 of Queen Victoria, and that which celebrated the coronation of King Edward VII. on the 16th of August 1902.

SPITI, an extensive minor division of Kangra district in the Punjab, India. Area, 2155 sq. m., the population (1901) being only 3231, all Buddhists. It consists of an outlying Tibetan valley among the external ranges of the Himalayas, which has a mean elevation of 12,081 ft. and contains on its borders many peaks over 20,000 ft. and one in the outer Himalayas of 23,064 ft. in altitude. Spiti originally formed part of the kingdom of Ladakh, and came into the hands of the British in 1846. The river Spiti rises at the converging angle of the Kamzang and outer Himalayan ranges at a height of 20,073 ft., drains the whole valley of Spiti, and falls into the Sutlej after a course of 120 m.

SPITSBERGEN (the name being Dutch is incorrectly, though commonly, spelled *Spitzbergen*), an Arctic archipelago, almost midway between Greenland and Novaya Zemlya, in 76° 26' to 80° 50' N. and 10° 20' to 32° 40' E., comprising the five large islands of West Spitsbergen or New Friesland, North-East Land, Edge Island, Barents Island and Prince Charles Foreland, the Wiche Islands, and many small islands divided by straits from the main group. The chief island, West Spitsbergen, shaped like a wedge pointed towards the south and deeply indented on the west and north by long branching fjords, has an area of about 15,200 sq. m. At the north-west angle of the island is a region of bold peaks and large glaciers, in the midst of which is the fine Magdalena Bay. Farther south come the series of glaciers called by the whalers "The Seven Icebergs," which drain a high snowfield reaching east almost to Wood Bay and south to the head of Cross Bay. On the south-east it is drained by glaciers towards or into Dickson and Ekman bays. South of this snowfield comes the mountainous King James Land, consisting of an intricate network of craggy ridges with glaciers between. A deep north-and-south depression is occupied by Wijde and Dickson bays, the one opening on the north coast, the other a head-branch of the great Ice Fjord of the west coast, bordered on the west by a range of fine mountains, a spur of which separates the two bays. East of this depression there is a plateau region. Its edge is eaten away into deep valleys, down which the ice-sheet of New Friesland sends glacier tongues into Wijde Bay. East of Dickson Bay the marginal valleys are larger, and no glaciers come far down them. The plateau between Dickson and Klaas Billen bays is cut up by deep valleys such as the Rendal, Skansdal and Mimesdal (all well known to geologists); it contains no large glaciers. Farther east is found a glaciated area called Garwood Land by Sir Martin Conway. The neck of West Spitsbergen is bounded on the north by a line from near the head of Klaas Billen Bay to Wiche Bay, and on the south by the Sassendal and the depression leading to Agardh Bay. It is a complicated area of fine craggy ridges with beautiful glaciers between. Adventure Land lies south of the neck, and is bounded on the south by a line from the head of Van Keulen Bay to Whales Bay. It is an area of boggy valleys, rounded hills, and small glaciers,

and may be described as the temperate and fertile belt, and is the only part of the island where reindeer still linger in any number. Near the west coast it contains some fine peaks and large glaciers. It is penetrated by the longest green valleys in Spitsbergen, e.g. from Coles Bay, Advent Bay and Low Sound (the valley of the Shallow river). The southern division of the island is very icy. There is a high snowfield along its east side, and ranges of peaks farther west. Two parallel ranges form the backbone of the island south of Horn Sound, the higher of them containing the famous Horn Sund Tind (4560 ft.). The long narrow island, Prince Charles Foreland, with lofty peaks, runs parallel to part of the west coast of West Spitsbergen, from which it is separated by a narrow strait. Its range of mountains is interrupted towards the southern end of the island by a flat plain of 50 sq. m. raised only a few feet above sea-level. There is a narrower depression a few miles farther north. The broad Stor (Great) Fjord, of Wybe Jans Water, separates the main island from two others to the east—Edge Island (2500 sq. m.) and Barents Land (580 sq. m.). Formerly these were considered as one, until the narrow Freeman Strait which parts them was discovered. Neither Barents Land nor Edge Island carries ice-sheets, and both are practically devoid of glaciers down their western coasts, but have large glaciers reaching the sea on the east. To the north-east of West Spitsbergen, separated from it by Hinlopen Strait (7 to 60 m. in breadth) lies North-East Land, with an area of about 6,200 sq. m. Its western and northern coasts are indented by several bays and fjords. It is covered with a true ice-sheet, while the neighbouring Wiche Islands to the south-east bear no large glaciers at all. East by north from Cape Leigh Smith, the easternmost promontory of North-East Land, rises White Island, covered with snow and ice, and rising to about 700 ft. It was discovered by Cornelis Giles or Gillis in 1707, and is alternatively named Giles Land. Numerous small islands lie around the larger: Danes and other islands off the north-west coast of West Spitsbergen, the Seven Islands, Outer Reps, Broch, and Charles XII. Island on the north of North-East Land; Hinlopen Strait contains numerous islets, and the Ryk Yse Archipelago, Hope or Walrus Island, and the Thousand Islands (about a hundred small rocks) lie to the east and south of Edge Island.

The nomenclature is in a state of hopeless confusion, the names given by the old explorers having been carelessly transferred from point to point, or capriciously set aside. The true names, English and Dutch, of the principal misnamed sites are here indicated in brackets after the current names: South Cape (Point Look-out), Torrel's Glacier (Slaadberg), Recherche Bay (Joseph's Bay, Schoonhoven), Van Keulen Bay (Lord Ellesmere Sound, Sardammer Rivier), Van Mayen Bay (Low Sound, Klok Rivier), Coal Bay (Coles Bay), Advent Bay (Adventure Bay), St John's Bay (Osborn's Inlet), English Bay (Cove Comfortesse), Foreland Sound (Sir Thomas Smith Bay, Keerwyk), Cross Bay (Close Cove), the bay called Smeerenburg (Fair Haven, Dutch Bay), Flat Hook (Fox Point), Biscayers' Hook (Point Welcome), Redbeach (Broad Bay), Leifde Bay (Wiche Sound), Grey Hook (Castlin's Point), Wijde Bay (Sir Thomas Smith Inlet), Verlegen Hook (Point Desire), Treurenberg Bay (Bear Bay), Agardh Bay (Foul Sound), Stor Fjord (Wybe Jans Water), North-East Land (Sir Thomas Smith Island), North Cape (Point Purchas). Stans Foreland is not, as often appears, an alternative name of Edge Island, but the name of its south-eastern cape only.

Geology.—The backbone of the main island consists of an ancient mass of pre-Devonian granites, gneisses and schists forming a mountain chain in the western region. Resting upon these ancient crystalline rocks, the precise age of which has not been definitely determined, there is a succession of sedimentary rocks representing nearly every one of the prominent periods of geological time. For the eastern part of the group these strata lie nearly horizontal; here and there they are pierced by intrusive igneous rocks. The oldest sediments yet found are the Ordovician beds which occur at Hekla Hook, dolomites, limestones, slates and quartzites; Silurian rocks may possibly exist in the north-west; and Devonian grits with *Pteraspis* have been recorded in Liefde Bay. The Carboniferous period is represented by Culm-like rocks (classed by O. Heer as

Ursien—Upper Devonian); upon these come limestones with *Spirifer Mosquensis* (Hinlopen Straits) and above these again are limestones with *Cyathophyllum* and *Fusulina*; (Eisfjord, Bell Sound, Horn Sound, &c.). Permo-Carboniferous limestones and dolomites occur on the west on the mainland and on Prince Charles Foreland and in King James Land. Black slaty shales with large ammonites in the Calcareous nodules and beds of black, bituminous limestone represent the Trias at Cape Thorodsen; and Rhaetic fossils are found in Research Bay, Bell Sound. Jurassic rocks are widely spread and include Bajocian, Bathonian, Callovian, Oxfordian and Portlandian (Cape Starashchin and Advent Bay); the older stages being in the west. Some of these rocks are coal-bearing. Wealden strata with coal seams and marine beds (Volgian) occur in the south, and in King Charles Land are Neocomian rocks with interbedded basalts. Plant-bearing lower Cretaceous strata have been recorded, and lower Eocene beds are found in Ice Fjord, Bell Sound containing large magnolia leaves and others; beds of London Clay age occur in Kol-bay. Miocene Sandstones and clay with lignite beds, some 2800 ft. thick, occupy the west coast about Ice Fjord, Bell Sound, Advent Bay, &c. In this period these islands were probably all united and covered a much greater area and were covered with extensive peat bogs, on the edges of which the marsh cypress flowered, dropping its leaves and blossoms into the marshes. *Sequoia*, poplars, birches, planes and large oaks also grew there, while ivy and thick underwood freely developed under their shadow, and thousands of insects swarmed in the thicket. Subsidence followed in late Tertiary times, to be succeeded by a period of rapid elevation giving origin to the raised beaches such as those seen on Prince Charles Foreland, and possibly resubmergence may be again in progress. In comparatively recent geological times this, the main island, was over most of its area a high plateau covered with an ice-sheet, which has gradually been withdrawn from the west towards the east, the western region being thus cut up into deep valleys and more or less rugged mountains. Farther east the mountains are more rounded, but still farther east the plateau character of the land remains.

Climate.—The sea around Spitsbergen is shallow, and the ice readily accumulates round the shores. Although the glaciers of Spitsbergen do not give origin to icebergs so huge as those of Greenland, the smaller bergs and the pack-ice are thick enough to prevent access to the shores except for a few months in the year. However, the warm drift from the Atlantic sends a branch to the western shores of Spitsbergen, moderating its climate, and leaving an open passage which permits vessels to approach the western coast even under the most unfavourable conditions of ice in the arctic regions. Drift-wood from lower latitudes, glass floats of the Norwegian fishermen and other objects have been found at the northern extremity of Spitsbergen. On the other hand a cold current charged with ice descends from higher latitudes along the eastern coasts, rendering approach extremely difficult. On this account these shores long remained practically unknown.

Owing to the warm drift the climate of Spitsbergen is less severe than in the corresponding latitudes of Greenland and Smith Sound. Bear Island, notwithstanding its more southerly position, has a lower temperature. The isotherm of 23° F., which crosses the middle of Eastern Siberia, touches its southern extremity, and only the north-east coasts of Spitsbergen have an average yearly temperature so low as 14° to 10.5°. At Mussel Bay (79° 53') the average yearly temperature is 16° (January 14.1°, July 39.3°). Even in the coldest months of the winter a thaw may set in for a few days; but, on the other hand, snow sometimes falls in July and August. Spring comes in June; the snow becomes saturated with water and disappears in places, and scurvy grass and the polar willow open their buds. By the end of June the thermometer has ceased to sink below the freezing-point at night; July, August and September are the best months. In September, however, autumn sets in on shore, and by the end of the month the pack-ice rapidly freezes into one solid mass. In Treurenberg Bay an annual precipitation of 64 in. has been observed.

Fauna and Flora.—The Greenland whale has completely disappeared in consequence of the great havoc made by the early whalers. According to Scoresby, no less than 57,590 whales were killed between 1669 and 1775. A great diminution, in the same way, is to be observed in the numbers of other creatures which were the object of hunters. A reckless extermination of seals was carried on. Walrus are now only occasionally seen in the waters of West Spitsbergen. Birds, also, have rapidly diminished in numbers. The fulmar petrel meets ships approaching Spitsbergen far away from the coasts. It makes colonies on the cliffs, as also do the glaucous gull and the "burgomaster." Rotches, black guillemots, ivory gulls, auks and kittiwake gulls breed on the cliffs, while geese, loons and snipe frequent the lagoons and small fresh-water ponds. The eider duck breeds on the islands, but its numbers have become noticeably reduced, while the lumme and the tern confine themselves to separate cliffs. These birds, however, are only guests in Spitsbergen, the snow-bunting being the only species which stays permanently; some twenty-three species breed regularly on Spitsbergen, and four others (the falcon, snowy owl, swan and skua) come occasionally. Of land mammals, besides the polar bear, the reindeer and arctic fox have been greatly reduced; the reindeer, in fact, are approaching extinction, whereas for several years consecutively

before 1868 from 1500 to 2000 were killed by hunters in a few weeks of summer.

There are twenty-three species of fishes, but no reptiles. Insects are few. Arachnids, and especially Pantopods, on the other hand, are very common. Molluscs are also numerous. At some places the mussels and univalves reach a large size and appear in great abundance. Of Crustaceans fully 100 species have been recognized in the waters of the archipelago.

The flora is, of course, poor. The only tree is the polar willow, which does not exceed 2 in. in height and bears a few leaves not larger than a man's finger-nail; and the only bushes are the crowberry and cloudberry. But at the foot of the warmer cliffs some loam has been formed notwithstanding the slowness of putrefaction, and there, in contrast with the brownish lichens that cover the hills, grows a carpet of mosses of the brightest green, variegated with the golden-yellow flowers of the ranunculus, the large-leaved scurvy grass, several saxifrages, fox-tail grass, &c., with a few large flowers, *Polygona* and *Andromeda*; while on the driest spots yellow poppies, whitlow grasses, &c., are found. Even on the higher slopes, 1500 ft. above the sea, the poppy is occasionally met with. In all over 130 species of flowering plants have been found. Mosses, mostly European acquaintances, cover all places where peat has accumulated. The slopes of the crags and the blocks of stone on the beach are sometimes entirely covered with a luxuriant moss and lichen vegetation, among the last being the so-called "famine bread" (*Umbilicaria arctica*), which has maintained the life of many arctic travellers. Although limited in number, the flora is suggestive in its distribution. The vegetation of the south has a decidedly Lappish or European alpine character, while that of the north coast is decidedly American, and recalls that of Melville Island. Many flowering plants which are common in north-west Spitsbergen are absent from the east coast, where the cold climate is inimical to both flora and fauna; but, on the other hand, one moss (*Pottia hyperborea*) and one lichen (*Usnea melaxantha*) are found there which are of American origin and grow both in North America and on the Cordilleras. Algae are most numerous, many, like the brown *Laminaria* and *Nostoc communis*, which fill all pools and are the chief food of many birds, being familiar in Europe. *Protococcus nivalis* covers the snow with its reddish powder.

History.—Spitsbergen has never been permanently inhabited, although there are several instances of hunters wintering on the island under stress of circumstances, and several scientific expeditions have done so. A Russian trapper named Starashchin is said in various accounts to have spent 32 or 39 winters, and 15 consecutive years, in the archipelago; he died there in 1826. Spitsbergen was discovered on the 17th of June 1596, during the expedition under William Barents and Jacob Heemskerck, which ended with the death of Barents. Barents saw parts of the west and north coasts, and to these he gave the name of Spitsbergen. In 1607 Henry Hudson, after visiting the coast of Greenland, reached Spitsbergen in June. Bear Island, the ice-bound island midway between Spitsbergen and the North Cape, situated on the same submarine platform as the former, had been discovered by Barents, and became important as a hunting-ground (for walrus, &c.) before Spitsbergen began to be visited for this purpose. In 1609 Thomas Marmaduke of the "Heartsease," proceeding north from Bear Island, reached Spitsbergen, and in the following year the first hunting expedition was despatched thither by the Muscovy Company on board the "Amitie" of London, Jonas Poole, master, on whose report of the abundance of whales on the coast the Spitsbergen whaling industry, which was to grow to such importance, was established in 1611. Very shortly the Dutch began to take a share in this, and there were frequent collisions between the whalers of the two nationalities, while in 1615 the Danes attempted to claim this part of "Greenland," as Spitsbergen was for a long time considered. England attempted to annex the archipelago, but at length the Dutch became predominant in the whaling industry, and in 1623 founded the summer settlement of Smeerenburg. This became a busy and important centre, but began to decline in about twenty years, as the whales were gradually driven from the bays and must be followed, at first northward along the coast, and later into the open sea. Independently of the English and Dutch, Russians from the White Sea district came to Spitsbergen to hunt walruses, seals, bears, foxes, &c. At what early period they first did so cannot be known, but the industry seems to have gained a certain importance before 1740. The Russians had their own nomenclature for various parts of the archipelago, the

whole of which they also called Grumant, a corruption of Greenland. A similar hunting industry was established by Norwegians early in the 18th century, but Spitsbergen declined in importance as a hunting-ground owing to the indiscriminate slaughter of game.

Many expeditions have made Spitsbergen their base for polar exploration. The Russian admiral Chichagov visited it twice, in 1765 and 1766, and reached 80° 28' N. The expedition sent from England in 1773 at the instigation of Daines Barrington under the command of Constantine John Phipps, was the first having a purely geographical purpose. It consisted of two vessels, the "Racehorse" and the "Carcass," on the first of which Horatio Nelson was a midshipman. Phipps mapped the north of Spitsbergen, and reached 80° 48' north. In 1818 David Buchan and John Franklin reached 80° 34' to the north of the archipelago. Captain D. C. Clavering and Sir Edward Sabine in 1823 explored the islands, and Sabine made his remarkable magnetic observations, while Clavering reached 80° 20' N. Sir William Parry, shortly after his return from his third voyage, went to Spitsbergen and reached 82° 40' north on sledges, while other members of the expedition were occupied with scientific work in the archipelago. In the same year the Norwegian geologist Balthasar Mathias Keilhau visited the group and related his experiences in a remarkable book, *Resa i Ost og West Finmarken* (Christiania, 1831). The Swedish professor Sven Loven was the first to undertake, in 1837, dredging and geological explorations in Spitsbergen and its vicinity. Next year a body of French, Swedish, Danish, and Norwegian naturalists, among whom was Charles Martins, visited the western coast. In 1858, at the suggestion of Loven, Otto Torell, accompanied by A. E. Nordenskiöld and A. Quennerstadt made many important observations and brought home rich geological collections. In 1861 a larger expedition led by Torell, Nordenskiöld, A. J. Malmgren, and Karl Chydenius, set out with the object of finding how far it was possible to obtain a measurement of an arc of meridian of sufficient extent. This aim was only partly accomplished, but the expedition returned with an invaluable store of various observations. The work of the measurement of the arc was completed in 1864 by another expedition conducted by Nordenskiöld, assisted by Malmgren and N. Dunér. This expedition was followed in 1868 by that of the "Sofia," under Nordenskiöld, which, in the words of Oswald Heer, "achieved more and gave a wider extension to the horizon of our knowledge than if it had returned merely with the information that the 'Sofia' had hoisted her flag on the North Pole." In the same year the German arctic expedition under Karl Koldewey circumnavigated West Spitsbergen. In 1870 two young Swedish savants, Drs Nathorst and Wilander, visited Spitsbergen in order to examine the phosphoric deposits, and two years later a colony was formed in Ice Fjord, and a small tramway constructed to work the beds. The attempt, however, did not prove successful. Leigh Smith and the Norwegian Captain Ulve visited and mapped parts of East Spitsbergen in 1871, returning with valuable information. They reached 81° 24' north. In the same year the first tourist steamer visited the archipelago. In 1872 a great polar expedition under Nordenskiöld set out to winter on Spitsbergen with the intention of attempting in the spring to advance towards the pole on sledges drawn by reindeer. But the expedition encountered a series of misfortunes. The ships were beset in the ice very early in Mussel Bay, and, six Norwegian fishing vessels having been likewise overtaken and shut in, the expedition had to feed the crews on its provisions and thus to reduce the rations of its own men. The reindeer all made their escape during a snow-storm; and when the sledge party reached the Seven Islands they found the ice so packed that all idea of going north had to be abandoned. Instead of this, Nordenskiöld explored North-East Land and crossed the vast ice-sheet which covers it. The expedition returned in 1873 with a fresh store of important scientific observations, especially in physics and submarine zoology. In 1873 R. von Drasche-Wartinberg, the geologist, paid a short visit to Spitsbergen,

In 1882 the Swedish geologists, A. G. Nathorst and G. de Geer made a journey which furnished interesting data about the geology and flora of the islands. In the same year a Swedish meteorological station was established at Cape Thorsen for carrying on the observations desired by the international polar committee. During the last decade of the 19th century Spitsbergen attracted not only a number of scientists but also sportsmen and tourists. Such expeditions as those of Gustaf Nordenkiöld in 1890 and the important circumnavigation by Nathorst in 1898, during which the Wiche Islands and White Islands were carefully explored, confined their attentions almost entirely to the coasts. In 1892 M. C. Rabot made the first serious attempt to penetrate the interior from the head of Ice Fjord, exploring a part of the Sassendal; and in 1896 Sir Martin Conway led an expedition which crossed the island for the first time, and surveyed the region between Ice Fjord and Bell Sound on the east coast. In 1897 Conway and Mr E. J. Garwood surveyed the glaciated area north of Ice Fjord to about 78° 10' N., and climbed Horn Sund Tind. In the same year Herr André made his fatal balloon ascent from Danes Island with the intention of floating over the Pole. In 1896 a weekly service of Norwegian tourist steamers was established in summer, and a small inn was built at Advent Bay in Ice Fjord, and though this was afterwards closed, the west coast continued to be frequently visited by tourist steamers during the height of summer. In 1898, 1899 and 1906 the prince of Monaco made scientific investigations in the Archipelago, and in 1898-1902 Swedish and Russian expeditions undertook the measurement of an arc of the meridian, the results of which were accompanied by valuable physiographical, meteorological, botanical and other observations. Dr W. S. Bruce made a complete survey and scientific investigations of Prince Charles Foreland. In 1900 coal began to be worked on Advent Bay, a seam 10 ft. thick being found below 40 ft. of fossil ice and 20 ft. of rock. This development and other considerations led to some discussion between the powers interested as to the territorial sovereignty over the archipelago, a question which though approached before (as in 1870) had never been brought to a settlement.

BIBLIOGRAPHY.—On a land visited by so many scientific observers the literature is naturally voluminous. The chief source of scientific papers is the publications of the Swedish *Vetenskaps Akademi*. Sir W. Martin Conway narrates his expedition in the *First Crossing of Spitsbergen* (London, 1897); and in *No Man's Land* (Cambridge, 1906) he details the history of the Archipelago down to 1840, tabulates the principal voyages and incidents thereafter until 1900, and furnishes a very full bibliography for the history and geography of Spitsbergen from the earliest time down to 1902. The various observations of the Swedish expedition for the measurement of an arc of the meridian were brought together (in French) in *Missions scientifiques pour la mesure d'un arc de méridien au Spitzberg* . . . (Stockholm, 1903-1906), and those of the Russian expedition under the same title in 1904, seq. (St. Petersburg).

SPITTA, FRIEDRICH (1852-), German Protestant theologian, was born at Wittingen on the 10th of January 1852. His father, Karl Johann Philipp (1801-1859), well known as a hymn-writer (see *Lyra domestica*, 1st series, London, 1860; 2nd series, 1864), was superintendent at Burgdorf near Hanover. Friedrich studied at Göttingen and Erlangen, and in course of time became (1887) professor ordinarius and university preacher at Strassburg. In 1896 he became joint-editor with J. Smend of the *Monatschrift für Gottesdienst und kirchliche Kunst*, and he is widely known as the author of a work on the Acts of the Apostles (*Die Apostelgeschichte, ihre Quellen und deren geschichtlicher Wert* (1891).

His other works include: *Der Knabe Jesus, eine biblische Geschichte und ihre apokryphischen Entstellungen* (1883), *Die Offenbarung des Johannes* (1889), *Zur Reform des evang. Kultus* (1891), and *Zur Geschichte und Litteratur des Urchristentums* (3 vols., 1893-1901).

SPLEEN (Gr. σπλήν), a vascular organ situated on the left side of the abdomen (see DUCTLESS GLANDS). It was supposed in olden times to be the seat of ill-humour and melancholy, whence such phrases as "to have the spleen," to be out of temper, sulky, morose, "splenic."

SPLÜGEN PASS, one of the passes across the main chain of the Alps from Switzerland to Italy (from 1512 to 1797, however,

Chiavenna belonged to the Grisons). The route quits that of the Albula Pass (*q.v.*) at Thusis, passes first through the celebrated gorge of the Via Mala, then through the Schams basin and past Andeer, beyond which the Rofna gorge gives access to the village of Splügen (from which the pass takes its name) in the upper reach of the main or Hinter branch of the Rhine (*q.v.*). Leaving to the west the road over the San Bernardino Pass, 6769 ft. (by which the St Gotthard railway line is joined at Biasca, the route lying entirely through Swiss territory) the Splügen road (constructed in 1823) mounts south to the pass (6946 ft.), which forms the political frontier. On the other side the road avoids the old path through the dreaded Cardinello gorge (here passed Macdonald's army in December, 1800) in order to descend by zigzags to Pianazzo. Thence past Campo Dolcino and Gallivaggio the descent is made to the ancient town of Chiavenna at the junction of the road from the upper Engadine over the Maloja Pass, and 17 m. by rail above Colico, at the northern end of the lake of Como. The distance by road from Splügen village (16 m. above Andeer) to Chiavenna is 25 m. The diligences take 5½ hours from Splügen village (4 hours above Thusis) to Chiavenna. But by the proposal to pierce a railway tunnel of about 16 m. in length from Andeer to Gallivaggio, it was calculated that the Splügen line would become the shortest route from southern Germany to Milan, while at Chiavenna it would receive the traffic from the upper Engadine. (W. A. B. C.)

SPODUMENE, a lithium-aluminium silicate belonging to the pyroxene group (see PYROXENE). It was named by B. J. d'Andrada e Sylva, in 1800, from Gr. σπόδιος (ash-coloured), in allusion to its grey colour. Soon afterwards J. R. Haüy termed it *triphane*, because it exhibited certain characteristics equally in three directions (*τριφανής*, appearing three-fold). Spodumene crystallizes in the monoclinic system, the crystals having generally a prismatic habit and being often striated longitudinally. It has perfect prismatic cleavage, and imperfect cleavage parallel to the clinopinacoid, whilst a lamellar structure may be developed by parting along the orthopinacoid. The hardness is 6.5 to 7, and the specific gravity about 3.16. Though generally a dull mineral, some varieties of spodumene are so brightly coloured and transparent as to be valued as gem-stones. Such is the emerald-green hiddenite (*q.v.*) and the lilac-coloured kunzite (*q.v.*), whilst a yellow or yellowish-green spodumene found as pebbles in the state of Minas Geraes, in Brazil, resembles, when cut, some kinds of chrysoberyl. Common spodumene is used as a source of lithium in chemical preparations.

Spodumene occurs in granite and crystalline schists. The original specimens came from the isle of Utö in Södermanland, Sweden, but the finest examples are found in the United States, especially in Massachusetts, where Goshen, Sterling and Chesterfield are well-known localities. Very fine specimens have been obtained from the Black Hills of S. Dakota. Some remarkable deposits containing spodumene were discovered many years ago at Branchville, Fairfield county, Connecticut, and the minerals which they yielded were exhaustively studied by Professor G. J. Brush and E. S. Dana. The spodumene occurred in large quantity, in a vein of albite-granite, associated with apatite, garnet, columbite, pitchblende and other uranium minerals, together with several species of manganese phosphates, termed eosphorite, triploidite, dickinsonite, lithiophilite, natrophilite, reddingite, fairfieldite and fillowite. The spodumene, which has normally the formula LiAl(SiO₃)₂, becomes altered at Branchville to what has been called β-spodumene, which consists really of the mineral eucryptite (LiAlSiO₄) and albite. Eucryptite was named by Brush and Dana from εὖ (well) and κρυπτός (concealed). Further alteration results in the formation of cymatolite, a mineral described by C. U. Shepard in 1867, but shown to be an intimate mechanical mixture of muscovite and albite. The final products of alteration of the spodumene may be muscovite, albite and microcline. The mineral discovered in 1817 in the granite of Killiney Hill, near Dublin, and described by T. Thomson as killinite, appears to be an altered spodumene. (F. W. R. *)

SPOHR, LUDWIG (1784–1859), German composer and violinist, was born at Brunswick on the 25th of April 1784. He spent his childhood at Seesen, where in 1789 he began to study the violin, and at six years old was able to take part in chamber-music. He had a few lessons in composition, but, as he himself tells us, he learnt more from studying the scores of Mozart. After playing a concerto of his own at a school concert with marked success, he was placed under Maucourt, the leader of the duke's band; and in 1798 he started on an artistic tour. This proved a failure; but on his return to Brunswick the duke gave him an appointment in his band, and provided for his future education under Franz Eck, with whom he visited St Petersburg and other European capitals. His first violin concerto was printed in 1803. In that year Spohr returned to Brunswick and resumed his place in the duke's band. A visit to Paris was prevented by the loss of his favourite violin—a magnificent Guarnerius, presented to him in Russia. After a series of concerts in Berlin, Leipzig, Dresden, and other German towns, his reputation gained for him in 1805 the appointment of leading violinist to the duke of Gotha. Soon after this he married his first wife, Dorette Scheidler, a celebrated harpist. At Gotha he composed his first opera, *Die Prüfung*, but did not succeed in producing it. *Alruna* was equally unfortunate, though Goethe approved of it at a trial rehearsal at Weimar in 1808. In this year Spohr, hearing that Talma was performing at Erfurt before Napoleon's Congress of Princes, and failing to obtain admission to the theatre, bribed a horn-player to send him as his deputy; and, though he had never touched a horn in his life, he learned in a single day to play it well enough to pass muster in the evening and so to get a good view of Napoleon and the princes in a pocket mirror on his desk. Spohr's third opera, *Der Zweikampf mit der Geliebten*, written in 1809, was successfully performed at Hamburg next year. In 1811 he produced his (first) *Symphony in E flat*, and in 1812 composed his first oratorio, *Das jüngste Gericht*.¹ In writing this work he felt hampered by lack of skill in counterpoint; so with characteristic diligence he mastered the contents of Marpurge's *Abhandlung von der Fuge*.

In 1812 Spohr visited Vienna, and was induced to accept the leadership of the orchestra at the Theater an der Wien. He then began his dramatic masterpiece, *Faust*, which he completed in 1813, though it was not performed until five years later. His strength and inventiveness as a composer were now fully developed, and enabled him to produce large works with astonishing rapidity. He resigned his appointment at Vienna in 1815, and soon afterwards made a tour in Italy, where he performed his eighth and finest violin concerto, the *Scena cantante nello stilo drammatico*. The leading Italian critics called him "the finest singer on the violin that had ever been heard." On Spohr's return to Germany in 1817 he was appointed conductor of the opera at Frankfurt; and there in 1818 he first produced his *Faust*. It was followed by *Zemire und Azor*, which, though by no means as fine as *Faust*, soon attained a much greater popularity. *Faust* suffered from its libretto, which is on quite a different plot from Goethe's poem.

Spohr first visited England in 1820, and on the 6th of March played his *Scena cantante* with great success in London at the first Philharmonic concert. At the third he produced a new symphony (*No. 2 in D minor*) and, instead of having it led by the first violinist and a *maestro al cembalo*, conducted it himself with a bâton; a great innovation in London at the time. Spohr had a triumphant success both as composer and as virtuoso; and he on his side was delighted with the Philharmonic orchestra. At his farewell concert in London Mme Spohr played on the harp for the last time. The constrained attitudes of harp-playing were bad for her health; so in later concerts she played the pianoforte in duets with violin which her husband produced with his usual prompt facility. After a transitory visit to Paris, Spohr returned to Germany and settled for a time in Dresden, where German and Italian opera were flourishing side by side under the direction of Weber and Morlacchi. Spohr could

¹ Not to be confused with *The Last Judgment*.

not appreciate Weber's genius; nevertheless Weber recommended him strongly to the elector of Hesse Cassel as Kapellmeister. Spohr entered upon his duties at Cassel on the 1st of January 1822, and soon afterwards began his sixth opera, *Jessonda*, which he produced in 1823. This work—which he himself regarded as one of his best—marks an important epoch in his operatic career. It was his first opera on Gluck's lines, *i.e.* with accompanied recitative throughout in place of secco-recitative or spoken dialogue; and it was produced in the same year as Weber's *Euryanthe*, a work marked by the same departure from German custom.

Spohr's resources at Cassel enabled him to produce his new works on a grander scale and with more perfect detail than he could have attained in a less well-endowed post; and he never failed to use these privileges to the advantage of other meritorious composers, though as a critic he was very difficult to please. Soon after his instalment Mendelssohn, then a boy of thirteen, visited Cassel; notwithstanding the disparity of their years, a firm friendship sprang up between the two, which ceased only with Mendelssohn's death in 1847. Spohr's next three operas, *Der Berggeist* (1825), *Pietro von Abano* (1827) and *Der Alchymist* (1830), attained only fair temporary success. But at the Rhenish musical festival held at Düsseldorf in 1826, his oratorio *Die letzten Dinge* met with so enthusiastic a reception that it was repeated a few days later in aid of the Greek Insurgents, and became the most famous of his sacred compositions. It is known in English as *The Last Judgment*. In 1831 Spohr summed up another aspect of his career by publishing his *Violin School*, an admirable book for advanced students, which stands to the violin much as the combination of Cramer's *Studies* with Clementi's *Gradus* stands to the pianoforte. The year 1834 was saddened by the death of Spohr's wife. In 1836 he married again. During 1833 he had been working at an oratorio—*Des Heilands letzte Stunden*, known in English as *Calvary* or *The Crucifixion*—which was performed at Cassel on Good Friday 1835, and sung in English at the Norwich Festival of 1839 under Spohr's own direction, with an effect which he afterwards always spoke of as the greatest triumph of his life. For the Norwich Festival of 1842 he composed *The Fall of Babylon*, which also was a perfect success, though the elector of Hesse-Cassel, unmoved by a petition from England almost amounting to a diplomatic representation, refused Spohr leave of absence to conduct it. His last opera, *Die Kreuzfahrer*, was produced at Cassel in 1845. Of his nine symphonies the finest, *Die Weihe der Töne*, was produced in 1832. His compositions for the violin include concertos, quartets, duets, and other concerted pieces and solos, and among these a high place is taken by four double quartets, (*i.e.* octets for two antiphonal string-quartet groups), an art-form of his own invention. He was, indeed, keenly interested in experiments, notwithstanding his attachment to classical form; and the care with which he produced Wagner's *Fliegender Holländer* and *Tannhäuser* at Cassel in 1842 and 1853, in spite of the elector's opposition, shows that his failure to understand Beethoven lay deeper than pedantry. Spohr retained his appointment until 1857, when, very much against his wish, he was pensioned off. In the same year he broke his arm, but he was able to conduct *Jessonda* at Prague in 1858. This, however, was his last effort. He died at Cassel on the 16th of October 1859.

Spohr's *Selbstbiographie* is a delightful document, revealing a character the generosity of which was conspicuous through all its complacent intellectual foibles. He was a born taste-maker, for he mastered the technique of his art safely and then applied his mastery to the expression of exactly those modes of thought which surprise no one who believes that each art-problem has one answer and that the critics know it. But he had a very genuine melodic invention, and his sense of beauty was such as even the all-pervading mannerisms of his otiose chromatic style could not quite destroy. He tried every experiment the copy-book optimism of his age could suggest; the subjects of his operas are all that is romantic and necromantic; he wrote almost as much "programme-music" as Berlioz; he invented

"double quartets," he wrote an *Historical Symphony* tracing the progress of music from Bach to his own day; and, lastly, his gift for orchestration was quite exceptional. Yet not one of his experiments shows any essential connexion between the new form and the old material which he has so skilfully packed into it. Nor is his treatment of his beloved classical forms any nearer to organic life. In conversation with Joachim he once in his last years expressed the ambition to write a set of string quartets "in the strict form with all the passages ending properly with shakes." This shows that all his work as a composer had failed to wean him from the conventions of virtuoso players, and it well illustrates the way in which "strict forms" desert their convenient functions to pose as classical ideas; for the "passage ending in a shake" is merely the easiest known way of finishing a section in concerto style, and is so far from being an essential feature in chamber-music that in the ten mature quartets of Mozart which Spohr undoubtedly regarded as his models it cannot be traced in more than twelve of the thirty-one movements in which it ought to occur.

The steady level of Spohr's mastery prevents any of his work from either rising to the height of Mendelssohn's masterpieces, or sinking to the weakness of Mendelssohn's failures. But where the true conditions of an art-form suit Spohr's training and temperament he is, at times, very nearly a great composer; and in the severely restricted medium of duets for two violins his work is an artistic *tour de force*, the neglect of which would be unfortunate in a wider field than that of mere violin-technique. His best work is not so great that we are obliged to live with it; but its merits demand that we should let it live.

(D. F. T.)

SPOIL-FIVE, an old game of cards, probably imported from Ireland, where it is still very popular, though the original name, according to *The Compleat Gamester*, was "Five-cards." It may probably be identified with "Maw," a game of which James I. of England was very fond. A full pack of cards is used: about five players is the best number, each receiving five cards, dealt in pairs and triplets, the card that is left at the top of the pack being turned up for trumps. If the turn-up is an ace, the dealer must "rob," i.e. put out, face downwards, any card from his hand and take in the ace. The trump suit remains unaltered. "Robbing" must take place before the first player, the player on the dealer's left, leads. Similarly a player who *holds* the ace of trumps must rob, putting out any card and taking in the turn-up, but need not disclose the fact till it is his turn to play. A player who fails to rob cannot go out that hand. The card put out may not be seen. The player on the dealer's left leads. The highest card of the suit led—the value of the cards will be explained—or the highest trump, wins the trick. Players must follow suit to a lead of trumps, except in certain cases which will be mentioned. To a plain suit no one need follow except a player who holds no trumps; others may follow or trump as they please. If a player takes three tricks he wins the game. If no one succeeds there is a "spoil," and a fresh stake, smaller than the original one as a rule, is put into the pool for the next round. The order of the cards in plain suits may be remembered by "after the knave the highest in red and the lowest in black." In red suits the order is king, queen, knave, ten, &c., down to the ace, which is lowest: in black suits king, queen, knave, ace, &c., up to ten, which is lowest. But the ace of hearts, which is always a trump, is not reckoned in its own suit. In trumps the order is "below the queen highest in red, lowest in black." The order in red suits is five, knave, ace, of hearts, ace of trumps, king, queen, ten, &c.: in black suits five, knave, ace of hearts, ace of trumps, king, queen, two, three, &c., up to ten, which is the lowest. When trumps are led, the five and the knave of trumps and the ace of hearts need not be played. This is called "renegeing," colloquially "renigging." The five may always renege: if it is led, no card can renege. The knave may renege if the five is played, not led. Only the five can renege to the knave led. The ace of hearts can renege to any inferior card. If hearts are not trumps and the ace of hearts is led, a trump must be

played if possible: if not, it is not necessary to play a heart. "Twenty-five" and "Forty-five" are varieties of "Spoil-five": the game is played for either of these numbers; each trick counts five to the maker, and there is no "spoil," but the trick made by the highest trump out scores ten; if a player gets out before that trump is played, he wins the game all the same. The winning of all five tricks is called a "jink"; at "Spoil-five" a player who jinks, if jinking is agreed upon, receives an extra stake all round; but if, after winning three tricks, he elects to "jink" and fails, he cannot score during that hand.

SPOKANE, a city and the county-seat of Spokane county, Washington, U.S.A., on both banks of the Spokane river, near the eastern boundary of the state, and about 242 m. E. of Seattle. Pop. (1890), 19,922; (1900), 36,848, of whom 7833 were foreign-born, including 1683 English Canadians, 1326 Germans, and 1168 Swedes; (1910 census) 104,402. Spokane is served by the Great Northern, the Oregon Railway & Navigation Co. (Union Pacific system), the Northern Pacific, the Idaho & Washington Northern, the Spokane, Portland & Seattle, and the Spokane & International railways, and by the Spokane & Inland Empire (electric) line connecting with the Cœur d'Alène mining region, Idaho, and with Colfax, Washington and Moscow, Idaho. Among the principal buildings of the city are the Federal building, the county court-house, the city-hall, the post office, the Paulsen building, the Columbia and Auditorium theatres, the Spokane club, the masonic temple, the Spokesman-Review building, and a large Roman Catholic church. Spokane is the see of a Protestant Episcopal bishop. The city has a Carnegie library, and ten public parks aggregating 320 acres; the more important are Liberty Park (25 acres), Manito Park (85 acres), and Corbin Park (13 acres). Fort George Wright (established in 1895) is 3 m. west of Spokane on a tract of 1022 acres given to the United States Government by the city, for that purpose, in 1894-1895. Spokane is the seat of Gonzaga College (Roman Catholic) for boys, founded in 1887 and incorporated in 1904; of Spokane College (1907; Lutheran); of Brunot Hall (Protestant Episcopal), for girls; the Academy of the Holy Names (Roman Catholic), for girls; and of other schools and academies. Among the city's charitable institutions are a home for the friendless (1890), the St Joseph orphanage (1890), St Luke's (1900) and the Marie Beard Deaconess (1896) hospitals, each having a training school for nurses, a Florence Crittenden home, and a House of the Good Shepherd. The Spokane river is a rapidly flowing stream with two falls (the upper of 60 and the lower of 70 ft.), within the city limits, providing an estimated energy of about 35,000 horse-power at low water. Of this energy, in 1908, about 17,000 horse-power was being utilized, chiefly for generating electricity (the motive power most used in the city's industries), as well as for lighting and transit purposes, while about 9000 horse-power in electrical power was transmitted to the Cœur d'Alène mines. At Post Falls, Idaho, 22 m. east of Spokane, about 12,000 horse-power is developed, and at Nine Mile Bridge near Spokane, about 20,000 horse-power. Spokane's manufacturing interests have developed with remarkable rapidity. In 1900 there were 84 factories capitalized at \$2,211,304, and their product was valued at \$3,756,110. In 1905 there were 188 factories capitalized at \$5,407,313 (144.5% increase), and the value of their products was \$8,830,852 (135.1% increase). The city's principal manufactures in 1905 were: lumber and planing mill products (\$2,040,050); flour and grist-mill products (\$1,080,306); malt liquors (\$679,274); foundry and machine-shop products (\$479,954); and lumber and timber products (\$418,010). Spokane is an important jobbing centre, is a natural supply point for the gold, silver and lead mining regions of northern and central Idaho, eastern Washington, and Oregon, and is a distributing point for the rich agricultural districts in this region.

The first permanent settlement on the site of Spokane was made in 1874 by James N. Glover, who bought from two trappers a tract of land here. The settlement was named Spokane Falls, in memory of the Spokan Indians, a tribe of

Salishan stock, which formerly occupied the Spokane Valley; the word Spokan is said to mean "children of the sun." Spokane was incorporated as a town in 1881 and in the same year received its first city charter (amended in 1891). The city became the county-seat in 1882. The present name was adopted in 1890. The city was reached by the Northern Pacific railway in 1883, by the Union Pacific in 1889, and by the Great Northern in 1892. On the 4-6th of August 1889, thirty squares of the city (nearly all of its business section) were destroyed by fire, with a loss estimated at \$5,000,000. Rebuilding was at once begun, and in about two years the city had been almost entirely reconstructed and greatly improved. In 1910 Spokane adopted a commission form of government.

SPOLETO (anc. *Spoletium*), a town and archiepiscopal see of the province of Perugia, Italy, 18 m. N.N.E. of Terni, and 88 m. N. by E. of Rome by rail. Pop. (1901), 9631 (town); 24,648 (commune). It is situated on a hill, so that the lowest part is about 1000, the highest 1485, ft. above sea-level, at the south end of the open valley of the Topino, a tributary of the Tiber, which it joins near Assisi. The principal industries are the collection and preparation of truffles and preserved foods, also tanning and the manufacture of earthenware. Spoleto is also the centre of an agricultural district, and contains a government experimental olive oil factory. There are few towns of Italy which possess so many Roman remains in good preservation under the medieval buildings, and few medieval towns with so picturesque an appearance. There are considerable remains of perhaps pre-Roman polygonal walls—in one place a piece of this walling has masonry of rectangular blocks superposed, with an inscription of two of the Roman municipal magistrates (*quattuorviri*). There are also a few traces of an inner enceinte of the Roman period. There are remains of a Roman theatre, over 370 ft. in diameter, and an amphitheatre 390 by 205 ft. A Roman bridge of three arches, 80 ft. long and 26 ft. high, exists at the lower (north) entrance to the town, under the modern road to Foligno, in the former bed of a torrent which has now changed its course. A Mithraeum was found outside this gate in 1878. The rock above the town was included within the polygonal walls: but Totila fortified, not this rock, but the amphitheatre, which remained the citadel until 1364, when Cardinal Albornoz destroyed it and erected the present Rocca, which was enlarged by Pope Nicholas V.; it is now a prison. The Porta della Fuga (the name alludes to the repulse of Hannibal) occupies the site of a Roman gate, but is itself medieval: while the medieval enceinte encloses a somewhat wider area than the ancient. The Piazza del Mercato represents the Roman forum; close by is a triumphal arch of Drusus and Germanicus, and a temple (?) into which is built the church of S. Ansano. A Roman house in the upper part of the town, with mosaic pavements, probably belonged to Vespasia Polla, the mother of the emperor Vespasian. The Palazzo Municipale, close by, contains the archives and picture gallery. The cathedral of S. Maria Assunta, much modernized in 1644, occupies the site of a church of the Lombard dukes erected about 602. The present church was consecrated in 1198; the façade belongs to the middle of the 12th century. Over the main entrance is a large mosaic of Christ enthroned, with the Virgin and St John, by the artist Solsernus (1207). The Early Renaissance vestibule (after 1491) is fine. In the choir and on the half dome of the apse, are the finest frescoes of Fra Filippo Lippi (scenes from the life of the Virgin) completed after his death by Fra Diamante: his tomb, erected by Lorenzo de' Medici, with the epitaph by Politian, is on the left of the choir. The fine stalls and panelling in the winter choir date from 1548-1554. In and near the Piazza del Duomo are the unfinished Palazzo della Signoria, of the early 14th century, which contains the archaeological museum, the small Renaissance church of the Manna d'Oro (1527), the façade of the Romanesque basilica of S. Eufemia (in the archbishop's palace) and the fine Early Renaissance Palazzo Arroni with its graffito frieze.

The church of S. Pietro, outside the town on the road to Rome (wrongly supposed to have been the cathedral before 1067), was

founded in A.D. 419 by Bishop Achilles. Its façade is remarkable for its richly sculptured decorations of grotesque figures and beasts, which are of two different dates, about 1000 and about 1200. S. Domenico is a fine example of later Italian Gothic with bands of different coloured stones. Both the church and its crypt contain 14th-century frescoes. The triple-apsed crypt of S. Gregorio probably dates from the 9th century: the upper church was consecrated in 1196 and the Romanesque work covered with stucco in the restoration of 1597. S. Nicolò is a beautiful example of Pointed Gothic. The basilica of S. Salvatore (*il Crocefisso*) at the cemetery belongs to the 4th century A.D. The fine sculptures of the façade, with its beautiful windows, as also the octagonal dome, all belong to this period; Meliorantius, the sculptor of the portal of the cathedral (after 1155), took his inspiration hence. S. Ponziano, not far off, belongs to the 13th century, but its interior has been restored: the crypt contains frescoes of the 15th century. The city is still supplied with water by an aqueduct, to which belongs the huge bridge called the Ponte delle Torri, crossing the ravine which divides the town from the Monte Luco (2723 ft.). The bridge is 253 ft. high and 755 ft. long and has ten arches: the ground plan is Roman; the stone piers are in the main later (the work is often attributed to Theodelapius, the third Lombard duke, in 604), while the pointed brick arches belong to a restoration of the 14th (?) century. The Monte Luco, which commands a splendid view, has several hermitages upon it.

The first mention of Spoletium in history is the notice of the foundation of a colony there in 241 B.C. (Liv. *Epit.* xx.; Vell. Pat. i. 14), and it was still according to Cicero (*Pro Balb.* 21)—"colonia latina in primis firma et illustis"—a Latin colony in 95 B.C. After the battle of Trasimenus (217 B.C.) Spoletium was attacked by Hannibal, who was repulsed by the inhabitants (Liv. xxii. 9). During the Second Punic War the city was a useful ally to Rome. It suffered greatly during the civil wars of Marius and Sulla. The latter, after his victory over Crassus, confiscated the territory of Spoletium (82 B.C.). From this time forth it was a *municipium*. Under the empire it again became a flourishing town, but is not often mentioned in history. It was situated on a branch of the Via Flaminia, which left the main road at Narnia and rejoined it at Forum Flaminii. An ancient road also ran hence to Nursia. Martial speaks of its wine. Aemilianus, who had been proclaimed emperor by his soldiers in Moesia, was slain by them here on his way to Rome (A.D. 253), after a reign of three or four months. Rescripts of Constantine (326) and Julian (362) are dated from Spoleto. The foundation of the episcopal see dates from the 4th century. Owing to its elevated position it was an important stronghold during the Vandal and Gothic wars; its walls were dismantled by Totila (Procop. *Bell. got.* iii. 12). Under the Lombards Spoleto became the capital of an independent duchy (from 570), and its dukes ruled a considerable part of central Italy. Together with other fiefs, it was bequeathed to Pope Gregory VII. by the empress Matilda, but for some time struggled to maintain its independence. In 1155 it was destroyed by Frederick Barbarossa. In 1213 it was definitely occupied by Gregory IX. During the absence of the papal court in Avignon it was a prey to the struggles between Guelphs and Ghibellines, until in 1354 Cardinal Albornoz brought it once more under the authority of the Church. In 1809 it became capital of the French department of Trasimene. In 1860 it was taken by the Italian troops after a gallant defence. Giovanni Pontano, founder of the Accademia Pontaniana of Naples, was born here.

See A. Sansi, *Degli Edifici e dei frammenti storici dell' antichità di Spoleto* (Foligno, 1869), and other works; G. Angelini Rota, *Spoleto e dintorni* (Spoleto, 1905); and various articles by G. Sordini, in *Notizie degli Scavi*. (T. As.)

SPON, JACQUES (1647-1685), French doctor and archaeologist, was born at Lyons and died at Vevey. He is famous as a pioneer in the exploration of the monuments of Greece, travelling there in 1675-1676 with the Englishman (Sir) George Wheeler

(1650-1723), whose collection of antiquities was afterwards bequeathed to Oxford University. Spon brought back many valuable treasures, coins, inscriptions and manuscripts, and in later years published various important works on archaeology, notably his *Voyage d'Italie, de Dalmatie, de Grèce et du Levant* (1678), and a *Histoire de la république de Genève* (1680).

SPONGES. The Sponges or Porifera form a somewhat isolated phylum (or principal subdivision) of the animal kingdom. This phylum includes an immense number of marine and fresh-water organisms, all of which agree amongst themselves in possessing a combination of important structural characters which is not found in any other animals. Though the phylum is a very large one yet almost the only examples with which the name "sponge" is popularly associated are the common bath sponges (species of the genera *Euspongia* and *Hippospongia*), which are amongst the most highly organized and least typical members of the group.

The history of the group begins with Aristotle, who recognized several different kinds of sponge, some of which were used by the Greek warriors for padding their helmets. Owing, however, to the permanently fixed character, irregular growth and feeble power of movement in the adult organism, it was not until the advent of microscopical research that it was definitely proved that the sponges are animals and not plants. Indeed our scientific knowledge of the group can scarcely be said to begin much before the middle of the 19th century, when the classical researches of R. E. Grant, J. E. Gray, H. J. Carter and J. S. Bowerbank laid the foundations of modern spongology. It very soon became evident that the group is one which illustrates with remarkable clearness and beauty those laws of organic evolution which were beginning to attract so much attention from zoologists, a fact which found abundant recognition in Ernst Haeckel's epoch-making work on the Calcareous Sponges published in 1872. This was followed by a series of remarkable researches by F. E. Schulze on the minute anatomy, histology and embryology of the group, which have served as a pattern to all subsequent investigators. In more recent years our knowledge of the sponges has advanced very rapidly, especially as the result of the great series of scientific exploring expeditions inaugurated by the voyage of H.M.S. "Challenger." The large collection made by the "Challenger" expedition alone, necessitated a complete reorganization of our systematic knowledge of the phylum, and afforded the foundation upon which our present system of classification has been built up. There is perhaps no great group of the animal kingdom in the study of which greater advance has been made in the last twenty years. It is impossible in the space at our disposal to do justice to the numerous valuable memoirs which have appeared during this period, but reference to the more important works of recent investigators will be found in the bibliography at the end of this article, while for a comprehensive account of the whole subject the reader should refer especially to Professor E. A. Minchin's article in Sir E. Ray Lankester's *Treatise on Zoology*.

General Characters of the Phylum.—The sponges are all aquatic organisms, and for the most part marine. They vary in size from minute solitary individuals, scarcely visible to the naked eye, up to great compound masses several feet in circumference, and in form from almost complete shapelessness to the most exquisite and perfect symmetry. The indefiniteness of shape and size which characterizes the vast majority of the group is due to the power of budding, which is almost universal amongst them, whereby extremely complex colonies are built up in which it is usually impossible to determine the limits of the individual zooids or persons, while very frequently, by a process of integration, individuals of a higher order are produced which again form colonies by budding (fig. 2).

The entire body of the sponge is penetrated by a more or less complicated canal-system, beginning with numerous inhalant pores, scattered over the general surface or collected in special pore-areas, and ending in one or several larger apertures, the vents or oscula, situated usually on the uppermost portions of the sponge (fig. 8). If the living animal be kept under

observation it will be seen that a stream of water is ejected with considerable force from the vents, carrying with it minute particles in suspension. At the same time numerous smaller streams enter the canal system through the inhalant pores, bringing with them the minute particles of organic matter upon which the sponge feeds and the oxygen which it requires for respiration. This stream of water may be temporarily interrupted by the closure of the pores and vents, to be resumed apparently at will. It is maintained by the activity of certain cells, known as collared cells or choanocytes (fig. 35, g, fig. 36), which line the walls of the canal system either throughout their entire extent or in certain regions only. These cells bear an extraordinarily close resemblance to the choanoflagellate Protozoa or collared Monads. Each is provided with a filmy protoplasmic collar and a long whip-like flagellum, and the movements of the latter drive the water out of the canal-system through the vents and thus keep up the circulation. In all but the simplest sponges the collared cells are confined to certain portions of the canal system known as flagellated chambers (fig. 9), the size, form and arrangement of which vary greatly in different types. That part of the canal-system which is not lined by collared cells is covered with a flattened pavement-epithelium (fig. 34, r), and so also is the outer surface of the sponge. The space between the various branches of the canal-system is occupied by a gelatinous ground-substance (mesogloea) in which amoeboid and connective-tissue cells are embedded (fig. 34, 3, 4, 5; fig. 35, a), and in which in most cases a well-developed skeleton is secreted by special cells known as scleroblasts. This skeleton (figs. 24-32, &c.) supports the extremely soft tissues of which the body is composed, and consists either of mineral spicules (carbonate of lime or silica) or of horny fibres (spongin), or of a combination of siliceous spicules with spongin. In many cases the proper skeleton is more or less completely replaced by sand.

The question as to how far the cell-layers of the sponge body correspond to the "germinal layers" usually recognizable in other multicellular animals is an extremely difficult one and not yet by any means settled. It has until recently been generally supposed that the flattened epithelium which covers the outer surface of the sponge, together with part of that which lines the canal-system, is ectodermal, while the collared cells and the remainder of the flattened epithelium lining the canal-system are endodermal, and the term mesoderm has been frequently applied to the middle gelatinous layer. Recent embryological research, however, makes it extremely doubtful whether this view is justifiable, and whether indeed the germ-layers of typical Metazoa can be identified at all in the Porifera. Embryological research, moreover, tends to show that the primitive gastral epithelium (of collared cells) is in most sponges completely replaced, except in the flagellated chambers, by an invasion of the dermal epithelium (composed of flat pavement-cells).

Sexual reproduction, by means of ova and spermatozoa, is probably universal throughout the group. The segmentation of the ovum gives rise to the free-swimming ciliated larva (figs. 38, e, 39) in the form of a hollow "amphiblastula" or of a solid "parenchymula." This larva becomes attached and, by means of a more or less complex metamorphosis, gives rise to the young sponge. During the metamorphosis the outer, ciliated or flagellated cells of the larva take up their position in the interior of the body and give rise to the collared cells of the adult; while the inner cells (of the parenchymula) migrate outwards and form the superficial epithelium, so that the position of the so-called "ectoderm" and "endoderm" is completely reversed in the adult as compared with the larva.

A sexual reproduction is effected by budding, and the buds may either remain attached to the parent and form colonies or become detached and form entirely separate individuals.

Types of Structure.—We may illustrate our account of the general characters of the group by a brief description of the anatomy of three widely divergent types, selected as being fairly representative of the entire group, viz. *Leucosolenia*, *Plakina* and *Euspongia*.

Leucosolenia.—The genus *Leucosolenia* includes a number of calcareous sponges of very simple structure, and thus forms a suitable starting-point for our studies. Imagine a minute, thin-walled sac (fig. 1), attached at the lower end to some rock or seaweed, and enclosing a spacious cavity in its interior. This cavity is the gastral or digestive cavity, and it opens to the exterior

through a wide vent or osculum at the upper extremity of the sponge. The thin wall is also pierced by numerous small inhalant pores or prosopyles. The inhalant pores, the gastral cavity and the vent constitute the canal-system, through which a stream of water can be kept flowing by the activity of the collared cells which line practically the whole of the gastral cavity. Each collared cell consists of an oval nucleated body surmounted by a filmy protoplasmic collar, in the middle of which the whip-like flagellum projects into the water. They are placed close together, side by side, and thus form a continuous layer, extending almost up to the vent and interrupted only by the inhalant pores. The outer surface of the sponge is covered by a single layer of flattened pavement-epithelium or epidermis. Some of these cells, distinguished as porocytes, become perforated by the inhalant pores, around which they form contractile diaphragms capable of opening and closing, and thus regulating the supply of water. Between the outer protective, dermal epithelium, and the inner gastral epithelium of collared cells, lies the mesogloea, a layer of gelatinous material containing cells of at least two kinds, amoebocytes and scleroblasts. The former closely resemble the amoeboid white blood corpuscles, or leucocytes, of higher animals, and have the power of wandering about from place to place in the sponge-wall. They probably serve to distribute food material and carry away waste products, and some of them undoubtedly give rise to the ova and spermatozoa. The scleroblasts are derived from cells of the dermal epithelium which migrate inwards into the gelatinous ground-substance and there secrete the spicules of which the skeleton is composed. These spicules are composed of transparent crystalline carbonate of lime (calcite), and may be of three fundamental forms: triradial, quadriradial and monaxon. It has been shown by E. A. Minchin, however, that the triradial and quadriradial types are not simple spicules but spicule-systems, each formed of three or four primary spicules, originating from as many mother-cells and only secondarily united. In fig. 1 only triradial spicules are represented, but very often all three kinds are present in the same sponge (cf. fig. 24). The triradiates lie in the mesogloea with their three rays extended in a plane parallel to the surfaces of the sponge-wall, and form a kind of loose scaffolding upon which the soft tissues are supported. The quadriradiates resemble the triradiates in form and position, but a fourth ray is developed which projects through the layer of collared cells into the gastral cavity, where it serves as a defence against internal parasites. The monaxon spicules have one end embedded in the mesogloea while the other projects outwards and upwards and serves as a defence against external foes.



(After Haeckel.)

FIG. 1.—*Leucosolenia primordialis* (Olynthus form).

Although all species of the genus *Leucosolenia* agree essentially in structure, yet they exhibit very great diversity in external form. This is due to the habit of budding and colony formation. All start life after the metamorphosis of the larva in the simple sac-shaped condition which we have just described, and to which the name "Olynthus-type" is sometimes applied. This is indeed the simplest type of sponge organization known to us and we must look upon the Olynthus as representing a primary sponge-individual or "person." By a simple process of budding, in which

the buds all remain united together by their bases, we get a branched colony in which the persons or zooids are still easily recognizable, each with its own vent or osculum. Very frequently, however, the zooids become elongated into slender cylindrical tubes which branch in an extremely complex manner and anastomose with one another in many places to form networks, in which it is no longer possible to recognize the component individuals (fig. 2). This is known as the "Clathrina" type of structure, and we may look upon a Clathrina colony as an individual of a higher order, which may assume a definite external form and even acquire a secondary internal cavity (pseudogaster), opening to the exterior through a secondary vent (pseudosculum), while the outer tubes of the colony may give rise to a protective skin (pseudoderm), perforated by secondary inhalant pores (pseudopores) which are obviously quite distinct in nature from the primary inhalant pores or prosopyles of the Olynthus.

Other types of colony-formation in the genus *Leucosolenia* will be discussed when we come to deal with the canal-system in general.

Plakina.—The genus *Plakina* includes some of the simplest of the siliceous sponges. Just as in the Calcarea the most primitive "person" or individual is represented by the Olynthus type, so in the non-calcareous sponges we may recognize a primitive or

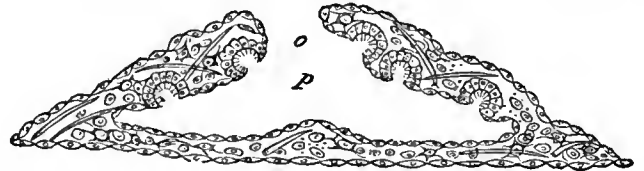

(After Keller.)

FIG. 3.—Vertical section of a Rhagon, diagrammatic.

o, Osculum; *p*, Gastral cavity. (X 100.)

fundamental form of individual to which the name "Rhagon" has been applied. This is the first stage reached after the metamorphosis of the larva in certain species, and the little sponge consists of a cushion-shaped sac, attached below by a broad flattened base and terminating above in a single vent or osculum (fig. 3). There is a large gastral cavity lined by pavement-epithelium and surrounded by a number of more or less spherical "flagellated chambers," lined by collared cells. These chambers open into the gastral cavity by wide mouths (apopyles) and communicate with the exterior by smaller inhalant pores. The entire outer surface of the sponge is covered with pavement-epithelium and there is a well-developed mesogloea which may contain spicules. This Rhagon may be compared to an Olynthus which has become flattened out from above downwards and from which a number of small buds (the flagellated chambers) have been given off all round, except from the attached basal portion; so that the whole forms a small colony, in which the collared cells have become restricted to the buds. We may, therefore, perhaps, look upon the Rhagon as an individual or person of a higher order than the Olynthus. Like the Olynthus the Rhagon occurs as a transient stage in the development of certain sponges, but we do not know any non-calcareous sponge which remains in such a simple condition throughout life. In *Plakina monolopha*, for example, the entire wall of the Rhagon becomes thrown into folds (fig. 4) so that a system of inhalant and exhalant canals is formed between the folds, through which the water has to pass on its way to and from the chambers. The inhalant canals lead down between the folds from the outer surface of the sponge. In *P. monolopha* they are wide and ill defined. In another species, *Plakina dilopha*, they become constricted to form perfectly definite, narrow canals, by the development of a thick layer of mesogloea (and pavement-epithelium) which covers the outer surface of the sponge in such a manner that the folded character is no longer visible externally. The external openings of the inhalant canals now form definite dermal pores. In such a sponge as this the folded chamber-layer of the sponge-wall is sometimes called the choanosome, while the external layer of mesogloea and pavement-epithelium is called the ectosome. In a third species, *Plakina trilopha*, further folding of the "choanosomal lamella" takes place and we thus get a still more complex canal-system.

In *Plakina* the spicules are composed of colloidal silica. The fundamental spicule form is the primitive tetract or calthrops, consisting of four sharp-pointed rays diverging at equal angles from a common centre (fig. 5, a-e). Modifications of this form occur in two directions: in the first place some of the tetracts, by branching of one ray, give rise to "candelabra," while others, by suppression of rays, give rise to forms with three or even two rays only, triacts and diacts, the latter sometimes termed oxeate (fig. 5, f-l). The arrangement of the spicules is very irregular; the candelabra alone are definitely arranged (at the surface of the sponge), the other forms are thickly scattered without any sort of order throughout the mesogloea.

Euspongia.—The genus *Euspongia*, to which belong all the finer bath sponges, is a typical example of the true "horny" sponges or *Euceralosa*, characterized especially by the fact that the skeleton is not composed of spicules but of so called horny fibres. A living

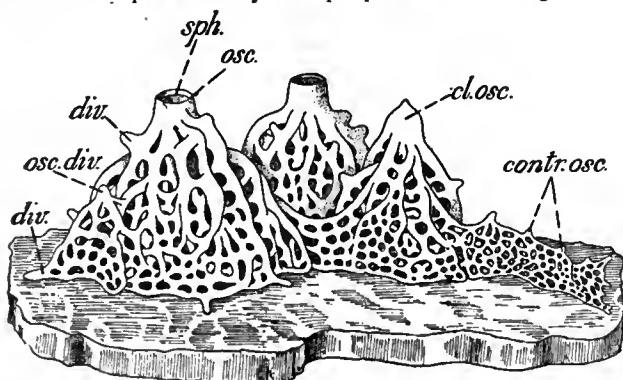

(After Minchin, from Lankester's *Treatise on Zoology*.)

FIG. 2.—*Leucosolenia (Clathrina) clathrus*, natural size; showing reticulate form of colony, expanded and with open oscula on the left, contracted and with closed oscula on the right.

osc., Osculum. *ph.*, Sphincter of osculum.
cl. osc., Closed osculum. *div.*, Diverticula.
contr. osc., Closed oscula in contracted part of colony. *osc. div.*, Diverticula from which new oscula arise.

bath sponge appears as a dark-coloured, irregular or sometimes cup-shaped mass attached by the under surface to the sea-bottom. The outer surface is covered by a skin or dermal membrane, elevated in innumerable minute conuli by the growing apices of the primary

speak of under the name "sponge." It consists of a very close network of spongin fibres (closely resembling silk in chemical composition), some of which, known as primaries, run towards the surface at fairly regular intervals, while others, known as secondary

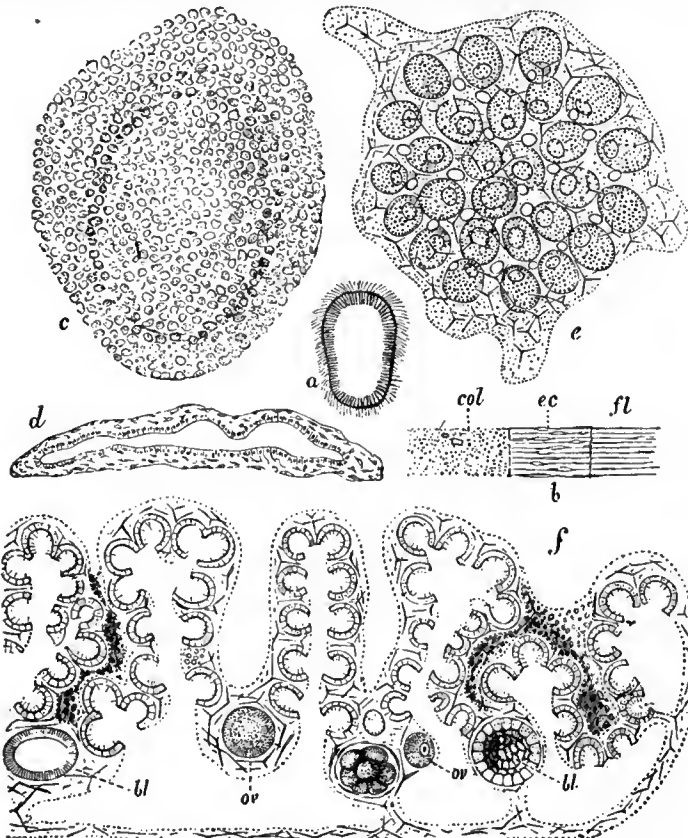

(After F. E. Schulze.)

FIG. 4.—*Plakina monolopha*.

- a, Ciliated embryo (the central part should be shaded).
- b, Part of section of ciliated embryo.
- col, Inner cell-mass.
- ec, External, columnar cells.
- fl, Flagella.
- c, Attached embryo, viewed from above, with the gastric cavity appearing in the interior.
- d, Vertical section of attached embryo.
- e, Rhagon stage, viewed as a transparent object, showing the inhalant pores on the surface and the flagellated chambers in the interior; the osculum is not shown.
- f, Part of vertical section through adult sponge, showing the folded choanosomal lamella or spongophare.
- ov, Ova.
- bl, Embryo.

skeleton fibres. This skin is pierced by a vast number of inhalant dermal pores of microscopic size, and by a much smaller number of comparatively large vents or oscula. When the sponge is removed from the water the soft tissues rapidly decay and leave behind only the elastic "horny" skeleton, which is what we usually

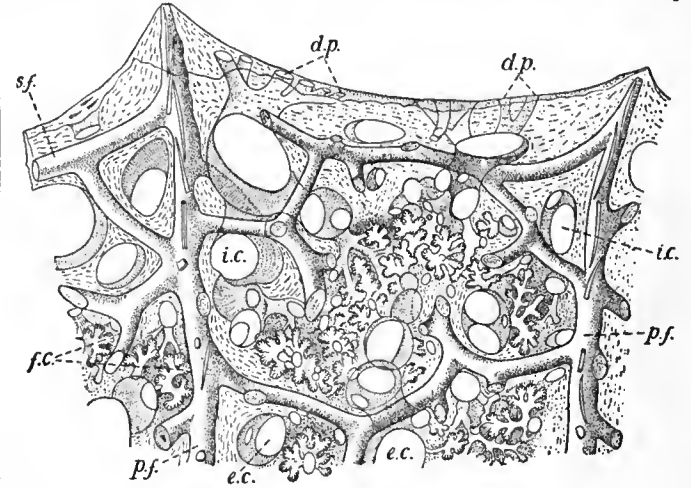

(After F. E. Schulze. From a coloured plate in *Zeits. für Wissen. Zoologie*, by permission of Wilhelm Engelmann.)

FIG. 6.—*Euspongia officinalis* (bath sponge). Part of vertical section showing general arrangement of skeleton and canal-system. p.f., Primary fibre of skeleton. i.c., Inhalant canals. s.f., Secondary fibres. e.c., Exhalant canals. d.p., Dermal pores (inhalant). f.c., Flagellated chambers. fibres, connect the primaries in all directions and themselves branch and anastomose freely. The primary fibres contain particles of sand or foreign spicules which are taken in by their growing

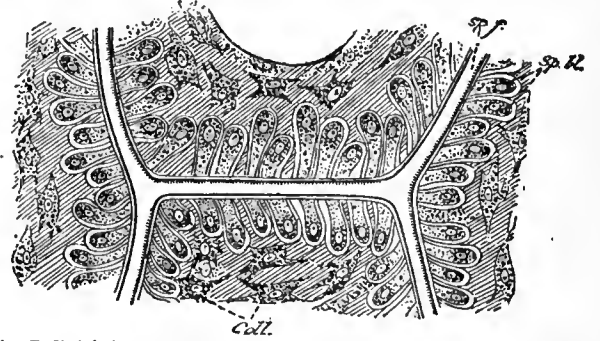

(After F. E. Schulze. From Lankester's *Treatise on Zoology*.)

FIG. 7.—*Euspongia officinalis* (bath sponge). Skeleton. Fibre surrounded by spongoblasts.

sp.f., Spongin fibre; sp.bl., Spongoblasts. Coll., Collenzytes. apices at the surface of the sponge, and the presence of which may greatly injure the quality of the sponge. The connecting fibres are only about 0.035 mm. in diameter, or even less, and the primaries are a little thicker, while the meshes between the fibres are so narrow as to permit of the soaking up of water by capillary attraction,

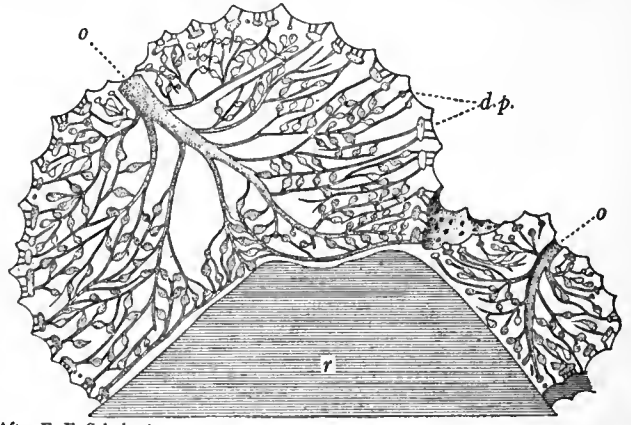

(After F. E. Schulze.)

FIG. 8.—*Euspongia officinalis* (bath sponge). Diagram of the arrangement of the canal-system as seen in vertical sections of two young individuals. d.p., Dermal pores; o, Oscula; r, Rock to which the sponges are attached.

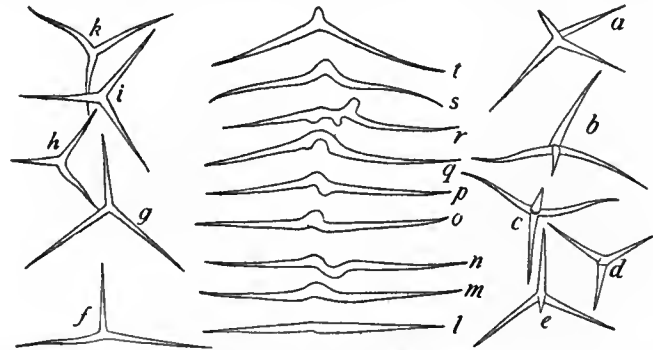

(After F. E. Schulze. From a plate in *Zeitschrift für Wissen. Zoologie*, by permission of Wilhelm Engelmann.)

FIG. 5.—*Plakina monolopha*.

Spicules, a-e, tetracts or calthrops; f-k, triacts or triradiates; l-t, diacts, showing how the monaxon form (l) may be derived from the primitive tetract (a) by suppression of actines.

the property upon which the economic value of the bath sponge depends. In the living sponge the fibres are embedded in the mesogloea, where they are secreted by special cells known as spongo-blasts, which are often found thickly clustering around them (fig. 7). The canal-system (figs. 6, 8) is very complex and shows but little indication of its origin from a folded rhagon. The inhalant pores lead each into a short, narrow, inhalant canal; these unite in roomy subdermal cavities lying in the ectosome, and from these in turn the main inhalant canals come off. The latter divide

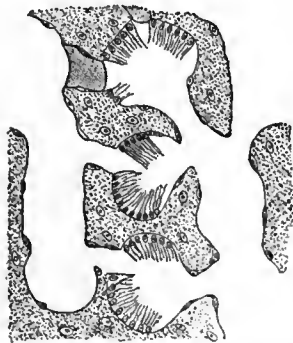

(After F. E. Schulze. From a plate in *Zeits. für Wissen. Zoologie*, by permission of Wilhelm Engelmann.)

FIG. 9.—*Euspongia officinalis* (bath sponge). Part of a section such as is shown in fig. 6, more highly magnified, showing three flagellated chambers, with inhalant canaliculi on the left and exhalant canaliculi on the right.

and subdivide, and thus ramify through the deeper parts of the sponge amongst the flagellated chambers, to each of which a small number of slender canaliculi are ultimately given off (fig. 9). The chambers themselves, lined by the usual collared cells, are small and approximately spherical, and each one discharges its water through a short and narrow exhalant canaliculus (fig. 9). The openings of the inhalant canaliculi into the chambers, of which there are several, correspond to the prosopyles of an Olynthus, while the single exhalant opening, or apopyle, may possibly correspond to an Olynthus osculum. The exhalant canaliculi unite together to form larger and larger canals which finally lead the stream of water to the vents on the surface of the sponge (fig. 8). The various parts of the canal-system, other than the chambers themselves, are lined by a flat pavement-epithelium, and the mesogloea, occupying all the spaces between the different parts of the canal-system, contains cells of various kinds, embedded in a very granular matrix.

Comparative Anatomy.

External Characters.—Amongst the simpler calcareous sponges, which are all of comparatively small size, the external form is usually symmetrical and is evidently a kind of outward expression of the arrangement of the canal-system. This is well seen in the simplest form of all, the sac-shaped Olynthus, and also in its simpler Syconoid and Leuconoid derivatives (described later on), which may be regarded either as individuals of a higher order or as colonies of Olynthus persons grouped around a central individual whose large gastral cavity opens to the exterior through the single osculum. In the more complex Leuconoids, however, the process of colony formation becomes very irregular and may give rise to great compound masses, with many vents. In these masses we may perhaps recognize the presence of individuals of three orders: (1) the primitive Olynthus persons, represented by the individual flagellated chambers; (2) the Leuconoid persons, indicated each by its osculum; and (3) the entire colony formed by the union of many such Leuconoid persons in an irregular manner. It is, however, very doubtful how far the flagellated chambers in such forms as this can be regarded as morphologically equivalent to Olynthus persons.

In the non-calcareous sponges we are always dealing with individuals of a high order, which usually form complex aggregates (colonies) of large size and very various shape. As a general rule the form of those non-calcareous sponges which grow in shallow water is extremely irregular and variable while at great ocean depths the shape is usually definite, constant and often exquisitely symmetrical, a fact which may perhaps be accounted for in part by the absence of disturbing influences such as are met with in shallow water. Perhaps the most extraordinary external form yet discovered is that of *Esperiopsis challengerii*, discovered by the "Challenger" expedition in deep water off the Philip-

(After Ridley and Dendy. From a plate in "*Challenger*" Reports, xx., by permission of the Controller of H.M. Stationery Office.)

FIG. 10.—*Esperiopsis challengerii*: a deep-water Monaxonellid Sponge.

pine Islands (fig. 10), a form which reminds one strikingly of a number of flowers arranged in a raceme, except that the largest and oldest member of the compound colony is at the top of the stalk and the smallest at the bottom. In other deep-water species the external form may frequently be explained

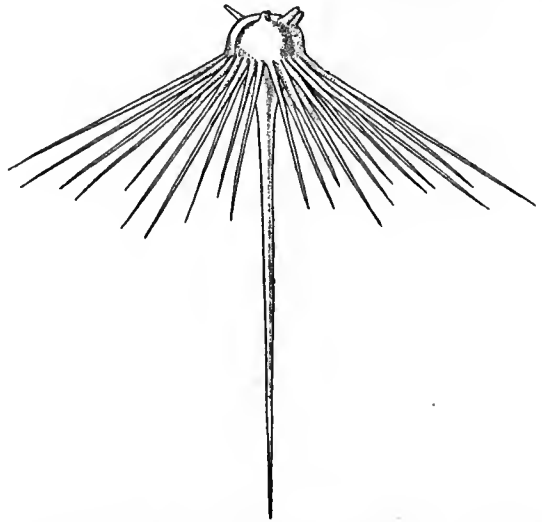

(After Ridley and Dendy. From "*Challenger*" Reports, xx., by permission of the Controller of H. M. Stationery Office.)

FIG. 11.—*Cladorhiza longipinna*: a deep-water Monaxonellid Sponge, showing the "Crinorhiza" form, adapted for support on soft ooze.

as an adaptation to the special exigencies of the environment. Thus, for example, many species are provided with long stalks which lift up the body of the sponge out of the soft ooze in which it would otherwise be smothered, while the bottom of the stalk is frequently extended in root-like processes which serve to attach it to some solid object (e.g. *Stylocordyla*). In other cases the sponge supports itself on the surface of the ooze by long stiff processes, formed of bundles of spicules which radiate from the central, cap-shaped body; this is known as the "Crinorhiza form," and is met with in several distinct genera (fig. 11). Amongst the Hexactinellida, which are essentially a deep-water group, many very beautiful external forms are met with, the best known, perhaps, being the so-called Venus's flower basket (*Euplectella*, fig. 12).

Flabellate (or fan-shaped) and cup-shaped forms are frequently met with even amongst shallow-water sponges, and in widely separated genera, such as *Poterion* (the great Neptune's cup sponge) and *Reniera testudinaria*. In *Phyllospongia* the flabellate and cup-shaped forms pass insensibly into one another, the cup being apparently merely a folded lamella. Slender branching forms are also not uncommon in shallow water, as seen in the common *Chalina oculata* of the British coast. Spherical forms, such as *Tethya*, likewise occur. By far the greater number of shallow-water sponges, however, are quite irregular in shape and either form crusts of varying thickness on the surface of rocks and sea-weed, or large and massive aggregates which may rise to a considerable height above the substratum. In the boring sponges (Family Clionidae) the sponge occupies an elaborate system of chambers and passages which it excavates for itself in the shells of Mollusca and other calcareous organisms. The common British *Cliona celata* begins



(After F. E. Schulze. From a plate in "*Challenger*" Reports, xxi., by permission of the Controller of H.M. Stationery Office.)

FIG. 12.—*Euplectella aspergillum*, "Venus's Flower Basket": a Hexactinellid Sponge.

life in this way, but soon outgrows the housing capacity of its host, whose shell then serves merely as a base of attachment for the large independent sponge-colony.

One of the most striking features of living sponges is their colour, which is often very brilliant. Yellow, red, orange, purple, brown, black, green and blue are all met with, in varying degrees of purity and intensity, amongst the commoner Non-calcareous; whilst the calcareous sponges are usually white. It appears probable that the colour is more or less constant for each species, and may therefore afford a useful guide to specific identification. As a rule the colour is lost in spirit-preserved or dry specimens, but a noteworthy exception is found in the brilliant purple *Suberites wilsoni* of Port Phillip, in which the colour, though soluble in water, is permanent in dry specimens and in alcohol. The colouring matter is sometimes lodged in special pigment cells belonging to the sponge itself, and sometimes in symbiotic algae, with which the mesogloea is frequently filled.

Canal-system.—Whether we start with the primitive Olynthus form of the Calcareous or with the more advanced Rhagon of many Non-calcareous, it is evident that further advance in the complication of the canal-system is arrived at either by budding or folding, or by a combination of these processes. As, however, the canal-systems of the calcareous and of the main types of non-calcareous sponges have been evolved along perfectly independent lines it will be well to consider them separately.

In the genus *Leucosolenia* (Calcareous Homocoela) the primitive Olynthus form may, as we have already seen, give rise, by branching and anastomosing, to complex reticulate colonies of the Clathrina type, in which a pseudoderm, pierced by inhalant pores, may cover over a system of inhalant canals which are simply the interspaces between the branching tubes of which the colony is made up, while at the same time a centrally placed pseudogaster, which is simply a space enclosed by upgrowth of the colony around it, may form the main exhalant canal and open to the exterior through a well-defined vent or pseudosculum. In this direction perhaps the most remarkable modification arrived at is that of *Leucosolenia cavata*, in which the Clathrina tubes, lined by collared cells, widen out into large irregular spaces, while the inhalant interspaces become constricted into narrow canals lined by collared cells on the outside. We have here a kind of inversion of the ordinary Clathrina canal-system, but a perfectly gradual transition from the ordinary to the inverted condition is seen as we pass from the older to the younger parts of the colony.

In *Leucosolenia (Dendya) tripodifera* (fig. 13) we find a totally different type of colony formation, which is of great importance as indicating in its canal-system the possible starting-point of a line of evolution which culminates in the highest Calcareous. Here a large central individual, whose spacious gastral cavity is lined by collared cells, gives off radial buds from all sides, which branch slightly and terminate in blind ends in contact with one another, so that the entire colony has an approximately even surface. The inhalant canals are represented by the interspaces between the radial tubes, between the blind extremities of which the water finds its way in from the outside. There is only a single vent, situate at the extremity of the central cavity. This cavity must be regarded as the original gastral cavity of a parent Olynthus, from which the radial tubes have been produced by budding.

(After Dendy. Simplified from a coloured plate in *Trans. Roy. Soc. of Victoria*, Melbourne, vol. iii. pt. 1.)

FIG. 13.—*Leucosolenia tripodifera*, with part of the sponge-wall cut away to show the arrangement of the radial outgrowths.

pierced as before by numerous prosopyles through which the water enters from the spaces between the chambers, while the original gastral cavity forms a central exhalant canal terminating in the single vent, a true osculum, corresponding to the osculum of an

Olynthus. In the simplest Syconoid forms (*Sycella*) the radial chambers remain perfectly straight and unbranched. They do not touch one another at all and there is no trace of an ectosome or dermal cortex, and hence there are no true inhalant canals, and the water circulates without interruption between the chambers. In the genus *Sycon* (fig. 14) the walls of adjacent chambers come into contact with one another and fuse together and thus give rise to more or less well-defined inhalant "inter-canals." The chambers themselves may branch, and in some species of *Sycon* a thin, pore-bearing dermal membrane connects together their distal extremities and covers over the entrances to the inhalant canals. The canal-system now exhibits all the different parts found in the most highly-organized sponges: viz. dermal pores, inhalant canals, flagellated chambers, exhalant canal and osculum. In the genus *Grantia* and its allies (e.g. *Ute*, fig. 15) the thin dermal membrane of *Sycon* is converted into a well-developed cortex, covering the extremities of both the inhalant canals and the radial chambers, and sometimes containing a system of special cortical inhalant canals. We may now distinguish between an ectosome (the dermal cortex), which contains no flagellate chambers, and a choanosome in which chambers are present. The next stage has probably been arrived at by a kind of folding of the choanosome, for we find the chambers arranged

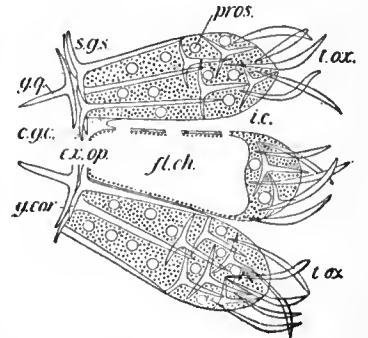

(From Dendy, in *Quart. Journ. Micro. Sci.*, new series, xxxv., by permission of J. and A. Churchill.)

FIG. 14.—*Sycon carteri*, part of a transverse (horizontal) section, showing three radial chambers, the middle one cut open.

fl.ch., Flagellated chamber.
ex.op., Its exhalant opening or apopyle.
pros., Prosopyle.
c.g.c., Central gastral cavity.
i.c., Inhalant canal.
g.cor., Gastral cortex.
g.q., Gastral quadriradiate spicule.
s.g.s., Subgastral sagittal triadial spicules, forming the first joint of the articulate tubular skeleton.
t.ox., Tufts of monaxon spicules at the ends of the chambers.

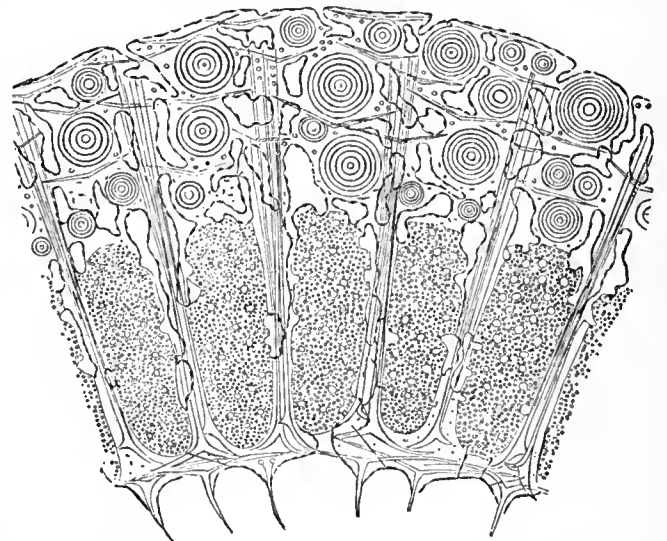

(After Poléjaeff.)

FIG. 15.—*Ute argentea*, part of transverse section, showing the Syconoid canal-system, and thick dermal cortex containing huge longitudinally placed monaxon spicules whose cross-sections are represented by concentric circles.

radially, not around the central gastral cavity but around diverticula of the latter which form special exhalant canals. This condition, sometimes called the "sylllebid" type, is not characteristic of any particular genus or family, but occurs in a few isolated species, such as *Leucilla connexiva* (fig. 16). A somewhat similar condition may be arrived at by branching of the radial flagellated chambers, as in *Heteropogma* (fig. 17). The next stage is marked by great reduction in the size of the chambers, which may become almost spherical, and by further folding of the choanosome, so that in a section of the sponge-wall we see the small chambers scattered irregularly in the mesogloea between the numerous branches of complicated inhalant and exhalant canals. Each

chamber still has several prosopyles, through which it receives water from the ultimate branches of the inhalant canals, while it opens into a relatively large exhalant canal by a wide apopyle. This is the highest type of canal-system met with amongst the Calcarea. It is sometimes known as the Leucon type and is seen in most species of the genus *Leucandra*, as well as in many others.

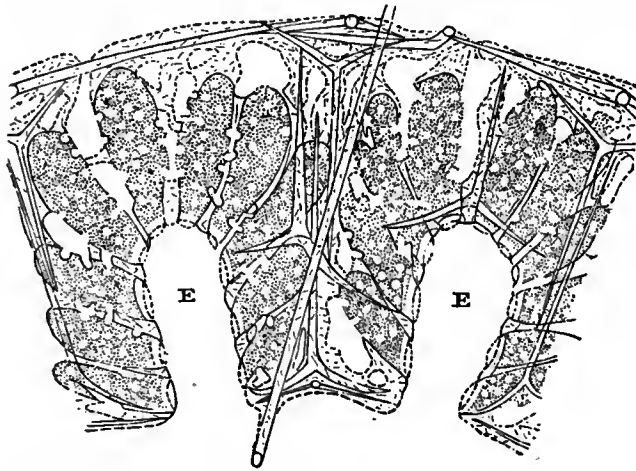

(After Poléjaeff.)

FIG. 16.—*Leucilla connexiva*, part of transverse section, showing "syllebid" type of canal system with folded chamber layer and exhalant canals (E) into which the chambers open.

It is almost identical with one of the types commonly found in non-calcareous sponges (e.g. *Plakina*, fig. 4), but has of course been evolved independently. The various types of canal-system met with in the Calcarea are connected together by numerous intermediate forms, thus forming a very interesting evolutionary series, while both the Syllebid and Leuconoid types appear to have been independently evolved several times, thus affording excellent examples of the phenomenon of convergence, a phenomenon which is very frequently met with amongst sponges.

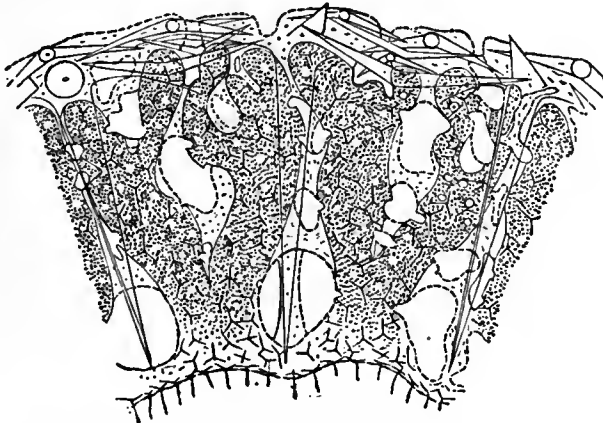

(After Poléjaeff.)

FIG. 17.—*Heteropogma nodus-gordii*, part of transverse section, showing branching flagellated chambers and huge subdermal quadriradiate spicules, with greatly reduced tubular skeleton.

In describing the anatomy of *Plakina* as a type of non-calcareous sponge, we have traced the development of a fairly complex canal-system from the so-called Rhagon form. We can, however, hardly regard the Rhagon as representing a fundamental type of canal-system common to all the Non-calcareous, for in some of the Myxospongida, which are the most primitive of all, and again in the Hexactinellida, we find a type characterized by the presence of elongated sac-shaped flagellated chambers resembling those of the Sycon type amongst the Calcarea, and these chambers are arranged radially around the exhalant canals (*Halisarca*, Hexactinellida). The first recognizable stage in the evolution of the canal-system of the Non-calcareous would thus appear to be a condition not unlike that of *Sycon*, with a number of elongated chambers arranged radially around a central gastral cavity and having their blind outer extremities covered over by a dermal membrane. This stage is very nearly reproduced in the young form of a Hexactinellid sponge, *Lanuginella pupa*. From some such form the Rhagon type may perhaps be derived by flattening out of the lower end of the sponge into a broad base of attachment, and by reduction in the size of the flagellated chambers, accompanied by a more irregular arrangement.

Starting from the primitive Myxosponge ancestor, with large sac-shaped chambers, radially arranged, the Non-calcareous have apparently developed along four main lines, giving rise to the existing Myxospongida, the Hexactinellida (Triaxonida), the Tetraxonida

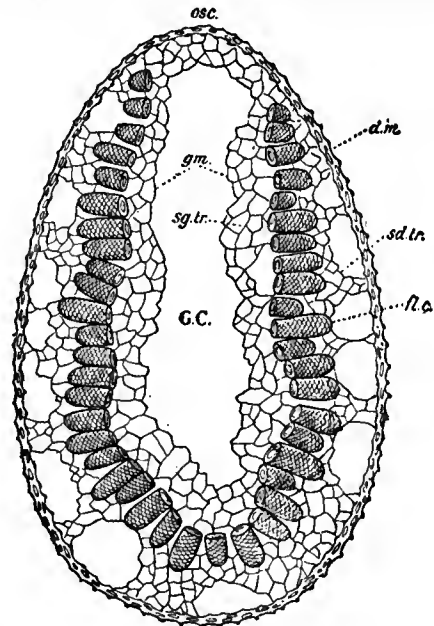

(After F. E. Schulze. From Lankester's *Treatise on Zoology*.)

FIG. 18.—*Lanuginella pupa*. O.S., Vertical section of a young specimen (spicules omitted).

d.m., Dermal membrane. *gm.*, Gastral membrane.
sd.tr., Subdermal trabecular layer. *G.C.*, Gastral cavity.
fl.c., Flagellated chamber. *osc.*, Region of future osculum.
sg.tr., Subgastral trabecular layer.

and the Euceratosa. The Myxospongida have retained the large size of the chambers in certain forms (*Halisarca*, *Bajalus*), but have lost this primitive character in the more advanced members of the group (*Oscarella*). The Hexactinellida have retained the large size and radial arrangement of the flagellated chambers throughout their entire series. The chamber layer, however, tends to become more or less folded (fig. 19), and always lies between two layers of

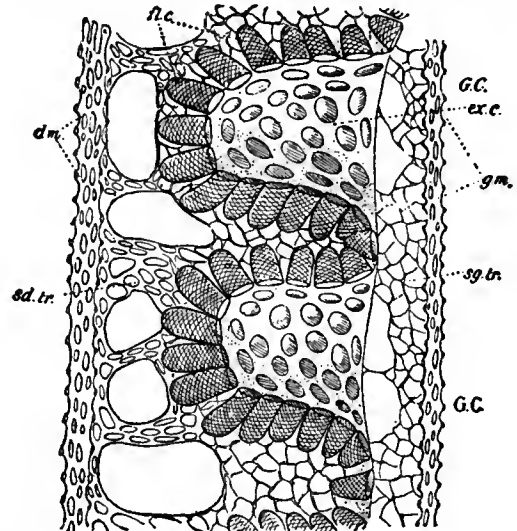

(After Schulze. From Lankester's *Treatise on Zoology*.)

FIG. 19.—Section of the Body-wall of *Bathydorus fimbriatus*, F.E.S. (spicules omitted).

ex.c., Exhalant canals. *sg.tr.*, Subgastral trabecular layer.
d.m., Dermal membrane. *gm.*, Gastral membrane.
sd.tr., Subdermal trabecular layer. *G.C.*, Gastral cavity.
fl.c., Flagellated chambers.

loose trabecular tissue in which the canals are represented by irregular spaces. The Tetraxonida appear to have suffered reduction in the size of the flagellated chambers at a very early date, and it is of this group especially that the Rhagon type is characteristic (e.g. *Plakina*, fig. 4). The Euceratosa exhibit a beautiful series,

beginning with forms (*Aplysillidae*) having large sac-shaped chambers like those of Hexactinellids and ending with forms (*Spongiidae*, *Euspongia*, figs. 6, 8, 9) having small spherical chambers.

Along all four lines of descent it is probable that folding of the choanosome, or chamber-bearing layer of the sponge-wall, has played a very important part in the evolution of the canal-system. This folding is very clearly seen in the Hexactinellida and in such forms as *Oscarella* (Myxospongia) and *Plakina* (Tetragonida). By this process inhalant and exhalant canal-systems have been formed, and then the ends of the inhalant canals have in most cases been closed in by development of an ectosome, as in *Plakina trilopha* and *Stelletta phrissens* (fig. 20). In the majority of cases (e.g.

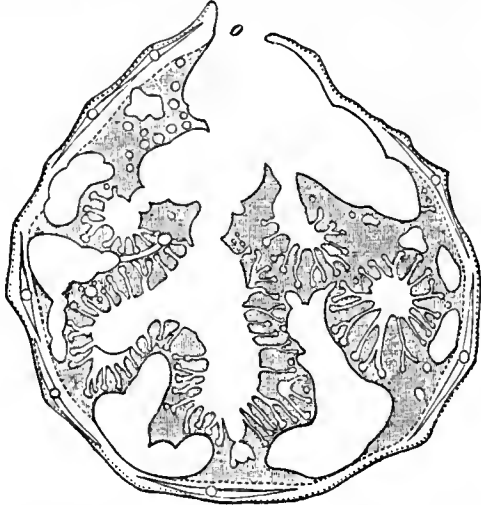

(After Sollas.)

FIG. 20.—Young specimen of *Stelletta phrissens* (Sollas). Vertical section through the osculum (*o*), showing the choanosome folded within the ectosome.

Euspongia) the folding has become so complex that it is no longer recognizable as such, and the origin of the now well-defined inhalant and exhalant canals is completely disguised. In many cases the principal exhalant canals may be surrounded by a layer of tissue of considerable thickness in which there are no flagellated chambers at all, known as the endosome, so that the folded choanosome may be sandwiched in between ectosome on the outside and endosome on the inside.

The manner in which the flagellated chambers communicate with their respective branches of the inhalant and exhalant canal-

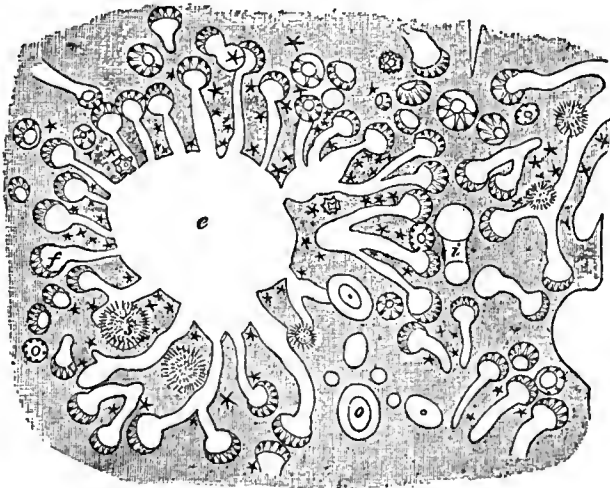

(After Sollas.)

FIG. 21.—Transverse section across an exhalant canal and surrounding choanosome of *Cydonium eosaster* (Sollas), showing the apophodal flagellated chambers.

system varies considerably in different forms, and the following types are recognizable, though by no means sharply distinguished from one another. In the more primitive forms (e.g. Hexactinellida, Aplysillidae, Spongiellidae) each chamber is provided with several prosopyles and receives its water supply direct from relatively large inhalant canals or even lacunae, discharging it again through a wide mouth (apopyle) into a relatively large exhalant canal or lacuna which also receives water directly from other chambers.

To this type (fig. 4, *f*) the name "eurypylous" has been given, and we may include in it cases where there is only a single prosopyle, and perhaps even a short, narrow inhalant canal. In more advanced forms the water is discharged from each chamber through a narrow exhalant canaliculus (aphodus) peculiar to itself, and thence into wider canals. This is known as the "aphodal" type (e.g. *Cydonium*, fig. 21). In the "diploidal" type there is a special inhalant canaliculus (prosodus) as well as a special aphodus to each chamber, with usually, at any rate, only a single prosopyle (e.g. *Corticium*, fig. 22). The progress from the eurypylous to the diploidal condition is accompanied by a corresponding increase in the development of the mesogloea, whereby the canals are greatly restricted in diameter, and at the same time the mesogloea tends to lose its transparent gelatinous character and to become compact and granular.

With the growth of the ectosome we necessarily get a corresponding development of the proximal portion of the inhalant canal-system. At first the ectosome is merely a thin membrane, the *dermal membrane*, pierced by the inhalant pores, which are usually arranged in groups. Beneath the groups of pores (pore-areas) lie spacious *subdermal cavities* which form the commencement of the inhalant canal-system in the choanosome.

In more advanced types the ectosome becomes greatly thickened and may be specially strengthened in a variety of ways to form a *cortex*. The inhalant pores now no longer lead directly into the subdermal cavities, but first into a series of cavities lying in the cortex and known as *chones*, which may be separated from the underlying subdermal cavities (sub-cortical crypts) by definite sphincters (*Cydonium*, fig. 23).

The arrangement of the oscula and pores on the surface of the sponge varies greatly in different types, and sometimes gives rise to very striking modifications of the external form. The oscula or vents are usually relatively large openings situated on the more prominent parts of the sponge, often on special elevations. Occasionally they are replaced by sieve-like oscular areas (e.g. *Geodia perarmata*), a modification which doubtless serves to prevent foreign bodies from entering the wide exhalant canals. The inhalant pores may be irregularly scattered over the surface of the sponge or collected in more or less well-defined pore-areas. In cup-shaped sponges the pores are usually confined to the outer and the oscula to the inner surface. In flabellate sponges we find pores on one side and oscula on the other. In *Tedania actiniformis*, a deep-sea form, the pores are restricted to a narrow band surrounding the columnar body of the sponge just beneath the flattened top, which bears the vents; thus they are kept from being choked up by the soft ooze on which the sponge lies. In *Xenospongia*, a flattened discoid form, they are confined to narrow grooves on the upper surface, the chief of which run round the margin of the disk. In *Esperella murrayi* the pores are also confined to special grooves on the surface of the sponge, and in both these cases the grooves can apparently be opened and closed by special bands of muscle-fibres, and the supply of water thus regulated. In some species of *Latrunculia* we find the surface of the sponge covered with

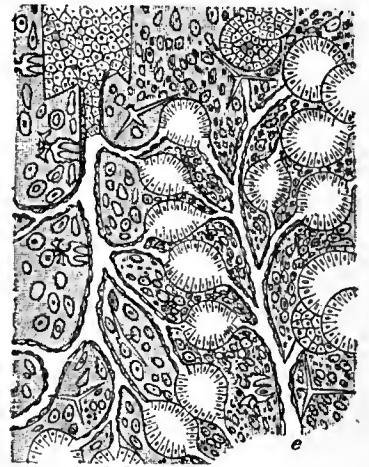

(After F. E. Schulze.)

FIG. 22.—Part of a section of *Corticium candeiabrum*, O.S., showing diploidal type of canal-system. The canal shown on the left is inhalant and that on the right (*e*) exhalant.

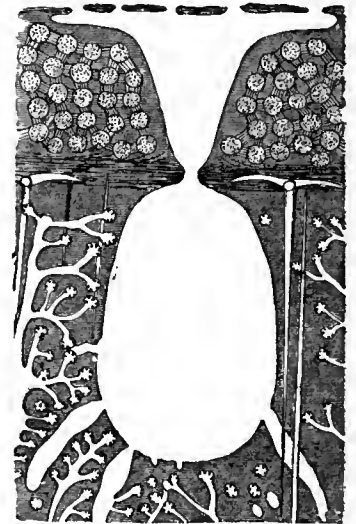

(After Sollas.)

FIG. 23.—Section through the cortex and part of the choanosome of *Cydonium eosaster* (Sollas), showing a pore-sieve and underlying chone in the cortex. The chone communicates below with a subcortical crypt, from which the inhalant canals originate. The cortex contains numerous sterrasters, connected with one another by fibrous bands.

or collected in more or less well-defined pore-areas. In cup-shaped sponges the pores are usually confined to the outer and the oscula to the inner surface. In flabellate sponges we find pores on one side and oscula on the other. In *Tedania actiniformis*, a deep-sea form, the pores are restricted to a narrow band surrounding the columnar body of the sponge just beneath the flattened top, which bears the vents; thus they are kept from being choked up by the soft ooze on which the sponge lies. In *Xenospongia*, a flattened discoid form, they are confined to narrow grooves on the upper surface, the chief of which run round the margin of the disk. In *Esperella murrayi* the pores are also confined to special grooves on the surface of the sponge, and in both these cases the grooves can apparently be opened and closed by special bands of muscle-fibres, and the supply of water thus regulated. In some species of *Latrunculia* we find the surface of the sponge covered with

conspicuous projections of two kinds, some conical and bearing each a single vent, others truncated at the top and bearing the inhalant pores.

Skeleton.—The original ancestral form (*Protolynthus*) from which all the Porifera are supposed to be descended, probably possessed no proper skeleton at all, and this condition has been retained in the existing Myxospongida, although these sponges have made considerable progress in the evolution of their canal-system. There appears to be little doubt that the Myxospongida are *primitively* devoid of skeleton, and in this respect they must be carefully distinguished from the genus *Chondrosia*, in which the skeleton has been secondarily suppressed, as well as from numerous and diverse species in which the proper skeleton has been more or less completely replaced by grains of sand or other foreign bodies. The Calcarea, Triaxonida, Tetraxonida and Euceratosa, except in cases of extreme degeneration, all possess a well-developed proper skeleton. As this skeleton has been independently evolved in each of these great groups it is necessary to deal with it separately in each case.

Calcarea.—The skeleton in this group is composed of spicules of crystalline carbonate of lime (usually calcite), developed within special mother-cells or scleroblasts. Each spicule is enclosed in a delicate membranous spicule-sheath and contains an axial thread of organic matter. Three main types of calcareous spicule are met with, triradiate, quadriradiate and monaxon (fig. 24). The triradiates and quadriradiates, however, are not simple spicules, but spicule-systems formed of three or four rays each originating independently from its own scleroblast (actinoblast) and all uniting together secondarily. There is reason to believe that this may also sometimes be the case with the monaxon or oxeate spicules. In the most primitive triradiate spicules all three rays lie in the

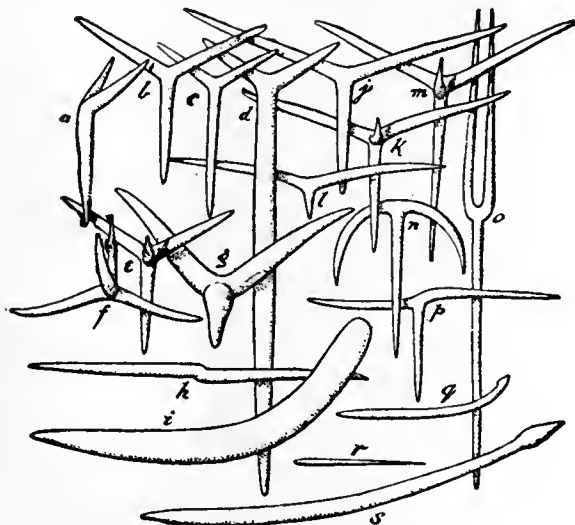

(After E. A. Minchin. From Lankester's *Treatise on Zoology*.)
FIG. 24.—Spicules of Calcareous Sponges.

same plane. Three chief varieties may be distinguished: (1) Regular (fig. 24, *b*), with all the rays and all the angles equal; (2) Sagittal (fig. 24, *c*, *d*, *l*, &c.), with two of the rays or two of the angles forming a pair, differentiated in some respect from the remaining ray or angle, the paired rays being termed "oral" and the odd ray "basal"; (3) Irregular (fig. 24, *p*), when conforming to neither of the above types. It has been proposed to draw a very sharp distinction between "equi-angular" triradiates and "alate" forms (in which the angle between the oral rays differs from the paired angles), but it may be doubted whether such a distinction has any great value. The quadriradiate (fig. 24, *e*, *f*, *k*, *m*) is formed by the addition of an "apical" or "gastral" ray to the three "facial" rays of the triradiate; this ray lies in a plane at right angles to that of the facial rays. The monaxon spicules (fig. 24, *h*, *i*, *g*, *r*, *s*) are straight or curved and the two ends are usually more or less sharply differentiated from one another. In all these spicules the form and arrangement of the rays is usually clearly correlated with their position in the sponge in such a manner that they are specially adapted for the work which they have to do.

The arrangement of the spicules in the case of the genus *Leucosolenia* has been dealt with above, and we must pass on at once to the Calcarea Heterocoela. In this group the skeleton exhibits an evolutionary series no less remarkable than that of the canal-system. We may take as a convenient starting-point the genus *Syceta*, a typical Syconoid form, with the flagellated chambers radiating independently from the central gastral cavity. The wall of the gastral cavity is supported by a gastral skeleton of triradiate or

quadriradiate spicules. These may be sagittal, in which case the oral rays are turned towards the osculum while the basal ray is directed downwards. If there is an apical ray it projects into the gastral cavity. The walls of the radial chambers are supported by a special "tubar" skeleton (cf. fig. 14), consisting exclusively of

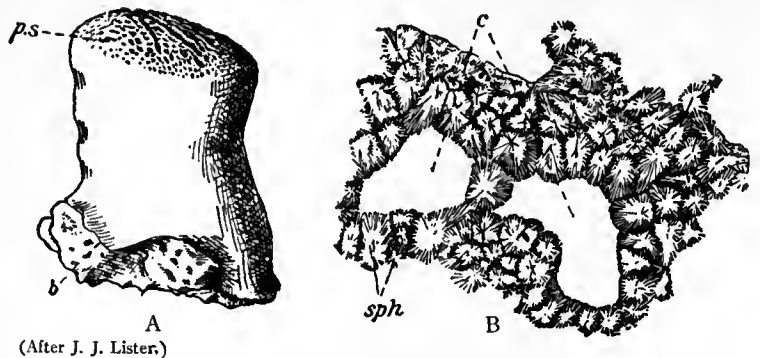

(After J. J. Lister.)

FIG. 25.—*Astroclera willeyana* (Lister).

- A, Entire sponge (x 3): *p.s.*, upper surface with openings of canal-system; *b*, base of attachment.
B, Section of skeleton: *sph*, spherules of arragonite; *c*, canals.

triradiates with their basal rays directed towards the distal end of each chamber. The oral rays are spread out at right angles to the length of the chamber, and as several spicules generally lie at the same level the tubar skeleton forms a series of more or less definite joints and is said to be "articulate." This type of skeleton is almost invariably associated with the Syconoid type of canal-system. In the genus *Sycon* itself we find the distal ends of the chambers specially protected by tufts of monaxon spicules (fig. 14), but the next great advance in the evolution of the skeleton is brought about by the development of a dermal cortex, in which a special dermal skeleton is developed. This is well seen in the genus *Ute* (fig. 15). After this the skeleton of the chamber layer in the sponge-wall begins to undergo modifications, some of which are obviously correlated with the gradual change of the canal-system from the Syconoid to the Leuconoid condition (cf. figs. 16 and 17). Finally all trace of the articulate tubar skeleton is lost, and we get a "parenchymal" skeleton of scattered radiate spicules in the chamber layer. The skeleton of the chamber layer, no matter what the type of canal-system, may be supplemented by large subdermal sagittal triradiates or subdermal quadriradiates (fig. 17), whose basal or apical rays project inwards from the dermal cortex (Heteropidae and Amphoriscidae). Very generally a special "ocular" skeleton is developed in the form of a fringe of long monaxon spicules around the vent.

Various aberrant types of skeleton are met with in the group. In the genus *Lelapia* we find a partly fibrous skeleton, in which the fibres are composed of bundles of triradiates shaped like tuning-forks (fig. 24, *o*), and in *Petrostoma* the main skeleton is formed of calcareous spicules actually fused together. In *Astroclera* (fig. 25) a very anomalous type of calcareous skeleton is found, consisting of spherulic masses of arragonite, each originating in a special scleroblast and having a radiate structure, recalling that of a siliceous

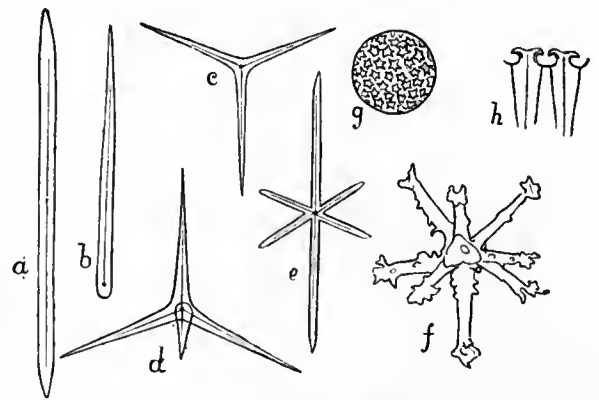

(After W. J. Sollas.)

FIG. 26.—Typical Siliceous Megascleres.

- a*, Diactinal monaxon (oxeate). *g*, Sterraster (often regarded as a microsclere).
b, Style. *h*, Part of section of sterraster, showing two rays united by intervening silica.
c, Triact.
d, Primitive tetraxon (calthrops).
e, Hexact.
f, Polyaxon desma.

sterraster. These bodies become closely packed together over large areas, and give the sponge a stony hardness.

Hexactinellida.—In this group the skeleton is composed of spicules of colloidal silica deposited in concentric lamellae around slender axes of an organic substance which in life occupies the "axial canal" of the spicule. Although varying greatly in detail and often exhibiting great complication or, it may be, reduction in structure, these spicules are all referable to the same fundamental triaxonid and hexactinellid type, characterized by the possession of three axes intersecting each other at right angles and each thereby divided into two rays or actines (fig. 26, e). According as one, two, three, four or five of these actines are suppressed we distinguish between pentact, tetract, triact, diact and monact spicules, and these may be further subdivided according to special modifications of the rays due to secondary branching, ornamentation by spines,



(After F. E. Schulze.)

FIG. 27.—Derivatives of the Hexact type of Spicule, found in Hexactinellida.

- a, Dagger. d, Amphidisc. f, Tetract (staurus).
b, c, Pinuli. e, Pentact. g, Diact (rhabdus).

knobs, &c., or curvature, or to excessive development of certain rays as compared with the remainder. Some of the most characteristic of these special types are represented in figs. 27 and 28. Two of them require special notice on account of their importance in the classification of the group. These are the *hexaster* and the



(After F. E. Schulze.)

FIG. 28.—Derivatives of the Hexact type of Spicule, found in Hexactinellida.

- a, Uncinaria; b, Clavula; c, Scopula.

amphidisc. A hexaster (=rosette) is a perfectly symmetrical hexact whose actines branch out into secondary or terminal rays, in a star-like manner (fig. 30, b). Various sub-types are distinguished according to the character of the rays (*floricome*, *plumicome*, &c.). An amphidisc (fig. 27, d) is a diact spicule consisting of two opposite rays each of which terminates in a disk-like or spherical expansion surrounded by marginal teeth.

In some cases the spicules all remain disconnected from one another (Lyssacine condition), in others some of them may be united by siliceous cement into a continuous framework (Dictyonine condition), and the distinction between these two types of arrangement was for a long time regarded as indicating a primary subdivision of the Hexactinellida into Lyssacina and Dictyonina, but this subdivision has now been abandoned. The term *prostalia* is applied to spicules which project freely from the surface of the sponge, and these are further distinguished as *basalia*, *pleuralia* and *marginalia*, according to their position at the base of the sponge, on the sides, or round the margin of the osculum. The basalia frequently form a root-tuft for attaching the sponge to the substratum (*Hyalonema*, *Euplectella*) and commonly have anchor-like distal extremities. They may be extremely long, as in the well-known "glass-ropes" of *Hyalonema*. In the remarkable genus *Monorhaphis* we find a single gigantic diact spicule, which may attain a length of two or three feet and the thickness of a lead pencil, transfixing the body of the sponge like a skewer from above downwards. A special dermal skeleton is usually formed by a number of spicules distinguished as *dermalia*, and a gastral skeleton may be similarly formed by special *gastralia* surrounding the central gastral cavity. Between the dermal and gastral skeletons another set of spicules, known as *parenchymalia*, form the most important part of the skeleton, supporting the chamber-layer and adjacent tissues. The distinction into large *megascleres* and small *microscleres* is perhaps less well marked in this group than in the Tetraxonida.

Tetraxonida.—Here, again, the spicules are composed of colloidal silica deposited around organic axial threads. The starting-point in the evolution of the very complex series of tetraxonid spicules is the primitive tetract or calthrops, characteristic of the most primitive members of the group (e.g. *Plakina*). This fundamental ground-form (fig. 26, d) consists of four rays or actines of equal length, which all meet one another at equal angles in the centre of the spicule, while their apices would occupy the four angles of a regular pyramid whose sides are four equilateral triangles. It is thus both *tetraxonid* (with four axes) and *tetractinellid* (with four rays). In *Plakina* the spicules are all of about the same size, neither very large nor very small, but in higher forms we usually

find some of the spicules enlarged to form megascleres and others reduced to form microscleres. The megascleres play the principal part in building up the skeleton while the microscleres are usually scattered through the mesogloea.

Triaxene Series of Megascleres.—When three rays (cladi) of the tetract resemble one another, while the fourth (shaft) differs in some respect the spicule is termed a *triaene*. The simplest form is the *plagiotriaene* (fig. 29, 2), with three short simple cladi and an elongated shaft.

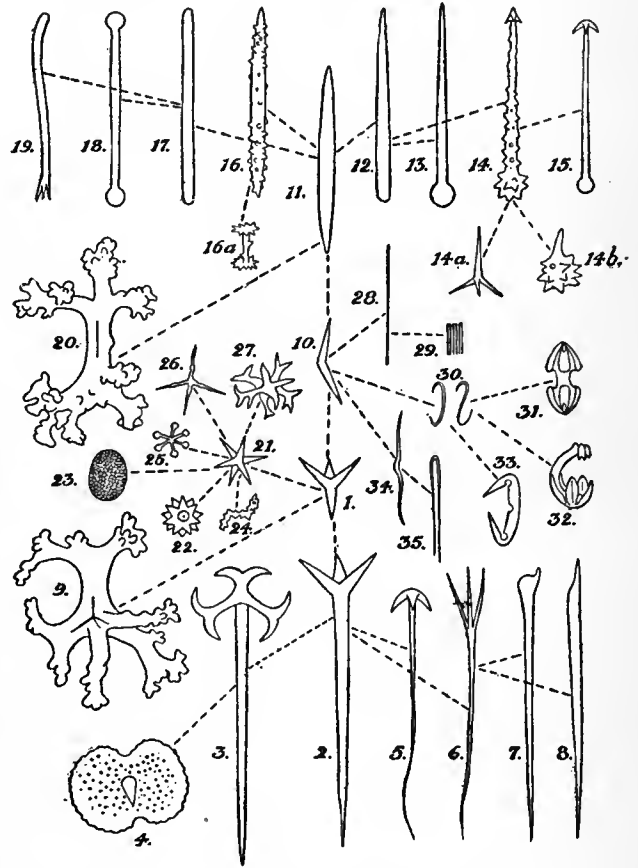

FIG. 29.—The Tetraxon type of Spicule and its derivatives, found in Tetraxonida.

- | | | |
|--|--------------------------------------|--------------------------------|
| 1, Primitive tetract. | 14a, 14b, Pseudasters. | 25, Chiaster. |
| 2, Plagiotriaene. | 15, Cladotylole. | 26, Oxyaster. |
| 3, Dichotriaene. | 16, Acanthoxcate. | 27, Aster with branching rays. |
| 4, Discotriaene. | 16a, Pseudaster (amphidisc). | 28, Rhaphis or trichite. |
| 5, Anatriaene. | | 29, Trichodragma. |
| 6, Prottriaene. | 17, Strongyle. | 30, Sigmata. |
| 7, 8, Reduced triaxenes, becoming monaxon. | 18, Tylote. | 31, Isochela. |
| 9, Tetracrepid desma. | 19, Cladostongyle. | 32, Anisochela. |
| 10, Primitive diact. | 20, Rhabdocrepid (monocrepid) desma. | 33, Diancistron. |
| 11, Oxate. | 21, Aster. | 34, Toxon. |
| 12, Style. | 22, Spheraster. | 35, Labis (forcipiform). |
| 13, Tylostyle. | 23, Sterraster. | |
| 14, Acanthotylostyle. | 24, Spiraster. | |

gated shaft, the angles all remaining approximately equal. If the angles between the cladi and shaft become approximately right angles we have an *orthotriaene*. If the cladi point forward, we have a *prottriaene* (fig. 29, 6). If the cladi are turned backwards towards the shaft we have an *anatriaene* (fig. 29, 5). If the cladi branch each into two we have a *dichotriaene* (fig. 29, 3). If the cladi are expanded laterally and fused together to form a plate, while the shaft is reduced, we have a *discotriaene* (fig. 29, 4). The cladi may be reduced in size or even suppressed (fig. 29, 7, 8), leaving only the shaft, which may be either sharp at each end (*oxate*) or sharp at the apex and rounded at the base (*tylote*). The spicule has now become monaxonid or monaxonellid (i.e. with a single axis) and monactinellid (with only a single ray); but this condition may also be arrived at in a different way, as we shall see directly.

The *tetracrepid desma* (fig. 29, 9), characteristic of many Lithistids, has been derived from the primitive tetract by ramification of the ends of all the rays.

Monaxonid Series of Megascleres.—We have already seen, in *Plakina*, how a diactinellid spicule may arise by suppression of two rays of the tetract (fig. 5). At first the two remaining axes

are distinctly indicated by the presence of an angle in the middle of the spicule (fig. 29, 10); by straightening out of this angle we reach a monaxonid but diactinellid condition—the diactinellid oxeate, with the organic centre of the spicule in the middle (fig. 29, 11). By rounding off of both ends this form passes into the *strongylote* (fig. 29, 17), then if both ends become enlarged into knobs it is said to be *tylote* (fig. 29, 18). If one end only is rounded off, which apparently usually takes place by suppression of one ray, while the other remains sharp, the spicule is termed *stylote* (fig. 29, 12). It is now monactinellid as well as monaxonid. If the blunt end of the style enlarges to form a knob we have the *tylostyle* (fig. 29, 13). *Acanthoxeates* (fig. 29, 16), *acanthostyles* and *acanthotylostyles* (fig. 29, 14) are formed by the development of spines on the surface of the spicule. The development of large recurved spines at the apex of a tylostyle gives us the *cladotylole* or grapple spicule (fig. 29, 15), which simulates an anatriaene. By enlargement of the spiny base of an acanthotylostyle and suppression of the shaft we get forms which simulate astrose microscleres and may be called *pseudasters* (fig. 29, 14a, 14b). Pseudasters may also be developed by shortening up of acanthoxeates, accompanied by enlargement of the spines (e.g. *Spongillinae*, fig. 29, 16a). The *exotyle* appears to have been formed by enlargement of the outer end of a radially placed oxeate at the surface of the sponge. By ramification of both ends of a diactinal megasclere we get the *monocrepid desma* (fig. 29, 20), characteristic of certain Lithistids and closely simulating the tetracrepid desma. By ramification of one end of a strongylote spicule we may get a *cladostrongyle* (fig. 29, 19).

Diactinal Series of Microscleres.—The starting-point of this series is the primitive angulate, diactinal oxeate (fig. 29, 10). This has given rise to long hair-like forms or *rhaphides* (fig. 29, 28), short hair-like forms associated in bundles and called *trichodragmata* (fig. 29, 29), bow-shaped forms or *toxa* (fig. 29, 34), and C- and S-shaped forms or *sigmata* (fig. 29, 30). From the *sigmata* may be

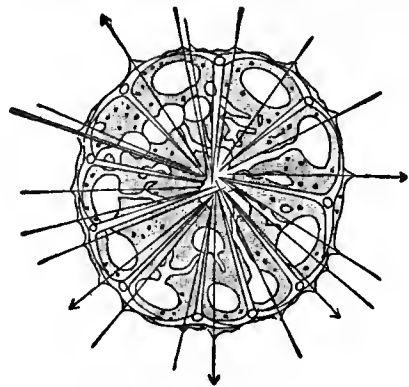

(After W. J. Sollas.)

FIG. 31.—Section of a young Stellettid Sponge, showing radial arrangement of skeleton.

initiated by the development of the triaenes. The cladi of these spicules are commonly extended in or beneath the ectosome and form a very efficient dermal skeleton, while the shafts are directed centripetally through the choanosome. In the genus *Discodermia* the discotriaenes form a continuous dermal armour of siliceous plates. When anatriaenes and protriaenes are developed their cladi commonly project beyond the surface of the sponge and render it more or less strongly hispid, thus forming a protection from the attacks of enemies. The shafts of the triaenes, though greatly reduced in *Discodermia*, usually become very much hypertrophied and may be grouped together in bundles, often associated with oxeate spicules. These spicules, or bundles of spicules, now form the principal part of the skeleton, and inasmuch as they radiate from the interior towards the surface of the sponge we distinguish this as the radiate type of skeleton. The skeleton of the vast majority of Tetraxonida is either actually radiate in structure or derived from the radiate type by further modification. In many Stellettidae, for example (fig. 31), we have a typical radiate skeleton in which a large number of the spicules retain the primitive tetractinellid form, though associated with oxeates, while in *Tethya* the skeleton is arranged in a similar manner but only monaxonid spicules are present. From the radiate we pass to the reticulate type of

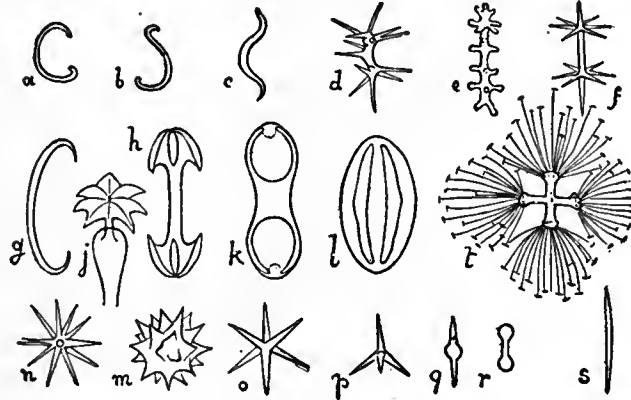

(After Sollas.)

FIG. 30.—Typical Microscleres.

- a, b, *Sigmata* (sigmaspires).
- c, *Toxon*.
- d, *Spiraster*.
- e, *Sanidaster*.
- f, *Amphiaster*.
- g, *Sigma*.
- h, k, *Isochelae*.
- j, End of a chela, showing the teeth.
- l, Modified isochela of *Melonanchora*.
- m, *Spheraster*.
- n, o, p, *Oxyasters*.
- q, r, Reduced asters.
- s, *Microxeate*.
- t, *Hexaster* (rosette).

derived the *diancistra* (fig. 29, 33), shaped like pocket-knives with a blade half open at each end, and the wonderful series of *chelae* (fig. 29, 31, 32), in which each end branches into a number of sharply recurved teeth. These chelae are characteristic of the family *Desmacidonidae*, and exhibit great variations in detail, while each particular form is remarkably constant in the species in which it occurs. The most curious and aberrant are those of *Melonanchora* (fig. 30, l) and *Guilarrua*. In *isochelae* the two ends of the spicule are equal, in *anisochelae* they are unequal.

Astrose or Polyactinal Series of Microscleres.—For the beginning of this series we must go back to the primitive tetract. Reduction in size, sometimes accompanied by increase in the number of rays, has given rise to the *oxyaster* (fig. 29, 26), with sharp rays and no conspicuous centrum. The development of a distinct centrum from which numerous rays come off gives us the *spheraster* (fig. 29, 22). In the *sterraster* (fig. 26, g, h), characteristic of the family *Geodiidae*, numerous slender rays become fused together side by side to form a solid ball. In the *spiraster* (fig. 29, 24) the centrum appears to have become elongated and twisted into a spiral. The rays of the aster may terminate in knobs as in the *chiaster* (fig. 29, 25), or they may become branched (fig. 29, 27).

Arrangement of the Skeleton in the Tetraxonida.—The most primitive type of skeleton arrangement in this group was probably very similar to that which we still find in *Plakina* or *Dercitopsis*, but

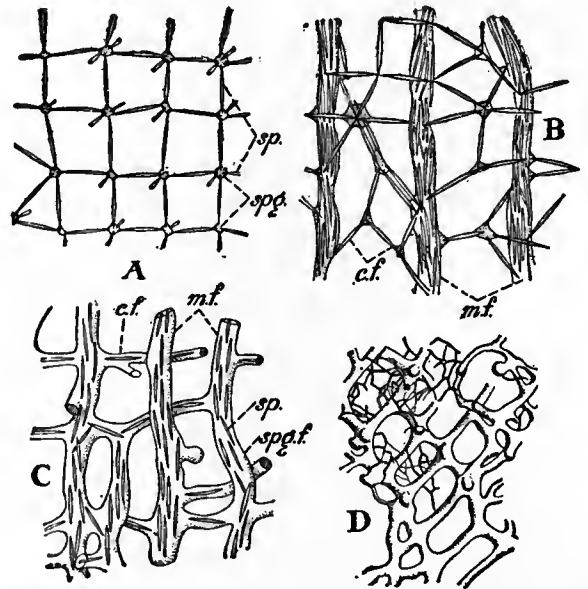

(After Miachin and Dendy. A, B, C from Lankester's *Treatise on Zoology*, D from *Trans. of Zool. Soc. of London*, vol. xii.)

FIG. 32.—Evolution of the Pseudoceratose Reticulate type of Skeleton, as seen in A, *Reniera*; B, *Pachychalina*; C, *Chatina*; D, *Spinosella plicifera*.
sp, Spicules; spg., Spongin; m.f., Primary fibres; c.f., Secondary (connecting) fibres.

skeleton which characterizes the majority of the so-called Monaxonellida. This is derived from the former by the establishment of secondary spicule-bundles connecting the primary or radial bundles together, and the transition is usually accompanied by loss of the cladi of the triaenes and by the development of a massive irregular form on the part of the entire sponge. An intermediate condition is found in some of the massive species of *Tetilla* (e.g. *T. limicola*), in which the spicule-bundles are very well defined and form distinct primary "fibres" in the interior of the sponge, but no distinct secondary or connecting fibres are yet developed.



(After Lendenfeld. Modified from Lendenfeld's *Horny Sponges*, by permission of the Royal Society of London.)

FIG. 33.—Dendritic, Euceratose Skeleton of *Dendrilla rosea*.

In the Sigmatomonaxonellida, derived from the Tetillidae, the reticulate type of skeleton is almost universal, and in this group an entirely new element is introduced into the skeleton with the development of a "horny" cementing material (spongine) which unites the spicules together in the fibres. At first small in quantity (*Reniera*, fig. 32, A), the spongine cement gradually increases in proportion to the spicules until in many Chalininae (fig. 32, B, C) and *Desmacidonidae* the spicules become completely embedded in it, and the fibres may be formed chiefly of spongine, with only a core of spicules. The complete enclosure of the spicules by spongine at a very early stage cuts off their food supply and causes arrest of development. Finally, in some Chalininae (fig. 32, D) and *Desmacidonidae* the spicules entirely disappear from the interior of the fibre, and if at the same time they happen to be absent from the intervening mesogloea we get a skeleton composed exclusively of horny matter or spongine, to which the term *pseudoceratose* may be applied. In the sub-family *Ectyoninae* the skeleton becomes modified in an interesting manner by the development of "echinating" spicules, usually acanthostyles or acanthotylostyles, whose bases are cemented on to the fibre by spongine while their apices project into the surrounding soft tissues. These doubtless serve as a defence against internal parasites. In *Agelas* these echinating spicules may persist after the spicules have entirely disappeared from the interior of the strongly developed horny fibre. In the Axinellidae all the spicules in the fibres are typically more or less echinating in character and the fibres become plumelike.

Very frequently a special dermal skeleton is developed in the ectosome altogether distinct from that formed by the cladi of the triaenes (when these are present). Thus in the Geodiidae (fig. 23) the thick cortex is almost filled with densely packed sterrasters. In many forms there is a dense layer of small radially arranged monaxons at the surface of the sponge, whose projecting apices form an efficient protection. In the reticulate forms the ectosome is usually a thin dermal membrane supported by a reticulate dermal skeleton of slightly different structure from the "main" skeleton. In cases where a special stalk or a root-tuft is developed we also find a special and appropriate skeleton in connexion therewith.

In the so-called Lithistida alone amongst the Tetraxonida do we find the spicules (desmas) united together by silica to form a coherent skeleton, sometimes of stony hardness, very different from the elastic, flexible skeleton resulting from the development of spongine, and analogous to the condition met with in the Dictyonine Hexactinellids.

The microscleres usually play quite a subordinate part in the formation of the skeleton, being scattered irregularly throughout the mesogloea, though sometimes (*Geodia*, *Tethya*) the asters may form a definite cortical layer.

Euceratosa.—In the true horny sponges, if we neglect for the moment the presence of foreign bodies, we may say that the skeleton consists from the first exclusively of spongine, secreted (by special

spongoblasts) in concentric layers to form very well defined fibres. In the most primitive forms (*Aplysillidae*) this horny skeleton is dendritic in arrangement (fig. 33), composed of fibres which rise vertically upwards from the base of the sponge (where they may be expanded to form a horny basal cuticle which serves for attachment) and ramify towards the surface, where their apices push against the dermal membrane and cause it to project in the form of "conuli." No reticulation is formed in the simplest cases (*Aplysilla*, *Dendrilla*), but in *Megalopastus* secondary connecting fibres are established (in relation, doubtless, to the increase in size and massive form of the sponge), and the skeleton thus simulates the pseudoceratose reticulate type of the Sigmatomonaxonellida. In *Darwinella* we have, in addition to the dendritic skeleton, isolated "spicules" of spongine scattered irregularly through the mesogloea. The presence of these spicules, which are sometimes, though by no means always, hexactinellid in form, has given rise to much speculation as to the possible relationship of the *Aplysillidae* to the siliceous Hexactinellida. Until we know more about their origin, however, we may perhaps best regard them simply as detached portions of the general skeleton secreted by isolated groups of spongoblasts. The genus *Megalopastus* forms a natural transition to the Spongeliidae, in which the reticulation of the horny skeleton is an almost constant feature, and in which the tendency to supplement or replace the spongine by foreign bodies (sand, broken spicules) is very strongly marked. In extreme cases the skeleton is composed almost exclusively of sand (e.g. *Psammopemma*), and the whole sponge looks like a mass of sand stuck together by a minimum of soft tissues and spongine cement. Such "arenaceous" sponges also occur in other groups (e.g. *Desmacidonidae*). The culminating point in the development of the true horny skeleton is found in the Spongeliidae (e.g. *Euspongia*), but even in the bath sponge (fig. 6) we commonly find sand grains or other foreign matter in the interior of the primary fibres. The value of the sponge for domestic purposes depends upon the softness and elasticity of the fibre, the closeness of the meshes, and the relative absence of sand.

Histology.

There are two primary tissue-forms in sponges, the flat pavement epithelium and the epithelium composed of choanocytes or collared cells. The former covers the whole of the external surface of the sponge and, except in the simpler *Calcarea Homocoela*, it also lines a considerable portion of the canal-system. The latter lines practically the whole of the primitive gastral cavity in the *Calcarea Homocoela*, but in all higher types becomes restricted to well-defined "flagellated chambers." A gelatinous "mesogloea," which must be regarded primarily as an intercellular substance, appears between the primitive outer and inner layers of the sponge-wall. This contains primitive amoeboid wandering cells (archaeocytes),

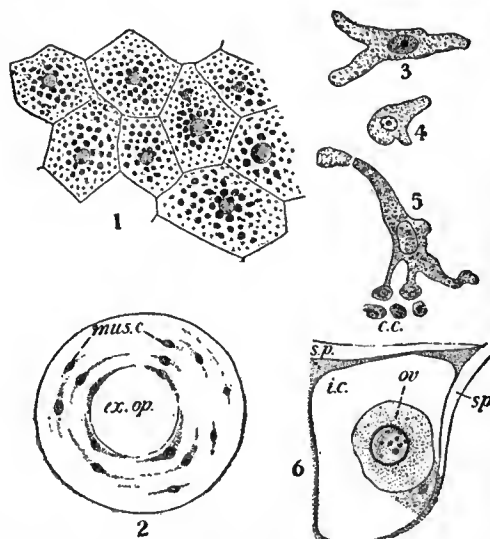

(After Dendy. From *Quart. Journ. Micro. Science*, new series, vol. xxxv., by permission of J. and A. Churchill.)

FIG. 34.—Histology.

- 1, Pavement epithelium from the upper surface of an oscular diaphragm of *Vosmaeropsis wilsoni*.
- 2, Chamber diaphragm of *Vermaeropsis macera*; *mus.c.*, Myocytes; *ex.op.*, Exhalant aperture of flagellated chamber.
- 3, 4, 5, Amoebocytes of *Leucandra philippensis* (the one shown in 5 appears to be feeding by means of pseudopodia upon the collared cells (*c.c.*) of a flagellated chamber).
- 6, Section across an inhalant canal (*i.c.*) of *Ute syconoides*, showing an ovum (*ov.*) suspended from the wall, apparently awaiting fertilization; *sp.*, spicules.

which give rise to the ova and spermatozoa, and also various other cells which are now generally believed to migrate into it from the primitive pavement epithelium (dermal epithelium) of the outer surface, such as scleroblasts, various connective tissue elements and contractile fibres.

Pavement Epithelium (fig. 34, 1).—This always consists of a single layer of polygonal cells, which are usually flat and very rarely (*Oscarella*) provided with cilia or flagella. They may be glandular and may secrete a definite cuticle (as in many Euceratosa). They may also be highly contractile.

Porocytes.—In certain Calcareous sponges (*Leucosolenia*) it has been shown (by E. A. Minchin) that the primitive inhalant pores (prosopyles) are formed as perforations in certain of the pavement epithelium cells, which acquire a tubular form and extend through the mesogloea from the dermal to the gastral surface. The outer portion of each porocyte forms a contractile diaphragm which doubtless regulates the admission of water to the gastral cavity. The porocytes are sometimes conspicuous on account of their highly granular character.

Scleroblasts.—We may distinguish three kinds of scleroblasts, according to the chemical character of the skeletal material which they secrete; these are *calcioblasts*, *silicoblasts* and *spongoblasts*. The calcioblasts and silicoblasts (fig. 35, *h-n*) form their respective spicules, at any rate in the first instance, as intra-cellular (perhaps sometimes intra-syncytial) secretions, though we must suppose

that in the case of large spicules the later stages in growth are accomplished by the activity of several or many scleroblasts in co-operation. The spongoblasts (fig. 7) appear to co-operate with one another in the formation of the spongin fibre from the beginning. They are found only around the young, growing fibres, where they occur in large numbers, forming a kind of sheath of somewhat flask-shaped cells, each placed at right angles to the surface of the fibre and with the nucleus in its broad distal end. The spongin is secreted in concentric lamellae and is obviously intercellular in origin, and probably of the same nature as the cuticle which often occurs on the surface of the sponge.

Connective-tissue Elements.—The following are the chief forms assumed by the mesogloea according to the nature of its connective-tissue cells and intercellular substance. (a) *Collenchyme*, consisting of a clear gelatinous matrix with branching stellate *collencytes* (fig. 35, *a*) embedded in it; (b) *Sarcenchyme*, in which the quantity of intercellular matrix is greatly reduced and the connective-tissue cells are closely packed together; (c) *Cystenenchyme* (fig. 7, *Coll*, fig. 35, *c*), consisting of close-packed, oval, vesicular cells with fluid contents and strands of protoplasm radiating from the nucleus to the periphery; (d) *Chondrenchyme* (fig. 35, *b*), somewhat resembling cartilage in texture and with a very large amount of intercellular matrix.

The name *desmacytes* has been given to certain slender connective-tissue fibres (fig. 35, *d*) often united in dense bundles or layers, which occur especially in the ectosome of many Tetraxonida, giving rise to a fibrous cortex of leathery consistence.

Contractile Fibres.—Muscular fibres or *myocytes* (fig. 35, *e*) are of common occurrence, especially in relation to various parts of the canal-system, the diameter of which appears to be regulated by their agency. They may form definite sphincters around the vents or in other places (fig. 34, 2), or they may form transverse bands lying in the floor of pore-bearing grooves, by the contraction of which the lips of the groove are doubtless approximated and the incurrent stream of water shut off (*Esperella murrayi*, *Xenospongia patelliformis*).

Endothelial Cells.—In many sponges the developing embryos are enclosed in definite capsules composed of flattened polygonal cells, the whole being embedded in the mesogloea. The origin of the endothelial cells forming the capsules is doubtful. They sometimes aid in the nutrition of the developing embryo (e.g. in *Stelospongia flabelliformis*).

No nervous elements, nor sensory cells of any kind, have as yet been recognized with any degree of certainty in sponges, in spite of various heroic attempts to demonstrate their existence.

Collared Cells or Choanocytes (fig. 35, *g*).—These are quite the most characteristic histological elements met with in sponges. Although exhibiting various minor differences in structure, and still more as regards size, they always show the same essential features. Each consists usually of an oval or rounded body (frequently appearing polygonal from the pressure of its fellows) surmounted by a more or less cylindrical or funnel-shaped collar, which surrounds a single long, whip-like flagellum projecting from the apex of the cell. The collar is a filmy, transparent extension of the cytoplasm (cell-protoplasm), which can be completely withdrawn. The flagellum may also be withdrawn, and in preserved specimens neither collar nor flagellum is usually visible. The cell is usually broadest at the base and narrowed to form a neck or "collum," beneath the collar. The nucleus may be situated either at the base or at the apex of the cell-body or between the two. The collar itself is often a more complicated structure than appears at first sight. It

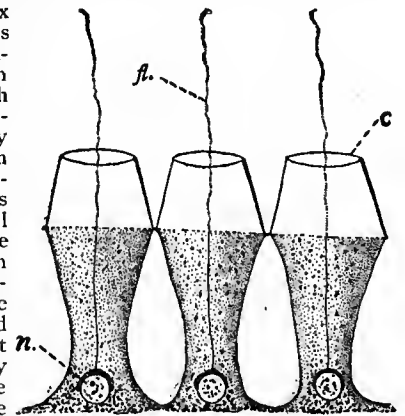

(After F. E. Schulze.)

FIG. 36.—Collared Cells of *Schaudinnia arctica*.
n, Nucleus; *fl*, Flagellum; *c*, Collar.

In many cases the collars of adjacent choanocytes have been observed to be connected by a definite membrane which stretches from one to the other at the level of their margins. This is known as *Sollas's membrane*, but it is apparently not a permanent structure, and the circumstances under which it appears require elucidation. In the Hexactinellida the form of the collared cells appears to be somewhat unusual (fig. 36).

Archaeocytes.—The term "archaeocytes" has been applied to certain undifferentiated amoeboid cells which make their appearance at an extremely early stage in the ontogeny, and some of which persist throughout life, with little, if any, modification, as the *amoebocytes* of the adult sponge, while others become germ-cells, differentiated into ova and spermatozoa.

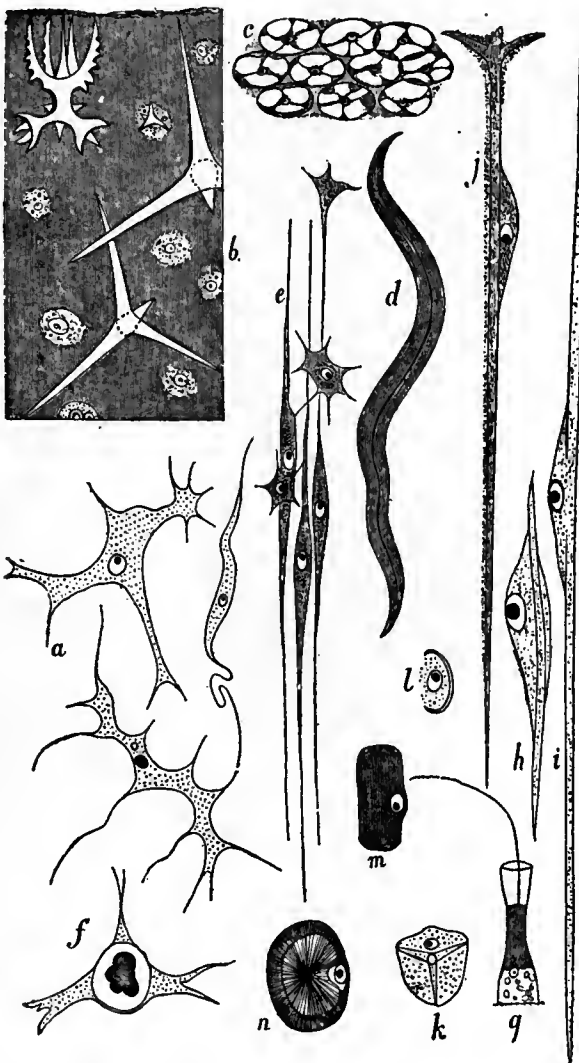

(After Schulze and Sollas.)

FIG. 35.—Histology.

- a*, Collencytes from *Thenea muricata*.
b, Chondrenchyme (with spicules) from *Corticium candelabrum*.
c, Cystenenchyme, from *Pachymatisma johnstoni*.
d, Desmacyte, from *Dragmastra normani*.
e, Myocyte and collencytes, from *Cinachyra barbata*.
f, Thesocyte, from *Thenea muricata*.
g, Collared cell (choanocyte), from *Sycon raphanus*.
h-n, Silicoblasts or mother-cells, in which different forms of siliceous spicules are being secreted.

Amoebocytes.—These are amoeboid cells closely resembling the leucocytes or white blood corpuscles of higher animals. They commonly have blunt, lobose pseudopodia and the cytoplasm is generally more or less densely charged with refractive granules. They have the power of wandering from place to place through the mesogloea (fig. 34, 3-5).

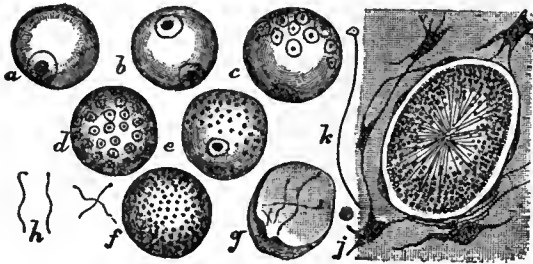

(After Poléjaeff and Schulze.)

FIG. 37.—Spermatozoa.

a-h, Development of Spermatozoa in *Sycon raphanus*; h, Mature Spermatozoa; j, Sperm-ball in Mesogloea of *Oscarella lobularis*; k, Mature Spermatozoan.

Germ-Cells.—The ova (fig. 34, 6) are formed from amoebocytes, which grow to a large size and finally withdraw their pseudopodia and acquire a rounded form. They have large nuclei with a very distinct nuclear membrane and commonly a conspicuous nucleolus. The spermatozoa (fig. 37) closely resemble those of higher animals, consisting each of a small "head," composed chiefly of chromatin material, and a slender vibratile "tail" composed of cytoplasm. In this case the amoebocyte gives rise to a single sperm mother-cell (spermocyte) sometimes enclosed in one or two covering cells. The nucleus of the spermocyte undergoes repeated mitosis and a "sperm-ball" is produced which is either enclosed in the covering cell or in a special endothelium similar to that which surrounds the segmenting ovum. The germ-cells occur scattered through the mesogloea and are not aggregated in gonads, so that we cannot speak of "ovaries" and "testes" as in higher types.

Reproduction.

Reproduction in sponges may be effected in one of three ways: (1) The first is by vegetative budding, followed by separation of the buds and thus differing from the ordinary budding which leads merely to increase in the size of the sponge-colony. This process has been observed in many cases (e.g. *Leucosolema*, *Oscarella*, *Lophocalyx*, *Aplysilla*). (2) The second way is by the formation of specialized reproductive bodies known as *gemmules*. This process is best known in the fresh-water sponges (Spongillinae), where it has been developed as a special means of tiding over unfavourable periods during which the parent sponge is liable to be destroyed by cold or drought. Each gemmule consists of an aggregation of amoeboid cells (statocytes) densely charged with nutrient granules and enclosed in a protective horny envelope which may be strengthened by a layer of special spicules. The ripe gemmule is very resistant to adverse conditions and is capable of remaining dormant for a lengthened period, and of developing into a new sponge on the return of favourable conditions. In temperate climates the gemmules remain dormant throughout the winter and develop in the spring, the development being very similar to that of an ordinary fertilized ovum except that it begins at the "morula" stage, with the numerous statocytes representing the blastomeres. (3) The third way is by the union of ova and spermatozoa to form *zygotes*, which undergo segmentation and develop into the adult through a more or less complex series of ontogenetic stages. Previous to fertilization the ovum undergoes a process of maturation accompanied by the extrusion of two polar bodies, as in higher animals. Very little is known about the actual process of fertilization, but it appears probable that this is effected in the inhalant canals of the parent sponge, where the ova have been observed suspended from the epithelial lining of the canal (e.g. in *Ute*, fig. 34, 6). After fertilization they appear, usually at any rate, to migrate back into the mesogloea, where they become surrounded by endothelial capsules and undergo segmentation. In *Stelospongia flabelliformis* the cells of the capsule are of gigantic size and are attached to the superficial blastomeres of the developing embryo by protoplasmic processes, through which, no doubt, nutriment is passed from the parent to the embryo.

Embryology.

The segmentation of the ovum appears to be in all cases complete or holoblastic, and the young sponge usually leaves the parent in

the form of a free-swimming ciliated larva, which, after fixing itself to some object, undergoes a metamorphosis and then grows into the adult form. The details of development appear to differ widely in different species and various interpretations have been placed upon somewhat limited and discrepant observations.

One of the best-known cases is that of the calcareous genus *Sycon* (fig. 38). The fertilized ova develop into ciliated larvae within the parent sponge, embedded in the walls of the radial chambers, in their endothelial capsules. Each divides first into two, then into four, and then into eight equal and similar blastomeres by successive vertical clefths. The eight-celled stage (fig. 38, b, c,) has the form of a somewhat flattened cushion, with an axial cavity which is the beginning of the blastocoel or segmentation cavity. A horizontal cleft now divides each blastomere into a somewhat smaller upper and a somewhat larger lower portion, and the sixteen blastomeres arrange themselves in the form of a hollow sphere surrounding the blastocoel. The smaller cells multiply rapidly and become columnar, while still remaining as a single layer. Each one presently acquires a flagellum ("cilium") at its outer end. The larger cells multiply more slowly and are characterized by their coarsely granular appearance. They are destined to give rise to the dermal layer and its derivatives (including archaeocytes?) and never become flagellated.¹ The blastosphere or blastula (fig. 38, d, e,) is now complete, the blastocoel being completely surrounded by a single layer of cells differentiated, however, into two groups, gastral and dermal. The large granula (dermal) cells now become invaginated, but this

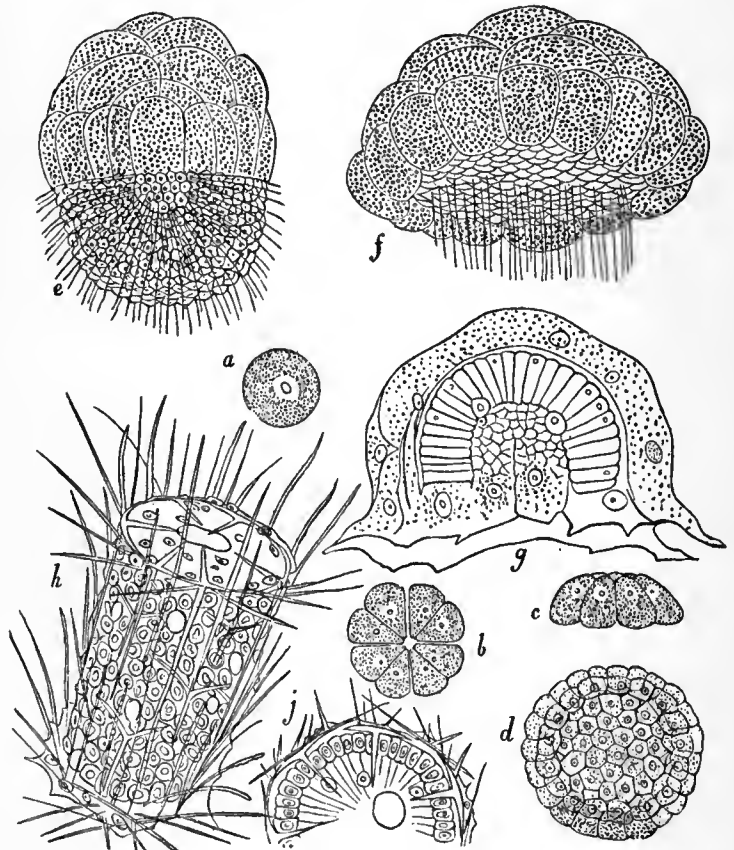

(After F. E. Schulze.)

FIG. 38.—Development of *Sycon raphanus*.

- a, Ovum.
b, c, Embryo with 8 blastomeres (b, top view, c, side view).
d, Blastosphere (blastula).
e, Larva at time of escape from parent.
f, Invagination of flagellated cells.
g, Gastrula attached by oral face.
h, Young sponge (Olynthus stage).
j, Top view of young sponge.

is only a temporary condition, probably to be explained as the mechanical result of the pressure of the spicules of the parent sponge. The so-called "pseudogastrula" thus formed escapes by rupture

¹ According to E. A. Minchin, the first-formed granular cells are "archaeocytes," which migrate into the interior of the larva while their place is taken by granular cells formed by modification of the neighbouring flagellated cells. The later-formed granular cells are destined to give rise to the dermal layer of the adult, while the remaining flagellated cells form the gastral layer.

of the parent tissues into a radial flagellated chamber and passes to the exterior with the outgoing stream of water. The invaginated dermal cells are pushed out again and the "amphiblastula" swims away (fig. 38, e). (Possibly the granular dermal cells, by proliferation, may form a solid mass blocking up the blastocoel completely, so that we have a solid embryo.) The larva now fixes itself by the anterior flagellated pole (which, according to Schulze, becomes permanently invaginated, thus giving rise to a true gastrula, fig. 38, f, g), and the dermal cells spread themselves out over the gastral cells, which they completely cover. The fixed larva ("pupa") consists of a solid mass of gastral cells enclosed in a single layer of now flattened dermal cells. Presently the gastral cavity appears (or reappears) in the middle, around which the gastral cells arrange themselves in a single layer. The young sponge elongates upwards, some of the dermal cells form porocytes which become perforated by prosopyles, others migrate into the gelatinous mesogloea and form scleroblasts, from which spicules are developed. The cells of the gastral layer acquire collars in addition to their flagella, an osculum is formed by perforation at the apex, and the young sponge begins to feed. It is now in the Olynthus condition (fig. 38, h) and is exactly comparable to a simple *Leucosolenia* individual. As it grows older radial flagellated chambers are budded out around the central gastral cavity and the collared cells lining the latter are replaced by pavement-epithelium derived from the dermal layer.

An interesting account of the development of *Leucosolenia* (*Clathrina*) *blanca* has been given by E. A. Minchin. Segmentation is regular and complete, resulting in the formation of a hollow, ciliated, oval blastula (fig. 39, A), with a large blastocoel and a wall composed of a single layer of columnar flagellated cells and a pair of very large granular cells at the posterior pole. The latter are primitive archaeocytes and are destined to give rise to the amoebocytes and germ-cells of the adult. The flagellated cells will give rise to all the other cells of the adult, both dermal and gastral. The larva becomes free-swimming in this condition. Here and there individual flagellated cells (destined to form the cells of the dermal layer) lose their flagella and, becoming amoeboid, migrate into the blastocoel, which presently becomes completely filled with such cells. The larva is thus converted into a solid "parenchymula," in which the archaeocytes remain unchanged in their original position at the posterior extremity. It now fixes itself and flattens out upon the substratum in the pupal condition. During the metamorphosis which now ensues the majority of the cells of the inner mass (dermal cells) pass out to the exterior again between the flagellated cells

(gastral cells), over which they spread themselves in the form of a dermal layer of flattened epithelium. Some of the dermal cells, however, remain in the inner mass as porocytes; the primitive archaeocytes have divided up into amoebocytes; and porocytes, amoebocytes and the cells of the gastral layer are all crowded together in the interior of the pupa. The pupa now elongates vertically. A gastral cavity appears in the interior. The cells of the gastral layer arrange themselves around this cavity and develop their collars and flagella. At first, however, the gastral cavity is lined by the porocytes, which presently separate and migrate outwards.¹ Scleroblasts migrate inwards from the dermal layer and secrete spicules. An osculum and prosopyles are formed as in *Sycon* and the Olynthus stage is reached.

The development of sponges in general appears to be characterized by a remarkable want of uniformity in the arrangement of the different kinds of cells of which the larva is composed. Two, or possibly three, primary groups of cells are universally present; the flagellated cells, which will give rise to the collared cells of the adult, the non-flagellated (granular) cells, which will give rise to the dermal layer and its derivatives, and possibly the primitive archaeocytes (perhaps to be regarded as undifferentiated blastomeres). It may be considered as doubtful, however, whether the primitive archaeocytes can in all cases be distinguished from the primitive dermal cells. The latter are in some cases (amphiblastula type) grouped at the posterior pole of the larva (*Sycon*), while in other cases (parenchymula type) they may pass inwards and completely fill the interior, blocking up the blastocoel and perhaps also freely projecting at the hinder end (fig. 39, F). At the time of the metamorphosis the dermal cells pass to the outside and come to completely enclose the gastral cells, so that the two layers acquire their proper relative positions. The sponge larva in many respects closely resembles the Coelenterate "planula," with its ectoderm and endoderm, but it is very doubtful how far this comparison is valid, and in the present state of our knowledge it is perhaps better to avoid the use of the terms ectoderm and endoderm in dealing with the sponges altogether. The idea naturally suggests itself that the two primary layers of the Sponges correspond to those of the Coelenterate, but in a reversed position, the inner layer of the one being the outer layer of the other, and vice versa, and this idea has found expression in the name *Enantiozoa* which has been proposed for the group by Yves Delage, but which has not met with general acceptance.

Physiology.

Comparatively little is known of the physiology of sponges. The most obvious expression of the vital activity of the organism is the stream of water which flows in through the dermal pores or ostia and out through the vents or oscula. That this stream is maintained by the undulatory movements of the flagella of the collared cells there can be no doubt, but the fact that the movements of the flagella of different cells are not co-ordinated, so that they do not act in unison, indicates that the mechanical problem involved is not so simple as is usually supposed. There can be no doubt that the incoming stream brings with it minute food-particles, consisting of fragments of organic matter, alive or dead, and also the oxygen required for purposes of respiration; while the outgoing stream removes faecal products and waste matter (excreta). The rate of flow appears to be regulated by the opening and closing of the pores and vents, or of intermediate apertures such as the apopyles or exhalant openings of the flagellate chambers. This opening and closing may be effected by the activity of definite muscular sphincters (fig. 34, 2) or, in the case of some prosopyles, by the contractility of the porocytes themselves.

The ingestion of the food particles is no doubt effected in large measure by the collared cells, which seem to feed much in the same manner as independent collared monads (Choanoflagellata). It seems not improbable that Sollas's membrane may be a temporary structure which assists in arresting food particles as they pass through the flagellate chambers. There is reason to believe also that amoebocytes (in this case therefore phagocytes) may capture minute organisms on their way through the canal system, and even porocytes are sometimes credited with this power. Digestion, no doubt, is, at any rate chiefly, intracellular. The amoebocytes probably serve not only to ingest food themselves but also to receive surplus food from the collared cells and distribute it through the sponge (fig. 34, 5).

Nothing definite is known as to the function of excretion, but here, as in the case of nutrition, it seems likely that collared cells and amoebocytes are both concerned.

¹ The position of the porocytes inside the collared cells appears at first sight very anomalous, but Minchin has shown that this condition is actually repeated in the adult sponge every time the gastral cavity is obliterated by contraction.

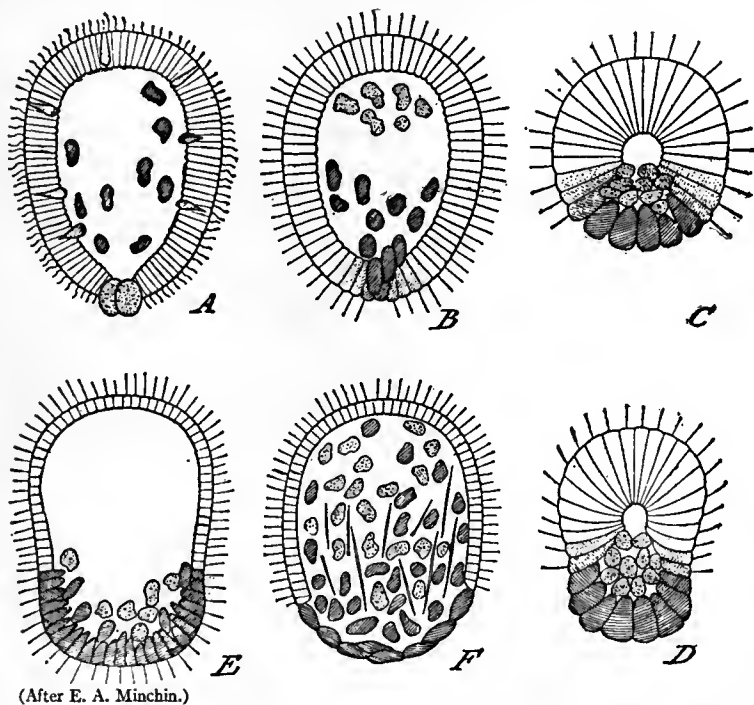

FIG. 39.—Types of Sponge Larvae (semi-diagrammatic). The ciliated (gastral) cells are left blank; the dermal cells are shaded, and the archaeocytes are granulated.

- A, Larva of *Leucosolenia* (*Clathrina*) *blanca*.
- B, Of *Leucosolenia* (*Clathrina*) *reticulum*.
- C, Young larva of *Leucosolenia* (or pseudogastrula stage of *Sycon*).
- D, Late larva of *Leucosolenia* (or newly hatched larva of *Sycon*).
- E, Larva of *Oscarella*.
- F, Parenchymula larva of a siliceous Monaxonellid (*Myxilla*).

Sponges, as we have already seen possess no special nervous system and no special sense organs, and the power of response to stimuli appears to be very limited. Many sponges probably have the power of contracting as a whole, which may in some cases be due, in part at any rate, to the presence of bands of muscular fibres, and Sollas observes that in *Pachymatisma* irritation of the oscular margin is invariably followed after a short interval by a slow closure of the sphincter. The power of movement in adult sponges is, however, chiefly confined to individual cells acting independently. The young larvae, on the other hand, swim vigorously about by means of their cilia or flagella, whose movements must obviously be co-ordinated in order to ensure the progress of the entire organism in definite directions.

The rate of growth of sponges appears to be very rapid. A British species of *Hymeniacidon* is said to form a crust measuring a foot in diameter in so short a period as five months. With this rapidity of growth must be associated the fact that many sponges, marine as well as fresh-water, appear to be annual.

Distribution.

The vast majority of sponges are marine, only a single sub-family, the Spongillinae, having acquired the habit of living in fresh water. The Spongillinae are, however, very widely distributed, being found in lakes and rivers in all parts of the world. Marine sponges occur everywhere, from low-water mark to the greatest depths, but certain localities, such as the Gulf of Manaar, Port Phillip and Port Jackson, appear to be much richer than others both in individuals and species. The Hexactinellida are essentially a deep-water group and are therefore much more rarely met with than other forms. The Tetraxonida and Euceratosa abound in shallow and in moderately deep water, and a comparatively small number of species of Tetraxonida occur at great depths. Both are dominant groups at the present day, represented by very large numbers of species and individuals. The Myxospongida are comparatively rare and represented by very few species. The Calcarea are common in the littoral region, especially in sheltered situations amongst rocks and seaweed.

Most families and even genera of sponges enjoy a very wide geographical range, very many being cosmopolitan. Species are usually much more restricted in distribution, but even here there are some noteworthy exceptions, and future researches will probably show that many species from different localities which are at present regarded as distinct are connected by intermediate forms living in intermediate situations.

There appears to be a well-marked relation between temperature and the power of spongin-secretion, and as a result we find that sponges with a really well-developed horny skeleton (whether *Euceratosa* or *Pseudoceratosa*) are usually only met with in comparatively warm waters. This fact brings about a striking contrast between the sponge-faunas of different latitudes.

Classification.

The classification of the Phylum Porifera, the characters of which have already been given, is as follows:—

Sub-phylum and Class **Calcarea**.—Sponges with a skeleton composed of carbonate of lime, commonly in the form of isolated spicules whose most usual shape is triadial.

Order 1. Homocoela.—Calcarea in which the gastral cavity and its outgrowths are lined throughout by collared cells. This order is sometimes divided into two families, Clathrinidae and Leucosoleniidae, but it is doubtful if this distinction can be maintained, and by some writers only a single genus (*Leucosolenia*) is recognized.

Order 2. Heterocoela.—Calcarea in which the original lining of the gastral cavity is partly replaced by pavement epithelium, so that the collared cells are confined to separate flagellated chambers. This order includes the living families Leucascidae, Sycettidae, Grantidae, Heteropidae, Amphoriscidae and Pharetronidae (with only two living representatives but numerous fossil forms). The relationships of the anomalous *Astrosclera* (fig. 25), for which the family *Astroscleridae* has been proposed by J. J. Lister, must still be regarded as problematical.

Sub-phylum **Non-Calcarea**.—Sponges without any calcareous skeleton.

Class and Order **MYXOSPONGIDA**.—Sponges with no skeleton; with simple canal system and usually large flagellate chambers. (The absence of skeleton is primitive and not due to degeneration.) This class is sometimes divided into two families—Halisarcidae, with elongated, sac-shaped chambers, and Oscarellidae, with more or less spherical chambers.

Class **TRIAXONIDA** (=HEXACTINELLIDA).—Sponges with a skeleton composed of siliceous spicules, either isolated or cemented together by silica, and either triaxonid and hexactinellid in form or derivable from the triaxonid and hexactinellid type. The canal system is simple and the flagellated chambers are large and sac-shaped, and more or less radially arranged in a network of trabecular tissue. Spongin is never formed.

Order 1. Amphidiscophora.—Triaxonida with characteristic amphidisc spicules, but no hexasters, and with a root-tuft of anchoring spicules. The family Hyalonematidae, including the well-known glass-rope sponges of the genus *Hyalonema*, is the only family recognized in this order.

Order 2. Hexasterophora.—Triaxonida whose most characteristic spicules are hexasters. To this order belong the living families Euplectellidae, Asconematidae, Rossellidae, Euretidae, Melittionidae, Coscinoporidae, Tretodictyidae and Maeandrospongidae, and a number of extinct families such as the *Ventriculitidae* so commonly met with in the Jurassic and Cretaceous rocks.

Class **TETRAAXONIDA**.—Sponges with a skeleton composed of siliceous spicules, either isolated or cemented together (by silica or by spongin), and either tetraxonid and tetractinellid in form or derivable from the tetraxonid and tetractinellid type. The canal system is usually complex, with small, more or less spherical flagellated chambers.

Grade **TETRACTINELLIDA**.—Tetraxonida in which some, at any rate, of the megascleres retain the primitive tetractinellid form. No desmas are developed.

Order 1. Homosclerophora.—Tetractinellida in which microscleres and megascleres are not yet sharply differentiated from one another and no triaenes are developed. The canal system is comparatively simple. This order includes the family Plakinae (see *Plakina*, ante) which forms the starting-point of the evolution of the class.

Order 2. Astrophora.—Tetractinellida with triaenes and with astrose microscleres, without sigmata. This order includes the families Pachastrellidae, Thencidae, Stellettidae, Geodiidae.

Order 3. Sigmatophora.—Tetractinellida with triaenes, with sigmata for microscleres (when present), without asters. This order includes the families Tetillidae and Samidae.

Grade (? order) **LITHISTIDA**.—Tetraxonida in which the megascleres form desmas, typically united with each other by siliceous cement to form a continuous skeleton, often of stony hardness. This group includes both tetractinellid and monaxonellid forms and may possibly be of polyphyletic origin. The Lithistida bear the same relation to the other Tetraxonida that the dictyonine Hexactinellids bear to the lyssacine forms, but in the present state of our knowledge it is hardly possible to trace the natural affinities of the numerous members of the group, many of which are only known in the fossil state. The following are the principal families: Tetraladidae, Desmanthidae, Corallistidae, Pleromidae, Neopeltidae, Scleritodermidae, Cladopeltidae, Azoricidae, Anomocladidae.

Grade **MONAXONELLIDA**.—Tetraxonida in which the primitive tetraxonid and tetractinellid condition of the megascleres has been entirely lost through suppression of some of the spicule rays, so that none but monaxonellid megascleres remain. No desmas are developed. Owing to the extreme reduction or modification of the skeleton, leading in many cases to convergence, the classification of this group is extraordinarily difficult and the group is obviously not monophyletic.

Order 1. Astromonaxonellida.—Monaxonellida in which the microsclere, when present, is some form of aster. The members of this order are to be regarded as descended from aster-bearing tetractinellid ancestors.

Families.—Epipolasidae, Tethyidae, Spirastrellidae (including Placospongiidae), Clonidae (the boring sponges), Suberitidae, Chondrosidae. (In *Chondrosia* the skeleton is entirely suppressed, so that it simulates the Myxospongida.)

Order 2. Sigmatomonaxonellida.—Monaxonellida in which the typical microscleres are sigmata, or other diactinal forms. Normal astrose microscleres are absent (though secondary pseudasters are occasionally present). The members of this order are to be regarded as descended from sigma-bearing tetractinellid ancestors.

Families.—Haploscleridae (chief sub-families: Gelliinae, Renierina Chalininae, Spongillinae), Desmacidonidae (chief sub-families: Esperellinae, Ectyoninae), Axinellidae.

Class and Order **EUCERATOSA**.—Non-calcareous sponges without siliceous spicules, but with a skeleton composed of horny fibres developed independently, i.e. not in relation to any pre-existing spicular skeleton. The skeleton is often supplemented, or even largely replaced, by foreign bodies. This group includes the bath-sponges and their very numerous relations.

Families.—Aplysillidae, Spongeliidae, Spongiidae.

There are two groups of palaeozoic fossil siliceous sponges which apparently do not fit into the above system,

viz. the Octactinellida and Heteractinellida of G. J. Hinde. The former, represented by the genus *Astracospongia*, have octactinal megascleres. The latter, represented by the genera *Tholiasterella* and *Asteractinella*, have polyaxon megascleres with an indefinite number of rays.

These may indicate the former existence of two distinct classes of siliceous sponges

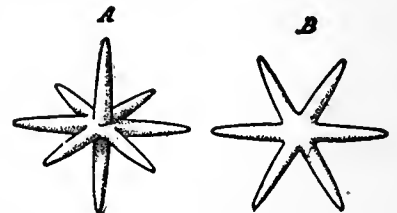

(After G. J. Hinde.)

FIG. 40.—A, octactine and B, hexactine spicules of *Astracospongia*.

which are, so far as we know, totally unrepresented at the present day.

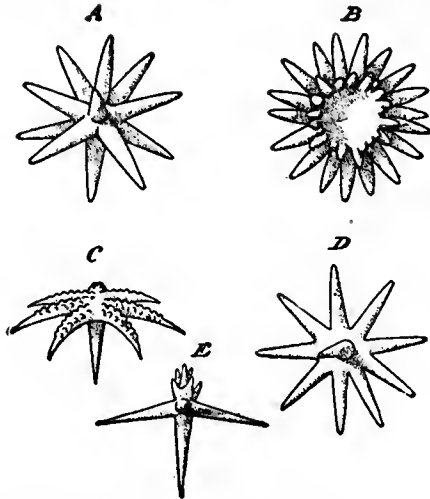

(After G. J. Hinde.)

FIG. 41.—Spicules of Heteractinellida.

A, Typical polyactine. B, Rosette-like form. C, D, E, Nail-like forms.

Phylogeny.

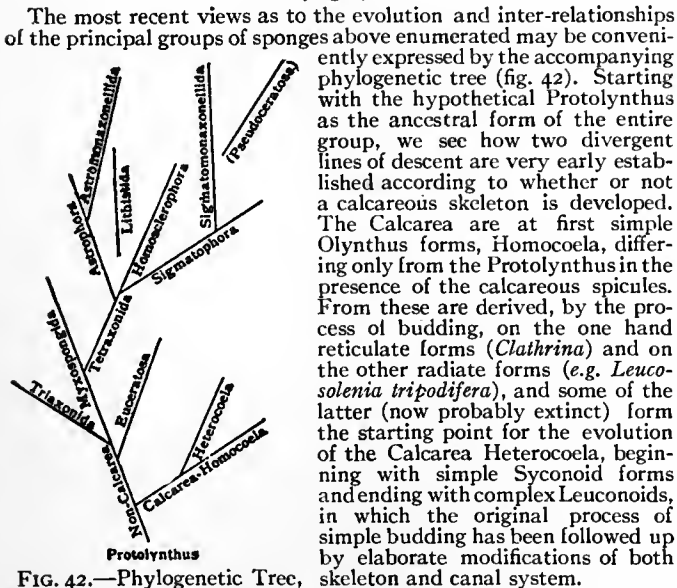

FIG. 42.—Phylogenetic Tree, showing the supposed relationships of the principal groups of sponges to one another.

sponge; though the analogy of the Calcareo makes it easy to understand how the almost Syconoid canal system of the simplest Hexactinellids, or the primitive Rhagon type of other groups, may have been derived from the Protolynthus ancestor in the first instance by simple budding. This line of descent may be regarded as continued straight on into the existing Myxospongida, with increase in the complexity of the canal system, due to folding of the chamber-bearing layer and the accompanying development of inhalent and exhalent canal systems, but without the development of any skeleton. The Triaxonida and Euceratosa would seem to have branched off independently at a very early stage from the Myxosponge line, before the flagellated chambers had suffered that reduction in size which occurs in some existing Myxospongida and in all Tetraxonida. In the Triaxonid line of descent the evolution of the siliceous skeleton of primitively hexactinellid spicules is the leading feature, the canal system preserving remarkable uniformity throughout the group. In the Tetraxonida also the skeleton has played the principal part in the evolution of existing species, but the canal system too has undergone great modifications. The primitive tetraxonid, tetractinellid siliceous spicules must have arisen quite independently, their fundamental form being totally different from that of the triaxonid hexactinellid type. The appearance of differentiated microscleres in this group introduced new possibilities of variation, of which full advantage has been taken, and we are confronted with most interesting evolutionary series, terminating in many very

remarkable and at present inexplicable spicule forms (fig. 29). In many of the more advanced Tetraxonida, especially in the Chaliniinae, the development of spongin cement also appears as a new factor in the process of evolution. At first serving merely to glue the megascleres together into a continuous framework, it ultimately, in some extreme cases, completely replaces the siliceous skeleton and gives rise to a purely "horny" skeleton in which all traces of spicules have been lost by degeneration. Thus we arrive at a "Pseudoceratose" condition (fig. 32, D) which must be carefully distinguished from the condition of the Euceratosa, which have apparently branched off quite independently from Myxosponge ancestors. Here we have another typical example of that phenomenon of "convergence" which has rendered the classification of sponges so very difficult. In the Euceratose line of descent we start with forms (*Aplysilla*) with large sac-shaped chambers and altogether primitive canal system, accompanied by an arborescent horny skeleton (fig. 33) of an entirely different type from that of the pseudoceratose Tetraxonida. From this we can trace the evolution gradually through the Spongeliidae to the Spongiidae, the skeleton becoming reticulate and the canal system gradually more complex with accompanying reduction in size of the chambers. The bath sponge perhaps represents the culminating point in this direction. Thus it appears that both the horny type of skeleton and the siliceous spicular type have been twice independently produced in the evolution of the Non-calcareo. An analogous case of convergence is seen in the union of originally separate spicules into a coherent skeleton by means of cement of the same chemical composition as themselves. This has taken place independently in the Calcareo (*Petrosoma*), the Dictyonine Hexactinellida and the Lithistid Tetraxonida.

Affinities of the Porifera.

Three main views have been put forward with regard to the position of the Sponges in the animal kingdom: (1) that they are colonies of Protozoa; (2) that they form a subdivision of the Coelenterata; (3) that they are not Protozoa but have originated from Protozoan ancestors quite independently from other Metazoa (Enterozoa). The first of these views, associated especially with the names of James Clark and Saville Kent, is supported by the relative independence of the constituent cells in the sponge-body and by the extraordinary resemblance of the collared cells to the choanoflagellate or collared Monads. It is also supported by the existence of a remarkable colonial form of Choanoflagellata (*Proterospongia*) in which the collared Monads are partially embedded in the surface of a gelatinous matrix, in the interior of which amoeboid cells are found. E. A. Minchin has shown that even in the adult *Leucosolenia* (*Clathrina*) the collared cells and porocytes have the power of changing their relative positions, while migration of dermal and gastral cells and consequent inversion of the layers appears to be a common feature of the sponge larva at the time of metamorphosis. These facts are certainly suggestive of Protozoan colonies rather than of Metazoa. On the other hand it must not be forgotten that migratory amoebocytes (*leucocytes*) occur in probably all groups of Metazoa, while the degree of integration and the amount of histological differentiation in Sponges are far greater than in any other Protozoan colonies known to us. It has been argued that the process of sexual reproduction by means of ova and spermatozoa is fatal to the Protozoon-colony theory, but this argument is completely disposed of by the discovery of spermatozoa and ova in the unicellular Sporozoa. On the other hand the occurrence of collared cells has been held to distinguish the Sponges from all other Metazoa, and this argument has also been answered by the discovery of collared cells in the larva of *Echinocyamus* (an Echinoderm) by H. Theel. It would, in short, be difficult to frame a definition of the Protozoa which should absolutely exclude the Sponges, while at the same time our conception of the nature of Protozoa will have to be profoundly modified if we are to admit the Sponges within the limits of that group.

The second view, that the Sponges constitute a subdivision of the Coelenterata, is maintained by some very eminent continental authors such as Ernst Haeckel and F. E. Schulze. This view is supported by the structure of the Olynthus type, which, as we have seen, forms the starting-point of Sponge evolution. The dermal layer of the Olynthus is regarded as ectoderm, the gastral layer as endoderm and the mesogloea with its contained cells as mesoderm, more highly developed

than in most Coelenterates. It is also supported by a considerable amount of agreement in the early stages of development, up to the formation of the ciliated larva. According to this view the Olynthus, or at any rate the imaginary "*Protolynthus*" is only a slightly modified gastrula, and the Sponges are therefore Enterozoa without any coelom, or in other words Coelenterata. The extraordinary histological differences between the Sponges and other Coelenterates (Cnidaria), combined with the highly characteristic canal system and the absence of tentacles, are, however, alone sufficient to throw grave doubts upon the probability of a close relationship between the two groups, and these doubts are greatly strengthened by recent embryological researches, which tend to show that the so-called ectoderm and endoderm are not homologous in the two cases.

There remains the third view, in accordance with which the Sponges are multicellular animals which have originated quite independently from Choanoflagellate Protozoan ancestors, and this is the view which at present seems to have most in its favour. It is especially associated with the name of W. J. Sollas, who invented the term "*Parazoa*" for the group. In support of this view it may be pointed out that the tendency to form hollow, spherical colonies, resembling the blastosphere stage in the development of Enterozoa, is met with in very distinct groups of Protozoa (e.g. *Volvox*, *Sphaerozoum*). This form of colony is obviously polyphyletic in origin. The fact that the segmentation of the ovum leads to such a form in both Sponges and Enterozoa is therefore by no means conclusive evidence that Sponges and Enterozoa have originated from the same Protozoan group. While, as has been repeatedly pointed out, the universal and characteristic collared cells of sponges point emphatically to a Choanoflagellate ancestry, it is impossible, in the present state of our knowledge, to indicate the particular Protozoan group which has given origin to the Enterozoa. We may then consider the Metazoa, or many-celled animals, as a polyphyletic, or at any rate diphyletic group, including two perfectly distinct lines of descent from the ancestral Protozoa, the Sponge-line on the one hand, which leads to nothing higher than Sponges, which retain in many respects the characters of Protozoa, and the Enterozoon line on the other, which leads through the Coelenterata to the Coelomata and so on to the highest divisions of the animal kingdom.

Economics.

All the bath sponges belong to the two genera *Euspongia*, Bronn, and *Hippospongia*, Schulze, subdivisions of the old genus *Spongia*, auctorum, distinguished from one another by the fact that in *Hippospongia* the body of the sponge is traversed by wide ramifying canals or vestibules, in addition to the proper canal system of the sponge. Species of these two genera occur in many parts of the world, probably wherever the temperature of the sea-water is sufficiently high and the depth and bottom suitable. It is only in a few localities, however, that they occur in sufficient numbers and of sufficiently good quality to render a sponge fishery practicable. The sponges of commerce are obtained chiefly from the Mediterranean, the coast of Florida and the Bahama Islands. From the Mediterranean three distinct species are obtained—(1) *Euspongia officinalis*, which includes the "fine sponges," with two chief varieties, *mollissima* (the Levantine sponges, very soft and often cup-shaped), and *adriatica*; (2) *Euspongia zimocca*, including the "hard" or Zimocca sponges; (3) *Hippospongia equina*, the "common" or "horse" sponge.

Of the Florida sponges five principal kinds are recognized by the dealers—(1) the sheep's wool sponge (*Hippospongia gossypina*)—this appears to be by far the most abundant in the market and also the most valuable; (2) the yellow sponge (*Euspongia agaricina*), resembling the Zimocca sponge of the Mediterranean; (3) the grass sponges (including both *Hippospongia graminea* and *H. cerebriiformis*); (4) the velvet sponge (*Hippospongia maeandriniformis*), which is not so common as the others; (5) the glove sponge (*Euspongia tubulifera*), which is the least valuable. In the year 1900 the Florida sponge

fisheries yielded 418,125 lb of sponges, valued at \$567,685. The Bahama sponges appear to be very similar to those of Florida.

Bath sponges occur in comparatively shallow water and are obtained by diving, by dredging, or by means of a trident or long-handled fork. The preparation of the sponges for the market is extremely simple. The slimy soft tissues very soon begin to decay and run off when they are removed from the water; after this has gone on for some time the sponges are washed and beaten until the skeleton is clean, they are then threaded on string and dried. They are frequently "loaded" with foreign matter by the dealers in order to increase their weight; rock-salt, glucose, molasses, lead, gravel, sand and stones being used for the purpose. They are also often bleached by means of chemicals to give them a better colour, but though their appearance is thereby greatly improved, their durability is said to be impaired.

In spite of the undoubted rapidity with which sponges grow, as shown by the fact that on the coast of Florida marketable sponges are found commonly in places that had been stripped of saleable specimens in the preceding year, there appears to be considerable danger of injury to the sponge industry by over-fishing and by the reckless destruction of young specimens, and it has been found necessary to introduce special legislation in America to counteract these evil tendencies. The question of the artificial propagation and cultivation of sponges has also been much discussed, but although some very interesting experiments have been made, they have not as yet led to any great practical results. As far back as 1862 Oscar Schmidt showed that "cuttings" of sponges will attach themselves and grow. This idea was followed out in the experiments of G. Buccich on the Island of Lesina, from 1863-1872, but these experiments were brought to a close by the hostility of the native fishermen. Similar experiments have since been made on the Florida sponge-grounds. The possibility of rearing sponges in this way from cuttings has thus been fully demonstrated, but whether it can be done profitably is another question. According to the experience of G. Buccich it appeared that it would take seven years for the cuttings to attain marketable size in the Mediterranean. The Florida experiments, on the other hand, indicate a much more rapid rate of growth, and it has been stated that under favourable conditions the cuttings will attain marketable size in as short a time as one year. It has been doubted, however, whether the total weight of sponges produced by cuttings would be greater than the weight of the sponges from which the cuttings were taken if these sponges were allowed to continue their growth undisturbed. H. V. Wilson has suggested that sponges may be artificially reared from the eggs, in the same way that fishes or oysters are reared. The eggs of the bath sponge, like those of other sponges, develop into free-swimming ciliated larvae, and these might be made to attach themselves, like oyster-spat, to suitable objects, on which the young sponges could be cultivated under appropriate conditions. Detailed experiments are required to demonstrate the feasibility or otherwise of this interesting suggestion.

For further information on the economic aspect of the subject the student should consult the annual Bulletin and special papers of the United States Bureau of Fisheries and also the work of Seurat referred to in the bibliography.

BIBLIOGRAPHY.—A very full list of the literature of the group up to 1889 is given in Lendenfeld's work on the Horny Sponges, published by the Royal Society. We have only space here to refer to a very limited number of memoirs. Other references will be found in the works cited.

(1) J. S. Bowerbank, *Monograph of the British Spongiadae* (Ray Society); (2) H. J. Carter, a long series of memoirs, chiefly systematic, in the *Annals and Magazine of Natural History* (1847 to 1887); (3) Y. Delage, *Embryogénie des éponges* (Arch. Zool. Exp. (2), x, 1892); (4) A. Dendy, "Monograph of Victorian Sponges," pt. i., *Trans. Royal Soc.*, Victoria III. (1891); (5) idem, "Studies on the Comparative Anatomy of Sponges," pts. i.-vi., *Quart. Journ. Mic. Sci.* (1888-1894); (6) idem, "Report on the Sponges collected by Professor Herdman at Ceylon in 1902" (Royal Society, 1905); (7) E. Haeckel, *Die Kalkschwämme* (Berlin, 1872); (8) G. J. Hinde, *Monograph of British Fossil Sponges* (Palaeontological Society, London); (9) A. Hyatt, "Revision of the North American

Poriferae," *Mem. Boston Soc. Nat. Hist.* (1875-1877), vol. ii.; (10) R. Kirkpatrick, *Descriptions of South African Sponges* (Marine Investigations in South Africa; Cape of Good Hope Department of Agriculture, 1902-1903); (11) W. Lundbeck, *Parifera* (Danish Ingolf-Expedition, vol. vi., 1902, &c.); (12) E. A. Minchin, "Materials for a Monograph of the Ascans," I., *Quart. Journ. Mic. Sci.* (1898), vol. xl.; (13) idem, "Sponges," in Lankester's *Zoology*, pt. ii. (1900); (14) N. Poléjaeff, "*Calcarea*," "*Challenger*" Reports, "*Zoology*" (1883), vol. viii.; (15) S. O. Ridley and A. Dendy, "*Monaxonida*," "*Challenger*" Reports, "*Zoology*" (1888) vol. xx.; (16) F. E. Schulze, "Untersuchungen über den Bau und die Entwicklung der Spongien," *Zeitschrift für wiss. Zoologie* (1875-1881); (17) idem, "*Hexactinellida*" ("*Challenger*" Reports, "*Zoology*," vol. xxi.); (18) idem, "*Amerikanische Hexactinelliden*" (Gustav Fischer, Jena, 1899); (19) idem, "*Hexactinellida of the 'Valdivia'*" Expedition (Jena, 1904); (20) L. G. Seurat, *L'Eponge histoire naturelle*; Pêche; "Acclimatation"; Spongiculture, *Bull. soc. nat. d'acclimatation de France*, 48th year (1901); (21) W. J. Sollas, "*Tetractinellida*" ("*Challenger*" Reports, "*Zoology*," vol. xxv.); (22) I. B. J. Sollas, "Sponges," *Cambridge Natural History* (1906), vol. i.; (23) E. Topsent, *Études monographiques des spongiaires de France* (Arch. Zool. Exp. (3), 1894, vol. ii. &c.); (24) idem, "Contribution à l'étude des spongiaires de l'Atlantique Nord" (*Campagnes scientifiques du prince de Monaco*, 1892, vol. ii.); (25) idem, "Spongiaires des Açores" (*Campagnes scientifiques du prince de Monaco*, 1904, vol. xxv.); (26) G. C. J. Vosmaer, "Spongien," *Bronn's Klassen und Ordnungen des Tierreichs* (1887), vol. ii.; (27) H. V. Wilson, "On the Feasibility of Raising Sponges from the Egg," *Bulletin of the United States Fish Commission* (1897), vol. xvii. (A. DE.)

SPONSOR (from Lat. *spondere*, to promise), one who stands surety for another, especially in the rite of Christian baptism, a godfather or godmother. The practice originated not in infant baptism, but in the custom of requiring an adult pagan who offered himself for the rite to be accompanied by a Christian known to the bishop, who could vouch for the applicant and undertake his supervision, thus fulfilling the function performed in the Eleusinian mysteries by the *mystagogus*. The Greek word for the person undertaking this function is *ἀνάδοχος*, to which the Latin *susceptor* is equivalent. The word "sponsor" in this ecclesiastical sense occurs for the first time, but incidentally only, and as if it were already long familiar, in Tertullian's treatise *De baptismo* (ch. 18), where, arguing that in certain circumstances baptism may conveniently be postponed, especially in the case of little children, he asks, "For why is it necessary that the sponsors likewise should be thrust into danger, who both themselves by reason of mortality may fail to fulfil their promises, and may also be disappointed by the development of an evil disposition [in those for whom they become sponsors]?" The sponsors here alluded to may have been in many cases the actual parents, and even in the 5th century it was not felt to be inappropriate that they should be so; Augustine, indeed, in one passage appears to speak of it as a matter of course that parents should bring their children and answer for them "tanquam fidejussores" (*Epist. . . . ad Bonif.* 98), and the oldest Egyptian ritual bears similar testimony. Elsewhere Augustine contemplates the bringing of the children of slaves by their masters, and of course orphans and foundlings were brought by other benevolent persons. The comparatively early appearance, however, of such names as *compadres*, *commatres*, *propatres*, *promatres*, *patrini*, *matrinae*, is of itself sufficient evidence, not only that the sponsorial relationship had come to be regarded as a very close one, but also that it was not usually assumed by the natural parents. How very close it was held to be is shown by the Justinian prohibition of marriage between godparents and godchildren. On the other hand, the anciently allowable practice of parents becoming sponsors for their own children, though gradually becoming obsolete, seems to have lingered until the 9th century, when it was at last formally prohibited by the council of Mainz (813). For a long time there was no fixed rule as to the necessary or allowable number of sponsors and sometimes the number actually assumed was large. By the council of Trent, however, it was decided that one only, or at most two, these not being of the same sex, should be permitted. The rubric of the Church of England according to which "there shall be for every male child to be baptized two godfathers and one godmother, and for every female one godfather and two godmothers," is not older than 1661; the sponsors are charged

with the duty of instructing the child, and in due time presenting it for confirmation, and in the Catechism the child is taught to say that he received his name from his "godfathers and godmothers." At the Reformation the Lutheran churches retained godfathers and godmothers, but the Reformed churches reverted to what they believed to be the more primitive rule, that in ordinary circumstances this function should be undertaken by a child's proper parents. Most churches demand of sponsors that they be in full communion. In the Roman Catholic Church, priests, monks and nuns are disqualified from being sponsors, either "because it might involve their entanglement in worldly affairs," or more probably because every relationship of fatherhood or motherhood is felt to be in their case inappropriate. The spiritual relationship established between the sponsor and the baptized, and the sponsors and the parents of the baptized, constitutes an impediment to marriage (see MARRIAGE: *Canon Law*).

SPONTINI, GASPARO LUIGI PACIFICO (1774-1851), Italian musical composer, was born on the 14th of November 1774 at Majolati (Ancona) in Italy. He was the son of a poor cobbler and was intended for the priesthood. His musical propensities however were not to be restrained, and he obtained lessons from Kapellmeister Quintiliani. In 1791 he went to the Conservatorio de' Turchini at Naples, where he was trained to write operatic music under Paisiello, Cimarosa and Fiorivanti. His first opera, *L'Eroismo ridicolo*, was successfully produced in 1796, and by 1799 he had already written and produced eight operas. After becoming court composer to King Ferdinand of Naples in this year an intrigue with a princess of the court compelled Spontini to leave Naples in 1800. For the next few years he wrote operas in Rome and Venice until 1803 when he settled in Paris, where his reception was anything but flattering. His comic opera *Julie* proved a failure; a successor, *La Petite maison*, was hissed. Undaunted by these misfortunes, he abandoned the light and somewhat frivolous style of his earlier works, and in *Milton*, a one-act opera produced in 1804, achieved a real success. Spontini henceforth aimed at a very high ideal, and during the remainder of his life strove so earnestly to reach it that he frequently remodelled his passages five or six times before permitting them to be performed in public, and wearied his singers by introducing new improvements at every rehearsal. His first masterpiece was *La Vestale*, completed in 1805, but kept from the stage through the opposition of a jealous clique until the 15th of December 1807, when it was produced at the Académie, and at once took rank with the finest works of its class. Spontini had abandoned the *parlando* of Italian opera for an accompanied recitative; he had increased the strength of the orchestra and introduced the big chorus freely. His opera, *Ferdinand Cortez*, was received with equal enthusiasm in 1809; but another, *Olympia*, was much less warmly welcomed in 1810. Napoleon, whose approval of any work of art was at once a compliment to the artist and a serious imputation on the value of the work, professed immense admiration for Spontini's music.

Spontini had been appointed director of the Italian opera in 1810; but his quarrelsome and grasping disposition led to his summary dismissal two years later, and, though reinstated in 1814, he voluntarily resigned his post soon afterwards. He was in fact very ill fitted to act as director; yet on the 28th of May 1820, five months after the failure of *Olympia*, he settled in Berlin by invitation of Frederick William III., commissioned to superintend all music performed at the Prussian court and compose two new grand operas, or three smaller ones, every three years. But he began by at once embroiling himself with the intendant, Count Brühl. Spontini's life at Berlin may be best described as a ceaseless struggle for precedence under circumstances which rendered its attainment impossible. Yet he did good work. *Die Vestalin*, *Ferdinand Cortez* and *Olympia*—the last two entirely remodelled—were produced with great success in 1821. A new opera, *Nourmahal*, founded on Moore's *Lalla Rookh*, was performed in 1822, and another, entitled *Alcidor*, in 1825; and in 1826 Spontini began the composition of *Agnes von Hohenstaufen*, a work planned on a grander scale than any of his

former efforts. The first act was performed in 1827, and the complete work in three acts graced the marriage of Prince William in 1829. Though the German critics abused it bitterly, *Agnes von Hohenstaufen* is undoubtedly Spontini's greatest work. In breadth of conception and grandeur of style it exceeds both *Die Vestalin* and *Ferdinand Cortez*, and its details are worked out with untiring conscientiousness. Spontini himself, however, was utterly dissatisfied with it, and at once set to work upon an entire revision, so that on its re-presentation in 1837 many parts were scarcely recognizable by those who had heard the opera in its original form.

This was his last great work. He several times began to rewrite his early opera, *Milton*, and contemplated the treatment of many new subjects, such as *Sappho*, *La Colère d'Achille*, and other classical myths, but with no definite result. He had never been popular in Berlin; and he has been accused of endeavouring to prevent the performance of *Euryanthe*, *Oberon*, *Die Hochzeit des Camacho*, *Jessonda*, *Robert the Devil*, and other works of genius, through sheer envy of the laurels won by their composers. But the critics and reviewers of the period were so closely leagued against him that it is difficult to know what to believe. After the death of Frederick William III. in 1840 Spontini's conduct became so violent and imperious that he was sentenced to nine months' imprisonment for *lèse-majesté*. The sentence was remitted by Frederick William IV., but on the 2nd of April 1841, when he appeared at the conductor's desk to direct a performance of *Don Juan*, he was greeted with hisses and groans, and his orders to raise the curtain were ignored, so that he was compelled to leave the desk. The king dismissed him on the 25th of August, with power to retain his titles and live wherever he pleased in the enjoyment of his full salary. He elected to settle once more in Paris, after a short visit to Italy; but beyond conducting occasional performances of some of his own works he made but few attempts to keep his name before the public. In 1847 he revisited Berlin and was invited by the king to conduct some performances during the winter. In 1848 he became deaf. In 1850 he retired to his birthplace, Majolati, and died there on the 14th of January 1851, bequeathing all he possessed to the poor of his native town.

SPONTOON (Fr. *esponton*, Ital. *spontone*, from Lat. *punctum*, point, *pungere*, to prick), a weapon carried by infantry officers in the 17th and early 18th centuries. It was a type of the partisan or halberd (*q.v.*), a shafted weapon with a special form of spear head.

SPOON (O. Eng. *spōn*, a chip or splinter of wood, cf. Du. *spaan*, Ger. *Spahn*, in same sense, probably related to Gr. *σφήν*, wedge), a table implement, bowl-shaped at the end, with a handle varying in length and size. From the derivation of the word the earliest northern European spoon would seem to have been a chip or splinter of wood; the Greek *κοχλιάριον* (Lat. *cochleare*) points to the early and natural use of shells, such as are still used by primitive peoples. Examples are preserved of the various forms of spoons used by the ancient Egyptians of ivory, flint, slate and wood, many of them carved with the symbols of their religion. The spoons of the Greeks and Romans were chiefly made of bronze and silver, and the handle usually takes the form of a spike or pointed stem. There are many examples in the British Museum from which the form of the various types can be ascertained, the chief points of difference being found in the junction of the bowl with the handle. Medieval spoons for domestic use were commonly made of horn or wood, but brass, pewter and "latten" spoons appear to have been common about the 15th century. The full descriptions and entries relating to silver spoons in the inventories of the royal and other households point to their special value and rarity. The earliest English reference appears to be in a will of 1259. In the wardrobe accounts of Edward I. for the year 1300 some gold and silver spoons marked with the fleur-de-lis, the Paris mark, are mentioned. One of the most interesting medieval spoons is the coronation spoon used in the anointing of the sovereign, an illustration of which is given under REGALIA. The sets of

spoons popular as christening presents in Tudor times, the handles of which terminate in heads or busts of the apostles, are a special form to which antiquarian interest attaches (see APOSTLE SPOONS). The earlier English spoon-handles terminate in an acorn, plain knob or a diamond; at the end of the 16th century the baluster and seal ending becomes common, the bowl being "fig-shaped." At the Restoration the handle becomes broad and flat, the bowl is broad and oval and the termination is cut into the shape known as the *piéd de biche*, or hind's foot. In the first quarter of the 18th century the bowl becomes narrow and elliptical, with a tongue or "rat's tail" down the back, and the handle is turned up at the end. The modern form, with the tip of the bowl narrower than the base and the rounded end of the handle turned down, came into use about 1760.

See C. J. Jackson, "The Spoon and its History," in *Archæologia* (1892), vol. liii.; also Cripps, *Old English Plate*.

SPOONBILL. The bird now so called was formerly known in England as the Shovelard or Shovelar, while that which used to bear the name of Spoonbill, often amplified into Spoon-billed Duck, is the Shoveler (*q.v.*) of modern days—the exchange of names having been effected as already stated (*loc. cit.*) about 200 years ago, when the subject of the present notice—the *Platalea leucorodia* of Linnaeus as well as of recent writers—was doubtless far better known than now, since it evidently was, from ancient documents, the constant concomitant of Herons, and with them the law attempted to protect it.¹ J. E. Harting (*Zoologist*, 1886, pp. 81 seq.) has cited a case from the "Year-Book" of 14 Hen. VIII. (1523), wherein the then bishop of London (Cuthbert Tunstall) maintained an action of trespass against the tenant of a close at Fulham for taking Herons and "Shovelars" that made their nests on the trees therein growing, and has also printed (*Zoologist*, 1877, pp. 425 seq.) an old document showing that "Shovelars" bred in certain woods in west Sussex in 1570. Nearly one hundred years later (*c.* 1662) Sir Thomas Browne, in his "Account of Birds found in Norfolk" (*Works*, ed. Wilkin, iv. 315, 316), stated of the "*Platea* or *Shovelard*" that it formerly "built in the Hernerie at Claxton and Reedham, now at Trimley in Suffolk." This last is the latest known proof of the breeding of the species in England; but more recent evidence to that effect may be hoped for from other sources. That the Spoonbill was in the fullest sense of the word a "native" of England is thus incontestably shown; but for many years past it has only been a more or less regular visitant, though not seldom in considerable numbers, which would doubtless, if allowed, once more make their home there; but its conspicuous appearance renders it an easy mark for the greedy gunner and the contemptible collector. What may have been the case formerly is not known, except that, according to P. Belon, it nested in his time (1555) in the borders of Brittany and Poitou; but as regards north-western Europe it seems of late years to have bred only in Holland, and there it has been deprived by drainage of its favourite resorts, one after the other, so that it must shortly become merely a stranger, except in Spain or the basin of the Danube and other parts of south-eastern Europe.

The Spoonbill ranges over the greater part of middle and southern Asia,² and breeds abundantly in India, as well as on some of the islands in the Red Sea, and seems to be resident throughout Northern Africa. In Southern Africa its place is taken by an allied species with red legs, *P. cristata* or *tenuirostris*,

¹ Nothing shows better the futility of the old statutes for the protection of birds than the fact that in 1534 the taking of the eggs of Herons, Spoonbills (Shovelars), Cranes, Bitterns and Bustards was visited by a heavy penalty, while there was none for destroying the parent birds in the breeding season. All of the species just named, except the Heron, have passed away, while there is strong reason to think that some at least might have survived had the principle of the Levitical law (Deut. xxii. 6) been followed.

² Ornithologists have been in doubt as to the recognition of two species from Japan described by Temminck and Schlegel under the names of *P. major* and *P. minor*. It has been suggested that the former is only the young of *P. leucorodia*, and the latter the young of the Australian *P. regia*.

which also goes to Madagascar. Australia has two other species, *P. regia* or *melanorhynchus*, with black bill and feet, and *P. flavipes*, in which those parts are yellow. The very beautiful and wholly different *P. ajaja* is the Roseate Spoonbill of America, and is the only one found on that continent, the tropical or juxta-tropical parts of which it inhabits. The rich pink, deepening in some parts into crimson, of nearly all its plumage, together with the yellowish green of its bare head and its lake-coloured legs, sufficiently marks this bird; but all the other species are almost wholly clothed in pure white, though the English has, when adult, a fine buff pectoral band, and the spoon-shaped expanse of its bill is yellow, contrasting with the black of the compressed and basal portion. Its legs are also black. In the breeding season, a pendent tuft of white plumes further ornaments the head of both sexes, but is longest in the male. The young of the year have the primary quills dark-coloured.

The Spoonbills form a natural group, Plataleinae, allied to the Ibididae, and somewhat more distantly to the Storks (see STORK). They breed in societies, not only of their own kind, but in company with Herons, either on trees or in reed-beds, making large nests in which are commonly laid four eggs—white, speckled, streaked or blotched, but never very closely, with light red. Such breeding stations have been several times described, as for instance by P. L. Sclater and W. A. Forbes (*Ibis*, 1877, p. 412), and H. Seebohm (*Zoologist*, 1880, p. 457), while a view of another has been given by H. Schlegel (*Vögl. Nederland*, taf. xvii.). (A. N.)

SPORADES (Gr. *Σποράδες*, from *σπείρειν*, to sow), the islands scattered about the Greek Archipelago, as distinguished from the Cyclades, which are grouped round Delos, and from the islands attached, as it were, to the mainlands of Europe and Asia. Ancient and modern writers differ as to the list of the Sporades (see Bursian, *Griechenland*, ii. 348 seq.). The Doric Sporades—Melos, Pholegandros, Sikinos, Thera, Anaphe, Astropalia and Cos—were by some considered a southern cluster of the Cyclades. In modern times the name Sporades is more especially applied to two groups—the northern Sporades, which lie north-east of Negropont (Euboea), Skiathos, Skopelos and Ikos being included in the department of Magnesia and Scyros in that of Euboea; and the southern Sporades, lying off the south-west of Asia Minor, being included in the Turkish vilayet of the "Islands of the White Sea." The northern, which have altogether an area of 180 sq. m. and a population of 12,250 (1896), comprise Skiathos (pop. 2790), Ikos (pop. 653), Skopelos (pop. 5295), Pelagonisi, Giura, Pipari and Scyros (pop. 3512), with the adjacent islets. Skiathos is a beautifully wooded and picturesque island; the town stands on a declivity surrounding an excellent harbour. The larger island of Skopelos is also well wooded. Almost every household in both islands is the owner, joint owner or skipper of a sailing ship. The southern Sporades are as follows: Icaria, Patmos, Leros, Calymnus, Astropalia (Astypalaea or Stampalia), Cos (Stanko), Nisyros, Tilos or Episcopi, Syme, Khalki, Rhodes, Crete and many smaller isles. Icaria (pop. about 8000) derives its name from the legend of Icarus. The forests which it once possessed have been destroyed by the inhabitants for the manufacture of charcoal. Leros (pop. about 3000) was in ancient times a seat of the worship of Artemis. Calymnus (pop. about 7000) was once covered by forests—(Ovid, *A. A.* ii. 81, "silvis umbrosa Calymne"), which have disappeared. Nisyros (pop. about 2500) possesses hot sulphur springs.

SPOROZOA, a large and most important section of the Protozoa, all the members of which are exclusively parasitic in habitat. They are of extremely widespread occurrence; there is hardly one of the chief classes of animals which does not furnish hosts for these parasites, scarcely one of the common tissues or organs of the Metazoan body which may not be liable to infection. Sporozoa differ greatly as regards the effects which they produce upon their hosts. In many, perhaps in most, cases the general health of the infected animal seems to be unimpaired, even though the parasites may be fairly abundant. Some, however,

give rise to dangerous or fatal diseases, while others may cause ravaging epidemics; instances of these are given under the various orders.

Correlated with the mode of life are the two features characteristic of all Sporozoa: (a) They absorb only fluid nutriment, osmotically, and so lack any organs for ingesting and digesting solid food; and (b) they reproduce by sporulation, *i.e.* the formation of minute germs, which are in most instances very numerous and are often enclosed in firm protective envelopes or cases, each case with its contents forming a *spore*. In addition, the great majority have also another method of reproduction, for increasing the number of the parasites in any individual host; this is distinguished as multiplicative or endogenous reproduction, from the propagative or exogenous method (by means of the resistant spores), which, serves for the infection of fresh hosts and secures the dissemination and survival of the species. Further, most if not all forms of Sporozoa undergo sexual conjugation at some period or other of the life-cycle.

Beyond this, however, it is impossible to generalize. In response to the exceeding diversity of habitat and of the conditions of life, the parasites exhibit manifold and widely-different types of form, organization and life-history. The recognition of this fact is expressed, at the present day, by the division of the Sporozoa into several well-defined orders, which are grouped in two main divisions, each containing more or less closely related forms. One of these groups consists of the Gregarines, Coccidia and Haemosporidia (*qq.v.*). The other comprises the Myxosporidia, Actinomyxidia, Sarcosporidia and Haplosporidia, the parasites included in the last named order being of comparatively simple structure, and probably near the base of this section. There are, in addition, various other forms (Sero- and Exo-sporidia), also primitive in character, but which are as yet too insufficiently known for it to be certain whether they are of distinct ordinal rank, or should be placed with the Haplosporidia.

The nomenclature assigned to these two principal divisions of the Sporozoa by different writers has varied according to the particular character on which they have primarily based the arrangement. Of late years, the terms Telosporidia and Neosporidia, proposed by F. Schaudinn (1900), have been most in favour. In the Telosporidia (comprising the Gregarines, Coccidia and Haemosporidia), sporulation does not begin until the close of the vegetative or trophic period, *i.e.* until growth has ceased; in the Neosporidia (including the remaining orders) growth and sporulation go on coincidentally. Recently, however, considerable doubt has been thrown upon the general occurrence of this latter condition in certain Myxosporidia (*Microsporidia*); and the present writer adopts as preferable, therefore, the terms *Ectospora* and *Endospora* (*qq.v.*), invented by E. Metschnikoff and made use of by F. Mesnil (1899), which indicate a universal distinction between the two groups in their manner of sporulation. This distinction is probably the most fundamental one, and itself supports a conclusion which is, on other grounds, becoming more and more likely, namely, that these two divisions are not related phylogenetically; but have, on the contrary, a radically different origin. In other words, under the heading Sporozoa, as at present used, are included two entirely independent series of Protozoan parasites; the general resemblances which these exhibit are due to convergence brought about by their specialized mode of life.

The most recent and comprehensive account of the group is that by E. A. Minchin (in Lankester's *Treatise on Zoology*, pt. i., London, 1903), to which the present writer is much indebted; another useful treatise is that of F. Doflein, *Die Protozoen als Parasiten u. Krankheitserreger* (G. Fischer, Jena, 1901). Earlier accounts are those of M. Lühe, *Ergebnisse der neuen Sporozoenforschung* (Jena, 1900); Wasielewski, *Sporozoenkunde* (Jena, 1896); Y. Delage and E. Hérouard in *Traité de zoologie concrète*, pt. i., Paris, 1896; E. R. Lankester, art. "Protozoa" in *Ency. Brit.* 9th ed. (1886), and O. Bütschli in Bronn's *Klassen u. Ordnungen des Tierreichs*, I. i. (1882). There is a systematic enumeration of the group by A. Labbé in *Das Tierreich*, 5. (Berlin, 1899); and the classification and phylogeny are considered by E. Mesnil (*Soc. Biol.*, vol. jub. p. 258, Paris, 1899), and by H. Crawley in *Amer. Nat.* (1905), xxxix. 607.

(H. M. Wo.)

SPORRAN (Gaelic *sporan*, purse, pouch), a pouch which is worn, in Highland costume, hanging from the belt over the front of the kilt. The older sporrans were quite modest objects and ordinarily of leather; in modern Highland costume and in the uniform of Highland kilted regiments it has become a highly ornamental adjunct, with silver or metal rims, and a heavy long backing of horsehair or fur.

SPORT (a contracted or shortened form of "disport," to amuse, divert oneself, O. Fr. *se disporter* or *deporter*, to leave off work, hence to play, Lat. *dis-*, away, and *portare*, to carry; the origin of the meaning lies in the notion of turning away from serious occupations, cf. "diversion"), play, amusement, entertainment or recreation. The term was applied in early times to all forms of pastime. It was, however, particularly used of out-of-door or manly recreations, such as shooting with the bow, hunting and the like. Modern usage has given several meanings to "sport" and "sports." Generally speaking "sport" includes the out-of-door recreations, the "field-sports," such as fishing, shooting, fox-hunting, &c., connected with the killing or hunting of animals as opposed to organized "games," which are contests of skill or strength played according to rules. It also includes the special class of horse-racing, the votaries of which, and also of the prize-ring, have arrogated to themselves sometimes the name of "sportsman," applying that word even to those who follow racing simply as an occasion for betting. On the other hand, the plural "sports" is generally confined to athletic contests such as running, jumping, &c. (see **ATHLETIC SPORTS** and subsidiary articles).

In zoology and botany the word has a specific meaning of a sudden or singular variation from type, a "diversion" in a more etymological sense of the term.

SPORTS, THE BOOK OF, or more properly the **DECLARATION OF SPORTS**, an order issued by James I. in 1617 on the recommendation of Thomas Morton, bishop of Chester, for use in Lancashire, where the king on his return from Scotland found a conflict on the subject of Sunday amusements between the Puritans and the gentry, many of whom were Roman Catholics. Permission was given for dancing, archery, leaping, vaulting and other harmless recreations, and of "having of May games, Whitsun ales and morris dances, and the setting up of May-poles and other sports therewith used, so as the same may be had in due and convenient time without impediment or neglect of divine service, and that women shall have leave to carry rushes to church for the decorating of it." On the other hand, "bear and bull-baiting, interludes, and (at all times in the meane sort of people by law prohibited) bowling" were not to be permitted on Sunday (Wilkins, *Concilia*, iv. 483). In 1618 James transmitted orders to the clergy of the whole of England to read the declaration from the pulpit; but so strong was the opposition that he prudently withdrew his command (Wilson, in Kennet, ii. 709; Fuller, *Church History*, v. 452). In 1633 Charles I. not only directed the republication of his father's declaration (Rushworth, ii. 193) but insisted upon the reading of it by the clergy. Many of the clergy were punished for refusing to obey the injunction. With the fall of Laud all attempts to enforce it necessarily came to an end.

SPOTSWOOD (SPOTTSWOOD or SPOTTISWOOD), **ALEXANDER** (1676-1740), American colonial governor, was born, of an old Scotch family, in Tangier, Africa, in 1676. He served under Marlborough in the War of the Spanish Succession, and was wounded at Blenheim. He became lieutenant governor of Virginia in June 1710, when he was received with some enthusiasm, because he brought to the colony the privilege of *habeas corpus*; his term as governor closed in September 1722—probably because he meddled in ecclesiastical matters; but he remained in Virginia, living near his ironworks in Germanna, a settlement of Germans, on the Rapidan in Spottsylvania county (named in his honour) and he was deputy postmaster-general of the colonies from 1730 to 1739. He was the first representative of the British government in America who fully appreciated the value of the western territory. As governor he recommended the establishment of a Virginia company to carry on trade with the

Indians, he urged upon the provincial government and also upon the British authorities the wisdom of constructing forts along the frontier, and he personally organized and conducted an exploring expedition (Aug. 17 to Sept. 20, 1716) into the Shenandoah Valley reaching the water-parting between the Atlantic and the Ohio river.¹ These ambitious and expensive schemes, coupled with his haughty and overbearing conduct, involved him in a controversy with the rather niggardly House of Burgesses. He developed the iron industry of Virginia, promoted the religious education of the Indians and tried to advance the interests of education, and especially of the College of William and Mary. In 1740 he was commissioned major-general to conduct the expedition against Cartagena, but died while attending to the embarkation, at Annapolis, Maryland, on the 7th of June 1740. His library he left to the College of William and Mary.

See R. A. Brock (ed.), "The Official Letters of Alexander Spotswood" (with a memoir), in *The Collections of the Virginia Historical Society* (2 vols., Richmond, 1882-1885).

SPOTTISWOODE (SPOTTISWOOD, SPOTISWOOD or SPOTSWOOD), **JOHN** (1565-1639), archbishop of St Andrews and historian of Scotland, eldest son of John Spottiswood, minister of Calder and "superintendent" of Lothian, was born in 1565. He was educated at Glasgow University (M.A. 1581), and succeeded his father in the parish of Calder in 1583. In 1601 he attended Ludowick, duke of Lennox, as his chaplain, in an embassy to the court of France, returning in 1603. He followed James to England on his accession, but was the same year nominated to the see of Glasgow, his consecration in London, however, not taking place until October 1610. Spottiswoode had originally become prominent as an ardent supporter of the strict Presbyterian party, but gradually came to see the inconveniences of "parity in the Church," attributed little importance to the existing matters of dispute, and thought that the interests of both church and state were best secured by keeping on good terms with the king. He was therefore ready to co-operate with James in curtailing the powers of the Kirk which encroached on the royal authority, and in assimilating the church of Scotland to that of England. On the 30th of May 1605 he became a member of the Scottish privy council. In 1610 he presided as moderator over the assembly in which presbytery was abolished, in 1615 he was made archbishop of St Andrews and primate of Scotland, and in 1618 procured the sanction of the privy council to the Five Articles of Perth with their ratification by parliament in 1621. In 1633 he crowned Charles I. at Holyrood. In 1635 he was appointed lord chancellor of Scotland, an office which he retained till 1638. He was opposed to the new liturgy as inexpedient, but when he could not prevent its introduction he took part in enforcing it. He was a spectator of the riot of St Giles's, Edinburgh, on the 23rd of July 1637, endeavoured in vain to avoid disaster by concessions, and on the taking of the Covenant perceived that "now all that we have been doing these thirty years past is thrown down at once." He escaped to Newcastle, was deposed by the assembly on the 4th of December on a variety of ridiculous charges, and died in London on the 26th of November 1639, receiving burial in Westminster Abbey. Spottiswoode published in 1620 *Refutatio libelli de regimine ecclesiae scoticanæ*, an answer to a tract of Calderwood, who replied in the *Vindiciae* subjoined to his *Altare damascenum*, (1623). The only other writing published during his lifetime was the sermon he preached at the Perth assembly. His most considerable work was *The History of the Church and State of Scotland* (London, 1655, seq.). It displays considerable research and sagacity, and even when dealing with contemporary events, gives a favourable impression, upon the whole, of the author's candour and truth. The opposite side can be studied in Calderwood's *History*.

Spottiswoode married Rachel, daughter of David Lindsay, bishop of Ross, and besides a daughter left two sons, Sir John Spottiswoode of Dairsie in Fife, and Sir Robert, president of

¹ To each of his comrades in this journey Spotswood presented a small golden horseshoe, lettered "Sic juvat transcendere montes."

the Court of Session, who was captured at the battle of Philiphaugh in 1645 and executed in 1646.

See the accounts prefixed to the first edition of Spottiswoode's *History of Scotland* and to that published by the Spottiswoode Society in 1851; also David Calderwood's *Hist. of the Kirk of Scotland* (1842-1849).

SPOTTISWOODE, WILLIAM (1825-1883), English mathematician and physicist, was born in London on the 11th of January 1825. His father, Andrew Spottiswoode, who was descended from an ancient Scottish family, represented Colchester in parliament for some years, and in 1831 became junior partner in the firm of Eyre & Spottiswoode, printers. William was educated at Laleham, Eton, Harrow and Balliol College, Oxford. His bent for science showed itself while he was still a schoolboy, and indeed his removal from Eton to Harrow is said to have been occasioned by an accidental explosion which occurred whilst he was performing an experiment for his own amusement. At Harrow he obtained in 1842 a Lyon scholarship, and at Oxford in 1845 a first-class in mathematics, in 1846 the junior and in 1847 the senior university mathematical scholarship. In 1846 he left Oxford to take his father's place in the business, in which he was engaged until his death. In 1847 he issued five pamphlets entitled *Meditationes analyticae*. This was his first publication of original mathematical work; and from this time scarcely a year passed in which he did not give to the world further mathematical researches. In 1856 Spottiswoode travelled in eastern Russia, and in 1860 in Croatia and Hungary; of the former expedition he has left an interesting record entitled *A Taran-tasse Journey through Eastern Russia in the Autumn of 1856* (London, 1857). In 1870 he was elected president of the London Mathematical Society. In 1871 he began to turn his attention to experimental physics, his earlier researches bearing upon the polarization of light and his later work upon the electrical discharge in rarefied gases. He wrote a popular treatise upon the former subject for the "Nature" Series (1874). In 1878 he was elected president of the British Association, and in the same year president of the Royal Society, of which he had been a fellow since 1853. He died in London of typhoid fever on the 27th of June 1883, and was buried in Westminster Abbey.

As a mathematician he occupied himself with many branches of his favourite science, more especially with higher algebra, including the theory of determinants, with the general calculus of symbols, and with the application of analysis to geometry and mechanics. The following brief review of his mathematical work is quoted from the obituary notice which appeared in the *Proceedings of the Royal Society* (xxxviii. 34): "The interesting series of communications on the contact of curves and surfaces which are contained in the *Philosophical Transactions* of 1862 and subsequent years would alone account for the high rank he obtained as a mathematician. . . . The mastery which he had obtained over the mathematical symbols was so complete that he never shrank from the use of expressions, however complicated—nay, the more complicated they were the more he seemed to revel in them—provided they did not sin against the ruling spirit of all his work—symmetry. To a mind imbued with the love of mathematical symmetry the study of determinants had naturally every attraction. In 1851 Mr Spottiswoode published in the form of a pamphlet an account of some elementary theorems on the subject. This having fallen out of print, permission was sought by the editor of *Crelle* to reproduce it in the pages of that journal. Mr Spottiswoode granted the request and undertook to revise his work. The subject had, however, been so extensively developed in the interim that it proved necessary not merely to revise it but entirely to rewrite the work, which became a memoir of 116 pages. To this, the first elementary treatise on determinants, much of the rapid development of the subject is due. The effect of the study on Mr Spottiswoode's own methods was most pronounced; there is scarcely a page of his mathematical writings that does not bristle with determinants." His papers, numbering over 100, were published principally in the *Philosophical Transactions*, *Proceedings of the Royal Society*, *Quarterly Journal of Mathematics*, *Proceedings of the London Mathematical Society* and *Crelle*, and one or two in the *Comptes rendus* of the Paris Academy; a list of them, arranged according to the several journals in which they originally appeared, with short notes upon the less familiar memoirs, is given in *Nature*, xxvii. 599.

SPOTTISYLVANIA, a county of Virginia, U.S.A., so called after Alexander Spotswood (*q.v.*), lieutenant governor of Virginia in 1710-1722, who owned extensive estates and mines therein. It is

bounded on the N. by the Rapidan and Rappahannock rivers and on the S. by the North Anna. It is celebrated as containing several of the most famous battlefields of the Civil War—Fredericksburg, Chancellorsville, the Wilderness, and particularly that of Spottsylvania Court House, where the armies of Grant and Lee contended for nearly two weeks (May 8-21, 1864). The battles of Chancellorsville, Wilderness and Spottsylvania are described in the article WILDERNESS.

SPOUSE, (O. Fr. *espous*, mod. *époux*, *espouse*, *épouse*, Lat. *sponsus*, *sponsa*, a betrothed or promised man or woman, from *spondere*, to promise), a husband or wife, properly one promised or betrothed to another in marriage.

SPRAT, THOMAS (1635-1713), English divine, was born at Beaminster, Dorsetshire, and educated at Wadham College, Oxford, where he held a fellowship (1657-1670). Having taken orders he became a prebendary of Lincoln in 1660. In the preceding year he had gained a reputation by his poem *To the Happy Memory of the most Renowned Prince Oliver, Lord Protector* (London, 1659), and he was afterwards well known as a wit, preacher and man of letters. His chief prose works are the *Observations upon Monsieur de Sorbier's Voyage into England* (London, 1665), a satirical reply to the strictures on Englishmen in Samuel de Sorbière's book of that name, and a *History of the Royal Society of London* (London, 1667), which Sprat had helped to found. In 1669 he became canon of Westminster, and in 1670 rector of Uffington, Lincolnshire. He was chaplain to Charles II. in 1676, curate and lecturer at St Margaret's, Westminster, in 1679, canon of Windsor in 1681, dean of Westminster in 1683 and bishop of Rochester in 1684. He was a member of James II.'s ecclesiastical commission, and in 1688 he read the Declaration of Indulgence to empty benches in Westminster Abbey. Although he opposed the motion of 1689 declaring the throne vacant, he assisted at the coronation of William and Mary. As dean of Westminster he directed Wren's restoration of the abbey. He died on the 20th of May 1713.

SPRAT, a marine fish (*Clupea sprattus*), named "garvie" in Scotland, one of the smallest species of the genus *Clupea* or herrings, rarely exceeds 5 in. in length, and occurs in large shoals on the Atlantic coasts of Europe. Sprats are very often confounded with young herrings, which they much resemble, but can always be distinguished by the following characters: they do not possess any teeth on the palate (vomer), like herrings; their gill-covers are smooth, without the radiating striae which are found in the shad and the pilchard; the anal fin consists of from seventeen to twenty rays, and the lateral line of forty-seven or forty-eight scales. The ventral fins are slightly anterior to the origin of the dorsal fin; and the spine consists of from forty-seven to forty-nine vertebrae. The sprat spawns in the open sea from February to May and is only occasionally captured in the ripe condition. Its eggs are buoyant and pelagic and easily recognized. The sprat is one of the more important food-fishes on account of the immense numbers which are caught when the shoals approach the coasts. They are somewhat capricious, however, as regards the place and time of their appearance, the latter falling chiefly in the first half of winter. They are caught with the seine or with the bag-net in the tideway. Large quantities are consumed fresh, but many are pickled or smoked and others prepared like anchovies. Frequently the captures are so large that the fish can be used as manure only.

SPRATT, THOMAS ABEL BRIMAGE (1811-1883), English vice-admiral, hydrographer and geologist, was born at East Teignmouth on the 11th of May 1811. He was the eldest son of Commander James Spratt, R.N., and entered the navy in 1827. He was attached to the surveying branch, and was engaged almost continuously until 1863 in surveying the Mediterranean. As commander of the "Spitfire" he rendered distinguished service in the Black Sea during the Crimean War, and was appointed C.B. in 1855. At an earlier date he was associated with Edward Forbes, then naturalist to the "Beacon," and during the years 1841-1843 they made observations on the bathymetrical distribution of marine life. To Forbes he was specially indebted for his interest in natural history and geology,

and together they published *Travels in Lycia, &c.* (1847). Spratt investigated the caves at Malta and obtained remains of the pigmy elephant (*Elephas melitensis*), which was described by Dr H. Falconer. He investigated the geology of several Greek islands, also the shores of Asia Minor, and made detailed observations on the Delta of the Nile. He was especially distinguished for his *Travels and Researches in Crete* (2 vols., 1865), in which he ably described the physical geography, geology, archaeology and natural history of the island. He was commissioner of fisheries from 1866 to 1873; and acting conservator of the Mersey from 1879 until the close of his life. He died at Tunbridge Wells on the 10th of March 1888.

SPRECKELS, CLAUS (1828–1908), American capitalist, was born in Lanstedt, Hanover, in 1828. In 1846, to escape army service, he emigrated to the United States and became a grocer. In 1856 he removed from New York City to San Francisco, where he set up as a grocer, then a brewer, and later a sugar refiner. He gradually obtained control of most of the sugar refineries on the Pacific coast; he was able to undersell his competitors because he bought his raw sugar in Hawaii, where he purchased large plantations and contracted for the produce of others. He built a large refinery in Hawaii, and his influence with the Hawaiian government was for a time paramount. By financing the Pacific Steamship Company he was able to reduce the freight charges on his sugar, and he also introduced various improvements in the methods of manufacture. It was he who built the railway from Salinas to San Francisco, by buying which the Atchison, Topeka & Santa Fé first made a through line into San Francisco. Spreckels died in San Francisco on the 26th of December 1908. His eldest son, John Friedrich Spreckels (b. 1853), became proprietor of the *San Francisco Morning Call* and succeeded to his father's steamship interests; and another son, Rudolph Spreckels (1873–), became president of the First National Bank of San Francisco.

SPREE, a river of Prussia, Germany, rising in the district of Upper Lusatia, in the kingdom of Saxony, close to the Bohemian frontier, and flowing nearly due north past Bautzen, Spremberg and Cottbus, dividing between the first two towns for a time into two arms. Below Cottbus the river splits into a network of channels, and swings round in a big curve to the west forming the peculiar marshy region (30 m. long and 3 to 6 m. wide) known as the Spreewald. Having returned to its predominant direction, it turns W.N.W., and passing Fürstenwalde and Köpenick threads Berlin in several arms, and joins the Havel at Spandau. Its length is 227 m. of which 112 are navigable; the area of its drainage basin is 3660 sq. m. It is connected with the Oder by the Friedrich Wilhelm or Müllrose Canal made in 1862–1868, which is 17 m. long, and by the Oder-Spree Canal, made in 1887–1888, and with the Havel by the Berlin-Spandau Navigation Canal, 5½ m. long, and by the Teltow Canal completed in 1905.

SPREEWALD, a district of Germany, in the Prussian province of Brandenburg, a marshy depression of the middle Spree valley, extending to some 106 sq. m., its length being 27 m. and its width varying from 1 to 7 m. It owes its marshy character to the river Spree, which above Lübben splits into a network of over two hundred arms, and in seasons of flood generally overflows considerable portions of the region. In the parts which are especially liable to inundation, as, for example, the villages of Lehde, Leipe and Burg, many of the homesteads are built each on a little self-contained island, approachable in summer only by boat, and in winter over the ice. In spite of its marshy character the Spreewald is in part cultivated, in part converted into pasturage, and almost everywhere, but more especially in the lower districts, wooded like a park, the predominant trees being willows. Fishing, cattle-breeding and the growing of vegetables, more particularly small pickling cucumbers, are the chief occupations of the people, about 30,000 in all. In great part they are of Wendish blood, and though the majority have been Germanized, there is a small residue who have faithfully preserved their national speech, customs, and their own peculiar styles of dress. The attractive

blending of wood and water makes the Spreewald in summer a resort of the people of the Prussian capital, but also in winter the district is largely visited by people bent on skating, sleighing and other winter pastimes. The chief town is Lübben, 45 m. south from Berlin on the railway to Görlitz.

See W. von Schulenburg, *Wendische Volkssagen und Gebräuche aus dem Spreewald* (Leipzig, 1880); Kühn, *Der Spreewald und seine Bewohner* (Cottbus, 1889); and Braunsdorf, *Spreewaldfahrten* (Lübbenau, 1901).

SPREMBERG, a town of Germany, in the Prussian province of Brandenburg, situated partly on an island in the river Spree and partly on the west bank, 76 m. S.E. of Berlin by the railway to Görlitz. Pop. (1905) 11,188. There are a Roman Catholic and two Evangelical churches, a pilgrimage chapel, dating from 1100, a ducal château, built by a son of the elector John George about the end of the 16th century (now utilized as government offices), classical, technical and commercial schools and a hospital. It carries on considerable manufactures of woollen cloth.

SPRENGEL, KURT (1766–1833), German botanist and physiologist, was born on the 3rd of August 1766 at Bodelkow in Pomerania. His uncle, Christian Konrad Sprengel (1750–1816), is remembered for his studies in the fertilization of flowers by insects—a subject in which he reached conclusions many years ahead of his time. His father, a clergyman, provided him with a thorough education of wide scope; and the boy at an early age distinguished himself as a linguist, not only in Latin and Greek, but also in Arabic. He appeared as an author at the age of fourteen, publishing a small work called *Anleitung zur Botanik für Frauenzimmer* in 1780. In 1784 he began to study theology and medicine at the university of Halle, but soon relinquished the former. He graduated in medicine in 1787. In 1789 he was appointed extraordinary professor of medicine in his *alma mater*, and in 1795 was promoted to be ordinary professor. He devoted much of his time to medical work and to investigations into the history of medicine; and he held a foremost rank as an original investigator both in medicine and botany. Among the more important of his many services to the latter science was the part he took in awakening and stimulating microscopic investigation into the anatomy of the tissues of the higher plants, though defective microscopic appliances rendered the conclusions arrived at by himself untrustworthy. He also made many improvements in the details of both the Linnaean and the “natural” systems of classification. He died of an apoplectic seizure at Halle on the 15th of March 1833.

Sprengel's more important works were: *Beiträge zur Geschichte des Pulses* (1787); *Galens Fieberlehre* (1788); *Apologie des Hippocrates* (1789); *Versuch einer pragmatischen Geschichte der Arzneikunde* (1792–1799); *Handbuch der Pathologie* (1795–1797); *Institutiones medicæ* (6 vols., 1809–1816); *Geschichte der Medicin* (completed in 1820); *Antiquitatum botanicarum specimen* (1798); *Historia rei herbariæ* (1807–1808); *Anleitung zur Kenntniss der Gewächse* (1802–1804; and again 1817–1818); *Geschichte der Botanik* (1817–1818); *Von dem Bau und der Natur der Gewächse* (1812); *Flora halensis* (1806–1815; and in 1832); *Species umbelliferarum minus cognitæ* (1818); *Neue Entdeckung im ganzen Umfang der Pflanzenkunde* (1820–1822). He edited an edition of Linnaeus's *Systema vegetabilium* in 1824 and of the *Genera plantarum* in 1830. A list of his botanical papers from 1798 onwards will be found in the Royal Society's *Catalogue of Scientific Papers*.

SPRENGER, JAKOB (fl. 1500), the Dominican inquisitor of Cologne, who with Heinrich Krämer (institor) published *Malleus maleficarum* or *Hexenhammer*, the standard textbook on witchcraft, especially in Germany. The book gives (1) evidences of witchcraft; (2) rules for discovering it; (3) proceedings for punishment.

SPRENGTPORTEN, GÖRAN MAGNUS, COUNT (1740–1819), Swedish and Russian politician, younger brother of Jakob Magnus Sprengtporten, entered the army and rose to the rank of captain during the Seven Years' War. He assisted his brother in the revolution of 1772, and in 1775 was made a colonel and brigadier in east Finland. Here he distinguished himself greatly as an organizer and administrator. The military school which he founded at Brahelinnä subsequently became a state

institution. Irritable and suspicious like his brother he also came to the conclusion that his services had not been adequately appreciated, and the flattering way in which he was welcomed by the Russian court during a visit to St Petersburg in 1779 still further incensed him against the purely imaginary ingratitude of his own sovereign. For the next two years he was in the French service, returning to Finland in 1781. It was now that he first conceived the plan of separating the grand duchy from Sweden and erecting it into an independent state under the protection of Russia. During the *riksdag* of 1786 he openly opposed Gustavus III., at the same time engaging in a secret and treasonable correspondence with the Russian ministers with the view of inducing them to assist the Finns by force of arms. In the following year, at the invitation of Catherine II., he formally entered the Russian service. When the Russo-Swedish War of 1788-90 began, Sprengtporten received the command of a Russian army corps directed against Finland. He took no direct part in the Anjala conspiracy (see SWEDEN: *History*), but urged Catherine to support it more energetically. His own negotiations with his fellow countrymen, especially after Gustavus III. had brought the Finlanders back to their allegiance, failed utterly. Nor was he able to serve Russia very effectively in the field for he was seriously wounded at the battle of Parosalmi (1790). At the end of the war, indeed, his position was somewhat precarious, as the High Court of Finland condemned him as a traitor, while Catherine regarded him as an incompetent impostor who could not perform his promises. For the next five years, therefore (1793-1798), he thought it expedient to quit Russia and live at Töplitz in Bohemia. He was re-employed by the emperor Paul who, in 1800, sent him to negotiate with Napoleon concerning the Maltese Order and the interchange of prisoners. After Paul's death Sprengtporten was again in disgrace for seven years, but was consulted in 1808 on the eve of the outbreak of hostilities with France. On the 1st of December 1808 he was appointed the first Russian governor-general of Finland with the title of count, but was so unpopular that he had to resign his post the following year. The last ten years of his life were lived in retirement.

See *Finska Tidskrift* (Helsingfors, 1877-1889); and *Svenska Literatur-sällskapets i Finland förhandlingar* (Helsingfors, 1887).

(R. N. B.)

SPRENGTPORTEN, JAKOB MAGNUS (1727-1786), Swedish soldier and politician. In his twelfth year he chose the profession of arms, and served his country with distinction. The few and miserable triumphs of Sweden during the Seven Years' War were due almost entirely to young Sprengtporten, and he emerged from it with a lieutenant-colonelcy, a pension of £20, and the reputation of being the smartest officer in the service. Sprengtporten, above all things a man of action, had too hearty a contempt for "Hats" and "Caps" to belong to either. He regarded the monstrous system of misrule for which they were primarily responsible with indignation, made no secret of his sentiments, and soon gathered round him a band of young officers of strong royalist proclivities, whom he formed into a club, the so-called *Svenska Botten* (Sweden's groundwork). The club was suppressed by the dominant "Caps," who also sought to ruin Sprengtporten financially by inciting his tenants in Finland to bring actions against him for alleged extortion, not in the ordinary courts but in the *riksdag* itself, where Sprengtporten's political adversaries would be his judges. The enraged Finnish colonel thereupon approached Gustavus III. with the project of a revolution against their common enemies, the "Caps." It was to begin in Finland where Sprengtporten's regiment, the Nyland dragoons, was stationed. He undertook to seize the impregnable fortress of Sveaborg by a *coup de main*. The submission of the whole grand duchy would be the natural consequence of such a success, and, Finland once secured, Sprengtporten proposed at the head of his Finns to embark for Sweden, meet the king and his friends near Stockholm, and surprise the capital by a night attack. This plan, subsequently enlarged by a suggestion of a fellow plotter, J. K. Toll (*q.v.*),

was warmly approved of by the king. On the 22nd of July 1772 Sprengtporten left Stockholm. On the 9th of August he reached Helsingfors. On the 16th he persuaded the fortress of Sveaborg to submit to him. Helsingfors followed the example of Sveaborg. A week later all Finland lay at the feet of the intrepid colonel of the Borgå dragoons. By the 23rd of August Sprengtporten was ready to re-embark for Stockholm with 780 men, but contrary winds kept him back, and in the meantime Gustavus III. himself had carried out his revolution unaided. On his return to Sweden, however, Sprengtporten was received with the greatest distinction and made a lieutenant-general and colonel of the guards. He was also appointed the president of a commission for strengthening the defences of Finland. But Sprengtporten was still dissatisfied. He could never forgive Gustavus for having forestalled the revolution, and his morbidly irritable and suspicious temper saw slights and insults in the most innocent conjunctures. His first quarrel with Gustavus happened in 1774 when he refused to accept the post of commander-in-chief in Finland on the eve of threatened war with Russia. The king good-naturedly overlooked his outrageous insolence on this occasion, but the inevitable rupture was only postponed. A most trumpery affair brought matters to a head. Sprengtporten had insulted the guards by giving precedence over them at a court-martial to some officers of his own dragoons. The guards complained to the king, who, after consulting with the senate, mildly remonstrated with Sprengtporten by letter. Sprengtporten thereupon tendered his resignation as colonel of the guard, and at a personal interview with Gustavus was so violent and insolent that anything like agreement between them became impossible. Sprengtporten was haunted by the fixed idea that the *jeunesse dorée* of the court was in league with his old enemies to traduce and supplant him, and not all the forbearance of the king could open his eyes. He received a pension of £2400 a year on his retirement and was allowed the extraordinary privilege of a guard of honour as long as he lived. Nevertheless, to the end of his career, he continued to harass and annoy his long-suffering benefactor with fresh impertinences.

See R. N. Bain, *Gustavus III. and his Contemporaries*, vol. i. (London, 1895); C. Julin, *Gustavus III. och J. M. Sprengtporten*, *sv. Hist. Tid.* (Stockholm, 1903).

(R. N. B.)

SPRING (from "to spring," "to leap or jump up," "burst out," O. Eng., *springan*, a common Teut. word, cf. Ger. *springen*, possibly allied to Gr. *σπέρχασθαι*, to move rapidly), primarily the act of springing or leaping. The word is hence applied in various senses: to the season of the year in which plant life begins to bud and shoot; to a source of water springing or welling up from below the surface of the earth and flowing away as a stream or standing in a pool (see WATER SUPPLY); or to an elastic or resilient body or contrivance for receiving and imparting mechanical power. The most common form in which springs in this last sense are made is that of a spiral coil of wire or narrow band of steel. There are many uses to which they are put, e.g. for communicating motion, as in a clock or watch (*qq.v.*), or for relieving concussion, as in the case of carriages (*q.v.*).

SPRINGBUCK, or SPRINGBOK (*Antidorcas euchores*), an aberrant South African gazelle inhabiting the country south of the Zambezi, but ranging north-westwards to Mossamedes. In the more settled parts of Cape Colony, the Transvaal and the Orange Free State it now only exists within the enclosures of the large farms, and can hardly be said to be any longer truly wild. Both sexes carry lyrate horns; the shoulder-height of an adult male is about 30 in., and an average pair of horns measures 14 in. along the curve; in the female the horns are more slender. The general colour above is reddish fawn, separated from the white of the under-parts by a dark band on the flanks. Along the middle of the hinder half of the back is a line of long erectile white hairs, forming the "fan," continued down over the rump; in repose this is concealed by the surrounding hair, but is conspicuously displayed when the animal takes the great leaps from which it derives its popular name. The periodical migrations of springbuck are well known, and though the *tracks* are

small compared with those of about 1850, they still include very large herds. In 1896 there was a great *trek*, and about then in the north of Cape Colony a herd was seen which was estimated at 500,000 head.

SPRINGER, ANTON HEINRICH (1825-1891), German writer, was born at Prague on the 13th of July 1825 and was educated at the university of his native city. Taking an interest in art, he visited Munich, Dresden and Berlin, and spent some months in Italy; afterwards he settled at Tübingen and in 1848 he returned to Prague and began to lecture at his own university on the history of the revolutionary epoch. The liberal tone of these lectures brought him into disfavour with the ruling authorities, and in 1849 he left Bohemia and passed some time in England, France and the Netherlands. In 1852 he settled at Bonn, where he lectured on art and became a professor in 1859; in 1872 he went to the university of Strassburg and in 1873 to Leipzig. As a journalist and a publicist Springer advocated the federal union of the states ruled by the Austrian emperor, and asserted the right of Prussia to the headship of Germany; during the Crimean War he favoured the emancipation of the small states in the south-east of Europe from Turkish supremacy. After many years of feeble health, he died at Leipzig on the 31st of May 1891.

Springer is known as a writer both on history and on art. In the former connexion his most important work is his *Geschichte Oesterreichs seit dem wiener Frieden* (Leipzig, 1863-1865), which has been translated into Czech (Prague, 1867). His other historical works are: *Geschichte des Revolutionszeitalters* (Prague, 1849); *Oesterreich nach der Revolution* (Prague, 1850); *Oesterreich, Preussen und Deutschland* (Prague, 1851); *Paris im xiii. Jahrhundert* (Leipzig, 1856); and *Protokolle des Verfassungs-Ausschusses im oesterreichischen Reichstage 1848-1849* (Leipzig, 1885). His principal works on art are: *Baukunst des christlichen Mittelalters* (Bonn, 1854); the valuable *Handbuch der Kunstgeschichte* (7th ed., Leipzig, 1906), a revised edition of his *Grundzüge der Kunstgeschichte* (Leipzig, 1887-1888); *Geschichte der bildenden Künste im xix. Jahrhundert* (Leipzig, 1858); *Bilder aus der neueren Kunstgeschichte* (Bonn 1867, and again 1886); *Raffaël und Michelangelo* (Leipzig, 1877 and 1885); and *Die Kunst des xix. Jahrhunderts* (Leipzig 1880-1881). Springer wrote two biographies: *Friedrich Christoph Dahlmann* (Leipzig, 1870-1872), and *Albrecht Dürer* (Berlin, 1892); and was responsible for the German edition of Crowe and Cavalcaselle's *Lives of the Early Flemish Painters*, which was published at Leipzig in 1875. His book of reminiscences, *Aus meinem Leben* (Berlin, 1892), containing contributions by G. Freytag and H. Janitschek, was edited by his son Jaro Springer (b. 1856), who is also known as a writer on art.

SPRINGER (Fr. *rein*), the term given in architecture to the stone from which an arch springs (see ARCH); in some cases this is the stone resting on the impost or capital, the upper surface of which is a plane directed to the centre of the arch. In vaulting, however, where the lower stone of the arch or rib is laid in horizontal courses, so as to bond it well into the wall, constituting a system of construction known in France as the *tas-de-charge*, the springer may be considerably higher. The term is sometimes applied to the lowest stone of a gable.

SPRINGFIELD, the capital of Illinois, U.S.A., and the county-seat of Sangamon county, on the Sangamon river, in the central part of the state. Pop. (1890), 24,963; (1900), 34,159, of whom 4654 were foreign-born (1940 Germans, 1106 Irish and 499 English) and 2227 negroes; (1910 census) 51,678. Land area (1906), 7.07 sq. m., of which 3.37 sq. m. had been annexed since 1890. It is served by the Baltimore & Ohio South-Western, the Chicago & Alton, the Chicago, Peoria & St Louis, the Illinois Central, the Wabash, and the Cincinnati, Hamilton & Dayton railways, and by inter-urban electric lines. The city has a park and a boulevard system; the principal parks are Washington, Lincoln, Reservoir and Mildred. The chief public building is the state capitol (built in 1868-1888 at a cost of about \$4,500,000), in the form of a Greek cross, with porticoes of granite and a dome 361 ft. high. It is the fifth state capitol of Illinois and the second erected in Springfield. Other prominent buildings are the Supreme Court building, the county court house (the old state capitol, finished in 1853), the city-hall, the state arsenal, the high school and the public library. In Oak Ridge cemetery, adjacent to the city, is the Lincoln monument, erected over Abraham Lincoln's grave with funds raised throughout

the country by a Lincoln Monument Association. It was designed by Larkin G. Mead, and consists of a granite obelisk 121 ft. above the centre of a mausoleum, which is 119½ ft. long and 72½ ft. wide, and in which there are six crypts for the burial of members of Lincoln's family, and a memorial hall, a museum of Lincolniana. Around the foot of the obelisk (besides an heroic statue of Lincoln) are four groups of figures in bronze, symbolizing the army and navy of the United States. The monument was completed and dedicated in 1874, was transferred to the state in 1895, and restored and in large part rebuilt in 1899-1901. Lincoln's home (erected in 1839 and bought by Lincoln in 1844) in Springfield is well preserved by the state. In the city are the state library (1842), the state law library (1839), the Illinois historical library (1889), of which the State Historical Society (1903) is a department, and the Illinois Supreme Court library; several educational institutions, including Concordia-Seminar (Evangelical Lutheran), the Ursuline Academy (Roman Catholic), and the Academy of the Sacred Heart (Roman Catholic); the Springfield hospital (1897; Lutheran), and the St John's hospital (1875; under the Sisters of St Francis), two orphanages, two homes for aged women, and a sanatorium; the permanent grounds of the State Fair (157 acres), and a state rifle range and militia camp-ground (160 acres). Springfield is a trading and shipping centre for a prosperous agricultural region, and ships large quantities of bituminous coal from the immediate vicinity. The Wabash and the Chicago, Peoria & St Louis railways have large repair shops here. Among the manufactures are agricultural implements, watches and watch material—the Illinois Watch Company has a large factory here—lumber, flour, foundry and machine-shop products, automobiles, shoes and boilers. The total value of the factory product in 1905 was \$5,976,637 (67.2 % more than in 1900). The first settlement was made in 1818. In 1821 the place was chosen to be the county-seat of the newly created Sangamon county and was named Springfield. In 1823 it was platted, and was named Calhoun in honour of John C. Calhoun, but this name was not popular and the former name was soon restored. Springfield was incorporated as a town in 1832 and chartered as a city in 1840. In 1837 the state legislature passed a bill making Springfield the capital, and in December 1839 the legislature first met here.

SPRINGFIELD, a city and the county-seat of Hampden county, Massachusetts, U.S.A., about 99 m. W. by S. of Boston and 26 m. N. of Hartford, Connecticut, on the east bank of the Connecticut river. Pop. (1800), 2312; (1850), 11,766; (1890), 44,179; (1900), 62,059, of whom 14,381 were foreign-born (5462 Irish, 2474 French Canadians, 1144 English-Canadians, 1321 English), 33,710 were of foreign parentage (either parent foreign-born), and 1021 were negroes; (1910, census), 88,926. Springfield is served by the Springfield division of the New York & New England, the Hartford division of the New York, New Haven & Hartford, the Connecticut River division of the Boston & Maine, and the Athol division and the main line of the Boston & Albany railways, and by inter-urban electric railway lines. The river is crossed here by four large bridges. The area of the city, which until 1852 was a township, is 38.53 sq. m. In its extreme eastern part is the small village of Sixteen Acres; north-west of the main part of the city on the Connecticut river is another village, Brightwood (on the Boston & Maine railway) and on the Chicopee river, north-east of the business part of the city, is the village of Indian Orchard, served by the Athol division of the Boston & Albany railway.

The city contains many public and private buildings of architectural importance. Among these are some of the earlier works of H. H. Richardson, such as the Court House, the Union railway station (1889), the Church of the Unity on State Street, and the North Congregational Church. Among other buildings are: Christ Church (Protestant Episcopal) St Michael's Cathedral (Roman Catholic), the South Congregational Church, the Memorial Church, and the Church of the Sacred Heart; the Art Museum (1894-1896), which contains the George Walter Vincent Smith art collection and an art library; the Horace

Smith Hall of Sculpture; the Museum of Natural History (1808), organized in 1859; a group of municipal buildings, with a tower 270 ft. high and a large auditorium; a government building (1801) containing the post office and custom house, the Hampden County Hall of Records, the City Library with 175,000 volumes, and two branch libraries given by Andrew Carnegie; a state armoury, and the business buildings of the Springfield Fire & Marine Insurance Company, the Union Trust Company, and the Institution for Savings. The Public Library, the Art Museum, and the Museum of Natural History are controlled by the City Library Association, organized in 1857. In the city are a government arsenal and armoury. The arsenal was established by the Continental Congress during the War of Independence and began to be used as a repository for arms and ammunition about 1777. The armoury, in the midst of a park on Armory Hill immediately east of the railway station, was established in 1794. Here the famous Springfield muskets used by the Federal forces during the Civil War were manufactured (800,000 having been made during that struggle) and it is still the principal manufactory of small arms for the United States army. Springfield has a good system of parks (under a board of park commissioners) with a total acreage of 550 acres. Forest Park (464 acres), in the southern part of the city, is the largest and most attractive; it contains a good zoölogical collection, and in its ponds is one of the finest collections in America of lotus plants and Oriental aquatic flora; at its southern entrance is a monument to President McKinley by Philip Martiny. In Merrick Park, adjoining the City Library, there is St Gaudens's famous statue of "The Puritan," commemorative of Deacon Samuel Chapin, one of the early settlers of the city. In Court Square are a statue of Miles Morgan (1616-1699), an early settler, by J. S. Hartley, and a monument in memory of the soldiers and sailors of the Civil War. In Carew Triangle in the northern part of the city is a monument in honour of soldiers of the Spanish-American War. In the suburbs of the city is Hampden Park, once a famous race track. There are two large cemeteries, in one of which are buried many of Springfield's famous men, including Samuel Bowles and J. G. Holland, whose grave is marked by a medallion by St Gaudens. Among the hospitals are the Mercy Hospital (1896, under the Sisters of Divine Providence), the Wesson Memorial (formerly Hampden Homeopathic) Hospital (1900), the Wesson Maternity Hospital (1906), and the Springfield Hospital (1883). The Springfield public school system is excellent, and in addition to the regular high school there are a technical high school, a vocational school, and a kindergarten training school. Other schools in Springfield are: the training school of the International Young Men's Christian Association (1885); the American International College, established in Lowell (1885) as the French-American College for the education of French-Canadians, and now working among various immigrant races; and the MacDuffie school (1890) and the Elms (1866), both schools for girls.

Springfield is noted for the diversity of its industries. In 1905 the capital invested in manufacturing establishments was \$24,081,099, and in the value of its factory products (\$25,860,250, not including those of the U.S. Arsenal; 42.4% more than in 1900) Springfield ranked ninth among the cities of Massachusetts. The largest single item in point of value was the product (\$3,053,008) of the slaughtering and meat-packing establishments. Other important products were foundry and machine-shop products (\$1,749,054); paper goods (\$1,481,427, not including envelopes, which had an additional value of almost \$700,000); cars, automobiles, firearms (besides the Federal arsenal there is the Smith & Wesson revolver factory); and printing and publishing (\$1,165,544).

The principal newspapers are the *Springfield Republican* (Independent; weekly, 1824; morning, 1844), one of the most able and influential journals in New England, which since its establishment by Samuel Bowles (*q.v.*) has been the property of the Bowles family; the *Union* (Republican; morning, evening, and weekly; 1864); the *Daily News* (Democratic; 1880); and

the *Springfield Homestead* (tri-weekly; 1878). The *New England Homestead* (weekly; published by the Orange Judd Company), *Farm and Home*, a semi-monthly, and *Good Housekeeping*, a monthly (published by the Phelps Publishing Company), and the *Kindergarten Review* (monthly, published by the Milton-Bradley Company, who publish other educational matter) are important periodicals.

The city is governed by a mayor, a board of aldermen (one from each of eight wards) and a common council of eighteen members (two or three from each ward, according to population), elected in December every other year. The city owns and operates the waterworks.

Springfield was founded in 1636 by a company of settlers from Roxbury led by William Pynchon (1590-1662). Pynchon, who had been one of the original patentees of the Massachusetts Bay Colony, was dissatisfied with the government of Roxbury, of which he had been a founder. On a trip to the Connecticut Valley he selected a spot for a new colony which should have a limited membership and in which his ideas as to government might be put into execution. Accompanied by a dozen families he removed thither early in 1636. The settlers found there a settlement of Agawam Indians (probably allied with the Pacomtuc), and the settlement was at first known as Agawam. For some time the political affiliation was with the Connecticut river towns in Connecticut, but later the authority of the Massachusetts General Court was recognized. In 1640 the name was changed to Springfield, after the native place of William Pynchon in Essex, England. For several years Pynchon was the dominating influence in the colony, ruling it with the power of an autocrat. In 1650 he published a tract (*The Meritorious Price of Our Redemption*) in which he attacked the Calvinistic doctrine of the atonement, and which was burned on Boston Common by order of the General Court. He was removed from the magistracy and returned to England in 1652. In King Philip's War Springfield was a centre of hostilities. In October 1675 a force of hostile Indians, joined by the hitherto friendly Agawams, surprised the settlers, killed some of them, drove the others into the three fortified houses, and burned the remaining buildings. They were preparing to storm the fortified houses when they were in turn attacked and driven off by a force of militia. Springfield was somewhat out of the track of operations of the warfare between the French and English in America, as it was later in the War of Independence; but men from Springfield served in all these conflicts. In 1777 the armoury was established and the place became an important military supply dépôt for the Continental forces. In July of that year representatives of the New England States and New York met here in convention to consider plans of co-operation for meeting Burgoyne's invasion. During Shays's rebellion there was a riot here in September 1786, and on the 25th of January 1787 the insurgent forces under Daniel Shays attacked the arsenal, but were dispersed by the militia under Brigadier-General William Shepard (1737-1817). Springfield remained little more than a large country market town until the completion of the Boston & Albany railway in 1839. From that time its growth as a railway and manufacturing centre was marked. Springfield was a strong abolition centre before the Civil War, and from here active plans were put in operation for sending material aid in the form of men and arms to the "free state" party in Kansas. The city was chartered in 1852.

See H. M. Burt, *First Century of the History of Springfield* (2 vols., Springfield, 1898-1899); J. E. Tower (ed.), *Springfield, Present and Prospective* (ibid., 1905); M. A. Green, *Springfield, 1636-1886* (ibid., 1888); Moses King, *Handbook of Springfield* (ibid., 1884).

SPRINGFIELD, a city and the county-seat of Greene county, Missouri, U.S.A., in the S.W. part of the state, about 238 m. from St Louis. Pop. (1890), 21,850; (1900), 23,267, of whom 2268 were negroes and 1057 foreign-born; (1910, census), 35,201. It is served by the St Louis & San Francisco, the Missouri Pacific, and the Kansas City, Clinton & Springfield railways. The city is pleasantly situated on the Ozark Dome, about 1300 ft. above sea-level, is regularly laid out on an undulating site, and has

attractive residential districts. The principal building is that of the Federal government (1894), which is built of Indiana cut stone. Springfield is the seat of Loretto Academy, of a state normal school, and of Drury College (co-educational; founded in 1873 by Congregationalists, but now undenominational), which comprises, besides the college proper, an academy, a conservatory of music and a summer school, and which in 1908-1909 had 500 students. Near the city is the Academy of the Visitation under the Sisters of St Chantal. The municipal water-supply is drawn from springs 3 m. north of the centre of the city. There are four large private parks (340 acres) on the outskirts, and two municipal cemeteries—a Confederate cemetery, maintained by associations, the only distinctively Confederate burial ground in Missouri; and a National cemetery, maintained by the United States government. Springfield is one of the two chief commercial centres of this region, which has large mining, fruit, grain, lumber and livestock interests. The jobbing trade is important. Springfield ranks fourth among the manufacturing cities of the state; in 1905 the value of its factory products was \$5,293,315 (28.2% more than in 1900). Flour and grist mill products constituted in 1905 a third of the total; and carriages and wagons ranked next. The St Louis & San Francisco railway has large shops here.

Springfield was settled in the years following 1829, and was laid out in 1833, though the public lands did not pass from the United States for sale until 1837. In 1838 and again in 1846 Springfield was incorporated as a town, and in 1847 was chartered as a city; though government lapsed during much of the time up to 1865, when prosperous conditions became settled. At the opening of the Civil War, Springfield was one of the most important strategic points west of the Mississippi river. In 1861-62 it was occupied or controlled a half dozen times in succession by the Confederate and the Union forces, the latter retaining control of it after the spring of 1862. In the battle of Wilson's Creek (August 10, 1861), fought about 10 m. south of the city, and one of the bloodiest battles of the war, relatively to numbers engaged, a force of about 5500 Union soldiers under General Nathaniel Lyon was defeated by about 10,000 Confederates under Generals Benjamin McCulloch (1811-1862) and Sterling Price. The other occupations and abandonments were unattended by serious conflicts in the immediate vicinity. In January 1863, after Springfield had been made an important Union supply post, it was attacked without success by a Confederate force of about 2000 men under General J. S. Marmaduke. The year 1870 was marked by the arrival of the first railway. In the same year North Springfield was laid out, and was incorporated as a town in 1870 and 1871. In 1881 Springfield was chartered as a city of a higher class, and in 1887 it absorbed North Springfield. After 1902 the city's growth in population and in industries was very rapid.

SPRINGFIELD, a city and the county-seat of Clark county, Ohio, U.S.A., at the confluence of Mad river and Lagonda Creek, about 45 m. W.S.W. of Columbus. Pop. (1890), 31,895; (1900), 38,253, of whom 3311 were foreign-born (including 1337 German, 1097 Irish and 308 English) and 4253 were negroes; (1910, census), 46,921. Springfield is served by the Cleveland, Cincinnati, Chicago & St Louis; the Pittsburg, Cincinnati, Chicago & St Louis; the Erie, and the Detroit, Toledo & Ironton railways, and by an extensive inter-urban electric system. The older portion of the city is in the narrow valley of Lagonda Creek, but from here the city has spread over the higher and more undulating surface farther back until it occupies an area of about 8½ sq. m. Among the public buildings are the United States government building, the Clark county court house, the City building (the first floor of which is occupied by the city market), the Warder public library (established 1872), which in 1908 contained 25,000 volumes, the city hospital, and the city prison and work-house. On hills near the city border are the Ohio state homes for the Masons, the Independent Order of Oddfellows, and the Knights of Pythias. The city park contains more than 250

acres, and in 1908 the city adopted plans for an extensive park system. Ferncliff cemetery is a picturesque burial-ground. On a hill on the north side of the city is Wittenberg College (Lutheran; 1845), which in 1909 had 35 instructors and 710 students. Springfield is in a productive farming region, and water power is provided by Lagonda Creek, so that manufactures closely related to agriculture have always been prominent. The value of the factory product in 1905 was \$13,654,423, of which \$4,051,167 was the value of agricultural implements, \$2,914,493 of foundry and machine-shop products, and \$1,025,244 of flour and grist-mill products. The municipality owns and operates the waterworks. Natural gas is piped from Fairfield county.

In 1799 Simon Kenton and a small party from Kentucky built a fort and fourteen cabins near Mad river 3 or 4 m. beyond the present western limits of the city. Later in the same year James Demint built a cabin on a hill-side overlooking Lagonda Creek. In 1801 he engaged a surveyor to plat a town here and soon after this the site of the Kenton settlement was abandoned. The new town was near the borderline that had been fixed between the Whites and the Indians, and the latter threatened trouble until 1807, when in a council held on a large hill in the vicinity, at which Tecumseh was the principal speaker for the Indians, peace was more firmly established. In 1818, when Clark county was erected, Springfield was made the county-seat. It was incorporated as a town in 1827, and in 1850 it was chartered as a city.

See E. S. Todd, *A Sociological Study of Clark County, Ohio* (Springfield, 1904).

SPRING-GUN, a device formerly in use against poachers and trespassers. Wires were attached to the trigger of a gun in such a manner that any one stumbling over or treading on them would discharge it and wound himself. Since 1827 spring-guns and all man-traps are illegal in England, except within a house between sunset and sunrise as a protection against burglars. Spring-guns are sometimes used to trap wild animals.

SPRINGTAIL, the common name of a group of small insects, so named from the presence of a pair of tail-like appendages at the end of the abdomen, which acts as a spring. When the insect is undisturbed these appendages are turned forwards and held in position by a catch beneath the abdomen; but in case of alarm they are kicked forcibly downwards and backwards, jerking the body into the air. This action may be rapidly repeated until a place of safety is reached. These insects usually live under fallen leaves, stones or the bark of trees, and sometimes occur in such quantities as to resemble patches of powder or dust. One species (*Podura aquatica*) may be seen floating in this way in masses upon the surface of standing water. Another (*Achorutes socialis*) may sometimes be found in abundance in the snow. Zoologically the springtails belong to the sub-order Collembola of the order Aptera (*q.v.*).

SPRING VALLEY, a city of Bureau county, Illinois, U.S.A., on the north bank of the Illinois River, in the northern part of the state, about 104 m. S.W. of Chicago. Pop. (1890), 3837; (1900), 6214 (2845 foreign-born); (1910) 7035. It is served by the Chicago, Burlington & Quincy, the Chicago, Rock Island & Pacific, the Chicago & North Western, and the Chicago, Ottawa & Peoria (electric) railways. Spring Valley is a shipping and distributing point for a large number of bituminous coal-mines in its vicinity. It was chartered as a city in 1886.

SPRUCE, *i.e.* spruce-fir, a coniferous tree belonging to the genus *Picea*, of which there are several species, such as the Norway spruce, *Picea excelsa*; the black spruce, *Picea nigra*, &c. (see **FIR**). The name has a curious origin, which explains also the particular meaning of the adjective "spruce," neatly dressed, smart in appearance, fine. From a number of early quotations given by Skeat (*Etym. Dict.*) it is clear that "spruce" a variant of "pruce," simply stood for Prussian; the form "spruce," rather than "pruce," being established partly by the German *Sprossen*, sprouts or young shoots (seen in *Sprossen-bier*, spruce beer, made of the sprouts of this fir).

SPRUE, a tropical disease, prevalent in India, China, Java, and the West Indies. It is described by Sir Patrick Manson as characterized by a peculiar, inflamed, superficially ulcerated, exceedingly sensitive condition of the mucous membrane of the tongue and mouth; great wasting and anaemia; and more or less diarrhoea, with pale and frothy fermenting stools. It is an obscure disorder, and the treatment recommended is rest and milk diet.

SPULLER, EUGÈNE (1835-1896), French politician and writer, was born at Seurre (Côte d'Or) on the 8th of December 1835, his father being a German who had married and settled in France. After studying law at Dijon he went to Paris, where he was called to the bar, and entered into close relations with Gambetta, collaborating with him in 1868 in the foundation of the *Revue politique*. He had helped Emile Ollivier in his electoral campaign in Paris in 1863, but when in 1869 Ollivier was preparing to "rally" to the empire he supported the republican candidate. During the siege of Paris he escaped from the city with Gambetta, to act as his energetic lieutenant in the provinces. After the peace he edited his chief's Parisian organ, the *République française*, until in 1876 he entered the Chamber of Deputies for the department of the Seine. He was minister of foreign affairs during part of the brief Gambetta administration, and subsequently one of the vice-presidents of the chamber, serving also on the budget commission and on a special industrial and agricultural inquiry. His Parisian constituents thought his policy too moderate on the clerical question, and he had to seek election in 1885 in the Côte d'Or, which in later years he represented in the Senate. He was minister of education, religion and the fine arts in the Rouvier cabinet of 1887, minister of foreign affairs under Tirard (1889-1890), and minister of education in 1894 in the Casimir-Périer cabinet. He died on the 28th of July 1896. His published works include some volumes of speeches and well-known studies of Ignatius Loyola (1876) and of Michelet (1876).

SPUR (A.S. *spura*, *spora*, related to *spornan*, *spurnan*, to kick, spurn; cf. M.H.G. *sporn*, mod. Ger. *Sporn*), an instrument attached to the heel of a rider's boot for the purpose of goading the horse. The earliest form of the horseman's spur armed the heel with a single prick. In England the rowel spur is shown upon the first seal of Henry III., but it does not come into general use until the 14th century. In the 15th century spurs appear with very long shanks, to reach the horse's flank below the outstanding bards. After this time, and until the beginning of the modern period of costume at the Restoration, they take many decorative forms, some of which remain in the great spurs worn by Mexican cavaliers. Gilded spurs were reckoned the badge of knighthood, and in the rare cases of ceremonious degradation they were hacked from the knight's heels by the cook's chopper. After the battle of Courtrai, in 1302, the victors hung up bushels of gilt spurs in the churches of Courtrai and Maestricht as trophies of what is still remembered by the Flemings as the *Goudensporendag*. For another reason the English named the French rout beside Théroouanne as the Battle of Spurs.

In architecture, a spur (Fr. *griffe*, Ger. *Knoll*), is the ornament carved on the angles of the base of early columns; it consists of a projecting claw, which, emerging from the lower torus of the base, rests on the projecting angle of the square plinth. It is possibly to these that Pliny refers (*Hist. Nat.* xxvi. 42) when speaking of the lizard and frog carved on the bases (*spirae*) of the columns of the temples of Jupiter and Juno in the Portico of Octavius; the earliest known example is that of Diocletian's palace at Spalato. In Romanesque work the oldest examples are those found on the bases in crypts, where they assumed various conventional forms; being, however, close to the eye, the spur soon developed into an elaborate leaf ornament, which in French 13th-century work and in the early English period is of great beauty; sometimes the spur takes the form of a fabulous animal, such as a griffin.

SPURGEON, CHARLES HADDON (1834-1892), English Nonconformist divine, was born at Kelvedon, Essex, on the 19th of June 1834. He was the grandson of an Essex pastor, and son of John Spurgeon, Independent minister at Upper Street, Islington. He went to school at Colchester and Maidstone, and in 1849 he became usher at a school in Newmarket. He joined the Baptist communion in 1851, and his work at once attested his "conversion." He began distributing tracts and visiting the poor, joined the lay preachers' association, and gave his first sermon at Teversham, near Cambridge. In 1852 he became pastor of Waterbeach. He was strongly urged to enter Stepney (now Regent's Park) College to prepare more fully for the ministry, but an appointment with Dr Joseph Angus, the tutor, having accidentally fallen through, Spurgeon interpreted the *contrectemps* as a divine warning against a college career. The lack of early systematic theological training certainly had a momentous effect upon his development. Broad in every other respect, he retained to the last the narrow Calvinism of the early 19th century. His powers as a boy preacher became widely known, and at the close of 1853 he was "called" to New Park Street Chapel, Southwark. In a very few months' time the chapel was full to overflowing. Exeter Hall was used while a new chapel was being erected, but Exeter Hall could not contain Spurgeon's hearers. The enlarged chapel at once proved too small for the crowds, and a huge tabernacle was projected in Newington Causeway. The preacher had recourse to the Surrey Gardens music hall, where his congregation numbered from seven to ten thousand. At twenty-two he was the most popular preacher of his day. In 1857, on the day of national humiliation for the Indian Mutiny, he preached at the Crystal Palace to 24,000 people. The Metropolitan Tabernacle, with a platform for the preacher and accommodation for 6000 persons, was opened for service on the 25th of March 1861. The cost was over £30,000, and the debt was entirely paid off at the close of the opening services, which lasted over a month. Spurgeon preached habitually at the Tabernacle on Sundays and Thursdays. He frequently spoke for nearly an hour, and invariably from heads and subheads jotted down upon half a sheet of letter paper. His Sunday sermons were taken down in shorthand, corrected by him on Monday, and sold by his publishers, Messrs Passmore & Alabaster, literally by tons. They have been extensively translated. Clear and forcible in style and arrangement, they are models of Puritan exposition and of appeal through the emotions to the individual conscience, illuminated by frequent flashes of spontaneous and often highly unconventional humour. In his method of employing illustration he is suggestive of Thomas Adams, Thomas Fuller, Richard Baxter, Thomas Manton and John Bunyan. Like them, too, he excelled in his vigorous command of the vernacular. Among more recent preachers he had most affinity with George Whitefield, Richard Cecil and Joseph Irons. Collected as *The Tabernacle Pulpit*, the sermons form some fifty volumes. Spurgeon's lectures, aphorisms, talks, and "Saplings for Sermons" were similarly stenographed, corrected and circulated. He also edited a monthly magazine, *The Sword and Trowel*; an elaborate exposition of the Psalms, in seven volumes, called *The Treasury of David* (1870-1885); and a book of sayings called *John Ploughman's Talks; or, Plain Advice for Plain People* (1866), a kind of religious *Poor Richard*. In the summer of 1864 a sermon which he preached and printed on *Baptismal Regeneration* (a doctrine which he strenuously repudiated, maintaining that immersion was only an outward and visible sign of the inward conversion) led to a difference with the bulk of the Evangelical party, both Nonconformist and Anglican. Spurgeon maintained his ground, but in 1865 he withdrew from the Evangelical Alliance. Subsequently in 1887 his distrust of modern biblical criticism led to his withdrawing from the Baptist Union. His powers of organization were strongly exhibited in the Pastors' College, the Orphanage (at Stockwell), the Tabernacle Almshouses, the Colportage Association for selling religious books, and the gratuitous book fund which grew up under his care. He received large money testimonials

(£6000 on his silver-wedding day and £5000 on his fiftieth birthday), which he handed over to these institutions. He died at Mentone on the 31st of January 1892, leaving a widow with twin sons (b. 1856). One of them, Rev. Thomas Spurgeon, after some years of pastorate in New Zealand, succeeded his father as minister of the Tabernacle, but resigned in 1908 and became president of the Pastors' College.

An *Autobiography* was compiled by his widow and his private secretary from his diary, sermons, records and letters (1897-1900).

SPURN HEAD, or **SPURN POINT**, a foreland of the North Sea coast of England, in Yorkshire, projecting across the mouth of the Humber. Its length is nearly 4 m. from the village of Kilnsea, but its breadth seldom exceeds 300 yds., and it rises only a few feet above sea-level. It is formed of sand and shingle, the débris of the soft coast of Holderness to the north, from which it is estimated that six million tons of material are annually removed by southerly currents along the shore. Deep water is found close off the seaward side of Spurn Head, the formation of which appears to have taken place within historic times, even since about the close of the 16th century. There are two light-houses and a lifeboat station on the head.

SPURZHEIM, JOHANN CHRISTOPH [KASPAR] (1776-1832), German phrenologist, was born near Treves on the 31st of December 1776. He made the acquaintance of F. J. Gall while studying medicine in Vienna, and for some years assisted him in spreading his phrenological doctrines, but in 1813 the two separated. Spurzheim lectured with considerable success in England and France, and was extending his propaganda to the United States when he died at Boston, Massachusetts, on the 10th of November 1832. His works include: *Anatomie et physiologie du système nerveux* (1810-1820); *Observations sur la phrénologie* (1810); *The Physiognomical Systems of Drs Gall and Spurzheim* (1815), and *Essai philosophique sur la nature de l'homme* (1820). (See PHRENOLOGY.)

SPY, a commune near Namur, Belgium. Here in 1886, in Betche aux Roches cavern, Maximin Lohest and Marcel de Puydt found two nearly perfect skeletons (man and woman) at the depth of 16 ft., with numerous implements of the Mousterian type. All the human remains are now in the Lohest Collection, Liège. The skulls were characterized by enormous brows, retreating forehead, massive jaw-bones, rudimentary chin and large posterior molars. The skeletons were further marked by a divergent curvature of the bones of the fore-arm; the tibia were shorter than in any other known race, and stouter than in most; the tibia and femur, being so articulated that to maintain equilibrium the head and body must have been thrown forward, as in the gait of the larger apes. These characteristics justify placing "the man of Spy in the lowest category . . . the dentition is inferior to that of the neolithic man in France . . . approximates near to the apes, although there is still, to use the language of Fraipont and Lohest, an abyss between the man of Spy and the highest ape" (E. D. Cope, "The Genealogy of Man" in *The American Naturalist*, April 1893, p. 334). With the skeletons were found bones of extinct mammals, the woolly rhinoceros (*Rhinoceros tichorhinus*), mammoth (*Elephas primi-genius*), and the cave-bear (*Ursus spelaeus*).

See also *L'Homme contemporain du mammoth à Spy* (Namur, 1887); G. de Mortillet, *Le Préhistorique* (1900).

SPY (from "to spy" or "espionage"; O. Fr. *espier*, *espier*, to spy, watch; cf. Ger. *spähen*, Lat. *specere*, to look; the Fr. term "espionage" is of course from the same source), in war—a person who, disguised or without bearing the distinguishing marks of belligerent forces, mixes with the enemy for the purpose of obtaining information useful to the army he is serving. As by the law of war a spy is liable, if caught, to the penalty of death, the Hague "Regulations respecting the Laws and Customs of War on Land" are very precise on the subject. A soldier not wearing a disguise is not a spy, though he may be found within the zone of the hostile army and though his object may be to obtain information; nor are soldiers or civilians spies who cross

enemy lines openly carrying messages. This applies even to persons sent in balloons for the purpose of carrying despatches. In short, it is essential to the character of a spy that he should act clandestinely or on false pretences, that he should be caught within the zone of operations of the hostile belligerent forces, and that his object should be to obtain information for use against them (art. 29). The regulations also provide that he cannot be "punished" without previous trial (art. 30). Nor can he be treated as a spy if he is captured after he has rejoined his army. He must then be treated as an ordinary prisoner of war (art. 31). (T. BA.)

The term "spy" is applied also to those who in time of peace secretly endeavour to obtain information concerning the forces, armaments, fortifications or defences of a country for the purpose of supplying it to another country. Every country has always endeavoured to guard jealously its military and naval secrets, and with this object denies admittance to fortified places or arsenals to those who cannot produce the proper credentials. Notwithstanding the utmost precautions, it is impossible to prevent some amount of leakage to countries which are prepared to pay for information otherwise unobtainable. Consequently, most countries have legislation dealing with "spying" in time of peace. In the United Kingdom, the Official Secrets Act 1889 makes it a misdemeanour wrongfully to obtain information as to any fortress, dockyard, office, &c., of his majesty, or, having such information or any information relating to the naval or military affairs of his majesty, to communicate the same to any person to whom it ought not in the interest of the state to be communicated at the time. If the information is communicated, or intended or attempted to be communicated, to any foreign state, the offence becomes a felony. In Germany an imperial law of 1893 deals similarly with such an offence.

SQUADRON, a military and naval term for a body of mounted troops or a detachment of war vessels. The word is derived from *squadra*, a square, as a military term, according to Florio, applied to a "certain part of a company of souldiers of 20 or 25 whose chiefe was a corporal," and so called no doubt as being formed on parade or in battle array in squares. *Squadra*, square, is derived from the Low Latin *exquadrare*, an intensive form of *quadrare* (*quadrus*, four-cornered, *quattuor*, four). In military usage the term "squadron" is applied to the principal units into which a cavalry regiment is divided, corresponding to the company in an infantry battalion. The normal modern division of a cavalry regiment is into four squadrons of two to four troops each, this squadron numbering 120 to 200 men (see CAVALRY). In naval usage a squadron is a group of vessels either as forming one of the divisions of a fleet or as a separate detachment under a flag officer despatched on special service. In military use, "squad" (a shortened form of "squadron") is used of any small detachment of men detailed for drill, fatigue or other duty.

SQUAILS (from *skail* or *kail*, a ninepin), an old English game in which disks are snapped or struck with the palm from the edge of a table or board at a mark at its centre. Its early prototype was *shove-groat*, called also *slyp-groat* or *slide-thrift*, which in the 18th century went under the name of *jervis* or *jarvis*. This last variation was played on a table marked with chalk into alleys divided into squares numbered from 1 to 9 or 10, the object being to send a halfpenny into a high-numbered space. If it went beyond nothing was scored. The highest aggregate of a certain number of plays won. The most scientific development of this class of games is the modern *Shuffle-board* (q.v.).

SQUALL, the name given to any sudden increase of wind to gale force. Generally speaking a squall is understood to be of short duration, but the word "gust" would be used to indicate an increase of wind force of more transient character than a squall. Gusts may succeed one another several times within the compass of a minute. A squall may comprise a succession of gusts, with intervening partial lulls, and would last with varying intensity for some minutes at least. The distinction

between gusts and squalls is best illustrated by the traces of a Dines pressure-tube anemograph. The trace reproduced in fig. 1 for an ordinary steady wind shows that the force of the wind is constantly oscillating. The general appearance of the trace is a ribbon which has a breadth proportional to the mean wind velocity. The breadth of the ribbon is also dependent upon the nature of the reference; the better the exposure the narrower the ribbon; for an anemograph at a coast station the ribbon is wider for a shore wind than for a sea wind.

From the records obtained at Scilly and Holyhead, Dr G. C. Simpson concluded that a wind of mean hourly velocity v was composed of alternations of gusts and lulls ranging on the average between limits $.5+1.2v$ and $-.5+.76v$ with occasional recurrences to extreme velocities of $1.5+1.3v$ and $-1.0+.65v$. In other words, the average range of the ribbon is $.5+.45v$ for the two

stations during the hour when the mean velocity is v , and the extreme range within the same period is $2.0+.68v$.

The differences of gust velocity at stations with different exposures may be illustrated by quoting the breadth of the ribbon for a 30 m. wind at the following stations:—

Southport (Marshside)	10 m.	
Scilly	15 "	
Shoeburyness	20 "	(from W.)
"	10 "	(from E.N.E.)
Holyhead	15 "	
Pendennis Castle (Falmouth)	8 "	(from S.)
"	16 "	(from W.)
Aberdeen	30 "	(from N.W.)
Alnwick Castle	25 "	
Kew	30 "	

Fig. 2 represents a succession of squalls occurring in an ordinary gusty wind; the squalls succeed one another with fair regularity about every twenty minutes and last in full force for a few minutes. A

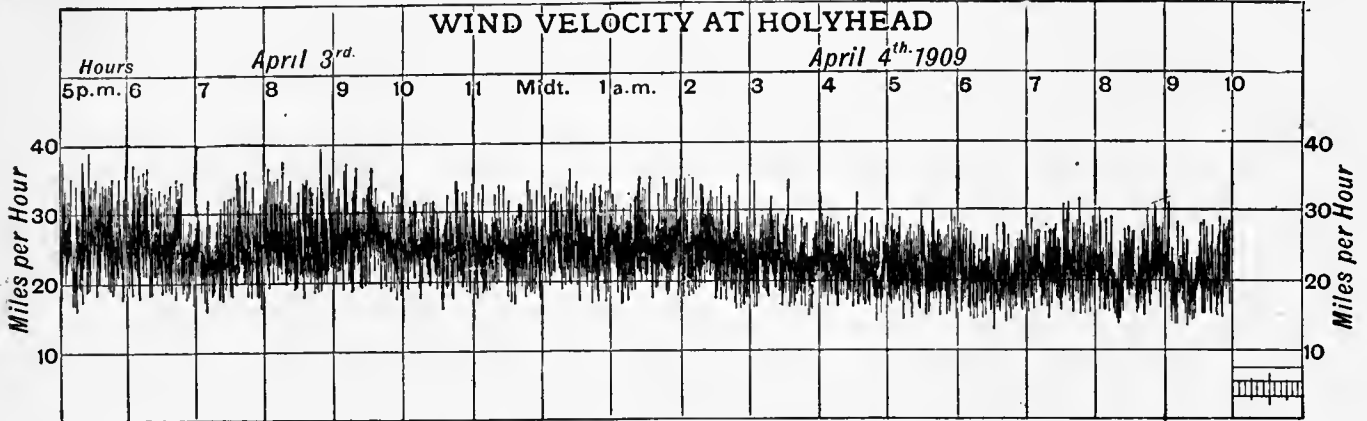

FIG. 1.

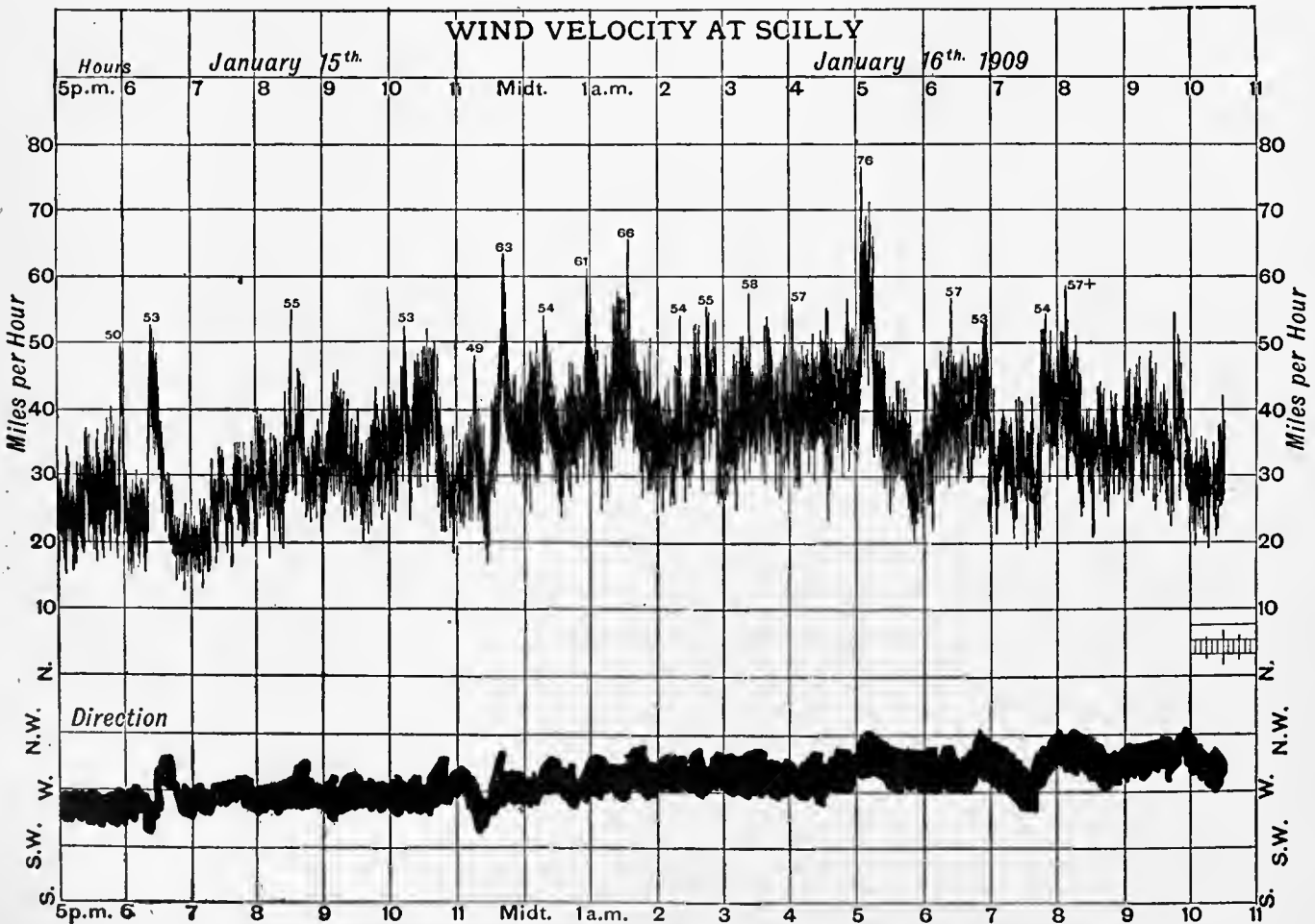
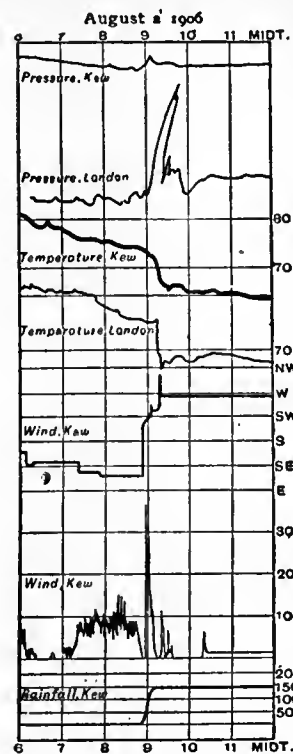

FIG. 2.

succession of squalls of this kind is a common experience with westerly wind at Scilly, and the onset of squalls is generally associated with the veering of the wind to the north-west. Changes in wind velocity, either in the form of gusts or squalls, are generally associated with some change in direction of the wind, but the relation between the changes in gusts have not yet been studied.



(Redrawn by permission from the British Association Report, 1908.)
 FIG. 3.—Variation of Meteorological Elements in a Line Squall.

changes at different places. The associated events are very well marked by those recorded for the line of squall of the 2nd of August 1906 (fig. 3). They comprise a sudden increase of wind with a veer of direction of 45° to 90°, a sudden rise of pressure known in France as the *crochet d'orange*, and in Germany as the *Gewitter Nase*, a pronounced and permanent fall of temperature, and a shower of rain, hail or snow. While these various phenomena are indicated all along the advancing line their intensity may be very different at different points along it. The squall often exhibits greater violence in the middle portion, and it becomes more intense as the whole line advances. In the most fully developed portions the weather phenomena take the form of thunderstorms with violent wind and rain. The course of events in a typical line squall has been most carefully worked out by R. G. K. Lempfert in a paper on the "Line Squall" of the 8th of February 1906 (*Quart. Journ. Roy. Met. Soc.* vol. xxxii.). Fig. 4 (reproduced from the papers) shows the successive positions of the line of the front from which its rate of travel can be estimated. The line of advance of a line squall is generally from some point between south and north on the western side, the change of wind being from a warm southerly or westerly wind to a colder westerly or northerly one. So far as is known to the writer there is no case of a line squall exhibiting a backing wind. The date and direction of advance appear to be, generally speaking, those of the final wind, but in cases where the thunderstorms are developed there is a local violence of the wind bearing no relation to the isobaric distribution of the final wind.

Endeavours have been made to explain the phenomena of line squalls as due to vortex motion of particular character. The violent wind blowing out in front of the storm is part of the circulation of a vortex with horizontal axis. It supplies the air for the rainfall of the stations in front. Its place is taken by descending air at the back, which becomes in its turn the surface supply for stations farther in. But such an explanation

seems in many ways incomplete. Although perhaps if the wind velocities in a vertical plane were plotted there might be some evidence of circulation in the mathematical sense by integrating round a closed curve, yet the idea of circulation in a vertical plane as suggesting the primary constitution of the phenomena is very inadequate. The change of air which takes place during the passage of the line squall is altogether different from that which we would get by passing the surface air through a complete vertical cycle and condensing a large quantity of water vapour on the way. If vertical circulation were complete the air would

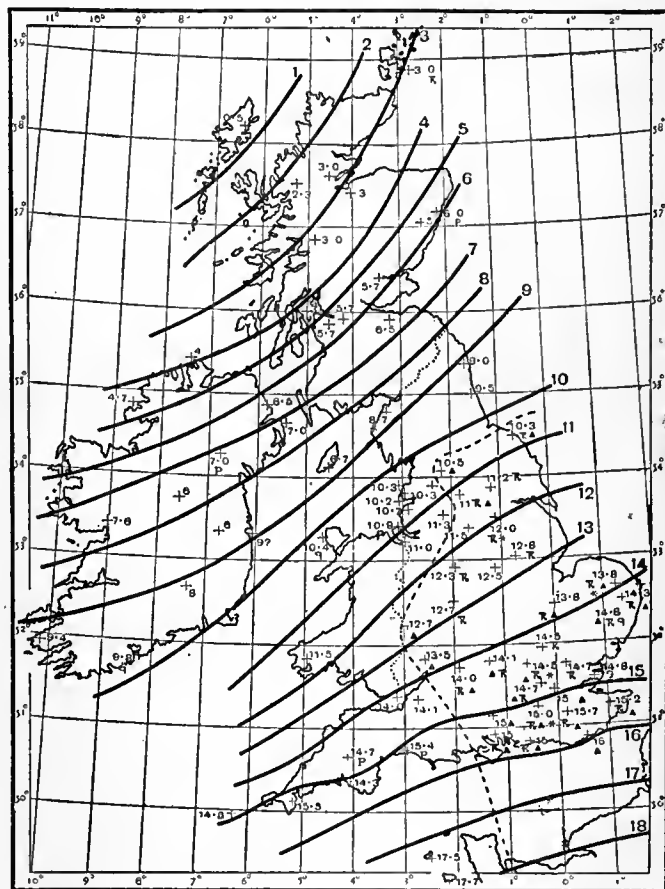
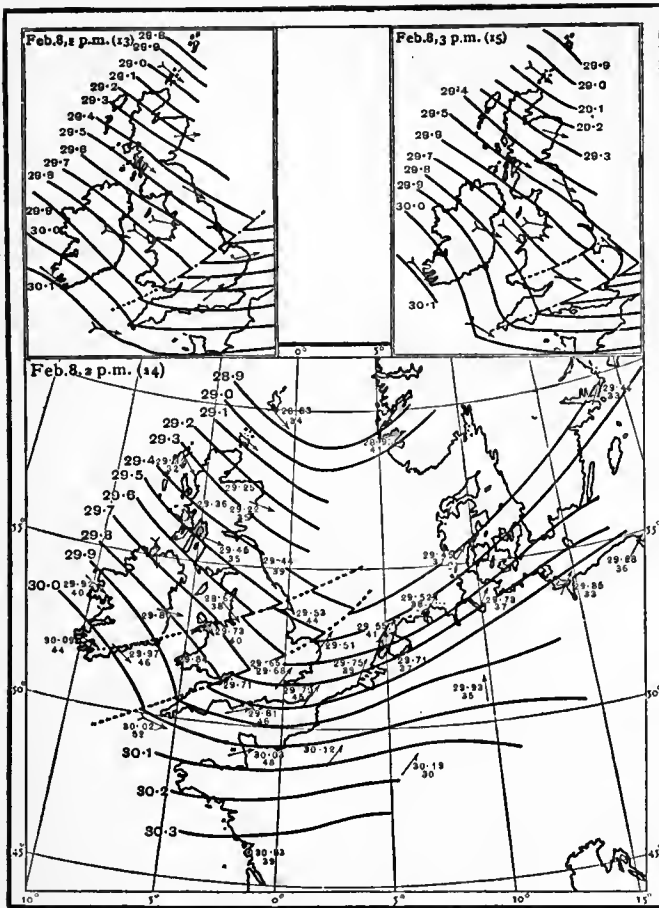

FIG. 4.—Times of occurrence of sudden meteorological changes, and isochronous lines showing the advance of the squall. The hours are numbered consecutively from 1 to 18, starting at 1 a.m. (Feb. 8), and the minutes are expressed as decimal fractions of an hour. Hail and thunder storms occurred in the region to the east of the dotted line.

return to the surface warmed and dried. A few revolutions would produce a very considerable elevation of temperature. The air which remains after the passage of a line squall is, however, distinctly colder, of an entirely different kind from that which it replaces and, in those cases which have been investigated, can be traced back to a different point of the compass. Moreover, the smallness of vertical dimensions in the atmosphere as compared with the horizontal dimensions makes it difficult to allow that there is really room for an effective vortex with a horizontal axis. To carry air up 5 m. and bring it back again would practically deprive it of all its moisture and raise its temperature 72° F. Yet 5 m. would be a very small allowance for the horizontal spread of the phenomena of the squall.

The sudden replacement of warm air by cold with a change of wind seems much more likely to be associated with the flooding of the country by an advancing sweep of cold air. The pressure changes are continuous in the old layer and in the new layer, but discontinuous with varying degrees of discontinuity along the line of junction, where instability of the upper air may be set up. Fig. 5 shows the discontinuity of pressure in the example discussed by Mr Lempfert. It is clear that as the discontinuity of pressure becomes accentuated there arise



(Redrawn by permission from the *Quart. Journ. Roy. Met. Soc.*)

FIG. 5.—Distribution of Pressure (Feb. 8, 1906). Isobars are shown for each 0.1 in.

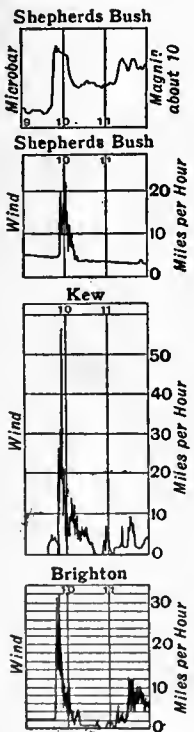

(Redrawn by permission from the *British Association Report, 1908.*)

FIG. 6.—Records of wind velocity on June 1, 1908.

in the localities on the line of advance very steep pressure gradients for which there are corresponding winds. The violent winds may therefore be attributed to the breakdown of the dynamical system under the stress of these local differences of pressure.

From this point of view the phenomena of the line squall are to be regarded as a development of the ordinary phenomena of the V-shaped depression. A sudden change of wind and a line of rain that pass over the country with the velocity of the same order as that of the following wind are quite common features of the S.W. quadrant of a cyclonic depression, and they, too, seem to point to the juxtaposition of currents of different temperature coming from different regions but forming adjacent components of supply for the depression.

Examples of all degrees between the comparatively unimportant rain line and the most violent tornado-like squall could be put side by side with cases in which the typical pressure, temperature and weather changes are accompanied by a sudden lull in the wind, as in the example quoted in the *Life History of Surface Air Currents* (M. O. publication, No. 174, 1906). An example of a line squall in its most

violent and destructive form is shown in the records for the 1st of June 1908. In the record for Kew the squall of wind which destroyed a number of the trees of Bushey Avenue is shown as lasting for a very long period (fig. 6).

A line squall of historic interest is that which capsized H.M.S. "Eurydice" off the Isle of Wight on the 24th of March 1878. The occurrence is discussed by the Hon. Ralph Abercromby in 1884 (*Quart. Journ. Roy. Met. Soc.* x. 172) and previously by the Rev. Mr Clementhey (*Symon's Met. Mag.*, April 1878). The shift of wind in this case appears to have been from west to north, and the change in the wind was accompanied by the transitions from fine blue sky to snow. The records at the seven observatories belonging to the Meteorological Council are reproduced in the *Quarterly Weather Report*, from which fig. 7 is taken.

Whatever explanation may be given of the cause and origin of the phenomena of line squalls, it must take account of the fact that a first squall is often succeeded by others of a similar character but often of less intensity than the first. After the sudden shift of wind, with accompanying weather changes, the conditions seem to revert more or less to the original state. The warm southerly wind reasserts itself, but is driven out again by another attack, and ultimately the cold wind holds the field. It is easy to suggest, but at present not easy to verify, the course of replacement of the warm wind. Upper air observations in such circumstances with kites or manned balloons are dangerous, both for the apparatus and the observer; but it may be possible to trace the actual course of events by the records of rounding balloons supplemented by observations of the motive balloon by means of theodolites.

Little has been said about the actual force of the wind in gusts or squalls, and in the present state of anemometry it is difficult to

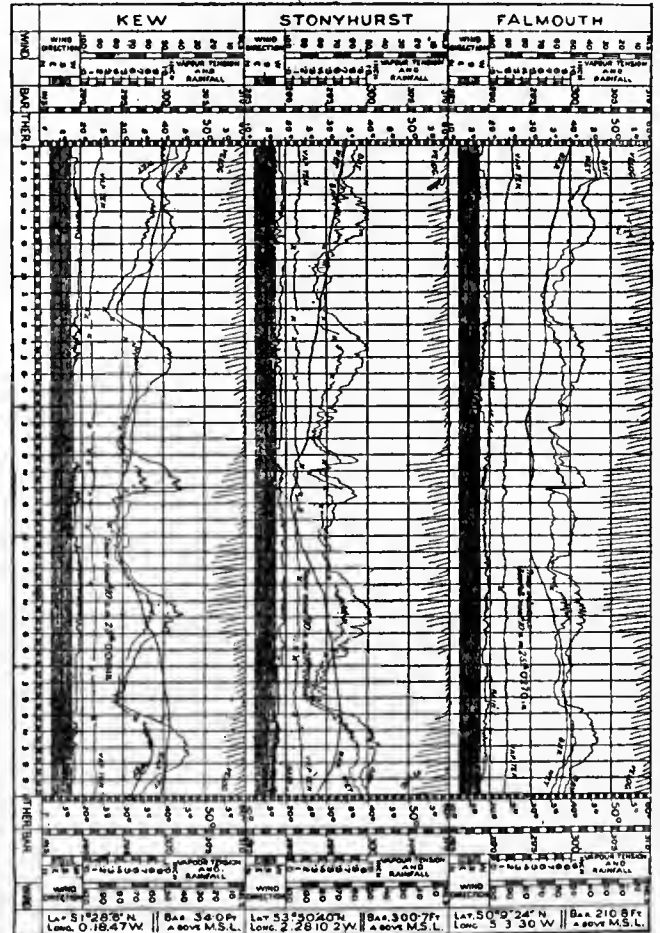

(By permission of the Controller of His Majesty's Stationery Office.)

FIG. 7.—"Eurydice" Squall, from the *Quarterly Weather Report*.

regard the figures hitherto obtained as final; moreover, the large wind force in squalls is probably subject to large local variations, the difference between the record of the squall of the 1st of June 1908 at Kew and Shepherd's Bush suggests that it may have been much stronger at Bushey, where the damage was done. The highest velocity in a gust hitherto recorded upon instruments belonging to the office is 106.5 m. per hour at Pendennis Castle on the 14th of March 1905. Gale force is defined for the purposes of the meteorological office as that of a wind which has an average velocity during an hour of 38 m. per hour. According to Simpson's results at Scilly or Holyhead, where the exposure is good, a wind that just got within the reckoning of gales would reach 44 m. per hour in the ordinary gusts, with occasional records of 51 m. per hour. Squalls with velocities reaching 55 m. per hour are not uncommon, and the range of wind velocity which constitutes a squall may be anything between 40 m. an hour and upwards of 100 m. an hour. (W. N. S.)

SQUAW, the anglicized word for woman among the North American Indians; the Massachusetts Indian form is *squa* or *schqua*, the Narraganset *squāwo*, the Cree *eskwoo*, Delaware *ochqueu*, *khqueu*, &c. It is also used in composition with names of animals to denote the female.

SQUIB, supposed to be derived from the German word *schieben*, to push or shove forward with a sliding movement, the name for a projected kind of firework that is flung out of a groove and breaks with a flash and a clatter. Hence, in the literary sense, a squib is a slight satirical composition put forth on an occasion; and it is intended that it should make a noise by its explosion, not by the possession of any permanent importance. Steele says, in the *Taller*, that "squibs are those who in the common phrase of the world are call'd libellers, lampooners and pamphleteers," showing that, at the beginning of the 18th century, the man who composed the satire, as well as the satire itself, was called a squib. Swift speaks of the rapidity with which these little literary fireworks flew about from place to place, and he himself was a proficient in the making of noisy squibs. Perhaps the best type of a squib in English literature is Gray's *Candidate*, which was written and circulated among the electors in 1764, when Lord Sandwich was canvassing for the office of high-steward of the university of Cambridge. The object of this poem was, by ridicule and defamation, to injure Lord Sandwich's prospects of success. When once the election was over the verses served no further purpose, and they have survived simply in consequence of their fluent wit and of the reputation of the great poet who composed them. (See also LAMPOON.)

SQUILL, the name under which the bulbous root of *Urginea Scilla* is used in medicine. It belongs to the natural order Liliaceae. The name of "squill" is also applied by gardeners to the various species of *Scilla*. The medicinal squill is a native of the countries bordering the Mediterranean, and grows from the sea-level up to an elevation of 3000 ft. The bulbs are globular and of large size, often weighing more than 4 lb. Two varieties are met with, the one having white and the other pink scales. They are collected in August, when they are leafless, the membranous outer scales being removed and the fleshy portion cut transversely into slices and dried in the sun. These are then packed in casks for exportation. They are chiefly imported into the United Kingdom from Malta. When reduced to powder and exposed to the air the drug rapidly absorbs moisture and cakes together into a hard mass.

Squill has been used in medicine from a very early period. The ancient Greek physicians prescribed it with vinegar and honey almost in the same manner as it is used at present. The composition of the drug, first efficiently studied by Merck in 1878, is very complex. The chief constituent is *scillitoxin*, a bitter and intensely irritant principle. A somewhat similar substance, *scillipain*, is also physiologically active. The bitter glucoside *scillin*, or *scillain*, is unimportant. The bulb also contains mucilage, and a considerable quantity of an irritant resin. It has been shown that a definite action on the heart is not obtainable unless so large a dose of squill is given that some gastro-intestinal irritation or even inflammation is set up by this resin. The dose of squill is from 1 to 3 grains. Of the numerous pharmacopoeial preparations only three are of any importance: the syrup of squill, composed of one part of squill, eight of dilute acetic acid and four of sugar; the *Pilula Ipecacuanhae cum Scilla*, in which ipecacuanha and opium are the chief constituents; and the tincture of squill, which is still widely used, made by macerating one part of squill

with five of alcohol. The action of the drug is that of a cardiac stimulant, with three important further properties all dependent on its irritant constituents. Even in small doses, such as will not affect the heart, it is a gastro-intestinal, a bronchial and a renal irritant. The two latter properties constitute it a powerful expectorant and a fairly active diuretic. The drug must not be given alone, owing to its irritant action. It is very frequently given as a diuretic in cardiac cases in the form of a pill containing one grain each of mercury, digitalis and squill. Combined with a sedative, such as opium, it may be given in chronic bronchitis. It must not be given in acute bronchitis, which it only aggravates; nor in phthisis, which is invariably accompanied by a hypersensitive state of the alimentary tract. For similar reasons squill should not be given in any form of Bright's disease. The textbook prohibition against its use in acute Bright's disease should certainly be extended to chronic nephritis in all its forms. The use of this irritating drug, while still extensive, is yearly diminishing. It does not accomplish anything that may not otherwise be achieved at less cost to the secreting surfaces of the patient.

An allied species, *Urginea indica*, is used in India in the same manner as the European species. The true squills are represented in Great Britain by two species, *Scilla autumnalis* and *S. verna*. The former has a racemose inflorescence and leaves appearing in autumn after the flowers; the latter has the flowers arranged in a corymbose manner, leaves appearing in spring, and is confined to the sea-coast. Several species are cultivated in gardens, *S. bifolia* and *S. sibirica* being remarkable for their beautiful blue flowers, which are produced in early spring; Chinese squill is *S. chinensis*, a half-hardy species; Roman squill is a popular name for species of *Bellevalia*, a genus now generally included in *Hyacinthus*; striped squill is *Puschkinia scilloides*, a liliaceous plant resembling the squill in habit.

SQUINCH, possibly a corruption of sconce (French equivalents are *pendentive*, *trompe*), the term in architecture applied to a corbelling out by means of arched rings in stone thrown across the angles of a square tower, to carry an octagonal spire or a dome. The earliest examples are found in the palaces of Serbittan and Firuzabad constructed by the Sassanian dynasty (A.D. 350-450), and in the mosque at Damascus, where it takes the form of a niche. In early French Romanesque work a small niche with additional rings above is employed; a greater importance is sometimes given by small shafts at the sides, of which there are examples in the Coptic churches of Egypt, and in France in the cathedral at Le Puy and the church of St Martin at Dijon. (See PENDENTIVE.)

SQUINT (possibly connected with Swed. *svinka*, to flinch; O. Eng. *swiccan*, avoid), properly an adjective meaning looking different ways, hence oblique, indirect vision, particularly a strabismus, an affection of the eyes consisting in non-coincidence of the optic axes (see EYE, § Diseases; and VISION). In architecture "squint" is used of a slit or opening usually on one or both sides of the chancel arch, giving a view of the altar from the transepts or aisles; it is also styled "hagioscope" (*q.v.*).

SQUIRE, an abbreviated form of "esquire" (*q.v.*), originally with the same meaning of an attendant on a knight. In this form, however, the word has developed certain special connotations. Thus in England it is used partly as a courtesy title, partly as a description of the chief landed proprietor, usually the lord of the manor, in a parish the lesser proprietors being "gentlemen" or yeomen. In some parts also it is not uncommon for the title of "squire" to be given to small freeholders of the yeoman class, known in Ireland half contemptuously as "squireens." In the United States the title has also survived as applied to justices of the peace, local judges and other dignitaries in country districts and towns. In another sense "squire" has survived in its sense of "attendant," "to squire" being used so early as Chaucer's day as synonymous with "to wait upon." A "squire of dames" is thus a man very attentive to women and much in their company. Footpads and highwaymen were termed sometimes "squires of the pad" as well as "gentlemen of the road."

SQUIRREL (Fr. *écureuil*), properly the name of the well-known red, bushy-tailed British arboreal mammal, *Sciurus vulgaris*, typifying the genus *Sciurus* and the family Sciuridae, but in a wider sense embracing all the rodents included in this

and a few nearly allied genera. For the characteristics of the family Sciuridae and the different squirrel-like genera by which it is represented, see RODENTIA.

What may be called typical, that is to say arboreal, squirrels are found throughout the greater part of the tropical and temperate regions of both hemispheres, although they are absent both from Madagascar and Australasia. The species are both largest and most numerous in the tropics, and reach their greatest development in the Malay countries. Squirrels vary in size from animals no larger than a mouse, such as *Nannosciurus soricinus* of Borneo, or *N. minutus* of West Africa, to others as large as a cat, such as the black and yellow *Ratufa bicolor* of Burma and the Malay area. The larger species, as might be expected from their heavier build, are somewhat less strictly arboreal in their habits than the smaller ones. The common squirrel, whose habits are too well known to need special description, ranges over the whole of Europe and Northern Asia, from Ireland to Japan, and from Lapland to North Italy; but specimens from different parts of this wide range differ so much in colour as to constitute distinct races. Thus, while the squirrels of north and west Europe are of the bright red colour of the British animal, those of the mountainous regions of southern Europe are of a deep blackish grey; while those from Siberia are a clear pale grey colour, with scarcely a tinge of rufous. There is also a great seasonal change in appearance and colour in this squirrel, owing to the ears losing their tufts of hair and to the bleaching of the tail. The pairing time of the squirrel is from February to April; and after a period of gestation of about thirty days the female brings forth from three to nine young. In addition to all sorts of vegetables and fruits, the squirrel is exceedingly fond of animal food, greedily devouring mice, small birds and eggs. The squirrels of the typical genus *Sciurus* are unknown in Africa south of the Sahara, but otherwise have a distribution co-extensive with the rest of the family.

Although the English squirrel is a beautiful little animal, it is surpassed by many of the tropical members of the group, and especially by those of the Malay countries, where nearly all the species are brilliantly marked, and many are ornamented



The Burmese Red-bellied Squirrel (*Sciurus pygerythrus*).

with variously coloured longitudinal stripes along their bodies. Every one who has visited India is familiar with the pretty little striped palm-squirrel, which is to a considerable extent a partially domesticated animal, or, rather, an animal which has

taken to quarter itself in the immediate neighbourhood of human habitations. It has been generally supposed that there is only one palm-squirrel throughout India, but there are really two distinct types, each with local modifications. The first or typical palm-squirrel, *Funambulus palmarum*, inhabits Madras, has but three light stripes on the back, and shows a rufous band on the under-side of the base of the tail. In Pennant's palm-squirrel, *F. pennanti*, on the other hand, there is a pair of faint additional lateral white stripes, making five in all, and the under-surface of the tail is uniformly whitish olive. As this species has been obtained in Surat and the Punjab, it is believed to be the northern type. One Oriental species (*Sciurus caniceps*) presents almost the only known instance among mammals of the assumption during the breeding season of a distinctly ornamental coat, corresponding to the breeding plumage of birds. For the greater part of the year the animal is of a uniform grey colour, but about December its back becomes a brilliant orange-yellow, which lasts until about March, when it is again replaced by grey. The squirrel shown in the illustration is a native of Burma and Tenasserim, and is closely allied to *S. caniceps*, but goes through no seasonal change of colour. Another Burmese squirrel, *S. haringtoni*, differs as regards colour in a remarkable manner from all other known members of the group. It is a medium-sized species of a pale creamy buff colour above, lighter beneath, and with a whitish tail, while it is further characterized by the absence of the first upper premolar, which shows that it is not an albino or pale variety. Two examples were obtained by Captain H. H. Harington, of one of the Punjabi regiments, on the Upper Chindwin river. It may be added that generic subdivisions of the squirrels are based mainly on the characters of the skull and teeth. That they are essential is evident from the circumstance that the African spiny squirrels *Xerus* (see SPINY SQUIRREL) come between *Sciurus* and some of the other African genera. (R. L.*)

SQUIRREL MONKEY, the English name of a small golden-haired South American monkey, commonly known as *Chrysothrix sciurea*, and also applied to the two other members of the same genus, whose collective range extends from Costa Rica to Bolivia and Brazil. It has, however, been proposed to transfer the name *Chrysothrix* to the marmosets of the genus *Hapale*, to which it is stated to have been originally applied, and to replace it by *Saimiris*. The squirrel-monkeys were formerly classed with the douroucoulis (see DOUROUCOULI), but, on account of their brain-structure, they have been transferred to the Cebinae (see CAPUCHIN-MONKEY), from the other members of which they differ by their practically non-prehensile tails and smaller size, while they are further distinguished by their comparatively large eyes and the backward prolongation of the hinder part of the head. They are exceedingly pretty little monkeys. (See PRIMATES.) (R. L.*)

SRINAGAR, capital of the state of Kashmir, in Northern India, 5250 ft. above sea-level, on both banks of the river Jhelum, which winds through the city with an average width of 80 yds. and is crossed by seven wooden bridges. The houses occupy a length of about 3 m. and a breadth of about 1½ m. on either side of the river; but the greater part of the city lies on the right bank. No two buildings are alike. The curious grouping of the houses, the frail tenements of the poor, the substantial mansions of the wealthier, the curious carving of some, the balconies of others, the irregular embankment and the mountains in the background, form a quaint and picturesque spectacle. Area, 3795 acres. Pop. (1901), 122,618. The city is exposed to both fire and flood. In 1893 six of the seven bridges were swept away, and great damage was again caused in 1903. A regular water-supply has been provided. The artisans of Srinagar enjoy a high reputation. Unfortunately, the historic industry of shawl-weaving is now practically extinct. The loss of the French market after the war of 1870 was followed by the famine of 1877-1879, which drove many of the weavers into the Punjab, and the survivors have taken to the manufacture of carpets. Other industries are paper, leather, papier

mâché, silver and copper ware, wood-carving and boat-making. The three chief routes of communication with India are: (1) along the Jhelum valley to Murree and Rawalpindi, which has been opened throughout for wheeled traffic (195 m.); (2) over the Banihal pass (9200 ft. above the sea) to Jammu (163 m.); (3) over the Pir Panjal pass (11,400 ft.) to Gujrat (180 m.).

See Sir Walter R. Lawrence, *The Valley of Kashmir* (1895); M. A. Stein, *Chronicle of the Kings of Kashmir* (1900).

SRIRANGAM, or **SERINGHAM**, a town of British India, in Trichinopoly district, Madras presidency, 2 m. N. of Trichinopoly city. Pop. (1901), 23,039. It stands on an island of the same name, formed by the bifurcation of the river Cauvery and by the channel of the Coleroon. The town is celebrated for its great temple, dedicated to Vishnu, composed of seven square enclosures, one within another, and 350 ft. distant from each other. Each enclosure has four gates with high towers, placed one in the centre of each side opposite to the four cardinal points. The successively widening enclosures and the greater elaboration of the outer as compared with the inner buildings mark the progress of the shrine in fame and wealth. The outer wall of the temple is not less than 4 m. in circumference. Not far distant is the smaller but more beautiful Jambukeswaram, a temple dedicated to Siva. From 1751 to 1755 the island and its pagodas were the object of frequent contests between the French and the English.

STAAL, MARGUERITE JEANNE CORDIER DELAUNAY, BARONNE DE (1684-1750), French author, was born in Paris on the 30th of August 1684. Her father was a painter named Cordier. He seems to have deserted her mother, who then resumed her maiden name, Delaunay, which was also adopted by her daughter. She was educated at a convent at Evreux, of which Mme de la Rochefoucauld, sister of the author of the *Maximes*, was superior. Here she became attached to Mme de Grieu, who, being appointed abbess of the convent of St Louis at Rouen, took her friend with her. Mlle Delaunay lived there until 1710 in the enjoyment of the utmost consideration. There she held a little court of her own, which included Brunel, the friend of Fontenelle, the sieur de la Rey and the abbé Vertot. She describes her own first passion for the marquis de Silly, the brother of a friend with whom she was visiting. Her affection was not returned, but she entered on a correspondence with him in which she plays the part of director. After the death of her patron, Mme de Grieu, poverty compelled her to enter the household of the duchesse du Maine at Sceaux in the capacity of *femme de chambre*. Her literary talent soon manifested itself in the literary court of the duchess, and secured for her, among other friendships, the somewhat undesirable admiration of the abbé Chaulieu. The duchess is said, but chiefly on the waiting-lady's own authority, to have been not a little jealous of her attendant. Enough, however, is known of the duchess's imperious and capricious temper to make it improbable that her service was agreeable. Mlle Delaunay, however, enjoyed a large share of her confidence and had a considerable share in drawing up the *Mémoire des princes légitimes* which demanded the meeting of the states-general. She was implicated in the affair of the Cellamare conspiracy, and was sent in 1718 to the Bastille, where she remained for two years. Even here, however, she made conquests, though she was far from beautiful. Her own account of her love for her fellow prisoner, the chevalier de Ménil, and of the passion of the chevalier de Maisonrouge, her gaoler, for her, is justly famous. She returned on her liberation to the service of the duchess, who showed no gratitude for the devotion, approaching the heroic, that Mlle Delaunay had shown in her cause. She received no promotion and still had to fulfil the wearisome duties of a waiting-maid. She refused, it is said, André Dacier, the widower of a wife more famous than himself, and in 1735, being then more than fifty, married the Baron de Staal. Her dissatisfaction with her position had become so evident that the duchess, afraid of losing her services, arranged the marriage to give Mlle Delaunay rank sufficient to allow of her promotion to be on an equality with the ladies of the court. On this footing she remained a member of the

household. It was at this time that she became the friend and correspondent of Mme du Deffand. She died at Gennevilliers on the 15th of June 1750. Her *Mémoires* appeared about five years later, and have often been reprinted, both separately and in collections of the memoirs of the 17th and 18th centuries, to both of which the author belonged both in style and character. She has much of the frankness and seductive verve of Mme de Sévigné and her contemporaries, but more than a little alloyed with the *sensibilité* of a later time. It may be doubted whether she does not somewhat exaggerate the discomforts of her position and her sense of them. In her lack of illusions she was a child of the 18th century. Sainte-Beuve says that the most fit time for the reading of the *Mémoires* is the late autumn, under the trees of November. But her book is an extremely amusing one to read, as well as not a little instructive. The humours of the "court of Sceaux" are depicted as hardly any other society of the kind has ever been. "Dans cet art enjoué de raconter," says Sainte-Beuve, "Madame de Staal est classique."

Besides her *Mémoires* Mme de Staal left two excellent short comedies, performed at the court of Sceaux, and some letters, the answers to which are in some cases extant, and show, as well as the references of contemporaries, that the writer did not exaggerate her own charm. Her *Mémoires* were translated by S. Bathurst (1877) and by C. H. Bell (1892). See the edition (1877) of her *Mémoires* by M. de Lescure.

STABIAE, an ancient town of Campania, Italy, on the coast at the east extremity of the Gulf of Naples (mod. Castellammare di Stabia). It was dependent upon Nuceria Alfaterna (*q.v.*) until it joined the revolt against Rome in the Social War (90 B.C.). In 89 it was taken and destroyed by Sulla, and its territory given to Nuceria as a reward for fidelity to Rome. The place, however, continued to be visited for its natural beauties, its mineral springs and its pure milk. Remains of fine villas have been found about half a mile to the east of the modern town, and also the remains of a temple to the genius of Stabiae, which no doubt occupied the same site as it had done in Oscan times. None of these remains is now visible. The town was destroyed by the eruption of A.D. 79 (in which the elder Pliny met his death), but was soon rebuilt on the site now occupied by the modern Castellammare. Above the town on the east is the Mons Lactarius (from *lac*, milk). Here took place the battle between Narses and Teias in A.D. 553, which put an end to the Gothic domination in Italy.

See M. Ruggiero, *Scavi di Stabia del 1749 al 1782* (Naples, 1881); J. Beloch, *Campanien*, 2nd ed. p. 248 sqq. (Breslau, 1890). (T.A.S.)

STABLE, a building in which horses are kept, including the stall in which they stand, furnished with manger and rack, the room in which the harness is kept and attended to, the loft in which the hay and corn are stored, and other accessory rooms, &c. (See HORSE.) This is the current usage, but the word was formerly applied, as was the Latin *stabulum*, *i.e.* standing-place (from *stare*, to stand), to a stall or enclosure for all kinds of domestic animals, cows, sheep, &c. The adjective "stable," meaning firmly established, comes directly from Latin *stabilis*, also from *stare*, to stand.

STADE, BERNHARD (1848-1906), German Protestant theologian, was born on the 11th of May 1848, at Arnstadt, in Thuringia. He studied at Leipzig and Berlin, and in course of time became (1875) professor ordinarius at Giessen. Once a member of Franz Delitzsch's class, he became a convinced adherent of the newest critical school. In 1881 he founded the *Zeitschrift für alttestamentliche Wissenschaft*, which he continued to edit; and his critical history of Israel (*Geschichte des Volks Israel*, 2 vols., 1887-1888; vol. ii. in conjunction with Oscar Holtzmann) has made him very widely known. With C. Siegfried he has revised and edited the Hebrew lexicon, *Hebr. Wörterbuch zum Alten Testament* (1892-1893). Stade's other works include *Über die alttestamentlichen Vorstellungen vom Zustand nach dem Tode* (1877), *Lehrbuch der hebr. Grammatik* (vol. i., 1879), *Ausgewählte akademische Reden und Abhandlungen* (1899), and *Biblische Theologie des Alten Testaments* (1905, &c.). He died on the 6th of December 1906.

See O. Pfeiderer, *Development of Theology* (1890).

STADE, a town of Germany in the Prussian province of Hanover, situated on the navigable Schwinge, $\frac{3}{4}$ m. above its confluence with the Elbe, 20 m. N.W. of Hamburg on the railway to Cuxhaven. Pop. (1905), 10,837. It carries on a number of small manufactures and has some shipping trade, chiefly with Hamburg, but the rise of Harburg has deposited it from its former position as the chief port of Hanover. In the neighbourhood are deposits of gypsum and salt. The fortifications, erected in 1755 and strengthened in 1816, were demolished in 1882.

According to the legend, Stade was the oldest town of the Saxons and was built in 321 B.C. Historically it cannot be traced farther back than the 10th century, when it was the capital of a line of counts. In the 13th century it passed to the archbishopric of Bremen. Subsequently entering the Hanseatic League, it rose to some commercial importance.¹ In 1648 Stade became the capital of the principality of Bremen under the Swedes; and in 1719 it was ceded to Hanover, the fate of which it has since shared. The Prussians occupied it without resistance in 1866.

See Jobelmann and Wittpennig, *Geschichte der Stadt Stade* (Stade, 1898).

STADION, JOHANN PHILIPP KARL JOSEPH (1763–1824), Austrian statesman, entered the diplomatic service and rose early to a high position. In 1790–1793 he was ambassador in London. After some years of retirement he was entrusted (1800) with a mission to the Prussian court, where he endeavoured in vain to effect an alliance with Austria. He had greater success as envoy at St Petersburg, where he played a large part in the formation of the third coalition against Napoleon (1805). Notwithstanding the failure of this alliance he was made foreign minister, and in conjunction with the archduke Charles pursued a policy of quiet preparation for a fresh trial of strength with France. In 1808 he abandoned the policy of procrastination, and with the help of Metternich hastened the outbreak of a new war. The unfortunate results of the campaign of 1809 compelled his resignation, but in 1813 he was commissioned to negotiate the convention which finally overthrew Napoleon. The last ten years of his life were spent in a strenuous and partly successful attempt to reorganize the disordered finances of his country.

See A. Beer, *Zehn Jahre österreichischer Politik, 1801–1810* (Leipzig, 1877); *Die Finanzen Oesterreichs im 19. Jahrhundert* (Prague, 1877); Kroner, *Zur Geschichte Oesterreichs, 1792–1816* (Gotha, 1886).

STADIUM, the Latin form of this Greek name for a standard of length, a stade=100 ὀργυιαί (about 6 ft., or 1 fathom)=6 πλεθρα (100 Gr. about 101 Eng. ft.), equivalent to about 606 Eng. ft.; as being about one-eighth of the Roman mile, it is often translated by "furlong." The course for the foot-race at Olympia (q.v.) was exactly a stade in length, and hence the name was given to the Greek foot-race and to the amphitheatre in which the races took place (see GAMES, CLASSICAL).

STADTHOLDER (Du. *stadhouder*, a delegate or representative), the title of the chief magistrate of the seven states which formed the United Netherlands by the union of Utrecht in 1579. Though the word *stad* means a town, it has also the force of the kindred English "stead." A *stadhouder* was not the governor of a "stad" or "stead" in the sense of a place or town. He was in the place, or stead, of the sovereign. The word is translated into Latin by *legatus*, *gubernator* and *praefectus*. The office of stadtholder is a *proconsulatus*, and the High German equivalent is *Statthalter*, a delegate. When the northern Netherlands revolted from Philip II. of Spain, who had inherited his sovereign rights from the house of Burgundy (see NETHERLANDS: *History*), the *stad-*

¹The Stade Elbe-dues (Stader Elbezoll) were an ancient impost upon all goods carried up the Elbe, and were levied at the village of Brunshausen, at the mouth of the Schwinge. The tax was abolished in 1267 by the Hanseatic League, but it was revived by the Swedes in 1688, and confirmed by Hanover. The dues were fostered by the growing trade of Hamburg, and in 1861, when they were redeemed (for £427,600) by the nations trading in the Elbe, the exchequer of Hanover was in the yearly receipt of about £45,000 from this source. Hamburg and Great Britain each paid more than a third of the redemption money.

houder passed from being the representative of an absent sovereign prince and became the chief magistrate of the states in whom the sovereignty resided. Six of the seven states forming the confederation of the United Netherlands took as their stadtholder William of Orange-Nassau, called "the Silent," and his descendants during three generations. The seventh, Friesland, had for stadtholder William's brother, John "the Old," and his descendants. The younger line became stadtholders of the other states after the extinction of the elder, and were the ancestors of the present royal family of the Netherlands. Though the stadtholders of the house of Orange-Nassau were of princely rank and intermarried with the royal families of Europe, they were not sovereign princes. They exercised large administrative powers, and commanded the land and sea forces, but it was with delegated authority given them by each state in domestic affairs, and by the states-general of the confederation in all common and foreign affairs. The states-general and some of the individual states not only claimed but exercised the right of suspending the stadtholdership, as for instance after the death of William II., 1650, and of William III., 1702.

STAËL, MADAME DE. ANNE LOUISE GERMAINE NECKER, BARONNE DE STAËL-HOLSTEIN (1766–1817), French novelist and miscellaneous writer, was born at Paris on the 22nd of April 1766. Her father was the famous financier Necker, her mother Suzanne Curchod, almost equally famous as the early love of Gibbon, as the wife of Necker himself, and as the mistress of one of the most popular salons of Paris. Between mother and daughter there was, however, little sympathy. Mme Necker, despite her talents, her beauty and her fondness for *philosophie* society, was strictly decorous, somewhat reserved, and disposed to carry out in her daughter's case the rigorous discipline of her own childhood. The future Mme de Staël was from her earliest years a romp, a coquette, and passionately desirous of prominence and attention. There seems moreover to have been a sort of rivalry between mother and daughter for the chief place in Necker's affections, and it is not probable that the daughter's love for her mother was increased by the consciousness of her own inferiority in personal charms. Mme Necker was of a most refined though somewhat lackadaisical style of beauty, while her daughter was a plain child and a plainer woman, whose sole attractions were large and striking eyes and a buxom figure. She was, however, a child of unusual intellectual power, and she began very early to write though not to publish. She is said to have written her father a letter on his famous *Compte-Rendu* and other matters when she was not fifteen, and to have injured her health by excessive study and intellectual excitement. But in reading all the accounts of Mme de Staël's life which come from herself or her intimate friends, it must be carefully remembered that she was the most distinguished and characteristic product of the period of *sensibilité*—the singular fashion of ultra-sentiment which required that both men and women, but especially women, should be always palpitating with excitement, steeped in melancholy, or dissolved in tears. Still, there is no doubt that her father's dismissal from the ministry, which followed the presentation of the *Compte*, and the consequent removal of the family from the busy life of Paris, were beneficial to her. During part of the next few years they resided at Coppet, her father's estate on the Lake of Geneva, which she herself made famous. But other parts were spent in travelling about, chiefly in the south of France. They returned to Paris, or at least to its neighbourhood, in 1785, and Mlle Necker resumed literary work of a miscellaneous kind, including a novel, *Sophie*, printed in 1786, and a tragedy, *Jeanne Grey*, published in 1790. It became, however, a question of marrying her. Her want of beauty was compensated by her fortune. But her parents are said to have objected to her marrying a Roman Catholic, which, in France, considerably limited her choice. There is a legend that William Pitt the younger thought of her; the somewhat notorious lover of Mlle de Lespinasse, Guibert, a cold-hearted coxcomb of some talent, certainly paid her addresses. But she finally married Eric Magnus, Baron of Staël-Holstein, who was first an attaché of the Swedish

legation, and then minister. For a great heiress and a very ambitious girl the marriage scarcely seemed brilliant, for Staël had no fortune and no very great personal distinction. A singular series of negotiations, however, secured from the king of Sweden a promise of the ambassadorship for twelve years and a pension in case of its withdrawal, and the marriage took place on the 14th of January 1786. The husband was thirty-seven, the wife twenty. Mme de Staël was accused of extravagance, and latterly an amicable separation of goods had to be effected between the pair. But this was a mere legal formality, and on the whole the marriage seems to have met the views of both parties, neither of whom had any affection for the other. They had three children; there was no scandal between them; the baron obtained money and the lady obtained, as a guaranteed ambassadress of a foreign power of consideration, a much higher position at court and in society than she could have secured by marrying almost any Frenchman, without the inconveniences which might have been expected had she married a Frenchman superior to herself in rank. Mme de Staël was not a *persona grata* at court, but she seems to have played the part of ambassadress, as she played most parts, in a rather noisy and exaggerated manner, but not ill. Then in 1788 she appeared as an author under her own name (*Sophie* had been already published, but anonymously) with some *Lettres sur J. J. Rousseau*, a fervid panegyric showing a good deal of talent but no power of criticism. She was at this time, and indeed generally, enthusiastic for a mixture of Rousseauism and constitutionalism in politics. She exulted in the meeting of the states-general, and most of all when her father, after being driven to Brussels by a state intrigue, was once more recalled and triumphantly escorted into Paris. Every one knows what followed. Her first child, a boy, was born the week before Necker finally left France in unpopularity and disgrace; and the increasing disturbances of the Revolution made her privileges as ambassadress very important safeguards. She visited Coppet once or twice, but for the most part in the early days of the revolutionary period she was in Paris taking an interest and, as she thought, a part in the councils and efforts of the Moderates. At last, the day before the September massacres, she fled, befriended by Manuel and Tallien. Her own account of her escape is, as usual, so florid that it provokes the question whether she was really in any danger. Directly it does not seem that she was; but she had generously strained the privileges of the embassy to protect some threatened friends, and this was a serious matter.

She betook herself to Coppet, and there gathered round her a considerable number of friends and fellow-refugees, the beginning of the quasi-court which at intervals during the next five-and-twenty years made the place so famous. In 1793, however, she made a visit of some length to England, and established herself at Mickleham in Surrey as the centre of the Moderate Liberal emigrants—Talleyrand, Narbonne, Jaucourt and others. There was not a little scandal about her relations with Narbonne; and this Mickleham sojourn (the details of which are known from, among other sources, the letters of Fanny Burney) has never been altogether satisfactorily accounted for. In the summer she returned to Coppet and wrote a pamphlet (*Réflexions sur le procès de la reine*) on the queen's execution. The next year her mother died, and the fall of Robespierre opened the way back to Paris. M de Staël (whose mission had been in abeyance and himself in Holland for three years) was accredited to the French republic by the regent of Sweden; his wife reopened her salon and for a time was conspicuous in the motley and eccentric society of the Directory. She also published several small works, the chief being an essay *De l'Influence des passions* (1796), and another *De la Littérature considérée dans ses rapports avec les institutions sociales* (1800). It was during these years that Mme de Staël was of chief political importance. Narbonne's place had been supplied by Benjamin Constant, whom she first met at Coppet in 1794, and who had a very great influence over her, as in return she had over him. Both personal and political reasons threw her into opposition to Bonaparte. Her own preference for a moderate republic or a constitutional

monarchy was quite sincere, and, even if it had not been so, her own character and Napoleon's were too much alike in some points to admit of their getting on together. For some years, however, she was able to alternate between Coppet and Paris without difficulty, though not without knowing that the First Consul disliked her. In 1797 she, as above mentioned, separated formally from her husband. In 1799 he was recalled by the king of Sweden, and in 1802 he died, duly attended by her. Besides the eldest son Auguste Louis, they had two other children—a son Albert, and a daughter Albertine, who afterwards became the duchesse de Broglie.

The exact date of the beginning of what Mme de Staël's admirers call her duel with Napoleon is not easy to determine. Judging from the title of her book *Dix années d'exil*, it should be put at 1804; judging from the time at which it became pretty clear that the first man in France and she who wished to be the first woman in France were not likely to get on together, it might be put several years earlier. The whole question of this duel, however, requires consideration from the point of view of common sense. It displeased Napoleon no doubt that Mme de Staël should show herself recalcitrant to his influence. But it probably pleased Mme de Staël to quite an equal degree that Napoleon should apparently put forth his power to crush her and fail. Both personages had a curious touch of *charlatanerie*. If Mme de Staël had really desired to take up her parable against Napoleon seriously, she need only have established herself in England at the peace of Amiens. But she lingered on at Coppet, constantly hankering after Paris, and acknowledging the hankering quite honestly. In 1802 she published the first of her really noteworthy books, the novel of *Delphine*, in which the "femme incomprise" was in a manner introduced to French literature, and in which she herself and not a few of her intimates appeared in transparent disguise. In the autumn of 1803 she returned to Paris. Whether, if she had not displayed such extraordinary anxiety not to be exiled, Napoleon would have exiled her remains a question; but, as she began at once appealing to all sorts of persons to protect her, he seems to have thought it better that she should not be protected. She was directed not to reside within forty leagues of Paris, and after considerable delay she determined to go to Germany. She journeyed, in company with Constant, by Metz and Frankfort to Weimar, and arrived there in December. There she stayed during the winter and then went to Berlin, where she made the acquaintance of August Wilhelm Schlegel, who afterwards became one of her intimates at Coppet. Thence she travelled to Vienna, where, in April, the news of her father's dangerous illness and shortly of his death (April 8) reached her. She returned to Coppet, and found herself its wealthy and independent mistress, but her sorrow for her father was deep and certainly sincere. She spent the summer at the château with a brilliant company; in the autumn she journeyed to Italy accompanied by Schlegel and Sismondi, and there gathered the materials of her most famous work, *Corinne*. She returned in the summer of 1805, and spent nearly a year in writing *Corinne*; in 1806 she broke the decree of exile and lived for a time undisturbed near Paris. In 1807 *Corinne*, the first aesthetic romance not written in German, appeared. It is in fact, what it was described as being at the time of its appearance, "a picturesque tour couched in the form of a novel." The publication was taken as a reminder of her existence, and the police of the empire sent her back to Coppet. She stayed there as usual for the summer, and then set out once more for Germany, visiting Mainz, Frankfort, Berlin and Vienna. She was again at Coppet in the summer of 1808 (in which year Constant broke with her, subsequently marrying a German lady) and set to work at her book, *De l'Allemagne*. It took her nearly the whole of the next two years, during which she did not travel much or far from her own house. She had bought property in America and thought of moving thither, but chance or fatality made her determine to publish *De l'Allemagne* in Paris. The submission to censorship which this entailed was sufficiently inconsistent and she wrote to the emperor one of the unfortunate letters, at once undignified and provoking, of which she had the

secret. A man less tyrannical or less mean-spirited than Napoleon would of course have let her alone, but Napoleon was Napoleon, and she perfectly well knew him. The reply to her letter was the condemnation of the whole edition of her book (ten thousand copies) as "not French," and her own exile, not as before to a certain distance from Paris, but from France altogether. The act was unquestionably one of odious tyranny, but it is impossible not to ask why she had put herself within reach of it when her fortune enabled her to reside anywhere and to publish what she pleased. She retired once more to Coppet, where she was not at first interfered with, and she found consolation in a young officer of Swiss origin named Rocca, twenty-three years her junior, whom she married privately in 1811. The intimacy of their relations could escape no one at Coppet, but the fact of the marriage (which seems to have been happy enough) was not certainly known till after her death.

The operations of the imperial police in regard to Mme de Staël are rather obscure. She was at first left undisturbed, but by degrees the château itself became taboo, and her visitors found themselves punished heavily. Mathieu de Montmorency and Mme Récamier were exiled for the crime of seeing her; and she at last began to think of doing what she ought to have done years before and withdrawing herself entirely from Napoleon's sphere. In the complete subjection of the Continent which preceded the Russian War this was not so easy as it would have been earlier, and she remained at home during the winter of 1811, writing and planning. On the 23rd of May she left Coppet almost secretly, and journeyed by Bern, Innsbruck and Salzburg to Vienna. There she obtained an Austrian passport to the frontier, and after some fears and trouble, receiving a Russian passport in Galicia, she at last escaped from the dungeon of Napoleonic Europe.

She journeyed slowly through Russia and Finland to Sweden, making some stay at St Petersburg, spent the winter in Stockholm, and then set out for England. Here she received a brilliant reception and was much lionized during the season of 1813. She published *De l'Allemagne* in the autumn, was saddened by the death of her second son Albert, who had entered the Swedish army and fell in a duel brought on by gambling, undertook her *Considérations sur la révolution française*, and when Louis XVIII. had been restored returned to Paris. She was in Paris when the news of Napoleon's landing arrived and at once fled to Coppet, but a singular story, much discussed, is current of her having approved Napoleon's return. There is no direct evidence of it, but the conduct of her close ally Constant may be quoted in its support, and it is certain that she had no affection for the Bourbons. In October, after Waterloo, she set out for Italy, not only for the advantage of her own health but for that of her second husband, Rocca, who was dying of consumption. Her daughter married Duke Victor de Broglie on the 20th of February 1816, at Pisa, and became the wife and mother of French statesmen of distinction. The whole family returned to Coppet in June, and Byron now frequently visited Mme de Staël there. Despite her increasing ill-health she returned to Paris for the winter of 1816-1817, and her salon was much frequented. But she had already become confined to her room, if not to her bed. She died on the 14th of July, and Rocca survived her little more than six months.

Mme de Staël occupies a singular position in French literature. The men of her own time exalted her to the skies, and the most extravagant estimates of her (as "the greatest woman in literary history," as the "foundress of the romantic movement," as representing "ideas," while her contemporary Chateaubriand only represented words, colours, and images, and so forth) are to be found in minor histories of literature. On the other hand, it is acknowledged that she was soon very little read. No other writer of such eminence is so rarely quoted; none is so entirely destitute of the tribute of new and splendid editions. The abundant documents in the hands of her descendants, the families of Broglie and Haussouville, have indeed furnished material for books and papers, but these are almost wholly on the social aspect of Mme de Staël, not on her

literary merit. Nor, when the life and works are examined is the neglect without excuse. Her books are seen to be in large part merely clever reflections of other people's views or views current at the time. The sentimentality of her sentiment and the florid magniloquence of her style equally disgust the reader. But to state this alone would be in the highest degree unfair. Mme de Staël's faults are great; her style is of an age, not for all time; her ideas are mostly second-hand and frequently superficial. But nothing save a very great talent could have shown itself so receptive. Take away her assiduous frequentation of society, from the later *philosophe* coteries to the age of Byron—take away the influence of Constant and Schlegel and her other literary friends—and probably little of her will remain. But to have caught from all sides in this manner the floating notions of society and of individuals, to reflect them with such vigour and clearness, is not anybody's task. Her two best books, *Corinne* and *De l'Allemagne*, are in all probability almost wholly unoriginal, a little sentiment in the first and a little constitutionalism in the second being all that she can claim. But *Corinne* is still a very remarkable exposition of a certain kind of aestheticism, while *De l'Allemagne* is still perhaps the most remarkable account of one country, by a native and inhabitant of another, which exists in literature.

Baron Auguste de Staël (d. 1827) edited the complete works of his mother in seventeen volumes (Paris, 1820-1821), with a notice by Mme Necker de Saussure, and the edition was afterwards republished in a compact form, and, supplemented by some *Euvres inédites*, is still obtainable in three volumes, large 8vo (Didot). The *Considérations* and the *Dix années d'exil* had been published after Mme de Staël's death. Some *Lettres inédites* to H. Meister were published in 1903. There is no recent reissue of the whole, and the minor works have not been reprinted, but *Corinne*, *Delphine* and *De l'Allemagne* are easily accessible in cheap and separate forms. Of separate works on Mme de Staël, or rather on Coppet and its society, besides those of MM Caro and Othenin d'Haussonville, may be mentioned the capital work of A. Sorel in the *Grands écrivains français*. In English there are biographies by A. Stevens (London, 1880), and Lady Blennerhasset (1889). (G. SA.)

STAFF (O. Eng. *staef*, cf. Du. *staf*, Ger. *Stab*, &c.; Icel. *stafr* meant also a written letter, and O. Eng. *stafas*, the letters of the alphabet; "stave," one of the thin pieces of wood of which a cask is made, is a doublet), a long stick or pole, used either as an aid in walking, as a weapon as in the old quarter-staff (*q.v.*) or as a symbol of dignity and office, *e.g.* the pastoral staff (*q.v.*). Further the word is applied to the pole on which a flag is hoisted and to various measuring surveying instruments. Probably from the early use of the word for the letters of the alphabet, "staff" and its doublet "stave" came to be used of a line, verse or stanza, and in musical notation (*q.v.*) of the horizontal lines on which notes are placed to indicate the pitch. A particular use, perhaps derived from the sense of an aid or help, is that of a body of assistants, particularly military.

The *military staff* organization of to-day, with its subdivision and specialization, is a modern product. Although generals have always provided themselves with aides-de-camp and orderlies, the only official corresponding to a modern staff officer in a 16th or 17th century army was the "sergeant-major-general" or "major-general," in whom was vested the responsibility of forming the army in battle array and also the command of the foot. In those days armies, large and small, were arrayed in deep formations and, occupying but a narrow front both in camp and in battle, were easily manageable by one man and his messengers. A little later, however, we find a "quarter-master-general" and his assistants charged with the duties of selecting camps, reconnoitring the country and collecting information generally. The quartermaster-general himself was sometimes used, as Marlborough used Cadogan (*q.v.*), not only as chief-of-staff and as quartermaster-general in the strict sense, but also as the general's authorized representative with detachments, advanced guards, &c. But there was no subdivision of functions in the modern sense. A staff was a group of officers attached temporarily to headquarters and available for any mission which the commander thought fit to give them, and in the highly centralized armies of those days these missions

(as regards junior officers) were practically limited to orderly work and reconnaissance, especially topographical reconnaissance. Subordinate generals had aides-de-camp only. Apart, then, from the "adjutants" or personal staffs (amongst whom must be reckoned the commander-in-chief's secretary, generally a civilian), the staff in the field in Frederick the Great's day was the quartermaster-general's staff, and it was chiefly concerned, both in peace and war, with military engineering duties. In the Seven Years' War Frederick's Q.M.G. staff¹ comprised two to six officers, usually engineers, and by 1806 the quartermaster-general had practically monopolized engineering and scientific appointments at headquarters. Summer the staff officers devoted to surveying and topographical reconnaissance; winter to the codification of the information obtained. None of them were employed or trained with troops, although Frederick the Great sometimes made the quartermaster-general's officers at Berlin do duty with the guards.

With the French Revolution, however, the organization of the staff gradually modified itself to suit the new conditions of warfare. The size of armies necessitated subdivision and separate staffs for the subordinate leaders, their mobility reduced the importance of minute topographical reconnaissance, and the necessity of communicating between the several groups of an army produced an increased demand for orderly officers. But naturally a fully developed staff system did not spring to life immediately. Only by degrees were generals evolved who could handle large and mobile armies, and the highly gifted army leaders who in time appeared, Napoleon of course above all, scarcely needed a general staff. Napoleon had a chief of staff, Marshal Berthier, who bore the old title of "major-general," but Berthier was practically a chief clerk, a man of extraordinary aptitude for business. Berthier's staff was distinctly a mobile war office, and the great captain who needed not advice, but obedience, was wont to despatch his orders by a crowd of subalterns. The principal contribution, therefore, made by Napoleon to the development of staff organization was the thorough establishment of the principle of corps and divisional autonomy. Corps and divisions to be self-contained required, and they were furnished with, their own staffs. The old type of "quartermaster," whose "castrametation" and engineering science had been essential in the days of rigid indivisible armies, disappeared and gave way to a type of staff officer whose duty was to translate his chief's general instructions (other than those delivered in the field by the gallopers of the personal staff) into orders for the various subordinate commanders. The general staff officer's functions as strategical assistant to his chief were non-existent. This system worked satisfactorily in the main while Berthier was at the head of the central office, somewhat less satisfactorily in the Waterloo campaign when Marshal Soult occupied his place, and worst of all it worked in various wars of the 19th century in which the self-contained great general was not forthcoming. The general staff became a mere bureau, divorced from the army. Thus on the French side in 1870 Marshal Bazaine so far distrusted his general staff that he forbade it to appear on the battlefield, and worked the army almost wholly by means of his personal staff. Thus the latter, the mere mouthpiece of the marshal, issued sketchy strategical orders for movements, and so reduced the rate of marching of the army to five or six miles a day; while the former, kept in the dark by the commander-in-chief, issued either no orders at all or orders that had no reference to the real condition of affairs and the marshal's intentions. The army at large distrusted both staffs equally.

The Prussian general staff was as different from this staff of bureaucrats and amateurs as day from night. Even before 1806 Massenbach (*q.v.*) had added the preparation of strategical plans to the work of the quartermaster-general's staff, obtaining thus at the expense of the adjutant-general's side the powers of a general staff in the modern sense. That he was incapable of using these powers is shown by the mournful history of Jena. But another quartermaster-general in the war of 1806,

¹ The "general staff" was simply the list of general officers.

Scharnhorst (*q.v.*), took up his work and in a very different spirit. In Scharnhorst's first instructions of 1808 it was laid down that an *accurate* knowledge of troops and a *general* knowledge of country were essential to a staff officer who was to be practised in exercises with troops and also in surveying. Scharnhorst, moreover, distributed general staff officers in peace to the provincial commands. The business-like habits which he instilled into his pupils, and their close touch with commanders and troops, began a tradition of efficient and accurate staff work in the field, work in which the previous Prussian staff (and indeed all contemporary staffs except Napoleon's) had failed. Thus it was that although the battle of Gravelotte-Saint-Privat was fought on the German side by over 200,000 men and in two or three distinct phases with little central direction, and, moreover, was not finished until after dark, Moltke had in his hands at dawn next morning a complete account of the events of the battle, and of the losses and condition of the troops of each corps. This was the fruit not only of methodical training in the theory of staff duties but of constant practice with troops in field manœuvres.

Another very important feature of the Scharnhorst system was the periodical return of all general staff officers to regimental duty. This indeed has often been considered the keynote of efficiency. It did not at first meet with universal approval, but, like so many other military institutions in Prussia, financial considerations helped to ensure its retention until its intrinsic merits were proved in war. Just as the army was kept at a low peace effective and augmented on mobilization from a numerous reserve, so the staffs were small in peace, but as many officers as possible were passed through them so as to form a staff reserve within the regimental strength of the army.

But above all, the circulation of staff officers made it possible to educate the regimental officer in the approved doctrines of strategy and tactics. "Unity of doctrine" meant that instead of the complicated instructions hitherto issued for any operation, a brief note or even a hint was sufficient. In an army with a "doctrine" all ranks from general to subaltern speak the same language and use the same term in the same sense. There must always be shades of interpretation, varying with the individual officer, as was notably the case in all that Prince Frederick Charles and Blumenthal did in execution of Moltke's "directives" in 1866 and 1870. But the general lines of action in such an army are thoroughly fixed.

A further consequence of the new conception of staff work was an enormous increase in the "discretionary" powers of all officers. If there is to be one and only one doctrine, that doctrine must be comprehensive and elastic, and education in it must consist chiefly in applying the general principle to the specific case. Thence it was not a long step to the notion that an officer could disregard a superior's orders if the situation on which they were based was wrongly conceived or had changed in the meantime. For the test of such independent action is that the "inferior should be conscientiously satisfied that the superior, in his place, would act as he himself proposes to do," and this, of course, is the very purpose of unity of doctrine. The exercise of initiative was peculiarly useful and necessary in the case of the staff officer. He could not only disobey superior orders, but give orders in the name of superior authority. He was better able than any other person to say, not only what action the Field Service Regulations laid down generally for such problems as that in hand, but also what solution his own general, possessing better information than the regimental officers, would adopt if present. The latitude in this respect accorded to German staff officers as well as to German commanders, is a most striking phenomenon of the war of 1870 (*e.g.* Colonel von Caprivi before Vionville and Colonel von der Esch at Wörth).

The result of unity of doctrine, then, was that a properly qualified officer could act as a substitute for his superior, and that the orders which he gave in that capacity were obeyed even by officers higher in rank than the originator of the order. This principle, owing to the peculiar circumstances of the

German army, was carried to an extreme in the case of the chiefs of staff. Moltke himself was a chief of staff, the king, although more experienced than any officer in his army, deliberately accepting Moltke's guidance and assuming the responsibility for the orders that Moltke issued in his name. On several occasions the king indeed formed a different conclusion from Moltke's and gave his orders accordingly, but these were exceptions. The effect of this, however, is not to deprive or to relieve the actual commander from the responsibility for the results of his action, whether that action was suggested by his own brain or by his staff officer's. Such an arrangement depends moreover on mutual confidence. The self-sufficing great commander does not need a Moltke, an average general is wholly ruled by his mentor; and between these two extremes the influence of the chief of staff varies according to circumstances and the character of the general. In the German armies of 1870, for example, the chief staff officer was in one case the reflector of his chief's views, in another he was the real army commander, in a third the characters of the two men were opposed in an almost paralysing equilibrium, while in a fourth the staff officer's business was to soothe and encourage an angry and disheartened commander and at the same time to "keep him straight."

This delicate adjustment is a necessary result of the absorption—inevitable under modern conditions of war—of strategical and even tactical functions by the general staff. The serious risks of disunion within the headquarters—and 1870 proves that even "unity of doctrine" does not altogether eliminate this disunion—has to be faced, and is best insured against by the selection of officers appropriate to each other. The imagination and technique of Hess supplemented the vigorous commonsense of Radetzky; Blücher, with the single supreme military quality of character, could leave all the brain-work to his Gneisenau. But usually, unless other than purely military considerations determine the selection of the general-in-chief (in which case he can make the best soldier in the army—irrespective of seniority—his adviser), smooth and efficient working is best secured when the general and his chief of staff possess the same military qualities in different balance, each compensating the other's weaknesses and deriving strength from the other's good qualities. In the Prussian account of the war of 1859 Moltke writes:—

"Great captains have no need of counsel. They study the questions which arise, and decide them, and their *entourage* has only to execute their decisions. But such generals are stars of the first magnitude, who scarcely appear once in a century. In the great majority of cases the leader of the army cannot do without advice. This advice may be the outcome of the deliberations of a small number of qualified men. But within this small number one and only one opinion must prevail. The organization of the military hierarchy must ensure subordination even in thought, and give the right and duty of presenting a single opinion for the examination of the general-in-chief to one man, and one only. He will be appointed, not by seniority, but by reason of the confidence he inspires. The general-in-chief will always have, as compared with his adviser, the infinitely weightier merit of having assumed the responsibility of executing what he advises."

Thus the chief of the general staff is defined in the British Field Service Regulations as the general's "responsible adviser on all matters affecting military operations, through whom he exercises his functions of command and by whom all orders issued by him will be signed."

Staff Duties in the Field.—The manifold duties essential and incidental to commanding and administering an army, which the general performs, as above defined, through his staff, are in the British service classified broadly into three headings—general staff work, adjutant-general's work and quartermaster-general's work. The immediate head of the general staff, and (if the general delegates the duty) the supervising authority over the other staffs, is the chief of the general staff. The link between the army and the inspector-general or controller of its lines of communication is the quartermaster-general. All details required for insertion in general staff (*i.e.* "operation") orders that come within the adjutant-general's or the quartermaster-general's branch are drafted by those branches in accordance with the general lines laid down by the general staff, and inserted in the orders issued by the general staff. "Routine" orders are drafted and issued by the other staffs themselves.

a. General Staff Duties (Operations).—The study of proposed operations; the framing, issue and despatch of the operation orders; plans for movements to the points of concentration and for strategic deployment; general allotment of areas for quarters; measures of security; intercommunication; reconnaissance; acquisition, collation and distribution of information as to the enemy and the country; flags of truce and correspondence with the enemy; censorship; provision, distribution and revision of maps; reports and despatches relating to operations; furnishing of the adjutant-general's and quartermaster-general's staffs with information as to the situation and probable requirements of the troops, and receiving from these branches such information as affects the operations in prospect.

b. Adjutant-General's Staff (Personnel).—Discipline; application of military law, martial law and international law, both to the army and to the civil population of occupied areas; questions of promotion, appointments of officers, pay, rewards, enlistments; chaplain's services; casualties and invaliding; medical and sanitary services; organization of new corps and drafts; prisoners of war; police; routine and interior economy; ceremonial.

c. Quartermaster-General's Staff (Matériel).—Distribution of camps and quarters within allotted areas; supplies, equipment and clothing (except medical stores); transport by land and sea; railway administration; remounts; veterinary service; postal service.

The work of the lower staffs—divisions and brigades—is similarly subdivided as far as necessary. There are, moreover, the small personal staffs (*aides-de-camp*) of the army and divisional commanders. The work of the latter is not of course as important as it was under the old system, and is partly of a social character, partly orderly work. The headquarters staff of an army of six infantry and one cavalry divisions consists of: *Personal Staff*, 5 officers; *General Staff*, chief and 10 other officers; *Adjutant-General's Staff*, adjutant-general and 4 officers; *Quartermaster-General's Staff*, quartermaster-general and 3 officers; attached in various capacities, 28 officers. 232 non-commissioned officers and men are employed in the work of headquarters as clerks, printers, cooks, servants, &c. The staff of a division consists of: *Personal*, 2 *aides-de-camp*; *General*, 3 or 4 officers; *Adjutant-General's*, 1 officer; *Quartermaster-General's*, 1 officer; attached, 8 officers; rank and file attached, 64–80 men. A brigade staff consists of one general staff officer for operations, a brigade major for administration, and one *aide-de-camp*: attached, 1 officer; rank and file, 33–45.

Staff Duties in Peace.—In modern conditions peace is normal and war exceptional; moreover, as between European nations, the need of a swift decision of a quarrel is so urgent that immediately after mobilization and concentration, if not indeed during these preliminaries, the decisive action of the war may be begun. Success in such a war is the consequence of national spirit in the first place and of the peace training of all ranks in the second. The direction and supervision of the latter is the principal duty of a staff in time of peace, and therefore the specialization of staff functions, referred to above, in the three branches of operations, *personnel* and *matériel*, is as well marked in peace as in war. The two latter branches, which are concerned with the maintenance rather than the use of an army, are necessarily quite as fully occupied in peace as in war, for the life of the army is uninterrupted. But the "general staff" branch would not have enough work to justify a separate existence, were it not for the fact that on the battlefield nothing can be reaped that has not been sown. Nowadays, as the decisive battle immediately follows the concentration of the armies, the crop that is expected to be reaped must be sown in peace time. To this end the modern general staff in peace not only has an existence apart from the routine and supply staffs, but, as in war, occupies the first place in importance. In Great Britain, perhaps more than in any other state, the functions of training and administration are very sharply differentiated. Each commander-in-chief of a large group of garrisons has under him not only a brigadier-general at the head of the general staff, but a major-general "in charge of administration," who in all questions of administration is the *alter ego* of the commander-in-chief. The latter is thus free to devote himself to the training of his troops, which he carries out through the medium of his general staff officers. Only those administrative questions that involve important decisions come before him, the whole of the routine work being carried out by the general in charge of administration in his own office and on his own responsibility.

In the War Office, the general staff work, under the Chief of the Imperial General Staff, is classified into three main heads, for each of which there is a general officer as "director." These are: (a) *Military Operations*, in which all strategical matters connected with imperial defence and operations overseas are studied. (b) *Staff Duties*, which organizes and co-ordinates the whole of the general staff work, and also deals with questions of war organization. (c) *Military Training*, which supervises the Staff College and other educational institutions and also the Officers' Training Corps, and controls and in some cases conducts the professional examinations of officers and candidates for commissions. Under this branch is placed the section which arranges questions of home defence.

The administrative work is divided between the three departments of the *Adjutant-General* (peace organization, mobilization arrangements, record offices and routine orders, medals, regimental

distinctions, titles, &c.; certain artillery and engineer services; and the large and exceedingly important service of personnel, discipline, recruiting, casualties, drafts and reliefs); the *Quartermaster-General* (movements and quartering, barracks, railway administration, mobilization arrangements for rail and sea transportation; remounts and registration of horses for service in war; Army Service Corps work, including horse and mechanical transport, vehicles, &c.; training of administrative personnel; veterinary duties; provision and maintenance of supplies, clothing and stores); the *Master-General of the Ordnance* (armaments and weapons of all kinds, ammunition and explosive stores, military engineering and fortifications, barrack and building construction). Besides these three departments there are the civil departments of the *Civil Member of the Army Council*, under whom, on account of its citizen character, has been placed the administration of the Territorial Force, and who has further all duties connected with war department lands, roads, &c.; and of the *Finance Minister*, which works out the annual estimates, examines financial proposals such as contracts, administers the Army Pay Department, and deals with accounts and audits.

Directly under the Army Council is the department of the Inspector-General of the Forces, whose duties are to review and report upon the training and efficiency of all troops under the home government, the state of stores, remounts, &c., with regard to war requirements, and the condition of fortifications.

See Bronsart von Schellendorf, *Duties of the General Staff* (Eng. trans., 1904); Spenser Wilkinson, *The Brain of an Army*; British official *Field Service Regulations* (1909), pt. ii.; *King's Regulations*, and *Field Service Pocket Book*; v. Janson, *Generalsstabsdienst im Frieden* (1901); French official *Aide-Mémoire de l'officier d'état-major*.

STAFFA (Norse for staff, column, or pillar island), an island of the Inner Hebrides, Argyllshire, Scotland, 54 m. W. of Oban by steamer, about 7 m. from the nearest point of Mull, and 6 m. N. by E. of Iona. It lies almost due north and south, is $\frac{3}{4}$ m. long by about $\frac{1}{2}$ m. wide, is $1\frac{1}{2}$ m. in circumference, has an area of 71 acres, and its highest point is 135 ft. above sea-level. In the north-east it shelves to a shore, but otherwise the coast is rugged and much indented, numerous caves having been carved out by rain, stream and ocean. There is enough grass on the surface to feed a few cattle, and the island contains a spring, but it is uninhabited. During the tourist season it is visited every week-day by steamer from Oban. The island is of volcanic origin, a fragment of an ancient stream of lava. In section the isle is seen to possess a threefold character: there is first a basement of tufa, from which rise, secondly, colonnades of basalt in pillars forming the faces and walls of the principal caves, and these in turn are overlaid, thirdly, by a mass of amorphous basalt. Only the chief caves have been named. On the south-east coast is the Clam-shell or Scallop Cave. It is 30 ft. high, about 18 ft. wide at the entrance, and some 130 ft. long, and on one side of it the ridges of basalt stand out like the ribs of a ship. Near this cave is the rock of Buachaille ("The Herdsman," from a supposed likeness to a shepherd's cap), a pile of columns, fully seen only at low water. On the south-west shore are the Boat Cave and Mackinnon's or the Cormorants' Cave. Fingal's Cave is, however, the most famous of all. It was discovered in 1772 by Sir Joseph Banks, who visited Staffa on his expedition to Iceland. The grotto, situated in the southern face of the isle, is 227 ft. long, 42 ft. wide, 66 ft. high and 25 ft. deep at ebb. On its western side the pillars are 36 ft. high, on its east 18 ft. high. From its mouth to its extremity a pavement of broken pillars runs up one side. The cave is the haunt of seals and sea birds. In suitable atmospheric conditions its beauty is unique. The play of colour is exquisite, the basalt combining every tint of warm red, brown and rich maroon; sea-weeds and lichens paint the cave green and gold; while the lime that has filtered through has crusted the pillars here and there a pure snow-white. From the sombre roof of smooth rock or broken pillars hang yellow, crimson and white stalactites. The floor of the cave is the green sea, out of which the columns rise on either side with a regularity so perfect as to suggest the hand of man rather than the work of Nature. The murmur of the sea won for the cave a Gaelic name meaning "the Cave of Music." At times of storm the compressed air, as it rushes out, produces a sound as of thunder. When the sea is very smooth visitors may be rowed directly into the cave, but the more usual landing-place is near the Clam-shell Cave, where the columns have been worn down until they form a kind of terrace running all the way to Fingal's Cave. The

Wishing Chair is formed out of a column that has broken short. From the Causeway a ladder affords access to the summit of Staffa.

STAFFORD (FAMILY). This famous English house was founded in England by Robert, a younger brother of Ralf de Tosny (Toeni), of a noble Norman house, who was standard-bearer of the duchy. Robert received, like his elder brother, at the Conquest a great fief which extended into seven counties and became known as Robert de Stafford from his residence at Stafford Castle. The military service due from the fief was no less than sixty knights, as is proved by his grandson Robert's return in 1166. With this Robert's son the male line became extinct, and his sister's husband, Hervey Bagot, one of his knightly tenants, succeeded to the fief in her right (1194): their descendant Edmund de Stafford (that surname having been assumed) was summoned as a baron in 1299. His son, Ralph, a warrior like his father, attained fame in the French wars. He conducted the brilliant defence of Aiguillon against the host of France, fought at Crecy and in the siege of Calais. Chosen a Knight of the Garter at the foundation of the order, he was further created earl of Stafford in 1351.

His son Hugh, who succeeded as 2nd earl in 1372, served in the French wars. From 1376 he became prominent in politics, probably through his marriage to a daughter of the earl of Warwick, being one of the four lords on the committee in the Good Parliament, and also serving on the committee that controlled Richard II., 1378-1380. He was friendly, however, with that king, and was with him on his Scottish expedition in 1385. He died next year on pilgrimage at Rhodes. The marriage of his son, Thomas, the 3rd earl, in 1392 to the daughter and eventual heiress of Thomas, duke of Buckingham (son of Edward III.), by a coheirress of the great house of Bohun, proved a decisive turning-point in the history of the Staffords; for, although he died childless, this great lady, styled "countess of Stafford, Buckingham, Hereford and Northampton" in her will, married in 1398 his brother Edmund, the 5th earl, who obtained, in addition to her great possessions, her ancestors' office of lord high constable in 1403, but was slain the same year at Shrewsbury, commanding the van of the king's host. Their son, Humphrey (1402-1460), the first Stafford duke of Buckingham, was placed by his descent and his possessions in the front rank of the English nobility.

The Staffords fell from their pinnacle of greatness, which had aroused the jealousy of the Crown, by the attainder of Henry the 2nd duke in 1483, but were completely restored for the time, on the triumph of Henry VII. in 1486, when Edward, the 3rd duke (1478-1521), regained the title and estates. Under Henry VIII. his great position, fortified by his relationship to the Percys, Howards and Nevilles, made him a natural leader of the old nobility, while his recovery of the ancestral office of lord high constable in 1509 increased his prestige. He had not sufficient force of character to take an active part in politics, but the king's easily roused suspicions were excited by private accusations in 1521, and, after a nominal trial by his peers, he was beheaded on the 17th of May 1521, a subsequent act (1523) confirming his attainder. His fate, even under such a king, made a great sensation, exciting sympathy at home, and moving the emperor Charles V. to say that a butcher's dog (Wolsey) had pulled down the noblest buck in England. It is noteworthy that the 2nd and 3rd dukes were both beheaded, while the 1st duke fell in the Wars of the Roses.

Henry (1501-1563), the son of the last duke, was granted by the Crown some of his father's manors for his support, and, espousing the Protestant cause (though married to a daughter of Margaret, countess of Salisbury and sister of Cardinal Pole), was restored in blood on Edward VI.'s accession and declared Lord Stafford, as a new creation, by act of parliament. His second surviving son, Thomas, eventually assumed the royal arms, on the ground of his lofty descent, sailed from Dieppe with two ships in April 1557, landed at Scarborough, seized the castle, and proclaimed himself protector. He was captured and executed for high treason. His father's new barony, in 1637, passed to a cadet in humble circumstances, who was called on, as

a pauper, to surrender it to the king, which he did (illegally, it is now held) in 1639. The king thereupon bestowed it on Mary Stafford (the heir general of the line) and her husband, William Howard, in whose descendants it is now vested. Roger, who had surrendered the title, died in 1640, the last heir male, apparently, of the main line of this historic house.

Of the junior lines the most important was that known as Stafford of Hooke (Co. Dorset), which had branched off from the parent stem at a very early date. Sir John Stafford of this line married his kinswoman, a daughter of the 1st earl of Stafford. From their younger son, Ralf, descended the Staffords of Grafton and other families; the elder, who fought in the French wars, was grandfather of John (Stafford), archbishop of Canterbury. This prelate came to the front under Henry VI., becoming treasurer (1422), bishop of Bath and Wells (1425), and lord chancellor (1432-1450). Archbishop from 1443 to his death in 1452, he steered an even course between parties as a moderate man and useful official. His elder brother obtained Hooke by marriage, and left two sons, of whom the younger was grandfather of Humphrey Stafford, who succeeded to Hooke, fought for Edward IV. at Towton, and was summoned as Lord Stafford of Southwick in July 1461, and was advanced to the earldom of Devon on the 7th of May 1469, after the execution of the Courtenay earl, which he is said to have intrigued for. Failing to support the earl of Pembroke against the rebels a few months later, he was responsible for their victory, for which he was arrested and beheaded (Aug. 17). With him ended the Staffords of Hooke.

Sir Humphrey Stafford of Grafton (of their cadet line) was an active supporter of Richard III., and was executed for high treason by Henry VII. in 1485. From him descended Sir Edward Stafford (whose mother was a daughter of Henry, Lord Stafford), an Elizabethan diplomatist, who was appointed resident ambassador to France in 1583, a post which he held with success to 1590, sitting afterwards in parliament for Stafford, and dying in 1605. His brother William (1554-1612) was concerned in some obscure plots under Elizabeth.

Another offshoot from the main line was that of the Staffords of Clifton (Co. Stafford), founded by Sir Richard, younger brother of the 1st earl of Stafford, who was closely associated with him in French warfare and negotiation, fought, like him, at Crecy, and acted as seneschal of Gascony (1361-1362). Clifton came to him in marriage with a Camville heiress, and he was summoned as a baron in 1371. His eldest surviving son, Edmund (1344-1419), a churchman, became bishop of Exeter in 1395, and was lord chancellor from 1396 to 1399. He lost the office on Henry IV.'s accession, but held it again from 1401 to 1403. He then devoted himself to his diocese till his death in 1419. His patronage of learning is commemorated by Exeter College, Oxford. The male line of the Staffords of Clifton ended about 1445.

Of younger sons of the main line who attained peerage rank Sir Hugh Stafford, K.G., a son of the 2nd earl, was summoned as a baron from 1411 to 1413 (probably in right of his wife, a Bouchier heiress), but died childless in 1420. John, a son of the 1st duke of Buckingham, received the garter and an earldom of Wiltshire (1470), which became extinct with his son in 1499, but was revived in 1510 for Henry Stafford, K.G., a son of the 2nd duke, who, however, died childless in 1523.

The Staffords made illustrious marriages from the day of the 1st earl; a son of the 1st duke married the mother of Henry VII. The badge of the family was "the Stafford knot," at one time as famous as "the ragged staff" of the earls of Warwick.

See Dugdale, *Baronage* (1675), vol. i.; G. E. C. (okayne), *Complete Peerage*; Wrottesley, *History of the Family of Bagot* (1908) and *Crecy and Calais* (1898). The important Stafford MSS. in Lord Bagot's possession are calendared in the 4th Report on Historical MSS., and the Salt Arch. Soc.'s collections for the history of Staffordshire are valuable for early records. Harcourt's *His Grace the Steward and the Trial of Peers* (1907) should also be consulted. The bishop of Exeter's Register was edited by Hingeston-Randolph in 1886. *Papers relating to the two Baronies of Stafford* (1807), and Campbell's *The Stafford Peerage* (1818) are useful for the pedigree, and there are collections for a history of the family in Add. MSS. (Brit. Mus.) 14.409; 19.150. (J. H. R.)

STAFFORD, EARLS AND MARQUESSES OF. The earldom of Stafford, created in 1351, was held at first by the family of Stafford (see above). In 1521 it became extinct, and in September 1640 Sir William Howard (1614-1680), a son of Thomas Howard, earl of Arundel and Surrey, having three years previously married Mary (d. 1694), sister and heiress of Henry Stafford, 5th Baron Stafford, was created Baron Stafford and two months later viscount of Stafford. Accused by Titus Oates of participating in the popish plots, he was found guilty, and was beheaded on the 29th of December 1680, his titles being forfeited.

His son, Henry Stafford Howard (1658-1719), who, but for his father's attainder, would have inherited the barony and the viscounty, was created earl of Stafford in 1688, his mother being created countess of Stafford at the same time; he was succeeded by his nephew William (c. 1690-1734). When John Paul, the 4th earl (1700-1762), died, the earldom became extinct, but the title to the barony, which was under attainder, fell into abeyance.

The 4th earl's sister Mary (d. 1765) married Francis Plowden (d. 1712), and in 1824 their descendant, Sir George William Jerningham, Bart. (1771-1851), of Costessy Park, Norfolk, obtained a reversal of his ancestor's attainder and was recognized as Baron Stafford. The barony is still held by the Jerninghams.

In 1758 Granville Leveson-Gower (1721-1803) was created marquess of Stafford. He was the son of John Leveson-Gower (d. 1754), who was created Viscount Trentham and Earl Gower in 1746. The public positions held by him included that of lord privy seal, which he filled from 1755 to 1757, and again from 1784 to 1794; of master of the horse; of lord chamberlain of the royal household; and of lord president of the council, which he held from 1767 to 1769 and in 1783-1784. This wealthy and influential nobleman, who was the last survivor of the associates of the duke of Bedford, the "Bloomsbury gang," died at Trentham Hall, in Staffordshire, on the 26th of October 1803. His son and successor, George Granville Leveson-Gower, was created duke of Sutherland in 1833. A younger son was Granville Leveson-Gower, who was created Earl Granville in 1833. The title of marquess of Stafford is now borne by the eldest son of the duke of Sutherland.

STAFFORD, a market town, municipal and parliamentary borough, and the county town of Staffordshire, England, on the river Sow, a western tributary of the Trent. Pop. (1901), 20,895. It is an important junction on the main line of the London & North-Western railway, by which it is 133½ m. N.W. from London. Branches of this company diverge to Wolverhampton and Birmingham, and to Walsall; a joint line of the North-Western and Great Western companies to Shrewsbury and Welshpool; the Great Northern serves the town from the eastern counties, and the North Staffordshire runs north through the Potteries district. The town, while largely modernized, contains a number of picturesque half-timbered houses. The church of St Mary, a fine cruciform building having a transitional Norman nave, and Early English and Decorated in other parts, was formerly collegiate, its canons having mention in Domesday, though the complete foundation is attributed to King John. It contains a memorial to the famous angler, Izaak Walton, born at Stafford in 1593. The older church of St Chad contains good Norman details, but is chiefly a reconstruction. It formerly provided sanctuary. There are county council buildings, a shire hall and a borough hall. The grammar school is an ancient foundation enlarged in 1550 by Edward VI. The county technical institution is in Stafford. A museum, consisting principally of the collections of Clement Wragge, and called by his name, contains a specially fine series of fossils. The William Salt library, presented to the borough in 1872 after the death of the collector, has a large collection of books and MSS., deeds and pictures relating to the county. Charitable institutions include a general infirmary, county asylum, and the Coton Hill institution for the insane. The burgesses of Stafford had formerly common rights over a considerable tract known as Coton Field and Stone Flat; the first is now divided into allotments and the second is a recreation ground. The staple trade is the manufacture of

boots and shoes; there are ironworks, and salt is prepared from brine wells in the neighbourhood. These also supply baths. The parliamentary borough was extended in 1885, when the representation was reduced from two members to one. The town is governed by a mayor, 8 aldermen and 24 councillors. Area, 1084 acres.

In the beautiful well-wooded neighbourhood an interesting site is that of Stafford Castle, on a hill commanding a wide prospect. The existing ruin is that of an unfinished mansion dating from 1810, which replaced an old stronghold. Beyond it is an early encampment, Bury Ring.

Stafford (*Stadford, Staffort, Stafforde*) is said to have originally been called Betheneay from Berthelin, a hermit who lived here. The first authentic mention of it is in the Anglo-Saxon Chronicle, where it is stated that Aethelwulf, lady of the Mercians, in 913 built a fort at Stafford. It was a place of considerable importance in later Anglo-Saxon times, and the evidence of coins shows that a mint then existed here. Stafford is described as a borough in Domesday Book, and at the time of the survey it was the chief place in the county though many of the houses were "wasted." The king received all the dues, two-thirds coming to him as king, the other third as earl of Stafford. From the Domesday Survey it appears that the Conqueror took certain land out of the manor of Chelsea in order to erect a castle at Stafford; this was destroyed in the wars of the 17th century. A charter from John in 1206 constituted Stafford a free borough. In 1399 the government was by bailiffs. In 1501 it was ordered that two bailiffs should be elected annually out of a council of twenty-five burgesses. Charters were granted by Edward VI. in 1551 and by James I. in 1605, the latter incorporating it under the title of the mayor and burgesses of the borough of Stafford: owing to irregularities in elections, another almost similar charter was given by George IV., under which the town was governed until 1835. In Elizabeth's reign Stafford was in a depressed condition owing partly to the decay of the cap manufacture which formerly had been considerable. Speed (d. 1629) states that Lichfield is "more large" than Stafford: in the middle of the 18th century the town had "greatly increased of late by their manufacture of cloth:" about the same time the shoe trade began. Two fairs, to be held on St Matthew's day and on the 4th of December, were granted in 1261 and 1685 respectively, and are still kept up. There are now eight annual fairs in all.

STAFFORDSHIRE, a midland county of England, bounded N.E. by Derbyshire, E. by that county and Leicestershire, S.E. by Warwickshire, S. by Worcestershire, S.W. by Shropshire and N.W. by Cheshire. The area is 1171.2 sq. m. The county includes the valley of the Trent from its source to the point at which it becomes navigable, Burton-upon-Trent. It rises in the extreme north of the county, and follows a southerly course, turning eastward and finally north-eastward through the centre of the county. Its tributaries on the left bank follow a course roughly parallel with it; the chief are the Blythe and the Dove, which receives the Churnet from the west, and forms the county boundary with Derbyshire. The country between Trent, Churnet and Dove is undulating and beautiful; the hills rise to some 1800 ft. on the Derbyshire border in Axe Edge near Buxton, and continue by Mow Cop or Congleton Edge along the Cheshire border to the coal-bearing hills above the Potteries district. Dovedale, the name applied to a portion of the upper valley of the Dove (*q.v.*), attracts many visitors on account of its beauty, and is in favour with anglers for its trout-fishing. South of the Trent, about the middle of the county, an elevated area is known as Cannock Chase, formerly a royal preserve, now a wealthy coalfield, and the high ground, generally exceeding 500 ft., continues south to surround the great manufacturing district of south Staffordshire (the Black Country), and to merge into the Clent and Lickey Hills of Worcestershire. A small area in the north-west drains to the Weaver, and so to the Mersey, and from the west and south-west the Severn receives some small feeders and itself touches the county in the extreme south-west. The only considerable sheet of water is Aqualate Mere, in the grounds of the mansion of that name near Newport in Shropshire.

Geology.—The Pennine folding gently plicates the northern of two Carboniferous tracts interrupting the Midland Triassic plateau in Staffordshire, but affects the unconformable Trias less. It isolates the Pottery and smaller coalfields mainly in synclines, but elevates the western margin of the former anticlinally. A prolongation arches the South Staffordshire Coal Measures, with minor saddles disclosing Silurian inliers, intermediate formations being absent there. Faults depressing the Trias bound the southern coalfield on both sides, the northern Carboniferous westward. At Walsall Upper Llandoverly Sandstone with *Stricklandinia lens* and Barr (Woolhope) Limestone (*Iliaenus barriensis*) underlie Wenlock Shales, succeeded, as at Wren's Nest and Dudley, by Wenlock Limestone in two beds, honeycombed with old lime-workings and famous for trilobites. At Sedgley there follow Lower Ludlow Shales, Sedgley (Aymestry) Limestone (*Pentamerus knighti*) and some Upper Ludlow Shale. Carboniferous Limestone, with gently-sloping hills and deep valleys, enters the northern region on the east. It contains brachiopods and corals of the *Dibunophyllum* zone, with lead and copper, once worked at Ecton. Marine Pendleside (Yoredale) Shales, with thin limestones and higher sandstones, ascend around a central syncline and the northern margins of the coalfields into the Millstone Grit, whose four grits in massive escarpments, only the "First" and "Third" persisting westward, alternate with shales. The Pottery Coalfield, the centre of pottery manufacture, though local clays now furnish only coarse ware and the "saggars" in which pottery is baked, includes 8000 ft. of Coal Measures, chiefly shales, clays and sandstones, diminishing southward. The Lower and Middle Measures (5000 ft.) contain the principal coals, about forty, with comparatively barren strata (1000 ft.) preceding the Wimpenny, Bullhurst, Cockshead, Bambury, Ten-foot, and higher coals associated with "clayband" ironstones. The neighbouring Cheadle Coalfield comprises the lower 2000 ft., with the Crabtree, Woodhead and Dilhorne coals; two other little coalfields comprise only the lowest strata. The South Staffordshire coalfield has 500-1000 ft. of equivalent measures, with the Bottom, Fireclay, New Mine, Heathen, the composite Tenyard and other coals, besides ironstones to which the Black Country originally owed its hardware industry. Plants (*Lepidodendron*, *Neuropteris heterophylla*), fresh-water shells (*Carbonicola acuta*, *C. robusta*) and fishes are characteristic fossils; but the roof of the North Staffordshire Crabtree Coal (Lower Measures) and several higher bands yield marine goniatites, &c. Shales, pottery-clays and "blackband" ironstones with thin *Spirorbis*-limestones, Entomostraca and *Anthracomya phillipsi* (Blackband Series), succeed in the Pottery Coalfield. Then follow red brick-clays with ashy grits (Etruria Marls); white sandstones with *Pecopteris arborescens* (Newcastle-under-Lyme Series); red sandstones and clays with *Spirorbis*-limestones (Keele Series); paralleled in South Staffordshire respectively by Red Coal Measure Clays, Halesowen Sandstone, and beds like the Keele Series. Around this the Triassic sequence ascends outwards through Bunter (Pebble-Beds between Mottled Sandstones), Keuper Sandstone and Waterstones into Keuper Marl, which, containing gypsum and brine-springs, covers the central plateau, the sandstones emerging marginally and axially. The Pebble-Beds rise in Cannock Chase, and fringe the northern coalfields. Rhaetic outliers on Needwood Forest contain *Aximus cloacinus*. The Rowley and other doleritic sills and dikes invade the southern, one dike the Pottery Coalfield and the Trias.

Glacial drift partly conceals the rocks. Irish Sea ice, entering on the west, left boulder-clay with stratified sands, and mingled with local material, Lake District and Scotch erratics, and shells swept from the sea-bed. It threw down a gravelly moraine before the marginal hills of the Pottery Coalfield, and concentrated countless boulders between Rugeley and Enville. Barred northward by this ice, the Arenig glacier carried Welsh erratics across South Staffordshire to Birmingham. North Sea ice with Cretaceous and Jurassic debris reached east Staffordshire.

Agriculture.—Nearly four-fifths of the total area of the county is under cultivation, and of this more than two-thirds is in permanent pasture, cattle being largely kept, and especially cows for the supply of milk to the towns. Like most of the midland counties, Staffordshire is well wooded. The acreage under corn crops is steadily diminishing, and wheat, which formerly was the principal corn crop, is now superseded in this respect by oats, which occupies over one-half of the corn acreage, little more being under wheat than under barley. Turnips are grown on about half the acreage under green crops.

Manufactures.—The manufactures of Staffordshire are varied and important. Out of the three great coalfields in the north, south and centre (Cannock Chase), the two first have wholly distinct dependent industries. The southern industrial district is commonly known as the Black Country (*q.v.*); it is the principal seat in England of iron and steel manufacture in all its branches. It covers an area, between Birmingham and Wolverhampton, resembling one great town, and includes such famous centres as Walsall, Wednesbury, Dudley (in Staffordshire) and West Bromwich. The northern industrial district is called the Potteries (*q.v.*). Cheadle, east of the Potteries, is the centre of a smaller coalfield. Burton-upon-Trent is famous for its breweries. Chemical works are found in the Black Country, brick and tile works in the Black Country

and at Tunstall, glassworks at Tutbury; there are also a considerable textile industry, as at Newcastle-under-Lyme, paper-mills in that town and at Tamworth, and manufactures of boots and shoes at Stafford and Stone.

Communications.—The main line of the London & North-Western railway runs from south-east to north-west by Tamworth, Lichfield (Trent Valley), Rugeley and Stafford. This company and the Great Western serve the towns of the Black Country by many branches from Birmingham, and jointly work the Stafford-Shrewsbury line. The London & North-Western has branches from Trent Valley to Burton-upon-Trent, and from Rugeley through the Cannock Chase coalfields. The North Staffordshire railway runs from Stafford and from Burton-upon-Trent northward through the Potteries, with a line from Uttoxeter through Leek to Macclesfield. The Manifold Valley light railway serves part of the Dovedale district. The west-and-north line of the Midland railway (Bristol-Derby) crosses the south-eastern part of the county from Birmingham by Tamworth and Burton, with a branch to Wolverhampton. The Great Northern, with a branch from its main line at Grantham, serves Uttoxeter, Burton and Stafford. A considerable amount of coal-transport takes place along canals, the Black Country especially being served by numerous branches. The principal canals are—the Grand Trunk, which follows the Trent over the greater part of

hampton are county boroughs; Lichfield is a city, and Stafford is the county town. The urban districts are—in the southern industrial district, Amblecote (3218), Bilston (24,034), Brierley Hill (12,042), Coseley (22,219), Darlaston (15,395), Handsworth (52,921), Heath Town or Wednesfield Heath (9441), Perry Bar (2348), Quarry Bank (6012), Rowley Regis (34,670), Sedgley (15,951), Short Heath (3531), Tettehall (5337), Tipton (30,543), Wednesfield (4883), Willenhall (18,515); in the northern industrial district, Audley (13,683), Biddulph (6247), Fenton (22,742), Kidsgrove (4552), Smallthorne (6263), Tunstall (19,492), Wolstanton (24,975); elsewhere, Brownhills (15,252), Cannock (23,974), Leek (15,484), Rugeley (4447), Stone (5680), Uttoxeter (5133). Among other towns may be mentioned Abbots Bromley (1318), Brewwood (2535), Cheadle (5186) and Eccleshall (3799). The county is in the Oxford circuit, and assizes are held at Stafford. It has one court of quarter sessions, and is divided into 23 petty sessional divisions. The boroughs of Hanley, Lichfield, Newcastle-under-Lyme, Walsall, West Bromwich and Wolverhampton have separate commissions

of the peace and courts of quarter sessions, and those of Burslem, Burton, Longton, Stafford, Stoke-upon-Trent, Smethwick, Tamworth and Wednesbury have separate commissions of the peace only. The total number of civil parishes is 277. The county is almost wholly in the diocese of Worcester, but has small parts in those of Hereford, Southwell and Chester; it contains 348 ecclesiastical parishes or districts, wholly or in part. Staffordshire is divided into seven parliamentary divisions each returning one member—Burton, Handsworth, Kingswinford, Leek, Lichfield, North-West and West. The parliamentary borough of Wolverhampton returns a member for each of three divisions, and the boroughs of Hanley, Newcastle-under-Lyme, Stafford, Stoke-upon-Trent, Walsall, Wednesbury and West Bromwich each return one member.

History.—The district which is now Staffordshire was invaded in the 6th century by a tribe of Angles who settled about Tamworth, afterwards famous as a residence of the Mercian kings, and later made their way beyond Cannock Chase, through the passages afforded by the Sow valley in the north and Watling Street in the south. The district was frequently overrun by the Danes, who in 910 were defeated at Tettehall, and again at Wednesfield, and it was after Edward the Elder had finally expelled the Northmen from Mercia that the land of the south Mercians was formed into a shire around the fortified burgh which he had made in 914 at Stafford. The county is first mentioned by name in the Anglo-Saxon Chronicle in 1016 when it was harried by Canute.

The resistance which Staffordshire opposed to the Conqueror was punished by ruthless harrying and confiscation, and the Domesday Survey supplies evidence of the depopulated and impoverished condition of the county, which at this period contained but 64 mills, whereas Dorset, a smaller county, contained 272. No Englishman was allowed to retain estates of any importance after the Conquest, and the chief lay proprietors at the time of the survey were Earl Roger of Montgomery; Earl Hugh of Chester; Henry de Ferrers, who held Burton and Tutbury castles; Robert de Stafford; William Fitz-Ansculf, afterwards created first Baron Dudley; Richard Forester; Rainald Bailiol; Ralph Fitz Hubert and Nigel de Stafford. The Ferrers and Staffords long continued to play a leading part in Staffordshire history, and Turstin, who held Drayton under William Fitz Ansculf, was the ancestor of the Bassets of Drayton. At the time of the survey Burton was the only monastery in Staffordshire, but foundations of canons existed at Stafford, Wolverhampton, Tettehall, Lichfield,

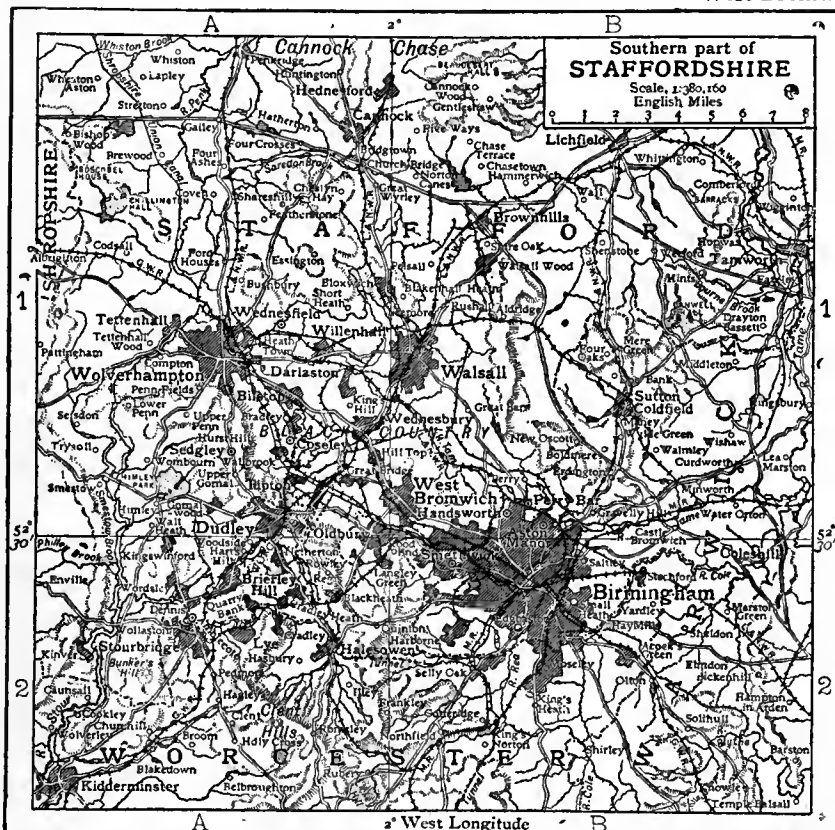

Information embodied from the Ordnance Survey, by permission of the Controller of H. M. Stationery Office.

Emery Walker & Co.

its course within the county, the Coventry, Birmingham and Fazeley, Daw End and Essington canals, connecting the Grand Trunk with Warwickshire, the Black Country and Cannock Chase; the Liverpool and Birmingham junction; the Staffordshire and Worcestershire, running from the Severn at Stourport by Wolverhampton and Penkridge to the Grand Junction near Stafford, and the Caldron canal running eastward from the Potteries into the Churnet Valley.

Population and Administration.—The area of the ancient county is 749,602 acres, with a population in 1891 of 1,083,424; and in 1901 of 1,234,506. The area of the administrative county is 744,984 acres. Staffordshire contains five hundreds, each having two divisions. The municipal boroughs are: in the southern industrial district, Smethwick (pop. 54,539), Walsall (86,430), Wednesbury (26,554), West Bromwich (65,175), Wolverhampton (94,187); in the northern industrial district, Newcastle-under-Lyme (19,914), and the several formerly separate boroughs amalgamated under the "Potteries Federation" Scheme (1908) under the name of Stoke-upon-Trent (*q.v.*); elsewhere, Burton-upon-Trent (50,386), Lichfield (7902), Stafford (20,895), Tamworth (7271). Burton, Hanley, Smethwick, Walsall, West Bromwich and Wolver-

Penkridge and Tamworth, while others at Hanbury, Stone, Strensall and Trentham had been either destroyed or absorbed before the Conquest. The five hundreds of Staffordshire have existed since the Domesday Survey, and the boundaries have remained practically unchanged. Edingale, however, was then included under Derbyshire, and Tirley under Shropshire, while Cheswardine, Chipnall and part of Bobbington, now in Shropshire, were assessed under Staffordshire. The hundreds of Offlow and Totmonslow had their names from sepulchral monuments of Saxon commanders. The shire court for Staffordshire was held at Stafford, and the assizes at Wolverhampton, Stafford and Lichfield, until by act of parliament of 1558 the assizes and sessions were fixed at Stafford, where they are still held.

In the 13th century Staffordshire formed the archdeaconry of Stafford, including the deaneries of Stafford, Newcastle, Alton and Leek, Tamworth and Tutbury, Lapley and Creigull. In 1535 the deanery of Newcastle was combined with that of Stone, the deaneries remaining otherwise unaltered until 1866, when they were increased to twenty. The archdeaconry of Stoke-on-Trent was formed in 1878, and in 1896 the deaneries were brought to their present number; the archdeaconry of Stafford comprising Handsworth, Himley, Lichfield, Penkridge, Rugeley, Stafford, Tamworth, Trysull, Tutbury, Walsall, Wednesbury, West Bromwich and Wolverhampton; the archdeaconry of Stoke-on-Trent comprising Alstonfield, Cheadle, Eccleshall, Hanley, Leek, Newcastle-under-Lyme, Stoke-on-Trent, Trentham and Uttoxeter.

In the wars of the reign of Henry III. most of the great families of Staffordshire, including the Bassets and the Ferrers, supported Simon de Montfort, and in 1263 Prince Edward ravaged all the lands of Earl Robert Ferrers in this county and destroyed Tutbury Castle. During the Wars of the Roses, Eccleshall was for a time the headquarters of Queen Margaret, and in 1459 the Lancastrians were defeated at Blore Heath. In the Civil War of the 17th century Staffordshire supported the parliamentary cause and was placed under Lord Brooke. Tamworth, Lichfield and Stafford, however, were garrisoned for Charles, and Lichfield Cathedral withstood a siege in 1643, in which year the Royalists were victorious at Hopton Heath, but lost their leader, the earl of Northampton. In 1745 the Young Pretender advanced as far as Leek in this county.

A large proportion of Staffordshire in Norman times was waste and uncultivated ground, but the moorlands of the north afforded excellent pasturage for sheep, and in the 14th century Wolverhampton was a staple town for wool. In the 13th century mines of coal and iron are mentioned at Walsall, and ironstone was procured at Sedgley and Eccleshall. In the 15th century both coal and iron were extensively worked. Thus in the 17th century the north of the county yielded coal, lead, copper, marble and millstones, while the rich meadows maintained great dairies; the woodlands of the south supplied timber, salt, black marble and alabaster; the clothing trade flourished about Tamworth, Burton, and Newcastle-under-Lyme; and hemp and flax were grown all over the county. The potteries are of remote origin, but were improved in the 17th century by two brothers, the Elers, from Amsterdam, who introduced the method of salt glazing, and in the 18th century they were rendered famous by the achievements of Josiah Wedgwood.

Staffordshire was represented by two members in the parliament of 1290, and in 1295 the borough of Stafford also returned two members. Lichfield was represented by two members in 1304, and Newcastle-under-Lyme in 1355. Tamworth returned two members in 1562. Under the Reform Act of 1832 the county returned four members in four divisions, and the boroughs of Stoke-on-Trent and Wolverhampton were represented by two members each, and Walsall by one member. Under the act of 1868 the county returned six members in three divisions and Wednesbury returned one member.

Antiquities.—Early British remains exist in various parts of the county; and a large number of barrows have been opened in which human bones, urns, fibulae, stone hammers, armlets,

pins, pottery and other articles have been found. In the neighbourhood of Wetton, near Dovedale, on the site called Borough Holes, no fewer than twenty-three barrows were opened, and British ornaments have been found in Needwood Forest, the district between the lower Dove and the angle of the Trent to the south. Several Roman camps also remain, as at Knave's Castle on Watling Street, near Brownhills. The most noteworthy churches in the county are found in the large towns, and are described under their respective headings. Such are the beautiful cathedral of Lichfield, and the churches of Eccleshall, Leek, Penkridge St Mary's at Stafford, Tamworth, Tutbury, and St Peter's at Wolverhampton. Checkley, 4 m. south of Cheadle, shows good Norman and Early English details, and there are carved stones of pre-Norman date in the churchyard. Armitage, south-east of Rugeley, has a church showing good Norman work. Brewood church, 4 m. south-west of Penkridge, is Early English. This village gives name to an ancient forest. Audley church, north-west of Newcastle-under-Lyme, is a good example of Early Decorated work. Remains of ecclesiastical foundations are generally slight, but those of the Cistercian abbey of Croxden, north-west of Uttoxeter, are fine Early English, and at Ranton, west of Stafford, the Perpendicular tower and other portions of an Augustinian foundation remain. Among medieval domestic remains may be mentioned the castles of Stafford, Tamworth and Tutbury, with that of Chartley, north-east of Stafford, which dates from the 13th century. Here is also a timbered hall, in the park of which a breed of wild cattle is maintained. Beaudesert, south of Rugeley, is a fine Elizabethan mansion in a beautiful undulating demesne. In the south-west, near Stourbridge, are Enville, a Tudor mansion with grounds laid out by the poet Shenstone, and Stourton Castle, embodying portions of the 15th century, where Reginald, Cardinal Pole, was born in 1500. Among numerous modern seats may be named Ingestre, Ilam Hall, Alton Towers, Shugborough, Patteshull, Keele Hall, and Trentham.

See Robert Plot, *Natural History of Staffordshire* (Oxford, 1686); S. Erdeswick, *Survey of Staffordshire* (London, 1717; 4th ed., by T. Harwood, London, 1844); Stebbing Shaw, *History and Antiquities of Staffordshire, &c.*, vol. i., ii., pt. i. (London, 1798-1801); William Pitt, *Topographical History of Staffordshire* (Newcastle-under-Lyme, 1817); Simeon Shaw, *History of the Staffordshire Potteries* (Hanley, 1829); Robert Garner, *Natural History of the County of Stafford* (London, 1844-1860); William Salt, *Archaeological Society, Collections for a History of Staffordshire* (1880), vol. i.; *Victoria County History; Staffordshire*.

STAG (O. Eng. *stagga*, a Norse word, cf. Icel. *steggr*, *steggi*, a male animal, cf. *Steggander*, a drake; it is usually referred to *stigan*, to climb, to mount, but this is doubtful), the common name of the male of many species of the deer tribe, but usually confined to the male of the red deer (*Cervus claphus*), "buck" being used in other cases, as of the fallow-deer (see DEER and PECORA). In Stock Exchange slang the term is used of an operator who applies for a portion of a new security being issued, not with a view to holding it, but with the intention of immediate realization, at a profit if possible.

STAGE (Fr. *étage*; from Lat. *stare*, to stand), in architecture, an elevated floor, particularly the various storeys of a bell-tower, &c. The term is also applied to the plain parts of buttresses between cap and cap where they set back, or where they are divided by horizontal strings and panelling. It is used, too, by William of Worcester to describe the compartments of windows between transom and transom, in contradistinction to the word *bay*, which signifies a division between mullion and mullion (see STOREY). From the sense of the floor or platform on which plays were acted the term came to signify both the theatre (*q.v.*) and the drama (*q.v.*). And from its etymological meaning of a station comes the sense of a place for rest on a journey, the distance between such places, &c.

STAHL, FRIEDRICH JULIUS (1802-1861), German ecclesiastical lawyer and politician, was born at Munich on the 16th of January 1802, of Jewish parentage. Although brought up strictly in the Jewish religion, he was allowed to attend the

gymnasium, and, as a result of its influence, was at the age of nineteen baptized into the Lutheran Church. To this faith he clung with earnest devotion and persistence until his death. Having studied law at Würzburg, Heidelberg and Erlangen, Stahl, on taking the degree of *doctor juris*, established himself as *privatdozent* in Munich, was appointed (1832) ordinary professor of law at Würzburg, and in 1840 received the chair of ecclesiastical law and polity at Berlin. Here he immediately made his mark as an ecclesiastical lawyer, and was appointed a member of the first chamber of the synod. Elected in 1850 a member of the short-lived Erfurt parliament, he bitterly opposed the idea of German federation. Stahl early fell under the influence of Schelling, and at the latter's insistence, began in 1827 his great work: *Die Philosophie des Rechts nach geschichtlicher Ansicht* (an historical view of the philosophy of law), in which he bases all law and political science upon Christian revelation, denies rationalistic doctrines, and, as a deduction from this principle, maintains that a state church must be strictly confessional. This position he further elucidated in his *Der christliche Staat und sein Verhältniss zum Deismus und Judenthum* (The Christian State and its relation to Deism and Judaism; 1874). As Oberkirchenrath (synodal councillor) Stahl used all his influence to weaken the Evangelical Union (*i.e.* that compromise between the Calvinist and Lutheran doctrines which is the essence of the Prussian Evangelical Church) and to strengthen the influence of the Lutheran Church (cf. *Die Lutherische Kirche und die Union*, 1859). The Prussian minister von Bunsen attacked, while King Frederick William IV. supported, Stahl in his ecclesiastical policy, and the Prussian Evangelical Church would probably have been dissolved had not the regency of Prince William (afterwards the emperor William I.) supervened in 1858. Stahl's influence fell under the new régime, and, resigning his seat on the synod, he retired into private life and died at Brückenau on the 10th of August 1861.

See "Biographie von Stahl," in *Unsere Zeit*, vi. 419-447 (anonymous, but probably by Gneist); *Pernice, Savigny, Stahl* (anonymous; Berlin, 1862).

STAHL, GEORG ERNST (1660-1734), German chemist and physician, was born on the 21st of October 1660 at Anspach. Having graduated in medicine at Jena in 1683, he became court physician to the duke of Weimar in 1687. From 1694 to 1716 he held the chair of medicine at Halle, and was then appointed physician to the king of Prussia in Berlin, where he died on the 14th of May 1734. In chemistry he is chiefly known in connexion with his doctrine of phlogiston, the essentials of which, however, he owed to J. J. Becher; and he also propounded a view of fermentation which in some respects resembles that supported by Liebig a century and half later. In medicine he professed an animistic system, in opposition to the materialism of Hermann Boerhaave and Friedrich Hoffmann.

The most important of his numerous writings are *Zymotechnia fundamentalis sive fermentationis theoria generalis* (1697), which contains the phlogistic hypothesis; *Specimen Becherianum* (1702); *Experimenta, observationes, animadversiones . . . chymicae et physicae* (1731); *Theoria medica vera* (1707); *Arts sanandi cum expectatione* (1730).

STAINER, SIR JOHN (1840-1901), English composer and organist, was born at Southwark on the 6th of June 1840. He was the second son of the schoolmaster of the parish school of St Thomas's, Southwark, who was enough of a musician to teach his son the organ and the art of reading music, in which he was already proficient when, in 1847, he entered the choir of St Paul's Cathedral. He remained there till 1856, and often took the organ in emergencies; he held the post of organist of St Benet's and St Paul's, Upper Thames Street, during the last year of his choristership; and in 1856 was given the appointment of organist to St Michael's College, Tenbury, where his musical and general education benefited greatly from the intercourse with Sir Frederick Gore Ouseley. He was appointed to Magdalen College, Oxford, in 1860, and became university organist in the following year. While at Oxford he did much to bring the choir of Magdalen to a remarkable state of excellence;

he took a keen interest in the foundation of various musical societies; and as a sign of his appreciation of the value of general culture, it is worth recording that he took the degree of B.A. in 1864, that of Mus. D. in 1865, and procured M.A. in 1867, being appointed a university examiner in music in the same year. In 1868 he was engaged frequently as solo organist at the Crystal Palace; and in 1872 was appointed organist of St Paul's, where he raised the standard of choral music to something very like perfection. He was professor of the organ in the National Training School of Music from 1876, and in 1881 succeeded his lifelong friend Sullivan as principal. In 1878 he was a juror at the Paris Exhibition, and was created Chevalier of the Légion d'Honneur. In 1882 he became inspector of music in training colleges. In 1888 he retired from the organistship of St Paul's owing to failing eyesight, and was knighted. In 1889 he succeeded Ouseley as professor of music in the university of Oxford, holding the post till 1890. Besides these official distinctions he received a great number of honorary degrees: he was vice-president of the Royal College of Organists, and president of the Plain-song and Medieval Music Society, the London Gregorian Association, and the Musical Association. His compositions include four oratorios: *Gideon* (1865), *The Daughter of Jairus* (Worcester, 1878), *St Mary Magdalen* (Gloucester, 1887), *Crucifixion* (London, 1887); forty-two anthems, some of them very elaborate; many hymn-tunes, organ pieces, madrigals, &c. His professorial lectures were of great value, and he made many contributions to the literature of music. He was a man of wide influence, with a remarkable faculty of organization, and his work in regard to the conditions of the musical profession was of considerable importance. His own music has many of the defects of his qualities, for his breadth of artistic views led him to admire and adopt many styles that are not always compatible with each other. He died while on a holiday at Verona on the 31st of March 1901.

STAINES, a market town in the Uxbridge parliamentary division of Middlesex, England, on the river Thames at the junction of the Colne, 19 m. W.S.W. of London on the London & South Western and Great Western railways. Pop. of urban district (1901), 6688. Breweries and mustard mills employ many hands. A rifle range for the Metropolitan Volunteers and others was opened in 1892. A British village was situated here at the crossing of the Thames on the main road from London to south-western Britain, and the crossing was certainly one of the earliest bridged. A grant of oaks from Windsor forest for the repair of the bridge is recorded in 1262. The existing bridge, from the designs of George Rennie, was opened in 1831, after three bridges had failed in the previous forty years. The name of Staines appears in the Domesday Survey, and it has been supposed that the town is so called from a stone which marks the limit of the former jurisdiction of the City of London over the lower Thames. This is still considered to be the boundary between the upper and lower Thames. In the immediate neighbourhood, though included in the parish of Egham, Surrey, is Runnimead Island, where King John signed the Magna Carta.

STAIR, JAMES DALRYMPLE, 1ST VISCOUNT (1619-1695), Scottish lawyer and statesman, was born in May 1619, at Drummurchie in Ayrshire. He was descended from a family for several generations inclined to the principles of the Reformation, and had ancestors both on the father's and the mother's side amongst the Lollards of Kyle. His father, James Dalrymple, laird of the small estate of Stair in Kyle, died when he was an infant; his mother, Janet Kennedy of Knockdaw, is described as "a woman of excellent spirit," who took care to have him well educated. From the grammar school at Mauchline he went, in 1633, to the university of Glasgow, where he graduated in arts on the 26th of July, 1637. Next year he went to Edinburgh, probably with the intention of studying law, but the troubles of the times, then approaching a crisis, led him to change his course, and we next find him serving in the earl of Glencairn's regiment in the War of the Covenant. What part he took in it is not certainly known, but he was in command of

a troop when recalled in 1641 to compete for a regency (as a tutorship or professorship was then called) in the university of Glasgow. He was elected in March. Mathematics, logic, ethics and politics were the chief subjects of his lectures, and a notebook on logic by one of his students has been preserved. His activity and skill in matters of college business were praised by his colleagues, who numbered amongst them some of the leading Covenanted divines, and his zeal in teaching was gratefully acknowledged by his students. After nearly seven years' service he resigned his regency, and removed to Edinburgh, where he was admitted to the bar on the 17th of February 1648. This step had probably been rendered easier by his marriage, four years before, to Margaret Ross, co-heiress of Balneil in Wigtown. Stair's practice at the bar does not appear to have been large; his talents lay rather in the direction of learning and business than of oratory or advocacy. His reputation and the confidence reposed in him were shown by his appointment in 1649 as secretary to the commission sent to the Hague to treat with Charles II. by the parliament of Scotland. The negotiation having been broken off through the unwillingness of the young king to accept the terms of the Covenanters, Stair was again sent in the following year to Breda, where the failure of Montrose's expedition forced Charles to change his attitude and to return to Scotland as the covenanted king. Stair had preceded him, and met him on his landing in Aberdeenshire, probably carrying with him the news of the execution of Montrose, which he had witnessed.

During the Commonwealth Stair continued to practise at the bar; but like most of his brethren he refused in 1654 to take the oath of allegiance to the Commonwealth. Three years later, on the death of Lord Balcomie, Stair was appointed one of the commissioners for the administration of justice in Scotland, on the recommendation of Monk. His appointment to the bench on the 1st of July 1657, by Monk, was confirmed by Cromwell on the 26th. Stair's association with the English judges at this time must have enlarged his acquaintance with English law, as his travels had extended his knowledge of the civil law and the modern European systems which followed it. He thus acquired a singular advantage when he came to write on law, regarding it from a cosmopolitan, or international, rather than a merely local or national point of view. His actual discharge of judicial duty at this time was short, for after the death of Cromwell the courts in Scotland were shut—a new commission issued in 1660 not having taken effect, it being uncertain in whose name the commission ought to run. It was during this period that Stair became intimate with Monk, who is said to have been advised by him when he left Scotland to call a full and free parliament. Soon after the Restoration Stair went to London, where he was received with favour by Charles, knighted, and included in the new nomination of judges in the court of session on the 13th of February 1661. He was also put on various important commissions, busied himself with local and agricultural affairs, and, like most of the Scottish judges of this and the following century, acted with zest and credit the part of a good country gentleman.

In 1662 he was one of the judges who refused to take the declaration that the national covenant and the solemn league and covenant were unlawful oaths, and, forestalling the deposition which had been threatened as the penalty of continued non-compliance, he placed his resignation in the king's hands. The king, however, summoned him to London, and allowed him to take the declaration under an implied reservation. The next five years of Stair's life were comparatively uneventful, but in 1669 a family calamity, the exact facts of which will probably never be ascertained, overtook him. His daughter Janet, who had been betrothed to Lord Ruthfurd, was married to Dunbar of Baldoon, and some tragic incident occurred on the wedding night, from the effects of which she never recovered. As the traditions vary on the central fact, whether it was the bride who stabbed her husband, or the husband who stabbed the bride, no credence can be given to the mass of superstitions

and spiteful slander which surrounded it, principally levelled at Lady Stair.¹ In 1670 Stair served as one of the Scottish commissioners who went to London to treat of the Union; but the project, not seriously pressed by Charles and his ministers, broke down through a claim on the part of the Scots to what was deemed an excessive representation in the British parliament. In January 1671 Stair was appointed president of the court of session. In the following year, and again in 1673, he was returned to parliament for Wigtownshire, and took part in the important legislation of those years in the department of private law. During the bad time of Lauderdale's government Stair used his influence in the privy council and with Lauderdale to mitigate the severity of the orders passed against ecclesiastical offenders, but for the most part he abstained from attending a board whose policy he could not approve. In 1679 he went to London to defend the court against charges of partiality and injustice which had been made against it, and was thanked by his brethren for his success. When, in the following year, the duke of York came to Scotland Stair distinguished himself by a bold speech, in which he congratulated the duke on his coming amongst a nation which was entirely Protestant. This speech can have been little relished, and the duke was henceforth his implacable enemy. His influence prevented Stair from being made chancellor in 1681, on the death of the duke of Rothes.

The parliament of this year, in which Stair again sat, was memorable for two statutes, one in private and the other in public law. The former, relating to the testing of deeds, was drawn by Stair, and is sometimes called by his name. The other was the infamous Test Act, probably the worst of the many measures devised at this period with the object of fettering the conscience by oaths. Stair also had a minor share in the form which this law finally took, but it was confined to the insertion of a definition of "the Protestant religion"; by this he hoped to make the test harmless, but his expectation was disappointed. Yet, self-contradictory and absurd as it was, the Test Act was at once rigidly enforced. Argyll, who declared he took it only in so far as it was consistent with itself and the Protestant religion, was tried and condemned for treason and narrowly saved his life by escaping from Edinburgh Castle the day before that fixed for his execution. Stair, dreading a similar fate, went to London to seek a personal interview with the king, who had more than once befriended him, perhaps remembering his services in Holland; but the duke of York intercepted his access to the royal ear, and when he returned to Scotland he found a new commission of judges issued, from which his name was omitted. He retired to his wife's estate in Galloway, and occupied himself with preparing for the press his great work, *The Institutions of the Law of Scotland*, which he published in the autumn of 1681, with a dedication to the king.

He was not, however, allowed to pursue his legal studies in peaceful retirement. His wife was charged with attending conventicles, his factor and tenants severely fined, and he was himself not safe from prosecution at any moment. A fierce dispute arose between Claverhouse and Stair's son, John, master of Stair, relative to the regality of Glenluce; and, both having appealed to the privy council, Claverhouse, as might have been expected, was absolved from all the charges brought against him and the master was deprived of the regality. Stair had still powerful friends, but his opponents were more powerful, and he received advice to quit the country. He repaired to Holland in October 1684, and took up his residence, along with his wife and some of his younger children, at Leiden. While there he published the *Decisions of the Court of Session between 1666 and 1671*, of which he had kept a daily record, and a small treatise on natural philosophy, entitled *Physiologia nova experimentalis*.

In his absence a prosecution for treason was raised against

¹ Sir Walter Scott took the plot of his *Bride of Lammermoor* from this incident, but he disclaimed any intention of making Sir William Ashton a portrait of Lord Stair.

him and others of the exiles by Sir G. Mackenzie, the lord advocate. He was charged with accession to the rebellion of 1679, the Rye House plot, and the expedition of Argyll. With the first two he had no connexion; with Argyll's unfortunate attempt he had no doubt sympathized, but the only proof of his complicity was slight, and was obtained by torture. The proceedings against him were never brought to an issue, having been continued by successive adjournments until 1687, when they were dropped. The cause of their abandonment was the appointment of his son, the master of Stair, who had made his peace with James II., as lord advocate in room of Mackenzie, who was dismissed from office for refusing to relax the penal laws against the Roman Catholics. The master only held office as lord advocate for a year, when he was "degraded to be justice clerk"—the king and his advisers finding him not a fit tool for their purpose. Stair remained in Holland till the following year, when he returned under happier auspices in the suite of William of Orange. William, who had made his acquaintance through the pensionary Fagel, was ever afterwards the firm friend of Stair and his family. The master was made lord advocate; and, on the murder of Lockhart of Carnwath in the following year, Stair was again placed at the head of the court of session. An unscrupulous opposition, headed by Montgomery of Skelmorlie, who coveted the office of secretary for Scotland, and Lord Ross, who aimed at the presidency of the court, sprang up in the Scottish parliament; and an anonymous pamphleteer, perhaps Montgomery himself or Ferguson the Plotter, attacked Stair in a pamphlet entitled *The Late Proceedings of the Parliament of Scotland Stated and Vindicated*. He defended himself by publishing an *Apology*, which, in the opinion of impartial judges, was a complete vindication.

Shortly after its issue he was created Viscount Stair (1690). He had now reached the summit of his prosperity, and the few years which remained of his old age were saddened by private and public cares. In 1692 he lost his wife, the faithful partner of his good and evil fortune for nearly fifty years. The massacre of the Macdonalds of Glencoe (Feb. 13, 1692), which has marked his son, the master of Stair, with a stain which his great services to the state cannot efface—for he was undoubtedly the principal adviser of William in that treacherous and cruel deed, as a signal way of repressing rebellion in the Highlands—was used as an opportunity by his adversaries of renewing their attack on the old president. His own share in the crime was remote; it was alleged that he had as a privy councillor declined to receive Glencoe's oath of allegiance, though tendered, on the technical ground that it was emitted after the day fixed, but even this was not clearly proved. But some share of the odium which attached to his son was naturally reflected on him. Other grounds of complaint were not difficult to make up, which found willing supporters in the opposition members of parliament. A disappointed suitor brought in a bill in 1693 complaining of his partiality. He was also accused of domineering over the other judges and of favouring the clients of his sons. Two bills were introduced without naming him but really aimed at him—one to disqualify peers from being judges and the other to confer on the Crown a power to appoint temporary presidents of the court. The complaint against him was remitted to a committee, which, after full inquiry, completely exculpated him; and the two bills, whose incompetency he demonstrated in an able paper addressed to the commission and parliament, were allowed to drop. He was also one of a parliamentary commission which prepared a report on the regulation of the judicatures, afterwards made the basis of a statute in 1695 supplementary to that of 1672, and forming the foundation of the judicial procedure in the Scottish courts for many years. On the 29th of November 1695 Stair, who had been for some time in failing health, died in Edinburgh, and was buried in the church of St Giles.

In 1695 there was published in London a small volume with the title *A Vindication of the Divine Perfections, Illustrating the Glory of God in them by Reason and Revelation, methodically digested—By a Person of Honour*. It was edited by the two Nonconformist divines, William Bates and John Howe, who had been in exile in

Holland along with Stair, and is undoubtedly his work. Perhaps it had been a sketch of the "Inquiry Concerning Natural Theology" which he had contemplated writing in 1681. It is of no value as a theological work, for Stair was no more a theologian than he was a man of science, but it is of interest as showing the serious bent of his thoughts and the genuine piety of his character.

Stair's great legal work, *The Institutions of the Law of Scotland deduced from its Originals, and collated with the Civil, Canon and Feudal Laws and with the Customs of Neighbouring Nations*, affords evidence of the advantage he had enjoyed from his philosophical training, his foreign travels and his intercourse with Continental jurists as well as English lawyers. Unfortunately for its permanent fame and use, much of the law elucidated in it has now become antiquated through the decay of the feudal part of Scottish law and the large introduction of English law, especially in the departments of commercial law and equity.

The *Physiologia* was favourably noticed by Boyle, and is interesting as showing the activity of mind of the exiled judge, who returned to the studies of his youth with fresh zest when physical science was approaching its new birth. But he was not able to emancipate himself from formulæ which had cramped the education of his generation, and had not caught the light which Newton spread at this very time by the communication of his *Principia* to the Royal Society of London.

Stair was fortunate in his descendants. "The family of Dalrymple," observes Sir Walter Scott, "produced within two centuries as many men of talent, civil and military, of literary, political and professional eminence, as any house in Scotland." His five sons were all remarkable in their professions. John, master of Stair (1648–1707), who was created 1st earl of Stair in 1703, an able lawyer and politician, who is, however, principally remembered for his part in the massacre of Glencoe, is dealt with above. Sir James Dalrymple of Borthwick, created a baronet in 1698, was one of the principal clerks of session, and a very thorough and accurate historical antiquary. Sir Hew Dalrymple of North Berwick (1652–1737) succeeded his father as president, and was reckoned one of the best lawyers and speakers of his time; he, too, was created a baronet in 1698. Thomas Dalrymple became physician to Queen Anne. Sir David Dalrymple of Hailes (d. 1721), who was created a baronet in 1700, was lord advocate under Anne and George I.; and his grandson was the famous judge and historian, Lord Hailes (*q.v.*).

Stair's grandson, John, 2nd earl (1673–1747), who rose to be a field-marshal, gained equal credit in war and diplomacy. He was ambassador in Paris (1715–1720), and, besides seeing service under Marlborough, was commander-in-chief of the British forces on the Continent in 1742, showing great gallantry at the battle of Dettingen. He had no son, and in 1707 had selected his nephew John (1720–1789) as heir to the title; but through a decision of the House of Lords in 1748 he only became 5th earl, after his cousin James and James's son had succeeded as 3rd and 4th earls. John's son, the 6th earl, died without issue, and a cousin again succeeded as 7th earl, his two sons becoming 8th and 9th earls. The 8th earl (1771–1853) was a general in the army, and keeper of the great seal of Scotland. The 9th earl's son and grandson succeeded as 10th and 11th earls.

For a fuller account of the life of Stair, see J. Murray Graham, *Annals of the Viscount and First and Second Earls of Stair* (1875); A. J. G. Mackay, *Memoir of Sir James Dalrymple, First Viscount Stair* (1875); and Sir R. Douglas, *Peerage of Scotland*, new ed., by Sir J. B. Paul.

STAIR (O. Eng. *stæger*, step, from *stigan*, to climb, cf. Ger. *steigen*; the root is also seen in "stile" and "stirrup"), in architecture, the term (Fr. *escalier*) given to a series of steps rising one above the other, either in one straight line or with returns, or round a newel, or open well-hole, either square, rectangular, circular or elliptical. A series of continuous steps is called a "flight." The ordinary staircase of two flights with landing between is known as a "pair"; "two pair back" therefore would be the room at the back on the second floor; in houses where the space occupied by the staircase is very limited there is no landing, but the stairs wind round the corner post or newel, and are known as "winders."

The steps of a stair consist of "tread" and "riser," the

respective dimensions of which vary according to the importance of the staircase and the space which has been given to it; in external flights or stairs, such as those at Persepolis, the tread is so wide and the riser so small in height as to allow of a horse ascending, and generally in garden terraces there is the same slight rise. For the stairs of a palace or municipal building, 14 in. tread and 5 in. riser would be required, but as a rule 12 in. tread and 6 in. riser is adopted. In the stone staircase in the palace at Cnossus in Crete, the treads were 18 in. and the risers 5½ in. In ordinary houses 9 in. or 10 in. is generally given for the tread, and 6½ in. to 7 in. for the riser. In the stairs leading to lofts, and in yachts or steamers, the ascent is much steeper, having sometimes 10 in. rise and 5 in. tread. The series of stairs provided to ascend from one floor to another when enclosed with walls is known as a staircase (*q.v.*). Unenclosed flights of steps placed in front of a building are known by the French term *perron* (*q.v.*), usually applied to a structure like the horseshoe staircase of the palace at Fontainebleau, the stairs of which are carried on a support independent of the main wall of the palace. From this point of view the great return flight of steps at Persepolis might be looked upon as a staircase, because on one side the steps are all embedded in the main wall of the platform.

Belonging to the same type are the great flights of steps which led to the successive stages of the Ziggurats or Assyrian stage towers; those in front of the Propylaea, leading to the Acropolis at Athens; the stairs leading to the Propylaea (150 ft. in width) at Baalbek; others in Palmyra; and generally all the Roman temples. In medieval times should be included the great flights of steps which stood in front of the cathedrals of Europe, some of which, as those at Le Puy in France, Ste Gudule at Brussels, the cathedral at Erfurt in Germany, S. Miniato at Florence in Italy, and others, still exist, not having yet been buried by the gradual raising of the ground-level in great towns; also the immense flights of steps in Rome, leading up to the Trinita del Monte and the Capitol, and those found in all towns built on hills, when an architectural composition has guided their plan.

In Egyptian architecture inclined planes took the place of stairs, as in the sloping corridors of the Great Pyramid, the descent leading to the temple of the Sphinx, and the approaches to the two temples of Deir el-Bahri, one of them the oldest temple found. Inclined planes were also provided in front of some of the Greek temples, where the steps of the stylobate were of great height; similar contrivances were adopted by the Mahomedans in Egypt to ascend the minaret of Ibn Tūlūn and el Hakim; in the great circular tower at Amboise, and in the fallen campanile of St Mark's, Venice. (R. P. S.)

STAIRCASE, the term usually applied (*Fr. cage d'escalier*, *Ger. Treppenhaus*) to the stairs leading to the upper floors in a building, including the enclosure walls. In the ordinary house a single staircase only is provided; in larger ones a second or service staircase; in those of more importance, especially where the principal reception rooms are on the first floor, a grand staircase leading to the latter, and other subsidiary stairs or staircases.

Architecture.—Among the earliest examples are those found in Egypt, generally built in the thickness of the walls, as in the pylons and temples; a remarkable example was found by Dr Arthur Evans in Cnossus, in Crete, consisting of a staircase in stone, 6 ft. wide, with return flights of stairs, rising through two floors; the staircase in the temple of Zeus at Olympia leading to the gallery, is supposed to have been in wood, but in some of the Greek temples have been found stairs in stone with return flights. In the Tabularium at Rome there is a long flight of 67 steps leading up from the Forum to a hall at the back, but otherwise there are few examples of ancient Roman staircases, and none of any importance have been found in Pompeii. Of medieval staircases the principal examples are those in stone built round a circular newel, to provide means of ascent to the various stages of the church towers. One of these, at St Gilles in Provence, is covered with a semicircular

rising vault, which is known as Vis St Gilles; some of these circular staircases are 12 ft. in diameter, others, like those in the campanile of Pisa, are built in the thickness of a circular hall with well-hole in centre. In the 15th century some of the stone staircases leading to the rood loft, with open tracery round the edge, are of great elaboration and beauty, as at St Maclou, Rouen. In the 16th century in France, in the châteaux of the Loire, are many examples, among which the circular staircases at Blois, two of them in square towers, the third octagonal in plan and on one side open at intervals to the court, has a great circular newel enriched with arabesque carving, and a rising elliptical barrel vault with ribs and bosses. In the château of Chambord the great staircase in the middle, which is built round a circular well-hole, had two separate flights, one over the other, so that, starting from opposite sides on the ground floor, two persons could ascend without seeing one another. At Azay le Rideau, Loire, and in the château of St Germain-en-Laye, the staircases in return flights are built between walls, and the same is found in the ducal palace at Venice and most of the palaces of Rome. At Venice, in the Palazzo Minelli, the staircase is in a circular tower with open arcades and balustrades. The most famous staircase in Spain is that in the north transept of Burgos Cathedral, remarkable for the magnificent iron-work of its balustrade; and in England the staircase leading to the hall of Christ Church, Oxford, with a magnificent fan vault, is a fine example. In the 16th and 17th centuries in England the grand staircases of the great mansions were usually in wood, the finest examples being those at Hatfield, Knole, Audley End, &c. They would seem also to have been regarded as part of the great entrance halls, but in France and Italy they assumed greater importance, being always in stone or marble, with colonnades or arcades round the staircase on the first floor. Of these there were three types. The first is the straight staircase with two or more landings, of which examples existed in Paris in the Tuileries and the old Hôtel de Ville, having been reproduced in the new Hôtel de Ville, and the staircase in the Vatican. The second is the staircase with return flights right and left, at the top of a first flight, sometimes built in long rectangular halls, but unsatisfactory owing to the want of concentration and to the difficulty of deciding whether to turn to the right or left at the top of the first flight; examples are in the Herrenchiemsee Palace, Bavaria, the Palazzo Reale at Naples, the Madama Palace at Turin, and the government offices in London. In the new opera house in Paris, J. L. Garnier (*q.v.*) solved the problem better by placing his staircase in a square hall, which, seen from the first floor surrounded with open balconies, forms one of the finest staircase halls known. The third alternative is that of the staircase in three flights, built round a square well-hole, of which the staircase in Holford House is the best example. The vestibule staircases in Genoa which lead to a raised ground-storey, such as those in the Palazzo Durazzo, or in the university, are extremely fine in effect and are executed all in white marble. As the vestibules are open to the narrow streets, it is possible that the title of the "marble palaces of Genoa" refers to those marble staircase halls, because the external walls of the palaces are either in ordinary stone or in brick covered with stucco. (R. P. S.)

Construction.—The primary object of stairs, in house-building, is to afford a safe and easy communication between floors at different levels. To make the communication easy the "rise" and width (or "tread") of the steps should be regular and suitably proportioned to each other with convenient landings; there should be no winding steps, and the rail which is fixed to render the use of the staircase safe should be strongly fixed with its top at a convenient height for the hand.

The first person that attempted to fix the relation between the height and width of a step upon correct principles was, we believe, Blondel, in his *Cours d'architecture*. His formula is applicable to very large buildings but not to ordinary dwellings. Ashpitel, who investigated the subject at length (in *Handrails and Staircases*), gives the following rules for different proportions of treads and risers:—

Width of tread in inches.	Height of rise in inches.
12	5½
11½	5¼
11	6
10½	6¼
10	6½
9½	6¾
9	7

These dimensions give angles of ascent varying from 24° to 37°. The projection of the nosings is not reckoned in the width of the treads and must be added to determine the full width of the treads. It will be seen upon examination that these proportions may be expressed in the following simple formula: 23 = twice the rise in inches + the tread in inches. An American rule is to make the sum of the rise and tread equal to 17 or 17½ in.

The forms of staircases are various, the simplest being a straight flight, which type should only be used to a low storey. In towns, where space cannot be allowed for convenient forms, they are often made angular, circular or elliptical, with winding steps, or are constructed of composite form partly straight and partly circular. In large buildings, where convenience and beauty are the chief objects of attention, winding steps are seldom introduced when it is possible to avoid them. Well-designed stairs should be planned as simply as possible to afford easy and convenient access to the higher level. The staircase must be placed in a position easy of approach, and convenient for both the lower and upper apartments. It must be well ventilated and lighted—the absence of sufficient light may prove the cause of serious accidents. At no part should the head room (that is, the height between the level of a tread and that portion of the structure immediately above it) be less than 7 ft. Straight flights should be composed of not less than four and not more than twelve steps. If it is desired to continue more than this number of steps in a straight line, a landing equal in length at least to the width of the stairs should be provided before starting up the next flight. Winders should be avoided if possible, but should they be found necessary it is advisable to put them at the bottom of a flight rather than at the top, the reason being that should they be the cause of an accident the unfortunate individual will not have far to fall.

Besides the straight flight of stairs, stairs may be designed in almost numberless different ways to suit the position which they are to occupy or with a view to architectural effect, but whatever position or form they are made to take their chief purpose of providing convenient and easy access to a higher level must be steadily borne in mind. Some of the most ordinary forms from which staircases of a more ambitious character are elaborated are the dog-legged or newel stair, open newel stair, geometrical stair, circular newel stairs (see fig. 1).

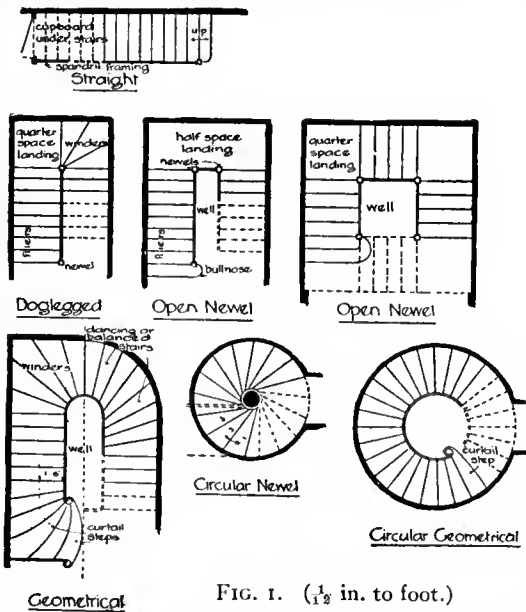

FIG. 1. (1/8 in. to foot.)

The newel or dog-legged stair is so termed from its supposed resemblance to a dog's hind leg. In this form the staircase is divided in width into two equal parts and the outer string of the upper return of the stairs rises in a vertical plane immediately above that of the lower flight. There is therefore no well-hole in this form of construction (see fig. 4, plan and section).

Open newel stairs, as in the previous example, have newels placed at the angles, but are so arranged as to enclose a well. This is more convenient for the distribution of light than the dog-legged stairs, especially when the lighting is effected by means of a lantern skylight placed at the top of the staircase.

Geometrical stairs usually enclose a well, which may vary very much in size and shape from merely a narrow slit between the flights to a square opening admitting of ample ventilation and lighting. This form has continuous strings and handrail, and may be rectangular, circular or elliptical in plan, although it is especially adapted for the curved forms and most satisfactory when so treated. Such stairs are more difficult to construct than the newel stairs already mentioned and lack their strength, as in the absence of the strong framed newel posts the handrail depends for support entirely upon the balusters, which must therefore be very securely fastened to the treads. When wood balusters for the most part are used bars of iron are often introduced at intervals to afford additional stiffness. Circular geometrical stairs are built on a circular plan around a well. Each step is necessarily a winder radiating from the outer string to the wall string. If in wood they must be very carefully framed, especially if the well-hole is small, owing to the difficulty of introducing proper carriages for support, and the number of pieces of which the work must be built up on account of its curvature. This type of stairs is more suitable for building in stone, and in this case support is obtained by pinning the end of the stone step well into the wall and supporting each step upon the one below. The balusters and handrail also, in the case of stone, are much more firmly fixed by the former, which are usually of iron, being let into mortices in the tread or end of the step and run in with molten lead and caulked to secure a firm fixing.

Solid newel or spiral stairs are circular or polygonal on plan and built around a central pillar or newel, which may be square, polygonal or circular in section. This also is a form of stair-building especially suitable for erection in stone, the central newel being formed on the step itself, and the other end well pinned into the masonry of the wall. Each succeeding step should be dowelled at the newel to the one below and should lap for a matter of two or three inches at least for its entire length over the one below and in this way obtain extra support.

The newel stair was at its best in Elizabethan and later Renaissance times. The older form of staircase with circular newel and narrow winding steps was found ill adapted to the altered conditions when convenience and elegance were becoming more sought after. The designers of this period found in the open newel stair a construction capable of being developed into a dignified and beautiful feature of domestic architecture, and they certainly brought out its possibilities in a remarkable manner. This is evidenced by the many fine examples, handed down to us by the architects of the Tudor period, to be found in the great mansions which date back to the time of the early Renaissance. Steps were arranged in broad short flights with wide treads and easy rise. Landings were freely used, and in many cases were large enough to be used as galleries for the display of pictures. The work was generally solidly executed in oak, and carved and moulded decoration was lavished upon every detail. The newels, much enriched, were frequently carried up to the ceiling and formed a portion of the arcading which was often a prominent feature around the well. In the period of the later Renaissance the newel principle of construction was still retained and the main features were the same, but they were planned with longer flights and the manner of decoration partook of a more severely classic nature. One of the first examples is that of the Château de Blois, and of modern treatment that of the Grand Opera House, Paris. In the period of the Georgian era the geometrical staircase was much favoured and very generally used in domestic buildings. Although more difficult to build it must be admitted that this type of stair is not so satisfactory in a number of ways as the newel form. With its continuous curving strings and handrail it has a certain elegance of its own, but in principle of construction it is not so good, nor can it compete with the open newel stair in regard to the ease with which the latter lends itself to schemes of artistic decoration. As before remarked, however, it is well adapted for stairs circular and elliptical in plan.

Experience has proved concrete to have fire-resisting properties of the most effective character, and it does not possess the propensities for splitting and flying under the action of heat that belong to stone.

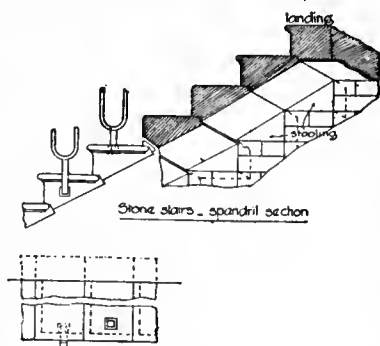

FIG. 2.

Steel or iron is often employed as an additional support for stone and concrete stairs. In the case of concrete work iron bars are frequently embedded in the steps for their full length, and are in this way hidden from sight while at the same time serving the purposes of support. When a more ornate appearance is desired than is obtained by the use of plain concrete Marbles, tiles and mosaic are the principal materials used for this

purpose. Stairs of fine concrete to which is given the name of "artificial stone" have largely superseded those constructed of genuine stone. It is very strong and capable of being further fortified by the introduction of steel core bars without detriment to its appearance; it is consistent in quality and special shapes are readily moulded; it is very hard-wearing, especially when the aggregate consists of a hard nature such as granite chippings. The stairs are built by pinning each step in the wall either at one or at both ends. In the first case they are termed *cantilever* or *hanging steps*, and it is advisable

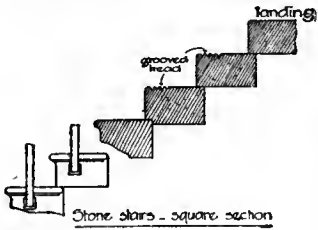

FIG. 3.

($\frac{3}{8}$ in. to foot.)

to use steel reinforcement and pin the end of the step at least 9 in. into the wall. When fixed at both ends the pinning need not be so deep, and unless the stairs are very wide the steel core may be omitted. The steps are either rectangular or spandrel-shaped in section (figs. 2 and 3); the former are stronger and easier to fix than the latter, which, however, give a better appearance and can be finished with a plain smooth soffit. Iron balusters are generally used for stone and concrete staircases, and are fitted with lug terminations which are let into dovetailed mortises formed in the top or side of the stair tread and held fast by molten lead, neat Portland cement, or a mixture of sulphur and sand.

The construction of wood staircases forms a special branch of the joinery craft, and many books have been written on the subject. Numerous methods of setting out the handrails have been put forward by different authors, among them being the tangent system, which gives excellent results at perhaps the smallest cost compatible with good work.

It is noteworthy that the common practice in England with regard to wood stairs is to frame and form the finished work in the workshop and fix it bodily in the position it has to occupy. In America, especially in the eastern states, the finished staircase is built up piece by piece upon a rough framework which has been used by the workmen during the erection of the carcass of the building. In many instances the strings consist of easings and panellings nailed upon the rough skeleton work.

Stairs are built in many kinds of materials, such as wood, stone, concrete, iron and brick. Often two or more kinds of materials are used in the same staircase, as when constructions of concrete or stone are reinforced with iron or steel. It is common also to fit to a staircase handrails, balusters and newels of a different nature from the steps themselves. The spandrel or triangular-shaped space between a flight of stairs and the floor is frequently enclosed with wood-pannelled framing and fitted with a door so that it may be made use of for cupboard accommodation.

There are a number of technical terms connected with staircases which require some explanation to enable the drawings to be easily understood:—

Staircase.—This comprises the whole of the stair construction and is the name given to the space or enclosure which contains the stairs.

Well-hole, the open space enclosed by the stairs.

Flight, a continuous series of steps between two landings.

Landing, a platform forming a kind of halting-place between two flights of stairs. A *quarter-space landing* forms a space, usually a rectangle, equal in width and length to the breadth of the two flights which it separates. A *half-space landing* extends the total width of the staircase.

Flier.—Fliers are steps that have the nosings of the treads parallel one to another.

Winder.—This is an angular-shaped step. A winder fitted into a wall angle is often termed a *kite winder*, from the fact that it resembles a kite. In planning stairs the width of the winder tread at a distance of 18 or 20 in. from the handrail should equal the width of a flier.

Curtail Step.—This may be either a flier or a winder. One or both ends of the step are projected to form a base for the newel and are shaped to a scroll which often follows the line of the curve terminating the handrail. It is usually the step or steps at the base of a staircase that are formed in this way.

Bull-nosed step, one having a blunt rounded end. It may be shaped to a quarter or half circle.

Dancing Stairs.—The introduction of winders in geometrical staircases brings about awkward complications in the curve of the handrail and strings, for the width of the winding steps at the handrail being much less than that of the fliers, while at the same time the rise is necessarily equal, causes an unsightly knee in the handrail and in the strings. To obviate this the whole of the steps are made to dance, that is, they are all shaped as winders in order to divide the going equally between them and thus obtain a regular slope for the strings and handrail. Often the first and last three or four steps of a flight are made ordinary fliers. In a polygonal or elliptical staircase the whole of the flight is constructed in this way so as to

obtain a regular sweep up from the bottom to the top *step*. Each step may be divided into several different parts such as the *tread*, the *riser* and the *nosings*. The tread is the horizontal upper surface of the step which supports the foot when ascending or descending the stairs. The riser is the upright member of a step which supports the tread. It fills in the vertical space between the nosing of one tread and the back edge of the one below. The edge of the tread usually projects some little distance beyond the face of the riser and is formed into a rounded or moulded nosing. Stone stairs and those of concrete usually have each step formed separately in a solid piece of stone of square or triangular section, and these are fixed in position by being pinned into the wall at one or both ends with each step resting upon the back edge of the one below. Stairs of costly marble are frequently built up in a manner somewhat similar to that adopted for wood construction.

Rise, the vertical distance between the surface of one tread and that of the next.

Going, the horizontal measurement between two adjacent risers. In America this is termed the *run*.

Newels, strong posts occurring at intervals in a newel staircase. They are placed at the ends of flights where junction is made to landings, at turnings, and at the top and bottom of the staircase. They should be strongly framed in the stair construction, and have the string and handrail housed into them. Newels are sometimes of iron, and in large stone staircases of stone. They are sometimes of elaborate form and often designed as a pedestal carrying a lamp or statuette, or they may be carried up to form part of some ornamental framing around the staircase. In America the *newel* is the main post where the stairs begin, and the remainder of the posts used in the framing are termed *angle posts*.

Handrail.—This is a rail commonly of hard wood which runs up at the same slope as the stairs at a height above the nosing line of about 2 ft. 8 in. (that is 3 ft. minus half a rise) to the upper surface of the rail. On the level, such as on landings, it is usually fixed 3 ft. above the surface. These are the heights at which a handrail is found to give most assistance to persons going up or down stairs. Handrails are made in other materials such as iron and bronze. A handrail is generally upheld by *balusters*, which are vertical bars or posts filling in the space between the handrail and the string or the treads. They are made in many shapes and in many different materials such as wood, iron, bronze, stone and marble. Sometimes in the place of balusters the space usually occupied by them is filled in with scrollwork of wrought or cast iron or bronze, or with panels of wood perforated, perhaps, and richly carved.

Core-rail.—An iron band is frequently used in geometrical stairs to give extra strength and stiffness to the handrail. It is generally about $\frac{1}{2}$ in. thick, being screwed into a groove formed in the underside of the handrail. It is especially necessary for the curved portions of the handrail, where the grain of the wood is often cut across.

String.—Strings are the members that carry the treads and risers which in wood stairs are housed into them or else fitted into notches cut in the strings to receive them. In the former case the supporting member is termed a *close string*, but if notched out for the steps it is known as a *cut string* (see details, fig. 4). A *cut and mitred string* is similar to this last, but has the vertical cut of each notch splayed and the riser is mitred to it so as not to show the joint. Strings are either *wall strings* or *outer strings*; the former are fixed against the wall, the latter run up from newel to newel or in geometrical stairs ramp and curve according to the nosing line. *Rough strings* or *rough carriages* are placed between the inner and outer strings to afford additional support to the treads and risers, and *rough brackets* about 1 in. thick are fitted into the steps and spiked to the carriages.

Ramp.—This is a concave curve formed in one plane when changing the direction of the handrail or string. In America it is known as an *easing*.

Knee.—This is a convex curve in one direction. When used in conjunction with a ramp it forms a *swan-neck*, which is a combination of ramp and knee.

Wreath.—This is a curve formed both horizontally and vertically in the handrail or string. It is often necessary in geometrical stairs where a change of direction takes place.

Although more in the nature of a mechanical lift or elevator than a stair, moving stairways may perhaps find a place in this article owing to their resemblance and to the fact that their object is to convey the passenger quickly and easily to a higher level without the necessity of a tedious climb up stairs, or of a wait such as is often entailed with a vertical lift. The contrivance consists of an endless inclined platform formed of links bolted together, which allow it to travel round wheels fixed at the top and bottom of the stairway and hidden within its framing. This is kept in continual motion by mechanical means, usually by an electric motor, which causes it to travel at the rate of about 100 ft. a minute. The handrail also moves at the same rate, so that a passenger merely steps on to the lower portion of the stair, places his hand upon the handrail, and is carried swiftly and safely up to the next floor, where he is deposited without any effort on his part. The process of stepping on and getting off the stairway is amazingly simple and without any element of danger

**Moving
Inclines.**

to the passenger. For high buildings, underground railways and similar positions, a spiral form is used which winds round in a circular shaft to the highest level and returns in the opposite direction in a similar manner, taking up and setting down passengers as it revolves. Although this type of elevator is probably not so rapid as the vertical lift working in a straight line to the point it is desired to reach, its great advantage is that it does away with the waiting which often causes so much annoyance with ordinary lifts.

ings, and if possible chased into the wall to avoid projection. The roof over the staircase shall be of fire-resisting materials. Separate exits are required for different parts of the theatre or hall.

The Factory and Workshop Act 1901 contains somewhat similar conditions, but in this case the staircases communicate with each floor and the roof. The minimum width of tread shall be 10 in. and the maximum rise $7\frac{1}{2}$ in. Steps of spandrel section may be used having a thickness of 3 in. at the smallest part for staircases 3 ft. 6 in. wide, and not less than $4\frac{1}{2}$ in. thick for staircases 4 ft. 6 in. wide. External fire escape stairs must be constructed with dead bearings and without cantilever work. They must comply with the requirements for enclosed staircases as regards width, going, width of treads, height of risers, doors, handrails, &c. They must deliver at the ground-level into a public way or some large space. Where in general use the treads must be of non-slippery material as distinguished from perforated iron or chequered iron plates.

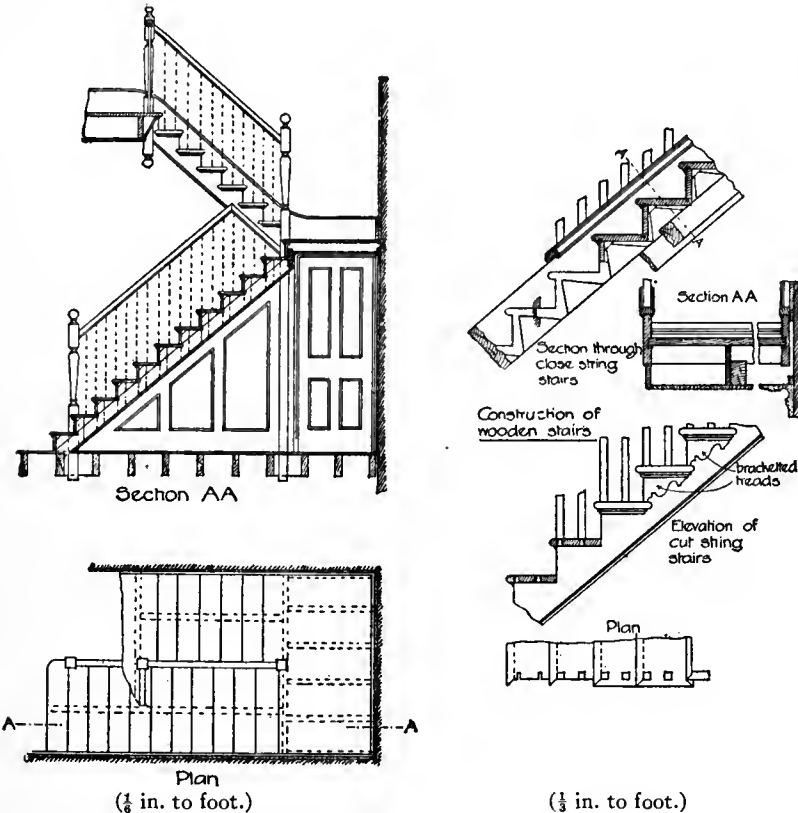

FIG. 4.

The by-laws of the London County Council contain many stipulations regulating the construction of staircases, and these are summarized below. In every public or other building of more than 125,000 cub. ft. constructed to be used as a dwelling for separate families the floors of lobbies, corridors, passages, landings, and also the flights of stairs, shall be of fire-resisting materials. The principal staircase of every dwelling-house shall be ventilated by means of a window or skylight opening directly into the external air. In buildings occupied in separate tenements by more than two families the common staircase shall be ventilated upon each storey above the ground storey by windows or skylights, or otherwise adequately ventilated. Staircases in churches, chapels, public halls, lecture rooms, exhibition rooms and buildings for similar purposes are subject to the following conditions: Stairs shall be supported and enclosed by brick walls at least 9 in. thick. The treads of each flight shall be of uniform width, and stairs, corridors or passages shall be 4 ft. 6 in. wide unless the building is for the accommodation of less than two hundred persons, when it may be 3 ft. 6 in. wide. If for more than four hundred persons the width must increase by 6 in. for each additional hundred persons up to a maximum of 9 ft. Staircases 6 ft. wide and upwards shall be divided by a handrail. Two staircases may be substituted for one large one, each to be two-thirds the width required for the single stair, but not less than 3 ft. 6 in. Accommodation upon different levels must be provided with separate stairs leading directly to the street or open. Exit doors must open outwards. Under the theatre regulations dated 1892 the same widths hold good, but the minimum width is increased to 4 ft. 6 in. Every staircase for the use of the audience shall have solid square section steps of approved stone or concrete with treads of uniform width not less than 11 in. wide or rise greater than 6 in. Winders are prohibited, and the flights must have not more than twelve steps nor less than three steps each. Both ends of each step shall be pinned into the wall. The several flights shall be supported and enclosed on all sides by brick walls not less than 9 in. thick carried down to the level of the footings. Not more than two flights of twelve steps each shall be constructed without a turn. Landings to be 6 in. thick, square on plan and supported under the middle by 9 in. brick arches. A continuous handrail supported on strong metal brackets to be fixed on both sides of steps and land-

The second schedule of the London Building Act 1894 sets forth the materials that are deemed fire-resisting under the act, and specific in the case of staircases "oak or teak or other hard timber with treads and risers not less than 2 in. thick."

The law regulating the construction of buildings in the city of New York provides that "stairways serving for the exit of fifty people must, if straight, be at least 4 ft. wide between railings or between walls, and if curved or winding 5 ft. wide, and for every additional fifty people to be accommodated 6 in. must be added to their width. In no case shall the risers of any stairs exceed $7\frac{1}{2}$ in. in height, nor shall the treads exclusive of nosings be less than $10\frac{1}{2}$ in. wide in straight stairs. In circular or winding stairs the width of the tread at the narrowest end shall not be less than 7 in."

AUTHORITIES.—The principal works of reference on this subject are J. Riddell, *Carpenter, Joiner, Stair-builder and Handrailer*; W. H. Wood, *Stair Building and Handrailing*; J. H. Monckton, *Stair Building in its Various Forms*; J. Newland, *Carpenter and Joiner's Assistant*; G. L. Sutcliffe, *Modern Carpenter, Joiner and Cabinetmaker*; W. Mowat, *Handrailing and Stair Building*; W. R. Purchase, *Practical Masonry*; F. E. Kidder, *Building Construction and Superintendence*, pt. ii. (J. Bt.)

STALACTITES (Gr. *σταλακτός*, from *σταλάσσειν*, to drip), pendent masses formed where water containing mineral solutions drops very slowly from an elevation. They are seen, for example, beneath bridges, arches and old buildings as water percolating through the joints of the masonry has dissolved very small quantities of the lime present in the cement and mortar between the stones. On exposure to the air part of the water evaporates and the solution of carbonate of lime becomes supersaturated; a deposit of this substance ensues and as the drop continues to fall from the same spot a small column of white calcite very slowly grows downwards in a vertical direction from the roof of the arch. In a very similar manner stalactites of ice are produced in frosty weather as the water dropping from eaves of buildings, beams, branches of trees, &c., very gradually freezes. Other minerals than ice and calcite often occur in stalactitic growths. Thus we find in mines and in the cavities of mineral veins stalactites of limonite, fluorspar, opal, chalcedony and gibbsite. These stalactites are never of great size, usually not more than 2 or 3 in. in length, and probably the method of origin is exactly the same as that of the larger and more common stalactites of ice and of calcite.

The conditions essential to the perfect development of stalactites appear to be (1) a very slow trickle of water from a fissure; (2) regular evaporation; (3) absence of disturbance, such as currents of air. If the discharge of water is fast, irregular encrustations may be produced, or the precipitate of solid matter may be entirely washed away by the mechanical force of the currents. Changes of temperature will interfere with evaporation, sometimes accelerating and sometimes retarding it, and the stalactites tend under such circumstances to stop growth or to develop irregularities and excrescences. Currents of wind produce the same effect. For these reasons ice stalactites form most readily on calm cold nights, and stalactites of ice or calcite are seen in greatest perfection in the interior of caves,

where the sun's light does not penetrate, the temperature is steady, and there are no strong currents of air.

In all limestone caves stalactites form in great abundance as glimmering white columns covered with a thin film of water. The great caves, such as those of Adelsberg (in Styria), Jenolan (Australia), the Mammoth Cave (Kentucky), the Causses district in France, and the grottos of Belgium, are divided into chambers which are richly festooned with stalactites, and fanciful names are given to various groups according to their similarity to different objects, natural or artificial. Ice caves of considerable size occur in the Arctic and Antarctic regions, and are draped with ice stalactites often wonderfully like those of limestone caves.

Where the water drops upon the floor of one of these caves evaporation still goes on and an encrustation forms which may cover the whole surface as an irregular sheet. If the air be perfectly still, however, the drop which falls from a stalactite on the roof will always land on the same place and a pillar of deposit will rise vertically, till in course of time it meets and joins with the stalactite above. In this way a column is produced, which sometimes has a graceful form with a long straight shaft expanding somewhat at its upper and lower extremities. As the stalactites thicken by deposit of layer upon layer of carbonate of lime, they rarely continue to be cylindrical but assume tapering forms with irregular surfaces. They seldom branch, but sometimes they give off excrescences which may curve upwards or downwards and occasionally long thin stalactites take their rise from these and grow downwards parallel to the main stalactite. Large stalactites may be three or four feet thick, but in that case they have usually formed by the coalescence of adjacent ones which enlarged till they met and were then covered with a continuous layer of deposit. Single stalactites 2 ft. in diameter are not rare. It is known that they are of very slow growth, and much speculation has gone on regarding the length of time required for the formation of some of the largest stalactites. From data obtained by measurement of the rate of growth at the present day it has been estimated that as much as two hundred thousand years may have elapsed since certain thick stalactites began to grow. We know that many caves are of great antiquity from the fossil remains they contain, but these estimates are probably ill-founded, seeing that there is no certainty that the conditions have remained the same during the whole period of growth. Sir Archibald Geikie records that stalactites $1\frac{1}{2}$ in. in diameter had formed beneath a bridge in Edinburgh which was a hundred years old; in caves, however, the rate of formation is rarely so great as this. Inscriptions on stalactites in the Adelsberg cave after thirty years had been covered with a scarcely perceptible film of new deposit. In one of the Moravian caves a stalactite, about as thick as a goose quill, was broken across in 1880 and in 1891 it had grown three or four centimetres; from careful observations it has been calculated that one of these stalactites, 7 ft. long, may have been formed in 4000 years. The stalagmitic crust on the floor of caves is usually mixed with blocks which have fallen from the roof, sand, mud and gravel carried in by floods, and the bones of animals and men which have inhabited the cave if it had an accessible entrance. Its formation must have been interrupted by many changes in the physical conditions of the district, and consequently it often occurs in layers which alternate with beds of a different character.

Some particulars regarding the internal structure and growth of stalactites have been ascertained by Professor W. Rinz of Brussels. The first stage of every stalactite is a low circular ring of deposit on the roof of the cave. The diameter of this ring corresponds to the breadth of a drop of water which is so large that it is on the point of falling. At the outer surface of the drop evaporation goes on and supersaturation results in the deposit of a thin ring-shaped band. At the centre of the drop no deposition takes place, and as this goes on after some time a short tube is produced; the width of this tube is about 5 millimetres and is fairly constant. The tube very slowly lengthens as deposit gathers at its lower end: water is constantly dropping from it and its interior is always full. Very little material is deposited except at the orifice—hence in many caves long straight

tubular stalactites can be seen not much more than a quarter of an inch wide, and with delicate thin walls. A little water, however, makes its way from the interior to the outside of the tube and is exposed to evaporation there, consequently the tube walls gradually grow thicker. The end of a simple tubular stalactite of this type has small sharp teeth or points which are the corners of crystals. These have the rhombohedral faces of calcite, and are usually of a simple description: their corresponding faces are parallel, and an examination of the material of the tube proves that the whole mass has the same crystalline structure. We may, in fact, describe these stalactites as rounded, tubular crystals continuously growing but provided with crystalline facets only at their lower ends. Small lateral passages sometimes allow the water to escape from the interior of the tube and their apertures become surrounded with lime deposits. In this way horns, twigs and branches arise, often curving upwards or downwards; they are always provided with a central tubule which may be a mere capillary. The substance of these offshoots is in crystalline continuity with that of the main stalactite, and the whole mass has a uniform optical orientation. In the majority of cases the long axis of the stalactite corresponds to the optic axis of the calcite crystal, but in one group of stalactites these two make an angle of 15° with one another. An interruption in the supply of water or an accidental fracture of the stalactite induce abnormal growth. The end of the tube becomes obstructed or completely closed, and nodular or tuberculate growths are often the result. If the outer surface dries the next layer which is laid down may often be readily detached, as it is not firmly united with the underlying material. In any case a second stage of growth ultimately arrives, when the central tube is no longer the chief conduit but a general drip of water from the roof bathes the whole outer surface of the stalactite. Then small, flat crystals of calcite appear with their basal planes directed outwards. These increase in number till they cover the whole mass, and as they grow outwards they develop into prisms whose axes are directed radially. In very old spherulites the initial tube is covered with a great thickness of radiating calcite crystals deposited from the mineral solutions which trickle down along the external surface. When they are cut across they show concentric rings, some of which are due to stains of iron or manganese oxides or insoluble materials brought down by the water; others are lines of cavities produced by interrupted or irregular crystallization. They resemble the rings of the wood of trees, but probably do not depend on seasonal changes but on purely accidental factors, so that they afford no clue to the rate of growth.

Stalactites also occur in the interior of lava caves in the Sandwich Isles, Samoa, &c. Often the upper surface of a lava flow has cooled to form a crust, while the interior is still perfectly fluid, and it sometimes happens that the liquid basalt has made its escape, leaving great cavities below the hollow roof of the lava. The interior of these caves is covered with a black shining film of glassy basalt, and black stalactites of lava hang downwards. Their surface is sometimes changed to brown or red by the oxidizing action of the acid vapours which occupied the cave after the lava retired. These stalactites are tubular, with bluntly rounded ends, and probably their mode of growth is somewhat analogous to that of ice-stalactites. In microscopic section they prove to be glassy with small crystals of olivine and augite; in this they differ from the ice and calcite stalactites which are crystalline throughout.

STALL (O. Eng. *steall*, *stael*, cf. Du. *stal*, Ger. and Swed. *Stall*, a common Teutonic word for a place, station, place for standing in; the root is the Indo-European *sta-*, to stand, seen also in Latin *stabulum*, Greek *σταβλός*, and in stallion, an entire horse, properly one kept in a stall and not worked), a word which means literally a place where one may stand, and so is applied to a separate division in a stable, shed, &c., in which a single horse, cow or other domestic animal may be kept, to a separate booth, bench or table in a market or other building, or in the street, on which goods are exposed for sale by the person owning or licensed to use the same, and in England to the higher-priced seats on the ground floor of a theatre. The word is more particularly applied to a special form of seat in an ecclesiastical building. In cathedrals, monastic churches and the larger parish churches the stalls are fixed seats enclosed at the back and separated at the sides by high projecting arms, and placed in one or more rows on the north and south sides of the choir or chancel, running from the sanctuary to the screen or chancel arch. These separate enclosed seats are properly reserved for the clergy, and more usually the choir are seated in open benches in front of the stalls. In a cathedral the canons and prebendaries have each a stall assigned to them.

In the chapels of the various knightly orders the stalls are assigned to the members of the order, thus, in St. George's Chapel, Windsor, are the stalls of the Knights of the Garter, in Henry VII.'s Chapel in Westminster Abbey are those of the Knights of the Bath, adorned with the stall plates emblazoned with the arms of the knight occupying the stall, above which is suspended his banner.

Architecturally and artistically considered, the stalls of a cathedral or church are a marked feature of the interior adornment. They are richly carved, and are frequently surmounted by canopies of tabernacle work. The seats generally can be folded back so as to allow the occupant to stand upright or kneel; beneath the seat, especially in monastic churches, is fixed a small bracket, a *miserere* (*q.v.*), which affords a slight rest for the person while standing. Among beautiful specimens of carved stalls may be mentioned the Early Decorated stalls in Winchester Cathedral, the Early Perpendicular ones in Lincoln Minster, and the early 15th-century canopies in Norwich Cathedral. The stalls, especially the towering corner-stalls with their ornate carving filled with figures, in Amiens Cathedral are very fine; they date from 1508-1520.

STALLBAUM, JOHANN GOTTFRIED (1793-1861), German classical scholar, was born at Zaasch, near Delitzsch in Saxony, on the 25th of September 1793. From 1820 until his death on the 24th of January 1861 Stallbaum was connected with the Thomasschule at Leipzig, from 1835 as rector. In 1840 he was also appointed extraordinary professor in the university. His reputation rests upon his work on Plato, of which he published two complete editions: the one (1821-1825) a revised text with critical apparatus, the other (1827-1860) containing exhaustive prolegomena and commentary written in excellent Latin, a fundamental contribution to Platonic exegesis. A separate edition of the *Parmenides* (1839), with the commentary of Proclus, deserves mention. Stallbaum also edited the commentaries of Eustathius on the *Iliad* and *Odyssey*, and the *Grammaticae Latinae Institutiones* of Thomas Ruddiman.

See C. H. Lipsius in the *Osterprogramm of the Thomasschule* (1861); R. Hoche in *Allgemeine deutsche Biographie*, vol. xxxv.

STALYBRIDGE, a municipal and parliamentary borough of Cheshire, England; the parliamentary borough extending into Lancashire. Pop. (1901), 27,673. It lies on the river Tame, in a hilly district, 6 m. E. of Manchester, and is served by the London & North-Western, Great Central, and Lancashire & Yorkshire railways. Immediately to the west lie the towns of Dukinfield, and across the river in Lancashire, Ashton-under-Lyne; while 2 m. south of Stalybridge is the town of Hyde. The whole district is thus very densely populated. Stalybridge is one of the oldest seats of the cotton manufacture in this locality, the first cotton mill having been erected in 1776, and the first steam engine in 1795. There are also machine works, nail works, paper mills, and iron and brass foundries. The development of the town is modern, as it was created a market town in 1828, incorporated in 1857, and created a parliamentary borough, returning one member, in 1867. It is under a mayor, 7 aldermen and 22 councillors. Area, 3130 acres.

STAMBOLOV, STEFAN (1854-1895), Bulgarian statesman, was born on the 31st of January 1854 at Trnovo, the ancient Bulgarian capital, where his father kept a small inn. Under Turkish rule it was impossible to obtain a liberal education in Bulgaria, and young Stambolov, after attending the communal school in his native town, was apprenticed to a tailor. During the politico-religious agitation which preceded the establishment of the Bulgarian exarchate in 1870, a number of Bulgarian youths were sent to Russia to be educated at the expense of the Imperial government; among them was Stambolov, who was entered at the seminary of Odessa in order to prepare for the priesthood. His wayward and independent nature, however, rebelled against the discipline of school life; he was expelled from the seminary on the ground of his association with Nihilists, and, making his way to Rumania, he entered into close relations with the Bulgarian revolutionary committees at Bucharest, Giurgevo and Galatz. In 1875, though only twenty years of

age, he led an insurrectionary movement at Nova Zagora in Bulgaria, and in the following year organized another rising at Orekhovitz. In the autumn of 1876 he took part as a volunteer in the Servian campaign against Turkey, and subsequently joined the Bulgarian irregular contingent with the Russian army in the war of 1877-78. After the signature of the Berlin Treaty in 1878 Stambolov settled at Trnovo, where he set up as a lawyer, and was soon elected deputy for his native town in the Sobranye. His force of character, his undoubted patriotism, his brilliant eloquence, and his disinclination to accept office—a rare characteristic in a Bulgarian politician—combined to render him one of the most influential men in Bulgaria. The overthrow of the Zankoff ministry in 1884 was largely due to his influence, and in that year he was nominated to the presidency of the Sobranye. He held this important office for the next two years, a critical period in the national history. The revolution of Philippopolis, which brought about the union of Bulgaria with eastern Rumelia, took place on the 18th of September 1885, and it was largely owing to Stambolov's advice that Prince Alexander decided to identify himself with the movement. The war with Servia followed, and Stambolov, notwithstanding his official position, served as an ordinary soldier in the Bulgarian army. After the abduction of Prince Alexander by a band of military conspirators (Aug. 21, 1886) Stambolov, who was then at Trnovo, acted with characteristic promptitude and courage. In his capacity as president of the Sobranye he established a loyal government at Trnovo, issued a manifesto to the nation, nominated his brother-in-law, General Mutkurov, commander-in-chief of the army, and invited the prince to return to Bulgaria. The consequence of these measures was the downfall of the provisional government set up by the Russophil party at Sofia. On the abdication of Prince Alexander (Sept. 8) Stambolov became head of a council of regency, with Mutkurov and Karavelov as his colleagues; the latter, however, soon made way for Jivkov, a friend and fellow townsman of the first regent. Invested with supreme power at this perilous juncture, Stambolov displayed all the qualities of an able diplomatist and an energetic ruler. He succeeded in frustrating the mission of General Kaulbars, whom the Tsar despatched as special commissioner to Bulgaria; in suppressing a rising organized by Nabokov, a Russian officer, at Burgas; in quelling military revolts at Silistra and Rustchuk; in holding elections for the Grand Sobranye, despite the interdict of Russia, and in securing eventually the election of Prince Ferdinand of Coburg to the vacant throne (July 7, 1887). Under the newly-elected ruler he became prime minister and minister of the interior, and continued in office for nearly seven years (see BULGARIA). The aim of his foreign policy was to obtain the recognition of Prince Ferdinand, and to win the support of the Triple Alliance and Great Britain against Russian interference in Bulgaria. In his dealings with Turkey, the suzerain power, he displayed considerable acuteness; he gained the confidence of the Sultan, whom he flattered and occasionally menaced; and aided by the ambassadors of the friendly powers, he succeeded in obtaining on two occasions important concessions for the Bulgarian episcopate in Macedonia (see MACEDONIA), while securing the tacit sanction of the Porte for the technically illegal situation in the principality. With the assistance of Austria-Hungary and Great Britain he negotiated large foreign loans which enabled him to develop the military strength of Bulgaria. Under Prince Ferdinand he pursued the same despotic methods of government which had characterized his administration during the regency; Major Panitz, who had organized a revolutionary conspiracy, was tried by court-martial and shot at Sofia in 1890; four of his political opponents were hanged at Sofia in the following year, and Karavelov was sentenced to five years' imprisonment. His tyrannical disposition was increased by the assassination of his colleague, Beltchev, in 1891, and of Dr Vlkovitch, the Bulgarian representative at Constantinople, in 1892, and eventually proved intolerable to Prince Ferdinand, who compelled him to resign in May 1894. He was now exposed to the vengeance of his enemies, and subjected to various indignities and persecutions; he was refused

permission to leave the country, and his property was confiscated. On the 15th of July 1895 he was attacked and barbarously mutilated by a band of Macedonian assassins in the streets of Sofia, and succumbed to his injuries three days later. His funeral, which was attended by the representatives of the powers at Sofia, was interrupted by disgraceful riots, and an effort was made to perpetrate an outrage on his remains. No attempt was made to arrest his murderers; two persons were, however, arraigned for the crime in 1896, and subjected to almost nominal penalties.

(J. D. B.)

STAMFORD, HENRY GREY, 1ST EARL OF (c. 1599–1673), eldest son of Sir John Grey, succeeded his grandfather, Henry Grey as Baron Grey of Groby in July 1614. He married Anne, daughter of William Cecil, 2nd earl of Exeter, the heiress of the borough and manor of Stamford, and in March 1628 was created earl of Stamford. Just before the outbreak of the Civil War he ranged himself definitely among the king's opponents, and was made lord-lieutenant of Leicestershire. After some operations around Leicester he occupied Hereford, and, when compelled to abandon the city, marched into Cornwall. At Stratton, in May 1643, his troops were beaten by the Royalists; driven into Exeter, Stamford was forced to surrender this city after a siege of three months. The earl, who was certainly no general, was charged with cowardice, and took no further part in the military operations of the war, although once or twice he was employed on other business. The ravages of the Royalists had reduced him to poverty, and, distrusted by the House of Commons, he had great difficulty in getting any compensation from parliament. After a period of retirement Stamford declared for Charles II. during a rising in August 1659, and was arrested, but was soon released. He died on the 21st of August 1673. One of his sons was Anchtell Grey (d. 1702), the compiler of the *Debates of the House of Commons, 1667–1694* (10 vols. 1769). His eldest son, Thomas, Lord Grey of Groby (c. 1623–1657), was member of parliament for Leicester during the Long Parliament, and an active member of the parliamentary party. In January 1643 he was appointed commander-in-chief of the forces of the parliament in the midland counties and governor of Leicester. In 1648 he won some credit for his share in the pursuit and capture of the duke of Hamilton; he assisted Colonel Pride to "purge" the House of Commons later in the same year; and he was a member of the court which tried the king, whose death-warrant he signed. A member of the council of state under the Commonwealth, Grey fought against the Scots in 1651, and in February 1655 he was arrested on suspicion of conspiring against Cromwell. He was, however, soon released, but he predeceased his father in April or May 1657.

THOMAS (c. 1654–1720), only son of the last named, succeeded his grandfather as 2nd earl of Stamford. He took some part in resisting the arbitrary actions of Charles II., and was arrested in July 1685; then after his release he took up arms on behalf of William of Orange, after whose accession to the throne he was made a privy councillor and lord-lieutenant of Devonshire. In 1697 he became chancellor of the duchy of Lancaster, and in 1699 president of the board of trade, being dismissed from his office on the accession of Anne in 1702. From 1707 to 1711, however, he was again president of the board of trade. On his death without children on the 31st of January 1720 his titles passed to his cousin HENRY (d. 1739), a grandson of the first earl, from whom the later earls were descended.

STAMFORD, a city of Fairfield county, Connecticut, U.S.A., in a township of the same name, in the south-western part of the state, on Long Island Sound, 33½ m. (by rail) N.E. of New York City. Pop. of the city (1900), 15,997, of whom 4078 were foreign-born; (1910, census) 25,138; of the township, including the city (1900), 18,839; (1910), 28,836. The city is served by the New York, New Haven & Hartford railway (which has other stations in the township at Glenbrook, Springdale and Talmadge Hill), by electric railway to Darien, Greenwich, &c., and by two lines of steamboats to New York City and ports on the Sound. The city is pleasantly situated with the Rippowam river flowing through it, the Mianus river on the west and the

Noroton on the east. It is the place of residence of many New York business men. Among its institutions are the Ferguson Library (1882; with 16,000 volumes in 1909), several private schools, a Y.M.C.A., the Stamford Hospital (private, 1893), two private sanatoria, the Convent of our Lady of Lourdes, St John's Church House, a day nursery (1902), with dispensary and kindergarten, and the Stamford Children's Home (1895). The Stamford and the Corinthian Yacht Clubs have club-houses here. Shippan Point, on the Sound, 1½ m. south of the city, is a summer resort, near which the city bought land for a public park in 1906. Stamford's factory product in 1905 was valued at \$5,890,416, 50.3% more than in 1900. The principal manufactures are builders' hardware, locks and keys (the works of the Yale & Towne Manufacturing Company are here), woollen goods, dye stuffs, &c. The township of Stamford, known until 1642 by the Indian name of Rippowam, was settled in 1641 by twenty-nine persons who for religious reasons seceded from the Wethersfield church and joined the colony of New Haven. Discontent with the religious policy of New Haven, however, caused a number of the Stamford citizens to withdraw and to found Hempstead, Long Island, and for the same reason many of the people of Stamford approved of the union of the New Haven colony and Connecticut by the charter of 1662; and in October 1662 Stamford submitted to Connecticut. Stamford was chartered as a borough in 1830 and as a city in 1894.

See E. B. Huntingdon, *History of Stamford* (Stamford, 1868); and C. B. Gillespie, *Picturesque Stamford* (Stamford, 1893).

STAMFORD, a market town and municipal borough, chiefly in the South Kesteven or Stamford parliamentary division of Lincolnshire, but partly in Northamptonshire, on the river Welland, at the landward edge of the fen country. Pop. (1901), 8229. The town stands picturesquely on the steep banks of the river, and is of the highest antiquarian interest. It formerly possessed fourteen parish churches, but now has only six, viz. St Mary's, erected at the end of the 13th century, possessing an Early English tower, with Decorated spire, the principal other parts of the building being Perpendicular; All Saints', also of the 13th century, the steeple being built at the expense of John Browne, merchant of the staple at Calais, in the beginning of the 15th century; St Michael's, rebuilt in 1836 on the site of the one erected in 1269; St George's, Early English, Decorated, and Perpendicular, for the most part rebuilt in 1450 at the expense of William Bruges, first garter king-at-arms; St John Baptist's, Perpendicular, erected about 1452; and St Martin's, Perpendicular, in which Lord Treasurer Burghley is buried. Formerly there were several religious houses: the Benedictine monastery of St Leonard's, founded in the 7th century, of which there are some Norman and later remains; the Carmelite monastery (1291), of which the west gate still stands; and houses for Grey Friars (time of Henry III.), Dominicans (1240), Gilbertines (1291), and Augustinians (1316). The principal secular buildings are the town hall (rebuilt 1776), the corn exchange (1859), and the literary and scientific institute (1842), with a library of 6000 volumes. There are a large number of charitable institutions, including the Stamford and Rutland infirmary (1828), Browne's hospital, founded in the time of Richard III., with its picturesque Late Perpendicular building, Snowden's almshouses (1604), Truesdale's almshouses (1700), and Burghley hospital, founded by Lord Treasurer Burghley (1597). The modern grammar school building incorporates remains of the church of St Paul. To the south of Stamford, in Northamptonshire, is Burghley House, the seat of the marquis of Exeter, a fine quadrangular mansion dating from 1587, containing a noteworthy art collection. It stands in a well-wooded park. The prosperity of the town depends chiefly on its connexion with agriculture. It possesses iron foundries, agricultural implement works, wagon factories and breweries. There is also some trade in coal, timber, stone and slates. The town is governed by a mayor, 6 aldermen and 18 councillors. Area, 1918 acres.

Apart from the tradition preserved by Henry of Huntingdon that the Saxons here defeated the Picts and Scots in 449, Stamford (*Stamford*) is a place of great antiquity. The Danes built

a fort here on the north bank of the Welland, round which a town existed when in 922 King Edward fortified the opposite side of the stream. It passed again into Danish hands and was one of the five boroughs recaptured by Edmund Ætheling in 941. The priory of St Leonard was a cell of Durham, and a charter of Edgar dated 972 mentions a market and a mint. In the reign of Edward the Confessor Stamford was a royal borough governed by twelve lawmen, reduced in 1086 to nine, and divided into six wards. The Norman castle, built before 1086, was thrice besieged by Henry II. while Duke of Normandy, but only yielded in 1153. Two years later he granted it and the manor to Richard Humet; forfeited by his son it was given to John, earl of Warenne, in 1206. In 1337 it passed to William de Bohun, earl of Northampton, and thence to Edmund Langley, afterwards duke of York, finally reverting to the Crown on the death of Cicely, duchess of York. Elizabeth granted it to the first Lord Burghley. The barons met here in 1215 on their march to London, and in 1309 a parliament was held at Stamford. In 1256 Henry III. gave the burgesses freedom from tolls, the right of receiving tolls and immunity of their goods from arrest; privileges confirmed and enlarged in the following year. William, earl of Warenne, in 1275 permitted the burgesses to choose their chief officer or alderman, who was still sworn in at the manor court as late as 1615 and was first called "mayor" in 1663. Edward IV. incorporated Stamford by the name of the alderman and burgesses in 1461 and granted the town immunity from all external jurisdiction and gave it a common seal. The charters have been frequently confirmed. As early as 1292 Stamford was well known for its monastic schools, and in 1333 was chosen as the headquarters of the students who seceded from Oxford, and an Early Decorated gateway remains of Brasenose Hall. The attempt to establish a regular university was prohibited by royal authority. The defeat of the Yorkists here was followed by the decay of the castle in the reign of Richard III., and the history of the place henceforth centred chiefly round the family of Cecil, whose ancestor, David Seyceuld, settled here about 1566. Stamford occasionally returned two members to parliament from 1295 until 1832. The representation was reduced to one by the act of 1867, and was abolished in 1885. The fairs are of ancient origin, and are mentioned in 1245 and the reign of Edward I. These are the May fair, town fair, and spring fair, and fairs on various dates representing Candlemas, mid-Lent, the feasts of Corpus Christi, St James and SS. Simon and Jude. A market is still held every Friday. In 1182 there were dyers, weavers and fullers here, but these were only the usual home industries. In 1822 silk throwing was successfully carried on, but this has long ceased.

See E. C. Mackenzie-Walcott, *Memorials of Stamford, past and present* (Stamford, 1867); John Drakard, *The History of Stamford in the County of Lincoln, comprising its ancient progressive and modern state* (Stamford, 1822); Charles Nevinson, *History of Stamford* (Stamford, 1879); *Victoria County History: Lincoln*.

STAMMERING, or STUTTERING, a spasmodic affection of the organs of speech in which the articulation of words is suddenly checked and a pause ensues, often followed by a repetition in rapid sequence of the particular sound at which the stoppage occurred. Of this distressing affection there are many grades, from a slight inability to pronounce with ease certain letters or syllables, or a tendency to hesitate and to interject unmeaning sounds in a spoken sentence, to the more severe condition in which there is a paroxysm of spasms of the muscles, not only of the tongue and throat and face, but even of those of respiration and of the body generally. To understand in some degree the explanation of stammering it is necessary to consider shortly the physiological mechanism of articulate speech. Speech is the result of various muscular movements affecting the current of air as it passes in expiration from the larynx through the mouth. If the vocal cords are called into action, and the sounds thus produced are modified by the muscular movements of the tongue, cheek and lips, we have vocal speech; but if the glottis is widely open and the vocal cords relaxed the current of air may still be moulded by the muscular apparatus so as to produce speech without voice, or whispering (see VOICE). In both cases, how-

ever, the mechanism is very complicated, requiring a series of nervous and muscular actions, all of which must be executed with precision and in accordance. In vocal speech, for example, it is necessary that the respiratory movements, more especially those of expiration, occur regularly and with nice adjustment to the kind of articulate expression required; that the vocal cords be approximated and tightened by the muscles of the larynx acting with delicate precision, so as to produce the sound of the pitch desired; that the *rima glottidis* (or aperture of the larynx) be opened so as to produce prolonged sounds, or suddenly closed so as to cut off the current of air; that the movements of the muscles of the tongue, of the soft palate, of the jaws, of the cheeks and of the lips occur precisely at the right time and to the requisite extent; and finally that all of these muscular adjustments take place with rapidity and smoothness, gliding into each other without effort and without loss of time. Exquisite co-ordination of muscular movement is therefore necessary, involving also complicated nervous actions. Hence is it that speech is acquired by long and laborious effort. A child possesses voice from the beginning; it is born with the capacity for speech; but articulate expression is the result of education. In infancy, not only is knowledge acquired of external objects, and signs attached in the form of words to the ideas thus awakened, but the nervous and muscular mechanisms by which these signs or words receive vocal expression are trained by long practice to work harmoniously.

It is not surprising, therefore, that in certain cases, owing to some obscure congenital defect, the co-ordination is not effected with sufficient precision, and that stammering is the result. Even in severe cases no appreciable lesion can be detected either in the nervous or muscular mechanisms, and the condition is similar to what may affect all varieties of finely co-ordinated movements. The mechanism does not work smoothly, but the pathologist is unable to show any organic defect. Thus the co-ordinated movements necessary in writing are disturbed in scrivener's palsy, and the skilful performer on the piano or on any instrument requiring minute manipulation may find that he is losing the power of delicate adjustment. Stammering is occasionally hereditary. It rarely shows itself before the age of four or five years, and as a rule it is developed between this age and puberty. Men stammer in a much larger proportion than women. It may occur during the course of nervous affections, such as hysteria, epilepsy or locomotor ataxia; sometimes it follows febrile disorders; often it develops in a child in a feeble state of health, without any special disease. In some cases a child may imitate a stammerer and thus acquire the habit. Any general enfeeblement of the health, and especially nervous excitement, aggravates the condition of a confirmed stammerer.

Stammerers, as a rule, find the explosive consonants *b*, *p*, *d*, *t*, *k* and hard *g* the most difficult to articulate, but many also are unable easily to deal with the more continuous consonants, such as *v*, *f*, *th*, *s*, *z*, *sh*, *m*, *n*, *y*, and in severe cases even the vowels may cause a certain amount of spasm. Usually the defect is not observed in whispering or singing; but there are exceptions to this statement. In pronouncing the explosive sounds the part of the oral apparatus that ought suddenly to open or close remains spasmodically closed, and the stammerer remains for a moment voiceless or strives pitifully to overcome the obstruction, uttering a few successive puffs or sounds like the beginning of the sound he wishes to utter. The lips thus remain closed at the attempted utterance of *b* and *p*; the tip of the tongue is pressed against the hard palate or the back of the upper front teeth in *d* and *t*; and the back of the tongue presses against the posterior part of the palate in pronouncing *g* hard and *k*. In attempting the continuous consonants, in which naturally the passage is not completely obstructed, the stammerer does not close the passage spasmodically, but the parts become fixed in the half-opened condition, or there are intermittent attempts to open or close them, causing either a drawling sound or coming to a full stop. In severe cases, where even vowels cannot be freely uttered, the spasm appears to be at the *rima glottidis*

(opening of the larynx). Again, in some cases, the spasm may affect the respiratory muscles, giving rise to a curious barking articulation, in consequence of spasm of the expiratory muscles, and in such cases the patient utters the first part of the sentence slowly, gradually accelerates the speed, and makes a rush towards the close. In the great majority of cases the spasm affects the muscles of articulation proper, that is, those of the pharynx, tongue, cheeks and lips.

A condition named *aphthongia* is particularly distressing. It totally prevents speech, and may, at intervals, come on when the person attempts to speak; but fortunately it is only of temporary duration, and is usually caused by exceptional nervous excitement. It is characterized by spasm of the muscles supplied by the hypoglossal nerve, including the sterno-hyoid, sterno-thyroid and thyro-hyoid muscles. In almost all cases of stuttering it is noticed that the defect is most apparent when the person is obliged to make a sudden transition from one class of sounds to another, and the patient soon discovers this for himself and chooses his words so as to avoid dangerous muscular combinations. When one considers the delicate nature of the adjustments necessary in articulate speech, this is what may be expected. It is well known that a quickly diffusible stimulant, such as alcohol, temporarily removes the difficulty in speech.

Stuttering may be successfully overcome in some cases by a careful process of education under a competent tutor. Not a few able public speakers were at first stutterers, but a prolonged course of vocal gymnastics has remedied the defect. The patient should be encouraged to read and speak slowly and deliberately, carefully pronouncing each syllable, and when he feels the tendency to stammer, he should be advised to pause for a short time, and then by a strong voluntary effort to attempt to pronounce the word. He should also be taught how to regulate respiration during speech, so that he may not fail from want of breath. In some cases aid may be obtained by raising the voice towards the close of the sentence. Sounds or combinations of sounds that present special difficulties should be made the subject of careful study; and the defect may be largely overcome by a series of graduated exercises in reading. The practice of intoning is useful in many cases; and many persons who habitually stutter in conversation show no sign of the defect when they come to sing. In ordinary conversation it is often important to have some one present who may by a look put the stammerer on his guard when he is observed to be talking too quickly or indistinctly. Thus by patience and determination many stammerers have so far overcome the defect that it can scarcely be noticed in conversation; but even in such cases mental excitement or slovenly inattention to the rules of speech suitable for the condition may cause a relapse. In very severe cases, where the spasmodic seizures affect other muscles than those of articulation, special medical treatment is necessary, as such are on the borderland of serious nervous disturbance. All measures tending to improve the general health, the removal of any affection of the mouth or gums that may aggravate habitual stammering, the avoidance of great emotional excitement, a steady determination to overcome the defect by voluntary control, and a system of education such as has been sketched will do much in the great majority of cases to remedy stammering.

STAMP (from "to stamp," to strike or tread heavily, hence to impress, O. Eng. *stempen*, Du. *stampen*, Ger. *stampfen*, whence, O. Fr. *estamper*, mod. *étamper*), an instrument for crushing or pounding or for making impressions or marks on other bodies; thus, in mining, the stamp is that part of the machinery of a mill which crushes the ore to the fineness necessary for the separation of the valuable portions; in coining, &c., it is an engraved block or die by which the mark is impressed, hence in the most general sense of the word an impression or mark made with a "stamp," and particularly such a mark impressed on a document for purposes of certification, validity and the like, or as showing that certain duties or charges have been paid. For the first class, viz., stamps for purposes of taxation, see *Stamp*

Duties below; For the second class, of which the most familiar are the small adhesive pieces of paper used as the sign that postal charges have been duly paid on letters, parcels, &c., transmitted by the postal service of a country, see **POST AND POSTAL SERVICE** and **PHILATELY**.

Stamp Duties.—The stamp duty is a tax imposed upon a great variety of legal and other documents, and forms a branch of the national revenue. The stamp is a cheap and convenient mode of certifying that the revenue regulations have been complied with. Stamp duties appear to have been invented by the Dutch in 1624. They were first imposed in England by an act of 1694 as a temporary means of raising funds for carrying on the war with France. Stamp duties in the United Kingdom form part of the inland revenue, and are placed under the control of the commissioner of inland revenue. The principal acts in force on the subject are the Stamp Act 1891 and the Stamp Duties Management Act 1891. Amendments of the law are also included in the Customs and Inland Revenue Act 1893, the Finance Acts of subsequent years, and the Revenue Act 1898. The death duties, the corporation duty, the duties on patent medicines and playing cards, and postage duties, are also technically "stamp duties"; but in ordinary use the expression is limited to those imposed on the various classes of legal instruments, such as conveyances, leases, transfers, mortgages, bonds, &c., on bills of exchange, promissory notes, contract notes, bank notes and bankers' drafts, receipts, insurance policies, bills of lading, and a few other documents. Stamps are either adhesive or impressed. The adhesive stamps, which can only be used for certain documents, can be obtained at inland revenue offices throughout the United Kingdom, and at all post offices which are money order offices. Stamps can only be impressed at the inland revenue offices in certain of the larger towns. For duties not exceeding 2s. 6d. the adhesive inland revenue or postage stamps may (in most cases) be used indiscriminately. This arrangement was first introduced in 1881, when it was applied to the penny stamp, and it has since been extended to other denominations. The commissioners of inland revenue are authorized to make allowance under certain conditions for stamps which have been inadvertently spoiled or rendered useless for their intended purposes. In order to obtain such allowance the parties must present the stamps within two years from the time when they became useless. The commissioners may be required by any person to express their opinion as to the amount of duty, if any, which is chargeable on any instrument; and such person, if dissatisfied with the assessment made, may appeal to the courts.

The stamp duty on the transfer of certain kinds of securities can be commuted by the payment of a lump sum or (in some cases) an annual composition, and the transfers then become exempt from duty.

Stamp duties are either fixed, such as the duty of one penny on every cheque irrespective of its amount, or *ad valorem*, as the duty on a conveyance, which varies according to the amount of the purchase money. The duty is denoted generally by an impressed, less frequently by an adhesive, stamp, sometimes by either at the option of the person stamping. Thus an inland bill of exchange (unless payable on demand) must have an impressed stamp, a foreign bill of exchange an adhesive stamp, while an agreement or receipt stamp may be of either kind. It should be noticed that certain documents falling within a class which as a rule is subject to stamp duty are for reasons of public policy or encouragement of trade exempted from the duty by special legislation. Examples of such documents are Bank of England notes, agreements within § 17 (but not those within § 4) of the Statute of Frauds (see **FRAUD**), agreements between a master of a ship and his crew, transfers of ships or shares in ships, indentures of apprenticeship for the sea service, petitions forwarded by post to the Crown or a House of Parliament and most instruments relating to the business of building and friendly societies.

As a general rule a document must be stamped at the time of execution, or a penalty (remissible by the commissioners of inland revenue) is incurred. The penalty is in most cases £10, sometimes much more; in the case of policies of marine insurance it is £100. Some instruments cannot be stamped at all after execution, even with payment of the penalty. Such are bills of exchange and promissory notes (where an impressed stamp is necessary), bills of lading,

proxies for voting at meetings of proprietors of joint-stock companies and receipts after a month from date. An unstamped instrument cannot be pleaded or given in evidence except in criminal proceedings or for a collateral purpose. If an instrument chargeable with duty be produced as evidence in a court, the officer whose duty it is to read the instrument is to call the attention of the judge to any omission or insufficiency of the stamp, and if the instrument is one which may legally be stamped after execution, it may, on payment of the amount of the unpaid duty and the penalty payable by law, and a further sum of £1, be received in evidence, saving all just exceptions on other grounds. The rules of the supreme court, 1883 (Ord. xxxix. r. 8, re-enacting a provision of the Common Law Procedure Act), provide that a new trial is not to be granted by reason of the ruling of a judge that the stamp upon any document is sufficient or that the document does not require a stamp. The stamp upon a document subject to the stamp laws of a foreign state is usually admissible in evidence in a court of the United Kingdom if it conform in other respects to the rules governing the admissibility of such documents, even though it be improperly stamped according to the law of the foreign country. The admissibility of documents belongs to the *ordinatoria litis* rather than the *decisoria litis*, and is governed by the *lex fori* rather than the *lex loci contractus*, unless indeed that law makes a stamp necessary to the validity of the instrument. Certain offences, such as forging a die or stamp, selling or using a forged stamp, &c., are made felonies punishable with penal servitude for life as a maximum.

United States.—The subject of stamp duties is of unusual historical interest, as the passing of Grenville's Stamp Act of 1765 (see UNITED STATES: *History*) directly led to the American War of Independence. The act was, indeed, repealed the next year as a matter of expediency, but an act of the same year dealing with the dependency of American colonies declared the right of the British legislature to bind the colonies by its acts. The actual yield of the stamp duties under the act of 1765 was, owing to the opposition in the American colonies, only £4000—less than the expenses of putting the act into force. The stamp duties of the United States are now under the superintendence of the commissioner of internal revenue.

STANCHION (Fr. *élançon*, a wooden post), an architectural term applied to the upright iron bars in windows which pass through the eyes of the saddle bars or horizontal irons to steady the lead lights. The French call the latter *traverses*, the stanchions *montants*, and the whole arrangement *armature*. Stanchions frequently finish with ornamental heads forged out of the iron.

STANDARD, a term with three main meanings: (1) an ensign or flag; (2) a fixed weight, measure, value or quality established by law or customarily recognized as a unit of comparison by which the correctness of others can be determined; (3) an upright or standing object, such as a large candelabrum, or, particularly, a fruit-tree which stands without support. With regard to the derivation, the word which appears in most European languages, e.g. Du. *standaard*, Ger. *Standarte*, O. Fr. *estandard*, *estendard*, mod. *étendard*, Ital. *stendale*, *stendardo*, &c., is to be referred to the Teut. *standan*, to stand, and refers to the fixed pole to which an object or a pole was attached. The "standard" as a military ensign was properly stationary and served as the signal of the position of its owner on the ordered field of battle. The O. Fr. form *estendard* points to the influence of Lat. *extendere*, to spread out, extend, of the flag when hung upon the pole (see further FLAG for the various meanings of the word and its history). The use of the term for a recognized unit of comparison is due probably to the fact that it is something fixed or set up, stable, and not to any fanciful reference to the ensign or flag as the object to which one turns as a rallying-point. For the standard weights and measures see WEIGHTS AND MEASURES and STANDARDS DEPARTMENT below. There are many other standards, such as electrical standards (see ELECTRICITY), standard solutions in chemistry (*q.v.*) for the purpose of volumetric analysis, &c. In engineering, the component parts of machines or other structures are "standardized" in accordance with agreed measurements. For "standard time" see TIME, STANDARD.

STANDARD, BATTLE OF THE, a name given to the battle of the 22nd of August 1138 near Northallerton, in which the Scottish army under King David was defeated by the English levies of Yorkshire and the north Midlands, who arrayed themselves round a chariot carrying the consecrated banners of St Peter of York, St John of Beverley, St Wilfrid of Ripon and St Cuthbert of Durham.

See C. Oman, *Art of War: Middle Ages*, pp. 389 sqq.

STANDARDS DEPARTMENT, a department of the English Board of Trade, having the custody of the imperial standards of weights and measures. As far back as can be traced, the standard weights and measures, the primary instruments for determining the justness of all other weights and measures used in the United Kingdom, were kept at the exchequer, and the duties relating to these standards were imposed upon the chamberlains of the exchequer. The office of chamberlains was abolished in 1826, under the operation of 23 Geo. III. c. 82, passed in 1783, but the custody of the standards and any duties connected therewith remained attached to an officer in the exchequer (*q.v.*) until that department was abolished in 1866. Meanwhile, in pursuance of recommendations of Standard Commissions of 1841 and 1854 and a House of Commons Committee of 1862, the Standards of Weights, Measures and Coinage Act 1866 was passed. This act created a special department of the Board of Trade, called the "Standard Weights and Measures Department," and a head of that department styled the "Warden of the Standards." His duty was to conduct comparisons, verifications and operations with reference to the standards in aid of scientific research and otherwise. The first—indeed, the only real holder—of the office was Henry Williams Chisholm (1809–1901), previously chief clerk of the old exchequer, under whose direction the department was organized; and before his retirement in 1877 it embraced not merely the re-verification of the imperial standards, but the making of local standards for local authorities, the re-verification of standards and instruments for all parts of the United Kingdom and colonies, for foreign countries which did not possess standardizing departments, the verification of manufacturers' standards and instruments, gas-measuring standards, apparatus for determining the flash-point of petroleum, &c. The Weights and Measures Act of 1878 left out all reference to the title and office of warden of the standards, and this opportunity was taken, in the words of the then permanent secretary of the Board of Trade, T. H. (afterwards Lord) Farrer, to make the office "more strictly a department of the Board of Trade." It was put in charge of an officer (Mr H. J. Chaney) termed "Superintendent of Weights and Measures," but on his death in 1906 an attempt was made partially to restore dignity and importance to the office by the appointment of Major P. A. MacMahon, F.R.S., with the title of "Deputy Warden of the Standards."¹

There are Standards departments under the charge of experienced scientists in Berlin, St Petersburg, Paris, Vienna, Rome, Madrid, Lisbon, Brussels, Bucharest and Constantinople and at Ottawa, Melbourne and Sidney. The United States Bureau of Standards is in the department of Commerce and Labor. It was established in 1901 and is under the charge of a director. Its work follows that of the English department and embraces also research in the domain of physics, extending from chemistry on the one side to engineering on the other. It also tests and investigates standards and methods of constructing measuring-instruments for scientific societies, educational institutions, manufacturers and others.

STANDERTON, a town of the Transvaal, 114 m. S.E. of Johannesburg, on the railway from that city, via Newcastle to Durban, distant 369 m. Pop. (1904), 4589, of whom 2136 were white. Standerton is 5025 ft. above the sea and is built on the north bank of the Vaal, here spanned by two fine bridges. It is the chief town of a district of the same name and the centre of an important agricultural and pastoral region. A government stud farm is maintained here. In the neighbourhood are coal-fields. The name of the town is derived from that of the former owner of the site, an Adrian Stander, who fought against the British at Boomplaats in 1848. The town was laid out in 1870. Since 1903 it has been governed by a municipality.

STANDISH, MILES, or **MYLES** (c. 1584–1656), American colonist, was born about 1584 in Lancashire, probably of the ¹The act of 1878, which repealed the act of 1866, merely declared that the Board of Trade should have all powers and perform all duties relative to the standards vested in or imposed upon the warden of the standards by the act of 1866 or otherwise, and the title "deputy warden of the standards" is therefore a departmental creation.

Duxbury Hall branch of the family. Nothing definite is known of him before 1620, when with his wife, Rose (d. 1621), he emigrated to New England in the "Mayflower." He became the military leader of the Plymouth colony; was sent to London in 1625 on an unsuccessful mission to secure the intervention of the Council for New England in the affairs of the colony; and in 1628 was one of the eight members of the colony who pledged themselves to pay £1800 and thus buy out the merchant adventurers. In 1631 with William Brewster and others he settled at Duxbury, where he died on the 3rd of October 1656, and where on "Captain's Hill," near the site of his home, there is a monument to him, consisting of a stone shaft, 110 ft. high, and a bronze statue of him. Longfellow's *Courtship of Miles Standish* apparently has no basis in fact; Standish's second wife, Barbara, a sister of Rose, must have been summoned to Plymouth a year before the marriage of John Alden to Priscilla Mullins. Lowell's *Interview with Miles Standish* misrepresents him: he was not a typical Puritan.

See William Bradford's *History of Plimouth Plantation*. Tudor Jenks's *Captain Myles Standish* (New York, 1905) and Henry Johnson's *Exploits of Myles Standish* (New York, 1897) are popular sketches.

STANFIELD, WILLIAM CLARKSON (1794-1867), English marine painter, was born of Irish parentage at Sunderland in 1794. As a youth he was a sailor, and during many long voyages he acquired that intimate acquaintance with the sea and shipping which was admirably displayed in his subsequent works. In his spare time he diligently occupied himself in sketching marine subjects, and so much skill did he acquire that, after having been incapacitated by an accident from active service, he received an engagement, about 1818, to paint scenery for the "Old Royalty," a sailor's theatre in Wellclose Square, London. Along with David Roberts he was afterwards employed at the Cobourg theatre, Lambeth; and in 1826 he became scene-painter to Drury Lane theatre, where he executed some admirable work, especially distinguishing himself by the production of a drop-scene, and by decorations for the Christmas pieces for which the house was celebrated. Meanwhile he had been at work upon some easel pictures of small dimensions, and was elected a member of the Society of British Artists. Encouraged by his success at the British Institution, where in 1827 he exhibited his first important picture—"Wreckers off Fort Rouge"—and in 1828 gained a premium of 50 guineas, he before 1830 abandoned scene-painting, and in that year made an extended tour on the Continent. He now produced his "Mount St Michael," which ranks as one of his finest works; in 1832 he exhibited his "Opening of New London Bridge" and "Portsmouth Harbour"—commissions from William IV.—in the Royal Academy, of which he was elected an associate in 1832 and an academician in 1835; and until his death on the 18th of May 1867 he contributed to its exhibitions a long series of powerful and highly popular works, dealing mainly with marine subjects, but occasionally with scenes of a more purely landscape character. Among these may be named: the "Battle of Trafalgar" (1836), executed for the United Service Club; the "Castle of Ischia" (1841), "Isola Bella" (1841), among the results of a visit to Italy in 1839; "French troops Forging the Margra" (1847), "The 'Victory' Bearing the Body of Nelson Towed into Gibraltar" (1853), "The Abandoned" (1856). He also executed two notable series of Venetian subjects, one for the banqueting-hall at Bowood, the other for Trentham. He was much employed on the illustrations for *The Picturesque Annual*, and published a collection of lithographic views on the Rhine, Moselle and Meuse; and forty of his works were engraved in line under the title of "Stanfield's Coast Scenery." The whole course of Stanfield's art was powerfully influenced by his early practice as a scene-painter. But, though there is always a touch of the spectacular and the scenic in his works, and though their colour is apt to be rather dry and hard, they are large and effective in handling, powerful in their treatment of broad atmospheric effects and telling in composition, and they evince the most complete knowledge of the artistic materials with which their painter deals.

STANFORD, SIR CHARLES VILLIERS (1852-), Irish musical composer, was born in Dublin on the 30th of September 1852, being the only son of Mr John Stanford, examiner in the court of chancery (Dublin) and clerk of the Crown, Co. Meath. Both parents of the composer were accomplished amateur musicians, the father being the possessor of a splendid bass voice, and the mother a very clever pianist. Under R. M. Levey (violin), Miss Meeke, Mrs Joseph Robinson, Miss Flynn and Michael Quarry (piano), young Stanford's musical powers were trained in the early days; and Sir Robert Stewart taught him composition and organ. Various feats of precocity are recorded in an article in the *Musical Times* for December 1898. He came to London as a pupil of Arthur O'Leary and Ernst Pauer in 1862, and in 1870 won a scholarship at Queen's College, Cambridge, whence he migrated to Trinity College in 1873, and succeeded J. L. Hopkins as college organist, a post he held till 1892. His appointment as conductor of the Cambridge University Musical Society gave him great opportunities, and the fame which the society soon obtained was in the main due to Stanford's energies. Before his time ladies were not admitted into the chorus, but during his tenure of the office of conductor many most interesting performances and revivals took place. In the years 1874 to 1877 he was given leave of absence for a portion of each year in order to complete his studies in Germany, where he learnt from Reinecke and Kiel. He took the B.A. degree in 1874 and M.A. in 1878, and was given the honorary degree of Mus. D., at Oxford in 1883, and at Cambridge in 1888. He first came prominently before the public as a composer with his incidental music to Tennyson's *Queen Mary* (Lyceum, 1876); and in 1881 his first opera, *The Veiled Prophet*, was given at Hanover (revived at Covent Garden, 1893); this was succeeded by *Savonarola* (Hamburg, April, and Covent Garden, July 1884), and *The Canterbury Pilgrims* (Drury Lane, 1884). A long interval separates these from his later operas, *Shamus O'Brien*, a delightful piece of Irish dramatic writing (Opera Comique, 1896) and *Much Ado About Nothing* (Covent Garden, 1901). For the main provincial festivals, works by Stanford were commissioned as follows: "Orchestral serenade" (Birmingham, 1882); "Elegiac Ode" (Norwich, 1884); *The Three Holy Children* (Birmingham, 1885); *The Revenge* (Leeds, 1886); *The Voyage of Maeldune* (Leeds, 1889); *The Battle of the Baltic* (Hereford, 1891); *Eden* (Birmingham, 1891); *The Bard* (Cardiff, 1895); *Phaudrig Crohoore* (Norwich, 1896); *Requiem* (Birmingham, 1897); *Te Deum* (Leeds, 1898); *The Last Post* (Hereford, 1900); *Stabat Mater* (Leeds, 1907). Besides these, his music includes a few choral works of importance, such as *The Resurrection* (Cambridge, 1875); *Psalm XLVI*. (Cambridge, 1877); *Carmen Saeculare* (Jubilee Ode, 1887); "Installation Ode" (Cambridge, 1892); *East to West* (London, 1893); *Psalm CL*. (Manchester, 1887); *Mass in G* (Brompton Oratory, 1893). He was appointed professor of composition at the Royal College of Music, 1883; conductor of the Bach choir in 1885; professor of music in the university of Cambridge, succeeding Sir G. A. Macfarren, 1887; conductor of the Leeds Philharmonic Society, 1897, and of the Leeds Festival from 1901 onwards. He was knighted in 1902. His instrumental works include six symphonies, many chamber compositions, among them two string quartets; besides many songs, part-songs, madrigals, &c., and incidental music to the *Eumenides* and *Oedipus Rex* (as performed at Cambridge), as well as Tennyson's *Becket*. His church music holds an honoured place among modern Anglican compositions; and his editions of Irish and other traditional songs are well known. In 1908 he published an interesting volume of *Studies and Memories*, a collection of contributions to reviews, &c., in past years.

STANHOPE, EARLS. JAMES STANHOPE, 1ST EARL STANHOPE (c. 1673-1721), English statesman and soldier, was the eldest son of Alexander Stanhope (d. 1707), a son of Philip Stanhope, 1st earl of Chesterfield. Educated at Eton and at Trinity College, Oxford, he accompanied his father, then British minister at Madrid, to Spain in 1690, and obtained some knowledge of that country which was very useful to him in later life. A little later, however, he went to Italy where, as afterwards in Flanders,

he served as a volunteer against France, and in 1695 he secured a commission in the British army. In 1701 Stanhope entered the House of Commons, but he continued his career as a soldier and was in Spain and Portugal during the earlier stages of the War of the Spanish Succession. In 1705 he served in Spain under Charles Mordaunt, earl of Peterborough, and in 1706 he was appointed British minister in Spain, but his duties were still military as well as diplomatic, and in 1708, after some differences with Peterborough, who favoured defensive measures only, he was made commander-in-chief of the British forces in that country. Taking the offensive he captured Port Mahon, Minorca, and after a visit to England, where he took part in the impeachment of Sacheverell, he returned to Spain and in 1710 helped to win the battles of Almenara and of Saragossa, his perseverance enabling the archduke Charles to enter Madrid in September. However, at Brihuega he was overwhelmed by the French and was forced to capitulate on the 9th of December 1710. He remained a prisoner in Spain for over a year and returned to England in August 1712. He now definitely abandoned the army for politics, and became one of the leaders of the Whig opposition in the House of Commons. He had his share in establishing the house of Hanover on the throne, and in September 1714 he was appointed secretary of state for the southern department, sharing with Walpole the leadership of the House of Commons. He was mainly responsible for the measures which were instrumental in crushing the Jacobite rebellion of 1715, and he forwarded the passing of the Septennial Act. He acted as George I.'s foreign minister, and only just failed to conclude a treaty of alliance with France in 1716. In 1717, consequent on changes in the ministry, Stanhope was made first lord of the treasury, but a year later he returned to his former office of secretary for the southern department. In 1717 he was created Viscount Stanhope of Mahon and in 1718 Earl Stanhope. His activity was now shown in the conclusion of the quadruple alliance between England, France, Austria and Holland in 1718, and in obtaining peace for Sweden, when threatened by Russia and Denmark, while at home he promoted the bill to limit the membership of the House of Lords. Just after the collapse of the South Sea Scheme, for which he was partly responsible but from which he did not profit, the earl died in London on the 5th of February 1721. Stanhope married Lucy, daughter of Thomas Pitt, governor of Madras, and he was succeeded by his eldest son Philip (1717-1786), a distinguished mathematician and a fellow of the Royal Society.

CHARLES STANHOPE, 3RD EARL STANHOPE (1753-1816), statesman and man of science, son of the 2nd earl, was born on the 3rd of August, 1753, and educated under the opposing influences of Eton and Geneva, devoting himself whilst resident in the Swiss city to the study of mathematics, and acquiring from the associations connected with Switzerland an intense love of liberty. In politics he took the democratic side. As Lord Mahon he contested the city of Westminster without success in 1774, when only just of age; but from the general election of 1780 until his accession to the peerage on the 7th of March 1786 he represented through the influence of Lord Shelburne the Buckinghamshire borough of High Wycombe, and during the sessions of 1783 and 1784 he gave his support to the administration of William Pitt, whose sister, Lady Hester Pitt, he married on the 19th of December 1774. When Pitt ceased to be inspired by the Liberal principles of his early days, his brother-in-law severed their political connexion and opposed with all the impetuosity of his fiery heart the arbitrary measures which the ministry favoured. Lord Stanhope's character was without any taint of meanness, and his conduct was marked by a lofty consistency never influenced by any petty motives; but his speeches, able as they were, had no weight on the minds of his compeers in the upper chamber, and, from a disregard of their prejudices, too often drove them into the opposite lobby. He was the chairman of the "Revolution Society," founded in honour of the Revolution of 1688, the members of which in 1790 expressed their sympathy with the aims of the French republicans. He brought forward in 1794 the case of Muir, one

of the Edinburgh politicians who were transported to Botany Bay; and in 1795 he introduced into the Lords a motion deprecating any interference with the internal affairs of France. In all these points he was hopelessly beaten, and in the last of them he was in a "minority of one"—a sobriquet which stuck to him throughout life—whereupon he seceded from parliamentary life for five years. He was elected a fellow of the Royal Society so early as November 1772, and devoted a large part of his income to experiments in science and philosophy. He invented a method of securing buildings from fire (which, however, proved impracticable), the printing press and the lens which bear his name and a monochord for tuning musical instruments, suggested improvements in canal locks, made experiments in steam navigation in 1795-1797 and contrived two calculating machines. When he acquired an extensive property in Devonshire, he projected a canal through that county from the Bristol to the English Channel and took the levels himself. Electricity was another of the subjects which he studied, and the volume of *Principles of Electricity* which he issued in 1779 contained the rudiments of his theory on the "return stroke" resulting from the contact with the earth of the electric current of lightning, which were afterwards amplified in a contribution to the *Philosophical Transactions* for 1787. His principal labours in literature consisted of a reply to Burke's *Reflections on the French Revolution* (1790) and an *Essay on the rights of juries* (1792), and he long meditated the compilation of a digest of the statutes. The lean and awkward figure of Lord Stanhope figured in a host of the caricatures of Sayers and Gillray, reflecting on his political opinions and his personal relations with his children. His first wife died in 1780, and he married in 1781 Louisa, daughter and sole heiress of the Hon. Henry Grenville (governor of Barbadoes in 1746 and ambassador to the Porte in 1762), a younger brother of the 1st Earl Temple and George Grenville; who survived him and died in March 1829. By his first wife he had three daughters, one of whom was Lady Hester Stanhope (q.v.). His youngest daughter, Lady Lucy Rachael Stanhope, eloped with Thomas Taylor of Sevenoaks, the family apothecary, and her father refused to be reconciled to her; but Pitt made Taylor controller-general of the customs, and his son was one of Lord Chatham's executors. His second wife was the mother of three sons. Lord Stanhope died at the family seat of Chevening, Kent, on the 15th of December 1816, being succeeded as 4th earl by his son Philip Henry (1781-1855), who inherited many of his scientific tastes, but is best known, perhaps for his association with Kaspar Hauser (q.v.).

PHILIP HENRY STANHOPE, 5TH EARL STANHOPE (1805-1875) English historian, better known as Lord Mahon, son of the 4th earl and his wife, the daughter of the 1st Baron Carrington, was born on the 30th of January 1805. He took his degree at Christ Church, Oxford, in 1827, and entered parliament in 1830. He was under secretary for foreign affairs for the early months of 1835, and secretary to the India Board in 1845, but though he remained in the House of Commons till 1852, he made no special mark in politics. He was chiefly interested in literature and antiquities, and in 1842 took a prominent part in passing the Copyright Act. He was a trustee of the British Museum, and in 1856 he proposed the foundation of a National Portrait Gallery; its subsequent creation was due to his executors. It was mainly due to him that in 1869 the Historical Manuscripts Commission was started. As president of the Society of Antiquaries (from 1846 onwards), it was he who called attention in England to the need of supporting the excavations at Troy. And in 1855 he founded the Stanhope essay prize at Oxford. Of his own works the most important are his *Life of Belisarius* (1829); *History of the War of Succession in Spain* (1832), largely based on the first earl's papers; *History of England from the Peace of Utrecht to the Peace of Versailles* (1836-1853); *Life of William Pitt* (1861-1862); and *History of England, comprising the reign of Queen Anne until the Peace of Utrecht* (1870). A new edition of this last work was published in 1908. The two histories and the *Life of Pitt* are of great importance on account of Stanhope's unique access to manuscript authorities, and they remain

standard works; and though here and there he has been found to give credit for too much to Lord Chatham, his industry, clear though not brilliant style, and general impartiality in criticism, have been deservedly praised. His position as an historian was already established when he succeeded to the earldom in 1855, and in 1872 he was made an honorary associate of the Institute of France. He was president of the Literary Fund from 1863 until his death. He died on the 24th of December 1875, being succeeded as 6th earl by his son Arthur Philip (1838–1905), father of the 7th earl. His second son, Edward Stanhope (1840–1893), was a well-known Conservative politician, who filled various important offices, and was finally secretary of state for war (1886–1892).

STANHOPE, LADY HESTER LUCY (1776–1839), the eldest child of the 3rd Earl Stanhope by his first wife Lady Hester Pitt, was born on the 12th of March 1776, and dwelt at her father's seat of Chevening in Kent until early in 1800, when his excitable and wayward disposition drove her to her grandmother's house at Burton Pynsent. A year or two later she travelled abroad, but her cravings after distinction were not satisfied until she became the chief of the household of her uncle, William Pitt, in August 1803. She sat at the head of his table and assisted in welcoming his guests, gracing the board with her stately beauty and enlivening the company by her quickness and keenness of conversation. Although her brightness of style cheered the declining days of Pitt and amused most of his political friends, her satirical remarks sometimes created enemies when more consideration for the feelings of her associates would have converted them into friends. Lady Hester Stanhope possessed great business talents, and when Pitt was out of office she acted as his private secretary. She was with him in his dying illness, and some of his last thoughts were concerned with her future, but any anxiety which might have arisen in her mind on this point was dispelled through the grant by a nation grateful for her uncle's qualities of a pension of £1200 a year, dating from the 30th of January 1806, which Lady Hester Stanhope enjoyed for the rest of her days. On Pitt's death she lived in Montagu Square, London, but life in London without the interest caused by associating with the principal politicians of the Tory party proved irksome to her, and she sought relief from lassitude in the fastnesses of Wales. Whilst she remained on English soil happiness found no place in her heart, and her native land was finally abandoned in February 1810. After many wanderings she settled among the Druses on Mt Lebanon, and from this solitary position she wielded an almost absolute authority over the surrounding districts. Her control over the natives was sufficiently commanding to induce Ibrahim Pasha, when about to invade Syria in 1832, to solicit her neutrality, and this supremacy was maintained by her commanding character and by the belief that she possessed the gift of divination. Her cherished companion, Miss Williams, and her trusted medical attendant, Dr Charles Lewis Meryon (1783–1877), dwelt with her for some time; but the former died in 1828, and Meryon left Mt Lebanon in 1831, only returning for a final visit from July 1837 to August 1838. In this lonely residence, the villa of Djoun, 8 m. from Sidon, in a house "hemmed in by arid mountains," and with the troubles of a household of some thirty servants, only waiting for her death to plunder the house, Lady Hester Stanhope's strength slowly wasted away, and at last she died on the 23rd of June 1839. The disappointments of her life, and the necessity of overawing her servants as well as the chiefs who surrounded Djoun, had intensified a temper naturally imperious. In appearance as in voice she resembled her grandfather, the first Lord Chatham, and like him she domineered over the circle, large or small, in which she was placed.

Some years after her death there appeared three volumes of *Memoirs of the Lady Hester Stanhope as related by herself in Conversations with her Physician* (Dr Meryon, 1845), and these were followed in the succeeding year by three volumes of *Travels of Lady Hester Stanhope, forming the Completion of her Memoirs narrated by her Physician*. They presented a lively picture of this strange woman's life and character, and contained many anecdotes of Pitt

and his colleagues in political life for a quarter of a century before his death. See also Mrs Charles Roundell, *Lady Hester Stanhope* (1910).

STANIMAKA, a town of Bulgaria in Eastern Rumelia; on the Dérin Déré, an affluent of the Maritza, 12 m. S.S.E. of Philippopolis. Pop. (1906), 14,120. It is an important seat of the wine trade and also possesses a distillery. Sericulture is carried on under British auspices. To the south of the town are the ruins of the medieval citadel. Under its Greek name Stenimachos, the town is frequently mentioned in connexion with the Bulgarian wars from the 11th century onwards.

STANISLAU (Polish, *Stanisławów*), a town in Galicia, Austria, 87 m. S.E. of Lemberg by rail. Pop. (1900), 30,410, about half Jews. It possesses a beautiful parish church, which contains the tombs of the Potocki family. The principal industries include tanning, dyeing, tile-making, milling, the production of yeast and there is a large establishment for the manufacture of railway stock. Stanislaw is an important railway junction, and has a considerable trade, principally in agricultural produce. Stanislaw was founded by Stanislaw Potocki (d. 1683), and has been newly rebuilt since it was devastated by a great fire in 1868.

STANISLAUS I. [*LESZCZYŃSKI*] (1677–1766), king of Poland, born at Lemberg in 1677, was the son of Rafael Leszczyński, palatine of Posen, and Anne Catherine Jablonowska. He married Catherine Opalinska by whom he had one daughter. In 1697, as cupbearer of Poland, he signed the confirmation of the articles of election of Augustus II. In 1703 he joined the Lithuanian Confederacy, which the Sapiehas with the aid of Swedish gold had formed against Augustus, and in the following year was selected by Charles XII. to supersede Augustus. Leszczyński was a young man of blameless antecedents, respectable talents, and ancient family, but certainly without sufficient force of character or political influence to sustain himself on so unstable a throne. Nevertheless, with the assistance of a bribing fund and an army corps the Swedes succeeded in procuring his election by a scratch assembly of half a dozen castellans and a few score of gentlemen (July 2, 1704). A few months later Stanislaus was forced by a sudden inroad of Augustus to seek refuge in the Swedish camp, but finally on the 24th of September 1705 he was crowned king with great splendour, Charles himself supplying his nominee with a new crown and sceptre in lieu of the ancient regalia which had been carried off to Saxony by Augustus. The first act of the new king was to conclude an alliance with Charles XII. whereby Poland engaged to assist Sweden against the tsar. Stanislaus did what he could to assist his patron. Thus he induced Mazeppa the Cossack hetman to desert Peter at the most critical period of the war, and placed a small army corps at the disposal of the Swedes. But he depended so entirely upon the success of Charles's arms that after Poltava (1709) his authority vanished as a dream at the first touch of reality. The vast majority of the Poles hastened to repudiate him and make their peace with Augustus, and Leszczyński, henceforth a mere pensioner of Charles XII., accompanied Krassau's army corps in its retreat to Swedish Pomerania. On the restoration of Augustus, Stanislaus resigned the Polish Crown (though he retained the royal title) in exchange for the little principality of Zweibrücken. In 1716 he was saved from assassination at the hands of a Saxon officer, Lacroix, by Stanislaus Poniatowski, the father of the future king. He now resided at Weissenburg in Lorraine, and in 1725 had the satisfaction of seeing his daughter Mary become the consort of Louis XV. and queen of France. His son-in-law supported his claims to the Polish throne after the death of Augustus II. in 1733, which led to the war of the Polish Succession. On the 9th of September 1733 Stanislaus himself arrived at Warsaw, having travelled night and day through central Europe disguised as a coachman, and on the following day, despite many protests, was duly elected king of Poland for the second time. But Russia, opposed to any nominee of France and Sweden, at once protested against his election; declared in favour of the new elector of Saxony, as being the candidate of her Austrian ally; and on the 30th of June

1734 a Russian army of 20,000 under Peter Lacey, after proclaiming Augustus III. at Warsaw, proceeded to besiege Stanislaus in Danzig where he had intrenched himself with his partisans (including the primate and the French and Swedish ministers) to await the promised succour from France. The siege began in October 1734. On the 17th of March 1735 Marshal Münnich superseded Lacey, and on the 20th of May the long expected French fleet appeared in the roads and disembarked 2400 men. A week after its arrival this little army gallantly attempted to force the Russian intrenchments, but was beaten off and finally compelled to surrender. This, by the way, was the first time France and Russia met as foes in the field. On the 30th of June 1735 Danzig capitulated unconditionally, after sustaining a siege of 135 days which cost the Russians 8000 men. Stanislaus, disguised as a peasant, had contrived to escape two days before. He was first heard of again at Königsberg, whence he issued a manifesto to his partisans which resulted in the formation of a confederation on his behalf, and the despatch of a Polish envoy to Paris to urge France to invade Saxony with at least 40,000 men. In the Ukraine too, Count Nicholas Potocki kept on foot to support Stanislaus a motley host of 50,000 men, which was ultimately scattered by the Russians. In 1736 Stanislaus again abdicated the throne, but received by way of compensation the dukedom of Lorraine and Bar, which was to revert to France on his death. He settled at Lunéville, founded there the *Academia Stanislai*, and devoted himself for the rest of his life to science and philanthropy. He died in 1766 at the age of 89. Among his works may be mentioned: *Œuvres du philosophe bienfaisant* (Paris, 1763; 1866).

See Robert Nisbet Bain, *Charles XII.* (London, 1895); *ibid.*, *Pupils of Peter the Great*, cap. vi. (London, 1897); Czarnowski (Jan Nepomucen), *Stanislaw Leszczyński in Poland* (Pol.; Warsaw, 1858); Louis Lacroix, *Les Opuscules inédites de S. L.* (Nancy, 1866); *Lettres inédites de S. L.*, ed. P. Boyé (Paris, 1901); Marchioness Des Reaulx, *Le Roi Stanislas et Marie Leszczyńska* (Paris, 1895). (R. N. B.)

STANISLAUS II. AUGUSTUS [PONIATOWSKI] (1732–1798), king of Poland, the son of Stanislaw Poniatowski, palatine of Cracow, the friend and companion of Charles XII. of Sweden. Born in 1732 he owed his advance in life to the influence of his uncles the powerful Czartoryscy, who sent him to St Petersburg in the suite of the English ambassador Hanbury Williams. Subsequently, through the influence of the Russian chancellor, Bestuzhev-Ryumin, he was accredited to the Russian court as the ambassador of Saxony. Through Williams he was introduced to the grand duchess Catherine, who was irresistibly attracted to the handsome and brilliant young nobleman, for whom she abandoned all her other lovers. Poniatowski was concerned in the mysterious and disreputable conspiracy which sought to set aside the succession of the grand duke Peter and his son Paul in favour of Catherine, a conspiracy frustrated by the unexpected recovery of the empress Elizabeth and the consequent arrest of the conspirators. Stanislaus returned to Warsaw much discredited, but nevertheless was (Sept. 7, 1764) elected king of Poland through the overwhelming influence of Catherine (she had promised him the crown as early as October 1763), and was crowned on the 25th of November, to the disgust of his uncles, who would have preferred another nephew, Prince Adam Casimir Czartoryscy, as king, but were obliged to submit to the dictation of the Russian court. The best that can be said for Stanislaus as king of Poland is that with all his romantic ideas and excellent intentions he remained from first to last the creature of circumstances. He had climbed to the throne by very slippery ways, he was dependent for a considerable part of his enormous income on the woman who had compensated him with a crown for the loss of her affections, he was detested by the nobility, who regarded him as a base-born upstart and yet had to put up with him. Thus in every way his position was most difficult; yet he tried to do his duty. In the beginning of his reign he broke away from the leading-strings of his uncles and inaugurated some useful economical reforms. After the first partition (as a result of which, by the way, his debts amounting to 7,000,000 guildens were paid by the Diet and his civil list

was raised to 216,000 guildens per annum) he entered enthusiastically into the attempts of the patriots to restore the power and prosperity of their country, while the eloquent oration which he delivered before the Diet on taking the oath to defend the constitution of the 3rd of May 1791, moved the susceptible deputies to tears. But when the confederation of Targowica, with the secret support of Russia, was formed against the constitution, he was one of the first to accede to it, thus completely paralysing the action of the army which, under his younger brother Prince Joseph and Thaddeus Kosciuszko, was performing prodigies. In fact, by the end of his life, Stanislaus had become an expert in the art of "acceding" and "hedging." Of resolute and independent action he was quite incapable; in fact, his whole career is little more than a record of humiliations. Thus in 1782 when he waited upon Catherine at Kaniow during her triumphal progress to the Crimea, she kept her ancient, grey-haired lover waiting for weeks, and while half contemptuously promising to respect the integrity of Poland, she curtly declined to be present at a supper which he had prepared for her at great cost. A few years later he was forcibly abducted by the Confederates of Bar, who did not know what to do with their captive, and allowed him to return to his court in a confused, bedraggled condition. On the outbreak of the insurrection of 1794 he was obliged to sue for his very life to Kosciuszko, and suffered the indignity of seeing his effigy expunged from the coinage a year before he was obliged to abdicate his throne. The last years of his life were employed in his sumptuous prison at St Petersburg (where he died in 1798) in writing his memoirs. Of his innumerable mistresses the most notable was Mme Lullié, the widow of an upholsterer, on whom he lavished a fortune. He also contracted a secret marriage with the countess Grabowska. Yet he was capable of the most romantic friendships, as witness his correspondence with Mme Geoffrin, whom he invited to Warsaw, where on her arrival she found rooms provided for her exactly like those she had left at Paris—the same size, the same kind of carpets, the same furniture, down even to the very book which she had been reading the evening before her departure, placed exactly as she had left it with a marker at the very place where she had left off. Stanislaus had indeed a generous heart, frequently paid the debts of his friends or of deserving scholars whose cases were brought to his notice, and was exceedingly good to the poor. He also encouraged the arts and sciences, and his Wednesday literary suppers were for some time the most brilliant social functions of the Polish capital. The best description of Stanislaus is by the Swedish minister Engeström, who was presented to him early in 1788. "The king of Poland," he says, "has the finest head I ever saw, but an expression of deep melancholy detracts from the beauty of his countenance. . . . He is broad-shouldered, deep-chested, and of such lofty stature that his legs seem disproportionately short. . . . He has all the dazzling qualities necessary to sustain his dignity in public. He speaks the Polish, Latin, German, Italian, French and English tongues perfectly. . . . and his conversation fills strangers with admiration. . . . As a grand-master of the ceremonies he would have done the honours most brilliantly. . . . Moral courage he altogether lacks and allows himself to be completely led by his *entourage*, which for the most part consists of women."

See Lars von Engeström, *Minnen och Anteckningar*, vol. i. (Stockholm, 1876); *Correspondance inédite de Stanislas Poniatowski avec Madame Geoffrin* (Paris, 1875); Jan Kibinski, *Recollections of the Times of Stanislaw Augustus* (Pol. Cracow, 1899); *Mémoires secrets et inédits de Stanislas Auguste* (Leipzig, 1862); *Stanislaw and Prince Joseph Poniatowski in the Light of their Private Correspondence*, in French, edited in Polish by Bronislaw Dembinski (Lemberg, 1904). Stanislaus's diaries and letters, which were for many years in the Russian foreign office, have been published in the *Vestnik Evropy* for January 1908. See also R. N. Bain's, *The Last King of Poland and his Contemporaries* (1909). (R. N. B.)

STANLEY (FAMILY). This ancient and historic English family derived its name from Stanley in Leek (in the Staffordshire "moorlands"). Its first known ancestor is Adam de Stanley, brother of Liulf de Audley, ancestor of the lords Audley, who lived in the time of King Stephen. His descendant William de

Stanley acquired the forestership of Wirral, with an heiress, in 1284, and was ancestor of two brothers, Sir William and Sir John Stanley. The former married the heiress of Hooton in Wirral and was ancestor of the Stanleys of Hooton, whose baronetcy, created in 1661, became extinct in 1893. The younger brother was lieutenant of Ireland under Richard II. and Henry IV., obtained from the latter the Isle of Man in fee, built a fortified house at Liverpool, and became K.G. He married the heiress of the Lathoms, a native family who had held Lathom in thanage from the Conquest at least and Knowsley by knight-service from the 12th century. His grandson Thomas was father of the first earl of Derby (see DERBY, EARLS OF) and of Sir William Stanley of Holt, whose great wealth led to his execution for treason in 1495, and also of Sir John Stanley, ancestor of the Stanleys of Alderley, who obtained a baronetcy in 1660 and a barony in 1839.

Of the second earl's younger brothers, Sir Edward was raised to the peerage as Lord Monteagle in 1514 for his services at Flodden, but the dignity passed with an heiress to the Parkers in 1581; and Sir James was ancestor of the Stanleys of Bickerstaffe, who obtained a baronetcy in 1628 and succeeded to the earldom in 1736. Their father had married the heiress of Lord Strange of Knockyn, and was summoned in that peerage from 1482 to 1497, but did not live to inherit the earldom. His wife was a first cousin of Henry VII.'s queen.

The 4th earl was summoned as Lord Strange, in his father's lifetime, as was the 5th earl, but the barony fell into abeyance between his three daughters, who contested possession of the family estates with his brother, the 6th earl. He bought out their rights in the Isle of Man, and, by his marriage with a sister and co-heir of the 18th earl of Oxford, acquired a claim to the great chamberlainship, which he advanced in 1626 and which was renewed by their descendants. His son was summoned as Lord Strange in 1628 in the erroneous belief that the family retained the dignity, and a fresh barony of Strange was thus created. But on the death of the 10th earl (1736) this barony, with the lordship of Man and other great estates, passed to the 2nd duke of Atholl, whose heir, the present duke, holds the title. The earldom with large estates in Lancashire, passed to the heir male (see above).

Although the present wealth of the Stanleys is largely derived from the great industrial development of Lancashire, they were already a power to be reckoned with in that county and in Cheshire at the time of the Wars of the Roses, and have held a leading position ever since among English nobles. For three centuries they were in succession lords-lieutenant of Lancashire and occasionally of Cheshire as well, and they have always lived in considerable state. Lathom House, their ancient seat, in the hundred of West Derby (whence possibly the style of their earldom), was wrecked in the Civil War, and, though rebuilt by the ninth earl, was sold by his daughters. But Knowsley, with its great park, is still theirs, lying to the east of Liverpool, in which their feudal tower still stood in 1821.

See Young's *Hundred of Wirral* (Liverpool, 1909); Round's *Peerage and Pedigree* (London, 1910); County Histories of Lancashire and Cheshire, and works on the peerage *passim*. (J. H. R.)

The barony of STANLEY OF ALDERLEY was created in 1839 for Sir John Thomas Stanley, Bart. (1766-1850), of Alderley Park, Cheshire, a brother of Edward Stanley (1779-1849), bishop of Norwich and father of Arthur Penrhyn Stanley. A member of parliament and a fellow of the Royal Society, he married Maria Josepha (d. 1863), daughter of John Holroyd, 1st earl of Sheffield. Their eldest son, Edward John Stanley, 2nd baron (1802-1860), entered the House of Commons in 1831 and became under-secretary to the home department in 1841, patronage secretary to the treasury from 1835 to 1841, paymaster-general in 1841, and under-secretary for foreign affairs from 1846 to 1852. In 1848, two years before he succeeded to the barony of Stanley, he was created Baron Eddisbury of Winnington. He was president of the board of trade from 1855 to 1858, and postmaster-general from 1860 to 1866. His wife, Henrietta Maria (1807-1895), a daughter of Henry Augustus Dillon-Lee, 13th Viscount Dillon,

was a remarkable woman. Before her marriage in 1826 she had lived in Florence, and had attended the receptions of the countess of Albany, the widow of Charles Edward, the Young Pretender; and in London she had great influence in social and political circles. When he was patronage secretary her husband was described by Lord Palmerston as "joint-whip with Mrs Stanley." Later in life Lady Stanley of Alderley helped to found the Women's Liberal Unionist Association, and she was a strenuous worker for the higher education of women, helping to establish Girton College, Cambridge, the Girls' Public Day School Company, and the Medical College for Women. She died on the 16th of February 1895. Her younger son, Edward Lyulph Stanley (b. 1839), who in 1903 succeeded his brother Henry Edward John (1827-1903) as 4th baron, had previously had an active career as an educationist and a Liberal politician. He was a fellow of Balliol College, Oxford, and was M.P. for Oldham from 1880 to 1885. He was for many years a member of the London School Board. In 1909 on the death of the 3rd earl of Sheffield, he inherited the barony of Sheffield, and that of Stanley of Alderley now became merged in it.

STANLEY, ARTHUR PENRHYN (1815-1881), English divine, dean of Westminster, was born on the 13th of December 1815, at Alderley in Cheshire, where his father, afterwards bishop of Norwich, was then rector. He was educated at Rugby under Arnold, and in 1834 went up to Balliol College, Oxford. After obtaining the Ireland scholarship and Newdigate prize for an English poem (*The Gypsies*), he was in 1839 elected fellow of University College, and in the same year took orders. In 1840 he travelled in Greece and Italy, and on his return settled at Oxford, where for ten years he was tutor of his college and an influential element in university life. His personal relations with his pupils were of a singularly close and affectionate nature, and the charm of his social gifts and genial character won him friends on all sides. His literary reputation was early established by his *Life of Arnold*, published in 1844. In 1845 he was appointed select preacher, and published in 1847 a volume of *Sermons and Essays on the Apostolic Age*, which not only laid the foundation of his fame as a preacher, but also marked his future position as a theologian. In university politics, which at that time wore mainly the form of theological controversy, he was a strong advocate of comprehension and toleration. As an undergraduate he had entirely sympathized with Arnold in resenting the agitation led by, but not confined to, the High Church party in 1836 against the appointment of R. D. Hampden to the regius professorship of divinity. During the long agitation which followed the publication in 1841 of Tract No. XC. and which ended in the withdrawal of J. H. Newman from the Anglican Church, he used all his influence to protect from formal condemnation the leaders and tenets of the "Tractarian" party. In 1847 he resisted the movement set on foot at Oxford against Hampden's appointment to the bishopric of Hereford. Finally, in 1850, in an article published in the *Edinburgh Review* in defence of the "Gorham judgment" he asserted two principles which he maintained to the end of his life—first, "that the so-called supremacy of the Crown in religious matters was in reality nothing else than the supremacy of law," and, secondly, "that the Church of England, by the very condition of its being, was not High or Low, but Broad, and had always included and been meant to include, opposite and contradictory opinions on points even more important than those at present under discussion."

It was not only in theoretical but in academical matters that his sympathies were on the liberal side. He was greatly interested in university reform and acted as secretary to the royal commission appointed in 1850. Of the important changes in administration and education which were ultimately carried out, Stanley, who took the principal share in drafting the report printed in 1852, was a strenuous advocate. These changes included the transference of the initiative in university legislation from the sole authority of the heads of houses to an elected and representative body, the opening of college fellowships and scholarships to competition by the removal of local and other

restrictions the non-enforcement at matriculation of subscription to the Thirty-nine Articles, and various steps for increasing the usefulness and influence of the professoriate. Before the report was issued, Stanley was appointed to a canonry in Canterbury Cathedral. During his residence there he published his *Memoir of his father* (1851), and completed his *Commentary on the Epistles to the Corinthians* (1855). In the winter and spring of 1852-1853 he made a tour in Egypt and the Holy Land, the result of which was his well-known volume on *Sinai and Palestine* (1856). In 1857 he travelled in Russia, and collected much of the materials for his *Lectures on the Eastern Church* (1861). His *Memorials of Canterbury* (1855), displayed the full maturity of his power of dealing with the events and characters of past history. He was also examining chaplain to Bishop A. C. Tait, his former tutor.

At the close of 1856 Stanley was appointed regius professor of ecclesiastical history at Oxford, a post which, with the attached canonry at Christ Church, he held till 1863. He began his treatment of the subject with "the first dawn of the history of the church," the call of Abraham; and published the first two volumes of his *History of the Jewish Church* in 1863 and 1865. From 1860 to 1864 academical and clerical circles were agitated by the storm which followed the publication of *Essays and Reviews*, a volume to which two of his most valued friends, Benjamin Jowett and Frederick Temple, had been contributors. Stanley's part in this controversy may be studied in the second and third of his *Essays on Church and State* (1870). The result of his action was to alienate the leaders of the High Church party, who had endeavoured to procure the formal condemnation of the views advanced in *Essays and Reviews*. In 1836 he published a *Letter to the Bishop of London*, advocating a relaxation of the terms of clerical subscription to the Thirty-nine Articles and the Prayer-book. An act amending the Act of Uniformity, and carrying out in some degree Stanley's proposals, was passed in the year 1865. In 1862, Stanley, at Queen Victoria's wish, accompanied the prince of Wales on a tour in Egypt and Palestine.

Towards the close of 1863 he was appointed by the Crown to the deanery of Westminster. In December he married Lady Augusta Bruce, sister of Lord Elgin, then governor-general of India. His tenure of the deanery of Westminster was memorable in many ways. He recognized from the first two important disqualifications—his indifference to music and his slight knowledge of architecture. On both these subjects he availed himself largely of the aid of others, and threw himself with characteristic energy and entire success into the task of rescuing from neglect and preserving from decay the treasure of historic monuments in which the abbey is so rich. In 1865 he published his *Memorials of Westminster Abbey*, a work which, despite occasional inaccuracies, is a mine of information. He was a constant preacher, and gave a great impulse to Trench's practice of inviting distinguished preachers to the abbey pulpit, especially to the evening services in the nave. His personal influence, already unique, was much increased by his removal to London. His circle of friends included men of every denomination, every class and almost of every nation. He was untiring in literary work, and, though this consisted very largely of occasional papers, lectures, articles in reviews, addresses, and sermons, it included a third volume of his *History of the Jewish Church*, a volume on the *Church of Scotland*, another of *Addresses and Sermons* preached in America, and another on *Christian Institutions* (1881). He was continually engaged in theological controversy, and, by his advocacy of all efforts to promote the social, moral, and religious amelioration of the poorer classes and his chivalrous courage in defending those whom he held to be unjustly denounced, undoubtedly incurred much and growing odium in influential circles. Among the causes of offence might be enumerated not only his vigorous defence of one from whom he greatly differed, Bishop Colenso, but his invitation to the Holy Communion of all the revisers of the translation of the Bible, including a Unitarian among other Nonconformists. Still stronger was the feeling caused by his efforts to make the recital of the Athanasian Creed optional instead of imperative in the

Anglican Church. In 1874 he spent part of the winter in Russia, whither he went to take part in the marriage of the duke of Edinburgh and the grand duchess Marie. He lost his wife in the spring of 1876, a blow from which he never entirely recovered. But in 1878 he was deeply interested by a tour in America, and in the following autumn visited for the last time northern Italy and Venice. In the spring of 1881 he preached funeral sermons in the abbey on Thomas Carlyle and Lord Beaconsfield, concluding with the latter a series of sermons preached on public occasions. In the summer he was preparing a paper on the Westminster Confession, and preaching in the abbey a course of Saturday *Lectures on the Beatitudes*. He died on the 18th of July, and was buried in Henry VII.'s chapel, in the same grave as his wife. His pall-bearers comprised representatives of literature, of science, of both Houses of Parliament, of theology, Anglican and Nonconformist, and of the universities of Oxford and Cambridge. The recumbent monument placed upon the spot, and the windows in the chapter-house of the abbey, one of them a gift from Queen Victoria, were a tribute to his memory from friends of every class in England and America.

Stanley was undoubtedly the leading liberal theologian of his time in England. Throughout his writings we see the impress, not only of his distinctive genius and of his extraordinary gifts, but also of his special views, aims and aspirations. He looked on the age in which he lived as a period of transition, to be followed either by an "eclipse of faith" or by a "revival of Christianity in a wider aspect," a "catholic, comprehensive, all-embracing Christianity" that "might yet overcome the world." He was never tired of asserting his belief "that the Christian Church had not yet presented its final or its most perfect aspect to the world"; that "the belief of each successive age of Christendom had as a matter of fact varied enormously from the belief of its predecessor"; that "all confessions and similar documents are, if taken as final expressions of absolute truth, misleading"; and that "there still remained, behind all the controversies of the past, a higher Christianity which neither assailants nor defenders had fully exhausted." "The first duty of a modern theologian" he held to be "to study the Bible, not for the sake of making or defending systems out of it, but for the sake of discovering what it actually contains." To this study he looked for the best hope of such a progressive development of Christian theology as should avert the danger arising from "the apparently increasing divergence between the intelligence and the faith of our time." He enforced the duty "of placing in the background whatever was accidental, temporary or secondary, and of bringing into due prominence what was primary and essential." In the former group Stanley would, without doubt or hesitation, have placed all questions connected with Episcopal or Presbyterian orders, or that deal only with the outward forms or ceremonies of religion, or with the authorship or age of the books of the Old Testament. Even to the question of miraculous and external evidence he would have been inclined to assign a secondary place.

The foremost and highest place, that of the "essential and supernatural" elements of religion, he would have reserved for its moral and spiritual truths, "its chief evidence and chief essence," "the truths to be drawn from the teaching and from the life of Christ," in whose character he did not hesitate to recognize "the greatest of all miracles."

With such views it was not to be wondered at that, from first to last, as has already been indicated, he never lost an opportunity of supporting a policy of width, toleration and comprehension in the Church of England. So again he was always eager to insist on the essential points of union between various denominations of Christians. He was throughout his life an unflinching advocate of the connexion between Church and State. By this he understood: (1) "the recognition and support on the part of the state of the religious expression of the faith of the community," and (2) "that this religious expression of the faith of the community on the most sacred and most vital of all its interests should be controlled and guided by the whole community through the supremacy of law." At the same time he was in favour of making the creed of the Church as wide as possible—"not narrower than that which is even now the test of its membership, the Apostles' Creed"—and of throwing down all barriers which could be wisely dispensed with to admission to its ministry. As an immediate step he even advocated the admission under due restrictions of English Nonconformists and Scottish Presbyterians, to preach in Anglican pulpits.

Apart from the great impulse which he gave to the study alike of the Bible and Church history, his influence may be said in a very true sense to colour the writings of many of those who most differ from him. The subjects to which he looked as the most essential of all—the universality of the divine love, the supreme importance of the moral and spiritual elements of religion, the supremacy of conscience, the sense of the central citadel of Christianity as being contained in the character, the history, the spirit of its divine

Founder—have impressed themselves more and more on the teaching and the preaching of every class of clergy in the Church.

See G. G. Bradley, *Recollections of A. P. Stanley* (1883); R. E. Prothero and G. G. Bradley, *Life and Correspondence of Dean Stanley* (2 vols., 1893).

STANLEY, EDWARD (1779–1849), bishop of Norwich, the younger brother of the 1st Baron Stanley of Alderley, was born in London and educated at St John's College, Cambridge (16th wrangler, 1802). He was ordained in 1802 and became rector of Alderley, Cheshire, three years later. Here he took a great interest in education, and encouraged especially the teaching of secular subjects at his school. In 1837 he was consecrated bishop of Norwich. The diocese at this time was conspicuous for laxity and want of discipline, and this he proceeded to remedy, although at first he met with much opposition. Ordinations and confirmations were held more regularly and frequently, the schools were properly inspected, the Plurality Act was enforced and undesirable clergy were removed. He was tolerant towards Dissenters and supported all missionary undertakings without regarding their sectarian associations. In politics he was a Liberal and devoted himself especially to educational questions. Dean Stanley (see above) was his third son.

Stanley's letters, *Before and after Waterloo* (edited by J. H. Adeane and M. Grenfell, 1907), are full of interest to students of Napoleonic history.

STANLEY, SIR HENRY MORTON (1840–1904), British explorer of Africa, discoverer of the course of the Congo, was born at Denbigh, Wales, on the 10th of June 1840.¹ His parents were named Rowlands or Rollant, and his father, who died in 1843, was the son of a small farmer. John Rowlands, by which name Stanley was baptized, was brought up first by his maternal grandfather, and after his death was boarded out by his mother's brothers at half a crown a week. In 1847 he was taken to the St Asaph Union workhouse, where he was noted for his activity and intelligence. The schoolmaster at the workhouse, James Francis (who eventually died in a madhouse), was a tyrant of the Squeers type, and in May 1856, Rowlands, after giving Francis a thrashing, ran away from school. He sought out his paternal grandfather—a well-to-do farmer—who refused to help him. A cousin, however, who was master of a national school at Brynford, took him in as a pupil teacher. But within a year he was sent to Liverpool, where he lived with an uncle who was in straitened circumstances. The lad, after working at a haberdasher's and then at a butcher's shop, engaged himself as a cabin boy on a sailing ship bound for New Orleans, in which city he landed early in 1859. There he obtained a situation through the good offices of a merchant named Henry Morton Stanley, who subsequently adopted the lad as his son, designing for him a mercantile career. To this end young Stanley (as he was henceforth known) was sent to a country store in Arkansas. The merchant shortly afterwards died, without having made further provision for his protégé.

When the Civil War broke out in 1861 Stanley enlisted in the Confederate army; he was taken prisoner at the battle of Shiloh (April 1862), and after two months' experience of the hardships of Camp Douglas, Chicago (where the prisoners of war were confined), he obtained release by enrolling in the Federal artillery. In less than a month he was discharged as unfit. In November 1862 he returned to Liverpool "very poor, in bad health and in shabby clothes," and made his way to Denbigh, but was turned away from his mother's door. This incident deeply affected him. Naturally of a sensitive, affectionate nature, henceforth he practised strong self-suppression and reserve. For a livelihood he took to the sea—was wrecked off Barcelona—and in August 1864 enlisted in the United States navy. According to an apparently authentic story² he obtained promotion for swimming 500 yds. and tying a rope to a captured steamer, while exposed to the shot and shell of a battery of ten guns. After the war he crossed the plains to Salt Lake City, Denver, and other parts, acquiring a reputation as a vivid descriptive writer for the press.

¹ This is the usually accepted date, but from Stanley's *Autobiography* it would appear that the year of his birth was 1842.

² See C. Rowlands, *Henry M. Stanley*, p. 102.

Thus began a series of adventures in search of "copy." In the autumn of 1866 we hear of him travelling in Asia Minor "*en route* for Tiflis and Tibet," and as being attacked, with his two companions, by brigands, robbed and imprisoned, the Porte subsequently paying through the American minister an indemnity for the outrage. In December of the same year Stanley revisited Denbigh and St Asaph, returning thence to America. In 1867 he joined General Hancock's expedition against the Red Indians, acting as correspondent for the *Missouri Democrat* and other papers. His reports induced the *New York Herald* to send him to accompany the British expedition of 1867–68 against the emperor Theodore of Abyssinia. Succeeding in sending through the first news of the fall of Magdala, Stanley attracted the special attention of the proprietor of the *Herald*, James Gordon Bennett, and received from him a roving commission. He went to Crete, then in rebellion, in the latter part of 1868, and thence to Spain, where he arrived in time to witness the scenes following the flight of Queen Isabella from Madrid. He chronicled the events of the Republican rising in 1869 and was at Madrid in October of that year, when he received a telegram from Mr Gordon Bennett, jun., summoning him to Paris.

Arrived in Paris Stanley was informed that he was to go and find Livingstone.³ Stanley then shared the common opinion that Livingstone had died somewhere in Central Africa, but Bennett was sure he was alive and Stanley was to find and help him to the best of his ability. The journey, which was to be kept secret to avoid suspicion, was to begin next day. Strangely enough, though so urgent in the matter, Bennett cumbered Stanley with a large number of commissions to fulfil before the quest for Livingstone could be begun. In accordance with these instructions, Stanley went to Egypt to witness the opening of the Suez Canal in November, thence to Philae, and in January 1870 he arrived in Jerusalem, where he met Captain (afterwards Sir) Charles Warren. Next, by way of Constantinople, he visited the battlefields of the Crimea, and, passing through the Caucasus from Baku, he made an adventurous journey across Persia to Bushire, whence he sailed to Bombay. From Bombay he sailed for Africa, reaching Zanzibar on the 6th of January 1871.

The journey to the interior was begun on the 21st of March; on the 10th of November, having overcome innumerable difficulties, Stanley arrived at Ujiji, where Livingstone then was; the young traveller greeting the famous veteran with the words, "Dr Livingstone, I presume?" With Livingstone Stanley navigated the northern shores of Tanganyika and settled the question as to whether the Rusizi was an affluent or an effluent—a point then much debated in connexion with the hydrography of the Nile basin. Leaving Tanganyika on the 6th of January 1872 Stanley regained Zanzibar on the 7th of May. He had accomplished his mission, and by it he established his reputation as a leader of men and an explorer of great promise. His story, made public in a picturesque narrative, *How I Found Livingstone* (1872), was at first received in London with some incredulity, owing in part to his connexion with American journalism of a type then unfamiliar and distasteful; but the journals of Livingstone, which he brought home, silenced the critics, and from Queen Victoria Stanley received a gold snuff-box set with brilliants and her thanks for the services he had rendered. Nevertheless Stanley records that all the actions of his life, and all his thoughts, since 1872, were strongly coloured by the storm of abuse and the wholly unjustifiable reports circulated about him then.

A series of public lectures in England and America followed. In 1873, as war correspondent of the *Herald*, he accompanied Wolseley's expedition to Ashanti, which he described, together with his Abyssinian experiences, in a volume entitled *Coomassie and Magdala: Two British Campaigns* (London, 1874). On reaching the island of St Vincent from Ashanti in 1874 he first heard that Livingstone was dead, and that the body was on its way to England. After the funeral of Livingstone some time was spent in negotiations for sending Stanley again to Africa,

³ Previously, in November 1868, Stanley had been sent to Egypt by the *Herald* "to meet Livingstone," at the time reported to be on his way home. Stanley got as far as Aden when he was recalled.

there to determine geographical problems left unsolved by the deaths of Livingstone and Speke, and the discovery by Sir Samuel Baker of Albert Nyanza, a lake then reputed to extend illimitably in a southerly direction. Finally, Sir Edward Lawson (afterwards Lord Burnham), the editor and proprietor of the *Daily Telegraph*, to whom Stanley had communicated his desires, and Sir Edwin Arnold of that journal, induced Mr Gordon Bennett to join them in raising a fund for an Anglo-American expedition under Stanley's command. This expedition lasted from October 1874 to August 1877 and accomplished more than any other single exploring expedition in Africa. Politically, also, the journey had momentous consequences; it led directly to the foundation of the Congo State and to the partition of the hitherto unappropriated regions of Africa between the states of western Europe. Stanley started from the east coast and reached the ocean again at the mouth of the Congo, having demonstrated the identity of that river with Livingstone's Lualaba by navigating its course from Nyangwe—the point at which both Livingstone and Lovett Cameron had turned aside. This wonderful achievement was accomplished in the face of difficulties so great that they could have been overcome only by such a man as Stanley proved himself to be—a man of inflexible will, who having conceived a vast design carried it to its conclusion regardless of any obstacles, sparing neither himself nor his associates and, if opposed, prepared to shed blood to attain his object. Of the three white men who accompanied him all died during the journey; Stanley himself was prematurely aged. The discovery of the course of the Congo, though the greatest, was but one of many geographical problems solved during this memorable expedition. The part played by the Kagera in the Nile system, the unity and approximate area of Victoria Nyanza, the true length and area of Tanganyika and the whereabouts of its outlet, and the discovery of a new lake, Dweru, which at the time Stanley believed to be a branch of Albert Nyanza, are some of the other discoveries made by Stanley at this time. The story of the expedition was given at length in *Through the Dark Continent* (London, 1878). Stanley's letters from Uganda and his call for missionaries to go to the court of Mtesa met with an immediate response and proved the first step in bringing the region of the Nile sources under the protection of Great Britain. Important as was this result of his journey it was eclipsed by the events which followed his revelation of the Congo as a magnificent waterway piercing the very heart of Africa. Of the commercial possibilities of the region he had made known Stanley was well aware. The one other man who at once grasped the situation was Leopold II., king of the Belgians, who sent commissioners to intercept Stanley at Marseilles, when he was on his way back to England, with proposals to return to the Congo, proposals which Stanley, much needing rest, put aside for the time. Approached again in the summer of 1878 Stanley lent a more favourable ear to Leopold's suggestions. Efforts made by the explorer in the autumn to arouse British merchants to the importance of the Congo basin were unavailing, and in November Stanley went to Brussels and committed himself to the schemes of the king of the Belgians. A *Comité d'études du Haut Congo* was formed and Stanley was entrusted with the leadership of the new expedition, which was, in his own words, "to prove that the Congo natives were susceptible of civilization and that the Congo basin was rich enough to repay exploitation." Stanley reached the Congo in August 1879, and the work he accomplished there in the ensuing five years enabled the Comité, which had meantime changed its name to that of *Association internationale du Congo*, to obtain the recognition of America and Europe to its transformation into an independent state ("The Congo Free State") under the sovereignty of King Leopold. Stanley described his labours in *The Congo and the Founding of its Free State* (London, 1885), a book which throws valuable light on the manner in which the promoters of that enterprise set to work, and the object at which, from the beginning, they aimed. For the political aspects of this question see AFRICA (§ 5) and CONGO FREE STATE. Here it is only necessary to indicate what Stanley actually accomplished on the Congo. At the outset the area of his activities was

restricted by the enterprise of the French traveller de Brazza, who, reaching Stanley Pool by a more northern route, placed—September and October 1880—the neighbouring districts on the north bank of the Congo under French protection. De Brazza's journey was directly inspired by Stanley's discoveries, and thus early had those discoveries led to international rivalries. Notwithstanding this check Stanley, without much trouble with the natives, founded stations for his association along the banks of the river as high up as Stanley Falls. A more difficult task was the making of a road through the cataract region and the carrying over it in sections of four small steamers, all of which were launched on the middle river. This road-making exploit earned for Stanley from the natives the name of *Bula Matari*, the rock-breaker, the all-powerful—a fit description of the man who allowed no obstacles to turn him from the achievement of his purpose.

Stanley returned to Europe in the middle of 1884 and attended the Berlin Conference of 1884–1885, which dealt with African affairs, acting as technical adviser of the American plenipotentiaries. While in Germany he lectured in various cities on the benefits which would result from the opening up of Central Africa, and found the Germans more alive than the British to the great interests at stake. The revelation of what the *Association internationale* had done intensified the struggle among the powers for the possession of African territory. Stanley did not return to the Congo on the recognition of the Free State but took up his residence in London. With James F. Hatton, a leading Manchester merchant, he promoted the Royal Congo Railway Company to connect Stanley Pool with the lower river, but the scheme at the time came to nought, partly owing to the indifference of English capitalists and partly in consequence of a clause inimical to British interests in the charter which King Leopold proposed to grant the company.

Though still an American citizen Stanley's interests and ambitions were becoming distinctly British, his sympathies in that direction being joined to a personal loyalty to the king of the Belgians.¹ A desire to serve both parties was one of the leading motives in his next African adventure. Stanley had become deeply interested in the schemes of Mr (afterwards Sir) William Mackinnon, chairman of the British India Steam Navigation Company, for establishing a British protectorate in East Equatorial Africa, and it was believed that this object could be furthered at the same time that relief was afforded to Emin Pasha (*q.v.*), governor of the Equatorial Province of Egypt, who had been isolated by the Mahdist rising of 1881–1885. Stanley agreed to conduct an expedition, nominally in the service of the khedive of Egypt, for the relief of Emin. The major part of the funds needed was supplied by a committee, of which Mackinnon was chairman. Instead of choosing the direct route via Zanzibar or Mombasa, Stanley decided to go by way of the Congo, as thereby he would be able to render services to the infant Congo State, then encountering great difficulties with the Zanzibar Arabs established on the upper Congo. Stanley left Europe in January 1887 and at Zanzibar entered into an agreement with Tippoo Tib, the chief of the Congo Arabs, appointing him governor of Stanley Falls station on behalf of the Congo State, and making another arrangement with him to supply carriers for the Emin relief expedition. Stanley and Tippoo Tib travelled together up the Congo as far as Bangala, reached on the 30th of May. Thence Tippoo Tib went on to Stanley Falls and Stanley prepared for a journey to Albert Nyanza, where he expected to meet Emin. On the 15th of June Yambuya, on the lower Aruwimi, was reached, and here Stanley left his rear-guard under command of Major E. M. Barttelot and Mr J. S. Jameson. On the 28th Stanley and the advance-guard started for Albert Nyanza, "and until the 5th of December, for 160 days, we marched through the forest, bush and jungle, without ever having seen a bit of greensward of the size of a cottage chamber floor.

¹ Of the later policy pursued in the Congo State Stanley wrote, in 1896, that it was "erring and ignorant." To go back to the Congo "would be to disturb a moral malaria injurious to the reorganizer" (*Autobiography*, p. 537).

Nothing but miles and miles, endless miles of forest." Starvation, fever, the hostility of the tribes, were daily incidents of this terrible march, during which Stanley lost nearly 50% of his men. On the 13th of December Albert Nyanza was reached, and after some delay communication was opened with Emin, who came down the lake from the Nile in a steamer, the two chiefs meeting on the 29th of April 1888. Disquieted by the non-arrival of his rearguard, Stanley retraced his steps, and on the 17th of August, a short distance above Yambuya, found that Tippoo Tib had broken faith, that Barttelot had been murdered, that Jameson (who soon afterwards died of fever) was absent at Stanley Falls, and that only one European, William Bonny, was left in the camp. Collecting those who survived of the rearguard Stanley for the third time traversed the primeval forest, and in January 1889 all that was left of the expedition was assembled at Albert Nyanza. Of 646 men with whom he entered the Congo, but 246 remained. In April the return journey to Zanzibar by way of Uganda was begun, Emin reluctantly accompanying Stanley. On this homeward journey Stanley discovered Ruwenzori (the Mountains of the Moon), traced the course of the Semliki River, discovered Albert Edward Nyanza and the great south-western gulf of Victoria Nyanza. During his stay in the Congo forests he had also obtained much information concerning the pygmy tribes. As to the political results of the expedition, Stanley's proposals to Emin to hold the Equatorial Province for the Congo State or to move nearer Victoria Nyanza and enter the service of Mackinnon's British East Africa Company had not been accepted, but he concluded agreements with various chiefs in the lake regions in favour of Great Britain, agreements which were handed over to the East Africa Company. Zanzibar was reached on the 6th of December 1889 and the expedition was at an end. Stanley's account of it, *In Darkest Africa*, was published (in six languages) in 1890.

Returning to England, Stanley was received with much honour, among the many distinctions conferred upon him being the degrees of D.C.L. from Oxford and of LL.D. from Cambridge and from Edinburgh. On the 12th of July 1890 he married a lady whose graceful work as an artist was well known, Miss Dorothy Tennant, second daughter of Mr Charles Tennant, sometime M.P. for St Albans. Later in the year he visited the United States, where he made a pilgrimage to the places where his youth had been spent, and in 1891-1892 went to Australia and New Zealand on lecturing tours. On his return he was renaturalized as a British subject, and—at the solicitation of his wife—he stood at the general election in the summer of 1892 as candidate for North Lambeth in the Liberal Unionist interest, being defeated by a small majority. In 1895 he again stood for the same constituency and was elected, but he had no liking for parliamentary life, and (being also in ill-health) he did not seek re-election in 1900. In 1895 Stanley published *My Early Travels and Adventures in America and Asia*, in which he retold the story of his experiences with the Red Indians and of his eastern journey of 1869-1870. In 1897 Stanley paid his last visit to Africa. He went to the Cape as the guest of the British South Africa Company, spoke at the opening of the railway from the Cape to Bulawayo, visited the Victoria Falls of the Zambezi and had an interview with President Kruger, of whom he gives a characteristic picture. One result of this journey was *Through South Africa* (1898), the last of his published works. In 1899 in recognition of his services in Africa he was made a Knight Grand Cross of the Bath. The last few years of his life were spent mainly in retirement on a small estate he had purchased, Furze Hill, near Pirbright. He died at his London residence in Richmond Terrace, Whitehall, on the 10th of May 1904. After a service in Westminster Abbey he was buried at Pirbright on the 17th of May. His widow, Lady Stanley, afterwards married, in 1907, Mr Henry Curtis, F.R.C.S. By Sir Henry Stanley she had a son, Denzil, born 1896.

In geographical discoveries Stanley accomplished more than any other explorer of Africa, with which continent his name is indissolubly connected. Notwithstanding his frequent conflicts with Arabs and negroes, he possessed in extraordinary degree

the power of managing native races; he was absolutely fearless and ever ready to sacrifice either himself or others to achieve his object. His books differ widely from the ordinary books of travel. Stanley had a gift of dramatic narrative, and his power of portraiture was remarkable. Curiously, the least successful of his works was the only one which he cast in the form of fiction, *My Kalulu, Prince, King and Slave*. Another volume from his pen, *My Dark Companions and their Strange Stories* (1893), is a valuable contribution to folklore.

The Autobiography of Sir Henry Morton Stanley, ed. by his wife, Dorothy Stanley, appeared in 1909. *Henry M. Stanley, the Story of his Life* . . . (London, n.d. [1872]), by C. Rowlands, contains, notwithstanding many inaccuracies, valuable information concerning his family and early career. The following books may also be consulted: Mrs J. S. Jameson, *Story of the Rear Column of the Emin Pasha Relief Expedition* (1890); W. G. Barttelot, *The Life of Edmund Musgrave Barttelot* . . . (1890); H. Brode, *Tippoo Tib, the Story of his Career in Central Africa* (1907). (F. R. C.)

STANLEY, THOMAS (1625-1678), English poet and philosopher, son of Sir Thomas Stanley of Cumberlow, in Herts, was born in 1625. His mother, Mary Hammond, was the cousin of Richard Lovelace, and Stanley was educated in company with the son of Edward Fairfax, the translator of Tasso. He proceeded to Cambridge in 1637, in his thirteenth year, as a gentleman commoner of Pembroke Hall. In 1641 he took his M.A. degree, but seems by that time to have proceeded to Oxford. He was wealthy, married early, and travelled much on the Continent. He was the friend and companion, and at need the helper, of many poets, and was himself both a writer and a translator of verse. His *Poems* appeared in 1647; his *Europa, Cupid Crucified, Venus Vigils*, in 1649; his *Aurora and the Prince*, from the Spanish of J. Perez de Montalvan, in 1647; *Oronta, the Cyprian Virgin*, from the Italian of G. Preti (1650); and *Anacreon; Bion; Moschus; Kisses by Secundus* . . . a volume of translations, in 1651. Stanley's most serious work in life, however, was his *History of Philosophy*, which appeared in three successive volumes between 1655 and 1661. A fourth volume (1662), bearing the title of *History of Chaldaick Philosophy*, was translated into Latin by J. Le Clerc (Amsterdam, 1690). The three earlier volumes were published in an enlarged Latin version by Godfrey Olearius (Leipzig, 1711). In 1664 Stanley published in folio a monumental edition of the text of Aeschylus. He died at his lodgings in Suffolk Street, Strand, on the 12th of April 1678, and was buried in the church of St Martin-in-the-Fields. His portrait was painted by Sir Peter Lely; his wife was Dorothy, daughter and coheir of Sir James Emyon, of Flower, in Northamptonshire. Stanley is a very interesting transitional figure in English literature. Born into a later generation than that of Waller and Denham, he rejected their reforms, and was the last to cling obstinately to the old prosody and the conventional forms of fancy. He is the frankest of all English poets in his preference of decadent and Alexandrine schools of imagination; among the ancients he admired Moschus, Ausonius, and the *Pervigilium Veneris*; among the moderns, Joannes Secundus, Gongora and Marino. The English metaphysical school closes in Stanley, in whom it finds its most delicate and autumnal exponent, who went on weaving his fantastic conceits in elaborately artificial measures far into the days of Dryden and Butler. When Stanley turned to prose, however, his taste became transformed. He abandoned his decadents for the gravest masters of Hellenic thought. As an elegant scholar of the illuminative order, he secured a very high place indeed throughout the second half of the 17th century. His *History of Philosophy* was long the principal authority on the progress of thought in ancient Greece. It took the form of a series of critical biographies of the philosophers, beginning with Thales; what Stanley aimed at was the providing of necessary information concerning all "those on whom the attribute of Wise was conferred." He is particularly full on the great Attic masters, and introduces, "not as a comical divertisement for the reader, but as a necessary supplement to the life of Socrates," a blank verse translation of the *Clouds* of Aristophanes. Bentley is said to have had a very high appreciation of his scholarship, and to have made use of the

poet's copious notes, still in manuscript (in the British Museum), on Callimachus.

Stanley's original poems, which had been collected in 1651, were imperfectly reprinted in Sir S. Egerton Brydges's edition of 150 copies in 1814, but never since; his "Anacreon" was issued, with the Greek text, by Mr Bullen in 1892. His prose works have not been collected. (E. G.)

STANLEY, SIR WILLIAM (1548–1630), English soldier and traitor, was the eldest son of Sir Rowland Stanley (d. 1612) of Hooton, Cheshire, a member of the famous family of that name. As a volunteer under the duke of Alva he gained his earliest military experiences in the service of Spain; then about 1570 he joined the English forces in Ireland, where he remained for fifteen years, being knighted by Sir William Drury in 1579. He was very prominent in the guerrilla warfare against the Irish rebels; he was made sheriff of Cork, and he acted as deputy for Sir John Norris, the president of Munster, where by 300 executions he terrified the inhabitants "that a man now may travel the whole country and none to molest him." Having, says William Camden, "singulari fide et fortitudine in Hibernico bello moruerat," he returned to England in October 1585, undoubtedly annoyed that his services had not been more generously rewarded. In December of this year, however, he crossed to the Netherlands with the English forces, but almost as soon as he reached his destination he was sent to Ireland to collect recruits, of whom he enlisted about 1400. Although a strong Roman Catholic, Stanley had hitherto served Elizabeth loyally, but lingering in London on his return from his Irish errand, he seems to have entered into the schemes of the Jesuits against the queen, and he was probably aware of Anthony Babington's plot. But the time for more active and personal treachery had not yet arrived, and with his Irish levies he reached Holland in August 1586, fought gallantly at Zutphen and helped Sir William Pelham to seize Deventer. In spite of some remonstrances, Stanley was made governor of this town, being given extended powers by Leicester, and his opportunity had now come. In January 1587 he surrendered Deventer to the Spaniards, and while most of his men entered the Spanish service, he travelled to Madrid to discuss the projected invasion of England, his idea being to make Ireland the base for this undertaking. These and subsequent plans were ruined by the defeat of the Armada, but he made several journeys to Spain, and did not abandon the hope that England might be invaded. In the intervals between his travels he fought under the Spanish flag in the Netherlands and in France. Later he became governor of Mechlin, and he died at Ghent on the 3rd of March 1630. His descendant, William Stanley, was created a baronet in 1661, the male line of the family becoming extinct when Sir John Stanley-Errington, the 12th baronet, died in 1893.

See R. Bagwell, *Ireland under the Tudors* (1890), vol. iii.; and J. L. Motley, *The United Netherlands* (1904), vol. ii.

STANNARD, JOSEPH (1796–1830), British painter, was born in Norwich. He there received some training in art from Robert Ladbroke, the brother-in-law of Crome, and he also visited Holland and studied the pictures of the Dutch masters. His short life—he died when he was thirty-four—was spent in his native town, and he contributed to the exhibitions of the Norwich Society, of which he was a member, and also occasionally showed his work in London. Most of his pictures represent coast subjects or river scenes, but he had some reputation as a portrait-painter also, and in this branch of practice he achieved locally a fair measure of success. In his large picture, "The Annual Water Frolic at Thorpe," he combined landscape with portraiture. He attained no little skill as an etcher and published several plates which have a considerable degree of merit.

STANNARIES (Lat. *stannum*, Cornish, *stéan*, tin), tin mines. Stannary courts exercised a jurisdiction peculiar to Cornwall and Devon. So far as regards Cornwall the jurisdiction is an immemorial one. By ancient charters, the tinners of Cornwall were exempt from all other jurisdiction than that of the stannary courts, except in cases affecting land, life and limb.

The tin-mining industry of Cornwall, dating, as it does, from the very earliest times, was always prosecuted in accordance with a particular code of customs; the earliest charter which embodies them is that of Edmund, earl of Cornwall, but the freedom then assured was rather confirmed than given for the first time, and it is impossible to say how far these customs of the stannaries courts go back. Twenty-four stannators were returned for the whole of Cornwall. Their meeting was termed a parliament, and when they assembled they chose a speaker. In earlier times, the combined tinners of Devon and Cornwall assembled on Hingston Down, a tract of highland on the Cornish side of the Tamar. After the charter of Earl Edmund, the Cornish stannators met (apparently) at Truro; those of Devonshire at Crockern Tor or Dartmoor. An officer was appointed by the duke of Cornwall or the Crown, who was lord warden of the stannaries, and the parliaments were assembled by him from time to time, in order to revise old or to enact new laws. The last Cornish stannary parliament was held at Truro in 1752. For a long series of years little or no business was transacted in the stannary courts; but the necessity for a court of peculiar jurisdiction, embracing mines and mining transactions of every description within the county of Cornwall having become more and more apparent, a committee was appointed to report on the subject, and an act of parliament was afterwards (1836) passed, suppressing the law courts of the stewards of the different stannaries, and giving to the vice-warden their jurisdiction, besides confirming and enlarging the ancient equity jurisdiction of that office. By the Stannaries Act 1855 the respective parliaments or stannaries courts of Cornwall and Devon were consolidated. From the judgments of the vice-warden an appeal lay to the lord warden, and from him to the Supreme Court. By the Stannaries Courts Abolition Act 1896 the jurisdiction of the courts was transferred to the county courts. The most important customs may be briefly stated: (a) "free tinners" had the right to work upon rendering the "toll-tin," usually one-fifteenth of the produce, to the owner or lord of the soil; (b) the right of "tin-bounding," that is, the right of bounding any unappropriated waste lands, or any several or enclosed lands which had once been waste land, subject to the custom and to the delivery of tin-toll. The bound was marked by turf or stone, and was about an acre in extent. The estate of a bounder in Devonshire is real property, but in Cornwall is personal property.

For many centuries a tax on the tin, after smelting, was paid to the earls and dukes of Cornwall. The smelted blocks were carried to certain towns (Liskeard, Lostwithiel, Penzance, Truro) to be coined, that is, a corner of the block was cut off, and the block was then stamped with the duchy seal as a guarantee of the quality. By an act of 1838 the dues payable on the coinage of tin were abolished, and a compensation was awarded to the duchy instead of them.

See T. Pearce, *Laws and Customs of the Stannaries in the Counties of Cornwall and Devon* (1725); Bainbridge, *Law of Mines and Minerals*; G. R. Lewis, *The Stannaries: a Study of the English Tin Mines* ("Harvard Economic Studies," 1908).

STANNITE, a rare mineral consisting of tin, copper and iron sulphide (a sulpho-stannate, Cu_2FeSnS_4), containing, when pure, tin 27.5, copper 29.5%. It has a metallic lustre, and, when pure, is iron-black in colour: more often, however, it is bronze-yellow, owing to tarnish or to the presence of intimately admixed chalcopyrite: for this reason it is known to miners as "bell-metal-ore" or as "tin pyrites." The hardness is $3\frac{1}{2}$ and the specific gravity 4.45. It usually occurs as granular to compact masses, rarely as crystals. Minute crystals from Bolivia have been shown to be tetragonal and hemihedral, like chalcopyrite; and to be invariably twinned, giving rise to pseudocubic forms. The mineral has been found in a number of Cornish tin mines, and was formerly worked to a limited extent as an ore. At Zinnwald in Bohemia it occurs with blende and galena, and in Bolivia with silver ores. (L. J. S.)

STANS, the capital of the eastern half (or Nidwalden) of the Swiss canton of Unterwalden. It stands amid orchards at a

height of 1493 ft. above the sea-level on a plain at the north foot of the conical Stanserhorn (6238 ft.). It is, by electric railway, about 2 m. from Stansstad, its port on the south shore of the lake of Lucerne, and 12 m. from Engelberg (with its great Benedictine monastery, founded about 1120), now a much-frequented summer resort, while there is also an electric railway from Stans up the Stanserhorn. In 1900 Stans had a population of 2798, all German-speaking and Romanists. Stans was the home of the Winkelried family (*q.v.*) and has a modern monument to the memory of Arnold von Winkelried, the legendary hero of the battle of Sempach (1386). In 1481 the holy Nicholas von der Flüe composed at Stans by his advice the strife between the Confederates, while in 1798 many persons were massacred here by the French. (W. A. B. C.)

STANSFELD, SIR JAMES (1820-1898), English politician, was born at Moorlands, Halifax, on the 5th of October 1820, the son of James Stansfeld, a county-court judge. Educated at University College, London, he was called to the bar in 1849. In 1847 he was introduced through his father-in-law, W. H. Ashurst, to Mazzini, with whom he formed a close friendship. In 1859 he was returned to parliament as Radical member for Halifax, which town he continued to represent for over thirty-six years. He voted consistently on the Radical side, but his chief energies were devoted to promoting the cause of Italian unity. He was selected by Garibaldi as his adviser when the Italian patriot visited England in 1862. In 1863 he moved in the House of Commons a resolution of sympathy with the Poles, and two months later was made a junior lord of the admiralty. In 1864, as the result of charges made against him by the French authorities, in connexion with Greco's conspiracy against Napoleon III., Disraeli, in the House of Commons, accused him of being "in correspondence with the assassins of Europe." Stansfeld was vigorously defended by Bright and Forster, and his explanation was accepted as quite satisfactory by Palmerston. Nevertheless he only escaped a vote of censure by ten votes, and accordingly resigned office. In 1865 he was re-elected for Halifax, and in 1866 became under-secretary of state for India. In the first Gladstone administration he held a variety of public offices, finally becoming, in 1871, the first president of the local government board. The remainder of his life was mainly spent in endeavouring to secure the repeal of the Contagious Diseases Acts, and in 1886 this object was attained. In the same year Stansfeld again became president of the local government board. He died on the 17th of February 1898.

STANTON, EDWIN M'MASTERS (1814-1869), American statesman, was born at Steubenville, Ohio, on the 19th of December 1814. He attended Kenyon College at Gambier, Ohio, from 1831 to 1833, was admitted to the bar in 1836, was prosecuting attorney of Harrison county in 1837-1839, and practised in Cadiz, O., until 1839, when he returned to Steubenville. In 1847 he removed to Pittsburg, Pennsylvania, where he took a leading place at the bar. One of his most famous cases was that of *The State of Pennsylvania v. The Wheeling and Belmont Bridge Company* (1849-1856), in which, as counsel for the state, he invoked successfully the aid of the Federal government in preventing the construction of a bridge over the Ohio river at Wheeling, Virginia (now West Virginia)—on the ground that the structure would interfere with the navigation of that stream by citizens of Pennsylvania. His large practice before the United States Supreme Court caused him to remove to Washington in 1856. In 1858 he was sent to California by the United States attorney-general as special Federal agent for the settlement of land claims, and he succeeded in breaking up a conspiracy by which the government would have been defrauded of vast tracts of land of almost inestimable value. Before the Civil War Stanton was a Democrat, opposed to slavery, but a firm defender of the constitutional rights of the slaveholders, and was a bitter opponent of Lincoln, whose party he then hated and distrusted. In the reorganization of President Buchanan's cabinet in 1860 Stanton became attorney-general, and he did what he could to strengthen the

weak policy of the president in the last months of his administration. Although he had often violently denounced President Lincoln, the latter thought he saw in Stanton a good war minister, and in January 1862 invited him into his cabinet. In his administration of the war office Stanton was vigorous, rigid, and often harsh, and his peremptory manner, in speech and correspondence, was the cause of considerable friction between the war department and the generals, one of the last and most conspicuous instances being his controversy with General Sherman over the terms of surrender granted to J. E. Johnston's army. But he removed a horde of fraudulent contractors, kept the armies in the field well equipped, and infused energy into procrastinating generals. Not the least of his achievements was the peaceable disbandment of 800,000 soldiers at the end of the war. Remaining in the cabinet of President Andrew Johnson, Stanton exerted all his energies toward thwarting the policies of that executive, especially those related to the reconstruction of the Southern states. He expressed disapproval of the Tenure of Office Act, making the consent of the Senate necessary for the removal of civil officers, and drafted the supplementary act on Reconstruction, passed over the president's veto on the 19th of July 1867. Stanton was finally asked to resign, and on his refusal to do so the president suspended him (Aug. 12) from office and appointed General Grant (who had disapproved of the secretary's removal) secretary *ad interim*. When the Senate, however, under the terms of the Tenure of Office Act, refused (Jan. 13, 1868) to concur in the suspension, Grant left the office and Stanton returned to his duties. On the 21st of February 1868 Johnson appointed General Lorenzo Thomas secretary of war *ad interim*, and ordered Stanton to vacate, but on the same day the Senate upheld Stanton, and by way of reply the secretary made oath to a complaint against Thomas for violating the Tenure of Office Act, and invoked military protection from General Grant, who placed General E. A. Carr in charge of the war department building, while Congress came to Stanton's rescue by impeaching the president, the principal article of impeachment being that based on the removal of Stanton (see JOHNSON, ANDREW). When the impeachment proceedings failed (May 26) Stanton resigned and returned to the practice of law. In 1869 President Grant appointed him a justice of the United States Supreme Court, but he died on the 24th of December, four days after his appointment. Stanton had a violent temper and a sharp tongue, but he was courageous, energetic, thoroughly honest and a genuine patriot.

See George C. Gorham, *Life and Public Services of Edwin M. Stanton* (2 vols., Boston, 1899), and Frank A. Flower, *Edwin McMasters Stanton: The Autocrat of Rebellion, Emancipation, and Reconstruction* (New York, 1905).

STANTON, ELIZABETH CADY (1815-1902), American reformer, was born in Johnstown, New York, on the 12th of November 1815, the daughter of Daniel Cady (1773-1859), a Federalist member of the National House of Representatives in 1815-1817 and a justice of the supreme court of New York state in 1847-1855. She was educated at the Johnstown Academy and at the Troy Female Seminary (now the Emma Willard School), where she graduated in 1832. In 1840 she married Henry Brewster Stanton (1805-1887), a lawyer and journalist, who had been a prominent abolitionist since his student days (1832-1834) in Lane Theological Seminary, and who took her on a wedding journey to London, where he was a delegate to the World's Anti-Slavery Convention. He was a member of the New York Senate in 1850-1851, was one of the founders of the Republican party in New York, and from 1868 until his death was on the staff of the *New York Sun*. Mrs Stanton, who had become intimately acquainted in London with Mrs Lucretia Mott, one of the women delegates barred from the anti-slavery convention, devoted herself to the cause of women's rights. She did much by the circulation of petitions to secure the passage in New York in 1848 of a law giving a married woman property rights; and in the same year on the 19th and 20th of

June in Seneca Falls (*q.v.*), whither the Stantons had removed in 1847 from Boston, was held, chiefly under the leadership of Mrs Mott and Mrs Stanton, the first Woman's Rights Convention. She spoke before the New York legislature on the rights of married women in 1854 and on drunkenness as a ground for divorce in 1860, and for twenty-five years she annually addressed a committee of Congress urging an amendment to the Federal constitution giving certain privileges to women. With Parker Pillsbury (1809-1898) she edited in 1867-1870 *The Revolution*, a radical newspaper, which in 1870 was consolidated with the *Christian Enquirer*. To the *Woman's Tribune* she made important contributions, publishing in it serially parts of the *Woman's Bible* (1895), which she and others prepared, and her personal reminiscences, published in 1898 as *Eighty Years and More*. With Susan B. Anthony and Mathilda Joslyn Gage she wrote *The History of Woman Suffrage* (3 vols., 1880-1886). She was president of the National Woman Suffrage Association in 1865-1890. Her daughter, Harriot Stanton Blatch (1856-), also became prominent as a worker for woman's suffrage.

STANYHURST, RICHARD (1547-1618), English translator of Virgil, was born in Dublin in 1547. His father was recorder of the city, and Speaker of the Irish House of Commons in 1557, 1560 and 1568. Richard was sent in 1563 to University College, Oxford, and took his degree five years later. At Oxford he became intimate with Edmund Campian. After leaving the university he studied law at Furnival's Inn and Lincoln's Inn. He contributed in 1557 to Holinshed's Chronicles "a playne and perfecte description" of Ireland, and a history of the country during the reign of Henry VIII., which were severely criticized in Barnabe Rich's *New Description of Ireland* (1610) as a misrepresentation of Irish affairs written from the English standpoint. After the death of his wife, Janet Barnewall, in 1579, Stanyhurst went to the Netherlands. After his second marriage, which took place before 1585, with Helen Copley, he became active in the Catholic cause. He spent some time in Spain, ostensibly practising as a physician, but his real business seems to have been to keep Philip II. informed of the state of Catholic interest in England. After his wife's death in 1602 he took holy orders, and became chaplain to the archduke Albert in the Netherlands. He never returned to England, and died at Brussels, according to Wood, in 1618. He translated into English *The First Four Bookes of Virgil his Aeneis* (Leiden, 1582), to give practical proof of the feasibility of Gabriel Harvey's theory that classical rules of prosody could be successfully applied to English poetry. The translation is an unconscious burlesque of the original in a jargon arranged in what the writer called hexameters. Thomas Nashe in his preface to Greene's *Menaphon* ridiculed this performance as his "heroicall poetrie, infired . . . with an hexameter furie . . . a patterne whereof I will propounde to your judgments. . . .

Then did he make heaven's vault to rebounde, with rounce robbles hobble

Of ruffe raffe roaring, with thwick thwack thurlery bouncing."

This is a parody, but not a very extravagant one, of Stanyhurst's vocabulary and metrical methods.

His son, William Stanyhurst (1602-1663), was a voluminous writer of Latin religious works, one of which, *Dei immortalis in corpore mortali patientis historia*, was widely popular, and was translated into many languages.

Only two copies of the original Leiden edition of Stanyhurst's translation of Virgil are known to be in existence. In this edition his orthographical cranks are preserved. A reprint in 1583 by Henry Byneman forms the basis of J. Maidment's edition (Edinburgh, 1836), and of Professor E. Arber's reprint (1880), which contains an excellent introduction. Stanyhurst's Latin works include *De rebus in Hibernia gestis* (Antwerp, 1584) and a life of St Patrick (1587).

STANZA (Low Lat. *stantia*, Ital. *stantia* or *stanza*), properly an apartment or storey in a house, the term being hence adopted for literary purposes to denote a complete section, of recurrent form, in a poem. A stanza is a strophe of two or more lines,

usually rhyming, but always recurring, the idea of fixed repetition of form being essential to it. At the close of the 16th century the word *stanza* began to be used with an adjective to designate a particular species, as the "Spenserian stanza," because Spenser had invented that nine-lined form for his *Faerie Queen*; or "Ariosto's stanza" as Drayton described what is now known as *ottava rima*, because Ariosto had written prominently in it. By "stanzaic law" is meant the law which regulates the form and succession of stanzas. The stanza is a modern development of the strophe of the ancients, modified by the requirements of rhyme. (See VERSE; STROPHE; SPENSERIAN STANZA.)

STAPLE, a word which has had a curious and interesting development of meaning. The O. Eng. *stapul* meant a prop or support, and is to be referred to the root seen in step, stamp, &c.; the meaning is also seen in the cognate Du. *stapel*, stocks, pile, Ger. *Staffel*, step of a ladder, &c. The application, in current usage, of the word to a loop of wire or metal with two sharpened points used to fix a pin or bolt, or to fasten wire, &c., to wood, preserves the original sense. A special development in Low German of *stapel* gave the meaning of an orderly arranged heap of goods or stores, hence a store-house in which goods were arranged in a settled order, the idea of firmness or stability being that which runs through the changes of meaning to which the word has been subjected. This Low German word and sense was adapted in Old French as *estaple*, mod. *étape*, and applied to an established market or town, particularly to one which was the centre of the trade in some specific commodity. Thence the word has in modern usage been transferred to a principal or chief commodity or article of consumption.

In English economic history the term "staple" was applied to those towns which were appointed by the king as the centres for the trade of the company of the merchants of the staple. These merchants had a monopoly in the purchase and export of the staple commodities of England, viz. wool, woollens, leather, tin and lead. The merchants of the staple were the origin of all English trading companies. The trade of the staple towns was under the management of a mayor and constables, sometimes appointed by the merchants themselves, sometimes by the mayor of the town and sometimes by the king himself. W. Stubbs (*Const. Hist.* vol. ii.) dates the growth of the system from the reign of Edward I. The monopolies of the staple were from time to time abolished and restored, but they were consolidated by a statute of 1353, the number and place of the staples being fixed, the custom declared, and the rights and privileges of the merchants confirmed. (See C. Gross, *Gild Merchants*; W. Cunningham, *Growth of English Industry and Commerce*.)

STAPLEDON, WALTER DE (1261-1326), English bishop, was born at Annery in North Devon on the 1st of February 1261. He became professor of canon law at Oxford and chaplain to Pope Clement V. and in 1307 was chosen bishop of Exeter. He went on errands to France for both Edward I and Edward II., and attended the councils and parliaments of his time. As lord high treasurer of England, an office to which he was appointed in 1320, the bishop was associated in the popular mind with the misdeeds of Edward II., and consequently, after the king fled before the advancing troops of Queen Isabella, he was murdered in London by the mob on the 15th of October 1326. Stapledon is famous as the founder of Exeter College, Oxford, which originated in Stapledon Hall, established in 1314 by the bishop and his elder brother, Sir Richard Stapledon, a judge of the king's bench. He also contributed very liberally to the rebuilding of his cathedral at Exeter.

STAR, the general term for the luminous bodies seen in the heavens; used also by analogy for star-shaped ornaments (see MEDAL; *Orders and Decorations*) or other objects, and figuratively for persons of conspicuous brilliance. The word is common to many branches of languages: in Teutonic two forms appear, *starre* or *sterre* (cf. Du. *ster*), and *sterne*, or *stern* (cf. Ger. *Stern*, and the Scand. *stjarna*, *stjerna*, &c.). From Lat. *stella*, are derived Span. and Port. *estrella*, and Fr. *étoile*.

The Greek is *ἀστὴρ*, and the Sanskrit *tara*, for *stara*. The ultimate root is unknown, but may be connected with that meaning "to strew," and the word would thus mean the points of light scattered over the heavens. The study of the stars is coeval with the birth of astronomy (see *ASTRONOMY: History*); and among the earliest civilizations beneficent or malevolent influences were assigned to them (see *ASTROLOGY*). With the development of observational astronomy the sidereal universe was arbitrarily divided into areas characterized by special assemblages of stars; these assemblages were named asterisms or constellations, and each received a name suggested by mythological or other figures. The heavenly bodies fall into two classes: (1) the fixed stars, or stars proper, which retain the same relative position with respect to one another; and (2) the planets, which have motions of a distinctly individual character, and appear to wander among the stars proper.

Numerous counts of the number of stars visible to the naked eye have been made; it is doubtful whether more than 2000 can be seen at one time from any position on the earth. When a telescope is employed this number is enormously increased, and still more so with the introduction of photographic methods; with modern appliances more than a hundred million of these objects may be rendered perceptible.

The recognition of stars is primarily dependent on their brightness or "magnitude"; and it is clear that stars admit of classification on this basis. This was attempted by Ptolemy, who termed the brightest stars "of the first magnitude," and the progressively fainter stars of progressively greater magnitude. Ptolemy's classification has been adopted as the basis of the more exactly quantitative modern system. In this system one star is defined to be unit magnitude higher than another if its light is less in the ratio 1:2.512. This ratio is adopted so that a difference of five magnitudes may correspond to a light-ratio of 1:100. This subject is treated in the article *PHOTOMETRY, CELESTIAL*. The faintest stars visible to the naked eye on clear nights are of about the sixth magnitude; exceptionally keen, well-trained eyes and clear moonless nights are necessary for the perception of stars of the seventh magnitude. According to E. Heis the numbers and magnitudes of stars between the north pole and a circle 35° south of the equator are:—

1st mag.	2nd mag.	3rd mag.	4th mag.	5th mag.	6th mag.
14	48	152	313	854	2010

From the value of the light-ratio we can construct a table showing the number of stars of each magnitude which would together give as much light as a first magnitude star, viz.:—

1st mag.	2nd mag.	3rd mag.	4th mag.	5th mag.	6th mag.
1	2½	6	16	40	100

Comparing these figures with the numbers of stars of each magnitude we notice that the total light emitted by all the stars of a given magnitude is fairly constant.

Variable Stars.—Although the majority of the stars are unchanging in magnitude, there are many exceptions. Stars whose brightness fluctuates are called *variable stars*. The number of known objects of this class is being added to rapidly, and now amounts to over 4000. The systematic search made at Harvard Observatory is responsible for a large proportion of the recent discoveries. Many of these stars seem to vary quite irregularly; the changes of magnitude do not recur in any orderly way. Others, however, are periodic, that is to say, the sequence of changes is repeated at regular intervals, and it is thus possible to predict when the maximum and minimum brightness will occur. Of the periodic variable stars, the lengths of the periods range from 3 hours 12 minutes, which is the shortest yet determined, to 610 days, the longest. When statistics of the lengths of the periods are collected, it is at once

noticed that they fall into two fairly well-marked classes. The following table, based on S. C. Chandler's "Third Catalogue" (*Astronomical Journal*, vol. xvi.), supplemented by A. W. Roberts's list of southern variables (*ibid.* vol. xxi.), classifies the lengths of the periods of 330 stars.

Period in days	0 to 50	50 to 100	100 to 150	150 to 200	200 to 250	250 to 300	300 to 350	350 to 400	400 to 450	450 to 500	500 to 550	550 to 600	600 to 650
Stars	73	8	12	22	41	45	49	50	20	6	1	2	1

It will be noticed that there are very few periods between 50 and 150 days, that a considerable number are less than 50 days (actually a large majority of these are less than 10 days), and that from 150 days upwards the number of periods increases to a maximum at about 350 days and then diminishes. We thus recognize two classes of variables, of which (1) the *long-period variables* have periods ranging in general from 150 to 450 days, though a few are outside these limits, and (2) the *short-period variables* have periods less than 50 days (in the majority of cases less than 10 days). There is some over-lapping of these two classes as regards length of period, and it is doubtful in which class some stars, whose periods are between 10 days and 150 days, should be placed; but the two classes are quite distinct physically, and the variability depends on entirely different causes.

Long-period Variables.—The best known and typical star of this class is Mira or α Ceti. This was the first variable star to be discovered, having been noticed in 1596 by David Fabricius, who thought it was a new star (a *Nova*). The varying brightness, ranging from the ninth to the second magnitude, was recognized in 1639 by John Phocylides Holwarda, and in 1667 Ismael Boulliau (1605-1694) established a periodicity of 333 days. Although the periodic outbursts of light have taken place without intermission during the two and a half centuries that the star has been under observation, they are somewhat irregular. The different maxima differ considerably in brightness; thus in 1906 (the brightest maximum since 1779) the second magnitude was reached, but in other years (as in 1868) it has failed to reach the fifth magnitude. The minima likewise are variable, but only slightly so. Also, the period varies somewhat; the maxima occur sometimes early and sometimes late as compared with the mean period, but the difference is never more than forty days. No general law has been discovered governing these irregularities. The change of magnitude takes place gradually, but the rise to maximum brilliance is rather more rapid than the decline. Spectroscopic observation shows that the increased light accompanies an actual physical change or conflagration in the star. The spectrum is of the third type with bright hydrogen emission lines (see below, *Spectra of Stars*). Stars having this type of spectrum are always variable, and a large proportion of the more recently discovered long-period variables have been detected through their characteristic spectrum.

χ Cygni is another star of this class, remarkable for its range of magnitude. In its period of 406 days it fluctuates between the thirteenth and the fourth magnitudes; thus at maximum it emits 4000 times as much light as at minimum. The mean range of 75 long-period variables observed at Harvard (*Harvard Annals*, vol. lvii.) was five magnitudes. Another variable, R Normae¹ is of interest as having a pronounced double maximum in each period.

It is natural to compare the periodic outbursts occurring in these stars with the outbursts of activity on the sun, which have a period of about eleven years. In both cases no extraneous cause can be assigned; the period seems to be inherent in the star itself and not to be determined by the revolution of a satellite (no variability of the line-of-sight motion of Mira has been found, so that it is probably not accompanied by any large companion). In both cases the rise to a maximum is more rapid than the decline to a minimum, and in fact some of the minor peculiarities of the sunspot curve are closely imitated by the light-curves of variable stars. H. H. Turner has analysed harmonically the light-curves of a number of long-period variables, and has shown that when they are arranged in a natural series the sun takes its place in the series near, but not actually at, one end. It is necessary to suppose, if the analogy is to hold, that the sun is brightest when sunspots and faculae are most numerous; this is by no means unlikely. On the other hand, the variations in the light of the sun must be very small compared with the enormous fluctuations in the light of variable stars. Moreover, the solar period (11 years) is far outside the limits of the periods of

¹ Variable stars (except those sufficiently bright to have received special names) are denoted by the capital letters R to Z followed by the name of the constellation. The first nine variables recognized in each constellation are denoted by single letters, after which combinations RR, RS, &c., are used.

variables. It is therefore perhaps misleading actually to class the sun with them; but it seems highly probable that whatever cause produces the periodic outbursts of spots and faculae on our sun differs only in degree from that which, in stars under a different physical condition of pressure and temperature, results in the gigantic conflagrations which we have been considering.

Short-period Variables.—Besides the shortness of the period these variables possess other characteristics which differentiate them from the long-period variables. The range of variation is much smaller, the difference between maximum and minimum rarely exceeding two magnitudes. Also the variations recur with perfect regularity. There is reason to believe that all the stars of this class are binary systems, and that the variations of brightness are determined by the different aspects presented by the two component stars during the period of revolution. There are several well-marked varieties of short-period variables; the most important are typified by the stars Algol, β Lyrae, ζ Geminorum and δ Cephei.

In the Algol variables one of the component stars is dark (that is to say, dark in comparison with the other), and once in each revolution, passing between us and the bright component, partially hides it. This class of variables is accordingly characterized by the fact that for the greater part of the period the star shines steadily with its maximum brilliancy, but fades away for a short time during each period. The variability of Algol (β Persei) was discovered in 1783 by John Goodricke (1764-1786), but, judging from its name, which signifies "the demon," it seems possible that its peculiarity may have been known to the ancient astronomers. Algol is ordinarily of magnitude 2.3, but once in a period of 2^d. 20^h. 49^m. it suffers partial eclipse and fades to magnitude 3.5. The duration of each eclipse is 9 $\frac{1}{4}$ hours. Ever since the variability of Algol was observed it was suspected to be due to a partial eclipse of the star by a dark body nearly as large as itself revolving round it; but the explanation remained merely a surmise until K. H. Vogel of Potsdam, by repeated measurements of the motion of Algol in the line of sight, showed that the star is always receding from us before the loss of light and approaching us afterwards. This leaves no room for doubt that an invisible companion passes between us and Algol about the time the diminution of light takes place, and so proves the correctness of the explanation. The dimensions of the Algol system have been calculated, with the result that Algol appears to have a diameter of 1,000,000 m. and its companion a diameter of 830,000 m.; the distance between their centres cannot be deduced without making certain doubtful assumptions, but may be about 3,000,000 m. When this distance is compared with those prevailing in the solar system, it seems an extraordinarily small separation between two such large bodies; we shall, however, presently come across systems in which the two components revolve almost or actually in contact. About 56 Algol variables were known in 1907; the variables of this class are the most difficult to detect, for the short period of obscuration may easily escape notice unless the star is watched continuously.

The variable star β Lyrae, which is typical of another class, was also discovered by Goodricke in 1784. It differs from the Algol type in having two unequal minima separated by two equal maxima. Thus in a period of 12^d. 22^h. from a maximum of magnitude 3.4 it falls to 3.9, rises again to 3.4, then falls to 4.5 and returns to magnitude 3.4. The changes take place continuously, so that there is no period of steady luminosity. The hypothesis of G. W. Myers (*Astrophysical Journal*, vol. vii.) affords at least a partial explanation of the phenomena. Two stars are supposed to revolve about one another nearly or actually in contact. In such a system the tidal forces must be very great, and under their influence the stars will not be spherical, but will be elongated in the direction of the line joining their centres. When the line of centres is at right angles to our line of sight, the stars present to us their greatest apparent surface, and therefore send us the maximum light. This happens twice in a revolution. As the line of centres becomes more oblique, the surface is seen more and more foreshortened and the brilliancy diminishes continuously. Supposing that the two stars are of unequal surface brilliancy, the magnitude at minimum will depend on which of the two stars is the nearer to us, accordingly there are two unequal minima in each revolution. When the two stars are of equal brilliancy the minima are equal; this is the case in variables of the ζ Geminorum type. When the orbits are eccentric, the tidal disturbance varying with the distance between the two components will probably cause changes in their absolute brilliancy; the variation due to change in the aspect of the system presented to us may thus be supplemented by a real intrinsic variation, both, however, being regulated by the orbital motion. A large eccentricity also produces an unsymmetrical light variation, the minimum occurring at a time not midway between two maxima; stars of this character are called Cepheid variables, after the typical star δ Cephei. All the best-known short-period variables have been proved to be binary systems spectroscopically, and to have periods corresponding with the period of light variation, so that to this extent the hypothesis we have described is well founded; but it is doubtful if it is the whole explanation. S. Albrecht has shown that, of the 10 members of the δ Cephei class for which both the orbits and the light-variations are thoroughly known, the maximum light always occurs approximately at the time when the brighter

component is approaching us most rapidly; this relation, which seems to be well established, is a most perplexing one.

No hard and fast physical distinction can be drawn between the various classes of short-period variables; as the distance between the components diminishes the Algol variable merges insensibly into the β Lyrae type. The latter, on the other hand, is perhaps connected by insensible gradations with the ordinary simple star. Sir G. H. Darwin and H. Poincaré have investigated the forms taken up by rotating masses of fluid. When the angular momentum is too great for the usual spheroidal form to persist, this gives place to an ellipsoid with three unequal axes; this is succeeded by a pear-shaped form. The subsequent sequence of events cannot be traced with certainty, but it seems likely that the pear-shaped form is succeeded by an hour-glass-shaped form, which finally separates at the neck into two masses of fluid. Ellipsoidal, pear-shaped or hour-glass-shaped stars would all give rise to the phenomena of a short-period variable, and doubtless examples of these intermediate forms exist.

Certain clusters contain a remarkable number of short-period variables. Thus the cluster Messier 5 was found at Harvard to contain 185 variables out of 900 stars examined. Solon I. Bailey, on examining 63 of them, found that with one exception their periods lay between 10^h. 48^m. and 14^h. 59^m., and the range of variation between 0.7 and 1.4 magnitudes. Moreover, the light-curves were all of a uniform type, a distinctive feature of "cluster variables" being the rapid rise to a maximum and slow decline.

Temporary Stars or Novas.—From time to time a star, hitherto too faint to be noticeable, blazes out and becomes a prominent object, and then slowly fades into obscurity. According to Miss Agnes Clerke there are records of ten such stars appearing between 134 B.C. and A.D. 1500. Since that time nine novas have appeared, which have attained naked-eye visibility; and in recent years a number of very faint objects of the same class have been detected. The brightest star of all these was the famous "Tycho's star" in Cassiopeia. It was first observed on the 6th of November 1572 by Wolfgang Schuler. In five days its light had reached the first magnitude, and a little later it even equalled Venus in brilliancy and was observed in full daylight. After three weeks it began to decline, but the star did not finally disappear until March 1574. "Kepler's" nova in Ophiuchus broke out in 1604 and attained a brilliancy greater than that of Jupiter; it likewise gradually waned, and disappeared after about fifteen months. For nearly three centuries after these two remarkable stars no nova attained a brilliancy greater than that of the ordinary stars, until in 1901 Nova Persei appeared. This star was discovered by T. D. Anderson on the 21st-22nd of February, its magnitude at that time being 2.7. In the next two days it reached zero magnitude, thus becoming the brightest star in the northern heavens, but after that it rapidly decreased. On the 15th of March it was of the fourth magnitude; during the next three months it oscillated many times between magnitudes 4 and .6, and by the end of the year it had faded to the seventh magnitude. In July 1903 it was of the twelfth magnitude, and its light has remained constant since then. In the case of this star there is evidence that the outburst must have been extremely rapid, for the region where Nova Persei appeared had been photographed repeatedly at Harvard during February, and in particular no trace of the star was found on a plate taken on the 19th of February, which showed eleventh magnitude stars. Thus a rise of at least eight magnitudes in two days must have occurred.

On the 21st of August, six months after the discovery of Nova Persei, C. Flammarion and E. M. Antoniadi discovered that a nebula surrounded it. Subsequent photographs showed that this nebula, which consisted mainly of two incomplete rings of nebulosity, was expanding outwards at the rate of from 2" to 3" per day. This expansion continued at the same rate until the following year. Spectroscopic examination had already suggested prodigious velocities of the order of 1000 m. per second in the gases of the atmosphere of the nova; but the velocity implied by this expansion of the nebula was unprecedented and comparable only with the velocity of light. The suggestion was made, and seems to be the true explanation, that what was actually witnessed was the wave of light due to the outburst of the nova, spreading outwards with its velocity of 186,000 m. per second, and rendering luminous as it reached them the particles of a pre-existing nebula, whose own light had been too faint to be visible.

Two possible explanations of the phenomena of temporary stars have been held. The collision theory supposes that the outburst is the result of a collision between two stars or between a star and a swarm of meteoric or nebulous matter. The explosion theory regards the outburst as similar to the outbreak of activity of a long-period variable. Probably the latter hypothesis is the one more generally accepted now. There is one unique star, which is of special interest as occupying rather an intermediate position between a nova and a long-period variable. This is the southern star η Argus (sometimes called η Carinae). From 1750 until about 1832 it seems to have varied irregularly between the second and the fourth magnitudes. For the next ten years it slowly increased (though with slight check), and in 1843 was nearly as bright as Sirius; since then it has slowly faded, but it was not till 1869 that it ceased to be visible to the naked eye. It is now about magnitude 7.5. The slowness both of the rise and decline is in great contrast with the

progress of a nova. η Argus is surrounded by a nebula, the famous "Keyhole nebula"; in this respect it resembles Nova Persei.

System of Stars.—On examining the stars telescopically, many which appear single to the unaided eye are found to be composed of two or more stars very close together. In some cases the proximity is only apparent; one star may be really at a vast distance behind the other, but, being in the same line of vision, they appear close together. In many cases, however, two or more stars are really connected, and their distance from one another is (from the astronomical standpoint) small. The evidence of this connexion is of two kinds. In a number of cases measures of the relative positions of the two stars, continued for many years, have shown that they are revolving about a common centre; when this is so there can be no doubt that they form a binary system, and that the two components move in elliptic orbits about the common centre of mass, controlled by their mutual gravitation. But these cases form a very small proportion of the total number of double stars. In many other double stars the two components have very nearly the same proper motion. Unless this is a mere coincidence, it implies that the two stars are nearly at the same distance from us. For otherwise, if they had from some unknown cause the same *actual* motion, the *apparent* motion in arc would be different. We can therefore infer that the two stars are really comparatively close together, and, moreover, since they have the same proper motion, that they remain close together. They may thus be fairly regarded as constituting a binary system, though the gravitational attraction between some of the wider pairs must be very weak.

Several double stars were observed during the 17th century, ζ Ursae Majoris being the first on record. In 1784 Christian Mayer published a catalogue of all the double stars then known, which contained 89 pairs. Between 1825 and 1827 F. G. W. Struve at Dorpat examined 120,000 stars, and found 3112 double stars whose distance apart did not exceed $32''$. W. S. Burnham's *General Catalogue of Double Stars* (1907) contains 13,655 pairs north of declination -31° . Undoubtedly a large number of these are only optical pairs, but mere considerations of probability show that the majority must be physically connected. For only 88 of them has it been possible as yet to deduce a period, and at least half even of these periods are very doubtful. The rates of motion are so slow that many centuries' observations are needed to determine the orbit.

The most rapid visual binary (leaving aside Capella for the moment) is δ Equulei, which completes a revolution in 5.7 years. Next to it come 13 Ceti, period 7.4 years, and κ Pegasi, period 11.4 years. From a list of systems with determined periods given by Aitken (*Lick Observatory Bulletin*, No. 84) there are 20 with periods less than 50 years, and 16 between 50 and 100 years. δ Equulei, 13 Ceti and κ Pegasi are all extremely close pairs, and can only be resolved with the most powerful instruments. Capella, whose period is only 104 days, was discovered to be double by means of the spectroscope, but has since been measured frequently as a visual binary at Greenwich. With the best instruments a star can be distinguished as double when the separation of the two components is a little less than $0.1''$. From the very few orbits that have as yet been determined one interesting result has been arrived at. Most of the orbits are remarkably eccentric ellipses, the average eccentricity being about 0.5. There is a very striking relation between the eccentricity and the period of a system; in general the binaries of longest period have the greatest eccentricities. The relation applies not only to the visual but to the spectroscopic binaries; these, having shorter periods than the visual binaries, have generally quite small eccentricities. Another interesting feature is that, where the two components differ in brightness, the fainter component is often the one possessing the greater mass.

Far within the limit to which telescopic vision can extend binary systems are now being found by the spectroscope. These systems appear as a connecting link between short-period variable stars on the one hand and telescopic double stars on the other. Stars of the class to which the Algol type of variables belongs will appear to us to vary only in the exceptional case when the plane of the orbit passes so near our sun that one body appears to pass over the other and so causes an eclipse. Except when the line of sight is perpendicular to the plane of the orbit, the revolution of the two bodies will result in a periodic variation of the motion in the line of sight. Such a variation can be detected by the spectroscope. If both the bodies are luminous, especially if they do not differ much in brilliancy, the motion of revolution is shown by a periodic doubling of the lines of the spectrum; when one body is moving towards us and the other away their opposite lines are displaced (according to Doppler's principle) in opposite directions, so that all the lines strong enough to appear in both spectra appear double; when the two bodies are in

conjunction, and therefore moving transversely, their spectra are merged into one and show nothing unusual. More usually, however, only one component is sufficiently luminous for its spectrum to appear; its orbital motion is then detected by a periodic change in the absolute displacement of its spectral lines. Up to 1905, 140 spectroscopic binaries had been discovered; a list of these is given in the *Lick Observatory Bulletin*, no. 79. Details of the calculated orbits of 63 spectroscopic binaries are given in *Publications of the Alleghany Observatory*, vol. i. No. 21. According to W. W. Campbell one star in every seven examined is binary.

A continuous gradation can be traced from the most widely separated visual binaries, whose periods are many thousand years, to spectroscopic binaries, Algol and β Lyrae variables, whose periods are a few hours and whose components may even be in contact, and from these to dumb-bell shaped stars and finally to ordinary single stars. It is a legitimate speculation to suppose that these in the reverse order are the stages in the evolution of a double star. As the simple star radiates heat and contracts, it retains its angular momentum; when this is too great for the spheroidal form to persist, the star may ultimately separate into two components, which are driven farther and farther apart by their mutual tides. Tidal action also accounts for the progressively increasing eccentricities of the orbits, already referred to. This theory of the genesis of double-stars by fission is not, however, universally accepted; in particular objections have been urged by T. C. Chamberlin and F. R. Moulton. It is true that rotational instability alone is not competent to explain the separation into two components; but the existence of gravitational instability, pointed out by J. H. Jeans, enables the principal difficulties of the theory to be surmounted. Whilst there is thus no well-defined lower limit to the dimensions of systems of two stars, on the other hand we cannot set any superior limit either to the number of stars which shall form a system or to the dimensions of that system. No star is altogether removed from the attractions of its neighbours, and there are cases where some sort of connexion seems to relate stars which are widely separated in space. A curious case of this sort is that of the five stars β , γ , δ , ϵ and ζ of Ursa Major. These have proper motions which are almost identical in amount and in direction. The agreement is too close to be dismissed as a mere coincidence, and it is confirmed by a corresponding agreement of their radial motions determined by the spectroscope; and yet, seeing that β and ζ Ursae Majoris are 19° apart, these two stars must be distant from each other at least one-third of the distance of each from the sun; thus the members of this singular group are separated by the ordinary stellar distances, and probably each has neighbours, not belonging to the system, which are closer to it than the other four stars of the group. Further, E. Hertzsprung has shown that Sirius also belongs to this same system and shares its motion, notwithstanding that it is in a nearly opposite part of the sky. It is difficult to understand what may be the connexion between stars so widely separated; from the equality of their motions they must have been widely separated for a very long period.

Of multiple stars the most famous is θ Orionis, situated near the densest part of the great Orion nebula. It consists of four principal stars and two faint companions. From the more complex systems of this kind, we pass to the consideration of star-clusters, which are systems of stars in which the components are very numerous. When examined with a telescope of power insufficient to separate the individual stars, a cluster appears like a nebula. The "beehive cluster" Praesepe in Cancer is an example of an easily resolved cluster composed of fairly bright stars. The great cluster in Hercules (Messier 13), on the other hand, requires the highest telescope power for its complete resolution into stars. Doubtless with improved telescopes many more apparent nebulae would be shown to be clusters, but there are certainly many nebulae which are otherwise constituted. Many of the clusters are of very irregular forms, either showing no well-marked centre of condensation, or else condensed in streams along certain lines. There is, however, a well-marked type to which many of the richest clusters belong; these are the *globular clusters*. They have a symmetrical circular shape, the condensation increasing rapidly towards the centre. The Hercules cluster is of this form; another example is ω Centauri, in which over 6000 stars have been counted, comprised within a circle of about $40'$ diameter. These clusters present many unsolved problems. Thus Perrine, from an examination of ten globular clusters (including Messier 13 and ω Centauri), has found in each case that the stars can be separated into two classes of magnitudes. About one-third of the stars are between magnitudes 11 and 13, and the remaining two-thirds are between magnitudes 15.5 and 16.5. Stars of magnitudes intermediate between these two groups are almost entirely absent. Thus each cluster seems to consist of two kinds of stars, which we may distinguish as bright and faint; the bright stars are all approximately of one standard size, and the faint stars of another standard size and brightness.

The question of the stability of these clusters is one of much interest. The mutual gravitation of a large number of stars crowded in a comparatively small space must be considerable, and the individual stars must move in irregular orbits under their mutual attractions. It does not seem probable, however, that they can escape the fate of ultimately condensing into one confused mass. If this surmise be correct, we are witnessing in clusters a counter-process of

evolution to that which is taking place in double stars; the latter appear to be separating from a single original mass and the former condensing into one.

Colours and Spectra of Stars.—The brighter stars show a marked variety of colour in their light, and with the aid of a telescope a still greater diversity is noticeable. It is,

Colours. however, only the red stars that form a clearly marked class by themselves. For purposes of precise scientific investigation the study of spectra is generally more suitable than the vague and unsatisfactory estimates of colour, which differ with different observers. Of the first magnitude red stars Antares is the most deeply coloured, Betelgeux, Aldebaran and Arcturus being successively less conspicuously red. Systematic study of red stars dates from the publication in 1866 of Schjellerup's *Catalogue*, containing a list of 280 of them.

The two components of double stars often exhibit complementary colours. As a rule contrasted colours are shown by pairs having a bright and a faint component which are relatively wide apart; brilliant white stars frequently have a blue attendant—this is instanced in the case of Regulus and Rigel. That the effect is due to a real difference in the character of the light from the two components has been shown by spectrum analysis, but it is probably exaggerated by contrast.

The occurrence of change, either periodic or irregular, in the colour of individual stars, has been suspected by many observers; but such a colour-variability is necessarily very difficult to establish. A possible change of colour in the case of Sirius is noteworthy. In modern times Sirius has always been a typical white or bluish-white star, but a number of classical writers refer to it as red or fiery. There is perhaps room for doubt as to the precise significance of the words used; but the fact that Ptolemy classes Sirius with Antares, Aldebaran, Arcturus, Betelgeux and Procyon as "fiery red" (*ὑπόκισσρος*) as compared with all the other bright stars which are "yellow" (*ξάνθοι*) seems almost conclusive that Sirius was then a redstar.

When examined with the spectroscope the light of the stars is found to resemble generally that of the sun. The spectrum consists of a continuous band of light crossed by a greater or

Spectra of Stars.

less number of dark absorption lines or bands. As in the case of the sun, this indicates an incandescent body which might be solid, liquid, or a not too rare gas, surrounded by and seen through an atmosphere of somewhat cooler gases and vapours; it is this cooler envelope whose nature the spectroscope reveals to us, and in it the presence of many terrestrial elements has been detected by identifying in the spectrum their characteristic absorption lines. Stellar spectroscopy dates from 1862, when Sir William Huggins (with a small slit-spectroscope attached to an 8-in. telescope) measured the positions of the chief lines in the spectra of about forty stars. In 1876 he successfully applied photography to the study of the ultra-violet region of stellar spectra. Various schemes of classification of spectra have been used. The earliest is that due to A. Secchi (1863–1867) who distinguished four "types"; subsequent research, whilst slightly modifying, has in the main confirmed this classification. Secchi's Type I. or "Sirian" type includes most of the bright white stars, such as Sirius, Vega, Rigel, &c.; it is characterized by strong broad hydrogen lines, which are often the only absorption lines visible. Type II. includes the "Solar" stars, as Capella, Arcturus, Procyon, Aldebaran, their spectra are similar to that of the sun, being crossed by very numerous fine lines, mostly due to vapours of metals. The great majority of the visible stars belong to these first two types. Type III. or "Antarian" stars are of a reddish colour, such as Antares, Betelgeux, Mira, and many of the long-period variables. The spectrum, which closely resembles that of a sunspot, is marked by flutings or bands of lines sharply bounded on the violet side and fading off towards the red. It has been shown by A. Fowler that these flutings are due to titanium oxide; this probably indicates a relatively low temperature, for at a high temperature all compounds would be dissociated. Type IV. also consists of red stars with banded spectra, but the bands differ in arrangement and appearance from those in the third type, and are sharply bounded on the red side. These stars are also believed to have a comparatively low surface temperature, and the bands are attributed to the presence of compounds of carbon. About 250 Type IV. stars are known, but none conspicuous; 19 Piscium, the brightest, is of magnitude 5.5.

Other classifications which are extensively used are those respectively of K. H. Vogel, J. N. Lockyer and the Draper Catalogue. The divergences depend mainly on the different views taken by their authors as to the order of stellar evolution. Apart from these considerations, the chief modification in the classification introduced by more recent investigators has been to separate Secchi's Type I. into two divisions, called *helium* and *hydrogen* stars respectively. The former are often called "Orion" stars, as all the brighter stars in that constellation with the exception of Betelgeux belong to the helium type. Helium stars are generally considered to be the hottest and most luminous (in proportion to size) of all the stars. Type II. is now subdivided into "Procyon," "Solar" and "Arcturian" stars. The "Procyon"

or *calcium* stars form a transition between Type I. and Type II. proper, and show the lines of calcium besides those of hydrogen. An important variety of Type III. spectra has been recognized, in which, as well as the usual absorption bands, bright emission lines of hydrogen appear; stars having this particular spectrum are always variable. Finally, a fifth type has been added, the Wolf-Rayet stars; these show a spectrum crossed by the usual dark lines and bands, but showing also bright emission bands of blue and yellow light. About 100 Wolf-Rayet stars are known, of which γ Velorum is the brightest; they are confined to the region of the Milky Way and the Magellanic Clouds. (See PLANET.)

Evolution of Stars.—The absence of the distinctive lines of an element in the spectrum does not by any means signify that that element is wanting or scarce in the star. The spectroscope only yields information about the thin outer envelope of the star; and even here elements may be present which do not reveal themselves, for the spectrum shown depends very greatly on the temperature and pressure. Stars of the different types are therefore not necessarily of different chemical constitution, but rather are in different physical conditions, and it is generally believed that every star in the course of its existence passes through stages corresponding to all (or most of) the different types. The stars are known to be continually losing enormous quantities of energy by radiating their heat into space. Ordinary solid or liquid masses would cool very rapidly from this cause and would soon cease to shine. But a globe of gaseous matter under similar conditions will continually contract in volume, and in so doing transforms potential energy into heat. It was shown by Homer Lane that a mass of gas held in equilibrium by the mutual gravitation of its parts actually grows hotter through radiating heat; the heat gained by the resulting contraction more than counterbalances that lost by radiation. Thus in the first stage of a star's history we find it gradually condensing from a highly diffused gaseous state, and growing hotter as it does so. But this cannot continue indefinitely; when the density is too great the matter ceases to behave as a true gas, and the contraction is insufficient to maintain the heat. Thus in the second stage the star is still contracting, but its temperature is decreasing. The greatest temperature attained is not the same for all stars, but depends on the mass of the star. It is, however, important to bear in mind that Lane's theory is concerned with the temperature of the body of the star; the temperature of the photosphere and absorbing layers, with which we are chiefly concerned, does not necessarily follow the same law. It depends on the rapidity with which convection currents can supply heat from the interior to replace that radiated, and on a number of other nicely balanced circumstances which cannot well be calculated.

Conflicting opinions are held as to the various steps in the process of evolution and the order in which the various types succeed one another, but the following perhaps represents in the main the most generally accepted view. Starting from a widely diffused nebula, more or less uniform, we find that, in consequence of gravitational instability, it will tend to condense about a number of nuclei. Jeans has even estimated theoretically the average distances apart of these nuclei, and has shown that it agrees in order of magnitude with the observed distances of the stars from one another (*Astro-physical Journal*, vol. xxii.). As the first condensation takes place, the resulting development of heat causes the hydrogen, helium and light gases to be expelled. This may explain the existence of gaseous nebulae, which are often found intimately associated with star-clusters, a good example being the nebulosity surrounding the Pleiades. As the nuclei grow by the attraction of matter they begin to be capable of retaining the lighter gases, and atmospheres of hydrogen and helium are formed. The temperature of the photosphere at this stage has reached a maximum, and the star is now of the helium type. Then follows a gradual absorption of first the helium and then the hydrogen, the photosphere grows continually cooler, and the star passes successively through the stages exemplified by Sirius, Procyon, the Sun, Arcturus and Antares. Some authorities, however, consider the Antarian (Type III.) stars to be in a very early stage of development and to precede the helium stars in the order of evolution; in that case they are in the stage when the temperature is still rising. Type IV. (carbon) stars are placed last in the series by all authorities; they seem, however, to follow more directly the solar stars than the Antarian. If the latter are considered to be in an early state this presents no difficulty; but if both Antarian and carbon stars are held to be evolved from solar stars, we may consider them to be, not successive, but parallel stages of development, the chemical constitution of the star deciding whether it shall pass into the third or fourth type. The Wolf-Rayet stars must probably be assigned to the earliest period of evolution; they are perhaps semi-nebulous. In this connexion it may be noted that the spectrum of Nova Persei, after passing through a stage in which it resembled that of a planetary nebula, has now become of the Wolf-Rayet type.

Density of Stars.—Interesting light is thrown on the question of the physical state of the stars by some evidence which we possess as to their densities. The mean density of the sun is about $1\frac{1}{4}$ times that of water; but many of the stars, especially the brighter ones, have much lower densities and must be in a very diffused state. We have necessarily to turn to binary systems for our data. When

the orbit and periodic time is known, and also the parallax, the masses of the stars can be found. (If only the relative orbit is known, the sum of the masses can be determined; but if absolute positions of one component have been observed, both masses can be determined separately.) But even when, as in most cases, the parallax is unknown or uncertain, the ratio of the brightness to the mass can be accurately found. Thus it is found that Procyon gives about three times as much light as the sun in proportion to its mass, Sirius about sixteen times, and ζ Orionis more than ten thousand times. In these cases evidently either the star has a greater-intrinsic brilliancy per square mile of surface than the sun, or is less dense. Probably both causes contribute. The phenomena of long-period variables show that the surface brilliancy may vary very greatly, even in the same star. The Orion stars have the highest temperature of all and have admittedly the greatest surface-luminosity, but the extreme brilliancy of ζ Orionis in proportion to its mass must be mainly due to a small density. For the Algol variables it is possible to form even more direct calculations of the density, for from the duration of the eclipse an approximate estimate of the size of the star may be made. A. W. Roberts concluded in this way that the average density of the Algol variables and their eclipsing companions is about one-eighth that of the sun. For β Lyrae G. W. Myers found a density a little less than that of air; the density is certainly small, but J. H. Jeans has shown that for this type of star the argument is open to theoretical objection, so that Myers's result cannot be accepted.

There are many stars, however, of which the brightness is less than that of the sun in proportion to the mass. Thus the faint companion of Sirius is of nearly the same mass as the sun, but gives only $\frac{1}{4000}$ of its light. In this case the companion, being about half the mass of Sirius itself, has probably cooled more rapidly, and on that account emits much less light. T. Lewis, however, has shown that the fainter component of the binary system is often the more massive. It may be that these fainter components are still in the stage when the temperature is rising, and the luminosity is as yet comparatively small; but it is not impossible that the massive stars (owing to their greater gravitation) pass through the earlier stages of evolution more rapidly than the smaller stars.

Distances and Parallaxes of the Stars.—As the earth traverses annually its path around the sun, and passes from one part of its orbit to another, the direction in which a fixed star is seen changes. In fact the relative positions are the same as if the earth remained fixed and the star described an orbit equal to that of the earth, but with the displacement always exactly reversed. The star thus appears to describe a small ellipse in the sky, and the nearer the star, the larger will this ellipse appear. The greatest displacement of the star from its mean position (the semi-axis major of the ellipse) is called its parallax. If π be the parallax, and R the radius of the earth's orbit, the distance of the star is $R/\sin \pi$. The determination of stellar parallaxes is a matter of great difficulty on account of the minuteness of the angle to be measured, for in no case does the parallax amount to 1"; moreover, there is always an added difficulty in determining an annual change of position, for seasonal instrumental changes are liable to give rise to a spurious effect which will also have an annual period. Very special precautions are required to eliminate instrumental error before we can compare observations, say, of a star on the meridian in winter at 6 p.m. with observations of the same star in summer on the meridian at 6 a.m. The first determination of a stellar parallax was made by F. W. Bessel in the years 1837-1840, using a heliometer. He chose for his purpose the binary star 61 Cygni, which was the star with the most rapid apparent motion then known and therefore likely to be fairly near us, although only of the sixth magnitude. He found for it a parallax of 0.35" a value which agrees well with more modern determinations. T. Henderson at the Cape of Good Hope measured the parallax of α Centauri, but his resulting value 1" was considerably too high. More accurate determinations have shown that this star, which is the third brightest star in the heavens, has a parallax of 0.75", this indicates that its distance is 25,000,000,000 m. So far as is known α Centauri is our nearest neighbour.

Formerly attempts were made to determine parallaxes by measuring changes in the absolute right ascensions and declinations of the stars from observations with the meridian circle. The results were, however, always untrustworthy owing to annual and diurnal changes in the instrument. Nowadays the determination is more usually made by measuring the displacement of the star relatively to the stars surrounding it. Hitherto the heliometer has been most extensively used for this purpose, D. Gill, W. L. Elkin, B. E. A. Peter and others have made their important determinations with

it. The photographic method, however, now appears to yield results of equal precision, and is likely to be used very largely in the future. The quantity determined by these methods is the relative parallax between the star measured and the stars with which it is compared. To obtain the true parallax, the mean parallax of the comparison stars must be added to this relative parallax. It is, however, fair to assume that the comparison stars will rarely have a parallax as great as 0.01"; for it must be remembered that it is quite the exception for a star taken at random to have an appreciable parallax; particularly if a star has an ordinarily small proper motion, it is likely to be very distant. Still exceptional cases will occur where a comparison star is even nearer than the principal star; it is one of the advantages of the photographic method that it involves the use of a considerable number of comparison stars, whereas in the heliometric method usually only two stars, chosen symmetrically one on each side of the principal star, are used.

In the table are collected the parallaxes and other data of all stars for which the most probable value of the parallax exceeds 0.20". Although much work has been done recently in measuring parallaxes, the number of stars included in such a list has not been increased, but rather has been considerably diminished; many large parallaxes, which were formerly provisionally accepted, have been reduced on revision. It cannot be too strongly emphasized that many of these determinations are subject to a large probable error, or even altogether uncertain. For one or two of the more famous stars such as α Centauri the probable error is less than ± 0.01 "; but for others in the list it ranges up to ± 0.05 ". To convert parallaxes into distance we may remember that a parallax of 1" denotes a distance of 18 $\frac{1}{2}$ billion miles, or 206,000 times the distance of the sun from the earth. A parallax of 0.01" denotes a distance a hundred times as great, and so on, the distance and parallax being inversely proportional. A unit of length, which is often used in measuring stellar distances, is the *light year* or distance that light travels in a year; it is rather less than six billion miles.

Stars with Large Parallax.

Star.	Position R.A. Dec.	Mag.	Annual Proper Motion.	Parallax.	Authority for Parallax
	h. m. sec.				
Gr. 34 . . .	0 13 +43	8.1	2.8	.27	R, Sc, C
τ Ceti . . .	1 39 -16	3.7	1.9	.31	S
C. Z. 5h 243.	5 8 -45	8.5	8.7	.31	S
Sirius . . .	6 41 -17	-1.4	1.3	.38	G, E
Procyon . .	7 34 + 5	0.5	1.2	.30	A, E
Ll. 21185 . .	10 58 +37	7.6	4.8	.37	R, C
Ll. 21258 . .	11 0 +44	8.5	4.4	.21	A, k, K, R
Ll. 25372 . .	13 40 +15	8.5	2.3	.20	R, E
α Centauri .	14 33 -60	0.2	3.7	.76	G, E
O.A. 17415-6	17 37 +68	9.1	1.4	.22	sc
Σ 2398 . . .	18 42 +59	8.8	2.3	.29	K, R
σ Draconis .	19 32 +70	4.8	1.9	.22	s, P
Altair . . .	19 46 + 9	0.9	0.6	.24	E
61 Cygni . .	21 2 +38	4.8	5.2	.31	many
ϵ Indi . . .	21 56 -57	4.8	4.7	.28	G, E
Krueger 60 .	22 24 +57	9.2	0.9	.26	B, Sc, R
Lac. 9352 . .	22 59 -36	7.4	7.0	.28	G

Authorities.—A—A. Auwers; B—E. E. Barnard; C—F. L. Chase; E—W. L. Elkin; G—Sir David Gill; K—J. C. Kapteyn; k—K. N. A. Krüger; P—B. Peter; R—H. N. Russell and A. R. Hinks; S—W. de Sitter; s—M. F. Smith; Sc—F. Schlesinger.

The stars selected to be examined for parallax are usually either the brightest stars or those with an especially large proper motion. Neither criterion is a guarantee that the star shall have a measurable parallax. Brightness is particularly deceptive; thus Canopus, the second brightest star in the heavens, has probably a parallax of less than 0.01", and so also has Rigel. These two stars must have an intrinsic brilliancy enormously greater than that of the sun, for if the sun were removed to such a distance (parallax 0.01"), it would appear to be of about the tenth magnitude.

Although the parallaxes hitherto measured have added greatly to our general knowledge of stellar distances and absolute luminosities of stars, a collection of results derived by various observers choosing specially selected stars is not suitable for statistical discussion. For this reason a series of determinations of parallax of 163 stars on a uniform plan by F. L. Chase, M. F. Smith and W. L. Elkin (*Yale Transactions*, vol. ii., 1906) constitutes a very important addition to the available data. The stars chosen were those with centennial proper motions greater than 40", observable at Yale, and not hitherto attacked. It is noteworthy that no parallaxes exceeding 0.20" were found; the mean was about 0.05". It is greatly to be desired that a general survey of the heavens, or of typical regions of the heavens, should be made with a view to determining all the stars which have an appreciable parallax. This is now made possible by photography. If three plates (or three sets of exposures on one plate) are taken at intervals of six months, when the stars in the region have their maximum parallactic displacements, the first and third plates serve

to eliminate the proper motion of the star, and the detection of a parallax is easy. Some progress with this scheme has been made. But even such an attempt to systematically plumb the universe can only make us acquainted with the merest inside shell. We should learn perhaps the distribution and luminosities of the stars within a sphere of radius sixty light years (corresponding to a parallax of about 0.05"), but of the structure of the million-fold greater system of stars, lying beyond this limit, yet visible in our telescopes, we should learn nothing except by analogy. Fortunately the study of proper motions teaches us with some degree of certainty something of the general mean distances and distribution of these more distant stars, though it cannot tell us the distances of individual stars.

There is another method of determining stellar distances, which is applicable to a few double stars. By means of the spectroscope it is possible to determine the relative orbital velocity of the two components, and this when compared with the period fixes the absolute dimensions of the orbit; the apparent dimensions of the orbit being known from visual observations the distance can then be found. The method is of very limited application, for in general the orbital velocity of a visual binary is far too small to be found in this way; one of its first applications has been made to α Centauri, with the result that the parallax found in the ordinary way is completely confirmed.

Proper Motions of Stars.—The work of cataloguing the stars and determining their exact positions, which is being pursued on so large a scale, naturally leads to the determination of their proper motions. The problem is greatly complicated by the fact that the equator and equinox, to which the observed positions of the stars must be referred, are not stationary in space, and in fact the movements of these planes of reference can only be determined by a discussion of the observations of stars. Halley was the first to suspect from observation the proper motions of the stars. From comparisons between the observed places of Arcturus, Aldebaran and Sirius and the places assigned to them by Alexandrian astronomers, he was led to the opinion that all three are moving towards the south (*Phil. Trans.* 1718). Jacques Cassini also proved that Arcturus had even since the time of Tycho Brahe shifted five minutes in latitude; for η Boötis, which would have shared in the change, if it had been due to a motion of the ecliptic, had not moved appreciably. It was early realized that the proper motions of the stars were changes of position relative to the sun, and that, if the sun had any motion of its own as compared with the surrounding stars as a whole, this would be shown by a general tendency of the apparent motions of the stars to be directed away from the point to which the sun was moving.

To determine proper motions it is necessary to have observations separated by as long a period of time as possible. Old catalogues of precision are accordingly of great importance. By far the most valuable of these is Bradley's catalogue of 3240 stars observed at Greenwich about 1750–1763, which has been re-reduced according to modern methods by A. Auwers. These stars include most of the brighter ones visible in the latitude of Greenwich, ranging down to about the seventh magnitude. An early catalogue which includes large numbers of stars of magnitude as low as 8.5 is that of S. Groombridge, containing 4200 stars within 52° of the north pole observed between 1806 and 1816. This has been re-reduced by F. W. Dyson and W. G. Thackeray, and proper motions derived by comparison with modern Greenwich observations. A very extensive determination of proper motions from a comparison of all the principal catalogues has been made by Lewis Boss. The results are given in his *Preliminary General Catalogue* (1910), which comprises the motions of 6188 stars fairly uniformly distributed over the sky, including all the stars visible to the naked eye. Of rather a different nature are J. G. Porter's catalogue (*Publications of the Cincinnati Observatory*, No. 12) and J. F. Bossert's catalogue (*Paris Observations*, 1890), which consist of lists of stars of large proper motion determined from a variety of sources. Recently the proper motions of faint stars have been determined by comparing photographs of the same region of the sky, taken with an interval of a number of years. At present the available intervals are too small for this method to have met with marked success. Large proper motions can however be found in this way. Their detection is especially simple when the stereo-comparator is used; this instrument enables the two eyes to combine the images of each star on two plates into one image (as in the stereoscope); when the star has moved considerably in the interval between the taking of the two plates, it appears to stand out from the rest in relief and is at once noticed.

The star with the greatest proper motion yet known was found by J. C. Kapteyn on the plates of the Cape Photographic *Durchmusterung*. Its motion of 8.7" per year would carry it over a portion of the sky equal to the diameter of the full moon in about two

centuries. In the table is given a list of the stars now known to have an annual proper motion of more than 3". The faintness of the majority of the stars appearing in this list is noteworthy.

Stars with Large Proper Motion.

Name.	R.A. 1900.	Dec. 1900.	Annual Proper Motion.	Mag.
	h. m.	°	"	
C.Z.5 ^b 243 . . .	5 8	-45.0	8.70	8.5
Gr. 1830 . . .	11 47	+38.4	7.04	6.9
Lac. 9352 . . .	22 59	-36.4	6.94	7.5
Cor.32416 . . .	0 0	-37.8	6.07	8.5
61 ^a Cygni . . .	21 2	+38.3	5.20	5.5
L.I. 21185 . . .	10 58	+36.6	4.76	7.3
ϵ Indi . . .	21 56	-57.2	4.61	5.2
L.I. 21258 . . .	11 0	+44.0	4.41	8.7
σ^2 Eridani . . .	4 11	- 7.8	4.05	4.6
μ Cassiop . . .	1 2	+54.4	3.73	5.6
O.A. 14318 . . .	15 5	-16.0	3.68	9.1
O.A. 14320 . . .	15 5	-15.9	3.68	9.1
α Centauri . . .	14 33	-60.4	3.60	0.2
Lac. 8760 . . .	21 11	-39.2	3.53	7.3
ϵ Eridani . . .	3 16	-43.4	3.12	4.4
O.A. 11677 . . .	11 15	+66.4	3.02	9.0

The majority of the stars have far smaller proper motions than these. Only 24% of the stars of Auwers-Bradley have proper motions exceeding 10" per century, and 51% exceeding 5" per century. With catalogues containing fainter stars the proportion of large proper motions is somewhat smaller, thus the corresponding percentages for the Groombridge stars are 12 and 31 respectively.

When the parallax of a star is known, we are able to infer from its proper motion its actual linear speed in miles per hour, in so far as the motion is transverse to the line of sight. The velocity in the line of sight can be determined by spectroscopic observation, so that in a few cases the motion of the star is completely known. Several stars appear to have speeds exceeding 100 m. per second, but of these the only one reliably determined is Groombridge 1830, whose speed is found to be about 150 m. per second. Probably the velocity of Arcturus is also over 100 m. per second; there is, however, no real evidence for the velocity of 250 m. per second which has sometimes been credited to it. The above are velocities transverse to the line of sight. The greatest radial velocities that have yet been found are about 60 m. per second; several stars (Groombridge 1830 among them) have radial speeds of this amount. The stars of the Helium type of spectrum are remarkable for the smallness of their velocities; from spectroscopic observations of over 60 stars of this class, J. C. Kapteyn and E. B. Frost have deduced that the average speed is only 8 m. per second. According to W. W. Campbell the average velocity in space of a star is 21.2 m. per second.

When the proper motions of a considerable number of stars are collected and examined, a general systematic tendency is noticed. The stars as a whole are found to be moving towards a point somewhere in or near the constellation *The Solar Motion*. Canis Major. The motions of individual stars, it is true, vary widely, but if the mean motion of a number of stars is considered this tendency is always to be found. Now it is necessary to bear in mind that all observed motions are *relative*; and, especially in dealing with stellar motions, it is arbitrary what shall be considered at rest, and used as a standard to which to refer their movements. Accordingly this mean motion of the stars relative to the sun has been more generally regarded from another point of view as a motion (in the opposite direction—towards the constellation Lyra) of the sun relatively to the stars. In what follows we shall speak of this relative motion as a motion of the sun or of the stars indifferently, for there is no real distinction between the two conceptions. One of the problems, which has engaged a large share of the attention of astronomers in the last century, has been the determination of the direction of this "solar motion."

The first attempt to determine the solar apex (as the point towards which the solar motion is directed is termed) was made in 1783 by Sir William Herschel. Although his data were the proper motions of only seven stars, he indicated a point near λ Herculis not very far from that found by modern researches. Again in 1805 from Maskelyne's catalogue of the proper motions of 36 stars (published in 1790), he found the position, R.A. 245° 52' and Dec. 49° 38' N. The systematic tendency of the proper motions is so marked that the motions of a very few stars are quite sufficient to fix roughly the position of the solar apex; but attempts to fix its position to within a few degrees have failed, notwithstanding the many thousands of determined proper motions now available. The difficulties of the determination are twofold. There is a close interdependence between the constant of procession and the solar motion; the two determinations must generally be made simultaneously, and both depend very considerably on the systematic

corrections required by the catalogues compared. But further, if these practical difficulties could be considered overcome in the best determinations, there is a vagueness in the very definition of the solar motion. The motion of the sun relative to the stars depends on what stars are selected as representative. There is no a priori reason to expect the same result from the different classes of stars, such as the brighter or fainter, northern or southern, nearer or more distant, Solar type or Sirian stars. There is for example some evidence that the declination of the solar apex is really increased when the motion is referred to fainter stars. For these reasons a really close agreement between the results of different investigators is not to be expected.

Of the various modern determinations of the apex, we give first those which depend, wholly or mainly, on the Auwers-Bradley proper motions. Setting A for the right ascension, D for the declination of the apex, these are:—

$$\begin{aligned} \text{L. Boss } A &= 17^{\text{h}} 48^{\text{m}} \quad D = +42^{\circ}.8 \\ \text{L. Struve } A &= 18^{\text{h}} 20^{\text{m}} \quad D = +23^{\circ}.5 \\ \text{S. Newcomb } A &= 18^{\text{h}} 10^{\text{m}} \quad D = +31^{\circ}.3 \\ \text{J. C. Kapteyn } A &= 18^{\text{h}} 14^{\text{m}} \quad D = +29^{\circ}.5 \end{aligned}$$

The large differences between these results, derived from the same material, depend mainly on the different systematic corrections applied by each astronomer to the declinations of Bradley. From the data of his *Preliminary General Catalogue* (1910), L. Boss found $A = 18^{\text{h}} 2^{\text{m}}$, $D = +34^{\circ}.3$. Having regard to the special precautions taken to eliminate systematic error, and to the fact that the stars used were distributed nearly equally over both hemispheres, it is fair to conclude that this is the most accurate determination yet made. From the Groombridge proper motions Dyson and Thackeray found $A = 18^{\text{h}} 20^{\text{m}}$, $D = +37^{\circ}$. Other determinations have been made by O. Stumpe (*Ast. Nach.* No. 3000) and J. G. Porter (*Ast. Journ.* xii. 91), using mainly stars of large proper motions derived from various sources; their results are of the same general character. Most of the above investigators, besides giving a general result, have determined the apex separately for bright and faint stars, for stars of greater or less proper motion, and in some cases for stars of Sirian and Solar spectra. Considerable divergences in the resulting position of the apex are found.

It will be seen that the proper motion of any star may be regarded as made up of two components. The part of the star's apparent displacement, which is due to the solar motion, is generally called the *parallactic* motion; the rest of its motion (i.e. its motion relative to the mean of all the stars, is called its *peculiar* motion (*motus peculiaris*). Regarded as a linear velocity, the parallactic motion is the same for all stars, being exactly equal and opposite to the solar motion; but its amount, as measured by the corresponding angular displacement of the star, is inversely proportional to the distance of the star from the earth, and foreshortening causes it to vary as the sine of the angular distance from the apex. To arrive at some estimate of the speed of the solar motion, we may consider the motions of those stars whose parallaxes have been measured, and whose actual linear speed is accordingly known (disregarding motion in the line of sight). If a sufficient number of stars are considered, their peculiar motions will mutually cancel and the parallactic or solar motion can then be derived. But not much reliance can be placed on this kind of determination. A very weighty objection is that the stars whose parallaxes are determined are mainly those of large proper motion and therefore not fairly representative of the bulk of the stars; in fact their peculiar motions will not neutralize one another in the mean. A better method is to derive the speed from the radial motions observed with the spectroscope. In this way W. W. Campbell from the radial motions of 280 stars found the velocity to be 20 kilometres per second with a probable error of $1\frac{1}{2}$ km. per second (*Astrophysical Journal*, 1901, vol. xiii). This result depends on the northern stars only. By the addition of the data for southern stars, so as to obtain a distribution fairly symmetrical over the whole sphere, S. S. Hough and J. Halm deduced a velocity of 20.8 km. per second towards the apex $A = 18^{\text{h}} 5^{\text{m}}$, $D = +26^{\circ}$. The speed is very nearly four radii of the earth's orbit per year; thus the annual parallactic motion is equal to four times the parallax, for a star lying in a direction 90° from the solar apex; for stars nearer the apex or antapex it is foreshortened. This result, while it does not afford any means of determining the parallaxes of individual stars, enables us to determine the mean parallax of a group of stars, if we may assume their peculiar motions practically to cancel one another.

In researches on the solar motion the assumption is almost always made that the motions of the stars relatively to one another—the *peculiar* motions—are at random. The correctness of this hypothesis has long been under suspicion, but it has generally been accepted as the best simple approximation to the actual distribution of the motions that could be made. Naturally exceptional regions must be recognized; for example, a connected system such as the Pleiades, whose stars have the same proper motion, must constitute an exception. There can occasionally be traced a certain community of motion over a much larger area. Thus R. A. Proctor found that between Aldebaran and the Pleiades most of the stars have a motion positive in right ascension and negative in declination, a

phenomenon which he designated "star-drift." A more precise investigation by L. Boss has shown that there is in this region a "moving cluster" of globular form. The stars composing this all have equal and parallel motions; about 40 stars brighter than the seventh magnitude are known to belong to it. The group consisting of five stars of Ursa Major together with Sirius has already been alluded to; another very marked group of 16 stars in Perseus, all of the Helium type of spectrum, form a similar association. Spectroscopic evidence has indicated that most of the stars of Orion are associated, and share nearly the same motion (or rather, in this case, absence of motion).

But, whilst recognizing the existence of local drifts and systems, and admitting the possibility of relative motion between the nearer and more distant, or other classes of stars, it is only recently that astronomers have seriously doubted the correctness of the hypothesis of random distribution of stellar motions as at least a rough representation of the truth. The hypothesis was put to the test by J. C. Kapteyn, with the result that it appears to be not even approximately accordant with the facts. His researches indicate that, instead of being haphazard, the proper motions of the star show decided preference for two "favoured" directions, apparently implying that the stars surrounding us do not constitute a simple system but a dual one. The motion of the stars in the mean towards Canis Major is thus a *resultant* motion, which, when examined more minutely, is found to be due to the intermingling of two great streams of stars moving in very different directions. These two streams or drifts prevail in every part of the sky examined, and contain nearly equal numbers of stars; that is to say, in whatever part of the sky we look about half the stars are found to belong to one and half to the other of the two great drifts. This hypothesis of two star-drifts does not imply that all the stars move in one or other of two directions. The stars have on this theory random peculiar motions in addition to the motion of the drift to which they belong, just as on the older theory the stars have peculiar motions in addition to the solar or parallactic motion shared by all of them. But the two theories lead to a very different statistical distribution of the stellar motions. The older one—which may be called the "one-drift" hypothesis, since according to it the stars appear to form a single drift moving away from the solar apex—requires that the apparent directions of motion should be so distributed that fewest stars are moving directly towards the solar apex, and most stars along the great circle away from the solar apex, the number decreasing symmetrically, for directions inclined on either side of this great circle, according to a law which can be calculated. This is found not to agree with the facts at all. The deviation is unmistakable; in general the direction from the solar apex is not the one in which most stars are moving; and, what is even more striking, the directions, in which most and fewest stars respectively move, are not by any means opposite to one another. It seems difficult to account for the very remarkable and unsymmetrical distribution of the motions, unless we suppose that the stars form two more or less separate systems superposed; and it has been found possible by assuming two drifts with suitably assigned velocities to account very satisfactorily for the observed motions.

The phenomenon of two drifts was discovered by an examination of the Bradley proper motions (*Brit. Assoc. Rep.*, 1905, p. 257), and has subsequently been confirmed by a discussion of the Groombridge proper motions (*Mon. Not. R.A.S.*, 1906, 67, p. 34; 1910, 71, p. 4). By an examination of the stars of very large proper motion F. W. Dyson has traced the presence of the two drifts in all parts of the sky. They have been shown to prevail among fainter stars down to magnitude 9.5, by an examination of the Greenwich-Carrington proper motions; these, however, only cover a region within 9° of the north pole. Of the behaviour of stars fainter than magnitude 9.5 there is at present no direct evidence. About 10,000 stars altogether were dealt with in the above-mentioned investigations. The general results indicate that one of the drifts is moving (relatively to the sun) directly away from a point near α Ophiuchi (about R.A. 270° , Dec. $+12^{\circ}$), and the other from a point in Lynx (R.A. 83° , Dec. $+60^{\circ}$). These two points may be called the apices of the two drifts, for they are analogues of the solar apex on the one-drift theory; they are about 110° apart. The velocities of the drifts differ considerably, the one whose apex is in Ophiuchus having about $1\frac{1}{2}$ times the speed of the other. We may conveniently distinguish the two drifts as the *slow-moving* and *fast-moving* drifts respectively; but it should be remembered that, since these motions are measured relatively to the sun, this distinction is not physically significant. The stars appear to be nearly equally divided between the two drifts. The magnitudes of the stars are distributed in the same way in each drift. There is also clear evidence that the mean distances of both drifts from us are very approximately the same. Thus we are led to regard the two systems as completely intermingled, a fact which adds considerably to the difficulty of explaining the phenomena otherwise than as produced by two great systems—*universes* they have been called—which have come together, perhaps, by their mutual attraction, and are passing through one another. The chances of individual stars of the two systems colliding are infinitesimal. Until the hypothesis has been thoroughly tested by an

The Two
Star
Streams.

examination of the line-of-sight velocities of stars from the same point of view, this physical interpretation must be received with some degree of caution; but there can be no doubt of the reality of the anomalies in the statistical distribution of proper motions of the stars, and of these it offers a simple and adequate explanation.

Having determined the motions of the two drifts, and knowing also that the stars are nearly equally divided between them, it is evidently possible to determine the mean motion of the drifts combined. This is of course that relative motion of the sun and stars which we have previously called the solar motion. The position of the solar apex calculated in this way agrees satisfactorily with that found by the usual methods. It is naturally fairly close to the apex of the faster drift, but is displaced from it in the direction of the apex of the other drift. In this connexion it may be noticed that, when the smaller and larger proper motions are discussed separately, the latter category will include an unduly great proportion of stars belonging to the fast-moving drift, and the resulting determination will lead to a solar apex too near the apex of that drift, *i.e.* with too low a declination. This appears to be the explanation of Stumpe's and Porter's results; they both divided their proper motions into groups according to their numerical amount, and found that the declination of the solar apex progressively increased as the size of the motions used diminished. Another anomalous determination of the apex, due to H. A. Kobold (*Astro. Nach.*, 3163, 3451, and 3491) is also explained when the two drifts are recognized. Kobold, using a peculiar and ingenious method, found for it a declination -3° , which disagrees very badly with all other determinations; but it is a peculiarity of Kobold's method that it gives the line of symmetry of motion, which joins the apex and antapex, without indicating which end is the apex. Now the position of this line, as found by Kobold, actually is a (properly weighted) mean between the corresponding lines of symmetry of the two drifts, but naturally it lies in the *acute* angle between them, whereas the line of the solar motion is also a weighted mean between the two lines of drift, but lies in the *obtuse* angle between them.

The Structure of the Universe.—We now arrive at the greatest of all the problems of sidereal astronomy, the structure and nature of the universe as a whole. It can by no means be taken for granted that the universe has anything that may properly be called a *structure*. If it is merely the aggregate of the stars, each star or small group of stars may be a practically independent unit, its birth and development taking place without any relation to the evolution of the whole. But it is becoming more

only enables us to see stars more remote than before, but also reveals very many smaller stars within the limits previously penetrated. But notwithstanding the great variety of intrinsic brightness of the stars, the ratio of the number of stars of one magnitude to the number of the magnitude next lower (the "star-ratio") is a guide to the uniformity of their distribution. If the uniform distribution extends indefinitely, or as far as the telescope can penetrate, the star-ratio should have the theoretical value 3.98,¹ any decrease in density or limit to the distribution of the stars will be indicated by a continual falling off in the star-ratio for the higher magnitudes. H. H. Seeliger, who investigated this ratio for the stars of the *Bonn Durchmusterung* and *Southern Durchmusterung*, came to the conclusion (as summarized by Simon Newcomb) that for these stars the ratio ranges from 3.85 to 3.28, the former value being found for regions near the Milky Way and the latter for regions near the galactic poles. There is here evidence that even among stars of the *Durchmusterung* (9.5 magnitude), a limit of the universe has been reached, at least in the direction normal to the plane of the Milky Way. For the higher magnitudes J. C. Kapteyn has shown that the star-ratio diminishes still further.

In all investigations into the distribution of the stars in space one fact stands out pre-eminently, *viz.* the existence of a certain plane fundamental to the structure of the heavens. This is the *galactic plane*, well known from the fact that it is marked in the sky by the broad irregular belt of milky light called the Galaxy or Milky Way. But it is necessary to make a careful distinction between the galactic plane and the Galaxy itself; the latter, though it is necessarily one of the most remarkable features of the universe, is not the only peculiarity associated with the galactic plane. Its particular importance consists in the fact that the stars, bright as well as faint, crowd towards this plane. This apparent relation of the lucid stars to the Galaxy was first pointed out by Sir W. Herschel. For the stars visible to the naked eye a very thorough investigation by G. V. Schiaparelli has shown the relation in a striking manner. He indicated on planispheres the varying density of distribution of the stars over the sky. On these the belt of greatest density can be easily traced, and it follows very closely the course of the Milky Way; but, whereas the latter is a belt having rather sharply defined boundaries, the star-density decreases gradually and continuously from the galactic equator to the galactic poles. The same result for the great mass of fainter stars has been shown by Seeliger. The following table shows the density with which stars brighter than the ninth magnitude are distributed in each of nine zones into which Seeliger divided the heavens:—

The Galactic Plane.

Galactic latitude	} N. Pole to 70° N.	} 70° N. to 50° N.	} 50° N. to 30° N.	} 30° N. to 10° N.	} 10° N. to 10° S.	} 10° S. to 30° S.	} 30° S. to 50° S.	} 50° S. to 70° S.	} 70° S. to S. Pole
Number of stars per square degree									

and more generally recognized that the stars are not unrelated; they are parts of a greater system, and we have to deal with, not merely the history of a number of independent units, but with a far vaster conception, the evolution and development of an ordered universe.

Our first inquiry is whether the universe extends indefinitely in all directions, or whether there are limits beyond which the stars are not distributed. It is not difficult to obtain at least a partial answer to this question; anything approaching a uniform distribution of the stars cannot extend indefinitely. It can be shown that, if the density of distribution of the stars through infinite space is nowhere less than a certain limit (which may be as small as we please), the total amount of light received from them (assuming that there is no absorption of light in space) would be infinitely great, so that the background of the sky would shine with a dazzling brilliancy. We therefore conclude that beyond a certain distance there is a thinning out in the distribution of the stars; the stars visible in our telescopes form a universe having a more or less defined boundary; and, if there are other systems of stars unknown to us in the space beyond, they are, as it were, isolated from the universe in which we are. It is necessary however to emphasize that the foregoing argument assumes that there is no appreciable absorption of light in interstellar space. Recently, however, the trend of astronomical opinion has been rather in favour of the belief that diffused matter may exist through space in sufficient quantity to cause appreciable absorption; so that the argument has no longer the weight formerly attached to it. Another line of reasoning indicates that the boundary of the universe is not immeasurably distant, and that the thinning out of the stars is quite perceptible with our telescopes. This depends on the law of progression in the number of stars as the brightness diminishes. If the stars were all of the same intrinsic brightness it is evident that the comparison of the number of stars of successive magnitudes would show directly where the decreased density of distribution began. Actually we know that the intrinsic brightness varies very greatly, so that each increase of telescopic power not

The table, which is based on over 130,000 stars, shows that along the galactic circle the stars are scattered nearly three times more thickly than at the north and south poles of the Galaxy. What, however, is of particular importance is that the increase is gradual. No doubt many of the lucid stars which appear to lie in the Milky Way actually belong to it, and the presence of this unique cluster helps to swell the numbers along the galactic equator; but, for example, the increased density between latitudes 30° to 50° (both north and south) as compared with the density at the poles cannot be attributed to the Galaxy itself, for the Galaxy passes nowhere near these zones. The star-gauges of the Herschels exhibit a similar result; the Herschels counted the number of stars visible with their powerful telescopes in different regions of the sky, and thus formed comparative estimates of the density of the stars extending to a very high magnitude. According to their results the star-density increases continuously from 109 per square degree at the poles to 2019 along the galactic equator. In general, the fainter the stars included in the discussion the more marked is their crowding towards the galactic plane. Various considerations tend to show that this apparent crowding does not imply a really greater density or clustering of the stars in space, but is due to the fact that in these directions we look through a greater depth of stars before coming to the boundary of the stellar system. Sir William Herschel and afterwards F. G. W. Struve developed the view that the stars are contained in a comparatively thin stratum bounded by two parallel planes. The shape of the universe may thus be compared to that of a grindstone or lens, the sun being situated about midway between the two surfaces. Thus the figure represents a section the (ideally simplified) universe cut perpendicular to the planes AB and CD between which the stars are contained,

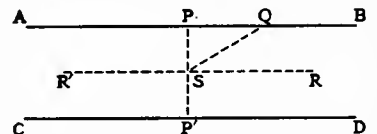

¹ This number is the 3/2th power of the ratio of the brightness of stars differing by a unit magnitude.

S being the sun. Imagine this stratum to be uniformly filled with stars (of course in the actual universe instead of sharply defined boundaries AB and CD, we shall have a gradual thinning out of the stars) it follows that in the two directions SP and SP' the fewest stars will be seen; these then are the directions of the galactic poles. As we consider a direction such as SQ farther and farther from the pole the boundary of the universe in that direction becomes more and more remote so that more stars are seen, and finally in the directions SR and SR' in the galactic plane, the boundary is perhaps beyond the limits of our telescopes. That the universe must have a boundary in the directions SR and SR', we can hardly doubt, but nothing is known of its shape or distance except that in all directions it must be far greater than SP or SP'; in particular it is not known whether the sun is near the centre or otherwise. That the sun is nearly midway between the two boundary planes can be tested by comparing the star-densities of the northern and southern galactic hemispheres. These are zone for zone very nearly equal; the slight excess of stars in the southern hemisphere perhaps implies that the sun is a little north of the central position. This is confirmed by the fact that the Milky Way is not quite a great circle of the celestial sphere, but has a mean south galactic latitude of about 1.7°.

If, instead of considering the whole mass of stars, attention is directed to those of large proper motion, which are therefore in the mean relatively near us, the crowding to the galactic plane is much less noticeable, if not indeed entirely absent. Thus Kapteyn found that the Bradley stars having proper motions greater than 5" per century were evenly distributed over the sky. Dyson and Thackeray's tables show the same result for the Groombridge stars down to magnitude 6.5; but the fainter stars (with centennial proper motions greater than 5") show a marked tendency to draw towards the galactic circle. The result is precisely what should be expected from the theory of the shape of the universe which has been set forth. If in the fig. we describe a sphere about S with radius SP so as just to touch the boundaries of the stratum of stars, then, provided a class of stars is considered wholly or mainly included within this sphere, no concentration of stars in the galactic plane is to be expected, for the shape of the universe does not enter into the question. It is only when some of the stars considered are more remote and lie outside this sphere (but of course between the two planes) that there is a galactic crowding. We infer that nearly all the stars down to magnitude 6.5, whose proper motions exceed 5", are at a distance from the sun less than SP, whilst of the fainter stars with equally great proper motions a large proportion are at a distance greater than SP. This result enables us to form some sort of idea of the distance SP.

On considering the distribution of the stars according to their spectra, it appears that the Type II. (solar) stars show no tendency to congregate in the galactic plane. The result of course only applies to the brighter stars, for we have very little knowledge of the spectra of stars fainter than about magnitude 7.5. The explanation indicated in the last paragraph applies to this case also. Type II. stars are in general much less intrinsically luminous than Type I., so that the stars known to be of this type must be comparatively near us, for otherwise they would appear too faint to have their spectra determined. They are accordingly within the sphere of radius SP (fig.), and consequently are equally numerous in every direction. The Type I. stars, being intrinsically brighter, are not so limited. According to F. McClean, of the stars brighter than magnitude 3.5, only the helium and not the hydrogen stars of Type I. show a condensation towards the galactic plane. Thus we see that the effect of limiting the magnitude to 3.5 is that the hydrogen stars are now practically all within the sphere SP, and it is only the helium stars, whose absolute luminosity is still greater, that are more widely distributed. Of the rarer types of spectra, stars of Type III. agree with those of Type II. in being evenly distributed over the sky; Types IV. and V. however, congregate towards the galactic plane. The most remarkable are the Type V. (Wolf-Rayet) stars; in their case the condensation into the galactic regions is complete, for of the 91 known stars of this type, 70 are actually in the Milky Way and the remaining 21 are in the Magellanic Clouds (two large clusters in the southern hemisphere, which resemble the Milky Way in several respects). Excluding the latter, the 70 Wolf-Rayet stars have a mean distance from the central galactic circle of only 2.6°. There can be little doubt that these stars belong to the Milky Way cluster, so that their presence is a property of the cluster rather than of the galactic plane in general. Spiral nebulae have the remarkable characteristic of avoiding the galactic plane, and it has been suggested that the space outside the limits of the stellar universe is filled with them. It does not, however, seem probable that their apparent anti-galactic tendency has such a significance; in the Magellanic Clouds spiral nebulae are very abundant, a fact which shows that there is no essential antipathy between the stars and the spiral nebulae.

As might be expected, the relative motion of the two great star-drifts is parallel to the galactic plane.

A glance at the Milky Way, with its sharply defined irregular boundaries, its clefts and diverging spur, is almost sufficient to assure us that it is a real cluster of stars, and does not merely

indicate the directions in which the universe extends farthest. Barnard's photographs of its structure leave little doubt on the matter; the numerous rifts and dark openings show that its thickness cannot be very great. To complete our representation of the universe, it is therefore necessary to add to the fairly uniform distribution of stars between two planes a gigantic cluster of an annular or spiral form, also lying between the planes and completely surrounding the sun. The Milky Way is not of uniform brightness, so that we are perhaps nearer to some parts of it than to others, but it is everywhere very distant from the sun. Estimates of this distance vary, but it may probably be put at more than three thousand light years (parallax less than 0.001"). Nevertheless the Milky Way contains a fair proportion of lucid stars, for these are considerably more numerous in the bright patches of the Milky Way than in the rifts and dark spaces.

The Milky Way.

It has been seen that the parallaxes afford little information as to the distribution of the main bulk of the stars and that the chief evidence on this point must be obtained indirectly from their proper motions. Our principal knowledge of this subject is due to Kapteyn (*Gröningen Publications*, Nos. 8 and 11), and though much of his work is provisional, and perhaps liable to considerable revision when more extensive data are obtainable, it probably gives an idea of the construction of the universe sufficiently accurate in all essential respects. As has been explained the mean distance of a group of stars can be readily determined from the parallactic motion, which, when not foreshortened, is approximately four times the parallax; but to obtain a complete knowledge of the distribution of stars it is necessary to know, not merely the mean parallax of the group, but also the frequency law, i.e. what proportion of stars have a quarter, half, twice or three times, &c., the mean parallax. One result of Kapteyn's investigations may be given here. Taking a sphere whose radius is 560 light years (a distance about equal to that of the average ninth magnitude star), it will contain:—

1 star giving from 100,000 to 10,000 times the light of the sun					
26 stars	"	10,000	"	1,000	"
1,300	"	1,000	"	100	"
22,000	"	100	"	10	"
140,000	"	10	"	1	"
430,000	"	1	"	0.1	"
650,000	"	0.1	"	0.01	"

Whether there is an increasing number of still less luminous stars is a disputed question.

The comparative nearness of the stars of the solar type, which we have had occasion to allude to, is confirmed by the fact that their proper motions are on the average much larger than those of the Sirian stars. Kapteyn finds that magnitude for magnitude, the absolute brightness of the solar stars is only one-fifth of that of the Sirian stars, so that in the mean they must be at less than half the distance. As the numbers of known stars of the two types are nearly equal, it is clear that, at all events in our immediate neighbourhood, the solar stars must greatly outnumber the Sirian.

REFERENCES.—Of modern semi-popular works entirely devoted to and covering the subjects treated of in this article the principal is Simon Newcomb's *The Stars, a Study of the Universe*; mention must also be made of Miss A. M. Clerke's *The System of the Stars* (2nd ed., 1905), which contains full references to original papers; *Problems in Astrophysics*, by the same author, may also be consulted. The following works of reference and catalogues deal with special branches of the subject; for variable stars, Chandler's "Third Catalogue," *Astronomical Journ.* (1896), vol. xvi., is now very incomplete; *Harvard Annals*, vol. lv., pt. 1, and vol. lx., No. 4, together constitute a catalogue of 3734 variable stars; ephemerides of over 800 variables are given in the *Vierteljahrsschrift* of the *Astronomische Gesellschaft*. For double stars see Burnham's *General Catalogue* (1907), and Lewis, *Memoirs of the R.A.S.*, vol. lvi.; the orbits of the principal binaries are discussed in T. J. J. See, *Evolution of Stellar Systems*, and another list will be found in *Lick Observatory Bulletin*, No. 84. A list of spectroscopic binaries discovered up to 1905 is given in *Lick Observatory Bulletin*, No. 79. For the spectrum analysis of stars, Scheiner's *Astronomical Spectroscopy* (trans. by Frost) may be consulted. The "Drapier Catalogue," *Harvard Annals*, vol. xxvii., gives the classification according to spectrum of over 10,000 stars; for the brighter stars *Harvard Annals*, vol. l. forms a more complete catalogue. Of the numerous memoirs discussing stellar spectra in relation to evolution, A. Schuster, "The Evolution of Solar Stars," *Astrophysical Journ.* (1903), vol. xvii., may be mentioned as giving a concise survey of the subject. (A. S. E.)

STARAYA RUSSA, a town of Russia, in the government of Novgorod, 58 m. S. of the city of Novgorod, on the river Polista, by means of which and Lake Ilmen it is brought into steamer communication with St. Petersburg. Pop., 15,234. Brine springs on the east of the town were used as a source for the supply of salt as late as 1865; at present they are used only as mineral waters (temperature 51-54° F.), having a great

resemblance to those of Kreuznach in Germany. Some thousands of visitors resort to them every summer, and owing to this circumstance Staraya Russa is better built and better kept than any other town in the government of Novgorod. The inhabitants are supported chiefly by the summer visitors. There is a trade in rye, oats and flax shipped to St Petersburg. The name of Staraya Russa occurs in Russian annals as far back as 1167. It belonged to the republic of Novgorod, and suffered continually in the wars between Russia, Lithuania and Livonia. It was afterwards annexed to Moscow.

STARA ZAGORA (Turk. *Eski-Zagra*), the capital of a department of Bulgaria, in Eastern Rumelia, on the southern slope of the Karaja Dagh, 70 m. N.W. of Adrianople, with which it is connected by railway. Pop. (1906), 20,647. It is surrounded by vineyards, and has also cloth and carpet manufactures, copper foundries and tanneries. The production of silk and attar of roses is carried on in the district, which contains numerous mineral springs. The town having been almost wholly destroyed during the Russo-Turkish War of 1877-78, was rebuilt on a regular plan, with wide and broad streets radiating from a fine central square, where are situated the principal public buildings. During the rebuilding, important Thracian, Roman, Byzantine and Turkish antiquities were discovered.

Stará Zagora, founded probably by the Macedonians, was known to the Romans as Augusta Traiana, but afterwards, to distinguish it from a Macedonian town of this name, it was named Beroe or Berrhoca. By the Turks the name was changed in the 17th century to Eski-Zagra or Eski-Zaara, but after 1878 the Bulgarian name of Stará Zagora came into general use.

STARBOARD AND LARBOARD, nautical terms for the right and left sides respectively of a ship, looking towards the bows. The final part of these is Old English *bord*, board, the side of a ship, now used for a plank of wood. In starboard (O. Eng. *steorbord*) the first part certainly means "steer," and "steering side" therefore refers to the time when vessels were steered by a paddle or sweep worked from the right side. In Old English the left side of a ship was known as *baecbord*, back board, the side of the vessel to the back of the steersman. This is paralleled in all other Teutonic languages, cf. German *backbord*, and has been adopted in Romanic languages, cf. French *bâbord*. *Baecbord* did not survive in Middle English, in which its place was taken by *laddeborde* or *latheborde*. In the 16th century the word takes the forms *lerbord*, *leerebord* or *larbord*, probably by assimilation to *ster-*, *steere-*, and *star-bord*. There is much doubt as to the origin of the term and the curious change from *laddebord* to *larboard*. Skeat (*Etym. Dict.*) suggests that these may be two distinct words. The earlier form is usually connected with "lade," to put cargo on board a vessel, the left side being that on which this was usually done, for the ship when in port would lie with her left side against the quay wall, her head pointing to the entrance. If the later form is not due to mere assimilation to starboard, it may contain a word meaning empty (O. Eng. *gelâr*, Ger. *leer*), and refer to that side of the vessel where the steersman does not stand. Owing to the similarity in sound between starboard and larboard, the word port is now used for the left side. The substitution of this for the older term was officially ordered in the British navy by an admiralty order of 1844, and in the United States of America by a navy department notice in 1896. The use of port in this sense is much older; it occurs in Manwaring's *Seaman's Dictionary* (1625-1644). In this usage port may either mean "harbour" (Lat. *portus*), the ship lying with its left side against the port or quay for unloading, or "opening," "entrance" (Lat. *porta*, gate), for the cargo to be taken on board; cf. "porthole."

STARCH, an organized product of the vegetable kingdom, forming one of the most important and characteristic elements of plant life. It originates within the living vegetable cell through the formative activity of chlorophyll under the influence of light, and is consequently an unfauling characteristic of all plants containing that body. Starch found within leaves and other green parts of plants is assimilated and transformed

with great rapidity; accumulations of it are carried as starch-formers, and redeposited as starch in special reservoirs or portions of plants as the period of maturity approaches. In this way the body is found to gorge the stems of certain palms—the sago, &c.—just before these plants begin to form their fruit; it is the principal constituent of the underground organs of biennial and perennial plants, tap-roots, root-stocks, corms, bulbs and tubers; and it is abundantly stored in many fruits and seeds, as in the cereals and pulses, in bananas, bread-fruit, &c. It occurs in minute granules varying in diameter from .002 to .185 millimetres; and the granules from different sources have each a distinct microscopic character. Under the microscope these granules are seen to consist of a nucleus or hilum surrounded by layers arranged concentrically or excentrically, and the relations of hilum and layers are the most distinctive features of individual starches (see H. Galt, *Microscopy of the Starches*, 1900). Starch consists of a white or yellowish-white glistening powder. It is only slightly acted on by cold water, but under the influence of heat in water it swells up, forming according to the proportions of starch and water a clouded opalescent paste. The soluble portion is called granulose, and the insoluble starch-cellulose; from the aqueous solution alcohol precipitates soluble starch. Iodine acts on it in water, producing a brilliant blue coloration, this reaction forming a very delicate and characteristic test. The colour disappears on heating, but is recovered when the mixture is cold. Diastase and dilute boiling sulphuric acid convert starch into a form soluble in hot water, whence it passes into a series of easily soluble dextrans, and finally into the condition of the sugars, dextrose and maltose. Chemically, starch is a carbohydrate with the formula $(C_6H_{10}O_5)_n$, where n is four or more.

As an economic product starch in its separate condition is a most important alimentary substance, the chief pure food starches being arrowroot, sago, tapioca and cornflour. In its combined condition, in cereals, &c., starch is a useful nutritive element. In its other industrial relations starch is used: (1) directly, as a thickening material in calico printing, for the dressing and finishing of many textiles, for laundry purposes, adhesive paste, and powder; and (2) indirectly, for the preparation of dextrin and British gum and starch sugar. Indian corn, wheat and rice starch are principally employed for the direct applications; and for the dextrin and starch-sugar manufacture potato starch is almost exclusively selected.

In the preparation of starch the object of the manufacturer is to burst the vegetable cell walls, to liberate the starch granules, and to free them from the other cell contents with which they are associated. When, as in the case of the potato, the associated cell contents, &c., are readily separated by solution and levigation the manufacture is exceedingly simple. Potato starch is prepared principally by carefully washing the potatoes and in a kind of rasping machine reducing them to a fine pulp, which is deposited in water as raw starch. The impurities of this starch—cellulose, albuminoids, fragments of potato, &c.—are separated by washing it in fine sieves, through the meshes of which the pure starch alone passes. The sieves are variously formed, some revolving, others moving horizontally or in such manner as to keep the material in agitation. The starch is then received in tanks, in which it settles, and so separates from the soluble albuminoids and salts of the potatoes. (The waste pulp which passes over the sieve is pressed, dried quickly, and sold as a low-grade cattle food.) The settling of the starch is much retarded by the dissolved albuminoids, and to hasten the separation small quantities of alum or sulphuric acid are employed. Alum coagulates the albumen and to that extent contaminates the starch, while the acid acts on the starch itself and is difficult of neutralization. After the starch has settled, the brown-coloured supernatant liquor is drawn off and the starch again washed either in tanks or in a centrifugal machine. Finally it is dried by spreading it in layers over porous bricks (a process not required in the case of starch washed in a centrifugal machine) and by exposure to the air, after which it still retains a large proportion of water, but is in a condition for making dextrin or starch-sugar. For further drying it is ground to a rough powder, and dried thoroughly in a hot chamber, then reduced to a powder and sifted. Potato starch is also made by a "rotting" process, in which potatoes are reduced to a pulp by slicing and are then heaped up till fermentation takes place; 100 lb of potatoes yield 15-16 lb of dry starch.

In dealing with the starches of the cereals, there is greater

difficulty, owing to the presence of gluten, which with water forms a tough elastic body difficult of solution and removal. The difficulty is experienced in greatest measure in dealing with wheat, which contains a large proportion of gluten. Wheat starch is separated in two different ways: (1) the fermentation method, which is the original process, and (2) by mechanical means without preliminary fermentation. In the fermentation process whole wheat or wheaten meal is softened and swollen by soaking in water. Wheat grains are, in this condition, ground, and the pulp, mixed to a thickish fluid with water, is placed in tanks, where it ferments, developing acids which dissolve the gummy constituents of the wheat, with part of the gluten, and render the whole less tenacious. After full fermentation, the period of which varies with the weather and the process employed, the starch is separated in a washing drum. It is subsequently washed with water, which dissolves out the gluten, the starch settling in two layers—one comparatively pure, the other mixed with gluten and some branny particles. These layers are separated, the second undergoing further washing to remove the gluten, &c., and the remaining operations are analogous to those employed in the preparation of potato-starch. By the mechanical process wheaten flour is kneaded into a stiff paste, which, after resting for an hour or two, is washed over a fine sieve so long as the water passing off continues milky, whereby the starch is liberated and the greater part of the gluten retained as a gluey elastic mass in the sieve. The starch is subsequently purified by fermentation, washing and treatment in centrifugal machines. The gluten thus preserved is a useful food for diabetic patients, and is made with flour into artificial macaroni and pastes, besides being valuable for other industrial purposes. The fermentation process gives about 59 lb of starch and 11 of bran from 100 lb of wheat, whilst the mechanical process gives about 55 lb of starch and 12 of gluten.

Maize (Indian corn) starch is obtained by analogous processes, but, the proportion of gluten in the grain being smaller and less tenacious in its nature, the operations, whether chemical or mechanical, present fewer difficulties. Under one method the separation of maize starch is facilitated by steeping, swelling and softening the grain in a weak solution of caustic soda, and favourable results are also obtained by a process in which the pulp from the crushing mill is treated with water acidulated with sulphurous acid.

In the preparation of rice-starch a weak solution of caustic soda is also employed for softening and swelling the grain. It is then washed with pure water, dried, ground and sifted, and again treated with alkaline water, by which the whole of the nitrogenous constituents are taken up in soluble form. An acid process for obtaining rice-starch is also employed, under which the grain, swollen and ground, is treated repeatedly with a solution of hydrochloric acid, which also dissolves away the non-starchy constituents of the grain. The yield is about 85 lb per 100 of rice. Laundry starches are principally made from rice and from pulse.

See O. Saare, *Die Fabrikation der Kartoffelstärke* (1897).

STAR CHAMBER, the name given in the 15th, 16th and 17th centuries to an English court of justice. The name is probably derived from the stars with which the roof of the chamber was painted; it was the *camera stellata*. But it has also been derived from a Hebrew word *shetar* or *sh'tar*, a bond, on the supposition that the chamber of meeting was the room in which the legal documents connected with the Jews were kept prior to their expulsion from England by Edward I.

The origin and early history of the court are somewhat obscure. The *curia regis* of the 12th century, combining judicial, deliberative and administrative functions, had thrown off several offshoots in the court of king's bench and other courts, but the Crown never parted with its supreme jurisdiction. When in the 13th century the king's council became a regular and permanent body, practically distinct from parliament, this supreme jurisdiction continued to be exercised by the king in council. As the ordinary courts of law became more important and more systematic, the indefinite character of the council's jurisdiction gave rise to frequent complaints, and efforts, for the most part fruitless, were made by the parliaments of the 14th century to check it. The equitable jurisdiction of the chancellor, which grew up during the reign of Edward III. like the courts of law under Henry II., was derived from this supreme judicial power, which was yet unexhausted.

It is in the reign of Edward III., after an act of 1341, that we first hear of the chancellor, treasurer, justices and other members of the king's council exercising jurisdiction in the old chamber, or *chambre de estoiles*, at Westminster. In Henry VI.'s reign one Danvers was acquitted of a certain charge by the council in the *camera stellata*. Hitherto such acts of parliament as had

recognized this jurisdiction had done so only by way of limitation or prohibition, but in 1453, about the time when the distinction between the ordinary and the privy council first became apparent, an act was passed empowering the chancellor to enforce the attendance of all persons summoned by the privy seal before the king and his council in all cases not determinable by common law. At this time, then, the jurisdiction of the council was recognized as supplementary to that of the ordinary courts of law. But the anarchy of the Wars of the Roses and the decay of local justice, owing to the influence of the great barons and the turbulence of all classes, obliged parliament to entrust wider powers to the council. This was the object of the famous act of 1487, which was incorrectly quoted by the lawyers of the long parliament as creating the court of star chamber, which was in reality of earlier origin.

The act of 1487 (3 Hen. VII.) created a court composed of seven persons, the chancellor, the treasurer, the keeper of the privy seal, or any two of them, with a bishop, a temporal lord and the two chief justices, or in their absence two other justices. It was to deal with cases of "unlawful maintenance, giving of licences, signs and tokens, great riots, unlawful assemblies"; in short with all offences against the law which were too serious to be dealt with by the ordinary courts. The jurisdiction thus entrusted to this committee of the council was not supplementary, therefore, like that granted in 1453, but it superseded the ordinary courts of law in cases where these were too weak to act. The act simply supplied machinery for the exercise, under special circumstances, of that extraordinary penal jurisdiction which the council had never ceased to possess. By an act of 1529 an eighth member, the president of the council, was added to the star chamber, the jurisdiction of which was at the same time confirmed. At this time the court performed a very necessary and valuable work in punishing powerful offenders who could not be reached by the ordinary courts of law. It was found very useful by Cardinal Wolsey, and a little later Sir Thomas Smith says its object was "to bridle such stout noblemen or gentlemen who would offer wrong by force to any manner of men, and cannot be content to demand or defend the right by order of the law."

It is popularly supposed that the star chamber, after an existence of about fifty years, disappeared towards the end of the reign of Henry VIII., the powers obtained by the act of 1487 being not lost, but reverting to the council as a whole. This may have been so, but it is more probable that the star chamber continued to exist side by side with the council, and the two bodies were certainly separate during the latter part of Elizabeth's reign. The act of 1540, which gave the king's proclamation the force of law, enacted that offenders against them were to be punished by the usual officers of the council, together with some bishops and judges "in the star chamber or elsewhere." It is difficult, if not impossible, to draw a clear distinction between the duties of the privy council and the duties of the star chamber at this time, although before the abolition of the latter there was a distinction "as to their composition and as to the matters dealt with by the two courts." During the reign of Elizabeth Sir Thomas Smith remarks that juries misbehaving "were many times commanded to appear in the star chamber, or before the privy council for the matter." The uncertain composition of the court is well shown by Sir Edward Coke, who says that the star chamber is or may be compounded of three several councils: (1) the lords and others of the privy council; (2) the judges of either bench and the barons of the exchequer; (3) the lords of parliament, who are not, however, standing judges of the court. William Hudson (d. 1635), on the other hand, considers that all peers had the right of sitting in the court, but if so they had certainly given up the privilege in the 17th century.

The jurisdiction of the star chamber was as vague as its constitution. Hudson says it is impossible to define it without offending the supporters of the prerogative by a limitation of its powers, or the lawyers by attributing to it an excessive latitude. In practice its jurisdiction was almost unlimited.

It took notice of riots, murder, forgery, felony, perjury, fraud, libel and slander, duels and acts tending to treason, as well as of some civil matters, such as disputes about land between great men and corporations, disputes between English and foreign merchants, and testamentary cases; in fact, as Hudson says, "all offences may be here examined and punished if the king will." Its procedure was not according to the common law. It dispensed with the encumbrance of a jury; it could proceed on rumour alone; it could apply torture; it could inflict any penalty but death. It was thus admirably calculated to be the support of order against anarchy, or of despotism against individual and national liberty. During the Tudor period it appeared in the former light, under the Stuarts in the latter. Under the Tudors, as S. R. Gardiner says, it was "a tribunal constantly resorted to as a resource against the ignorance or prejudices of a country jury," and adds that "in such investigations it showed itself intelligent and impartial." Under James I. and Charles I. all this was changed; the star chamber became the great engine of the royal tyranny. Hatel and excessive punishments were inflicted on those brought before the court, notable among whom were Prynne, Bastwick and Burton, and the odium which it gathered around it was one of the causes which led to the popular discontent against Charles I. As it became more unpopular its jurisdiction was occasionally questioned. An example of this kind occurred in 1629, but the barons of the exchequer who heard the case declared that the star chamber was created many years before the statute of Henry VII. and that it was "one of the most high and honourable courts of justice." It was abolished by an act of parliament of July 1641. In 1661 a committee of the House of Lords reported "that it was fit for the good of the nation that there be a court of like nature to the star chamber"; but nothing further was done in the matter.

For the history of the star chamber see Sir Thomas Smith, *Commonwealth of England* (1633); Lord Bacon, *History of Henry VII.*, edited by J. R. Lumby (Cambridge, 1881); William Hudson, "Treatise of the Court of Star Chamber," in vol. ii. of *Collectanea Juridica*; H. Hallam, *Constitutional History of England* (1876); W. S. Holdsworth, *History of English Law* (vol. 1902); G. W. Prothero, *Statutes and Constitutional Documents 1559-1625* (1894); W. Busch, *England under the Tudors* (1895); S. R. Gardiner, *History of England 1603-1642* (1883-1884); D. J. Medley, *English Constitutional History* (1907); and A. V. Dicey, *The Privy Council*. The pleadings in the star chamber are in the Record Office, London; the decrees appear to have been lost.

STARFISH, a popular term under which are included a large number of sea-animals, belonging all to the great group of Echinoderms, but to three distinct divisions of that group: the Asterids, the Ophiurids and the Crinoids (see ECHINODERMA). The Asterids or starfish proper include the cross-fish, the sun-star (see ECHINODERMA, fig. 17), the cushion-star, the button, and many without a popular name. The common cross-fish or five-finger, *Asterias rubens*, of British seas, may be taken as typical (figs. 1 and 2), and the description will apply also to the American species *A. forbesi* and *A. vulgaris*. The animal consists of a central body or disk, produced into five arms or rays. The upper surface is covered with a leathery skin, strengthened by a rafter-work of little bones or plates, made of crystalline carbonate of lime, many of them bearing prickles of the same substance and small pincer-like bodies—the pedicellariae (see SEA-URCHIN). In the

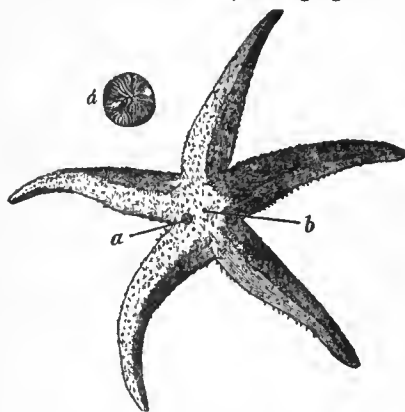

FIG. 1.—An Asterid, *Asterias rubens*, upper surface.

a, Madreporite.
 a, The same magnified.
 b, Anus.

This starfish may be 9-12 in. across. The upper surface is covered with a leathery skin, strengthened by a rafter-work of little bones or plates, made of crystalline carbonate of lime, many of them bearing prickles of the same substance and small pincer-like bodies—the pedicellariae (see SEA-URCHIN). In the

middle of the body is a small anal opening, and near the angle between two rays is a furrowed plate pierced by many minute pores and called the madreporite. The under surface of the body has the mouth in the centre, and from it deep grooves radiate to the ends of the arms. At the bottom of each groove is a water-vessel, which gives off branches to the podia or sucking-feet on each side of it. A section across this groove is given in the article ECHINODERMA, fig. 12 B. The arrangement and working of this hydraulic system is essentially the same as in the sea-urchin, except



FIG. 2.—*Asterias rubens*, under surface.
 a, The arm-groove with its row of sucking-feet or podia.
 b, End of a podium, magnified.

for the presence of plates at the bottom of the groove beneath the radial water-vessel, and the absence of any plates covering the groove. At the end of each ray is, as in the urchin, a single tentacle surrounded by pigment and connected with a definite plate called "terminal." Thus the terminals of a starfish correspond to the oculars of a sea-urchin (see ECHINODERMA, fig. 3). The stomach is not a long coil, but a simple sac with branched blind tubes extending into each ray. A generative gland also passes down the side of each ray, and emits the milt or eggs when ripe through a pore near the body. Spawning takes place in spring or early summer. A starfish can crawl in any direction by means of its sucking-feet, whether the surface be hard or rough or polished, or the softest silt, whilst its supple body can squeeze through incredibly narrow crevices. The rate of progress is about six inches a minute.

The starfish are the scavengers of the sea, but unfortunately do not confine their attentions to decaying matter; they eat oysters, clams, mussels, barnacles, sea-snails, worms, crustacea and even smaller starfish. There is constant war between oyster-fishers and starfish; no less than 42,000 bushels of starfish were removed from the oyster-beds of Connecticut in a single year, but not till they had worked damage to the amount of \$631,500. The simplest way in which a starfish eats is by taking small bits of food into the stomach, and ejecting the refuse again through the mouth. But since the mouth is quite small and the food often large, the starfish finds it more convenient to turn its stomach inside out and to wrap it around the animal to be eaten, which is then digested quietly and the stomach withdrawn again. In the case of oysters and similar bivalves, the starfish first has to open them; and this it does by fixing the suckers of one or two rays to one valve and those of the opposite rays to the other valve, while it may get a purchase by also holding on to some neighbouring object. It then begins to straighten out its rays. The oyster can withstand a very strong pull, but it cannot hold out against a long pull, and the starfish does not hurry. At last the oyster gives way, and the starfish has its reward; but its companions often join in, and you may see a whole ball of them interlaced round half-digested molluscs and rolling about. Starfish begin to eat voraciously when quite young; one less than $\frac{3}{4}$ th in. across has been observed to eat over fifty young clams of half that length in six days. The more a starfish has to eat the quicker it grows, and it may become sexually mature in less than a year, then producing many thousands of young. Fortunately the increase is kept in check by many causes. The young, while still in the stage of free-swimming larvae, are swallowed in millions by various fish. When they settle down on seaweed their bright colours attract eels and many small fishes. Later in life they are attacked by parasites, while those which stray into shallow water are eaten by gulls and crows. Freshets and cold currents are also destructive.

Probably the best way in which man can keep down the numbers of starfish is by dredging the seaweed in the latter half of July when it is covered with young; a single cartload thrown on shore would capture many millions. At a later stage tangles of hemp or cotton waste may be dragged over the oyster-beds, when the starfish will cling to them by their pedicellariae. They make excellent manure, but are of no further service to man. Fishermen who catch them in their nets or on their lines often tear them in half and throw them back into the sea. Some of these mutilated

animals may, however, grow fresh rays, and thus one may find a starfish consisting of one large ray and four quite small ones, the whole shaped like a comet.

The Ophiurids (the name means "snake-tails") include the brittle-stars, sand-stars, and basket-fish or medusa-heads.

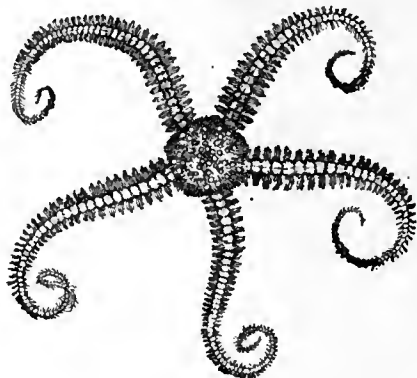

FIG. 3.—An Ophiurid, the Daisy Brittle-star (*Ophiopholis aculeata*); upper surface. ($\frac{2}{3}$ natural size.)

The two former, which may often be found hiding under the rocks, or in the seaweed, or in pools at low tide, resemble the ordinary starfish in having five distinct arms. These, however, as shown in fig. 3, are long and serpent-like, and are attached to a relatively small body or disk. The digestive and generative systems do not extend to the rays but are confined to the body. The arms are cylindrical and have no groove on the under side such as exists in starfish; but the water-vessel traverses the solid bones that form the axis of the arm, and the podia pass out through special openings (see ECHINODERMA, fig. 18).

In Ophiurids it is the arms that are used for locomotion and not the podia, so that the latter have no terminal suckers. The axial ossicles, which correspond to the plates flooring the arm-groove in a starfish, resemble vertebrae connected by pairs of straight muscular bundles, and articulated by tenon-and-mortise joints, according to whose degree of development the arms vary in their power of coiling. These vertebrae are encased in the tough outer skin of the arm, in which are developed plates. Spines borne by these plates aid the animal in locomotion. The skin of the disk also bears small plates, which are often covered with prickles. The mouth is on the under surface of the disk, and round it are a number of short, flat processes, the mouth-papillae, which serve as strainers. Inside the mouth are seen the five tooth-plates, borne on a strong frame of complicated structure. In the sand-stars the rays are comparatively short, with their spines closely pressed to their sides, so that they look like lizards' tails; in the brittle-stars the rays are much longer and more flexible, with the spines standing out, so that they look like wriggling centipedes attached round a little sea-urchin. The brittle-stars are more active than the sand-stars, and can go more than two yards in a minute; some of them, if seized, break off their arms, which continue breaking into smaller pieces; but the body can soon grow new ones. Sand-stars and brittle-stars are found in all seas, usually occurring in quantities, but are most abundant in the rock-pools of the tropics. By constantly sweeping their arms over the sea bottom, they gather food consisting of minute animals. They eat the bait of fishermen, and their fish as well if they find any already dead, but they are themselves a favourite food with many fish, notably the cod.

The basket-fish or medusa-heads are Ophiurids whose arms branch several times, their ends often curling and interlacing. They live in deeper water and are often brought up clinging to fishermen's lines.

The feather-stars (fig. 4) have a central body and five arms, each forking at least once and fringed with small branches (pinnules) which give the feathery appearance. The mouth is in the middle of the body, and from it grooves pass along the arms and all their branches. The animal lives with the mouth upwards, and although it can crawl and even swim by movement of its arms, it generally fixes itself to a stone or seaweed or some zoophyte, by means of a bunch of small jointed and hooked processes (cirri) growing from the back or under side of the body. It gets its food in this way: the arm-grooves (ECHINODERMA, fig. 12, C) are lined with minute hairs (cilia) always waving in the direction of the mouth, towards which they drive a stream of water; this stream, containing minute

organisms, constantly flows through the coiled gut, which extracts nourishment from it. The feather-stars were formerly placed with the starfish, but they really belong to another class of Echinoderms—the Crinoidea.

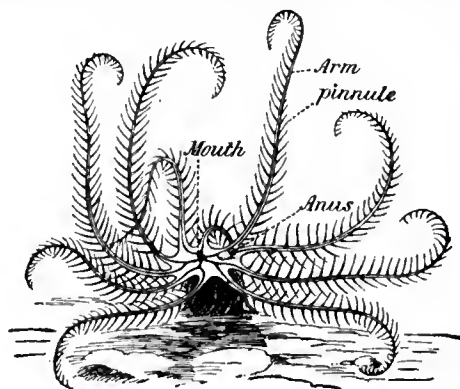

FIG. 4.—The Rosy Feather-star, *Antedon bifida*, attached by its cirri to a small stone, from which it is moving in the direction of the spectator by pushing with the branches of one arm and pulling with three branches of two arms. (Natural size.)

In 1823 J. V. Thompson, of Cork, discovered that the feather-star when quite young was fixed by a stalk, just as are nearly all crinoids (see ECHINODERMA, figs. 1 and 2). The stalked crinoids are not so numerous as they once were, but feather-stars belonging to about half a dozen genera (*Antedon*, *Actinometra*, &c.) are found in all seas at all depths, often in enormous numbers.

(F. A. B.)

STARGARD, a town of Germany, in the Prussian province of Pomerania, situated on the left bank of the navigable Ihna, 20 m. E. of Stettin on the railway to Danzig and at the junction of lines to Posen, Schneidmühl and Cüstrin. Pop. (1905), 26,908. Formerly a member of the Hanseatic League, the town retains memorials of its early importance in the large church of St Mary, built in the 14th century, the 16th-century town-hall, and some gateways and towers dating from the 14th century. The walls which formerly surrounded it have been mostly converted into promenades. Extensive new law-courts and three large barracks are among the modern buildings. Stargard has a considerable market for cattle and horses, and carries on trade in grain, spirits and raw produce. Its manufactures include cigars, tobacco, wadding and stockings; and there are also iron-foundries, and linen and woollen factories in the town.

Stargard, mentioned as having been destroyed by the Poles in 1120, received civic rights in 1229, and became the capital of eastern Pomerania. As a Hanseatic town it enjoyed considerable commercial prosperity, but it had also to undergo siege and capture in the middle ages and during the Thirty Years' War. In 1807 it was taken by Schill. The name Stargard (from the Slavonic Starogad or Starigrod, meaning "old town") is common to several other towns in the north of Germany, of which the chief are Preussisch-Stargard, near Danzig, and Stargard an der Linde in Mecklenburg-Strelitz.

See Zuck, *Führer durch Stargard* (Stargard, 1900).

STARK, JAMES (1794-1859), British painter, was born in Norwich, and as he showed strong artistic inclinations early in life was, at the age of seventeen, articled to John Crome for three years. He was elected in 1812 a member of the Norwich Society, to the exhibitions of which he had already contributed; but in 1817 he migrated to London and entered the Royal Academy Schools. He soon returned to Norwich and did not finally settle in the metropolis until 1830, though he was meanwhile a regular contributor to the British Institution and Suffolk Street Galleries. In 1840 he moved to Windsor, but after an interval of some years went back to London, where he died in 1859. Between 1831 and 1859 most of his pictures were shown at the Royal Academy, though he still continued to exhibit occasionally in other galleries. He undertook in 1827 the publication of a work on *The Scenery of the Rivers of Norfolk*, which was completed seven years later; the illustrations he

prepared for it have much topographical and artistic interest and show well the better qualities of his work. In his pictures the influence of Crome is plainly perceptible, and there is evidence also of his study of the Dutch landscape-painters; but he had little of Crome's largeness and power and his works charm rather by their gentle truth and quietness of manner than by their robustness of view or by their decisiveness of execution. There is one picture by him, "The Valley of the Yare," in the National Gallery of British Art.

STARK, JOHN (1728-1822), American soldier, was born at Nutfield, now Londonderry, New Hampshire, on the 28th of August 1728. In 1752 he was taken prisoner by the Indians but was ransomed by Massachusetts. During the Seven Years' War he served under Robert Rogers, first as a lieutenant and later as a captain, taking part in the battle of Lake George in 1755, the disastrous attack upon Ticonderoga in 1758, and the Ticonderoga-Crown Point campaign in 1759. At the beginning of the War of Independence he raised a regiment and as colonel did good service in the Battle of Bunker Hill, in the Canadian expedition, and in Washington's New Jersey campaign in the winter of 1776-77. In March 1777 he resigned his commission because other officers had been promoted over him. Later in the year, however, he was placed in command (by New Hampshire), with the rank of brigadier-general of militia, of a force of militiamen, with whom, on the 16th of August, near Bennington (*q.v.*), Vermont, he defeated two detachments of Burgoyne's army under Colonel Friedrich Baum and Colonel Breyman. For this victory, which did much to bring about the capitulation of General Burgoyne, Stark received the thanks of Congress and a commission as brigadier-general in the Continental Army (Oct. 4, 1777). He took part in the operations about Saratoga, and for a short time in 1778 and again in 1781 he was commander of the northern department. In September 1783 he was breveted major-general. He died at Manchester, New Hampshire, on the 8th of May 1822. John Stark's brother, William (1724-1776), served in the Seven Years' War and afterwards on the frontier; and at the outbreak of the War of Independence, piqued because he was not put in command of a regiment, he entered the British service.

See *Memoir and Official Correspondence of General John Stark* (Concord, N.H., 1860) by his grandson Caleb Stark (1804-1864), who wrote in 1831 *Reminiscences of the French War containing Rogers's Expeditions with the New England Rangers and an Account . . . of John Stark*.

STARLEY, JAMES (1830-1881), British inventor, the son of a farmer, was baptized at Albourne, Sussex, on the 13th of June 1830. At eighteen he ran away from home and started on foot for London, but on the way obtained work as a gardener at Lewisham, Kent, where he lived for a number of years. He had always been an ingenious mechanic, inventing trifling novelties and repairing watches and clocks in the neighbourhood, and when sewing machines began to be much used they attracted his practical attention, and aroused his inventive genius. Leaving his garden he went up to London and became working mechanic for a firm of sewing-machine makers. Here he was in his element, and in several particulars improved his principal's machines, and invented a new one with an arm attachment that permitted circular as well as straightforward work. With a fellow workman he moved in 1857 to Coventry, and started the manufacture of the "European" and other sewing machines from his patents. This was the beginning of the Coventry Machinists' Company, the pioneer of all the great bicycle and tricycle works which afterwards made that city the centre of the industry. Former acquaintances of Starley at Lewisham and elsewhere migrated to Coventry to become skilled mechanics for this company. In 1868 they began the manufacture, after a Paris model and at first for French use, of bicycles, several of the earliest suggested improvements being Starley's. A number of firms were soon devoting themselves exclusively to the manufacture of bicycles, and for one of these Starley—whose financial successes were always for others—designed the Coventry tricycle. As it was harder to propel than the bicycle he invented the balance gear, and applied it in the Salvo, which

is the type of the present tricycle (*q.v.*). Starley died on the 17th of June 1881, and a public monument has been erected to his memory in Coventry. His nephew, J. K. Starley, patented the tangent wheel in 1874.

STARLING (O. Eng. *staer stearn*, and *sterlyng*; Lat. *sturnus*; Fr. *étourneau*), a well-known bird about the size of a thrush; though at a distance it appears to be black, when near at hand its plumage is seen to be brightly shot with purple, green and steel-blue, most of the feathers when freshly grown being tipped with buff. These markings wear off in the course of the winter, and in the breeding season the bird is almost spotless. It is the *Sturnus vulgaris* of ornithologists.

A full description of the habits of the starling¹ is unnecessary in this place. A more engaging bird scarcely exists, for its familiarity during some months of the year gives opportunities for observing its ways that few others afford, while its varied song, its sprightly gestures, its glossy plumage, and, above all, its character as an insecticide—which last makes it the friend of the agriculturist and the grazer—render it an almost universal favourite. The worst that can be said of it is that it occasionally pilfers fruit, and, as it flocks to roost in autumn and winter among reed-beds, does considerable damage by breaking down the stems.² The congregations of starlings are indeed very marvellous, and no less than the aerial evolutions of the flocks, chiefly before settling for the night, have attracted attention from early times, being mentioned by Pliny (*Hist. naturalis*, x. 24) in the 1st century. The extraordinary precision with which the crowd, often numbering several hundreds, not to say thousands, of birds, wheels, closes, opens out, rises and descends, as if the whole body were a single living thing—all these movements being executed without a note or cry being uttered—must be seen to be appreciated, and may be seen repeatedly with pleasure. For a resident the starling is rather a late breeder. The nest is commonly placed in the hole of a tree or of a building, and its preparation is the work of some little time. The eggs, from 4 to 7 in number, are of a very pale blue, often tinged with green. As the young grow they become very noisy, and their parents, in their assiduous attendance, hardly less so, thus occasionally making themselves disagreeable in a quiet neighbourhood. The starling has a wide range over Europe and Asia, reaching India; but examples from Kashmir, Persia and Armenia have been considered worthy of specific distinction, and the resident starling of the countries bordering the Mediterranean is generally regarded as a good species, and called *S. unicolor* from its unspotted plumage.

Of the many forms allied to the genus *Sturnus*, some of which have perhaps been needlessly separated therefrom, those known as Grackles (*q.v.*), are separately dealt with, and here we shall only notice one other, *Pastor*, containing a beautiful species *P. roseus*, the Rose-coloured Starling, which is not an unfrequent visitor to the British Islands. It is a bird of most irregular and erratic habits—a vast horde suddenly arriving at some place to which it may have hitherto been a stranger, and at once making a settlement there, leaving it wholly deserted as soon as the young are reared. This happened in the summer of 1875 at Villafranca, in the province of Verona, the castle of which was occupied in a single day by some 12,000 or 14,000 birds of this species, as has been graphically told by Sig. de Betta (*Atti del r. ist. veneto*, 5th series, vol. ii.);³ but similar instances have been before recorded—as in Bulgaria in 1867, near Smyrna in 1856, and near Odessa in 1844, to mention only some of which particulars have been published.⁴

¹ They are dwelt on at some length in Yarrell's *British Birds*, ed. 4, vol. ii. pp. 229-241.

² A most ridiculous and unfounded charge has been, however, more than once brought against it—that of destroying the eggs of skylarks. There is little real evidence of its sucking eggs, and much of its not doing so; while, to render the allegation still more absurd, it has been brought by a class of farmers who generally complain that skylarks themselves are highly injurious.

³ A partial translation of this paper is given in the *Zoologist* for 1878, pp. 18-22.

⁴ It is remarkable that on almost all of these occasions the locality pitched upon has been, either at the time or soon after, ravaged

STARNBERG, a village and climatic health resort of Germany, in the kingdom of Bavaria, on the Starnberger See, 16 m. by rail S. from Munich. Pop. (1905), 3257. It has an evangelical and a Roman Catholic church, an old castle (now government offices) and a bathing establishment. The Starnberger See (or Würmse) is a lake with a length of 12 m., a breadth of 3 m., and covering 23 sq. m. Its greatest depth is about 400 ft. The lake is girdled by hills, studded with attractive villa residences, commanding beautiful and extensive views of the Alps. On the Roseninsel, an island in the lake, remains of lacustrine dwellings have been discovered. The waters abound in fish. In the summer steamboats ply, touching at all the villages lying on the shores.

See Ule, *Der Würmse in Oberbayern* (Leipzig, 1901).

STAR-NOSED MOLE (*Condylura cristata*), a North American species, the single representative of its genus. In burrowing habits it resembles the European mole, but is distinguished from all other members of the family *Talpidae* by the presence of a ring of tentacles round the nostrils, probably serving as organs of touch.

STARODUB, a town of Russia, in the government of Chernigov, 98 m. N.E. of the city of Chernigov. It is regularly built, with broad straight streets, and the houses are surrounded by large gardens. Pop. 12,451; Little Russians with about 5000 Jews. Tanning and the manufacture of copper wares are carried on, and there is a trade in corn and hemp exported to Riga and St Petersburg. As early as the 11th and 12th centuries Starodub was a bone of contention between different Russian princes, who appreciated its strategic position. The Mongols seem to have destroyed it in the middle of the 13th century, and its name does not reappear until the following century. During the 15th and 16th centuries the Russians and Lithuanians were continually disputing the possession of its fortress, and at the beginning of the 17th century it became a stronghold of Poland.

STARVATION, the state of being deprived of the essentials of nutrition, particularly of food, the suffering of the extremities of hunger and also of cold (see HUNGER AND THIRST). The word is an invented hybrid, attributed, according to the accepted story, to Henry Dundas, 1st Viscount Melville, who used it in a parliamentary debate on American matters in 1775 and gained thereby the nickname of "Starvation Dundas" (see H. Walpole's *Letters*, ed. Cunningham, viii. 30; and *Notes and Queries* no. 225). The English word "to starve" meant originally "to die," as in O. Eng. *stcorfan*, Du. *sterven*, Ger. *sterben*, but was particularly applied to death from hunger or cold.

STAS, JEAN SERVAIS (1813-1891), Belgian chemist, was born at Louvain on the 21st of August 1813. He studied for a medical career and took his doctor's degree, but soon turned to chemistry. In 1835 after much trouble he gained admission to J. B. A. Dumas's laboratory in Paris in order to continue a research on phloridzin which he had begun in an attic in his father's house, and he was associated with that chemist in several researches, including his redetermination of the atomic weight of carbon. In 1840 he left Paris on his appointment to the chair of chemistry at the École Royale Militaire in Brussels. There he remained for more than a quarter of a century, but before he had served the thirty years necessary to secure a pension he was obliged to resign through a malady which affected his speech. He was then appointed to a post in connexion with the Mint, but gave it up in 1872, and spent the rest of his life in retirement in Brussels, where he died on the 13th of December 1891. Stas's name is best known for his determination of the atomic weights of a number of the more important elements. His work in this field was marked by extreme care, and he adopted the most minute precautions to avoid error, with such success that the greatest variation between his numerous

by locusts, which the birds greedily devour. Another fact worthy of attention is that they are often observed to affect trees or shrubs bearing rose-coloured flowers, as *Nerium oleander* and *Robinia viscosa*, among the blossoms of which they themselves may easily escape notice, for their plumage is rose-pink and black shot with blue.

individual determinations for each element was represented by from 0.005 to 0.01. Though he started with a predilection in favour of Prout's hypothesis he was later led by the results he obtained and by his failure to find any evidence of dissociation in the elements to regard it as a pure illusion and to look upon the unity of matter as merely an attractive speculation unsupported by proof. Nevertheless, a few years before his death, à propos of the close approximation to integers presented by a number of the atomic weights of the elements when hydrogen is taken as unity, he remarked, "Il faut croire qu'il y a quelque chose là-dessous." In connexion with the poisoning of Count Hippolyte de Bocarmé with nicotine in 1850 Stas worked out a method for the detection of the vegetable alkaloids, which, modified by Friedrich Julius Otto (1809-1870), professor of chemistry at Brunswick, has been widely used by toxicologists as the Stas-Otto process.

STASINUS, of Cyprus, according to some ancient authorities the author of the *Cypria* (in 11 books), one of the poems belonging to the epic cycle. Others ascribed it to Hegesias (or Hegesinus) of Salamis or even to Homer himself, who was said to have written it on the occasion of his daughter's marriage to Stasinus. The *Cypria*, presupposing an acquaintance with the events of the Homeric poem, confined itself to what preceded, and thus formed a kind of introduction to the *Iliad*. It contained an account of the judgment of Paris, the rape of Helen, the abandonment of Philoctetes on the island of Lemnos, the landing of the Achaeans on the coast of Asia, and the first engagement before Troy. It is probable that the list of the Trojans and their allies (*Iliad*, ii. 816-876), which formed an appendix to the catalogue of the Greek ships, is abridged from that in the *Cypria*, which was known to contain a list of the Trojan allies. Proclus, in his *Chrestomathia*, gave an outline of the poem (preserved in Photius, *cod.* 239).

See F. G. Welcker, *Der epische Cyclus* (1862); D. B. Monro, Appendix to his edition of *Odyssey*, xiii.-xxiv. (1901); T. W. Allen, "The Epic Cycle," in *Classical Quarterly* (Jan. 1908, sqq.); and CYCLE.

STASSFURT, a town of Germany, in the Prussian province of Saxony, and one of the chief seats of the German salt-producing industry, situated on both sides of the Bode, 20 m. S.W. of Magdeburg by the railway to Aschersleben. Pop. (1905), 18,310. It is still surrounded in part by the ruins of its ancient walls, but, with the exception of the parish church of St John (15th century), there are no buildings worthy of special notice. Although saline springs are mentioned here as early as the 13th century, the first attempt to bore for salt was not made until 1839, while the systematic exploitation of the salt-beds, to which the town is indebted for its prosperity, dates only from 1856. The shafts reached deposits of salt at a depth of 850 ft., but the finer and purer layers lie more than 1100 ft. below the surface. Besides the rock-salt, which is excavated by blasting, the saline deposits of Stassfurt yield a considerable quantity of deliquescent salts and other saline products, which have encouraged the foundation of numerous chemical factories in the town and in the neighbouring village of Leopoldshall, which lies in Anhalt territory. The rock-salt works are mainly government property, while the chemical factories are in private hands.

See Precht, *Salzindustrie von Stassfurt und Umgebung* (Stassfurt, 1891); and Westphal, *Geschichte des königlichen Salzwerks zu Stassfurt* (Berlin, 1901).

STATE. As currently employed in that department of political science which concerns itself, not with the relations of separate political entities, but with the political composition of society as a whole, the word state *Definition.* expresses the abstract idea of government in general, or the governing authority as opposed to the governed, and is thus used by Herbert Spencer in all his discussions of government and society. Louis XIV.'s "l'état, c'est moi," Rousseau's theory of the "contrat social," Bastiat's "donne à l'état le strict nécessaire et garde le reste pour toi," all imply this opposition. Hobbes regards the state, or, as he calls it, the commonwealth, as "one person for whose acts a great multitude by

mutual covenants, one with another, have made themselves every one the author, to the end he may use the means and strength of them all as he shall think expedient for their peace and common defence."

The term is also used to distinguish the civil from the ecclesiastical authority in countries where they are or have been in conflict.

A large number of definitions and classifications, according to political structure, international status, national homogeneity, &c., have been attempted, but it is beyond the scope of a short article to do more than mention these different senses of a word so variously employed.

In international law the term has a more precise meaning, according to which the state is the external personality or outward agency of an independent community.

**Attributes
in Inter-
national
Law.**

In its fullest form its attributes are: (a) possession of sovereign power to pledge the community in its relations with other similarly sovereign communities, (b) independence of all external control, and (c) dominion over a determinate territory. In practice, however, there are still incomplete forms of states which join in the international life of states, paramount states whose relations to subordinate parts of their empire are in a condition of uncertainty, and there is, at any rate, one body carrying on international state intercourse without dominion over any territory at all. Thus, Great Britain, has diplomatic relations, purely formal though they may be, with several of the subordinate states forming the German Empire. Egypt, while legally under the suzerainty of the Porte, is practically a British protectorate. Great Britain treats Cyprus as a dependency, though she is in mere occupation of the island for the purpose of carrying out certain reforms for the protection of Christians. Austria-Hungary considered herself in the same position, though she occupied Bosnia and Herzegovina "without affecting the rights of sovereignty of his majesty the Sultan on those provinces." Though Bulgaria, by the Treaty of Berlin, was an "autonomous and tributary principality under the suzerainty of his imperial majesty the Sultan," Turkey did not consider her suzerainty to involve her in the war of 1885 between her vassal and Servia. The Roman Catholic Church has permanent diplomatic relations as an independent state, though it has no independent territory against which international rights can be enforced. We saw in the Boer War the army of an annexed community wandering from place to place recognized as a belligerent with whom Great Britain negotiated as an independent state.

A new and somewhat shadowy form of suzerainty is growing up in the "paramountcy" first enunciated (with the concurrence of Great Britain) by the President of the United States in 1823 (see MONROE DOCTRINE), asserted with a certain measure of success against Great Britain in 1896 (see VENEZUELA, also ARBITRATION), and proclaimed formally by the United States at the Hague peace conference in 1899 as a condition of her signature of the Peace Convention. While the Spanish republics of Central and South America are recognized in international law as sovereign states, they can only be said to fulfil the conditions of absolute independence subject to the limitations which the Monroe Doctrine has placed upon their treaty-making powers with Europe.¹

¹ Great Britain, in acceding to the arbitration imposed by President Cleveland, has, in the opinion of a number of American and Continental publicists, recognized the Monroe Doctrine. See Chrétien, *Principes*; De Beaumarchais, *La Doctrine de Monroe*; De Bustamente, *Le Canal de Panama et le droit international*; De Pressensé, "La Doctrine de Monroe et le conflit anglo-américain," *Revue des deux mondes* (1896); also the writings of Ridgway, W. L. Scruggs, Sibley and G. F. Tucker, and the *Annales de jurisprudence* (Colombia), June 1897 and following numbers. M Pradier-Fodéré, Professor of International Law at Lyons University, and formerly professor of the University of Lima, observes that "En déclarant que la grande république américaine considérerait comme dangereuse pour sa tranquillité et sa sécurité toute tentative de la part des puissances européennes d'étendre leur système politique à une partie quelconque du continent américain, il (le président) s'est mêlé indirectement des affaires intérieures des républiques du Nouveau Monde, autres que les États Unis; il a fait

"In constitutional law, the state," says a leading English authority, "is the power by which rights are created and maintained, by which the acts and forbearances necessary for their maintenance are habitually enforced" (Anson, *Law and Custom of the Constitution*, pt. i. p. 2). In France, where the state embraces a hierarchy of bodies and authorities culminating in the president of the republic, whose acts are the final form of a series of incomplete acts of the members of the hierarchy, it comes nearer to the theoretical meaning of the word. In Great Britain the sovereign power of the state is diffused among a number of authorities which have rights against each other and stand in independent relation towards the individual citizens. Actions can be brought by private citizens in the ordinary law courts against individual authorities, and there is no system of hierarchical responsibility which prevents a state official from being personally accountable for his administrative conduct. In A. V. Dicey's admirable *Introduction to the Study of the Law of the Constitution*, this distinction between the French, or, as we should rather call it, continental system of entire subordination of the organs to the state as a whole, and the less logical British system is dwelt upon. "Few things," he observes, "are more instructive than the examination of the actions which have been brought in Great Britain against officers for retaining ships about to proceed to sea. Under the Merchant Shipping Act 1876 the board are open to detain any ship which, from its unsafe and unseaworthy condition, is a serious danger to human life." "Most persons would suppose that the officials of the board of trade, so long as they—bona fide and without malice or corrupt motive—endeavour to carry out the provisions of the statute, would be safe from action at the hands of a shipowner. This, however, is not so. The board and its officers have more than once been sued with success. They have never been accused of either malice or negligence, but the mere fact that the board acts in an administrative capacity is not a protection to the board; nor is mere obedience to the orders of the board an answer to an action against its servants" (p. 324).

In England, we may say, the notion of state, from the constitutional point of view, is still inchoate, but the play of international intercourse seems to be gradually leading to a clearer conception of the fact that an increasing national responsibility requires a corresponding increase in the power of co-ordinate state control. An instance of its absence is shown by the loose way in which the British Crown has granted governing powers to chartered companies (see RAID). This uncertainty applies as much to the United States as to Great Britain. In the Louisiana lynching riots, of which some Italian citizens were the victims, it was contended that the United States government was not responsible, and that the responsibility fell upon the government of Louisiana alone. This contention could not be pressed, and compensation was of course paid to Italy. Similar difficulties arose in connexion with the Japanese school question in California. The subject is well known to have raised apprehension as to the adequacy of the United States system to meet its centralized state responsibilities.

Another, and, in some respects, more dangerous feature of an inchoate conception of state responsibility is the growing apart, so to speak, of certain British dependencies. The British state, for international purposes, is the British Empire, for domestic purposes it is the United Kingdom. Any limb of the former's huge body can have interests different from those of the United Kingdom, and involve its responsibility. A significant step towards concentration of liability and control was taken by the Australian colonies in the federation brought about by the Commonwealth Act of 1900. Under this act, by the way, an element of confusion has been created by the application of the term "state" to the federating colonies. Section 6 of the act provides "the states" shall mean such of the colonies of New de l'intervention par anticipation et au profit de l'Union; car, c'est d'intervenir que d'interdire aux autres gouvernements d'intervenir."

**British
and Con-
tinental
Con-
ceptions.**

South Wales, New Zealand, Queensland, Tasmania, Victoria, West Australia and South Australia as for the time being are parts of the Commonwealth, and such colonies or territories as may be admitted into or established by the Commonwealth as states; and each of such parts of the Commonwealth shall be called "a state." "Original states" shall mean "such states as are parts of the Commonwealth at its establishment." Following out this distinction between the Commonwealth and the states, articles 106 to 124 of the Commonwealth constitution deal with the respective positions of the Commonwealth, the original states, and the new states. Article 109 in particular provides that "when a law of a state is inconsistent with the law of the Commonwealth, the latter shall prevail, and the former shall, to the extent of the inconsistency, be invalid," thus paving the way for the ultimate consolidation of the federal power.

Much has been written on the "science" of the state, or, as we prefer, in Anglo-Saxon lands, to call it, "political science." In Germany the subject is dealt with as an independent branch of university education. Several of her universities have a *staatswissenschaftliche Facultät*, granting a special degree in the subject. In consequence of the great attention paid to the subject in Germany, her state polity has been largely the work of her political writers. The result has not unnaturally tended to a system bearing some resemblance to that of the American Union, with this very important difference, however, that whereas in the United States the federal power is derived from the democratic forces of the individual states, in Germany it is derived from their aristocratic and absolutist forces. German political thinkers, in fact, have worked out *Staatsrecht* as a comparative study, in which arguments in favour of absolute government have received as much careful consideration as those in favour of democratic institutions, and the German state has developed upon lines based on the best theoretical arguments of these thinkers. There is, therefore, no anomaly in its practically absolutist government working out the most democratic reforms as yet put into legislative form. It follows, however, that German theories are of little use in the consideration of the state problems with which British and American political thinkers have to deal. Anglo-Saxon institutions are following their independent development, and if the influence of foreign institutions is felt at all, it is probably that of the clear logical detail and cohesion of French institutions.

AUTHORITIES.—Rehm, *Geschichte der Staatsrechtswissenschaft* (1896), *Allgemeine Staatslehre* (1899); R. von Mohl, *Geschichte und Literatur der Staatswissenschaften* (1855–1858); Hildebrand, *Geschichte und System der Rechts- und Staatsphilosophie* (1866); Gierke, *Das deutsche Genossenschaftsrecht* (1881); I. F. Stahl, *Die Staatslehre und die Principien des Staatsrechts* (1870); Bluntschli, *Geschichte des allgemeinen Staatsrechts und der Politik* (1867); *Lehre vom modernen Staate* (1884–1885), i., ii.; *Politik* (1876); Seydel, *Grundzüge der allgemeinen Staatslehre* (1873); Lingg, *Empirische Untersuchungen zur allgemeinen Staatslehre* (1890); Bornhak, *Allgemeine Staatslehre* (1896); Jellinek, *Recht des modernen Staates* (1900); R. Schmidt, *Allgemeine Staatslehre* (1901); von Treitschke, *Politik* (1898); Laband, *Staatsrecht des deutschen Reiches*, 2 Bde. (1895); Haenel, *Deutsches Staatsrecht* (1892); Janet, *Histoire de la science politique* (1887); Boutmy, *Études de droit constitutionnel* (1899); Comtois, *La Conception juridique de l'état* (1899); Esmein, *Éléments de droit constitutionnel français et étranger* (1899); Hauriou, *Précis de droit administratif et de droit public général* (1900); Le Fur, *État fédéral et confédération d'états* (1896); Henry Michel, *L'Idée de l'état* (1896); Michaud, "De la Responsabilité de l'état à raison des fautes de ses agents," *Revue du droit public et de la science politique* (1895); Pillet, *Recherches sur les droits fondamentaux des états dans l'ordre des rapports internationaux* (1899); Fabreguettes, *Société, état, patrie* (1898); Daloz, *Répertoire du droit français*, t. 21, p. 37; Amos, *Science of Politics* (1883); Green, *Lectures on the Principles of Political Obligation* (1895); Pollock, *Introduction to the History of the Science of Politics* (1890; 3rd ed., 1900); Anson, *Law and Custom of the Constitution* (3rd ed., pt. i., 1897); Holland, *Jurisprudence* (10th ed., 1906); Dicey, *Introduction to the study of the Law of Constitution* (5th ed., 1897); Ilbert, *Legislative Methods and Forms* (1901); Kovalevsky, *Russian Political Institutions* (Chicago, 1902).

(T. BA.)

STATE, GREAT OFFICERS OF, a designation popularly applied to all the principal ministers of the British Crown, but

strictly applicable only to the lord high steward, the lord high chancellor, the lord high treasurer, the lord-president of the (privy) council, the lord (keeper of the) privy seal, the lord great chamberlain, the lord high constable, the earl marshal, and the lord high admiral. Of these, three—the lord chancellor, the lord-president of the council, and the lord privy seal—the first and second are always, and the third almost always, cabinet ministers. The offices of two more—those of the lord treasurer and the high admiral—are now executed by commission, the chief of the lords commissioners, known severally as the first lord of the treasury and the first lord of the admiralty, being likewise members of the cabinet, while the first lord of the treasury is usually at the head of the government. But, although it has become the rule for the treasury and the admiralty to be put in commission, there is nothing except usage of longer or shorter duration to prevent the Crown from making a personal appointment to either of them, and the functions which formerly appertained to the lord treasurer and the high admiral are still regularly performed in the established course of the national administration. The four offices of the high steward, the great chamberlain, the high constable, and the earl marshal stand on a different footing, and can be regarded at the present day as little else than survivals from an earlier condition of society. They have practically ceased to have any relation to the ordinary routine of business in the country or of ceremonial in the palace, and the duties associated with them have either passed entirely into abeyance or are restricted within extremely narrow limits, save on certain occasions of exceptional pomp and solemnity. All of them were once hereditary, and, taking the three kingdoms together, they or their counterparts and equivalents continue to be held by right of inheritance in one or other of them even now. These and the more important foreign great offices of state are all dealt with under their proper headings, and other information will be found in the articles **CABINET, MINISTRY, PRIVY COUNCIL, TREASURY, and HOUSEHOLD, ROYAL.**

On the subject of the great offices of state generally, see Stubbs, *Constitutional History*, ch. xi.; Freeman, *Norman Conquest*, ch. xxiv.; Gneist, *Constitution of England*, ch. xvi., xxv. and liv.; also Gibbon, *Decline and Fall*, ch. liii., and Bryce, *Holy Roman Empire*, ch. xiv.

STATEN ISLAND, an island constituting the borough of Richmond, New York City, and Richmond county, the southernmost of the counties of the state of New York. It is separated from Long Island on E. by the Narrows which connect Upper and Lower New York Bay; from New Jersey on the N. by the narrow channel of Kill van Kull which connects New York Bay with Newark Bay; and from New Jersey on the W. by the narrow channel of Staten Island Sound or Arthur Kill; and on its S.E. coast are Lower New York, Raritan and Prince's Bays, Great Kills, and the Atlantic Ocean. Pop. (1890), 51,693; (1900), 67,021; (1905), 72,845; (1910), 85,969. Staten Island is connected by ferry with the borough of Manhattan, 5 m. distant, and with Perth Amboy, New Jersey. The Staten Island Rapid Transit railway extends along the north shore and the south-east side, and there are several electric lines and pleasant drives. The island is triangular in shape, is 13½ m. long from north-east to south-west, has a maximum width of nearly 8 m. at its north end, and has an area of about 70 sq. m. The north-east quarter is broken by two ranges of hills having a precipitous east slope and rising to a maximum height of about 400 ft., 1 m. inland from the Narrows; but on the west and south the hills fall gently to the Coastal Plain, which, occupying the greater part of the island, is broken only by low morainal ridges and terminates in salt marshes along much of the west coast. There are many species of forest trees and more than 1300 species of flowering plants and ferns. The climate is subject to sudden changes, but the temperature rarely rises above 90° F. or falls below zero. The island is chiefly a residential district, and in the picturesque hill section are many fine residences. Forts Wadsworth and Tompkins commanding the passage of the Narrows constitute one of the strongest defences of New York Harbor. The principal villages are New Brighton, West New Brighton, Port Richmond, Stapleton, and Tompkinsville on the north coast,

and Tottenville (or Bentley Manor) on the south-west coast. Richmond, the county-seat since 1727, is a small village near the centre of the island. South Beach, below the Narrows, is a popular seaside resort. At West New Brighton is a large dyeing establishment, there are also ship-building yards, oyster fisheries, and truck farms, and among the manufactures are linoleum, paper, white lead, linseed oil, brick, and fire-clay products.

When discovered by Europeans Staten Island was occupied by the Aquehonga Indians, a branch of the Raritans, and several Indian burying-grounds, places where wampum was manufactured, and many Indian relics, including a stone head with human features, have been found here. In 1630 the Dutch West India Company granted the island to Michael Pauw as a part of his patroonship of Pavonia, and it was bought at this time from the Indians for "some duffels, kettles, axes, hoes, wampum, drilling awls, jew's harps, and divers other small wares"; but before Pauw had established a settlement upon it he sold his title back to the company. A portion of it was regranted to David Pietersen de Vries in 1636 and in 1642 the remainder was erected into a patroonship and granted to Cornelis Melyn. In 1641 de Vries established a settlement at Oude Dorp (Old Town), near Arrochar Park, near South Beach. It was destroyed by the Indians in the same year, was immediately rebuilt, was again destroyed in 1642 and was again rebuilt, but was abandoned after its destruction for the third time in 1655. A company of Waldenses founded a second settlement in 1658, at Stony Brook, about 2 m. west of the ruins of Oude Dorp; this was the principal village for many years and from 1683, when the island was erected into a county, until 1727 it was the county-seat. Melyn surrendered his rights as a patroon in 1661 and during the remainder of the Dutch régime many small grants of land were made to French, Dutch, and English settlers. In 1664 the duke of York became proprietor of the newly erected province of New York and by his grant in the same year to Berkeley and Carteret of all that portion which lay west of the Hudson river, Staten Island became properly a part of New Jersey, but in 1668 the duke decided that all islands within New York Bay which could be circumnavigated in twenty-four hours should be adjudged to New York. Captain Christopher Billopp made the trip within the time limit and was rewarded with a grant of 1163 acres at the south end of the island. He erected this into the Manor of Bentley and the manor house, built about this time, still stands in the village of Tottenville. It was in this house that Lord Howe on the 11th of September 1776 held a peace conference with Benjamin Franklin, John Adams, and Edward Rutledge representing the Continental Congress. The British army under Sir William Howe landed at the Narrows on the 3rd of July 1777 and until the close of the war Staten Island was held by the British and Loyalists. From it the British made frequent predatory raids into New Jersey and the Americans made several retaliatory raids into the island. Under the direction of General Hugh Mercer some American troops reached Richmond on the morning of the 16th of October 1776, and in an engagement which immediately followed they were victorious; but, as they were retreating with their prisoners, British reinforcements arrived and in a second engagement at Fresh Kill (now Green Ridge) they were routed with considerable loss. A second raid was made against Richmond early in August 1777; and on the 22nd of the same month American troops under General John Sullivan fought the British at several places, inflicted a loss of about 200 killed, wounded and prisoners and destroyed considerable quantities of stores. In the War of 1812 Fort Richmond was built at the Narrows and Fort Tompkins in the rear of it. The Federal government bought the site in 1847 and after destroying the old forts began the erection of the present works. In 1898 Staten Island became the borough of Richmond in Greater New York.

See I. K. Morris, *Memorial History of Staten Island* (2 vols., New York, 1898-1900); R. M. Bayles, *History of Richmond County* (New York, 1887); and J. J. Clute, *Annals of Staten Island* (New York, 1877).

STATE RIGHTS, a term used generally in political science to denote those governmental rights which belong to the individual states of a federal union, there being a certain sphere of authority in which these individual states may act without interference from the central government. Thus in the United States there were certain rights reserved to themselves by the states when forming the union under the constitution of 1787. These rights the central government is by fundamental law bound to respect, and they can be reduced only by amendment to the constitution. For a thousand years the various German states were so jealous of any curtailment of their individual rights as to prevent the formation of an efficient federal government; in Austria-Hungary the larger states still jealously guard their liberties. In federal unions, such as Mexico and Brazil where a central authority existed first and created the states, the belief in state rights is much weaker than it is in unions composed of originally independent states. The rights of a state are said to be delegated when, as in Mexico, Brazil and Colombia, the constitution is created by a central national authority which also makes the states; state rights are residuary when independent states unite to delegate by a constitution certain powers to a central government, as in the case of the German Empire, Austria-Hungary, the United States, Switzerland, and until 1905, Sweden-Norway. History shows that states forming unions of the second class are certain in after time to deny or assert that the sovereignty of the state is one of the rights reserved, according as the state belongs to a stronger or weaker section or faction; state sovereignty being the defence of the weaker state or faction, and being denied by the stronger group of states which controls the government and which asserts that a new sovereign state was created by a union of the former independent ones. This dispute is usually ended by civil war and the destruction of state sovereignty. The evolution of state rights as shown in the history of the United States is typical. Thirteen independent states formed a union in 1787 under a constitution reserving certain rights to the states. The sphere of the state authority embraced most of the powers of government, except, for instance, those relating to foreign affairs, army and navy, inter-state commerce, coinage and the tariff; the powers of the central government were specified in the fundamental law. Most of the states claimed at one time or another that sovereignty was one of the reserved rights of the states and on this theory the Southern states acted in the secession in 1861. The war that resulted destroyed all claims of state sovereignty. The other rights of the states consisted of those not delegated to the central government or forbidden to the states by the constitution. In case of doubt the presumption was in favour of the state. Since the beginning, however, the central government has gained strength at the expense of the states, seldom by direct usurpation (except during the Civil War and Reconstruction, 1861-76), but indirectly through use and custom, as the country and people developed and new conditions of government arose. The field of state rights had not increased, while centralization has slowly but surely taken place. This centralization is shown not only by the increased power and activity of the Federal government as compared with the state governments, but in the change in popular opinion indicated by the use of the terms *National*, *Union*, &c., where formerly *Confederate*, *Federal*, &c., were used, and in the use of singular verbs after the words *Congress* and the *United States*, where formerly they were followed by plural verbs.

The central authority in the United States, formerly almost unheard of by the average citizen, now touches him in many of the activities of life and sometimes intrudes even into the domain of local self-government. The history of the decay of state rights makes it seem doubtful if the federal form of government is a permanent one, or is only a transient form between independent state governments or loose confederacies and a centralized national government.

See J. W. Burgess, *Political Science and Comparative Constitutional Law* (New York, 1895); Woodrow Wilson, *The State* (new ed.,

New York, 1903); A. H. Stephens, *Constitutional View of the War Between the States* (Philadelphia, 1868-1870); and A. L. Lowell, *Governments and Parties in Continental Europe* (Boston, 1896).

STATES-GENERAL, the English translation of (1) the *États-Généraux* of France before the Revolution, (2) the *Staten-Generaal* of the Dutch Netherlands. The name in both cases signifies, whatever the ultimate divergence in character of the two bodies, the assembly of the representatives of the various estates of the realm, called together for purposes of legislation or deliberation.

The French States-General.—In France the States-General owed their origin to the same causes which produced the Parliament of England, the Cortes of Spain, the Diet of the Holy Roman Empire and the Diets (*Landtage*) of the states of Germany, and they resembled these assemblies in their constitution. In these countries the royal or ducal power, when it began to extend its scope, found itself limited by the feudal system and had to turn to the forces of feudalism to obtain from them aid and counsel, *i.e.* pecuniary assistance and moral support. Instead of treating severally with the local representatives of these forces the ruler found it useful and convenient to enter into contact with them as a whole, treating with them through their principal representatives.

In France these conditions led in 1302 to a general assembly consisting of the chief lords, both lay and ecclesiastical, and the representatives of the principal privileged towns, which were like distinct lordships. There had, of course, been certain precedents before 1302 which had, as it were, paved the way for this institution; the representatives of the principal towns had several times been convoked by the king, and under Philip III. there had been assemblies of nobles and ecclesiastics in which the two orders had deliberated separately. It was the dispute between Philip IV. the Fair and Boniface VIII. which led to the States-General of 1302; the king of France desired that, in addition to the officers of the Crown, the principal authorities of the country should come and testify solemnly that they were at one with the king in this serious crisis. The letters summoning the assembly of 1302 are published by M. Georges Picot in his collection of *Documents inédits pour servir à l'histoire de France*. In 1302 the States-General had been called upon only to give *counsel* to the king; but during the same reign they were several times assembled to give him *aid*, *i.e.* to grant him subsidies, and in course of time this came to be the most frequent motive of their convocation.

In one sense the composition and powers of the States-General have always been the same. They have always included representatives of the clergy, nobility and third estate, and they have always been summoned either to grant subsidies or to advise the Crown, to give *aid and counsel*. Their composition, however, as well as their effective powers, have varied greatly at different times.

In their primitive form, *i.e.* in the 14th and the first half of the 15th centuries, the States-General had only a limited elective element. The lay lords who appeared therein were not elected, but directly chosen and summoned by the king, and the same was the case with the prelates, bishops and clergy, who were summoned *quâ* ecclesiastical lords. In the order of the clergy, however, since certain ecclesiastical bodies, *e.g.* abbeys and chapters of cathedrals, were also summoned to the assembly, and as these bodies, being persons in the moral but not in the physical sense, could not appear in person, their representative had to be chosen by the monks of the convent or the canons of the chapter. It was only the representation of the third estate which was furnished by election. Originally, moreover, the latter was not called upon as a whole to seek representation in the estates. It was only the *bonnes villes*, the privileged towns, which were called upon. They were represented by elected *procureurs*, who were frequently the municipal officials of the town, but deputies were often elected for the purpose. The country districts, the *plat pays*, were not represented.

It was during the last thirty years of the 16th century that the States-General became an entirely elective body and really

representative of the whole nation as divided into three parts. This was brought about by various causes. On the one hand, the nobles and prelates who were summoned were not always inclined to attend the estates, so had themselves represented by an envoy, a *procureur*, as they had the right to do, and frequently the lords or prelates of the same district chose the same *procureur* to represent them. On the other hand, the Crown seems at that time to have felt the need of having the consent of representatives really expressing the will and feelings of all the orders, and especially of the third estate as a whole. The letters of summons to the States-General of 1484 invited the ecclesiastics, nobles and third estate in general, to meet at the chief town of their *bailliage* or *sénéchaussée* and elect deputies. An intermediate form had been employed in 1468 when the prelates and lords had still been summoned personally, but the towns had each elected three deputies, an ecclesiastic, a noble and a burgess.

At the estates of 1484 there seems to have been universal and direct suffrage for all the three orders. But the *roturiers* of the country districts could not in practice avail themselves of this power; so the country communities and small towns spontaneously elected delegates to represent them at the electoral assembly. Thus a system of indirect election arose for the third estate which became confirmed and subsequently continued to be used. To a certain extent there were sometimes more than two degrees in the suffrage; the delegates nominated by the country communities would gather together with the electors chosen by the neighbouring little town, and appoint with them new delegates to represent them at the electoral assembly of the *bailliage*. This ultimately became the system. For the clergy and nobles the suffrage remained direct; but as a rule only such ecclesiastics were admitted to the assembly of the *bailliage* as possessed a benefice, and only such lords as had a fief.

The effective powers of the States-General likewise varied in the course of time. In the 14th century they were actually great. The king could not, in theory, levy general taxation. Even in the provinces attached to the domain of the Crown, he could only levy it where he had retained the *haute justice* over the inhabitants, but not on the subjects of lords having the *haute justice*. The privileged towns had generally the right of taxing themselves. In order to obtain general taxes, the king had to obtain the consent of the lay and ecclesiastical lords and of the towns; this amounted to obtaining the authorization of the States-General, which only granted these subsidies temporarily for a fairly short period. The result was that they were summoned fairly frequently and that their power over the Crown might be considerable.

But in the second half of the 14th century certain royal taxes levied throughout the whole of the domain of the Crown, tended to become permanent, and independent of the vote of the estates. This sprang from many causes, but from one in particular; the Crown endeavoured by transforming and changing the nature of the "feudal aid" to levy a general tax by right, on its own authority, in such cases as those in which a lord could demand feudal aid from his vassals. For instance, it was in this way that the necessary taxes were raised for twenty years to pay the ransom of King John without a vote of the States-General, although they met several times during this period. Custom confined this tendency. Thus during the second half of the 15th century the chief taxes, the *taille*, aids and *gabelle* became definitely permanent for the benefit of the Crown, sometimes by the formal consent of the States-General, as in 1437 in the case of the aids. The critical periods of the Hundred Years' War had been favourable to the States-General, though at the price of great sacrifices. Under the reign of King John they had had for a few years, from 1355 to 1358, not only the voting, but through their commissaries, the administration of and jurisdiction over the taxes. In the first half of the reign of Charles VII. they had been summoned almost every year and had patriotically voted subsidies. And when the struggle was over they renounced, through weariness

and a longing for peace, their most precious right, the power of the purse.

At the estates of 1484, however, after the death of Louis XI., there was a kind of awakening. The deputies of the three orders united their efforts in perfect harmony in the hope of regaining the right of periodically sanctioning taxation. They voted the *taille* for two years only, at the same time reducing it to the amount which it had reached at the end of the reign of Charles VII. They even demanded, and obtained, the promise of the Crown that they should be summoned again before the expiry of the two years. But the promise was not kept, and we do not find the States-General summoned again till 1560. There was then a first interruption of 76 years in the working of the institution, while the absolute monarchy was establishing itself. But there was a revival of its activity in the second half of the 16th century caused by the scarcity of money and the quarrels and wars of religion. The estates of Orleans in 1560, followed by those of Pontoise in 1561, and those of Blois in 1576 and 1588 were most remarkable for the wisdom, courage and efforts of the deputies, but on the whole were lacking in effect. Those of 1588 were ended on a regular *coup d'état* effected by Henry III., and the States summoned by the League, which sat in Paris in 1593 and whose chief object was to elect a Catholic king, were not a success. The States-General again met in Paris in 1614, on the occasion of the disturbances which followed the death of Henry IV.; but though their minutes bear witness to their sentiments of exalted patriotism, the dissensions between the three orders rendered them weak and they were dissolved before having completed their work, not to be summoned again till 1789.

As to the question whether the States-General formed one or three chambers for the purposes of their working, from the constitutional point of view the point was never decided. What the king required was to have the consent, the resolution of the three estates of the realm; it was in reality of little importance to him whether their resolutions expressed themselves in common or separately. At the States-General of 1484 the elections were made in common for the three orders, and the deputies also arrived at their resolutions in common. But after 1560 the rule was that each order should deliberate separately; the royal declaration of the 23rd of June 1789 even stated that they formed three distinct chambers. But Necker's report to the *conseil du roi* according to which the convocation of 1789 was decided, said (as did the declaration of the 23rd of June), that on matters of common interest the deputies of the three orders could deliberate together, if each of the others decided by a separate vote in favour of this, and if the king consented.

The working of the States-General led to an almost exclusive system of deliberation by committee, as we should say nowadays. There were, it is true, solemn general sessions, called *séances royales*, because the king presided; but at these there was no discussion. At the first, the king or his chancellor announced the object of the convocation, and set forth the demands or questions put to them by the Crown; at the other royal sessions each order made known its answers or observations by the mouth of an *orateur* elected for the purpose. But almost all useful work was done in the sections, among which the deputies of each order were divided. At the estates of 1484 they were divided into six *nations* or *sections*, corresponding to the six *généralités* then existing. Subsequently the deputies belonging to the same *gouvernement* formed a group or bureau for deliberating and voting purposes. Certain questions, however, were discussed and decided in full assembly; sometimes, too, the estates nominated commissaries in equal numbers for each order. But in the ancient States-General there was never any personal vote. The unit represented for each of the three orders was the *bailliage* or *sénéchaussée* and each *bailliage* had one vote, the majority of the deputies of the *bailliage* deciding in what way this vote should be given. At the estates of the 16th century voting was by *gouvernements*; each *gouvernement* having one vote, but the majority of the *bailliages* composing the *gouvernement* decided how it should be given.

The States-General, when they gave counsel, had in theory only a consultative faculty. They had the power of granting subsidies, which was the chief and ordinary cause of their convocation. But it had come to be a consent with which the king could dispense. We have seen how permanent taxation became established. In the 16th century, however, the estates again claimed that their consent was necessary for the establishment of new taxation, and, on the whole, the facts seem to be in favour of this view at the time. But in the course of the 17th century the principle gained recognition that the king could tax on his own sole authority. Thus were established in the second half of the 17th century, and in the 18th, the direct taxes of the *capitation* and of the *dixième* or *vingtième*, and many indirect taxes. It was sufficient for the law creating them to be registered by the *cours des aides* and the *parlements*. It was only in 1787 that the *parlement* of Paris declared that it could not register the new taxes, the land-tax and stamp-duty (*subvention territoriale* and *impôt du timbre*), as they did not know whether they would be submitted to by the country, and that the consent of the representatives of the tax-payers must be asked.

The States-General had legally no share in the legislative power, which belonged to the king alone. The States of Blois demanded, it is true in 1576, that he should be bound to turn into law any proposition voted in identical terms by each of the three orders; but the king would not grant this demand, which would not even have left him a right of veto. In practice, however, the States-General contributed largely to legislation. Those who sat in them had at all times the right of presenting complaints (*doléances*), requests and petitions to the king; in this, indeed, consisted their sole initiative. They were usually answered by an *ordonnance*, and it is chiefly through these that we are acquainted with the activity of the estates of the 14th and 15th centuries. In the latest form, and from the estates of 1484 onwards, this was done by a new and special procedure. The States had become an entirely elective assembly, and at the elections (at each step of the election if there were several) the electors drew up a *cahier des doléances* (statement of grievances) which they requested the deputies to present; this even appeared to be the most important feature of an election. The deputies of each order in every *bailliage* also brought with them a *cahier des doléances*, which was arrived at, for the third estate, by a combination of the statements drawn up by the primary or secondary electors. On the assembly of the estates the *cahiers* of the *bailliages* were incorporated into a *cahier* for each *gouvernement*, and these again into a *cahier général* or general statement, which was presented to the king, and which he answered in his council. When the three orders deliberated in common, as in 1484, there was only one *cahier général*; when they deliberated separately, there were three, one for each order. The drawing up of the *cahier général* was looked upon as the main business (*le grand œuvre*) of the session.

By this means the States-General furnished the material for numerous *ordonnances*, though the king did not always adopt the propositions contained in the *cahiers*, and often modified them in forming them into an *ordonnance*. These latter were the *ordonnances de réforme* (reforming ordinances), treating of the most varied subjects, according to the demands of the *cahiers*. They were not, however, for the most part very well observed. The last of the type was the *grande ordonnance* of 1629 (*Code Michau*) drawn up in accordance with the *cahiers* of 1614 and with the observations of various assemblies of notables which followed them.

The States-General had, however, peculiar power which was recognized, but was of a kind that could not often be exercised; it was what might be called a constituent power. The ancient public law of France contained a number of rules called "the fundamental laws of the realm (*lois fondamentales du royaume*), though most of them were purely customary; chief among them were the rules of determining the succession to the Crown and those forbidding the alienation of the domain of the Crown. The king, supreme though his power might be,

could not abrogate, modify or infringe them. But it was admitted that he might do so by the consent of the States-General. The States could give the king a dispensation from a fundamental law in a given instance; they could even, in agreement with the king, make new fundamental laws. The States of Blois of 1576 and 1588 offer entirely convincing precedents in this respect. It was universally recognized that in the event of the line of Hugh Capet becoming extinct, it would be the function of the States-General to elect a new king.

The States-General of 1614 had been the last. A new convocation had indeed been announced to take place on the majority of Louis XIV., and letters were even issued in view of the elections, but this ended in nothing. Absolute monarchy was becoming definitely established, and was incompatible with the institution of the States-General. Liberal minds, however, in the *entourage* of the duke of Burgundy, who were preparing a new plan of government in view of his accession to the throne, thought of reviving the institution. It figures in the projects of St Simon and Fénelon, though the latter would have preferred to begin with an assembly of non-elected notables. But though St Simon was high in the favour of the regent Orleans, the States were not summoned at the death of Louis XIV.

In 1789 they were summoned. They were preceded, as Fénelon had wished in former days, by an assembly of notables in 1787, which already displayed great independence. It was the refusal of the *parlement* of Paris to register the fiscal edicts submitted to the Notables which led to the convocation of the States-General. The Notables, who had sat in 1787, were again summoned in 1788 to inquire into and fix the rules for the elections and the procedure of the States. Necker, in the *Mémoire* which he submitted to the *conseil du roi* in December 1788, granted for these States the *doublement du tiers*, i.e. that the third estate should have a number of deputies equal to that of the deputies of the other two orders combined, this is what had happened previously in the few provincial assemblies created by Necker during his first administration and in those created by an edict of 1787 for all the *pays d'élections*. But Necker's report, as to the subject of deliberating separately (*par ordre*) or in common, simply referred to the ancient principles; and he seems also to have proposed to maintain the system of voting by *bailliages*. Now the doubling of the *tiers* could yield it no real advantage unless the deliberation was in common and the voting by individuals, and it was this question which from the 6th of May 1789 onwards was the subject of the separate deliberations and negotiations between the three orders. On the 13th of June the third estate had arrived at a resolution to examine and settle in common the powers of the three orders, and invited to this common work those of the clergy and nobles. Certain of the latter and the majority of the clergy joined the *tiers*, and on the 17th of June it arrived at the celebrated decision by which it affirmed the principle of the national supremacy residing in the mass of the nation; the deputies, without any distinction of order, constituted a national assembly, which assembly was called upon to regenerate France by giving her a constitution, while the royal power (which in reality became provisional) could not negative its decisions. The king tried to resist. In the *séance royale* of the 23rd of June 1789, where he took the attitude of granting a *charte octroyée* (a constitution granted of the royal favour), he affirmed, subject to the traditional limitations, the right of separate deliberation for the three orders, which constitutionally formed three chambers. We know how this move failed; soon that part of the deputies of the nobles who still stood apart joined the National Assembly at the request of the king. The States-General had ceased to exist, having become the National Constituent Assembly, though it consisted of the deputies elected by the order.

See G. Picot, *Histoire des états-généraux* (2nd ed., Paris, 1888).
(J. P. E.)

The Dutch States-General.—In the Netherlands the convocation of the States-General, consisting of delegates from the provincial estates, dates from about the middle of the 15th

century, under the rule of the dukes of Burgundy. The name was transferred, after the separation of the northern Netherlands from the Spanish dominions, to the representatives elected by the seven sovereign provincial estates for the general government of the United Provinces. The States-General, in which the voting was by provinces—each province having one vote—was established from 1503 at the Hague. The States-General came to an end after the revolution in 1795, with the convocation of the National Assembly (March 1, 1796). See HOLLAND (*History*). The title of *Staten-Generaal* is, however, still borne by the Dutch parliament. (W. A. P.)

STATES OF THE CHURCH, or PAPAL STATES (Ital. *Stato della Chiesa, Stato Pontificio, Stato Romano, Stato Ecclesiastico*; Fr. *États de l'Église, Pontificat Souverain de Rome, &c.*; Ger. *Kirchenstaat*; in ecclesiastical Latin often *Patrimonium Sancti Petri*), that portion of central Italy which, previous to the unification of the kingdom, was under the direct government of the see of Rome. The territory stood in 1859 as in the annexed table.

With the exception of Benevento, surrounded by the Neapolitan province of Principato Ulteriore, and the small state of Pontecorvo, enclosed within the Terra di Lavoro, the States of the Church formed a compact territory, bounded on the N.W. by the Lombardo-Venetian kingdom, on the N.E. by the Adriatic, on the S.E. by the kingdom of Naples, on the S.W. by the Mediterranean, and on the W. by the grand-duchy of Tuscany and the duchy of Modena. On the Adriatic the coast extended 140 m. from the mouth of the Tronto (Truentus) to the southern mouth of the Po, and on the Tyrrhenian Sea 130 m. from 41° 20' to 42° 22' N. lat.

	Area in English sq. m.	Population in 1853.
Comarca of Rome	1752·8	326,509
Legations. { Bologna	1359·2	375,631
{ Ferrara	1094·0	244,524
{ Forlì	718·8	218,433
{ Ravenna	701·5	175,994
{ Urbino, with Pesaro	1414·6	257,751
{ Velletri	571·3	62,013
{ Ancona	441·8	176,519
{ Macerata	895·0	243,104
{ Camerino	320·0	42,991
{ Fermo	335·7	110,321
{ Ascoli	476·3	91,916
{ Perugia	1555·5	234,533
{ Spoleto	1175·9	135,029
{ Rieti	531·7	73,683
{ Viterbo	1158·9	128,324
{ Orvieto	316·6	29,047
{ Cività Vecchia	380·0	20,701
{ Frosinone, with Pontecorvo	739·9	154,559
{ Benevento	61·3	23,176
	16,000·8	3,124,758

The divisions shown above were adopted on the 21st of December 1827, the legations being ruled by a cardinal and the delegations by a prelate. Previously the several districts formally recognized were Latium, the Marittima (or sea-board) and Campagna, the patrimony of Saint Peter, the duchy of Castro, the Orvietano, the Sabina, Umbria, the Perugino, the March of Ancona, Romagna, the Bolognese, the Ferrarese, and the duchies of Benevento and of Pontecorvo. The former papal territories are now comprised within the Italian provinces of Bologna, Ferrara, Forlì, Ravenna, Pesaro and Urbino, Ancona, Macerata, Ascoli-Piceno, Perugia, Rome and Benevento.

The question of the origin of the territorial jurisdiction of the pope is treated under PAPACY. With the moral and ecclesiastical decay of the papacy in the 9th and 10th centuries much of its territorial authority slipped from its grasp; and by the middle of the 11th century its rule was not recognized beyond Rome and the immediate vicinity. By the treaty of Sutri (February 1111) Paschal II. was compelled by the emperor Henry V. to surrender all the possessions and royalties of the Church; but this treaty was soon afterwards repudiated, and by the will of Matilda, countess of Tuscany, the papal see was enabled to lay claim to new territories

of great value. By the capitulation of Neuss (1201) the emperor Otto IV. recognized the papal authority over the whole tract from Radicofani in Tuscany to the pass of Ceperano on the Neapolitan frontier—the exarchate of Ravenna, the Pentapolis, the March of Ancona, the bishopric of Spoleto, Matilda's personal estates, and the countship of Brittenoro; but a good deal of the territory thus described remained for centuries an object of ambition only on the part of the popes. The actual annexation of Ravenna, Ancona, Bologna, Ferrara, &c., dates from the 16th century. The States of the Church were of course submerged for a time by the groundswell of the French Revolution, but they appeared again in 1814. In 1849 they received a constitution. On the formation of the kingdom of Italy in 1860 they were reduced to the Comarca of Rome, the legation of Velletri, and the three delegations of Viterbo, Civitá Vecchia and Frosinone; and in 1870 they disappeared from the political map of Europe. See ITALY: *History*.

STATE TRIALS, in English law, a name which primarily denotes all trials relating to offences against the state, but in practice is often used of cases illustrative of the law relating to state officers or of international or constitutional law. The first collection of accounts of state trials was published in 1719 in four volumes. Although without an editor's name, it appears that Thomas Salmon (1679–1767), an historical and geographical writer, was responsible for the collection. A second edition, increased to six volumes, under the editorship of Sollom Emlyn (1697–1754), appeared in 1730. This edition contained a lengthy preface critically surveying the condition of English law at the time. A third edition appeared in 1742, in eight volumes, the seventh and eighth volumes having been added in 1835. Ninth and tenth volumes were added in 1766, and a fourth edition, comprising ten volumes, with the trials arranged chronologically, was published the same year. A fifth edition, originated by William Cobbett, but edited by Thomas Bayly Howell (1768–1815) and known as *Cobbett's Complete Collection of State Trials*, was published between 1809 and 1826. This edition is in thirty-three volumes; twenty-one of them, giving the more important state trials down to 1781, were edited by T. B. Howell, and the remaining volumes, bringing the trials down to 1820, by his son Thomas Jones Howell (d. 1858). A new series, under the direction of a parliamentary committee, was projected in 1885, with the object of bringing the trials down to a later date. Eight volumes were published in 1888–1898, bringing the work down to 1858. The first three of these were edited by Sir J. Macdonell, the remaining five by J. E. P. Wallis. Selections have also been edited by H. L. Stephen and others. The trials are invaluable not only for their reports of criminal cases, in which the whole course of criminal procedure and evidence may be traced, but for their historical information.

STATICS (from Gr. root *στα-*, stand, or cause to stand), the branch of mechanics which discusses the conditions of rest or equilibrium of forces (see **MECHANICS**).

STATIONERY, a term embracing all the various articles sold by "stationers," who were originally booksellers having "stations" or stands in markets, near churches or other buildings for the sale of their goods (see **BOOKSELLING** for the further history of the word). The stationers were formed into a guild in 1403, the Livery Company not being incorporated till 1556. At the hall of the company in London, "Stationers' Hall," is kept a book for the registration of copyrights (see **COPYRIGHT**). The "Stationery Office" is a British government department which supplies stationery to parliament and the government offices and generally controls the printing required by them.

Under the name of stationery are now included all writing materials and implements, together with the numerous appliances of the desk and of mercantile and commercial offices.

The principal articles and operations of the stationery trade are dealt with under such headings as **BOOKBINDING**; **COPYING MACHINES**; **INK**; **LITHOGRAPHY**; **PAPER**; **PEN**; and **PENCIL**.

STATIONS OF THE CROSS, a series of 14 pictures or images representing the closing scenes in the Passion of Christ, viz. (1) the condemnation by Pilate, (2) the reception of the cross, (3) Christ's first fall, (4) the meeting with His mother, (5) Simon of Cyrene carrying the cross, (6) Veronica wiping the face of Jesus, (7) the second fall, (8) the exhortation to the women of

Jerusalem, (9) the third fall, (10) the stripping of the clothes, (11) the crucifixion, (12) the death, (13) the descent from the cross, (14) the burial. Sometimes a 15th—the finding of the cross by Helena—is added; on the other hand in the diocese of Vienna, the stations were at the end of the 18th century reduced to eleven. They form a very popular item in Roman Catholic devotion. The representations are usually ranged round the church; sometimes they are found in the open air, especially on the ascent to some elevated church or shrine.

The devotion began among the Franciscans, who, as the guardians of the holy places in Jerusalem, sought by this means to enable Christians to make a pilgrimage at least in spirit. Pope Innocent XII. in 1694 declared that the indulgences granted for visiting Palestine might be gained by members of the order who, simply visiting the stations of the cross wherever represented, exercised a devout meditation as they passed from station to station. These indulgences were extended by Benedict XIII. in 1726 to all the faithful, and Clement XII. five years later granted the privilege to churches other than Franciscan, provided the stations were erected by a Franciscan. In 1857 the Roman Catholic bishops in England received faculties, renewed quinquennially, permitting them to erect the stations with the accompanying indulgences, and they often delegate this faculty to priests.

STATISTICS. The word "statistic" is derived from the Latin *status*, which, in the middle ages, had come to mean a "state" in the political sense. "Statistic," therefore, originally denoted inquiries into the condition of a state. Since the 18th century the denotation of the word has been extended, while at the same time its scope has become more definite, and may now be said, for all practical purposes, to be fixed.

History.—The origin of what is now known as "statistics" (Ger. *die Statistik*; Fr. *la statistique*; Ital. *statistica*) can only be referred to briefly here. As human societies became more and more highly organized, there can be no doubt that a very considerable body of official statistics must have come into existence, and been constantly used by statesmen, solely with a view to administration. The Romans were careful to obtain accurate information regarding the resources of the state, and they appear to have taken the census with a regularity which has hardly been surpassed in modern times.

Statistics, or rather the material for statistics, therefore existed at a very early period, but it was not until within the last three centuries that systematic use of the information available began to be made for purposes of investigation and not of mere administration. A volume compiled by Francesco Sansovino, entitled *Del Governo et amministrazione di diversi regni et repubbliche*, was printed in Venice and bears the date 1583. Other works of a similar kind were published towards the end of the 16th century in Italy and France. Works on state administration and finance continued to be published during the first half of the 17th century, and the tendency to employ figures, which were hardly used at all by Sansovino, became more marked, especially in England, where the facts connected with "bills of mortality" had begun to attract attention.

G. Achenwall is usually credited with being the first to use the word "statistics," but statistics, in the modern sense of the word, did not really come into existence until the publication (1761) by J. P. Süßmilch, a Prussian clergyman, of a work entitled *Die göttliche Ordnung in den Veränderungen des menschlichen Geschlechts aus der Geburt, dem Tode, und der Fortpflanzung desselben erwiesen*. In this book a systematic attempt was made to make use of a class of facts which up to that time had been regarded as belonging to "political arithmetic," under which description some of the most important problems of what modern writers term "vital statistics" had been studied, especially in England. Süßmilch had arrived at a perception of the advantage of studying what Quetelet subsequently termed the "laws of large numbers." He combined the method of "descriptive statistics" with that of the "political arithmeticians," who had confined themselves to investigations into the facts regarding

mortality and a few other similar subjects, without much attempt at generalizing from them.

Political arithmetic had come into existence in England in the middle of the 17th century. The earliest example of this class of investigation is the work of Captain John Graunt of London, entitled *Natural and Political Annals made upon the Bills of Mortality*, which was first published in 1666. This remarkable work, which dealt with mortality in London only, ran through many editions, and the line of inquiry it suggested was followed up by various other writers, of whom the most distinguished was Sir William Petty, who published in 1683 his *Five Essays in Political Arithmetick*. Other writers, of whom Halley, the celebrated mathematician and astronomer, was one, entered on similar investigations, and during the greater part of the 18th century the number of persons who devoted themselves to "arithmetical" inquiries into problems of the class now known as statistical was steadily increasing. Much attention was given to the construction of tables of mortality. Attempts were also made to deal with figures as the basis of political and fiscal discussion by Arthur Young, Hume and other historical writers, as well as by the two Mirabeaus.

It is now necessary to return to Süssmilch, who, as already mentioned, endeavoured to form a general theory of society, based on what were then termed "arithmetical" premises. In modern language, he made use of quantitative aggregate-observation as an instrument of social inquiry. It is true he did not enter on his investigation with an "open mind." He desired to support a foregone conclusion, as the title of his work shows. But nevertheless his work was a most valuable one, since it pointed out a road which others who had no desire to procure evidence in favour of a particular system of thought were not slow to follow. Although for many years after the appearance of Süssmilch's book there was a good deal of resistance to the introduction of "arithmetic" as the coadjutor of moral and political investigations, yet, practically there was a tacit admission of the usefulness of figures, even by the chiefs of the so-called "descriptive" school. On the other hand, Süssmilch's success was the origin of a "mathematical" school of statisticians, some of whom carried their enthusiasm for figures so far that they refused to allow any place for mere "descriptions" at all. These two schools have now coalesced, each admitting the importance of the point of view urged by the other. They were, however, still perceptibly distinct even as late as 1850, and the ignorant hostility with which many people even among the cultivated classes still regard statistical inquiries into the nature of human society may be regarded as a survival of the much stronger feeling which showed itself among "orthodox" professors of law and economics on the publication of Süssmilch's treatise.

To the impulse given by the great Belgian, Quetelet, must be attributed the foundation in 1834 of the Statistical Society of London, a body which, though it has contributed little to the theory of statistics, has had a considerable influence on the practical work of carrying out statistical investigations in the United Kingdom and elsewhere. Quetelet was above all things an exponent of the "laws of large numbers." He was especially fascinated with the tendency to relative constancy of magnitude displayed by the figures of moral statistics, especially those of crime, which inspired him with a certain degree of pessimism. His conception of an average man (*l'homme moyen*) and his disquisition on the "curve of possibility" were most important contributions to the technical development of the statistical method.

The influence exercised by Quetelet on the development of statistics is clearly seen from the fact that, though there is still considerable controversy among statisticians, the old controversy between the "descriptive" and arithmetical schools has disappeared, or perhaps we should say has been transformed into a discussion of another kind, the question now at issue being whether there is a science of statistics as well as

a statistical method. It is true that a few books were published between 1830 and 1850 in which the politico-geographical description of a country is spoken of as "statistics," which is thus distinguished from "political arithmetic." The title of Knies's great work, *Die Statistik als selbständige Wissenschaft* (Cassel, 1850), is especially noteworthy as showing that the nature of the controversy was changing. Knies claimed that the really "scientific" portion of statistics consisted of the figures employed. As Haushofer says, "his starting point is political arithmetic."

Some eminent statisticians of the latter half of the 19th century accepted the view of Knies, but the majority of modern writers on the theory of statistics, especially in Germany, have adopted a slightly different standpoint according to which statistics is at once a *science* relating to the social life of man and a *method of investigation* applicable to all sciences. This view was ably maintained by von Mayr, Haushofer, Gabaglio and Block, whose views, published fifteen to twenty years before the close of last century, still substantially represent the opinions held by the majority of statisticians in Germany, and probably on the European continent. In France, however, several writers of importance have recently published works on the subject in which, in spite of the influence of M. Block, the claim of statistics to be considered as an independent sociological science has been rejected. There has been little systematic exposition of the subject in the United Kingdom. Isolated dicta have been furnished by authorities on the practice of statistics, such as the late Dr W. A. Guy, Professor J. K. Ingram, Sir Rawson W. Rawson, Sir Robert Giffen and others, Professor Foxwell has lectured on statistics at University College, London. The most important English work dealing with the matter is that of Mr A. L. Bowley. His volume, *Elements of Statistics* (first published in 1901), is intended as a practical handbook for teaching the principles on which statistics should be handled. The nature of Mr Bowley's book is, indeed, an indication of the fact that in the United Kingdom the study of statistics has been, in the main, of a practical character, the investigation of the theoretical basis of the statistical method attracting little interest. On the other hand, numerous monographs have been published by English writers on particular points connected with the technique of statistical investigation, as was natural considering the excellence of the practical use made of statistics in the United Kingdom.

With regard to the few earlier invasions of the domain of theory attempted by English writers, it may be observed that the authorities above mentioned were not unanimous. Dr Guy as well as Sir Rawson W. Rawson both claim that statistics is to be regarded as an independent science, apart from sociology, while Professor Ingram maintained that statistics cannot occupy a position co-ordinate with that of sociology, and that they "constitute only one of the aids or adminicula of science." Sir Robert Giffen has also expressed himself adversely to the continental doctrine that there is an independent science of statistics, and this opinion appears to be the correct one, but, as Dr Guy and Sir Rawson W. Rawson had the support of the great body of systematic teaching emanating from distinguished continental statisticians in support of their view, while their opponents have so far only the *obiter dicta* of a few eminent men to rely upon, it appears needful to examine closely the views held by the continental authorities, and the grounds on which they are based.

The clearest and shortest definition of the science of statistics as thus conceived is that of M. Block, who describes it as "la science de l'homme vivant en société en tant qu'elle peut être exprimée par les chiffres." He proposes to give a new name to the branch of study thus defined, namely "demography." Von Mayr's definition is longer. He defines the statistical science as "die systematische Darlegung und Erörterung der thatsächlichen Vorgänge und der aus diesen sich ergebenden Gesetze des gesellschaftlichen menschlichen Lebens auf Grundlage quantitativer Massenbeobachtungen" (the systematic statement

and explanation of actual events, and of the laws of man's social life that may be deduced from these, on the basis of the quantitative observation of aggregates). Gabaglio's view is practically identical with those adopted by von Mayr and Block, though it is differently expressed. He says "statistics may be interpreted in an extended and in a restricted sense. In the former sense it is a method, in the latter a science. As a science it studies the actual social-political order by means of mathematical induction." Most German writers on the subject have endorsed the views of Block and von Mayr. Among them may be mentioned Professors J. Conrad, Lexis and Westergaard, but Dr Augst Meitzen of Berlin, a second edition of whose *Geschichte, Theorie und Technik der Statistik* was published in 1903, makes a much less wide claim. In France opinions are divided, Professors André Liesse and Fernand Faure and others accepting the view that statistics is essentially a method.

This discussion regarding the nature of statistics is to a large extent a discussion about names. There is really no difference of opinion among statistical experts as to the subject-matter of statistics, the only question being—Shall statistics be termed a science as well as a method? That there are some investigations in which statistical procedure is employed which certainly do not belong to the domain of the supposed statistical science is generally admitted. But, as already shown, an attempt has been made to claim that the phenomena of human society, or some part of those phenomena, constitute the subject-matter of an independent statistical science. It is not easy to see why this claim should be admitted. There is no reason either of convenience or logic why the use of a certain scientific method should be held to have created a science in one department of inquiry, while in others the said method is regarded merely as an aid in investigation carried on under the superintendence of a science already in existence. It is impossible to get over the fact that in meteorology, medicine, and other physical sciences statistical inquiries are plainly and obviously examples of the employment of a method, like microscopy, spectrum analysis, or the use of the telescope. Why should the fact of their employment in sociology be considered as authorizing the classification of the phenomena thus dealt with to form a new science?

The most effective argument put forward by the advocates of this view is the assertion that statistics are merely a convenient aid to investigation in the majority of sciences, but are the sole method of inquiry in the case of sociology. When, indeed, it is tested by reference to the important class of social facts which are named economic, it becomes obvious that the argument breaks down. Economics is a branch—the only scientifically organized branch—of sociology, and statistics are largely used in it, but no one, so far as we are aware, has proposed to call economics a department of statistical science.

Although, however, the above considerations forbid the acceptance of the continental opinion that the study of man in the social state is identical with statistics, it must be admitted that without statistics the nature of human society could never become known. For society is an aggregate, or rather a congeries of aggregates. Not only that, but the individuals composing these aggregates are not in juxtaposition, and what is, from the sociological point of view, the same aggregate or organ of the "body politic" is not always composed of the same individuals. Constancy of social form is maintained concurrently with the most extensive changes in the collocation and identity of the particles composing the form. A "nation" is really changed, so far as the individuals composing it are concerned, every moment of time by the operation of the laws of population. But the nation, considered sociologically, remains the same in spite of this slow change in the particles composing it, just as a human being is considered to be the same person year by year, although year by year the particles forming his or her body are constantly being destroyed and fresh particles substituted. Of course the analogy between the life of a human being and the life of a human community must not be pressed too far. Indeed, in several respects human communities more nearly

resemble some of the lower forms of animal life than the more highly organized forms of animal existence. There are organisms which are fissiparous, and when cut in two form two fresh independent organisms, so diffused is the vitality of the original organism; and the same phenomenon may be observed in regard to human communities.

Now the only means whereby the grouping of the individuals forming a social organism can be ascertained, and the changes in the groups year by year observed, is the statistical method. Accordingly the correct view seems to be that it is the function of this method to make perceptible facts regarding the constitution of society on which sociology is to base its conclusions. It is not claimed, or ought not to be claimed, that statistical investigation can supply *the whole* of the facts a knowledge of which will enable sociologists to form a correct theory of the social life of man. The statistical method is essentially a mathematical procedure, attempting to give a quantitative expression to certain facts; and the resolution of differences of quality into differences of quantity has not yet been effected, even in chemical science. In sociological science the importance of differences of quality is enormous, and the effect of these differences on the conclusions to be drawn from figures is sometimes neglected, or insufficiently recognized, even by men of unquestionable ability and good faith. The majority of politicians, social "reformers" and amateur handlers of statistics generally are in the habit of drawing the conclusions that seem good to them from such figures as they may obtain, merely by treating as homogeneous quantities which are heterogeneous, and as comparable quantities which are not comparable. Even to the conscientious and intelligent inquirer the difficulty of avoiding mistakes in using statistics prepared by other persons is very great. There are usually "pit-falls" even in the simplest statistical statement, the position and nature of which are known only to the persons who have actually handled what may be called the "raw-material" of the statistics in question; and in regard to complex statistical statements the "outsider" cannot be too careful to ascertain from those who compiled them as far as possible what are the points requiring elucidation.

The Statistical Method.—This method is a scientific procedure (1) whereby certain phenomena of aggregation not perceptible to the senses are rendered perceptible to the intellect, and (2) furnishing rules for the correct performance of the quantitative observation of these phenomena. The class of phenomena of aggregation referred to includes only such phenomena as are too large to be perceptible to the senses. It does not, *e.g.* include such phenomena as are the subject-matter of microscopy. Things which are very large are often quite as difficult to perceive as those which are very small. A familiar example of this is the difficulty which is sometimes experienced in finding the large names, as of countries or provinces, on a map. Of course, the terms "large," "too large," "small" and "too small" must be used with great caution, and with a clear comprehension on the part of the person using them of the standard of measurement implied by the terms in each particular case. A careful study of the first few pages of De Morgan's *Differential and Integral Calculus* will materially assist the student of statistics in attaining a grasp of the principles on which standards of measurement should be formed. It is not necessary that he should become acquainted with the calculus itself, or even possess anything more than an elementary knowledge of mathematical science, but it is essential that he should be fully conscious of the fact that "large" and "small" quantities can only be so designated with propriety by reference to a common standard. It is also necessary that he should be acquainted with the theory of probability as applied to statistical investigations, the need of which is well set forth by Mr A. L. Bowley in Part II. of his work, already referred to, and by other writers. Valuable instruction on this technical subject can be obtained from monographs by Professor F. Y. Edgeworth, Professor Karl Pearson, Dr John Venn, Mr Udney Yule and many other contributors to the *Transactions of the Royal Society*, the *Journal of the Royal Statistical Society*, the *Economic Journal*,

the *Quarterly Journal of Economics* and similar publications in different countries.

Sources whence Statistics are Derived.—The term "statistics" in the concrete sense means systematic arrangements of figures representing "primary statistical quantities." A primary statistical quantity is a number obtained from numbers representing phenomena, with a view to enable an observer to perceive a certain other phenomenon related to the former as whole to parts. They represent either a phenomenon of existence at a given point of time or a phenomenon of accretion during a given period. As examples may be mentioned the number of deaths in a given district during a given time, the number of pounds sterling received by the London & North Western railway during a given time, and the number of "inches of rain" that fell at Greenwich during a given time. Other examples are the number of tons of pig-iron lying in a particular store at a given date, the number of persons residing (the term "residing" to be specially defined) in a given territory at a given date, and the number of pounds sterling representing the "private deposits" of the Bank of England at a given date.

Primary statistical quantities are the result of labours carried on either (A) by governments or (B) by individuals or public or private corporations.

A Government Statistics.—1. A vast mass of statistical material of more or less value comes into existence automatically in modern states in consequence of the ordinary administrative routine of departments. To this class belong the highly important statistical information published in England by the registrar-general, the returns of pauperism issued by the local government board, the reports of inspectors of prisons, factories, schools, and those of sanitary inspectors, as well as the reports of the commissioners of the customs, and the annual statements of trade and navigation prepared by the same officials. There are also the various returns compiled and issued by the board of trade, which is the body most nearly resembling the statistical bureaux with which most foreign governments are furnished. Most of the government departments publish some statistics for which they are solely responsible as regards both matter and form, and they are very jealous of their right to do so, a fact which is to some extent detrimental to that uniformity as to dates and periods which should be the ideal of a well-organized system of statistics. Finally may be mentioned the very important set of statistical quantities known as the budget, and the statistics prepared and published by the commissioners of inland revenue, by the post office, and by the national debt commissioners. All these sets of primary statistical quantities arise out of the ordinary work of departments of the public service. Many of them have been in existence, in some form or other, ever since a settled government existed in the country. There are records of customs receipts at London and other ports of the time of Edward III., covering a period of many years, which leave nothing to be desired in point of precision and uniformity. It may be added that many of these sets of figures are obtained in much the same form by all civilized governments, and that it is often possible to compare the figures relating to different countries and thus obtain evidence as to the sociological phenomena of each, but in regard to others there are differences which make comparison difficult.

2. Besides being responsible for the issue of what may be called administration statistics, all governments are in the habit of ordering from time to time special inquiries into special subjects of interest, either to obtain additional information needful for administrative purposes, or, in countries possessed of representative institutions, to supply statistics asked for by parliaments or congresses. It is not necessary to refer particularly to this class of statistical information, except in the case of the census. This is an inquiry of such great importance that it may be regarded as one of the regular administrative duties of governments, though as the census is only taken once in a series of years it must be mentioned under the head of occasional or special inquiries undertaken by governments. In the United Kingdom the work is done by the registrars-general who are in office when the period for taking the census comes round. On the Continent the work is carried out by the statistical bureaux of each country—except France, where it is under the supervision of the minister of the interior. The new regulations as to income-tax assessment and the new land taxes will furnish the government with much fresh information as to incomes; and the census of production ordered in the session of 1907 and already carried out as regards a number of trades will also be useful.

B. The primary statistical quantities for which individuals or corporations are responsible may be divided into three categories:

1. Among those which are compiled in obedience to the law of the land are the accounts furnished by municipal corporations, by the Bank of England, by railway, gas, water, banking, insurance and other public companies making returns to the board of trade, by trades unions, and by other bodies which are obliged to make returns to the registrar of friendly societies. The information thus obtained is published in full by the departments receiving it, and is also furnished by the companies themselves to their proprietors or members.

2. An enormous mass of statistical information is furnished

voluntarily by public companies in the reports and accounts which, in accordance with their articles of association, are presented to their proprietors at stated intervals. With these statistics may be classed the figures furnished by the various trade associations, some of them of great importance, such as Lloyd's, the London Stock Exchange, the British Iron Trade Association, the London Corn Exchange, the Institute of Bankers, the Institute of Actuaries, and other such bodies too numerous to mention.

3. There are cases in which individuals have devoted themselves with more or less success to obtaining original statistics on special points. The great work done by Messrs Behm and Wagner in arriving at an approximate estimate of the population of the earth does not belong to this category, though its results are really primary statistical quantities. Many of these results have not been arrived at by a direct process of enumeration at all, but by ingenious processes of inference. It need hardly be said that it is not easy for individuals to obtain the materials for any primary statistical quantity of importance, but it has been done in some cases with success. The investigations of Mr Charles Booth into labour and wages questions, carried out with care over many years, are a remarkable example of this.

Operations Performed on Primary Statistical Quantities.—Only a brief description of matters connected with the *technique* of the statistical method can be given in this article. In order to form statistics properly so called the primary statistical quantities must be formed into tables, and in the formation of these tables lies the art of the statistician. It is not a very difficult art when the principles relating to it have been properly grasped, but those who are unfamiliar with the subject are apt to underrate the difficulty of correctly practising it.

Simple Tables.—The first thing to be done in the construction of a table is to form a clear idea of what the table is to show, and to express that idea in accurate language. This is a matter which is often neglected, and it is a source of much waste of time and occasionally of misapprehension to those who have to study the figures thus presented. No table ought to be considered complete without a "heading" accurately describing its contents, and it is frequently necessary that such headings should be rather long. It has been said that "you can prove anything by statistics." This statement is, of course, absurd, taken absolutely, but, like most assertions which are widely believed, it has a grain of truth in it. If this popular saying ran "you can prove anything by tables with slovenly and ambiguous headings," it might be assented to without hesitation. The false "statistical" facts which obtain a hold of the public mind may often be traced to some widely circulated table, to which, either from stupidity or carelessness, an erroneous or inaccurate "heading" has been affixed.

A statistical table in its simplest form consists of "primaries" representing phenomena of the same class, but existing at different points of time, or coming into existence during different portions of time. This is all that is essential to a table, though other things are usually added to it as an aid to its comprehension. A table stating the number of persons residing in each county of England on a given day of a given year, and also, in another column, the corresponding numbers for the same counties on the corresponding day of the tenth year subsequently, would be a simple tabular statement of the general facts regarding the total population of those counties supplied by two successive censuses. Various figures might, however, be added to it which would greatly add to its clearness. There might be columns showing the increase or decrease for each county and for the whole kingdom during the ten years, and another column showing what *proportion*, expressed in percentages, these increases or decreases bore to the figures for the earlier of the two years. Then there might be two columns showing what proportions, also expressed as percentages, the figures for each county bore in each year to the figures for the whole kingdom. The nine-column table thus resulting would still be simple, all the figures being merely explicit assertions of facts which are contained implicitly in the original "primaries."

Complex Tables.—Suppose now we have another table precisely similar in form to the first, and also relating to the counties of England, but giving the number of houses existing in each of them at the same two dates. A combination of the two would form a complex table, and an application of the processes of arithmetic would make evident a number of fresh facts, all of which would be implied in the table, but would not be obvious to most people until explicitly stated.

The technical work of the statistician consists largely in operations of which the processes just referred to are types.

Proportions.—The most usual and the best mode of expressing the proportion borne by one statistical quantity to another is to state it as a percentage. In some cases another method is adopted, viz. that of stating the proportion in the form "one in so many." This method is generally a bad one, and its use should be discouraged as much as possible, the chief reason being that the changing portion of this kind of proportional figure becomes greater or less inversely, and not directly, as the phenomenon it represents increases or diminishes.

Averages.—Averages or means are for statistical purposes divided into two classes, the *arithmetical* and *weighted*. An

arithmetical mean is the sum of all the members forming the series of figures under consideration divided by their number, without reference to their *weight* or relative importance among themselves. A weighted mean is the sum of such figures divided by their number, with due allowance made for their weight. An example will make this clear, and the simplest example is taken from a class of statistical quantities of a peculiar kind, viz. *prices*. The price of a given article is the approximate mathematical expression of the rates, in terms of money, at which exchanges of the article for money were actually made at or about a given hour on a given day. A quotation of *price* such as appears in a daily price list is, if there has been much fluctuation, only a very rough guide to the actual rates of exchange that have been the basis of the successive bargains making up the day's business. But let us suppose that the closing price each day may be accepted as a fair representative of the day's transactions, and let us further suppose that we desire to obtain the *average price* for thirty days. Now, the sum of the prices in question divided by thirty would be the arithmetical mean, and its weak point would be that it made no allowance for the fact that the business done on some days is much larger than that done on others; in other words, it treats them as being all of equal weight. Now if, as is actually the case in some markets, we have a daily account of the *total quantities sold* we can weight the members accurately, and can then obtain their weighted mean. There are cases in which the careless use of arithmetical means misleads the student of the social organism seriously. It is often comparatively easy to obtain arithmetical means, but difficult to obtain weighted means. Inferences based on the former class of average should be subjected to the most rigid investigation.

There are many methods of weighting averages; for descriptions of these statistical processes the reader must be referred to the works on the technique of statistics. In chapter v. of Mr Bowley's volume, the subject is dealt with in a manner suitable for students.

Before closing this short survey of the very important subject of averages or means, it is needful to discuss briefly the nature of the phenomena which they may safely be regarded as indicating, when they have been properly obtained. Given a weighted mean of a series of numbers referring to no matter what phenomenon, it is obvious that the value of the mean as a *type* of the whole series will depend entirely on the extent of divergence from it of the members of the series as a body. If we are told that there are in a certain district 1000 men, and that their average height is 5 ft. 8 in., and are told nothing further about them, we can make various hypotheses as to the structure of this body from the point of view of height. It is possible that they may consist of a rather large number of men about 6 ft. high, and a great many about 5 ft. 5 in. Or the proportions of relatively tall and short men may be reversed, that is, there may be a rather large number of men about 5 ft. 4 in., and a moderate number of men about 5 ft. 11 in. It is also possible that there may be very few men whose height is exactly 5 ft. 8 in., and that the bulk of the whole body consists of two large groups—one of giants and the other of dwarfs. Lastly, it is possible that 5 ft. 8 in. may really give a fair idea of the height of the majority of the men, which it would do if (say) 660 of them were within an inch of that height, either by excess or deficiency, while of the remainder one half were all above 5 ft. 9 in. and the other half all below 5 ft. 7 in. This latter supposition would most likely be found to be approximately correct if the men belonged to a race whose average height was 5 ft. 8 in., and if they had been collected by chance. The extent of the divergence of the items composing an average from the average itself may be accurately measured and expressed in percentages of the average, the algebraic signs + and - being employed to indicate the direction of the variation from the mean. An average may, therefore, advantageously be supplemented: (1) by a figure showing what proportion of the members from which it is derived differs from the average by a relatively small quantity, and (2) by figures showing the maximum and minimum deviations from the average. The meaning of the term "relatively small" must be considered independently in each investigation. Fuller remarks on averages will be found in the works mentioned at the conclusion of this article.

Prices.—Reference has already been made to the peculiar class of statistical quantities known as *prices*. Prices in their widest sense include all figures expressing *ratios of exchange*. In modern society the terms of exchange are always expressed in money, and the things for which money is exchanged are: (1) concrete entities with physical attributes, such as iron or wheat; (2) immediate rights, such as those given by interest-bearing securities of all kinds, by bills of exchange, by railway or steamship contracts to carry either passengers or goods, and by bargains relative to the foreign exchanges; (3) contingent rights, such as those implied in policies of insurance. All these rates of exchange belong to the same category, whether they are fixed within certain limits by law, as in the case of railway charges, or are left to be determined by the "higgling of the market." All these cases of price may conceivably come within the operation of the statistical method, but the only matter connected with price which it is necessary to refer to here is the theory of the *index number*.

Index Numbers.—The need for these became conspicuous during the investigations of Tooke, Newmarch and others into the general

cyclical movements of the prices of commodities; and to construct a good system of these may be said to be one of the highest technical aims of the statistical method. In comparing the prices of different years it was soon observed that, though whole groups of articles moved upwards or downwards simultaneously, they did not all move in the same proportion, and that there were nearly always cases in which isolated articles or groups of articles moved in the opposite direction to the majority of articles. The problem presented to statisticians therefore was, and is, to devise a statistical expression of the general movement of prices, in which all prices should be adequately represented. The first rough approximation to the desired result was attained by setting down the percentages representing the movements, with their proper algebraic signs before them, and adding them together algebraically. The total with its proper sign was then divided by the number of articles, and the quotient represented the movement in the prices of the whole body of articles during the period under consideration. It was soon seen, however, that this procedure was fatally defective, inasmuch as it treated all prices as of equal weight. Cotton weighed no more than pimento, and iron no more than umbrellas. Accordingly an improvement was made in the procedure, first by giving the prices of several different articles into which cotton, iron and other important commodities entered, and only one price each in the case of the minor articles, and secondly by fixing on the price of some one article representing iron or cotton, and multiplying it by some number selected with the view of assigning to these articles their proper weights relatively to each other and to the rest. The objection to both these plans is the same—that the numbers attached to the various articles or groups of articles are purely arbitrary; and attempts have been made to obtain what may be called *natural index numbers*, the most successful so far being that of Sir Robert Giffen, whose index numbers were obtained from the declared values of the imports or exports into or from the United Kingdom of the articles whose prices are dealt with. In the case of both imports and exports Sir Robert worked out the proportion borne by the value of each article to the total value for a series of years. Deducting the "unenumerated" articles, a series of numbers was thus obtained which could be used as the means of weighting the prices of the articles in an investigation of a movement of prices. This procedure is no doubt susceptible of further improvement, like its predecessors. The index numbers prepared and published every month by the *Economist*, and by Mr Augustus Sauerbeck, which are weighted, are of great value; owing to the frequency of their appearance they make it possible to watch the tendency of prices closely.

The Desirability of Increased Uniformity in Statistics.—One of the most serious difficulties in connexion with statistical investigations is the variety of the modes in which primaries of the same order are obtained, as regards dates and periods. This is a matter of which all persons who have occasion to use statistics are made painfully aware from time to time. Some attempts have lately been made to introduce more harmony into the official statistics of the United Kingdom, and many years ago a committee of the treasury sat to inquire into the matter. The committee received a good deal of evidence, and presented a report, from which, however, certain members of the committee dissented, preferring to express their views separately. The evidence will be found very interesting by all who wish to obtain an insight into the genesis of the official statistics of the country.

The International Institute of Statistics.—The absence of uniformity in statistics which is felt in England is not so marked in foreign countries, where the principle of centralization in arrangements of a political character is more powerful. In several continental countries and in the United States there are statistical bureaux with definite duties to perform. In the United Kingdom, as already remarked, the nearest approach to a central statistical office is the commercial and statistical department of the board of trade, on which the work of furnishing such statistics as are not definitely recognized as within the province of some other state department usually falls. Various attempts have been made to introduce more uniformity into the statistics of all countries. It was with this object that statistical congresses have met from time to time since 1853. An endeavour was made at the congress held in 1876 at Budapest to arrange for the publication of a system of international statistics, each statistical bureau undertaking a special branch of the subject. The experiment was, however, foredoomed to be only a very partial success, first because all countries were not then and are not yet furnished with central statistical offices, and secondly because the work which fell on the offices in existence could only be performed slowly, as the ordinary business of the offices necessarily left them little leisure for extra work. In 1885, at the jubilee of the London Statistical Society, a number of eminent statistical officials from all parts of the world except Germany were present, and the opportunity was taken to organize an International Institute of Statistics with a view to remedying the defects already ascertained to exist in the arrangements made by the congresses. The only obstacle to securing a proper representation of all countries was the absence of any German delegates, none of the official heads of the German statistical office being allowed to attend—apparently on political

grounds. Since then assurances of a satisfactory kind have been given to the German government that their servants would be in no way committed to any course disapproved by that government if they gave their assistance to the Institute, from the formation of which it is hoped that much advantage may result. For information as to the constitution and objects of the Institute reference may be made to a paper by the late Dr F. X. von Neumann-Spallart in vol. i. (1886) of the *Bulletin de l'institut international de statistique* (Rome, 1886). Meetings of the Institute have been held annually ever since its formation in various cities of the world.

LITERATURE.—E. Blaschke, *Vorlesungen über mathematische Statistik (die Lehre von den statistischen Masszahlen)* (Leipzig and Berlin, 1906); Maurice Block, *Traité théorique et pratique de statistique* (Paris, 1878); Luigi Bodio, *Della Statistica nei suoi rapporti coll'economia politica*, &c. (Milan, 1869); Arthur L. Bowley, *Elements of Statistics* (London, 1901); J. Conrad, "Statistik," *Grundriss zum Studieren der politischen Oekonomie, vierter Teil*; (2nd ed., Jena, 1902) (*vierter Teil*); Elderton (W. Palin and Ethel M.), *Primer of Statistics* (London, 1910); F. Faure, *Éléments de statistique* (Paris, 1906); A. Gabaglio, *Storia e teoria della statistica* (Milan, 1880); Max Haushofer, *Lehr- und Handbuch der Statistik* (2nd ed., Vienna, 1882); K. Knies, *Die Statistik als selbständige Wissenschaft* (Cassel, 1850); A. Liesse, *La Statistique* (Paris, 1905); R. Mayo-Smith, *Science of Statistics* (1895); G. von Mayr, *Die Gesetzmässigkeit im Gesellschaftsleben* (Munich, 1877), abridged translation in *Journ. Roy. Stat. Soc.* (Sept. 1883); idem, *Statistik und Gesellschaftslehre*, pts. i. and ii. (Freiburg, 1897); A. Meitzen, *Geschichte, Theorie und Technik der Statistik* (2nd ed., Stuttgart and Berlin, 1903); A. Quetelet, various works, but especially that entitled *Sur l'homme et le développement de ses facultés, ou Essai de physique sociale* (Paris, 1837); and *Letters on the Theory of Probability*; idem, *Lettres à s.a.r. le duc régnant de Saxe-Coburg et Gotha sur la théorie des probabilités* (Brussels, 1846); A. C. F. Schäffle, *Bau und Leben des sozialen Körpers* (Tübingen, 1881), especially pt. ii. pp. 463 seq., and pt. iv. pp. 493 seq.; Herbert Spencer, *Principles of Sociology* (London, 1877), especially pt. ii. p. 465 seq.; A. Wagner, article "Statistik," in Buntschli-Brater's *Staatswörterbuch*, vol. x.; H. Westergaard, *Die Grundzüge der Theorie der Statistik* (Jena, 1890). (W. Ho.)

STATIUS, PUBLIUS PAPINIUS (c. A.D. 45-96), Latin poet, was born at Naples. He was, to a great extent, devoted by birth and training to the profession of a poet. The Statii were of Graeco-Campanian origin, and were of gentle extraction, though impoverished, and the family records were not without political distinctions. The poet's father taught with marked success at Naples and Rome, and from boyhood to age he proved himself a champion in the poetic tournaments which formed an important part of the amusements of the early empire. The younger Statius declares that his father was in his time equal to any literary task, whether in prose or verse. Probably the poet inherited a modest competence and was not under the necessity of begging his bread from wealthy patrons. He certainly wrote poems to order (as *Silvae*, i. 1, 2, ii. 7, and iii. 4), but there is no indication that the material return for them was important to him, in spite of an allusion in Juvenal's seventh satire. Of events in the life of Statius we know little. From his boyhood he was victorious in poetic contests—many times at his native city Naples, thrice at Alba, where he received the golden crown from the hand of the emperor Domitian. But at the great Capitoline competition (probably on its third celebration in 94 A.D.) Statius failed to win the coveted chaplet of oak leaves. No doubt the extraordinary popularity of his *Thebais* had led him to regard himself as the supreme poet of the age, and when he could not sustain this reputation in the face of rivals from all parts of the empire he accepted the judges' verdict as a sign that his day was past, and retired to Naples, the home of his ancestors and of his own young years. We still possess the poem he addressed to his wife on this occasion (*Silv.* iii. 5). There are hints in this poem which naturally lead to the surmise that Statius was suffering from a loss of the emperor's favour; he may have felt that a word from Domitian would have won for him the envied garland, and that the word ought to have been given. In the preface to book iv. of the *Silvae* there is mention of detractors who hated our poet's style, and these may have succeeded in inducing a new fashion in poetry at court. Such an eclipse, if it happened, must have cut Statius to the heart. He appears to have relished thoroughly the rôle of court-poet. The statement sometimes made that the elder Statius had been the emperor's teacher, and had received many

favours from him, so that the son inherited a debt of gratitude, seems to have no solid foundation. Statius lauds the emperor, not to discharge a debt, but rather to create an obligation. His flattery is as far removed from the gentle propitiatory tone of Quintilian as it is from the coarse and crawling humiliation of Martial. It is in the large extravagant style of a nature in itself healthy and generous, which has accepted the theme and left scruples behind. In one of his prefatory epistles Statius declares that he never allowed any work of his to go forth without invoking the godhead of the divine emperor. Statius had taken the full measure of Domitian's gross taste, and, presenting him with the rodomontade which he loved, puts conscience and sincerity out of view, lest some uneasy twinge should mar his master's enjoyment. But in one poem, that in which the poet pays his due for an invitation to the Imperial table, we have sincerity enough. Statius clearly feels all the raptures he expresses. He longs for the power of him who told the tale of Dido's banquet, and for the voice of him who sang the feast of Alcinous, that he may give forth utterance worthy of the lofty theme. The poet seemed, he says, to dine with great Jove himself and to receive nectar from Ganymede the cup-bearer (an odious reference to the imperial favourite Earinus). All his life hitherto has been barren and profitless. Now only has he begun to live in truth. The palace struck on the poet's fancy like the very hall of heaven; nay, Jove himself marvels at its beauty, but is glad that the emperor should possess such an earthly habitation; he will thus feel less desire to seek his destined abode among the immortals in the skies. Yet even so gorgeous a palace is all too mean for his greatness and too small for his vast presence. "But it is himself, himself, that my eager eye has alone time to scan. He is like a resting Mars or Bacchus or Alcides." Martial too swore that, were Jove and Domitian both to invite him to dinner for the same day, he would prefer to dine with the greater potentate on the earth. Martial and Statius were no doubt supreme among the imperial flatterers. Each was the other's only serious rival. It is therefore not surprising that neither should breathe the other's name. Even if we could by any stretch excuse the bearing of Statius towards Domitian, he could never be forgiven the poem entitled "The Hair of Flavius Earinus," Domitian's Ganymede (*Silv.* iii. 4), a poem than which it would be hard to find a more repulsive example of real poetical talent defiled for personal ends. Everything points to the conclusion that Statius did not survive his emperor—that he died, in fact, a short time after leaving Rome to settle in Naples. Apart from the emperor and his minions, the friendships of Statius with men of high station seem to have been maintained on fairly equal terms. He was clearly the poet of society in his day as well as the poet of the court.

As poet, Statius unquestionably shines in many respects when compared with most other post-Augustans. He was born with exceptional talent, and his poetic expression is, with all its faults, richer on the whole and less forced, more buoyant and more felicitous, than is to be found generally in the Silver Age of Latin poetry. Statius is at his best in his occasional verses, the *Silvae*, which have a character of their own, and in their best parts a charm of their own. The title was proper to verses of rapid workmanship, on everyday themes. Statius prided himself on his powers of improvisation, and he seems to have been quite equal to the feat, which Horace describes, of dictating two hundred lines in an hour while standing on one leg. The improvisatore was in high honour among the later Greeks, as Cicero's speech for the poet Archias indicates; and the poetic contests common in the early empire did much to stimulate ability of the kind. It is to their velocity that the poems owe their comparative freshness and freedom, along with their loose texture and their inequality. There are thirty-two poems, divided into five books, each with a dedicatory epistle. Of nearly four thousand lines which the books contain, more than five-sixths are hexameters. Four of the pieces (containing about 450 lines) are written in the hendecasyllabic metre, the "tiny metre of Catullus," and there is one Alcaic and one Sapphic ode. The subjects of the *Silvae* are very various. Five poems are devoted to flattery of the emperor and his favourites; but of these enough has already been said. Six are lamentations for deaths, or consolations to survivors. Statius seems to have felt a special pride in this class of his productions; and certainly, notwithstanding the excessive and conventional employment of pretty mythological pictures, with other affectations, he sounds notes of pathos

such as only come from the true poet. There are oftentimes traits of an almost modern domesticity in these verses, and Statius, the childless, has here and there touched on the charm of childhood in lines for a parallel to which, among the ancients, we must go, strange to say, to his rival Martial. One of the *epicedia*, that on Priscilla the wife of Abascantus, Domitian's freedman (*Silv.* v. 1), is full of interest for the picture it presents of the official activity of a high officer of state. Another group of the *Silvae* give picturesque descriptions of the villas and gardens of the poet's friends. In these we have a more vivid representation than elsewhere of the surroundings amid which the grandees of the early empire lived when they took up their abode in the country. It was of these pieces that Niebuhr thought when he said that the poems of Statius are charming to read in Italy. They exhibit, better even than Pliny's well-known letters, the passion of the rich Roman for so constructing his country house that light, air, sun and leafage should subserve his luxury to the utmost, while scope was left for displaying all the resources of art which his wealth enabled him to command. As to the rest of the *Silvae*, the congratulatory addresses to friends are graceful but commonplace, nor do the jocose pieces call for special mention here. In the "Kalendae decembres" we have a striking description of the gifts and amusements provided by the emperor for the Roman population on the occasion of the Saturnalia. In his attempt at an epithalamium (*Silv.* i. 2) Statius is forced and unhappy. But his birthday ode in Lucan's honour (*Silv.* ii. 7) has, along with the accustomed exaggeration, many powerful lines, and shows high appreciation of preceding Latin poets. Some phrases, such as "the untaught muse of high-souled Ennius" and "the lofty passion of sage Lucretius," are familiar words with all scholars. The ode ends with a great picture of Lucan's spirit rising after death on wings of fame to regions whither only powerful souls can ascend, scornfully surveying earth and smiling at the tomb, or reclining in Elysium and singing a noble strain to the Pompeys and the Catos and all the "Pharsalian host," or with proud tread exploring Tartarus and listening to the wailings of the guilty, and gazing at Nero, pale with agony as his mother's avenging torch glitters before his eyes. It is singular to observe how thoroughly Nero had been struck out of the imperial succession as recognized at court, so that the "bald Nero" took no umbrage when his flatterer-in-chief profanely dealt with his predecessor's name.

The epic poems of Statius are less interesting because cast in a commoner mould, but they deserve study in many respects. They are the product of long elaboration. The *Thebais*, which the poet says took twelve years to compose, is in twelve books, and has for its theme the old "tale of Thebes"—the deadly strife of the Theban brothers. There is also preserved a fragment of an *Achilleis*, consisting of one book and part of another. In the weary length of these epics there are many flowers of pathos and many little finished gem-pictures, but the trammels of tradition, the fashionable taste and the narrow bars of education check continually the poet's flight. Not merely were the materials for his epics prescribed to him by rigid custom, but also to a great extent the method by which they were to be treated. All he could do was to sound the old notes with a distinctive *timbre* of his own. The gods must needs wage their wonted epic strife, and the men, their puppets, must dance at their nod; there must needs be heavenly messengers, portents, dreams, miracles, single combats, similes, Homeric and Virgilian echoes, and all the other paraphernalia of the conventional epic. But Statius treats his subjects with a boldness and freedom which contrast pleasingly with the timid traditionalism of Silius Italicus and the stiff scholasticism of Valerius Flaccus. The vocabulary of Statius is conspicuously rich, and he shows audacity, often successful, in the use of words and metaphors. At the same time he carried certain literary tricks to an aggravating pitch, in particular the excessive use of alliteration, and the misuse of mythological allusion. The most well-known persons and places are described by epithets or periphrases derived from some very remote connexion with mythology, so that many passages are as dark as Heraclitus. The *Thebais* is badly constructed. The action of the epic is hindered and stopped by enormous episodes, one of which fills one-sixth of the poem. Nor had Statius a firm grasp or clear imagination of character. So trying are the late ancient epics to a modern reader that he who has read any one of the three—Statius, Silius and Valerius Flaccus (Lucan stands apart)—will with difficulty be persuaded to enter on the other two. Yet, if he honestly reads them all, he can hardly fail to rank Statius the highest of the three by a whole sphere.

The *editio princeps* of the epics is dated 1470, of the *Silvae* 1472. Notable editions since have been those of Bernartius (Antwerp, 1595), Gronovius (1653) and Barth (1664). Recent texts are the Teubner (the *Achilleis* and *Thebais* by Kohlmann, the *Silvae* by Baehrens) and that contained in the new edition of the *Corpus poetarum latinorum*; and of the *Silvae* only, texts by Klotz (1899), and Vollmer (1898), the last with an explanatory commentary. Among editions of portions of Statius's works, that of the *Silvae* by Jeremiah Markland, fellow of Peterhouse in Cambridge (1728), deserves special attention. A translation of the *Silvae* with introduction and notes was published by D. A. Slater in 1908 (Oxford

Library of Translations). A critical edition of the *Thebais* and *Achilleis* was begun by O. Müller (1870) but not completed. The condition of the text of the *Silvae* is one of the most curious facts in the history of ancient literature. Poggio discovered a MS. at St Gallen and brought it into Italy. This MS. has disappeared, but from it are derived all our existing MSS., except one of the birthday ode to Lucan, now at Florence, and of the 10th century. Politian collated Poggio's MS. with the *editio princeps*, and the collation has come down to us, and is the principal basis of the text. The MSS. of the epics are numerous, as was to be expected from their great popularity in the middle ages, to which Dante is witness (see *Purg.* xxi., where an interview with the shade of Statius is described at some length). (J. S. R.)

STATUTE, a law made by the "sovereign power" in the state (see ACT OF PARLIAMENT). It forms a part of the *lex scripta*, or written law, which by English legal authorities is used solely for statutory law, a sense much narrower than it bore in Roman law. To make a statute the concurrence of the Crown and the three estates of the realm is necessary. Thus a so-called statute of 5 Ric. II. c. 5, directed against the Lollards, was afterwards repudiated by the Commons as passed without their assent. The validity of a statute was indeed at times claimed for ordinances such as that just mentioned, not framed in accordance with constitutional rule, and was actually given to royal proclamations by 31 Hen. VIII. c. 8 (1539). But this act was repealed by 1 Edw. VI. c. 12, and since that time nothing but a statute has possessed the force of a statute, unless indeed certain rules or orders depending ultimately for their sanction upon a statute may be said to have such force. Examples of what may be called indirect legislation of this kind are orders in council (see PRIVY COUNCIL), by-laws made under the powers of the Public Health Acts, Municipal Corporation Acts and other Acts, and rules of court such as those made under the powers of the Judicature Acts and Acts of Sederunt of the Court of Session.

The list of English statutes as at present existing begins with the Statute of Merton, 1235.¹ Many of the earlier statutes are known by the names of the places at which they were passed, e.g. the Statutes of Merton, Marlbridge, Gloucester, Westminster, or by their initial words, e.g. *Quia Emptores*, *Circumspecte Agalis*. The earliest existing statute roll is 6 Edw. I. (the Statute of Gloucester). After 4 Hen. VII. the statute roll ceased to be made up, and enrolments in chancery (first made in 1485) take its place. Some of the acts prior to the Statute of Gloucester are of questionable authority, but have gained recognition by a kind of prescription.

All statutes were originally public, irrespective of their subject-matter. The division into public and private dates from the reign of Richard III. At present statutes are of four kinds, public general acts, public local and personal acts, private acts printed by the king's printers and private acts not so printed. The division into public general and public local and personal rests upon a resolution of both Houses of Parliament in 1798. In 1815 a resolution was passed in accordance with which private acts are printed, with the exception of name, estate, naturalization and divorce acts. The last two are now practically superseded by the provisions of the Divorce Act 1857 (except as to Ireland and India), and the Naturalization Act 1870. Since 1815 it has been usual to refer to public general acts by Arabic numerals, e.g. 3 Edw. VII. c. 21, public local and personal acts by small Roman numerals, e.g. 3 Edw. VII. c. xxi. Each act is strictly but a chapter of the legislation of the session, which is regarded as composing a single act divided into chapters for convenience, the chapters themselves being also called acts. The citation of previous acts is provided for by 13 and 14 Vict. c. 21, § 3. It is now usual for each chapter or act to contain a short title by which it may be cited, e.g. the Elementary Education Act 1870. The Short Titles Act 1892 created short titles for numerous single acts and groups of acts, and since then it has been usual to cite acts and groups by their short titles—where possible—

¹ Ruffhead's edition of the statutes begins with the Magna Carta of 1225. But in the *Revised Statutes* that form of Magna Carta which is now law appears as a statute of the year 1297. It is often known as *Confirmatio cartarum*, and is a recital and confirmation by Edward I. of the chief provisions of John's charter.

rather than by the year of the reign. 8 & 9 Vict. c. 113, s. 3, makes evidence the king's printers' copies of private and local and personal acts. A private act not printed by the king's printers is proved by an examined copy of the parliament roll.

A public act binds all subjects of the realm, and need not be pleaded (except where the law from motives of policy specially provides for pleading certain acts, as in the defences of not guilty by statute, the Statute of Frauds and the Statute of Limitations). A private act must generally be pleaded, and does not as a rule bind strangers to its provisions. Formerly an act took effect from the first day of the session in which it was passed. The hardship caused by this technical rule has been obviated by 33 Geo. III. c. 13, by which an act takes effect from the day on which it receives the royal assent, where no other date is named. This has been held to mean the beginning of the day, so as to govern all matters occurring on that day. An act cannot in the strict theory of English law become obsolete by disuse. Nothing short of repeal can limit its operation. The law has, however, been interpreted in many cases with somewhat less rigour. In the case of a prosecution for blasphemy in 1883 (*R. v. Ramsay*) Lord Coleridge said, "though the principles of law remain unchanged, yet (and it is one of the advantages of the common law) their application is to be changed with the changing circumstances of the times."¹ This would be applicable as much to the interpretation of statutes as to other parts of the common law. The title, preamble and marginal notes are strictly no part of a statute, though they may at times aid its interpretation.

Besides the fourfold division above mentioned, statutes are often classed according to their subject-matter, as perpetual and temporary, penal and beneficial, imperative and directory, enabling and disabling. Temporary acts are those which expire at a date fixed in the act itself. Thus the Army Act is passed annually and continues for a year; the Ballot Act 1872 expired at the end of 1880, and the Regulation of Railways Act 1873 at the end of five years. By means of these temporary acts experimental legislation is rendered possible in many cases where the success of a new departure in legislation is doubtful. In every session an Expiring Laws Continuance Act is passed for the purpose of continuing (generally for a year) a considerable number of these temporary acts. By 48 Geo. III. c. 106 a continuing act is to take effect from the date of the expiration of a temporary act, where a bill for continuing the temporary act is in parliament, even though it be not actually passed before the date of the expiration. Penal acts are those which impose a new disability; beneficial, those which confer a new favour. An imperative statute (often negative or prohibitory in its terms) makes a certain act or omission absolutely necessary, and subjects a contravention of its provisions to a penalty. A directory statute (generally affirmative in its terms) recommends a certain act or omission, but imposes no penalty on non-observance of its provisions. To determine whether an act is imperative or directory the act itself must be looked at, and many nice questions have arisen on the application of the rule of law to a particular case. Enabling statutes are those which enlarge the common law, while disabling statutes restrict it. This division is to some extent coincident with that into beneficial and penal. Declaratory statutes, or those simply in affirmation of the common law, were at one period not uncommon, but they are now practically unknown. The Treason Act 1351 is an example of such a statute. Statutes are sometimes passed in order to overrule specific decisions of the courts. Examples are the Factors Act 1877, the Territorial Waters Jurisdiction Act 1878, the Married Women's Property Act 1893, the Trade Disputes Act 1906.

The construction or interpretation of statutes depends partly on the common law, partly on statute. The main rules of the common law, as gathered from the best authorities, are these:

¹ This opinion carries out to a certain extent the view of Locke, who in article 79 of his *Carolina Code* recommended the determination of acts of the legislature by effluxion of time after a hundred years from their enactment.

(1) Statutes are to be construed, not according to their mere letter, but according to the intent and object with which they were made. (2) The relation of the statute to the common law is to be considered. In the words of the resolution of the Court of Exchequer in *Heydon's case*, 3 Coke's Rep. 7, the points for consideration are: "(a) What was the common law before the making of the act? (b) What was the mischief and defect against which the common law did not provide? (c) What remedy the parliament hath resolved and appointed to cure the disease of the Commonwealth? (d) The true reason of the remedy." (3) Beneficial or remedial statutes are to be liberally, penal more strictly, construed. (4) Other statutes *in pari materia* are to be taken into consideration. (5) A statute which treats of persons of inferior rank cannot by general words be extended to those of superior rank. (6) A statute does not bind the Crown, unless it be named therein. (7) Where the provision of a statute is general, everything necessary to make such provision effectual is implied. (8) A later statute repeals an earlier, as far as the two are repugnant, but if they may stand together repeal will not be presumed. (9) There is a presumption against creation of new or ousting of existing jurisdictions, against impairing obligations, against retrospective effect, against violation of international law, against monopolies, and in general against what is inconvenient or unreasonable. (10) If a statute inflicts a penalty, the penalty implies a prohibition of the act or omission to which the penalty is imposed. Whether the remedy given by statute is the only one depends on the words of the particular act. In some cases an action or an indictment will lie; in others the statutory remedy, generally summary, takes the place of the common law remedy. In some instances the courts have construed the imposition of a penalty as operating not to invalidate a contract but to create a tax upon non-compliance with the terms of the statute. The Interpretation Act 1889 provides an authentic interpretation for numerous words and phrases of frequent occurrence in statutes. In addition to these general provisions most statutes contain an interpretation clause or interpretation clauses dealing with special words or phrases. A very detailed example is s. 742 of the Merchant Shipping Act 1894.

The earlier acts are generally simple in character and language, and comparatively few in number. At present the number passed every session is enormous; in the session of 1906 it was 58 general and 212 local and personal acts, the former being under the average. Without going as far as to concede with an eminent legal authority that of such legislation three-fourths is unnecessary and the other fourth mischievous, it may be admitted that the immense library of the statutes would be but a trackless desert without trustworthy guides. Revision of the statutes was evidently regarded by the legislature as desirable as early as 1563 (see the preamble to 5 Eliz. c. 4). It was demanded by a petition of the Commons in 1610. Both Coke and Bacon were employed for some time on a commission for revision. In 1861 was passed the first of a long series of Statute Law Revision Acts. The most important action, however, was the nomination of a revision committee by Lord Chancellor Cairns in 1868, the practical result of which has been the issue of an edition of the *Revised Statutes* in eighteen volumes, bringing the revision of statute law down to 1886. This edition is of course subject to the disadvantage that it becomes less accurate every year as new legislation appears. A *Chronological Table and Index of the Statutes* which are still law is published from time to time by the council of law reporting.

The chief editions of the British statutes are the *Statutes of the Realm* printed by the king's printers, Ruffhead's and the fine folio edition issued from 1810 to 1824 in pursuance of an address from the House of Commons to George III.

AUTHORITIES.—The safest authority is of course the *Revised Statutes*. Chitty's collection of *Statutes of Practical Utility* is a useful compilation. Among the earlier works on statute law may be mentioned the readings and commentaries on statutes by great lawyers, such as the second volume of Coke's *Institutes*, Bacon's *Reading on the Statute of Uses*, Barrington's *Observations on the more ancient Statutes from Magna Carta to the 21 Jac. I. c. 27* (5th ed., 1796), and the Introduction to Blackstone's *Commentaries*. Among the later works are the treatises of Dwarria (2nd ed., 1848) and Sir P. B. Maxwell (3rd ed., 1905) and Hardcastle (3rd ed., 1901). On the interpretation of statutes, see Lord Farnborough, *The Machinery of Parliamentary Legislation* (1881); Sir C. P. Ilbert, *Legislative Methods and Forms* (1901); Sir H. Thring, *Practical Legislation, or the Composition and Language of Acts of Parliament* (1902).

Scotland.

The statutes of the Scottish parliament before the union differed from the English statutes in two important respects; they were passed by the estates of the kingdom sitting together and not in separate houses, and from 1367 to 1690 they were discussed only after preliminary consideration by the lords of the articles.² An act

² The Scottish parliament from an early date discharged its functions by the aid of two committees known as the legislative and judicial committees. The legislative committee were termed lords of the articles and existed until 1688. The judicial committee were called lords auditors.

of the Scottish parliament may in certain cases cease to be binding by desuetude. "To bring an act of parliament like those we are dealing with" (*i.e.* the Sabbath Profanation Acts) "into what is called in Scots law the condition of desuetude, it must be shown that the offence prohibited is not only practised without being checked but is no longer considered or dealt with in this country as an offence against law" (Lord Justice General Inglis in *Bule's case*, 1 Couper's Rep., 495). Acts of the imperial parliament passed since the union extend in general to Scotland, unless that country be excluded from their operation by express terms or necessary implication. Scottish acts are cited thus, 1678, c. 10. The best edition is that issued by order of the Treasury, 1844-1875. An edition of the revised statutes has been facilitated by the repeal of obsolete statutes by the Statute Law Revision (Scotland) Act 1906.

Ireland.

Originally the lord deputy appears to have held parliaments at his option, and their acts were the only statutory law which applied to Ireland, except as far as judicial decisions had from motives of policy extended to that country the obligation of English statutes. In 1495 the act of the Irish parliament known as Poyning's Law or the Statute of Drogheda enacted that all statutes lately made in England be deemed good and effectual in Ireland. This was construed to mean that all statutes made in England prior to the 18 Hen. VII. were valid in Ireland, but none of later date were to have any operation unless Ireland were specially named therein or unless adopted by the Irish parliament (as was done, for instance, by Yelverton's Act, 21 & 22 Geo. III. c. 48 (I.). Another article of Poyning's Law secured an initiative of legislation to the English privy council, the Irish parliament having simply a power of acceptance or rejection of proposed legislation. The power of the parliament of Great Britain to make laws to bind the people of Ireland was declared by 6 Geo. I. c. 5. This act and the article of Poyning's Law were repealed in 1782, and the short-lived independence of the parliament of Ireland was recognized by 23 Geo. III. c. 28. The application of acts passed since the union is the same as in the case of Scotland. Divorce acts are still passed for Ireland (see *DIVORCE*). Irish acts are cited thus, 26 Geo. III. c. 15 (I.) or (Ir.). The best edition is that issued in twenty volumes pursuant to an order of the earl of Halifax, lord-lieutenant in 1762. A volume of revised statutes was published in 1885. The earliest that is still law is one of 1459.

British Colonies and Dependencies.

Acts of the imperial parliament do not extend to the Isle of Man, the Channel Islands or the colonies, unless they are specially named therein. By the Colonial Laws Validity Act 1865 ("the charter of colonial legislative independence") any colonial law repugnant to the provisions of any act of parliament extending to the colony is void to the extent of such repugnancy, and no colonial law is to be void by repugnancy to the law of England unless it be repugnant to such an act of parliament. For colonies without representative legislatures the Crown usually legislates, subject to the consent of parliament in particular cases. Examples of imperial legislation for the colonies in general are the Colonial Stock Act 1877, and the Colonial Courts of Admiralty Act 1890. For imperial acts dealing with particular colonies may be cited the British North America Act 1867, and the Commonwealth of Australia Constitution Act 1900. A colony is defined for the purposes of imperial legislation by the Interpretation Act 1889, s. 18. In many of the colonies, as in Canada, the constitutionality of an act of the colonial legislature is, as in the United States, a matter for the determination of the local court or of the judicial committee of the privy council on appeal.

United States.

By the constitutions of many states English statute law, as it existed at the time of the separation from England, and as far as it is applicable, has been adopted as part of the law of the states. The United States and the state are not bound by an act of Congress or a state law unless specially named. The states legislate for themselves within the limits of their own constitution and that of the United States. Here appears the striking difference between the binding force of a statute of the United Kingdom and an act passed by Congress or a state legislature. In the United Kingdom parliament is supreme; in the United States an act is only of authority if it is in accordance with the constitution. The courts may declare an act void if it contravene the constitution of the United States or of a state, so that practically the Supreme Court of the United States is the ultimate legislative authority. The restrictions upon Federal legislation in the constitution of the United States provide against the suspension of the writ of habeas corpus except in case of rebellion or invasion, the passing of a bill of attainder or *ex post facto* law, the imposition of capitation or

other direct tax, unless in proportion to the several states, or of a tax or duty on exports, the preference of the ports of one state over those of another, the drawing of money from the treasury except by appropriations made by law, and the grant of a title of nobility. Constitutional amendments contain further limitations, *e.g.* the taking of private property for public use without just compensation, and the abridging of the right of citizens on account of race, colour or previous condition of servitude. State legislation is limited by s. 10: "No state shall . . . make anything but gold and silver coin a tender in payment of debts, pass any bill of attainder, *ex post facto* law, or law impairing the obligation of contracts, or grant any title of nobility." The section further forbids imposition of duties on imports or exports or any duty of tonnage without consent of Congress. State constitutions often contain further restrictions; among the more usual are provisions against laws with a retrospective operation, or impairing the obligation of contracts, or dealing with more than one subject to be expressed in the title. The time when a statute is to take effect after its passing is often fixed by state constitutions. The statutes of the United States were revised under the powers of an act of Congress passed in 1874 (sess. i. c. 333), and the volume of *Revised Statutes* was issued in 1875. There was a second edition in 1878 and several supplements have appeared since that date. Many of the states have also issued revised editions of their statutes. The rules of construction are in general agreement with those adopted in England. In some states the referendum has been introduced in certain cases.

Continental European Countries.

In most European countries there is a code, the existence of which makes the system of legislation hardly comparable to ours. The assent of two chambers and of the monarch, or president, is generally necessary. Greece is an exception; it is the only state in Europe with one chamber.

International Law.

The term "statute" is used by international jurists and civilians mostly on the continent of Europe to denote the whole body of the municipal law of the state. In this sense statutes are either real, personal or mixed. A real statute is that part of the law which deals directly with property, whether movable or immovable. A personal statute has for its object a person, and deals with questions of status, such as marriage, legitimacy or infancy. A mixed statute affects both property and person, or, according to some authorities, it deals with acts and obligations. Personal statutes are of universal validity; real statutes have no extra-territorial authority. The determination of the class under which a particular law ought to fall is one of great difficulty, and one in which there is often a conflict of legal opinion. On the whole the division appears to have created more difficulties than it has solved, and it is rejected by Savigny as unsatisfactory.

See Story, *Conflict of Laws*, §§ 12-16; Phillimore, *International Law*, vol. iv. ch. xvi.; Pillet, *Principes de droit international privé*, chs. xi. and xii. (J. W.)

STATUTE MERCHANT and **STATUTE STAPLE**, two old forms of security, long obsolete in English practice, though references to them still occur in some modern statutes. The former security was first created by the Statute of Acton Burnell (1283) and amplified by the Statute of Merchants (1285)—whence its name—and the latter by an act of 1353, which provided that in every staple (*i.e.* public mart) the seal of the staple should be sufficient validity for a bond of record acknowledged and witnessed before the mayor of the staple. They were originally permitted only among traders, for the benefit of commerce, but afterwards extended by an act of Henry VIII. (1532) to all subjects, whether traders or not. The creditor under either form of security was allowed to seize the goods and hold the lands of a defaulting debtor until satisfaction of his debt. While he held the lands he was termed tenant by statute merchant or by statute staple. In addition to the loss of his goods and lands the debtor was liable to be imprisoned. Statute merchant, owing to the summary method of enforcing payment, was sometimes known as "pocket judgment." Both were repealed by the Statute Law Revision Act 1863.

STAUNTON, SIR GEORGE THOMAS, BART. (1781-1859), English traveller and Orientalist, was born near Salisbury on the 26th of May 1781. He was the son of Sir George Leonard

Staunton (1737–1801), first baronet, diplomatist and Orientalist, and in 1792 accompanied his father, who had been appointed secretary to Lord Macartney's mission to China, to the Far East. He acquired a good knowledge of Chinese, and in 1798 was appointed a writer in the East India Company's factory at Canton, and subsequently its chief. In 1805 he translated a work of Dr George Pearson into Chinese, thereby introducing vaccination into China. In 1816 he proceeded as second commissioner on a special mission to Peking with Lord Amherst and Sir Henry Ellis. Between 1818 and 1852 he was M.P. for several English constituencies, finally for Portsmouth. He was a member of the East India Committee, and in 1823, in conjunction with Henry Thomas Colebrooke founded the Royal Asiatic Society. He died on the 10th of August 1859.

His publications include translations of *Ta Tsing leu lee, being the Fundamental Laws of China* (1810), the first Chinese book translated into English, and of the *Narrative of the Chinese Embassy to the Khan of the Tourgouth Tartars* (1821); *Miscellaneous Notices Relating to China and our Commercial Intercourse with that Country* (1822); *Notes of Proceedings and Occurrences during the British Embassy to Peking* (1824); *Observations on our Chinese Commerce* (1850). For the Hakluyt Society he edited Gonzalez de Mendoza's *History of the Great and Mighty Kingdom of China*.

STAUNTON, HOWARD (1810–1874), English Shakespearian scholar and writer on chess, supposed to have been a natural son of Frederic Howard, fifth earl of Carlisle, was born in 1810. He is said to have studied at Oxford, but if so, he never matriculated. Settling in London he soon spent the small fortune left him under his father's will and began to make his living by journalism. He gave much of his attention to the study of the English dramatists of the Elizabethan age. As a Shakespearian commentator he showed the qualities of acuteness and caution which made him excel in chess. He possessed, moreover, a thorough mastery of the literature of the period, shown in his papers in the *Athenaeum* on "Unsuspected Corruptions of Shakespeare's text," begun in October 1872. These formed part of the materials which he intended to utilize in a proposed edition of Shakespeare which never became an accomplished fact. In 1864 he published a facsimile of the Shakespeare folio of 1623, and a facsimile edition of *Much Ado about Nothing*, photolithographed from the quarto of 1600. He died in London on the 22nd of June 1874. Staunton's services to chess literature were very great, and the game in England owes much of its later popularity to him, while for thirty years he was the best player in England, perhaps in the world. For his important works on the subject see CHESS.

STAUNTON, an independent city and the county-seat of Augusta county, Virginia, U.S.A., about 135 m. N.W. of Richmond. Pop. (1890) 6975; (1900) 7289, including 1828 negroes and 149 foreign-born; (1910) 10,604. Staunton is served by the Chesapeake & Ohio and the Baltimore & Ohio railways. It lies between the Alleghany Mountains and the Blue Ridge, on a plateau about 1380 ft. above sea-level, in a fertile farming country with good pasture on the hillsides. In Staunton are a county court-house, the Western State hospital for the insane (1828), the Virginia school for the deaf and the blind (1839), the King's Daughters' hospital (1895), Dunsmore business college, Staunton military academy, the Mary Baldwin seminary, formerly Augusta female seminary (founded in 1842) and Stuart Hall (for girls), which was founded in 1843, was incorporated in 1845, and was reincorporated in 1907 under its present name in honour of Mrs J. E. B. Stuart, wife of the confederate cavalry leader, who was its principal in 1879–1898. One mile east of Staunton is a U.S. national military cemetery with graves of 753 Union soldiers killed at Port Republic, Cross Keys and Piedmont; and west of the city is a Confederate cemetery with a memorial monument. The municipality owns the waterworks, the electric-lighting plant and the opera house. An interesting feature of the city government is the employment of a business manager (elected annually by the city council), whose duties are in general similar to those of the business manager of a large corporation—e.g. he buys the city's supplies and has general supervision over the city improvements.

The first settlement in this vicinity was on Lewis Creek, about 2 m. east of the city, in 1731. A county court-house was built here in 1745, and the name Staunton, in honour of the wife of Sir William Gooch (then lieutenant-governor), whose maiden name was Staunton, was used in 1748–1749, but Staunton was not incorporated as a town until 1761. It was chartered as a city in 1870, and then became a municipality independent of the county. The corporate limits of the city were extended in 1905 and, as its population thus became more than 10,000, Staunton was made a city of the first class.

STAUROLITE, a mineral consisting of basic aluminium and ferrous iron silicate with the formula $HFeAl_3Si_2O_{13}$. The material is, however, usually very impure, the crystals enclosing sometimes as much as 30 or 40% of quartz and other minerals as well as carbonaceous matter. Crystals are orthorhombic and have the form of six-sided prisms. Interpenetrating cruciform twinned crystals are very common and characteristic; they were early known as *pierres de croix* or *lapis crucifer*, and the name staurolite, given by J. C. Delamétherie in 1792, has the same meaning (Greek, *σταυρός*, a cross, and *λίθος*, a stone). In fig. 1 the twin-plane is (032) and the two prisms intercross

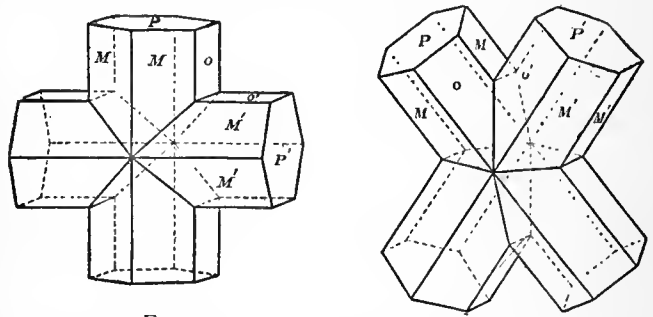

FIG. 1. FIG. 2. Twinned Crystals of Staurolite.

at an angle of $91^\circ 22'$; in fig. 2 the twin-plane is (232) and the prisms intercross at nearly 60° . The mineral is translucent to opaque and dark reddish-brown in colour; it thus has a certain resemblance to garnet, and on this account has been called grenatite. Waterworn pebbles of material sufficiently transparent for cutting as gem-stones are occasionally found in the diamantiferous sands of Brazil. The hardness is $7\frac{1}{2}$ and the specific gravity 3.75. Staurolite is a characteristic mineral of crystalline schists, and it is also a product of contact-metamorphism. Large twinned crystals with rough surfaces are found in mica-schist in Brittany and at several places in the United States, e.g. in Fannin county, Georgia. Untwinned crystals, translucent and of a rich brown colour (grenatite), are abundant in the silvery white paragonite-schist of Monte Campione, St Gothard. (L. J. S.)

STAVANGER, a seaport of Norway, capital of Stavanger amt (county), on the west coast in 59° N. (that of the Orkney Islands and northern Labrador). Pop. (1900), 30,541. It lies on the south side of the Bukken Fjord, and has a picturesque harbour well sheltered by islands. The town is one of the oldest in Norway, founded in the 8th or 9th century, but the present town is modern, though narrow, winding streets and wooden houses give it an antique appearance. It became the seat of a bishopric in the 13th century. Though the bishop's see was removed to Christiansand in 1685, the Romanesque cathedral church of St Swithun, founded by the English bishop Reinald in the end of the 11th century, and rebuilt after being burned down in 1272, remains, and, next to the cathedral of Trondhjem, is the most interesting stone church in Norway. There is an ornate painted pulpit of carved wood (1658). The old episcopal palace of Kongsgaard is now a Latin school. There are a theatre, an interesting museum of antiquities, natural history and art; and a picturesque park (Bjergsted). The industries of the town and its environs (Sandnaes, &c.) are prosperous, including factories for preserved foods, woollens and lincens, lime, iodine from seaweed, and domestic commodities. The

fisheries are important—for herring, mackerel, sprats, cod, salmon, lobsters and anchovies. On Rennes Island in the fjord, over against the town, there is a Cheviot sheep-breeding farm under government auspices. The imports consist principally of coal, salt, grain and flour, groceries, textiles, wood, and mineral oils. The most important export is fish, other items being seaweed, marble, preserved foods, butter and margarine and infusorial earth.

Stavanger is the first port of call for northward-bound passenger steamers from Hull and Newcastle, and has regular services from all the Norwegian coast towns, from Hamburg, &c. A railway runs south along the wild and desolate coast of Jæderen, one of the few low and unprotected shores in Norway, the scene of many wrecks. Stavanger commands a considerable tourist traffic. It is the starting-point of a favourite tour, embracing the fine valley of the Sand River, the great Lake Suldal and the Bratlandsdal. The Lyse Fjord, a branch of the Bukken Fjord, is a fine narrow inlet enclosed by precipitous mountains. Stavanger is the birthplace of Kjelland the novelist (1849).

STAVELEY, a town in the north-western parliamentary division of Derbyshire, England, 12 m. S.E. of Sheffield, on the Midland and the Great Central railways. Pop. (1901), 11,420. It lies in the valley of the Rother, in a populous industrial district, devoted chiefly to the working of coal and iron; while there are manufactures of iron goods and brushes in the town. The church of St John the Baptist is Early English, with much Perpendicular and modern alteration; it contains a number of interesting early monuments.

STAVELOT, an ancient town of Belgium, in the south-east of the province of Liège. Pop. (1904), 5037. Here Charles Martel gained a signal victory over Neustria in 719. A monastery had been established there half a century earlier by St Remacle, bishop of Tongres. The prince-abbot of Stavelot exercised secular authority over many towns in the Amblève and Warche valleys, including Malmédy (now in Prussia), and had a seat in the old German Diet. In 1815 the treaty of Vienna broke up the Stavelot principality, giving half to Prussia and half to the Netherlands. Only the tower of the old Benedictine abbey remains, and the shrine of St Remacle is preserved in the parish church.

STAVROPOL, a government of northern Caucasia, Russia, having an area of 26,492 sq. m. and bounded by the government of Astrakhan and the territory of the Don Cossacks on the N., by Kuban on the W. and by Terek on the S. and E. It occupies the eastern part of the broad steppes which stretch away north from the foot of the main chain of the Caucasus. The western part of the government is diversified by a broad undulating swelling, 1500 to 2000 ft. above sea-level; in the southern part of this swelling, and principally in Terek, there is a group of sixteen mountains, the Beshtau, 2800 to 4600 ft. in height, which are considered by H. Abich to be a porphyritic upheaval at the point of intersection of the two predominant orographical lines in the Caucasus (south-west to north-east and south-east to north-west). Northward and eastward of these heights are extensive steppes, 200 to 400 ft. above the sea, having gentle slopes both to the north (to the depression of the Manych) and to the east (towards the low, arid shores of the Caspian littoral).

Stavropol is chiefly drained by the Kuma and its tributaries (Karamyk and Buivola), its basin being the most fertile part of the government, but the evaporation is so great that the Kuma never reaches the Caspian except in spring. The Manych is not so much a river as a series of lakes, occupying a depression which formerly was a connecting channel between the Black Sea and the Caspian. This channel has two slopes, the eastern sometimes discharging its scanty water-supply into the Kuma, while on the western slope the elongated lakes which fill up the depression drain into the Don, reaching it however only during spring. Two Yegorlyks (Great and Middle), the Kalans, and the Chogra (temporary tributaries of the Manych), drain the western part of Stavropol. On the whole, irrigation is restricted, and in the eastern steppes water is supplied only by cisterns. Besides the lakes of the Manych depression, there are many smaller salt lakes along the Caspian. Timber is scarce, even in the hilly tracts.

The climate is marked by rapid changes of temperature. The

dry east winds are sometimes very violent in the spring and early summer, blowing the seeds out of the fields, and even destroying in a few days all existing vegetation. In July and August they continue for several weeks in succession, and choke the air with dust. The average temperatures at the town of Stavropol (altitude 2030 ft.) are much lower than one might expect in that latitude; that for the year is 47° Fahr., that for January 24°, and that for August 68°. The rainfall at the same place is 28.2 in., but other parts of the government are much worse off in this respect, the yearly rainfall being only 11 to 21½ in.

There is a great lack of forests, which are found only near the town of Stavropol and alongside of the main rivers. In the prairies the only arboreal vegetation is tamarisks and the dwarf almond tree. Altogether, except in the hilly parts of the government, the flora and fauna differ to a great extent from the flora and fauna of other parts of the Caucasus. Both resemble, on the one hand, those of Central Asia in such features as the presence, among mammals and birds, of the antelope *Saiga tatarica*, L., the steppe fox *Vulpes corsac*, Pallas, and the lark *Melanocorypha tatarica*, Pallas, and among plants of, firstly *Tamarix Pallasii*, *Statice caspia* and *Stipa lessingiana* (all characteristic of the arid prairies beyond the Urals), and secondly of species of *Salsola*, *Salicornia*, *Sueda*, *Artemisia*, *Kochia* and *Camphorosma*, all characteristic of the salt steppes of Asia; on the other hand, both flora and fauna have many features in common with the prairies of south Russia.

As regards geology, the whole of the government is covered with Tertiary and post-Tertiary deposits. Lower Miocene, Middle-Mediterranean deposits, and Sarmatian clays, limestones and sandstones crop out over nearly one-half of the surface of the government, namely, in its higher portion, while the remainder is buried under loess and fluvial and lacustrine deposits. A narrow zone, now a low plain almost devoid of vegetation, is overlain with the so-called Caspian deposits.

The population is rapidly increasing, particularly from natural causes, and partly in consequence of immigration. In 1886 it was 702,635; in 1897, 879,758; and in 1906 was estimated at 1,023,700. The average density of the population is only 44 per sq. m., but in some districts it rises to 87. Russians form 90% of the population, the other races being Kalmucks, Turkomans, Nogai Tatars, Armenians, Georgians, Germans, Poles, &c. More than four-fifths of the population (81%) are Russian peasants. The nomad population occupies, however, more than one-third of the territory. There are four ordinary districts, the centres of administration in which are Stavropol, Alexandrovsk, Medveyezhinsk and Praskoveya, the chief town of the district of Novo-grigoryevsk; besides these the territory occupied by the nomads is divided into three districts, Bolshe-Derbetovskiy, Turkoman and Achikulak.

Agriculture is the most important occupation of the settled population, and so large is the harvest that no less than 16,000 labourers come annually from European Russia to assist in gathering in the crops. The peasants own some 48% of the total area, private persons 7%, the imperial government 2% and the Crown less than 2%. Agriculture is most successful on the wide prairie lands, where over 3,250,000 acres are annually under cereals. The principal crops are rye, wheat, oats, barley and potatoes. Melons, water-melons, flax and sunflowers are widely cultivated. Modern agricultural implements are in general use. Vineyards stretch for close upon 100 m. along the Kuma, and nearly 800,000 gallons of wine of an inferior quality are obtained annually. The factories are limited to flour-mills, oil-mills, distilleries, tanneries and candle works, and a few domestic industries are carried on in the villages. Considerable quantities of grain, flax, wool and hides are exported, and the fairs are very animated. Large amounts of corn are exported both to the mountainous districts of Caucasia and to Russia (Rostov-on-the-Don). Livestock breeding is engaged in very largely, not only by the Kalmucks, Turkomans and Nogai Tatars, but also by the Russians.

The northern slopes of the Caucasus began to be colonized by the Russians at a very early period, and as early as the 11th century part of the territory now occupied by Stavropol was known to Russian annalists as the Tmutarakan principality, which had Russian princes. A new attempt to colonize North Caucasia was made in the 16th century, under Ivan the Terrible, who married a Kabardian princess. This was again unsuccessful, and it was not till 1711 that Russia began regularly to colonize the territory by Cossack settlements. Kizlyar was founded in 1736, Stavropol in 1776 or 1777. Vast tracts of lands were given by Catherine II. to her courtiers, who began to people them with serfs from Russia.

(P. A. K.; J. T. BE.)

STAVROPOL, a town of southern Russia, capital of the government of the same name, situated on a plateau 2030 ft. above the sea, on the northern slope of the Caucasus, 200 m. N.W. of Vladikavkaz. It is connected by rail (247 m.) with Rostov-on-the-Don. Although founded only in 1776, it has grown rapidly, and had in 1885 a population of 35,561, and of 46,965 in 1900. Stavropol is an episcopal see of the Orthodox Greek Church, and one of the best-built provincial towns of the

Russian Empire, having wide streets, and houses mostly of stone, with large gardens surrounding the houses. There are public libraries, a people's palace and several scientific societies. Stavropol has flour-mills and various small factories. Large numbers of cattle are sent to Moscow and St Petersburg, while cereals, tallow and sheepskins are exported to Russia, and manufactured wares imported. Armenian, Georgian and Persian merchants carry on a lively trade in local wares.

STAWELL, SIR WILLIAM FOSTER (1815–1889), British colonial statesman, was the son of Jonas Stawell, of Old Court, in the county of Cork, and of Anna, daughter of the Right Rev. William Foster, bishop of Clogher. He was born on the 27th of June 1815, was educated at Trinity College, Dublin, studied law at King's Inn, Dublin, and Lincoln's Inn, and was called to the Irish bar in 1839. He practised in Ireland until 1842, and then, making his home in Australia, was admitted to the Melbourne bar in 1843. He engaged extensively in pastoral pursuits, and had sheep stations at Natte Yallock, on the banks of the river Avoca, and in the neighbourhood of Lake Wallace, near the South Australian border. For many years he enjoyed the leading practice at the local bar, and when the Port Phillip district of New South Wales was separated from the parent colony, and entered upon an independent existence as the colony of Victoria, Mr Stawell accepted the position of attorney-general and became a member of the executive and legislative councils. A few weeks after his appointment gold was discovered, and to Mr Stawell fell the arduous duties of creating a system of government which could cope adequately with the difficulties of the position. He had to establish a police force, frame regulations for the government of the goldfields, appoint magistrates and officials of every grade, and protect life and property against the attacks of the hordes of adventurers, many of desperate character, who landed in Victoria, first from the neighbouring colonies, and later from Europe and America. It was very much owing to the firm administration of Mr Stawell that, at a time when the government was weak and a large section of the newcomers impatient of control, lynch law was never resorted to. He had very little assistance for some time from any of his colleagues, and until the executive council was strengthened by the admission of Captain (afterwards Sir Andrew) Clarke and Mr H. C. E. Childers Mr Stawell was the brains as well as the body of the administration. The success of his policy was upon the whole remarkable. In the legislature he was sometimes opposed, and at other times assisted, by Mr (afterwards Sir John) O'Shanassy, who was the leader of the popular party, and between them they managed to pass a number of statutes which added greatly to the prosperity of the colony. Mr Stawell was indefatigable in the discharge of his duties, and extraordinary stories are told of the long journeys on horseback to visit distant outposts which he would take after being all day long in the law courts or in the council chamber. Mr Stawell bore an active part in drafting the Constitution Act which gave to Victoria representative institutions and a responsible ministry, instead of an executive appointed and removable by the governor and a legislature in which one-third of the members were chosen by the Crown. At the first general election after the new constitution in 1856 Mr Stawell was returned as one of the members for Melbourne, and became the attorney-general of the first responsible ministry. In 1857, on the resignation of the chief justice, Sir William A'Beckett, he succeeded to the vacant post, and was created a knight-bachelor. He administered the government of Victoria in 1873, 1875–1876, and 1884. Sir William never left Australia from his arrival in 1843 till 1872, when he paid short visits to the neighbouring colonies and New Zealand, and 1873, when he returned to Europe on two years' leave of absence. He took a very deep interest in the proceedings of the Church of England, and was a member of the synod. On his retirement from the bench in 1886 he was created K.C.M.G. He died at Naples in 1889. In 1856 he had married Mary Frances Elizabeth, only daughter of W. P. Greene, R.N. (G. C. L.)

STAWELL, a municipality of Borung county, Victoria, Australia, 179 m. by rail W.N.W. of Melbourne. Pop. (1901), 5296. The quartz reefs of the Pleasant Creek goldfields near the town are worked at very deep levels and there are several extensive cyanide plants on the reef. In the adjacent Grampians, which are connected by rail with Stawell, there are numerous freestone quarries. Wheat is extensively grown in the vicinity and also large numbers of vines, for which the soil is particularly adapted. Stawell is the changing station on the line from Melbourne to Adelaide, and has large engine-houses and repairing shops.

STAY BARS, in architecture, saddle bars passing through the mullions in one length across the whole window, and secured to the jambs on each side (see **SADDLE**).

STEAD, WILLIAM THOMAS (1849–), English journalist, was born at Embleton, Northumberland, on the 5th of July 1849, the son of a Congregational minister. He went to school at Wakefield, but was early apprenticed in a merchant's office at Newcastle-on-Tyne; he soon gravitated however, into journalism, and in 1871 became editor of the Darlington *Northern Echo*. In 1880 he went to London to be assistant editor of the *Pall Mall Gazette* under John Morley, and when the latter retired he became editor (1883–1889). Up to 1885 he had distinguished himself for his vigorous handling of public affairs, and his brilliant modernity in the presentation of news. He introduced the "interview," made a feature of the *Pall Mall* "extras" (see also **NEWSPAPERS: London**), and his enterprise and originality exercised a potent influence on contemporary journalism and politics. His enthusiasm, however, carried him too far when in 1885 he entered upon a crusade against vice by publishing a series of articles on the "Maiden Tribute of Modern Babylon." Though his action undoubtedly furthered the passing of the Criminal Law Amendment Act, it made his position on the paper impossible; and his imprisonment at Holloway for three months on a charge arising out of his crusade made his connexion with the whole subject a source of considerable prejudice. On leaving the *Pall Mall* he founded the monthly *Review of Reviews* (1890), and his abundant energy and facile pen found scope in many other directions in journalism of an advanced humanitarian type. He started cheap reprints (*Penny Poets and Prose Classics*, &c.), conducted a spiritualistic organ, called *Borderland* (1893–1897), in which he gave full play to his interest in psychical research; and became an enthusiastic supporter of the peace movement, and of many other movements, popular and unpopular, in which he impressed the public generally as an extreme visionary, though his practical energy was recognized by a considerable circle of admirers and pupils. At the time of the Boer War of 1899 he threw himself into the Boer cause and attacked the government with characteristic violence. Yet amid all his unpopularity, and all the suspicion and opposition engendered by his methods, his personality remained a forceful one both in public and private life. He was an early imperialist dreamer, whose influence on Cecil Rhodes in South Africa remained of primary importance; and many politicians and statesmen, who on most subjects were completely at variance with his ideas, nevertheless owed something to them. Mr Rhodes made him his confidant, and was inspired in his will by his suggestions; and Mr Stead was intended to be one of Mr Rhodes's executors, though his name was struck out after the Boer War (see his *Last Will and Testament of C. J. Rhodes*, 1902). The number of his publications gradually became very large, as he wrote with facility and sensational fervour on all sorts of subjects, from *The Truth about Russia* (1888) to *If Christ came to Chicago* (1893), and from *Mrs Booth* (1900) to *The Americanization of the World* (1902). In private life his keen sense of merit and kindly interest influenced many aspirants to journalism and literature.

STEAK, a thick slice or piece of meat cut for frying, broiling or stewing. The word is apparently derived from Icel. *steik*, used in the same sense, which meant properly roasted meat, from *steikja*, to roast, that is, placed on a stick or peg of wood before the fire, *stika*, stick, cf. Swed. *stek*; Dan. *steg*, roast meat. A

steak may be cut from any meat or fish, but the best-known is a "beef-steak," cut properly from the rump a "rump-steak," or part of the loin a "tenderloin." A "porter-house" steak is a choice cut of steak from the loin, so named apparently first in New York from a well-known "porter-house," an eating-house where chops, steaks, &c., and porter or stout were served, at which these steaks were a speciality. A steak grilled between two other steaks, which are not served after the cooking is finished, is also sometimes called a "porter-house" steak.

STEAM (O. Eng. *steam*, vapour, smoke, cf. Du. *stoom*; the origin is unknown), water-vapour. Dry steam is steam free from mechanically mixed water particles; wet steam, on the other hand, contains water particles in suspension. Saturated steam is steam in contact with liquid water at a temperature which is the boiling point of the water and condensing point of the steam; superheated steam is steam out of contact with water heated above this temperature. For theoretical considerations see VAPORIZATION, and for the most important application see STEAM ENGINE; also WATER.

STEAM ENGINE. 1. A steam engine is a machine for the conversion of heat into mechanical work, in which the working substance is water and water vapour. The working substance may be regarded from two points of view. Thermodynamically it is the vehicle by which heat is conveyed to and through the engine from the hot source (the furnace and boiler). Part of this heat suffers a transformation into work as it passes through, and the remainder is rejected, still in the form of heat. Mechanically the working substance is a medium capable of exerting pressure, which effects this transformation in doing work by means of the changes of volume which it undergoes in the operation of the machine. Regarded as a thermodynamic device, the function of the engine is to get as much work as possible from a given quantity of heat or, to go a step further back, from the combustion of a given quantity of fuel. Accordingly, a question of primary importance is what is called the *efficiency* of the engine, which is the ratio of the work done to the heat supplied. Before, however, proceeding to discuss the steam engine in this aspect, or treating of the mechanics of its modern forms, it may be useful to give a brief historical sketch of its early development as an industrial appliance. In any such sketch the chief share of attention must necessarily be given to the work of James Watt. But a process of evolution had been going on before the time of Watt which prepared the steam engine for the immense improvements it received at his hands. His labours stand in natural sequence to those of Thomas Newcomen, and Newcomen's to those of Denis Papin and Thomas Savery. Savery's engine in its turn was the reduction to practical form of a contrivance which had long before been known as a scientific toy. The most modern type of all, the steam turbine of C. A. Parsons, is a new departure which has but little to connect it directly with the past; but even the steam turbine not only profits by the inventions of Watt, but in its characteristic feature finds crude prototypes in apparatus which employed the kinetic energy of jets of steam.

2. One of these, indeed, is mentioned amongst the earliest notices we have of any heat engine. In the *Pneumatica* of Hero of Alexandria (c. 130 B.C.) there is described the aeolipile, which is a primitive steam reaction turbine, consisting of a spherical vessel pivoted on a central axis and supplied with steam through one of the pivots. The steam escapes by bent pipes facing tangentially in opposite directions, at opposite ends of a diameter perpendicular to the axis. The globe revolves by

reaction from the escaping steam just as a Barker's mill is driven by escaping water. Another apparatus described by Hero (fig. 1)¹ is interesting as the prototype of a class of engines which long afterwards became practically important. A hollow altar containing air is heated by a fire kindled on it; the air in expanding drives some of the water contained in a spherical vessel beneath the altar into a bucket, which descends and opens the temple doors above by pulling round a pair of vertical posts to which the doors are fixed. When the fire is extinguished the air cools, the water leaves the bucket, and the doors close. In another device a jet of water driven out by expanding air is turned to account as a fountain.

3. From the time of Hero to the 17th century there is no progress to record, though here and there we find evidence that appliances like those described by Hero were used for trivial purposes, such as organ-blowing and the turning of spits. The next distinct step was the publication in 1601 of a treatise on pneumatics by Giovanni Battista della Porta, in which he shows an apparatus similar to Hero's fountain, but with steam instead of air as the displacing fluid. Steam generated in a separate vessel passes into a closed chamber containing water, from which a pipe (open under the water) leads out. He also points out that the condensation of steam in the closed chamber may be used to produce a vacuum and suck up water from a lower level. In fact, his suggestions anticipate very fully the engine which a century later became in the hands of Savery the earliest commercially successful steam engine. In 1615 Solomon de Caus gives a plan of forcing up water by a steam fountain which differs from Della Porta's only in having one vessel serve both as boiler and as displacement-chamber, the hot water being itself raised.

4. Another line of invention was taken by Giovanni Branca (1629), who designed an engine shaped like a water-wheel, to be driven by the impact of a jet of steam on its vanes, and in its turn to drive other mechanism for various useful purposes. But Branca's suggestion was for the time unproductive, and we find the course of invention reverting to the line followed by Della Porta and De Caus.

5. The next contributor is one whose place is not easily assigned. To Edward Somerset, second marquis of Worcester, appears to be due the credit of proposing, if not making, the first useful steam engine. Its object was to raise water, and it worked probably like Della Porta's model, but with a pair of displacement-chambers, from each of which alternately water was forced by steam from an independent boiler, or perhaps by applying heat to the chamber itself, while the other vessel was allowed to refill. Lord Worcester's description of the engine in art. 68 of his *Century of Inventions* (1663) is obscure, and no drawings are extant. It is, therefore, difficult to say whether there were any distinctly novel features except the double action; in particular, it is not clear whether the suction of a vacuum was used to raise water as well as the direct pressure of steam.

6. The steam engine first became commercially successful in the hands of Thomas Savery,² who, in 1698, obtained a patent for a water-raising engine, shown in fig. 2. Steam is admitted to one of the oval vessels A, displacing water, which it drives up through the check-valve B. When the vessel A is emptied of water the supply of steam is stopped, and the steam already there is condensed by allowing a jet of cold water from a cistern above to stream over the outer surface of the vessel. This produces a vacuum and causes water to be sucked up through the pipe C and the valve D. Meanwhile steam has been displacing water

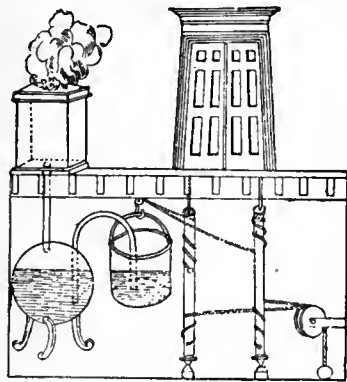

FIG. 1.—Hero's Apparatus, 130 B.C.

through one of the pivots. The steam escapes by bent pipes facing tangentially in opposite directions, at opposite ends of a diameter perpendicular to the axis. The globe revolves by

¹ From Greenwood's translation of Hero's *Pneumatica*.

² Savery was born probably in 1650 and died in 1715. See Sir E. Durning Lawrence's presidential address to the Royal Institution of Cornwall (*Journ. of the Roy. Inst. of Cornwall*, No. li.), republished with a reprint of Savery's *Miner's Friend* of 1702, in which he discusses the originality of Savery's invention and dismisses the claims put forward for Lord Worcester.

from the other vessel, and is ready to be condensed there. The valves B and D open only upwards. The supplementary boiler and furnace E are for feeding water to the main boiler; E is filled while cold and a fire is lighted under it; it then acts like the vessel of De Gaus in forcing a supply of feed-water into the main boiler F. The gauge cocks G, G are an interesting feature in detail. Another form of Savery's engine had only one displacement-chamber and worked intermittently. In the use of artificial means to condense the steam, and in the application of the vacuum so formed to raise water by suction from a level lower than that of the engine, Savery's engine

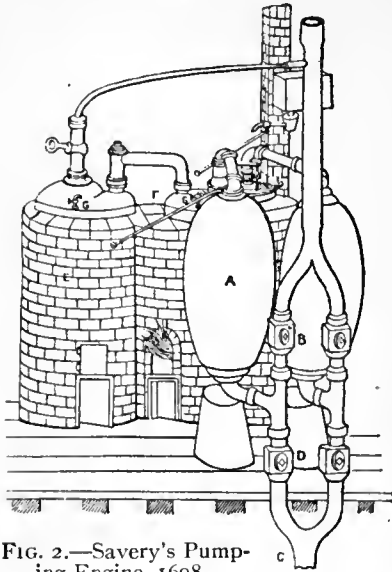

FIG. 2.—Savery's Pumping Engine, 1698.

was probably an improvement on Worcester's; in any case it found what Worcester's engine had failed to find—considerable employment in pumping mines and in raising water to supply houses and towns, and even to drive water-wheels. A serious difficulty which prevented its general use in mines was the fact that the height through which it would lift water was limited by the pressure the boiler and vessels could bear. Pressures as high as 8 or 10 atmospheres were employed—and that, too, without a safety-valve—but Savery found it no easy matter to deal with high-pressure steam; he complains that it melted his common solder, and forced him, as Desaguliers tells us, "to be at the pains and charge to have all his joints soldered with spelter." Apart from this drawback, the waste of fuel was enormous, from the condensation of steam which took place on the surface of the water and on the sides of the displacement-chamber at each stroke; the consumption of coal was, in proportion to the work done, some twenty times greater than in a good modern steam engine. In a tract called *The Miner's Friend* Savery alludes thus to the alternate heating and cooling of the water-vessel: "On the outside of the vessel you may see how the water goes out as well as if the vessel were transparent, for so far as the steam continues within the vessel so far is the vessel dry without and so very hot as scarce to endure the least touch of the hand. But as far as the water is, the said vessel will be cold and wet where any water has fallen on it; which cold and moisture vanishes as fast as the steam in its descent takes the place of the water." Before Savery's engine was entirely displaced by its successor, Newcomen's, it was improved by J. T. Desaguliers, who applied to it the safety valve (invented by Papin), and substituted condensation by a jet of cold water within the vessel for the surface condensation used by Savery. To Savery is ascribed the first use of the term "horse power" as a measure of the performance of an engine.

7. So early as 1678 the use of a piston and cylinder (long before known as applied to pumps) in a heat-engine had been suggested by Jean de Hautefeuille, who proposed to use the explosion of gun-powder either to raise a piston or to force up water, or to produce, by the subsequent cooling of the gases, a partial vacuum into which water might be sucked up. Two years later Christian Huygens described an engine in which the explosion of gun-powder in a cylinder expelled part of the gaseous contents, after which the cooling of the remainder caused a piston to descend under atmospheric pressure, and the piston in descending did work by raising a weight.

8. In 1690 Denis Papin, who ten years before had invented

the safety-valve as an adjunct to his "digerter," suggested that the condensation of steam should be employed to make a vacuum under a piston previously raised by the expansion of the steam. Papin's was the earliest cylinder and piston steam engine, and his plan of using steam was that which afterwards took practical shape in the atmospheric engine of Newcomen. But his scheme was made unworkable by the fact that he proposed to use but one vessel as both boiler and cylinder. A small quantity of water was placed at the bottom of a cylinder and heat was applied. When the piston had risen the fire was removed, the steam was allowed to cool, and the piston did work in its down-stroke under the pressure of the atmosphere. After hearing of Savery's engine in 1705 Papin turned his attention to improving it, and devised a modified form, shown in fig. 3, in which the displacement-

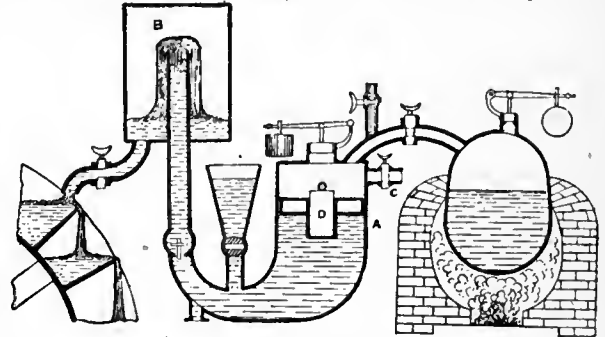

FIG. 3.—Papin, 1705.

chamber A was a cylinder, with a floating diaphragm or piston on the top of the water to keep the water and steam from direct contact with one another. The water was delivered into a closed air-vessel B, from which it issued in a continuous stream, against the vanes of a water-wheel. After the steam had done its work in the displacement-chamber it was allowed to escape by the stop-cock C instead of being condensed. Papin's engine was, in fact, a non-condensing single-acting steam pump, with steam cylinder and pump cylinder in one. A curious feature of it was the heater D, a hot mass of metal placed in the diaphragm for the purpose of keeping the steam dry. Among the many inventions of Papin was a boiler with an internal fire-box—the earliest example of a construction that is now almost universal.¹

9. While Papin was thus going back from his first notion of a piston engine to Savery's cruder type, a new inventor had appeared who made the piston engine a practical success by separating the boiler from the cylinder and by using (as Savery had done) artificial means to condense the steam. This was Thomas Newcomen, who in 1705, with his assistant, John Cawley,

Newcomen's Atmospheric Engine, 1705.

gave the steam engine the form shown in fig. 4. Steam admitted from the boiler to the cylinder allowed the piston to be raised by a heavy counterpoise on the other side of the beam. Then the steam valve was shut and a jet of cold water entered the cylinder and condensed the steam. The piston was consequently forced down by the pressure of the atmosphere and did work on the pump. The next entry of steam expelled the condensed water from the cylinder

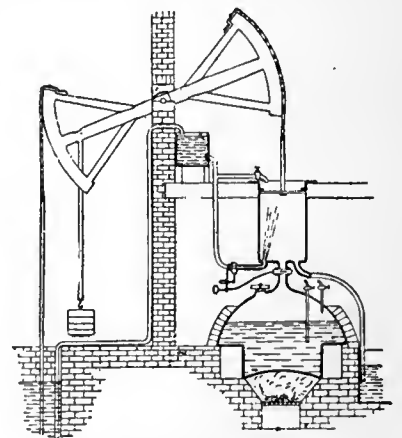

FIG. 4.—Newcomen's Atmospheric Engine, 1705.

¹ For an account of Papin's inventions see his *Life and Correspondence*, by Dr E. Gerland (Berlin, 1881).

through an escape valve. The piston was kept tight by a layer of water on its upper surface. Condensation was at first effected by cooling the outside of the cylinder, but the accidental leakage of the packing water past the piston showed the advantage of condensing by a jet of injection water, and this plan took the place of surface condensation. The engine used steam whose pressure was little if at all greater than that of the atmosphere; sometimes, indeed, it was worked with the manhole lid off the boiler.

10. About 1711 Newcomen's engine began to be introduced for pumping mines. It is doubtful whether the action was originally automatic, or depended on the periodical turning of taps by an attendant. The common story is that in 1713 a boy named Humphrey Potter, whose duty it was to open and shut the valves of an engine he attended, made the engine self-acting by causing the beam itself to open and close the valves by suitable cords and catches. This device was simplified in 1718 by Henry Beighton, who suspended from the beam a rod called the plug-tree, which worked the valves by means of tappets. By 1725 the engine was in common use in collieries, and it held its place without material change for about three-quarters of a century in all. Near the close of its career the atmospheric engine was much improved in its mechanical details by John Smeaton, who built many large engines of this type about the year 1770, just after the great step which was to make Newcomen's engine obsolete had been taken by James Watt.

Compared with Savery's engine, Newcomen's had (as a pumping engine) the great advantage that the intensity of pressure in the pumps was not in any way limited by the pressure of the steam. It shared with Savery's, in a scarcely less degree, the defect already pointed out, that steam was wasted by the alternate heating and cooling of the vessel into which it was led. Though obviously capable of more extended uses, it was in fact almost exclusively employed to raise water—in some instances for the purpose of turning water-wheels to drive other machinery. Even contemporary writers complain of its vast "consumption of fuel," which appears to have been scarcely smaller than that of the engine of Savery.

11. In 1763 James Watt, an instrument maker in Glasgow, while engaged by the university in repairing a model of Newcomen's engine, was struck with the waste of steam to which the alternate chilling and heating of the cylinder gave rise. He saw that the remedy, in his own words, would lie in keeping the cylinder as hot as the steam that entered it. With this view he added to the engine a new organ—an empty vessel separate from the cylinder, into which the steam should be allowed to escape from the cylinder, to be condensed there by the application of cold water either outside or as a jet. To preserve the vacuum in his condenser he added

a pump called the air-pump, whose function was to pump from it the condensed steam and water of condensation, as well as the air which would otherwise accumulate by leakage or by being brought in with the steam or with the injection water. Then, as the cylinder was no longer used as a condenser, he was able to keep it hot by clothing it with non-conducting bodies, and in particular by the use of a *steam jacket*, or layer of hot steam between the cylinder and an external casing. Further, and still with the same object, he covered in the top of the cylinder, taking the piston-rod out through a steam-tight stuffing-box, and allowed steam instead of air to press upon the piston's upper surface. The idea of using a separate condenser had no sooner occurred to Watt than he put it to the test by constructing the apparatus shown in fig. 5. There A is the cylinder, B a surface condenser, and C the air-pump. The cylinder was filled with steam above the piston, and a vacuum was formed in the surface condenser B.

On opening the stop-cock D the steam rushed over from the cylinder and was condensed, while the piston rose and lifted a weight. After several trials Watt patented his improvements in 1769; they are described in his specification in the following words, which, apart from their immense historical interest, deserve careful study as a statement of principles which to this day guide the scientific development of the steam engine:—

"My method of lessening the consumption of steam, and consequently fuel, in fire-engines, consists of the following principles:—

"*First*, That vessel in which the powers of steam are to be employed to work the engine, which is called the cylinder in common fire-engines, and which I call the steam-vessel, must, during the whole time the engine is at work, be kept as hot as the steam that enters it; first by enclosing it in a case of wood, or any other materials that transmit heat slowly; secondly, by surrounding it with steam or other heated bodies; and, thirdly, by suffering neither water nor any other substance colder than the steam to enter or touch it during that time.

"*Secondly*, In engines that are to be worked wholly or partially by condensation of steam, the steam is to be condensed in vessels distinct from the steam-vessels or cylinders, although occasionally communicating with them; these vessels I call condensers; and, whilst the engines are working, these condensers ought at least to be kept as cold as the air in the neighbourhood of the engines, by application of water or other cold bodies.

"*Thirdly*, Whatever air or other elastic vapour is not condensed by the cold of the condenser, and may impede the working of the engine, is to be drawn out of the steam-vessels or condensers by means of pumps, wrought by the engines themselves, or otherwise.

"*Fourthly*, I intend in many cases to employ the expansive force of steam to press on the pistons, or whatever may be used instead of them, in the same manner in which the pressure of the atmosphere is now employed in common fire-engines. In cases where cold water cannot be had in plenty, the engines may be wrought by this force of steam only, by discharging the steam into the air after it has done its office.

"*Sixthly*, I intend in some cases to apply a degree of cold not capable of reducing the steam to water, but of contracting it considerably, so that the engines shall be worked by the alternate expansion and contraction of the steam.

"*Lastly*, Instead of using water to render the pistons and other parts of the engine air and steam tight, I employ oils, wax, resinous bodies, fat of animals, quicksilver and other metals in their fluid state."

The fifth claim was for a rotary engine, and need not be quoted here.

The "common fire engine" alluded to was the steam engine, or, as it was more generally called, the "atmospheric" engine of Newcomen. Enormously important as Watt's first patent was, it resulted for a time in the production of nothing more than a greatly improved engine of the Newcomen type, much less wasteful of fuel, able to make faster strokes, but still only suitable for pumping, still single-acting, with steam admitted during the whole stroke, the piston, as before, pulling the beam by a chain working on a circular arc. The condenser was generally worked by injection, but Watt has left a model of a surface condenser made up of small tubes, in every essential respect like the condensers now used in marine engines.¹

12. Fig. 6 is an example of the Watt pumping engine of this period. It should be noticed that, although the top of the cylinder is closed and steam has access to the upper side of the piston, this is done only to keep the cylinder and piston warm. The engine is still single-acting; the steam in the upper side merely plays the part which was played in Newcomen's engine by the atmosphere; and it is the lower end of the cylinder alone that is ever put in communication with the condenser. There are three valves: the "steam" valve *a*, the "equilibrium" valve *b*, and the "exhaust" valve *c*. At the beginning of the down-stroke *c* is opened to produce a vacuum below the piston and *a* is opened to admit steam above it. At the end of the down-stroke *a* and *c* are shut and *b* is opened. This puts the two sides in equilibrium and allows the piston to be pulled up by the pump-rod *P*, which is heavy enough to serve as a counterpoise. *C* is the condenser, and *A* the air-pump, which discharges into the hot well *H*, whence the supply of the feed-pump *F* is drawn.

13. In a second patent (1781) Watt describes the "sun-and-planet" wheels and other methods of making the engine give

¹ An interesting detailed narrative of the steps leading to his invention was written by Watt as a note to the article "Steam Engine" in Robison's *System of Mechanical Philosophy* (1822). See Ewing, *The Steam Engine and other Heat Engines*, pp. 15-19.

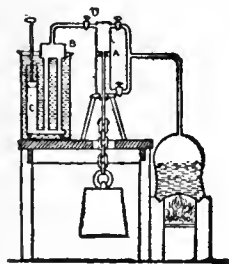

FIG. 5.—Watt's Experimental Apparatus.

Watt's
Pumping
Engine,
1769.

continuous revolving motion to a shaft provided with a flywheel. He had invented the crank and connecting-rod for this purpose, but it had meanwhile been patented by one Pickard, and Watt, rather than make terms with Pickard, whom he regarded as a plagiarist of his own ideas, made use of his sun-and-planet motion until the patent on the crank expired. The reciprocating motion of earlier forms had served only for pumping; by this invention Watt opened up for the steam engine a thousand other channels of

Rotative Engine.

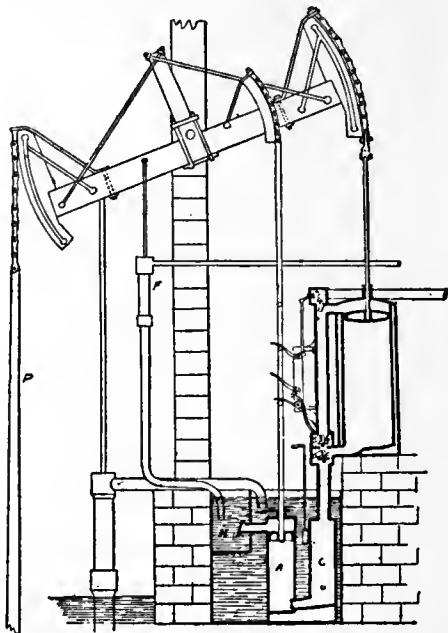

FIG. 6.—Watt's Single-Acting Engine, 1769.

usefulness. The engine was still single-acting; the connecting-rod was attached to the far end of the beam, and that carried a counterpoise which served to raise the piston when steam was admitted below it.

14. In 1782 Watt patented two further improvements of the first importance, both of which he had invented some years before. One was the use of double action, that is *Other Inventions of Watt.* each side of the piston alternately. The other (invented as early as 1769) was the use of steam expansively, in other words the plan (now used in all engines that aim at economy of fuel) of stopping

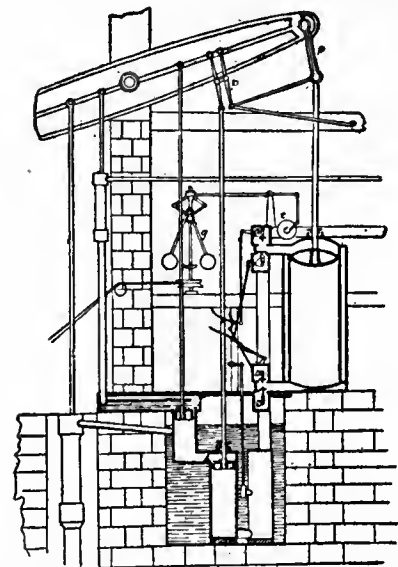

FIG. 7.—Watt's Double-Acting Engine, 1782.

when the piston had made only a part of its stroke, and allowing the rest of the stroke to be performed by the expansion of the steam already in the cylinder. To let the piston push as well as pull the end of the beam Watt devised his so-called parallel motion, an arrangement of links connecting the piston-rod head with the beam in such a way as to guide the rod to move in a very nearly straight line. He further added the throttle valve, for regulating the rate of admission of steam, and the centrifugal governor, a double conical pendulum, which controlled the speed by acting on

the throttle-valve. The stage of development reached at this time is illustrated by the engine of fig. 7 (from Stuart's *History of the Steam Engine*), which shows the parallel motion *pp*, the governor *g*, the throttle-valve *t*, and a pair of steam and exhaust valves at each end of the cylinder. Among other inventions of Watt were the "indicator," by which diagrams showing the relation of the steam pressure in the cylinder to the movement of the piston are automatically drawn; a steam tilt-hammer; and also a steam locomotive for ordinary roads—but this invention was not prosecuted.

In partnership with Matthew Boulton, Watt carried on in Birmingham the manufacture and sale of his engines with the utmost success, and held the field against all rivals in spite of severe assaults on the validity of his patents. Notwithstanding his accurate knowledge of the advantage to be gained by using steam expansively, he continued to employ only low pressures—seldom more than 7 lb per sq. in. over that of the atmosphere. His boilers were fed, as Newcomen's had been, through an open pipe which rose high enough to let the column of water in it balance the pressure of the steam. He gave a definite numerical significance to the term "horse-power" (*q.v.*) as a mode of rating engines, defining it as the rate at which work is done when 33,000 lb are raised one foot in one minute.

15. In the fourth claim in Watt's first patent the second sentence describes a non-condensing engine, which would have required steam of a higher pressure. This, how- *Non-condensing Engine.*

ever, was a line of invention which Watt did not follow up, perhaps because so early as 1725 a non-condensing engine had been described by Jacob Leupold in his *Theatrum machinarum*. Leupold's proposed engine is shown in fig. 8, which makes its action sufficiently clear.

Watt's aversion to high-pressure steam was strong, and its influence on steam engine practice long survived the expiry of his patents. So much indeed was this the case that the terms "high-pressure" and "non-condensing" were for many years synonymous in contradistinction to the "low-pressure" or condensing engines of Watt. This nomenclature no longer holds; in modern practice many condensing engines use as high pressures as non-condensing engines, and by doing so are able to take advantage

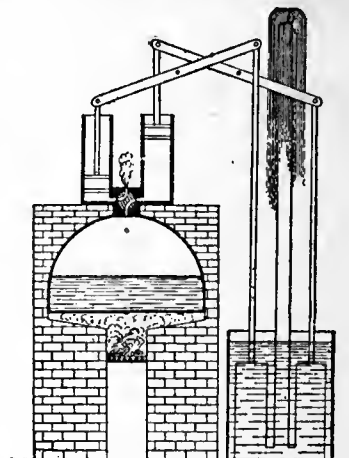

FIG. 8.—Leupold's Non-Condensing Engine, 1725.

of Watt's great invention of expansive working to a degree which was impossible in his own practice.

16. The introduction of the non-condensing and, at that time, relatively high-pressure engine was effected in England by Richard Trevithick and in America by Oliver *High-pressure Steam.* Evans about 1800. Both Evans and Trevithick applied their engines to propel carriages on roads, and both used for boiler a cylindrical vessel with a cylindrical flue inside—the construction now known as the Cornish boiler. In partnership with William Bull, Trevithick had previously made direct acting pumping-engines, with an inverted cylinder set over and in line with the pump-rod, thus dispensing with the beam that had been a feature in all earlier forms. But in these "Bull" engines, as they were called, a condenser was used, or, rather, the steam was condensed by a jet of cold water in the exhaust-pipe, and Boulton and Watt successfully opposed them as infringing Watt's patents. To Trevithick belongs the distinguished honour of being the first to use a steam carriage on a railway; in 1804 he built a locomotive in the modern sense, to run on what had formerly been a horse-tramway, in Wales, and it is noteworthy that the

exhaust steam was discharged into the funnel to force the furnace draught, a device which, twenty-five years later, in the hands of George Stephenson, went far to make the locomotive what it is to-day. In this connexion it may be added that as early as 1769 a steam carriage for roads had been built in France by Nicolas Joseph Cugnot, who used a pair of single-acting high-pressure cylinders to turn a driving axle step by step by means of pawls and ratchet-wheels. To the initiative of Evans may be ascribed the early general use of high-pressure steam in the United States, a feature which for many years distinguished American from English practice.

17. Amongst the contemporaries of Watt one name deserves special mention. In 1781 Jonathan Carter Hornblower constructed and patented what would now be called a compound engine, with two cylinders of different sizes. Steam was first admitted into the smaller cylinder, and then passed over into the larger, doing work against a piston in each. In Hornblower's engine the two cylinders were placed side by side, and both pistons worked on the same end of a beam overhead. This was an instance of the use of steam expansively, and as such was earlier than the patent, though not earlier than the invention, of expansive working by Watt. Hornblower was crushed by the Birmingham firm for infringing their patent in the use of a separate condenser and air-pump. The compound engine was revived in 1804 by Arthur Woolf, with whose name it is often associated. Using steam of fairly high pressure, and cutting off the supply before the end of the stroke in the small cylinder, Woolf expanded the steam to several times its original volume. Mechanically the double-cylinder compound engine has this advantage over an engine in which the same amount of expansion is performed in a single cylinder, that the sum of the forces exerted by the two pistons in the compound engine varies less throughout the action than the force exerted by the piston of the single-cylinder engine. This advantage may have been clear to Hornblower and Woolf and to other early users of compound expansion. But another and probably a more important merit of the system lies in a fact of which neither they nor for many years their followers in the use of compound engines were aware—the fact that by dividing the whole range of expansion into two parts the cylinders in which these are separately performed are subject to a reduced range of fluctuation in their temperature. This, as will be seen later, limits to a great extent a source of waste which is present in all steam engines, the waste which results from the heating and cooling of the metal by its alternate contact with hot and cooler steam. The system of compound expansion is now used in nearly all large engines that pretend to economy. Its introduction forms the most outstanding improvement which steam engines of the piston and cylinder type have undergone since the time of Watt; and we are able to recognize it as a very important step in the direction set forth in his "first principle" that the cylinder should be kept as hot as the steam that enters it.

18. Woolf introduced the compound engine somewhat widely about 1814 as a pumping engine in the mines of Cornwall.

But here it met a strong competitor in the high-pressure single-cylinder engine of Trevithick, which had the advantage of greater simplicity in construction. Woolf's engine fell into comparative disuse, and the single-cylinder type took a form which, under the name of the Cornish pumping engine, was for many years famous for its great economy of fuel. In this engine the cylinder was set under one end of a beam, from the other end of which hung a heavy rod which operated a pump at the foot of the shaft. Steam was admitted above the piston for a short portion of the stroke, thereby raising the pump-rod, and was allowed to expand for the remainder. Then an equilibrium valve, connecting the space above and below the piston, as in fig. 6, was opened, and the pump-rod descended, doing work in the pump and raising the engine piston. The large mass which had to be started and stopped at each stroke served by its inertia to counter-balance the unequal pressure of the steam, for the ascending

rods stored up energy of motion in the early part of the stroke, when the steam pressure was greatest, and gave out energy in the later part, when expansion had greatly lowered the pressure. The frequency of the stroke was controlled by a device called a cataract, consisting of a small plunger pump, in which the plunger, raised at each stroke by the engine, was allowed to descend more or less slowly by the escape of fluid below it through an adjustable orifice, and in its descent liberated catches which held the steam and exhaust valves from opening. A similar device controlled the equilibrium valve, and could be set to give a pause at the end of the piston's down-stroke, so that the pump-cylinder might have time to become completely filled. The Cornish engine is interesting as the earliest form which achieved an efficiency comparable with that of good modern engines. For many years monthly reports were published of the "duty" of these engines, the "duty" being the number of foot-pounds of work done per bushel or (in some cases) per cwt. of coal. The average duty of engines in the Cornwall district rose from about 18 millions of foot-pounds per cwt. of coal in 1813 to 68 millions in 1844, after which less effort seems to have been made to maintain a high efficiency (*Proc. Inst. C.E.*, 1863, vol. 23). In individual cases much higher results were reported, as in the Fowey Consols engine, which in 1835 was stated to have a duty of 125 millions. This (to use a more modern mode of reckoning) is equivalent to the consumption of only a little more than $1\frac{3}{4}$ lb of coal per horse-power per hour—a result surpassed by very few engines in even the best recent practice. It is difficult to credit figures which, even in exceptional instances, place the Cornish engine of that period on a level with the most efficient modern engines—in which compound expansion and higher pressure combine to make a much more perfect thermodynamic machine; and apart from this there is room to question the accuracy of the Cornish reports. They played, however, a useful part in the process of steam engine development by directing attention to the question of efficiency, and by demonstrating the advantage to be gained by high pressure and expansive working, at a time when the theory of the steam engine had not yet taken shape.

19. The final revival of the compound engine did not occur until about the middle of the 19th century, and then several agencies combined to effect it. In 1845 M'Naught introduced a plan of improving beam engines of the original Watt type, by adding a high-pressure cylinder whose piston acted on the beam between the centre and the flywheel end. Steam of higher pressure than had formerly been used, after doing work in the new cylinder, passed into the old or low-pressure cylinder, where it was further expanded. Many engines whose power was proving insufficient for the extended machinery they had to drive were "M'Naughted" in this way, and after conversion were found not only to yield more power but to show a marked economy of fuel. The compound form was selected by William Polc for the pumping engines of Lambeth and other waterworks about 1850; in 1854 John Elder began to use it in marine engines; in 1857 E. A. Cowper added a steam-jacketed intermediate reservoir for steam between the high and low pressure cylinders, which made it unnecessary for the low-pressure piston to be just beginning when the other piston was just ending its stroke. As facilities increased for the use of high-pressure steam, compound expansion came into more general use, its advantage becoming more conspicuous with every increase in boiler pressure—until now there are few large land engines and scarcely any marine engines that do not employ it. In marine practice, where economy of fuel is a much more important factor in determining the design than it is on land, the principle of compound expansion has been greatly extended by the introduction of triple and even quadruple expansion engines, in which the steam is made to expand successively in three or in four cylinders. In locomotive engines, where other considerations are of more moment than the saving of coal, compound expansion has found some application, but its use there is comparatively rare.

20. The adaptation of the steam engine to railways, begun by Trevithick, became a success in the hands of George Stephenson, whose engine, the "Rocket," when tried along with others, in 1829, not only distanced its competitors but settled once and for all the question whether horse traction or steam traction was to be used on railways. The principal features of the "Rocket" were an improved steam-blast for urging the combustion of coal and a boiler (suggested by Booth) in which a large heating surface was given by the use of many small tubes through which the hot gases passed. Further, the cylinders, instead of being vertical as in earlier locomotives, were set in at a slope, which was afterwards altered to a position more nearly horizontal. To these features there was added later the "link motion," a contrivance which enabled the engine to be easily reversed and the amount of expansion to be readily varied. In the hands of George Stephenson and his son Robert the locomotive took a form which has been in all essentials maintained by the far heavier locomotives of to-day.

21. The first practical steamboat was the tug "Charlotte Dundas," built by William Symington, and tried in the Forth and Clyde Canal in 1802. A Watt double-acting condensing engine, placed horizontally, acted directly by a connecting-rod on the crank of a shaft at the stern, which carried a revolving paddle-wheel. The trial was successful, but steam towing was abandoned for fear of injuring the banks of the canal. Ten years later Henry Bell built the "Comet," with side paddle-wheels, which ran as a passenger steamer on the Clyde; but an earlier inventor to follow up Symington's success was the American, Robert Fulton, who, after unsuccessful experiments on the Seine, fitted a steamer on the Hudson in 1807 with engines made to his designs by Boulton and Watt, and brought steam navigation for the first time to commercial success.

22. With improvements in the details of design and construction it gradually became practicable to use higher steam pressures and higher piston speeds, and consequently to obtain not only greater efficiency, but also a greater amount of power from engines of given bulk. In 1872 Sir F. J. Bramwell, describing the typical marine practice of that time, gave a list of engines, all compound, in which the boiler pressure ranged from 45 to 60 lb, the mean piston speed was 350 ft. per minute, and the consumption of coal 2 to 2½ lb per hour per indicated horse-power. In 1881 F. C. Marshall gave a similar list, in which the boiler pressure was 77 lb, the speed 460 ft. per minute, and the consumption a trifle under 2 lb. These were compound engines with expansion in two stages. The triple expansion engine, introduced by Dr A. C. Kirk in 1874, did not come into general use until after 1881. It became the normal type of marine engine, with pressures ranging, as a rule, from 150 to 200 lb, piston speeds generally of 500 or 600 ft. per minute, but sometimes as high as 900 or 1000, and coal consumption of about 1½ lb per hour per indicated horse-power. In some instances quadruple expansion has been preferred, with somewhat higher pressures, but it can scarcely be said to be established that the advantage of adding a fourth stage clearly compensates for the extra complication. Some particulars of the dimensions reached in modern practice will be given later. Several of the vessels engaged in the Transatlantic passenger service, and also a few armoured cruisers, have engines in which the twin sets together have an indicated horse-power exceeding 30,000. But even these figures are eclipsed in ships which are driven by turbine engines. The cruisers of the "Invincible" class have turbine engines of 41,000 horse-power, and the turbines of the great Cunarders "Lusitania" and "Mauretania" (1907) develop about 70,000 h.p. in propelling these ships at a speed of 25 knots. It may be questioned whether such gigantic concentrations of power for the propulsion of a ship would have been practicable had it not

been for the new possibilities which the introduction of the steam turbine has opened up.

23. The invention of the steam turbine has in fact revolutionized marine engine practice, so far as fast vessels are concerned, and has supplied a formidable rival to the reciprocating engine for use on land. The steam turbine has been brought to a degree of efficiency which places it, in respect of economy in steam and coal consumption, on a somewhat higher level than the best engines of the older type in cases where a large amount of power is to be generated. Its greater simplicity, compactness and freedom from vibration are merits which have already gone far to secure for it a preference, notwithstanding the short time that has passed since it became known as a practicable engine. The largest demands for power occur in fast passenger vessels, in war-ships and in stations from which electric energy is distributed for traction or other uses; in all these cases the steam turbine is now taking the leading place. It is to the inventive genius of the Hon. C. A. Parsons that we owe not only the main idea of the modern steam turbine, but also the working out of many novel mechanical details which have been essential to success, as well as the adaptation of the turbine to marine propulsion.

24. In the steam turbine, as in the water turbine (for which see HYDRAULICS), the force directly operative to do useful work is derived from the kinetic energy of the operative fluid, either by the impulse of a jet or jets sliding over movable blades, or by the reaction of orifices or guides from which the jets issue. The pressure, instead of being exerted on a piston, is employed in the first instance to set the fluid itself in motion. There is a conversion of pressure-energy into velocity-energy as a preliminary step towards obtaining the effective work of the machine. But in a steam turbine this implies velocities which are immensely greater than those with which water turbines have to deal, in consequence of the much smaller density of steam as the moving fluid. Attempts to design a steam turbine were made by numerous inventors, but fell short of practical success mainly because of the difficulty of arranging for a sufficiently high velocity in the working parts to utilize a reasonably large fraction of the kinetic energy of the steam, the principle involved being that for good efficiency the velocity of the blades should approximate to half the velocity of the jets which strike them. There is a further difficulty in getting the energy of the steam into a suitable kinetic form, namely, to get the stream of issuing particles to take a single direction, without undue dispersion, when steam is allowed to expand through an orifice from a chamber at high pressure into a space where the pressure is greatly less.

In 1889 Dr Gustaf de Laval introduced a form of steam turbine in which both of these difficulties were to a great extent overcome, partly by the special form of the nozzle used to produce the steam jet and partly by features of design which allowed an exceptionally high speed to be reached in the wheel carrying the vanes against which the steam impinged. This simple type of turbine, which will be described in a later section of this article, has met with considerable success, especially in comparatively small sizes, as an engine for driving electric generators. Its efficiency is fairly good, but it is not well adapted for work on a large scale, and it has not been applied to the propulsion of ships.

Parsons attacked the problem at an earlier date, in an entirely different way in the invention of his "compound" turbine. By dividing the whole expansion of the steam into a great number of successive and separate steps he limited the velocity acquired at each step to such an extent as to make it comparatively easy to extract the greater part of the kinetic energy, as work done upon the moving blades, without making the velocity of these blades inconveniently high. Moreover, in Parsons's compound turbine the range of pressure through which the steam expands in each separate step is too small to give rise to any difficulty in the formation of the jets. The guide blades, which form the jets, are distributed round the whole

circumference of the revolving wheel, and all the revolving blades are consequently in action at once. The steam streams from end to end through an annular space between a revolving drum and the casing which surrounds it. Parallel rings of fixed guide blades project inwards from the casing at suitable distances, and between these are rings of moving blades which project outwards from the drum and revolve with it. At each step in the expansion the steam streams through a ring of fixed guide blades, and the streams so formed impinge on the next ring of moving blades, and so on. The construction, which is of great simplicity, will be described later; it lends itself well to the generation of power on a large scale, especially in cases where a fairly high speed of rotation is wanted. The more powerful the turbine the less important do various inevitable sources of loss become; and hence, though the small turbines which were first built were less economical than reciprocating engines, the advantage is the other way where large powers are concerned.

25. Parsons introduced his compound steam turbine in 1884. For some years it was made in small sizes only, and the steam was discharged to the atmosphere without condensation. So long, however, as this was done the steam turbine was sacrificing one of its most important advantages, namely, its exceptional capacity for utilizing the energy of low-pressure steam down to the lowest vacuum obtainable in a condenser. In 1891 it was first fitted with a condenser, and it then began to be used in electric supply stations. Its efficiency at that date was found, in tests made by the present writer, to be comparable with that of good reciprocating compound engines, but the figures then obtained were much improved on later in turbines of larger size and modified design. The first application to marine propulsion was in the "Turbinia," in 1897. The success of this little experimental vessel of 100 tons, which with its horse-power of 2100 made a record in speed for a ship of any size, was soon followed by the application of the turbine to various war-ships and other steamers. In war-ships the use of steam turbines has a special advantage in enabling the machinery to be kept at a low level, beneath the protective deck, in addition to the general advantages of reduced bulk, reduced vibration, reduced liability to break-down, and reduced consumption of coal and of oil which are common to vessels of all classes. The successful trials of the cruiser "Amethyst" in 1904 demonstrated these advantages so conclusively that all new war-ships for the British navy, from battleships to torpedo-boats are being fitted with steam turbines. It is also used in many cross-channel packets, as well as in the largest ocean-going passenger vessels. The turbine-driven steamers "Lusitania" and "Mauretania" (1907) are the most powerful and the fastest ocean-going vessels afloat. The rapid development of the marine steam turbine makes it probable that it will displace the reciprocating engine in all large and fast ships. For slow-going cargo-boats it is at a disadvantage, unless gearing is resorted to, on account of the difficulty of securing a sufficiently high peripheral velocity in the turbine drums without making the turbines unduly bulky, and the leakage losses (due to steam passing through the clearance spaces over the tips of the blades) unduly large. Experiments by Parsons (*Trans. Inst. Nav. Arch.*, 1910) on a ship in which a slow-running propeller is driven through reducing-gear from a high-speed turbine, have given highly promising results.

Enough has been said to show that the invention of the steam turbine is the most important step in steam engineering since the time of Watt. It is the first solution of the problem of using steam efficiently in an engine without reciprocating parts. The object in most steam engines is to deliver power to revolving machinery, and much ingenuity has been expended in attempts to devise engines which will produce rotation directly, instead of by conversion of reciprocating motion. No rotary engine, however, was permanently successful until the steam turbine took a practical form.

26. In the early development of the steam engine inventors had little in the way of theory to guide them. Watt had the advantage, which he acknowledges, of a knowledge of Joseph

Black's doctrine of latent heat; but there was no philosophy of the relation of work to heat until long after the inventions of Watt were complete. The theory of the steam *Theory of Steam Engine.* engine as a heat engine dates from 1824, when N. L. Sadi Carnot published his *Réflexions sur la puissance motrice du feu*, and showed that heat does work only by being let down from a higher to a lower temperature. But Carnot had no idea that any of the heat disappears in the process, and it was not until the doctrine of the conservation of energy was established in 1843 by the experiments of J. P. Joule that the theory of heat engines began a vigorous growth. From 1849 onwards the science of thermodynamics was developed with extraordinary rapidity by R. J. M. Clausius, W. J. Macquorn Rankine and William Thomson (Lord Kelvin) and was applied, especially by Rankine, to practical problems in the use of steam. The publication in 1859 of Rankine's *Manual of the Steam Engine* formed an epoch in the history of the subject by giving inventors a new basis, outside of mere empiricism, from which they could push on the development of the steam engine. Unfortunately, however, it was assumed that the cylinder and piston might be treated as behaving to the steam like non-conducting bodies—that the transfer of heat between the steam and the metal was negligibly small. Rankine's calculations of steam consumption, work and thermodynamic efficiency involve this assumption, except in the case of steam-jacketed cylinders, where he estimates that the steam in its passage through the cylinder takes just enough heat from the jacket to prevent a small amount of condensation which would otherwise occur as the process of expansion goes on. If the transfer of heat from steam to metal could be overlooked, the steam which enters the cylinder would remain during admission as dry as it was before it entered, and the volume of steam consumed per stroke would correspond with the volume of the cylinder up to the point of cut-off. It is here that the actual behaviour of steam in the cylinder diverges most widely from the behaviour which the theory assumes. When steam enters the cylinder it finds the metal chilled by the previous exhaust, and a portion of it is at once condensed. This has the effect of increasing, often very largely, the volume of boiler steam required per stroke. As expansion goes on the water that was condensed during admission begins to be re-evaporated from the sides of the cylinder, and this action is often prolonged into the exhaust. It is now recognized that any theory which fails to take account of these exchanges of heat between the steam and its metal envelope fails also to yield even comparatively correct results in calculating the relative efficiency of various steam pressures or various ranges of expansion. But the exchanges of heat are so complex that there seems little prospect of submitting them to any comprehensive theoretical treatment, and information is rather to be sought from the scientific analysis of experiments with actual machines.

27. *Formation of Steam under Constant Pressure.*—In attempting a brief sketch of steam engine theory it is necessary to begin by giving some account of the properties of steam, so far as they are relevant. The properties of steam are most conveniently stated by referring in the first instance to what happens when steam is formed *under constant pressure*. This is substantially the process which occurs in the boiler of a steam engine when the engine is at work. To fix the ideas we may suppose that the vessel in which steam is to be formed is a long upright cylinder fitted with a piston which may be loaded so that it exerts a constant pressure on the fluid below. Let there be, to begin with, at the foot of the cylinder a quantity of water (which for convenience of numerical statement we shall take as 1 lb), at any temperature t_0 ; and let the piston press on the surface of the water with a force of p lb per square foot. Let heat now be applied to the bottom of the cylinder. As it enters the water it will produce the following effects in three stages:—

1. The temperature of the water rises until a certain temperature t is reached, at which steam begins to be formed. The value of t depends on the particular pressure p which the piston exerts. Until the temperature t is reached there is nothing but water below the piston.

2. Steam is formed, more heat being taken in. The piston (which is supposed to exert a constant pressure) rises. No further increase of temperature occurs during this stage, which continues until all the water is converted into steam. During this stage the steam

which is formed is said to be *saturated*. The volume which the piston encloses at the end of this stage—the volume, namely, of 1 lb of saturated steam at pressure p (and temperature t)—will be denoted by v in cubic feet.

3. If after all the water is converted into steam more heat be allowed to enter, the volume will increase and the temperature will rise. The steam is then said to be *superheated*.

The difference between saturated and superheated steam may be expressed by saying that if water (at the temperature of the steam) be mixed with steam some of the water will be evaporated if the steam is superheated, but none if the steam is saturated. Any vapour in contact with its liquid and in thermal equilibrium is necessarily saturated. When saturated its properties differ considerably, as a rule, from those of a perfect gas, especially at high pressures, but when superheated they approach those of a perfect gas more and more closely the further the process of superheating is carried, that is to say, the more the temperature is raised above t , the temperature of saturation corresponding to the given pressure p .

28. *Relation of Pressure and Temperature in Saturated Steam.*—The temperature t at which steam is formed depends on the value of p . Their relation was determined with great care by Regnault (*Mem. Inst. France*, vol. xxi.). The pressure of saturated steam rises with the temperature at a rate which increases rapidly in the upper regions of the scale. This will be apparent from the first and second columns of the following table. The first column gives the temperature on the Centigrade scale; the second gives the corresponding pressure in pounds per square inch.

29. *Relation of Volume and Temperature.*—The same table shows the volume v in cubic feet occupied by 1 lb of saturated steam at each temperature. This is based on the investigations of H. L. Callendar who has shown (see THERMODYNAMICS and VAPORIZATION) that an equation of the form

$$v = \frac{R\tau}{p} + b - c$$

is applicable to water vapour, whether saturated or superheated, within the limits of experimental error throughout the range of pressure that is important in engineering practice. In this equation τ is the absolute temperature, R and b are constants and c is a term varying inversely as a certain power of the temperature. By aid of this equation, in conjunction with the results of various experiments on the latent heat and other properties of steam, Callendar has shown that it is possible to frame expressions from which numerical values of all the important properties of steam may be derived throughout a range of saturation temperatures extending from 0° C. to 200° C. or so. The values so obtained are thermodynamically consistent with one another, and are in good agreement with the most authoritative experimental results. They are accordingly to be accepted in lieu of those given in earlier steam tables which depended on measurements by Regnault, and are now known to be in some particulars erroneous. R. Mollier has applied Callendar's method with great completeness to the calculation of steam tables, and the figures given here are adapted from his results.¹ In addition to the relation of temperature, pressure and volume, the table shows other properties of steam which will be explained as we proceed.

30. *Supply of Heat in Formation of Steam under Constant Pressure.*—We have next to consider the supply of heat in the imaginary experiment of § 27. During the first stage, until the temperature rises from its initial value t_0 to t , the temperature at which steam begins to form under the given pressure, heat is required only to warm the water. Since the specific heat of water is nearly constant, the amount of heat taken in during the first stage is approximately $t - t_0$ thermal units, or $J(t - t_0)$ foot-pounds, J being Joule's equivalent, and this expression for it will generally serve with sufficient accuracy in practical calculations. More exactly, however, the heat taken in is somewhat greater than this at high temperatures, for Regnault's experiments show that the specific heat of water increases slightly as the temperature rises. In stating the amount of heat required for this first stage, t_0 must be taken as a known temperature; for convenience in numerical statement the temperature 0° C. is usually chosen as an arbitrary starting-point from which the reception of heat is to be reckoned. We shall employ the symbol h to designate the heat required to raise 1 lb of water from 0° C. to the temperature t at which steam begins to form. During the first stage, sensibly all the heat supplied goes to increase the stock of internal energy which the fluid possesses, the amount of external work which is done by the expansion of the fluid being negligible.

The heat taken in during the second stage is what is called the *latent heat* of steam, and is denoted by L . Of it a part is spent in doing external work, namely, p multiplied by the excess of the volume of the steam v over the volume of the water w , and the remainder is the difference of internal energy between 1 lb of steam at t and 1 lb of water at t .

31. *Total Heat of Steam.*—Adding together the heat taken in during the first and second stages, we have a quantity designated

by H which may be called the heat of formation of 1 lb of saturated steam:—

$$H = h + L.$$

The heat of formation of 1 lb of steam, when formed under constant pressure from water at any temperature t_0 , is $H - h_0$, where h_0 corresponds to t_0 .

It has been pointed out by Mollier that for the purpose of calculations in technical thermodynamics it is convenient to add to the heat of formation the quantity pw/J , which represents the thermal equivalent of the work spent in introducing the water under the piston, against the constant pressure p , before the operation of heating imagined in § 27 begins, w being the volume of the water. We thus obtain a quantity which in its numerical values differs only very slightly from H , namely

$$I = H + pw/J.$$

We shall call this the *total heat* of saturated steam. Values of I are stated in the table. Since the volume of 1 lb of water is only

Properties of Saturated Steam.

Temperature. Centigrade.	Pressure lb per sq. in.	Volume cub. ft. per lb.	Total Heat.		Entropy.	
			Of Water.	Of Steam.	Of Water.	Of Steam.
0	0.089	3283.	0	594.7	0	2.178
5	0.127	2354.	5.0	597.1	0.018	2.148
10	0.178	1708.	10.0	599.4	0.036	2.119
15	0.246	1253.	15.0	601.8	0.054	2.091
20	0.336	931.	20.0	604.1	0.071	2.064
25	0.455	699.5	25.0	606.5	0.088	2.039
30	0.610	530.7	30.0	608.8	0.104	2.015
35	0.809	406.8	35.0	611.1	0.121	1.991
40	1.062	314.8	40.1	613.5	0.137	1.969
45	1.381	245.8	45.1	615.8	0.153	1.947
50	1.78	193.7	50.1	618.0	0.169	1.927
55	2.27	153.9	55.1	620.3	0.184	1.907
60	2.88	123.3	60.1	622.6	0.199	1.888
65	3.61	99.5	65.2	624.8	0.214	1.870
70	4.51	80.9	70.2	627.0	0.229	1.852
75	5.58	66.24	75.3	629.2	0.244	1.835
80	6.86	54.60	80.3	631.3	0.258	1.819
85	8.38	45.29	85.3	633.5	0.272	1.803
90	10.16	37.79	90.4	635.6	0.286	1.788
95	12.26	31.71	95.5	637.6	0.300	1.773
100	14.70	26.75	100.5	639.7	0.314	1.759
105	17.52	22.69	105.6	641.7	0.327	1.745
110	20.79	19.34	110.7	643.6	0.340	1.732
115	24.55	16.56	115.8	645.5	0.354	1.719
120	28.83	14.25	120.9	647.4	0.367	1.706
125	33.72	12.30	126.0	649.2	0.379	1.694
130	39.26	10.67	131.1	651.0	0.392	1.682
135	45.51	9.29	136.2	652.8	0.405	1.671
140	52.56	8.12	141.3	654.5	0.417	1.660
145	60.42	7.13	146.4	656.1	0.430	1.649
150	69.24	6.274	151.6	657.8	0.442	1.638
155	79.04	5.542	156.7	659.3	0.454	1.628
160	89.93	4.910	161.9	660.8	0.466	1.618
165	101.98	4.363	167.1	662.3	0.478	1.608
170	115.27	3.891	172.2	663.7	0.489	1.599
175	129.9	3.478	177.4	665.0	0.501	1.589
180	145.9	3.116	182.6	666.3	0.512	1.580
185	163.4	2.800	187.9	667.6	0.524	1.571
190	182.6	2.523	193.1	668.8	0.535	1.563
195	203.4	2.279	198.3	670.0	0.546	1.554
200	226.0	2.063	203.6	671.1	0.557	1.546
205	250.5	1.874	208.9	672.2	0.568	1.538
210	277.2	1.703	214.1	673.2	0.579	1.530
215	306.8	1.546	219.4	674.1	0.590	1.522

0.016 cub. ft. the term pw/J is numerically insignificant except at the highest pressures. Similarly, in reckoning the total heat of water I_w we add pw/J to h , and this quantity is also given in the table. The latent heat L is to be found from the table by subtracting I_w , the total heat of water, from the total heat of steam. We shall use the centigrade scale of temperature throughout this article, and accordingly the total heats are expressed in terms of a unit involving the centigrade degree, namely, the quantity of heat required to raise the temperature of unit mass of water through 1° C. at 15° C. With this unit of heat the mechanical equivalent J is 1400 foot-pounds when the unit of mass is the lb, and is 427 kilogram-metres when the unit of mass is the kilogramme.

32. *Internal Energy.*—Of the heat of steam the part pw/J is spent in doing external work. The remainder has gone to increase the stock of internal energy which the substance possesses.

In dealing with the heat required to produce steam we adopted the state of water at 0° C. as an arbitrary starting-point from which to reckon the reception of heat. In the same way it is convenient

¹ R. Mollier, *Neue Tabellen und Diagramme für Wasserdampf* (Berlin, 1906). See also Ewing's *Steam Engine* (3rd ed., 1910).

to use this arbitrary starting-point in reckoning what may be called the *internal energy* of the substance, which is the excess of the heat taken in over the external work done by the substance during its reception of heat. Thus the internal energy E of 1 lb of saturated steam at pressure p is equal to the total heat I , less that part of the total heat which is spent in doing external work, or

$$E = I - pv/J.$$

The notion of internal energy is useful in calculating the heat taken in or rejected by steam during any stage of its expansion or compression in an engine. When a working substance passes from one condition to another its gain or loss of heat is determined by the equation

Heat taken in = increase of internal energy + external work.

Any of the terms of this equation may be negative; the last term is negative when work is done, not by but upon the substance.

33. *Wet Steam*.—In calculations which relate to the action of steam in engines we have often to deal, not with *dry* saturated steam, but with *wet* steam, or steam which either carries in suspension, or is otherwise mixed with, a greater or less proportion of water. In any such mixture, assuming it to be in equilibrium, the steam and water have the same temperature, and the steam is saturated. The dryness of wet steam is measured by the proportion q of dry steam in each pound of the mixed substance. When that is known it is easy to determine the other physical constants: thus—

- Latent heat of 1 lb of wet steam = qL ;
- Total heat of 1 lb of wet steam = $I_w + qL$;
- Volume of 1 lb of wet steam = $qv + (1-q)w$ = qv very nearly,

unless the steam is so wet as to consist mainly of water.

34. *Superheated Steam*.—Steam is superheated when its temperature is raised, in any manner, above the temperature corresponding to saturation at the actual pressure. When considerably superheated, steam approximates in behaviour to a perfect gas.

The specific heat during superheating is nearly constant at low pressures, its value being approximately 0.48; at high pressures it is higher, especially when the amount of superheating is slight. Callendar's equations enable it to be calculated for any assigned conditions of temperature and pressure. They also allow a direct determination to be made of the total heat of superheated steam of given temperature and pressure, and from this, by comparison with the total heat of saturated steam at the same pressure, the mean specific heat over any stated range of superheating may be found. Calling I_s the total heat of steam in the saturated condition, when the temperature is t , κ the mean specific heat in superheating at constant pressure to a higher temperature t' and I' the total heat in the superheated state, we have

$$I' = I_s + \kappa(t' - t).$$

The following are values of κ :—

Temperature of Superheat t' in °C.	Temperature of Saturation t in °C.				
	80°	120°	160°	180°	200°
100°	0.49				
150°	0.49	0.51			
200°	0.49	0.51	0.54	0.57	
250°	0.48	0.50	0.53	0.56	0.59
300°	0.48	0.50	0.52	0.54	0.57
350°	0.48	0.49	0.51	0.53	0.56
400°	0.48	0.49	0.51	0.52	0.55
450°	0.48	0.49	0.51	0.52	0.54

35. *Isothermal Expansion of Steam*.—The expansion of volume which occurs during the conversion of water into steam under constant pressure is isothermal. From what has been already said it is obvious that steam, or any other saturated vapour, can be expanded or compressed isothermally only when wet, and that evaporation (in the one case) or condensation (in the other) must accompany the process. Isothermal lines for a working substance which consists of a liquid and its vapour are straight lines of uniform pressure.

36. *Adiabatic Expansion of Steam*.—If steam initially dry be allowed to expand adiabatically (namely, without taking in or giving out any heat) it becomes wet. A part of the steam is condensed by the process of adiabatic expansion, at first in the form of minute particles suspended throughout the mass. The temperature and pressure fall; and, as that part of the substance which remains uncondensed is saturated, the relation of pressure to temperature throughout the expansion is that which holds for saturated steam. Before expansion let the initial dryness of the steam be q_1 and its absolute temperature τ . Then, if it expand adiabatically until its temperature falls to τ , its dryness after expansion may be shown to be

$$q = \frac{\tau}{L} \left(\frac{q_1 L_1}{\tau_1} + \log_e \frac{\tau_1}{\tau} \right).$$

L_1 and L are the latent heats (in thermal units) of 1 lb of steam before and after expansion respectively. When the steam is dry to begin with, $q_1 = 1$.

This formula is easily applied to the construction of the adiabatic curve when the initial pressure and the pressure after expansion are given, the corresponding values τ and L being found from the table.

37. *Ideal Action of Heat Engine*.—According to the principles of thermodynamics (*q.v.*), the action of a heat engine depends on its receiving heat at a temperature higher than that at which it is capable of rejecting heat to surrounding objects. The working substance in the engine must necessarily pass from an upper temperature, at which it takes in heat, to a lower temperature, at which it rejects heat, the difference between the heat taken in and the heat rejected being the thermal equivalent of the work done. It may readily be shown that when the conditions are such as to make this difference as great as possible—in other words, to make the efficiency reach its ideal limit—the ratio of the heat taken in to the heat rejected depends only on the temperature at which reception and rejection of heat occur. Calling τ_1 and τ_2 the absolute temperatures at which heat is taken in and rejected respectively, and Q_1 and Q_2 the quantities of heat taken in and rejected, the limit of efficiency is reached when $Q_1/Q_2 = \tau_1/\tau_2$. The efficiency then has the value

$$(Q_1 - Q_2)/Q_1 = (\tau_1 - \tau_2)/\tau_1$$

and W , the work done, is $Q_1(\tau_1 - \tau_2)/\tau_1$.

In the ideal engine imagined by Carnot the action is of this simple character. The working substance is brought by adiabatic compression from the lower to the upper extreme of temperature. It then takes in heat, without changing in temperature. Next, it expands adiabatically until its temperature falls to the lower extreme and finally at that temperature it rejects enough heat to restore it to its initial state, thereby completing a cycle of operations.

38. *Carnot's Cycle with Steam for Working Substance*.—We are now in a position to study the action of a heat engine employing steam as the working substance. To simplify the first consideration as far as possible, let it be supposed that we have a long cylinder composed of non-conducting material except at the base, and fitted with a non-conducting piston; also a source of heat A at some temperature τ_1 ; a receiver of heat, or, as we may now call it, a condenser C , at a lower temperature τ_2 ; and a non-conducting cover B . Then we can perform as follows the ideal reversible cycle of operations first described by Carnot, which gives the highest possible efficiency attainable in any heat engine. To fix the ideas, suppose that there is 1 lb of water in the cylinder to begin with, at the temperature τ_1 :—

1. Apply A , and allow the piston to rise. The water will take in heat and be converted into steam, expanding isothermally at constant pressure p_1 . This part of the operation is shown by the line ab in fig. 9.

2. Remove A and apply B . Allow the expansion to continue adiabatically (bc), with falling pressure, until the temperature falls to τ_2 . The pressure will then be p_2 , namely, the pressure given in the table corresponding to τ_2 .

3. Remove B , apply C , and compress. Steam is condensed by rejecting heat to C . The action is isothermal, and the pressure remains p_2 . Let this be continued until a certain point d is reached, after which adiabatic compression will complete the cycle.

4. Remove C and apply B . Continue the compression, which is now adiabatic. If the point d has been rightly chosen, this will complete the cycle by restoring the working fluid to the state of water at temperature τ_1 .

The "indicator diagram" or diagram exhibiting the relation of pressure to volume for such a cycle is given in fig. 9. Since the process is reversible, and since heat is taken in only at τ_1 and rejected only at τ_2 , the ideal conditions for perfect efficiency are satisfied, and accordingly the efficiency is $(\tau_1 - \tau_2)/\tau_1$. The heat taken in per lb of the fluid is L_1 , and the work done is $L_1(\tau_1 - \tau_2)/\tau_1$, a result which may be used to check the calculation of the diagram.

39. *Efficiency of a Perfect Steam Engine: Limits of Temperature*.—If the action here described could be realized in practice, we should have a thermodynamically perfect steam engine using saturated steam. The fraction of the heat supplied to it which such an engine would convert into work would depend simply on the temperature, and therefore on the pressure, at which the steam was produced and condensed. The temperature of condensation is limited by the consideration that there must be an abundant supply of some substance to absorb the rejected heat; water is actually used for this purpose, so that τ_2 has for its lower limit the temperature of the available water-supply.

To the higher temperature τ_1 a practical limit is set by the mechanical difficulties, with regard to strength and to lubrication, which attend the use of high-pressure steam. In engines of ordinary construction the pressure is rarely so much as 250 lb per sq. in.

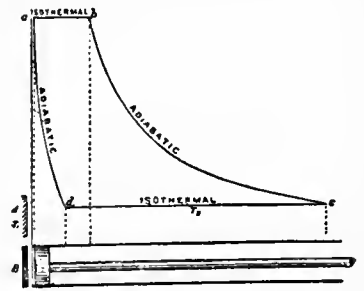

FIG. 9.—Carnot's Cycle with water and steam for working substance.

It must not be supposed that the efficiency $(\tau_1 - \tau_2)/\tau_1$ is actually attained, or is even attainable. Many causes conspire to prevent steam engines from being thermodynamically perfect, and some of the causes of imperfection cannot be removed.

40. *Engine with Separate Organs.*—In the ideal engine represented in fig. 10 the functions of boiler, cylinder and condenser are combined in a single vessel; but, provided the working substance passes through the same cycle of operations, it is indifferent whether these are performed in several vessels or in one. To approach a little more closely the conditions that hold in practice, we may think of the engine as consisting of a boiler A (fig. 10) kept at τ_1 , a non-conducting cylinder and piston B, a surface condenser C kept at τ_2 , and a feed-pump D which restores the condensed water to the boiler. When the several organs of the engine are separated in this way we can still carry out the first three stages of the cyclic process described in § 38. The first stage of that cycle corresponds to the admission of steam from the boiler

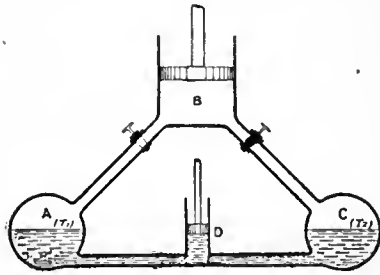

FIG. 10.—Organs of a Steam Engine.

into the cylinder. Then the point known as the point of *cut-off* is reached, at which admission ceases, and the steam already in the cylinder is allowed to expand, exerting a diminishing pressure on the piston. This is the second stage, or the stage of *expansion*. The process of expansion may be carried on until the pressure falls to that of the condenser, in which case the expansion is said to be complete. At the end of the expansion *release* takes place, that is to say, communication is opened with the condenser. Then the return stroke begins, and a period termed the *exhaust* occurs, that is to say, steam passes out of the cylinder, into the condenser, where it is condensed at the pressure in the condenser, which is felt as a *back pressure* opposing the return of the piston. So far, all has been essentially reversible and identical with the corresponding parts of Carnot's cycle.

But we cannot complete the cycle as Carnot's cycle was completed. The existence of a separate condenser makes the fourth stage, that of adiabatic compression, impracticable, and the best we can do is to continue the exhaust until condensation is complete, and then return the condensed water to the boiler.

41. *Rankine Cycle.*—It follows that the ideal cycle of Carnot is not an appropriate standard with which to compare the action of a real steam engine. Instead of it we have, in the engine with separated organs, a cycle which is commonly called the Rankine cycle, which differs from the Carnot cycle only in this, that the stage of adiabatic compression, is wanting and its place is taken by a direct return of the condensed water to the boiler, a process which makes the water receive heat at various temperatures, ranging from the temperature of the condenser up to that of the boiler. The chief part of the heat which the working substance receives is still taken in at the upper limit of temperature, during the process of changing from water to steam. But a small part is taken in at lower temperatures, namely, in the heating of the feed water in its transfer to the boiler. Any heat so taken in has less availability for conversion into work than if it were taken in at the top of the range, and consequently the ideal efficiency of the cycle falls somewhat short of this ideal reached in the cycle of Carnot.

But the principle still applies that with respect to each portion of the heat that is taken in, the fraction convertible into work under ideally favourable conditions is measured by $(\tau - \tau_2)/\tau$, where τ is the absolute temperature at which that portion of heat is received, and τ_2 is the temperature at which heat is rejected. Accordingly, we may investigate as follows the ideal performance of an engine following the Rankine cycle. Let δQ represent that portion of the whole heat which is taken in at any temperature τ . Then the greatest amount of work obtainable from that portion of heat is $\delta Q(\tau - \tau_2)/\tau$, and the whole amount of work ideally obtainable in the complete process is found by calculating $\sum \delta Q(\tau - \tau_2)/\tau$ where the summation includes all the heat that is taken in. In a steam engine using saturated steam the principal item in this sum is the latent heat L_1 , which is taken in at constant temperature τ_1 , during the change of state from water to steam. But there is, in addition, the heat taken in by the feed-water before it reaches the temperature at which steam is formed, and this may be represented as the sum of a series of elements $\sigma d\tau$ taken in at varying temperatures τ , where σ is the specific heat of water. Thus if W represents the thermal equivalent of the work theoretically obtainable per lb of steam, under ideally favourable conditions,

$$W = \sigma \int_{\tau_2}^{\tau_1} \frac{\delta\tau(\tau - \tau_2)}{\tau} + \frac{L_1(\tau_1 - \tau_2)}{\tau_1}$$

The experiments of Regnault show that σ , within the limits of temperature that obtain in boilers, is a nearly constant quantity, and no serious error will be introduced in this integration by treating it as a constant, with a value equal to the mean value, as

determined by Regnault, between the limits of τ_1 and τ_2 . On this basis

$$W = \sigma(\tau_1 - \tau_2) - \sigma\tau_2 \log_e \frac{\tau_1 + \frac{L_1(\tau_1 - \tau_2)}{\tau_1}}{\tau_2}$$

It is usual to take σ as practically equal to 1, which makes

$$W = (\tau_1 - \tau_2) \left(1 + \frac{L_1}{\tau_1} \right) - \tau_2 \log_e \frac{\tau_1}{\tau_2}$$

This expresses the greatest amount of work which each pound of steam can yield when the temperature τ_1 at which it reaches the engine and the temperature τ_2 at which it leaves the engine are assigned. It consequently serves as a standard with which the actual performance may usefully be compared. The actual yield per lb of steam is always considerably less, chiefly because the ideal condition of adiabatic expansion from the higher to the lower extreme of temperature is never satisfied.

A more simple expression for the work theoretically obtainable per lb of steam when expanded adiabatically under the conditions of the Rankine cycle, is

$$I_1 - I_2,$$

where I_1 is the total heat of the working substance in the initial state, before the adiabatic expansion, and I_2 is its total heat after that expansion. For it may readily be proved that, in an adiabatic process,

$$I_1 - I_2 = \int_{p_2}^{p_1} v dp,$$

and this integral is the area of the indicator diagram when the substance is taken in at p_1 , expanded to p_2 and discharged at p_2 .

This expression applies whether the steam is initially superheated or not. I_2 will in general be the total heat of a wet mixture, and to calculate it we must know the condition as to wetness which results from the expansion. This is most easily found, especially when there has been initial superheat, by making use of the entropy-temperature diagram to be presently described, or by other graphic methods, for an account of which the reader should refer to the paper by Mollier already cited, or to J. A. Ewing's *The Steam Engine and other Heat Engines* (3rd ed.).

42. *Entropy.*—The study of steam-engine problems is greatly assisted by introducing the idea of entropy and making use of diagrams in which the two co-ordinates are entropy and temperature. Entropy is a condition of the working substance defined by the statement that when any quantity of heat δQ is received by, or generated in, or rejected by the substance, when its absolute temperature is τ , the substance gains or loses entropy by the amount $\delta Q/\tau$. Thus $\sum \delta Q/\tau$ measures the whole change of entropy in a process which involves the taking in or rejection of heat at more than one temperature. We shall denote entropy by ϕ , and consider it as reckoned per unit of mass of the substance. Since by definition of entropy $\delta\phi = \delta Q/\tau$, $\tau\delta\phi = \delta Q$, and hence if a curve be drawn with τ and ϕ for ordinates to exhibit the action of a working substance, the area under the curve, or $\int \tau d\phi$, being equal to $\sum \delta Q$, measures the heat which the substance has received or rejected during the operation which the curve represents.

In a reversible cycle of operations Carnot's principle shows that $\sum \delta Q/\tau = 0$, and it is obvious in such a case that the entropy returns at the end of the cycle to its primitive value. The same result may be extended to a cycle which includes any non-reversible step, by taking account of the heat generated within the substance by such a step, as if it were heat communicated from outside, in the reckoning of entropy. Thus, for example, if at one stage in the cycle the substance passes through a throttle-valve, which lowers its pressure without letting it do work, the action is equivalent in effect to an adiabatic expansion, together with the communication to the substance, as heat, of the work which is lost in consequence of the irreversible expansion through the throttle-valve taking the place of adiabatic expansion against a piston. If this heat be included in the reckoning $\sum \delta Q/\tau = 0$ for the complete cycle.

The entropy-temperature diagram for any complete cyclic process is a closed curve, and the area it encloses, being the excess of the heat received over the heat rejected, measures the work done. The entropy-temperature diagram shares this useful characteristic with the pressure-volume diagram, and in addition it shows directly the heat received and the heat rejected by the areas under the forward and backward limbs of the curve. To draw the entropy-temperature diagram for the ideal steam engine (namely, the engine following the Rankine cycle), we have to reckon first the entropy which water acquires in being heated, and next the entropy L_1/τ_1 which is acquired when the conversion into steam has taken place. Reckoning from any standard temperature τ_0 , in the heating of the feed-water up to any temperature τ , the entropy acquired is

$$\phi_w = \int_{\tau_0}^{\tau} \frac{\sigma d\tau}{\tau},$$

and taking σ as sensibly constant,

$$\phi_w = \sigma(\log_e \tau - \log_e \tau_0).$$

During evaporation at τ_1 a quantity of heat L_1 is taken in at temperature τ_1 , and hence the entropy of the steam

$$\phi_s = \phi_w + L_1/\tau_1 = \sigma(\log_e \tau_1 - \log_e \tau_0) + L_1/\tau_1.$$

Values of the entropy of water and steam are given in the table. The entropy-temperature diagram for a Rankine cycle is illustrated

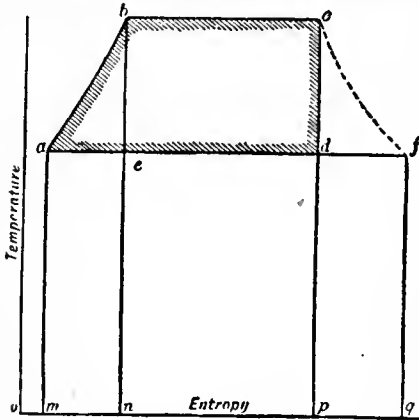

FIG. 11.

being also isentropic. Finally, the cycle is completed by *da*, which represents the condensation of the steam after its temperature has been reduced by adiabatic expansion to the lower limit of temperature. The area *abcd* represents the work done, and its value per lb of steam is identical with *W* as reckoned above. The area *mabc* is the whole heat taken in, and the area *madp* is the heat rejected.

Let a curve *cf* be drawn to show the values of the entropy of steam for various temperatures of saturation: then if *ad* be produced to meet the curve in *f*, the ratio *fd/fa* represents the fraction of the steam which was condensed during adiabatic expansion. For the point *f* represents the state of 1 lb of saturated steam, and in the condensation of 1 lb of saturated steam the heat given out would be the area under *fa*, whereas the heat actually given out in the condensation from *d* was the area under *da*. Thus the state at *d* is that of a wet mixture in which *da/fa* represents the fraction present as steam, and *fd/fa* the fraction present as water. It obviously follows that by drawing horizontal lines at intermediate temperatures the development of wetness in the expanding steam can be readily traced. Again, if the steam is not dry when expansion begins, its state may be represented by making the expansion line begin at a point in the line *bc*, such that the segments into which the line is divided are proportional to the constituents of the wet mixture. In this way the ideal process may be exhibited for steam with any assumed degree of initial wetness. Further, the entropy-temperature diagram admits of ready application to the case of incomplete expansion. Suppose, for example, that after adiabatic expansion from *c* to *c'* (fig. 12) the steam is directly cooled to the lower-limit



FIG. 12.

temperature by the application of cooling water instead of by continued expansion. This process is represented by the line *c'ed*, which is a curve of constant volume. Its form is determined by the consideration that at any point *e* the proportion of steam still uncondensed, or *le/lk*, is such that the mixture fills the same volume as was filled at *c'*.

43. *Entropy-Temperature Diagrams extended to the Case of Superheated Steam.*—In the diagrams which have been sketched, it has been assumed that the steam is supplied to the engine in a saturated state.

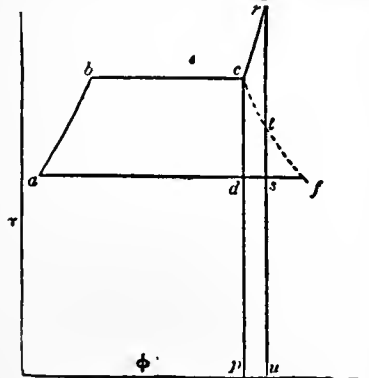

FIG. 13.

To extend the same treatment to the case of superheated steam, we have to take account of the supplementary supply of heat which the steam receives after the point *c* is reached, and before expansion begins. When superheating is resorted to, as is now often the case in practice, the superheat is given at constant pressure. If κ represent as before the mean specific heat of steam at constant pressure, the addition of entropy during

the process of superheating from τ_1 to τ' is $\kappa(\tau' - \tau_1)$. The value of κ may be treated as approximately constant, and the addition to the entropy may then be written as $\kappa(\log \tau' - \log \tau_1)$. This gives a line such as *cr* on the entropy diagram (fig. 13), and increases the value of *W* by the amount

$$\int_{\tau_1}^{\tau'} \frac{\kappa d\tau(\tau - \tau_1)}{\tau}$$

which is represented on the diagram by the area *dcrs*. During adiabatic expansion from τ the steam remains superheated until it reaches the state *l*, when it is just saturated, and further expansion results in the condition of wetness indicated by *s*. The extra work *dcrs* is done at the expense of the extra supply of heat *pcru*, and an inspection of the diagram suffices to show that the efficiency of the ideal cycle is only very slightly increased by even a large amount of superheating. In practice, however, superheating does much to promote efficiency, because it materially reduces the amount by which the actual performance of an engine falls short of the ideal performance by keeping the steam comparatively dry in its passage through the engine, and thereby reducing exchanges of heat between the steam and the metal.

44. *Entropy of Wet Steam.*—The entropy of wet steam is readily calculated by considering that the change of entropy in the conversion from water to steam will be qL/τ if the steam is wet, q being the dryness. Accordingly the entropy of wet steam at any temperature τ is $\sigma(\log \tau - \log \tau_0) + qL/\tau$. Further, since σ for water is practically equal to unity this expression may be written

$$\phi = \log \tau - \log \tau_0 + qL/\tau.$$

We may apply this expression to trace the development of wetness in steam when it expands adiabatically. In adiabatic expansion $\phi = \text{constant}$. Using the suffix 1 to distinguish the initial state, we therefore have at any stage in the expansion

$$\log \tau - \log \tau_0 + qL/\tau = \log \tau_1 - \log \tau_0 + q_1L_1/\tau_1,$$

from which the dryness at that stage is found, namely,

$$q = \frac{\tau}{L} \left(\frac{q_1L_1}{\tau_1} + \log \frac{\tau_1}{\tau} \right).$$

The expression is not applicable to steam which is initially superheated. In either case the graphic method of tracing the change of condition during adiabatic expansion is available.

45. *Actual Performance.*—Trials of engines using saturated steam show that in the most favourable cases from 60 to 65 % of the ideally possible amount of work is realized as "indicated" work. One of the causes of loss is that the expansion is incomplete. In practice the steam is allowed to escape to the condenser, while its pressure is still considerably higher than the pressure at which condensation is to take place. When the pressure of steam in the cylinder has been so far reduced by expansion that it can only overcome the friction of the piston, there is no advantage in going on further; the indicated work due to any additional expansion would add nothing to the output of the engine, when allowance is made for the work spent on friction within the mechanism itself. Considerations of bulk often lead to an even earlier release of the expanding steam; and another consideration which points the same way is that when expansion is carried very far, the losses due to exchange of heat between the cylinder and the steam, referred to below, tend to increase. Again, since experience shows that the most efficient engines are those in which the process of expansion is divided into two, three or more stages by the use of compounded cylinders, a certain amount of loss is to be ascribed to the drops in pressure which are liable to occur through unresisted expansion in the transfer of steam from one vessel to another. But the chief cause of loss is to be found in the exchanges of heat which take place between the steam and the metal. In each cylinder there is a process of alternate condensation and re-evaporation—condensation during the period of admission, when the steam finds itself brought into contact with metal which has been chilled by evaporation during the preceding exhaust stroke, and then evaporation, when the pressure has fallen sufficiently, during the later stage of expansion, as well as during exhaust. The consequence is that the steam, though supplied in a dry state, may contain some 20 or 30 % of moisture when admission to the cylinder is complete, and the entropy diagram for the real process of expansion takes a form such as is indicated by the line *c'c''* in fig. 14. The heat supplied is still measured by the area under *abc*. The condensation from *c* to *c'* occurs by contact with the walls of the cylinder; and though part of the heat thus abstracted is restored before release occurs at *c''*, the general result is to make a large reduction in the area of the diagram.

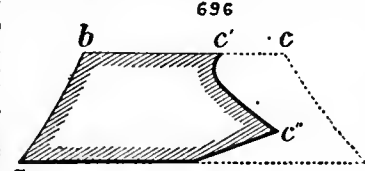

FIG. 14.

46. *Exchanges of Heat between the Steam and the Metal.*—The exchanges of heat between steam and metal in the engine cylinder have been made the subject of an elaborate experimental examination

by Professors Callendar and Nicolson (*Proc. Inst. C.E.* cxxxi. 147), who studied the cyclic variations of temperature throughout the metal by means of thermo-electric junctions set at various depths. They found that the range of temperature through which the surface of the metal fluctuates is much less than the range of temperature passed through by the steam; the processes of condensation and re-evaporation are slow, and the time is too short to bring the surface of the metal into anything like equilibrium with the steam. The amount of condensation up to the point of cut-off, as inferred from the heat which the metal takes up, may be much less than the "missing quantity" or difference between the steam supplied per stroke and the dry steam then present. According to their experiments, this discrepancy is accounted for by leakage of steam past the valve, direct from the steam chest to the exhaust, and they suggest that this source of error may have been present in many estimates of initial condensation based on determinations of the missing quantity. This may explain cases in which the initial condensation has apparently been excessive, but large amounts of initial condensation certainly do occur, and constitute the most potent factor in making the real performance of the engine fall short of the ideal standard.¹

In the alternate condensation and re-evaporation of steam in the cylinder more heat is given to the metal by each pound of steam that is condensed than is taken from the metal by each pound of steam that is re-evaporated, the temperature of condensation being higher than that of re-evaporation. The quantity $H_1 - H_2$, namely, the difference in the heat of formation at the two temperatures, represents this excess of heat. Unless this is in some way abstracted from the metal, the process cannot occur. Hence the action of the cylinder walls in causing alternate condensation and re-evaporation to occur may be limited by imposing conditions which prevent or reduce the abstraction of heat. By the use of a steam jacket the metal may be prevented from losing heat externally, and may even be made to take up heat. Under these conditions the action depends on the fact that more water is re-evaporated than is condensed. To some extent this is a necessary result of the work done during expansion, which (in an adiabatic process) would make the steam become wetter as expansion proceeds, and would therefore leave more water to be evaporated than is initially condensed by the action of the cylinder walls. But it is important to notice that any water which is introduced into the cylinder along with the steam will be an important factor in supplying the means by which this thermal balance is maintained. With steam that is perfectly dry before admission the action of the walls takes its limit from the condensation which expansion brings about; with steam that is wet before admission no such limit applies. Hence the importance of having steam that is initially dry. To secure this, no method is so certain as to give some initial superheat to the steam, and hence arises the practical advantage which even a small amount of superheating is found to bring about.

47. *Influence of the Slide-Valve.*—To a considerable extent the slide-valve itself promotes initial condensation, for it requires that the hot steam shall enter the cylinder through a passage which, immediately before, was chilled by being used for the escape of exhaust steam. The use of entirely distinct admission and exhaust ports and valves tends towards economy of steam, partly for this reason and partly because it allows the clearance spaces to be reduced. Accordingly, we find that many of the best recorded results of tests relate to engines in which each cylinder has four separate valves of the Corliss or of the drop type. By using horizontal cylinders with admission valves on the top and exhaust valves below, the further advantage of drainage through the exhaust valves is secured. Water which is present at release has then the chance of escaping without being re-evaporated, a circumstance which contributes largely to reduce the exchange of heat between the working substance and the metal. Thus a horizontal triple-expansion engine with drop valves, by Messrs Sulzer, using saturated steam at an absolute pressure of 160 lb per sq. in., and indicating not much more than 200 h.p., is reported, in a test by Professor Stodola, to have used only 11.52 lb of steam per indicated horse-power-hour (see *Engineer*, July 1, 1898; also summary of trials by B. Doukin, *ibid.*, Oct. 13, 1899). The performance in this test is equivalent to nearly 69% of the ideal, an exceptionally high figure. In one or two trials of larger engines even this performance has been surpassed, 11.2 and 11.3 lb per horse-power-hour having been recorded. In other particularly favourable records of trials the consumption of steam with triple-expansion engines has been found to lie between 12 and 13 lb per horse-power-hour. Some of the best results relate to slow-running pumping engines fitted with steam jackets on the barrels and on the covers of the cylinders, and may be taken as showing how influential, in a long-period engine, the jacket may prove in reducing the evils of initial condensation. In the mean of several apparently authoritative trials by different observers on different engines the consumption of steam was 12.2 lb per horse-power-hour, at an absolute pressure of about 140 lb per sq. in., which corresponds to 66% of the ideal performance.

It should be added that these figures are exceptional. A consumption of 13 or 14 lb of steam per horse-power-hour is much more usual even in large and well-designed triple-expansion engines; and with two-cylinder compound engines, using steam with an absolute pressure of 100 or 120 lb per sq. in., anything from 14 to 15 lb may be reckoned a good performance.

48. *Superheated Steam.*—The advantage of superheated steam, which arises mainly from its influence in reducing the exchange of heat between the steam and cylinder walls, was demonstrated by the experiments of Hirn, and as early as 1860 it was not unusual to supply superheaters with marine engines. But the practice of superheating was soon abandoned, chiefly on account of difficulties in regard to lubrication. By the introduction of heavy mineral oils this objection has been removed, and a revival in the use of superheating has taken place, with striking effect on the thermodynamic economy of engines. Experiments made in 1892 by the Alsatian Society of Steam Users on a large number of engines showed that superheating effected an average saving in coal to the extent of about 20%, when the superheater was simply placed in the boiler flue, so that it utilized what would otherwise be waste heat, and about 12% when the superheater was separately fired. In those cases the steam was superheated only about 30° to 45° C. above the temperature of saturation, but in more recent practice much greater amounts of superheat have been successfully applied. Professor Schröter has tested a factory engine of 1000 h.p., using steam superheated by some 50° C., and has shown that this amount of superheat is not sufficient to prevent some of the steam from becoming condensed on the walls during admission to the cylinder (*Zeitschrift des Vereins deutscher Ingenieure*, vol. xl., 1896). It follows that still larger amounts of superheat will be thermodynamically advantageous. That this is the case has been demonstrated by the remarkable results which have been obtained with highly superheated steam by W. Schmidt in stationary engines and locomotives. Using a somewhat special design, Schmidt has shown that it is perfectly practicable to employ steam superheated to a temperature of 400° C., and that an efficiency not attainable from steam in any other way is thereby reached. In several authentic trials of Schmidt engines the consumption of steam has been considerably less than 10 lb per indicated horse-power-hour—a figure which, after allowance is made for the heat taken up during the process of superheating, represents a better performance than that of the best engines using saturated or slightly superheated steam. It has been found that the consumption of coal, in the boiler and superheater together, need not exceed 1½ lb per indicated horse-power even with engines of small power. To attain this remarkable result it is of course necessary that, after the hot gases from the furnace have passed the superheater, a further extraction of heat from them should take place. This is done by an economizer or feed-water heater of peculiar form, consisting of a long coil of small pipes which maintain a circulation of hot distilled water through a closed system containing an external coil, which forms the heater of a tank through which the feed-water passes on its way to the boiler. Some of the Schmidt engines adopt the principle of single action, to escape the necessity of having a piston-rod and gland on the side which is exposed to contact with high-temperature steam; but it is found that this precaution is not essential, and that with glands of suitable design a double-acting piston may be used without inconvenience, and without risk of undue wear. In some instances Schmidt transfers to the partially expanded steam in the intermediate receiver a portion of the heat which is conveyed to the engine by the highly superheated steam; and when this is done, the steam may properly receive a still higher degree of initial superheat. Accordingly, though the initial temperature of the steam may be 400° C. or more, this is reduced to about 320° by transfer to steam in the superheater before the high-pressure steam is admitted to the cylinder. In tests by the present writer of a Schmidt plant indicating 180 h.p., in which this device was employed, the steam was superheated to 397° C. and 10.4 lb were used per horse-power-hour. In this trial the temperature of the chimney gases was reduced, by the use of Schmidt's feed-water heater, to 175° C., and the consumption of coal was 1.31 lb per indicated horse-power-hour. In another trial, of a larger engine with steam superheated to 425° C., the consumption of steam per horse-power-hour was only 9.0 lb.

49. *The Indicator.*—The actual behaviour of steam in the cylinder of a steam engine is studied by means of the indicator, which serves not only to measure the work done but to examine the operation of the valves and generally to give much useful information regarding the action of the engine. The indicator, which was invented by Watt, and improved by Richards, is a device for automatically drawing a diagram showing the pressure at all points of the piston's stroke. In its most usual form it consists of a small steam cylinder fitted with a piston which slides easily within it and is pressed down by a spiral spring of steel wire. The cylinder of the indicator is connected by a pipe below this piston to one or other end of the cylinder of the engine, so that the piston of the indicator rises and falls in response to the fluctuations of pressure which occur in the engine cylinder. The indicator piston actuates a pencil, which rises and falls with it and traces the diagram on a sheet of paper fixed to a drum that is caused to rotate back and forth through a certain arc, in unison with the motion of the engine piston. In

¹ See also "Report of Steam Engine Research Committee," *Inst. Mech. Eng.* (1905).

M'Naught's indicator the pencil is directly attached to the indicator piston, in Richards's the pencil is moved by means of a system of links so that it copies the motion of the piston on a magnified scale. This has the advantage that an equally large diagram is drawn with much less movement of the piston, and errors which are caused by the piston's inertia are consequently reduced. In high-speed engines especially it is important to minimize the inertia of the indicator piston and the parts connected with it. In Richards's indicator the linkage employed to multiply the piston's motion is an arrangement similar to the parallel motion introduced by Watt as a means of guiding the piston-rod in beam engines. In several recent forms of indicator lighter linkages are adopted, and other changes have been made with the object of fitting the instrument better for high-speed work. One of these modified forms of Richards's indicator (the Crosby) is shown in fig. 15. The pressure

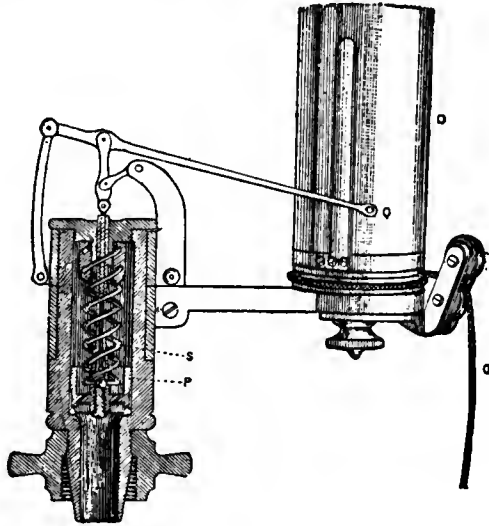

FIG. 15.—Crosby Indicator.

of steam in the engine cylinder raises the piston P, compressing the spring S and causing the pencil Q to rise in a nearly straight line through a distance proportional, on a magnified scale, to the compression of the spring and therefore to the pressure of the steam. At the same time the drum D, which carries the paper, receives motion through the cord C from the crosshead of the engine. Inside this drum there is a spiral spring which becomes wound up when the cord is pulled, and serves to turn the drum in the reverse direction during the back stroke. The cap of the indicator cylinder has holes in it which admit air freely to the top of the piston, and the piston has room to descend, extending the spring S, when the pressure of the steam is less than that of the atmosphere. The spring is easily taken out and replaced by a more or less stiff one when higher or lower pressures have to be dealt with.

50. *Errors in Indicator Diagrams.*—To register correctly, an indicator must satisfy two conditions: (1) the motion of the piston must be proportional to the change of steam pressure in the engine cylinder; and (2) the motion of the drum must be proportional to that of the engine piston.

The first of these requires that the pipe which connects the indicator with the cylinder should be short and of sufficient bore, and that it should open in the cylinder at a place where the pressure in it will not be affected by the kinetic action of the inrushing steam. Frequently pipes are led from both ends of the cylinder to a central position where the indicator is set, so that diagrams may be taken from either end without shifting the instrument; better results are obtained, especially when the cylinder is long, by using a pair of indicators, each fixed with the shortest possible connecting pipe. The general effect of an insufficiently free connexion between the indicator and the engine cylinder is to make the diagram too small. The first condition is also invalidated to some extent by the friction of the indicator piston, of the joints in the linkage, and of the pencil on the paper. The piston must slide very freely; nothing of the nature of packing is permissible, and any steam that leaks past it must have a free exit through the cover. The pencil pressure must not exceed the minimum which is necessary for clear marking. Another source of disturbance is the inertia of the moving parts, which tends to set them into oscillation whenever the indicator piston suffers a comparatively sudden displacement. These oscillations, superposed upon the legitimate motions of the piston, give a wavy outline to parts of the diagram, especially when the speed is great. When they appear on the diagram a continuous curve should be drawn midway between the crests and hollows of the undulations. To keep them within reasonable compass in high-speed work a stiff spring must be used and an indicator with light parts should be selected. Care must be taken that the spring is

graduated to suit the temperature (about 100° C.) to which it is exposed when in use; its stiffness at this temperature is about 3% less than when cold.

51. *Measurement of Horse-Power.*—To determine the indicated horse-power, the mean effective pressure is found by dividing the area of the diagram by the length of its base. This gives a mean height, which, interpreted on the scale of pressures, is the mean effective pressure in pounds per square inch. This has to be multiplied by the effective area of the piston in square inches and by the length of the piston stroke in feet to find the work done per stroke in foot-pounds on that side of the piston to which the diagram refers. Let A_1 be the area of the piston on one side and A_2 on the other; p_1 and p_2 the mean effective pressures on the two sides respectively; L the length of the stroke in feet; and n the number of complete double strokes or revolutions per minute. Then the indicated horse-power

$$\text{I.H.P.} = \frac{nL(p_1A_1 + p_2A_2)}{33000}$$

In finding the mean pressure the area of the diagram may be conveniently measured by a planimeter. A less accurate plan, frequently followed, is to divide the diagram by lines drawn at the middle of strips of equal width and to take the mean pressure as the average height of these lines.

52. *Tests of Efficiency.*—In testing the actual efficiency of an engine the work done as determined by the indicator is compared with the supply of heat, which is calculated from the amount of steam passing through the engine. We may find the amount of steam passing through either by measuring the feed-water or, when a surface condenser is used, by collecting the condensed water from the air-pump discharge and measuring that, adding the water drained from jackets if any are used. In some trials both of these measurements have been made, and it has been found that in general the amount of feed-water exceeds the amount of steam discharged from air-pump and jackets by something like 3 or 4%, a discrepancy due to leakages in the boiler and the engine. The results of tests are generally stated by giving the number of pounds of steam used per horse-power-hour, or by giving the work done by each pound of steam, a quantity which is directly comparable with the amount of work ideally obtainable, if the engine followed the perfect Rankine cycle already discussed. To make a complete engine trial the engine is caused to work not only at full power, but at various fractions of its greatest load. The results are very conveniently represented (in a manner due to P. W. Willans) by drawing a curve, the co-ordinates of which are the horse-power and the total consumption of steam per hour. This "Willans Line," as it is called, is in most cases straight or nearly straight. Another useful curve is drawn by plotting the steam used per horse-power-hour in relation to the horse-power.

53. *Determination of the "Missing Quantity."*—When the amount of steam passing through the engine is known, the indicator diagram enables the degree of wetness of the steam to be estimated at various stages in the expansion from cut-off to release, provided there is no direct passage from steam-chest to exhaust, such as has been referred to above in connexion with Messrs Callendar and Nicolson's researches. For this purpose we must first calculate the quantity of the working substance present in the cylinder. It is made up of two parts, namely, the amount supplied per stroke, plus the amount retained by being shut up in the clearance space. If we assume, as may generally be done without serious error, that at the beginning of compression the steam present in the cylinder is dry, it is an easy matter to deduce from the diagram, knowing the pressure and the volume, how much steam is shut up in the clearance. Adding that to the supply per stroke, we get the whole quantity that is present from cut-off to release. The volume which this would occupy at each pressure, if saturated, is found from the steam table. The volume actually occupied at each pressure is found from the diagram, and by comparing the two it is easy to infer how much of the substance exists as water and how much as steam. The ratio of the two volumes measures with sufficient accuracy the dryness of the steam. Any direct leakage from the steam side to the exhaust side of the valve will invalidate this calculation, which proceeds on the basis that all the steam passing through the engine passes through the cylinder.

54. *Compound Engines.*—In the original form of compound engine, invented by Hornblower and revived by Woolf, steam passed directly from the first to the second cylinder; the exhaust from the first and admission to the second went on together throughout the whole of the back stroke. This arrangement is possible only when the high and low pressure pistons begin and end their strokes together, as in engines of the "tandem" type, whose high and low pressure cylinders are in one line, with one piston-rod common to both pistons. Engines in which the high and low pressure cylinders are placed side by side, and act either on the same crank or on cranks set at 180° apart, may also discharge steam directly from one to the other cylinder; the same remark applies to beam engines, whether of the class in which both pistons act on one end of the beam, or of the class introduced by M'Naught, in which the high and low pressure cylinders stand on opposite sides of the centre. By a

convenient usage which is now pretty general the name "Woolf engine" is restricted to those compound engines which discharge steam directly from the high to the low pressure cylinders without the use of an intermediate receiver.

55. *Receiver Engine.*—An intermediate receiver becomes necessary when the phases of the pistons in a compound engine do not agree. With two cranks at right angles, for example, a portion of the discharge from the high-pressure cylinder occurs at a time when the low-pressure cylinder cannot properly receive steam. The receiver is in some cases an entirely independent vessel connected to the cylinders by pipes; very often, however, a sufficient amount of receiver volume is afforded by the valve casings and the steam pipe which connects the cylinders. The receiver, when it is a distinct vessel, is frequently jacketed.

A receiver is frequently applied with advantage to beam and tandem compound engines. Communication need not then be maintained between the high and low pressure cylinders during the whole of the stroke, admission to the low-pressure cylinder is stopped before the stroke is completed; the steam already admitted is allowed to expand independently; and the remainder of the discharge from the high-pressure cylinder is compressed into the intermediate receiver. Each cylinder has then a definite point of cut-off, and by varying these points the distribution of work between the two cylinders may be adjusted at will. In general it is desirable to make both cylinders of a compound engine contribute equal quantities of work. If they act on separate cranks this has the effect of giving the same value to the mean twisting moment of both cranks.

56. *Compound Diagrams.*—Wherever a receiver is used, care should be taken that there should not be a wasteful amount of unresisted expansion into it; in other words, the pressure in the receiver should be not greatly less than that in the high-pressure cylinder at the moment of release. If the receiver pressure is less there will be what is termed "drop" in the steam pressure between the high-pressure cylinder and the receiver, which will show itself in an indicator diagram by a sudden fall at the end of the high-pressure expansion. This "drop" is, from the thermodynamic point of view, irreversible, and therefore wasteful. It can be avoided by selecting a proper point of cut-off in the low-pressure cylinder. When there is no "drop" the expansion that occurs in a compound engine has precisely the same effect in doing work as the same amount of expansion in a simple engine would have, provided the law of expansion be the same in both and the waste of energy which occurs by the friction of ports and passages in the transfer of steam from one to the other cylinder be negligible. The work done in either case depends merely on the relation of pressure to volume throughout the process; and so long as that relation is unchanged it is a matter of indifference whether the expansion be performed in one vessel or in more than one. In general a compound engine has a thermodynamic advantage over a simple engine using the same pressure and the same expansion, inasmuch as it reduces the exchange of heat between the working substance and the cylinder walls and so makes the process of expansion more nearly adiabatic. The compound engine has also a mechanical advantage which will be presently described. The ultimate ratio of expansion in any compound engine is the ratio of the volume of the low-pressure cylinder to the

independent expansion of the steam now shut within the large cylinder, and DE shows the compression of steam by continued discharge from the small cylinder into the receiver. At the end of the stroke the receiver pressure is OE, and if there is to be no "drop" this must be the same as the pressure at C. Diagrams of a similar kind may be sketched without difficulty for the case of a receiver engine with any assigned phase relation between the pistons.

57. *Adjustment of Work and "Drop."*—By making the cut-off take place earlier in the large cylinder we increase the mean pressure in the receiver; the work done in the small cylinder is consequently diminished. The work done in the large cylinder is correspondingly increased, for the total work (depending as it does on the initial pressure and the total ratio of expansion) is unaffected by the change. The same adjustment serves, in case there is "drop," to lessen it. By selecting a suitable ratio of cylinder volumes to one another and to the volume of the receiver, and also by choosing a proper point for the low-pressure cut-off, it is possible to divide the work suitably between the cylinders and at the same time prevent the amount of drop from being greater than is practically convenient.

58. *Uniformity of Effort in a Compound Engine.*—An important mechanical advantage belongs to the compound engine in the fact that it avoids the extreme thrust and pull which would have to be borne by the piston-rod of a single-cylinder engine working at the same power with the same initial pressure and the same ratio of expansion. If all the expansion took place in the low-pressure cylinder, the piston at the beginning of the stroke would be exposed to a thrust much greater than the sum of the thrusts on the two pistons of a compound engine in which a fair proportion of the expansion is performed in the small cylinder. The mean thrust throughout the stroke in a tandem engine is of course not affected by compounding; only the range of variation in the thrust is reduced. The effort on the crank-pin is consequently made more uniform, the strength of the parts may be reduced, and the friction at slides and journals is lessened. The advantage in this respect is obviously much greater when the cylinders are placed side by side, instead of tandem, and work on cranks at right angles. As a set-off to its advantage in giving a more uniform effort, the compound engine has the drawback of requiring more working parts than a simple engine with one cylinder. But in many instances—as in marine engines—two or more cranks are almost indispensable, to give a tolerably uniform effort and to get over the dead points; and the comparison should then be made between a pair of simple cylinders and a pair of compounded cylinders. Another point in favour of the compound engine is that, although the whole ratio of expansion is great, there need not be a very early cut-off in either cylinder; hence the common slide-valve, which is unsuited to give an early cut-off, may be used in place of a more complex arrangement. The mechanical advantage of the compound engine has long been recognized, and had much to do with its adoption in the early days of high-pressure steam. Its subsequent development has been due in part to this, and in part to the thermodynamic advantage which has been discussed above.

59. *Ratio of Cylinder Volumes.*—In a two-cylinder compound engine, using steam at 80 to 100 lb pressure, the large cylinder has 3 or 4 times the volume of the small cylinder. In triple engines the pressure is rarely less than 150 lb; the low-pressure cylinder has generally 6 or 7 times, and the intermediate cylinder $2\frac{1}{2}$ to $2\frac{3}{4}$ times the volume of the high-pressure cylinder. In naval practice the ratios are about 1 : $2\frac{1}{2}$: 5 for a pressure of 160 lb and 1 : 2.6 : 7 for a pressure of 250 lb. In the mercantile marine the engines are normally working at full power, whereas in the navy most of the working is at greatly reduced powers, the cruising speed requiring very much less than the full output. Consequently, for the same boiler pressure, the cylinder ratio is made less in war-ships to adapt the engines for economical working under cruising conditions.

60. *The Distribution of Steam.*—In early steam engines the distribution of steam was effected by means of conical valves, worked by tappets from a rod which hung from the beam. The slide-valve, the invention of which in the form now known as the long D-slide

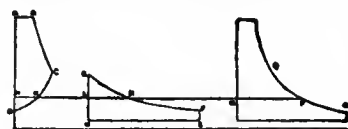
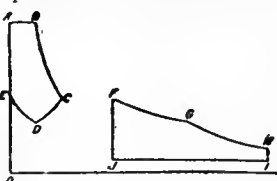

FIG. 16.—Compound Diagrams: Woolf type.

undergoes in transfer from one to the other cylinder. ABCD is the indicator diagram of the high-pressure cylinder. The exhaust line CD shows a falling pressure in consequence of the increase of volume which the steam is then undergoing through the advance of the low-pressure piston. EFGH is the diagram of the low-pressure cylinder drawn alongside of the other for convenience in the construction which follows. It has no point of cut-off; its admission line is the continuous curve of expansion EF, which is the same as the high-pressure exhaust line CD, but drawn to a different scale of volumes. At any point K, the actual volume of the steam is KL + MN. By drawing OP equal to KL + MN, so that OP represents the whole volume, and repeating the same construction at other points of the diagram, we may set out the curve QPR, the upper part of which is identical with BC, and so complete a single diagram which exhibits the equivalent expansion in a single cylinder.



In a tandem compound engine of the receiver type the diagrams resemble those shown in fig. 17. During CD (which corresponds to FG) expansion is taking place into the large or low-pressure cylinder. D and G mark the point of cut-off in the large cylinder, after which GH shows the

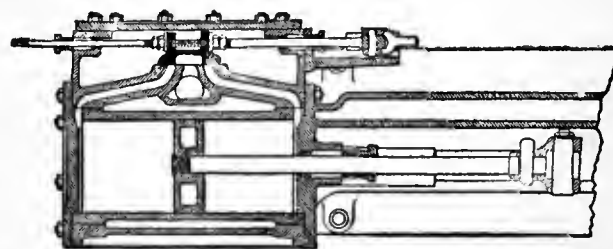

FIG. 18.—Horizontal Section through Cylinder and Valve-chest: showing Slide-valve.

is credited to Murdock, an assistant of Watt, came into general use with the introduction of locomotives, and is now employed, in one or other of many forms, in the great majority of engines.

The common slide-valve is illustrated in fig. 18, which also shows

the cylinder and the ports and passages leading to its ends. The seat, or surface on which the valve slides, is a plane surface formed on or fixed to the side of the cylinder, with three ports or openings which extend across the greater part of the cylinder's width. The central opening is the exhaust port through which the steam escapes; the others, or steam ports, which are narrower, lead to the two ends of the cylinder respectively. The valve is a box-shaped cover which slides over the seat, and the whole is enclosed in a chamber called the valve-chest, to which steam from the boiler is admitted. When the valve moves a sufficient distance to either side of the central position, steam enters one end of the cylinder from the valve-chest and escapes from the other end of the cylinder through the cavity of the valve into the exhaust port. The valve is generally moved by an eccentric on the engine shaft, which is mechanically equivalent to a crank whose radius is equal to the eccentricity, or distance from the centre of the shaft to the centre of the eccentric sheave. The eccentric rod is generally so long that the motion of the valve is sensibly the same as that which it would receive were the rod infinitely long. Thus if a circle (fig. 19) be drawn to represent the path of the eccentric centre during a revolution of the engine, and a perpendicular PM be drawn from any point P on a diameter AB, the distance CM is the displacement of the valve from its middle position at the time when the eccentric centre is at P. AB is the whole travel of the valve.

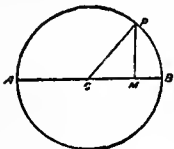

FIG. 19.

61. *Lap and Lead.*—If the valve when in its middle position did not overlap the steam ports (fig. 20), any movement to the right or the left would admit steam, and the admission would continue until the valve had returned to its middle position, or, in other words, for half a revolution of the engine. Such a valve would not serve for expansive working, and as regards the relative position of the crank and eccentric it would have to be set so that its middle position coincided with the extreme position of the piston; in other words,



FIG. 20.—Slide-Valve without Lap.



FIG. 21.—Slide-Valve with Lap.

the eccentric radius would make a right angle with the crank. Expansive working, however, becomes possible when we give the valve what is called "lap," by making it project over the edges of the steam ports, as in fig. 21, where *o* is the "outside lap" and *i* is the "inside lap." Admission of steam (to either side) then begins only when the displacement of the valve from its middle position exceeds the amount of the outside lap, and continues only until the valve has returned to the same distance from its middle position. Further, exhaust begins only when the valve has moved past the middle by a distance equal to *i*, and continues until the valve has again returned to a distance *i* from its middle position. Thus on the diagram of the eccentric's travel (fig. 22) we find, by setting off *o* and *i* on the two sides of the centre, the positions *a*, *b*, *c* and *d* of the eccentric radius at which the four events of admission, cut-off, release and compression occur for one side of the piston. As to the other side of the piston, it is only necessary to set off *o* to the right and *i* to the left of the centre, but for the sake of clearness we may confine our attention to one of the two sides. Of the whole revolution, the part from *a* to *b* is the arc of steam admission, from *b* to *c* is the arc of expansion, from *c* to *d* the arc of exhaust, and from *d* to *a* the arc of compression. The relation of these, however, to the piston's motion is still undefined. If the eccentric were set in advance of the crank by an angle equal to $\angle ACa$, the opening of the valve would be coincident with the beginning of the piston's stroke. It is, however, desirable, in order to allow the steam free entry, that the valve be already some way open when the piston stroke begins, and thus the eccentric may be set to have a position Ca' at the beginning of the stroke. In that case the valve is open at the beginning of the stroke to the extent mm' , which is called the "lead." The amount by which the angle between Ca' (the eccentric) and CA (the crank) exceeds a right angle is called the *angular advance*, this being the angle by which the eccentric is set in advance of the position it would occupy if the primitive arrangement without lap were adopted. The quantities lap, lead and angular advance (θ) are connected by the equation

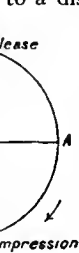

FIG. 22.

outside lap + lead = half travel $\times \cos \theta$.

An effect of lead is to cause *preadmission*, that is to say, admis-

sion before the end of the back stroke, which, together with the compression of steam left in the cylinder when the exhaust port closes, produces the mechanical effect of "cushioning," to which reference has already been made. To examine the distribution of steam throughout the piston's stroke, we may now draw a circle to represent the path of the crank pin (fig. 23, where the dotted lines

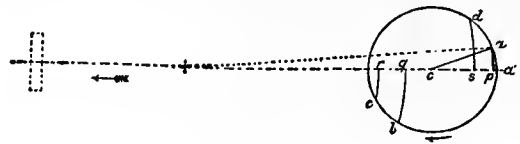

FIG. 23.

have been added to show the assumed configuration of piston, connecting-rod and crank) and transfer to it from the former diagram the angular positions *a*, *b*, *c* and *d* at which the four events occur. To facilitate this transfer the diagrams of eccentric path and of crank-pin path may by a suitable choice of scales be drawn of the same actual size. Then by projecting these points on a diameter which represents the piston's path, by circular arcs drawn with a radius equal to the length of the connecting-rod, we find *p*, the position of the piston at which admission occurs during the back stroke, also *q* and *r*, the position at cut-off and release, during the stroke which takes place in the direction of the arrow, and *s*, the point at which compression begins. It is obviously unnecessary to draw the two circles of figs. 22 and 23 separately; the single diagram (fig. 24) contains the solution of the steam distribution with a slide-valve whose laps, travel and angular advance are known, the same circle serving, on two scales, to show the motion of the crank and of the eccentric.

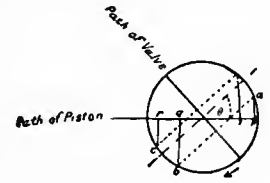

FIG. 24.

Zeuner's Diagram.—The graphic construction most usually employed in slide-valve investigations is the ingenious diagram published by Dr G. Zeuner in the *Civilingenieur* in 1856.¹ On the line AB (fig. 25), which represents the travel of the valve, let a pair of circles (called valve-circles) be drawn, each with diameter equal to the half travel. A radius vector CP, drawn in the direction of the eccentric at any instant, is cut by one of the circles at Q, so that CQ represents the corresponding displacement of the valve from its middle position. That this is so will be seen by drawing PM (as in fig. 19) and joining QB, when it is obvious that $CQ = CM$, which is the displacement of the valve. The line AB with the circle on it may now be turned back through an angle of $90^\circ + \theta$ (θ being the angular advance), so that the valve-circles take the position shown

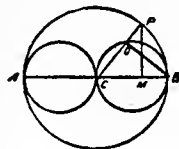

FIG. 25.

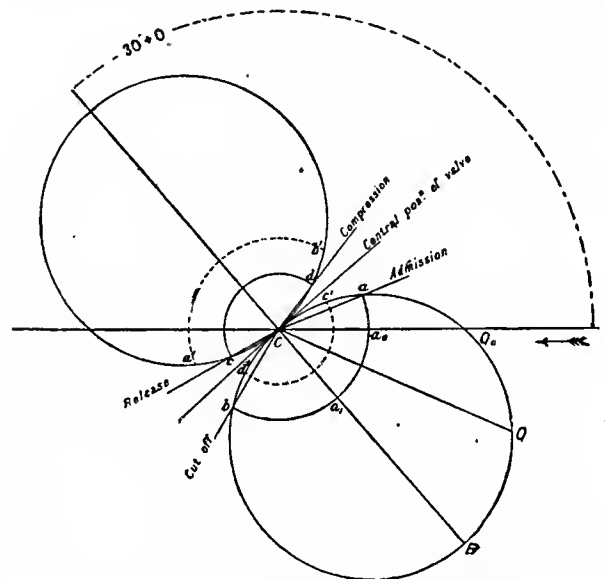

FIG. 26.—Zeuner's Slide-Valve Diagram.

to a larger scale in fig. 26. This makes the direction of CQ (the eccentric) coincide on the paper with the simultaneous direction of

¹ Zeuner, *Treatise on Valve Gears*, trans. by M. Müller (1868).

the crank, and hence to find the displacement of the valve at any position of the crank we have only to draw CQ in fig. 26 parallel to the crank, when CQ represents the displacement of the valve to the scale on which the diameter of each valve circle represents the half-travel of the valve. CQ₀ is the valve displacement at the beginning of the stroke shown by the arrow. Draw circular arcs *ab* and *cd* with C as centre and with radii equal to the outside lap *o* and the inside lap *i* respectively. Ca is the position of the crank at which pre-admission occurs. The lead is *aa*₀. The greatest steam opening is *a*₁B. The cut-off occurs when the crank has the direction Cb. Cc is the position of the crank at release, and Cd marks the end of the exhaust.

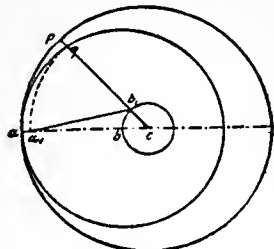

FIG. 27.

63. In this diagram radii drawn from C mark the angular positions of the crank, and their intercepts by the valve circles determine the corresponding displacement of the valve. It remains to find the corresponding displacement of the piston. For this Zeuner employs a supplementary graphic construction, shown in fig. 27. Here *ab* or *a'b'* represents the connecting rod, and *bc* or *b'c* the crank. With centre *c* and radius *ac* a circle *ap* is drawn, and with centre *b* and radius *ab* another circle *aq*. Then for any position of the crank, as *cb'*, the intercept *pq* between the circles is easily seen to be equal to *aa'*, and is therefore the distance by which the piston has moved from its extreme position at the beginning of the stroke. In practice this diagram is combined with that of fig. 26, by drawing both about the same centre and using different scales for valve and piston travel. A radius vector drawn from the centre parallel to the crank in any position then shows the valve's displacement from the valve's middle position by the intercept CQ of fig. 26, and the piston's displacement from the beginning of the piston's motion by the intercept *pq* of fig. 27.

64. In the figures which have been sketched the events refer to the front end of the cylinder, that is, the end nearest to the crank (see fig. 23). To determine the events of steam distribution at the back end, the lap circles shown by dotted lines in fig. 26 must also be drawn, Ca' being the outside lap for the back end, and Cc' the inside lap. These laps are not necessarily equal to those at the other end of the valve. From the diagrams it will be seen that, especially with a short connecting-rod, the cut-off and release occur earlier and the compression later at the front than at the back end if the laps are equal, and a more symmetrical steam distribution can be produced by making the inside lap greater and the outside lap less on the side which leads to the front end of the cylinder. On the other hand, an unsymmetrical distribution may be desirable, as in a vertical engine, where the weight of the piston assists the steam during the down-stroke and resists it during the up-stroke, and this may be secured by a suitable inequality in the laps.

65. By varying the ratio of the laps *o* and *i* to the travel of the valve, we produce effects on the steam distribution which are readily traced by means of the diagram. Reduction of travel (which is equivalent to increase of both *o* and *i*) gives later pre-admission, earlier cut-off, later release and earlier compression; the ratios of expansion and of compression are both increased. Increase of angular advance accelerates all the events and causes a slight increase in the ratio of expansion.

66. In designing a slide-valve the breadth of the steam ports in the direction of the valve's motion is determined with reference to the volume of the exhaust steam to be discharged in a given time, the area of the ports being generally such that the mean velocity of the steam during discharge is less than 100 ft. per second. The travel is made great enough to keep the cylinder port fully open during the greater part of the exhaust; for this purpose it is 2½ or 3 times the breadth of the steam port. To facilitate the exit of steam the inside lap is always small, and is often wanting or even negative. During admission the steam port is rarely quite uncovered, especially if the outside lap is large and the travel moderate. Large travel has the advantage of giving freer ingress and egress of steam, with more sharply-defined cut-off, compression and release, but this advantage is secured at the cost of more work spent in moving the valve and more wear of the faces. To lessen the necessary travel without reducing the area of steam ports, double-ported valves are often used. An example is shown below in fig. 39.

67. *Reversal of Motion with Slide-Valve.*—The eccentric must stand in advance of the crank by the angle $90^\circ + \theta$, as in fig. 28, where CK is the crank, and CE the corresponding position of the eccentric when the engine is running in the direction of the arrow *a*. To set the engine in gear to run in the opposite direction (*b*) it is only necessary to shift the eccentric into the position CE', when it will still be $90^\circ + \theta$ in advance of the crank. In the older engines this reversal was effected

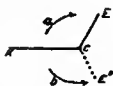

FIG. 28.

by temporarily disengaging the eccentric-rod from the valve-rod, working the valve by hand until the crank turned back through an angle equal to ECE' , the eccentric meanwhile remaining

at rest, and then re-engaging the gear. The eccentric sheave, instead of being keyed to the shaft, was driven by a stop fixed to the shaft, which abutted on one or other of two shoulders projecting from the sheave. In some modern forms of reversing gear means are provided for turning the eccentric round on the shaft, but the arrangement known as the link-motion is now the most usual gear in locomotive, marine, winding and other engines which require to be often and easily reversed.

68. *Link-Motion.*—In the link-motion two eccentrics are used, and the ends of their rods are connected by a link. In Stephenson's link-motion—the earliest and still the most usual form—the link is a slotted bar or pair of bars curved to the same radius as the eccentric rods (fig. 29), and capable of being shifted up or down by a suspension rod. The valve-rod ends in a block which slides within the link, and when the link is placed so that this block is nearly in line with the forward eccentric rod (R. fig. 29) the valve moves in

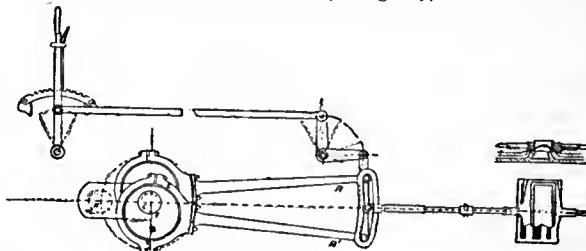

FIG. 29.—Stephenson's Link-Motion.

nearly the same way as if it were driven directly by a single eccentric. This is the position of "full forward gear." In "full backward gear," on the other hand, the link is pulled up until the block is in nearly a line with the backward eccentric rod R'. The link-motion thus gives a ready means of reversing the engine—but it does more than this. By setting the link in an intermediate position the valve receives a motion nearly the same as that which would be given by an eccentric of shorter radius and of greater angular advance, and the effect is to give a distribution of steam in which the cut-off is earlier than in full gear, and the expansion and compression are greater. In mid gear the steam distribution is such that scarcely any work is done in the cylinder. The movement of the link is effected by a hand-lever, or by a screw, or (in large engines) by an auxiliary steam engine. A usual arrangement of hand-lever, sketched in fig. 29, has given rise to the phrase "notching up,"

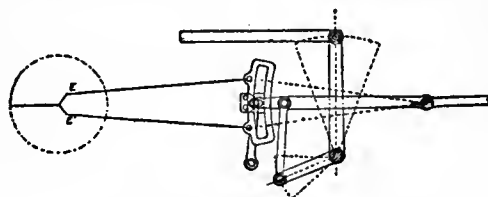

FIG. 30.—Gooch's Link-Motion.

to describe the setting of the link to give a greater degree of expansion.

In Gooch's link-motion (fig. 30) the link is not moved up in

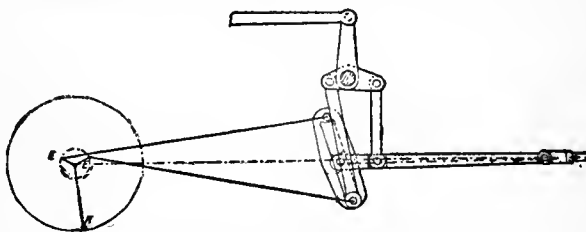

FIG. 31.—Allan's Link-Motion.

shifting from forward to backward gear, but a radius rod between the valve-rod and the link (which is curved to suit this radius rod) is raised or lowered—a plan which has the advantage that the lead is the same in all gears. In Allan's motion (fig. 31) the change of gear is effected partly by shifting the link and partly by shifting a radius rod, and the link is straight.

69. *Graphic Solution of Link-Motion.*—The movement of a valve driven by a link-motion may be very fully and exactly analysed by drawing with the aid of a template the positions of the centre line of the link corresponding to a number of successive positions of the crank. Thus, in fig. 32, two circular arcs passing through *e* and *e'* are drawn with E and E' as centres and the eccentric rods are radii. These are loci of two known points of the link, and a third locus is the circle *a* in which the point of suspension must lie. By placing on the paper a template of the link, with these three points marked

on it, the position of the link is readily found, and by repeating the process for other positions of the eccentrics a diagram of positions (fig. 32) is drawn for the assigned state of the gear. A line AB drawn across this diagram in the path of the valve's travel determines the displacements of the valve, and enables the oval diagram to be drawn, which is shown to a larger scale in another part of fig. 32. The example refers to Stephenson's link-motion in nearly full forward gear; with obvious modification the same method may be used in the analysis of Gooch's or Allan's motion. The same

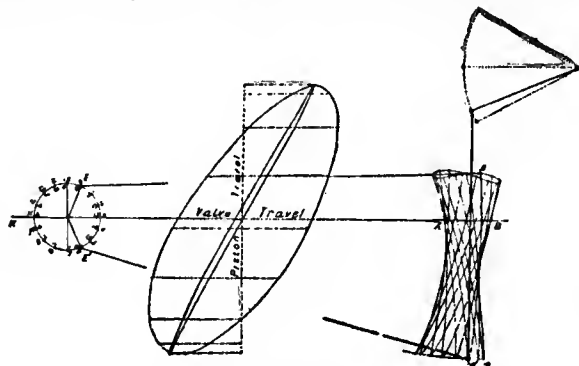

FIG. 32.

diagram determines the amount of slotting or sliding motion of the block in the link. In a well-designed gear this sliding is reduced to a minimum for that position of the gear in which the engine runs most usually. In marine engines the suspension-rod is generally connected to the link at the end of the link next the forward eccentric, to reduce this sliding when the engine is in forward gear.

70.—*Radial Gears.*—Many forms of gear for reversing and for varying expansion have been devised with the object of escaping the use of two eccentrics, and in some both eccentrics are dispensed with. Hackworth's gear, the parent of several others, to which the general name of radial gears is applied, has a single eccentric E (fig. 33) opposite the crank, with an eccentric-rod EQ, whose mean position is perpendicular to the travel of the valve. The rod ends in a block Q, which slides on a fixed inclined guide-bar or link, and the valve-rod receives its motion through a connecting rod from an intermediate point P of the eccentric-rod, the locus of which is an ellipse. To reverse the gear the guide-bar is tilted over to the position shown by the dotted lines, and intermediate inclinations give various degrees of expansion without altering the lead. The steam distribution is quite satisfactory, but an objection to the gear is the wear of the sliding-block and guide.

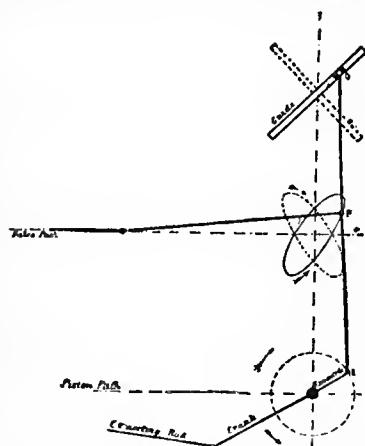

FIG. 33.—Hackworth's Valve-Gear.

In Bremme's or Marshall's form this objection is obviated with some loss of symmetry in the valve's motion by constraining the motion of the point Q, not by a sliding-guide, but a suspension-link, which makes the path of Q a circular arc instead of a straight line; to reverse the gear the centre of suspension R of this link is thrown over to the position R' (fig. 34). In the example sketched P is beyond Q, but P may be between Q and the crank (as in fig. 33), in which case the eccentric is set at 180° from the crank. This gear has been applied in a number of marine engines. In Joy's gear, which is extensively used in locomotives, no eccentric is required; and the rod corresponding to the eccentric rod in Hackworth's gear receives its motion from a point in the connecting rod by the linkage shown in fig. 35, and is either suspended, as in Marshall's form, by a rod whose suspension centre R is thrown over to reverse the motion, or constrained, as in Hackworth's, by a slot-guide whose inclination is reversed. Fig. 36 shows Joy's gear as applied to a locomotive. A slot-guide E is used, and it is curved to allow for the obliquity of the valve connecting-rod AE. C is the crank-pin, B the piston path and D a fixed centre.

A form of radial gear very largely used in locomotives, especially on the continent of Europe, is the Walschaert or Heusinger-Waldegge gear, in which the valve receives its motion in part from the piston cross-head through a reducing lever, and in part from a single eccentric set at right angles to the crank, which actuates a rocking link. Reversing is effected by shifting

a sliding block along this rocking link from one side to the other of the centre on which it rocks.

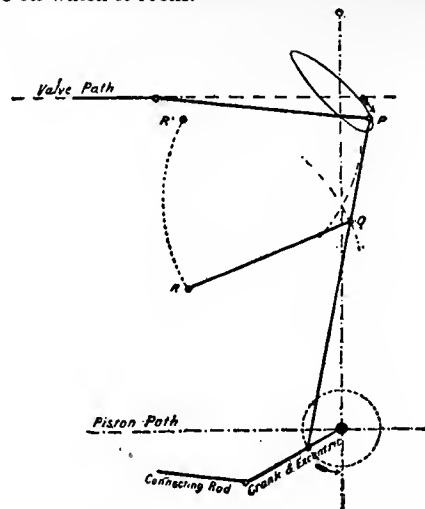

FIG. 34.—Bremme's or Marshall's Valve-Gear.

71. *Separate Expansion-Valves.*—When the distribution of steam is effected by the slide-valve alone the arc of the crank's motion during which compression occurs is equal to the arc during which expansion occurs, and for this reason the slide-valve would give an

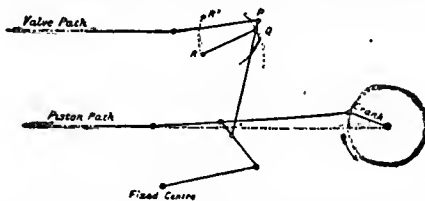

FIG. 35.—Diagram of Joy's Valve-Gear.

excessive amount of compression if it were made to cut off the supply of steam earlier than about half-stroke. Hence, where an early cut-off is wanted it is necessary either to use an entirely different means of regulating the distribution of steam, or to supplement the

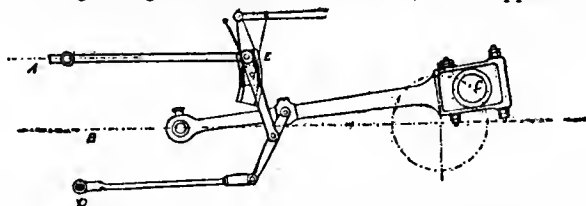

FIG. 36.—Joy's Gear as applied to a Locomotive.

slide-valve by another valve—called an expansion-valve, usually driven by a separate eccentric—whose function is to effect the cut-off, the other events being determined as usual by the slide-valve. Such expansion-valves belong generally to one or other of two types. In one the expansion-valve cuts off the supply of steam to the chest in which the main valve works.

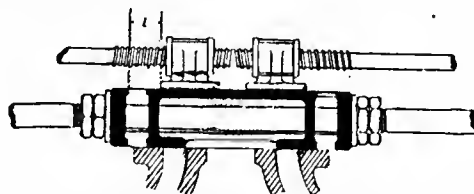

FIG. 37.—Expansion-Valve on back of Main Slide-Valve.

In the other the expansion-valve slides on the back of the main slide-valve, which is provided with through ports which the expansion-valve opens and closes. Fig. 37 shows one form of this type. Here the resultant relative motion of the expansion-valve and main-valve has to be considered. If r_a and r (fig. 38) are the eccentrics working the main and expansion valves respectively, then CR drawn equal and parallel to ME is the resultant eccentric which determines the motion of the expansion-valve relatively to the main-valve. Cut-off occurs at Q, when the shaft has turned through an

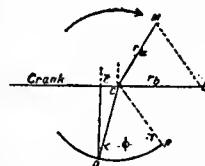

FIG. 38.

angle ϕ , which brings the resultant eccentric into the direction CQ and makes the relative displacement of the two valves equal to the distance l .

Expansion-valves furnish a convenient means of varying the expansion, which may be done by altering their lap, travel or angular advance. Alteration of lap, or rather of the distance l in the figures, is often effected by having the expansion-valve in two parts (as in fig. 37) and holding them on one rod by right- and left-handed screws respectively; by turning the valve-rod the parts are made to approach or recede from each other. In large valves the adjustment is more conveniently made by varying the travel of the valve, which is done by connecting it to its eccentric through a link which serves as a lever of variable length.

72. *Relief Rings.*—To relieve the pressure of the valve on the seat, large slide-valves are generally fitted with a steam-tight ring, which excludes steam from the greater part of the back of the valve. The ring fits steam-tight into a recess in the cover of the steam-chest, and is pressed by springs against the back of the valve, which is planed smooth to slide under the ring. Fig. 39 shows a relief ring of this kind fitted on the back of a large double-ported slide-valve for a marine engine. Another plan is to fit the ring into a recess on the back of the valve, and let it slide on the inside of the steam-chest cover. Steam is thus excluded from the space within the ring, any steam that leaks in being allowed to escape to the condenser (or to the intermediate receiver when the arrangement is fitted to the high-pressure cylinder of a compound engine). A flexible diaphragm has also been used, instead of a recess, to hold the ring.

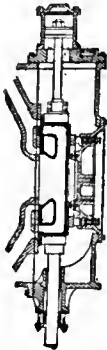

FIG. 39.

chest cover, which has recesses corresponding to the cylinder ports. This arrangement is most perfectly carried out in the piston slide-valves now

73. *Piston Slide-Valve.*—The pressure of valves on cylinder faces is still more completely obviated by making the back of the valve similar to its face, and causing the back to slide in contact with the valve-chest cover, which has recesses corresponding to the cylinder ports. This arrangement is most perfectly carried out in the very largely used in the high-pressure cylinders of marine engines. The piston slide-valve may be described as a slide-valve in which the valve face is curved to form a complete cylinder, round whose whole circumference the ports extend. The pistons are packed like ordinary cylinder pistons by metallic rings, and the ports are crossed here and there by diagonal bars to keep the rings from springing out as the valve moves over them. Fig. 40 shows a form of piston valve for the supply of high-pressure steam to a large marine engine. P, P are the cylinder ports.

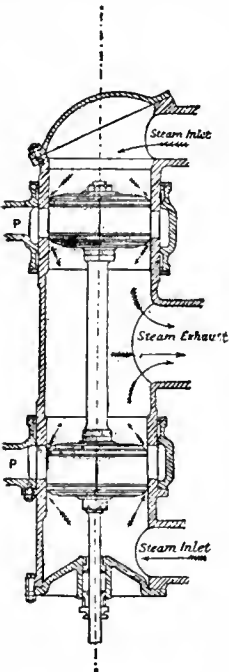

FIG. 40.—Piston Slide-Valve.

in which equilibrium is secured by the use of two conical faces which open or close together. In Cornish pumping engines, which retain the single action of Watt's early engine, three double-beat valves are used, as steam-valve, equilibrium-valve and exhaust-valve respectively. These are closed by tappets on a rod moving with the beam, but are opened by means of a device called a cataract, which acts as follows: The cataract is a small pump with a weighted plunger, discharging fluid through a stop-cock which can be adjusted by hand when it is desired to alter the speed of the engine. The weighted plunger is raised by a rod from the beam, but is free in its descent, so that it comes down at a rate depending on the extent to which the stop-cock is opened. When it comes down a certain way it opens the steam and exhaust valves, by liberating catches which hold them closed; the "out-door" stroke then begins and admission continues until the steam-valve is closed: this is done directly by the motion of the beam, which

also, at a later point in the stroke, closes the exhaust. Then the equilibrium-valve is opened, and the "in-door" stroke takes place, during which the plunger of the cataract is raised. When it is completed, the piston pauses until the cataract causes the steam-valve to open and the next "out-door" stroke begins. By applying a cataract to the equilibrium-valve also, a pause is introduced at the end of the "out-door" stroke. Pauses have the advantage of giving the pump time to fill and of allowing the pump-valves to settle in their seats without shock.

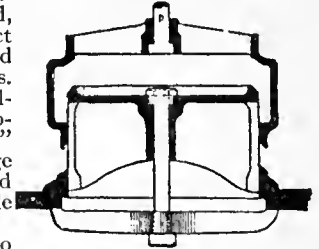

FIG. 41.—Double-Beat Lift Valve.

76. *Methods of Regulating.*—To make an engine run steadily an almost continuous process of adjustment must go on, by which the amount of work done by the steam in the cylinder is adapted to the amount of external work demanded of the engine. Even in cases where the demand for work is sensibly uniform, fluctuations in boiler-pressure still make regulation necessary. Generally the process of government aims at regularity of speed; occasionally, however, it is some other condition of running that is maintained constant, as when an engine driving a dynamo-electric machine is governed by an electric regulator to give a constant difference of potential between the brushes.

The ordinary methods of regulating are either (a) to alter the pressure at which steam is admitted by opening or closing more or less a throttle-valve between the boiler and the engine, or (b) to alter the volume of steam admitted to the cylinder by varying the point of cut-off. The former plan was introduced by Watt and is still common, especially in small engines. The second plan of regulating is generally preferred, especially when the engine is subject to large variations of load. Within certain limits regulation by either plan can be effected by hand, but for the finer adjustment of speed some form of automatic governor is necessary. Speed governors are commonly of the centrifugal type: a pair of masses revolving about a spindle which is driven by the engine are kept from flying out by a certain controlling force. When an increase of speed occurs this controlling force is no longer able to keep the masses revolving in their former path; they move out until the controlling force is sufficiently increased, and in moving out they act on the regulator of the engine, which may be a throttle-valve or some form of automatic expansion gear. In the conical pendulum governor of Watt (fig. 42) the revolving masses are balls attached to a vertical spindle by links, and the controlling force is furnished by the weight of the balls, which, in receding from the spindle, are obliged to rise. When the speed exceeds or falls short of its normal value they move out or in, and so raise or lower a collar c which is in connexion by a lever with the throttle-valve.

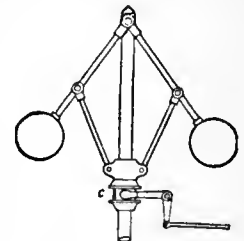

FIG. 42.—Watt's Governor.

77. *Loaded Governor.*—In a modified form, known as the loaded governor, a supplementary controlling force is given by placing a weight on the sliding collar (fig. 43). This is equivalent to increasing the weight of the balls without altering their mass. In other governors the controlling force is wholly or partly produced by springs. The use of springs to provide controlling force allows the axis of rotation to be horizontal, and governors of this class are frequently attached directly to the horizontal shaft in high-speed engines.

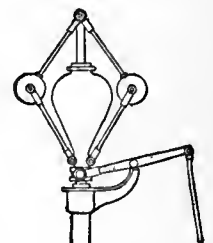

FIG. 43.—Loaded Governor.

78. *Equilibrium of Governor.*—In whatever way the revolving masses are controlled, the controlling force may be treated as a force F acting on each ball in the direction of the radius towards the axis of revolution. Then, if M be the mass of the ball, n the number of revolutions per second and r the radius of the ball's path, the governor will revolve in equilibrium when $F = 4\pi^2 n^2 r M$ (in absolute units), or

$$n = \frac{1}{2\pi} \sqrt{\frac{F}{Mr}}$$

In order that the configuration of the governor should be stable, F must increase more rapidly than r , as the balls move outwards. It is obvious that no stable governor maintains a strictly constant speed in the engine which it controls. If the boiler pressure or the demand for work is changed, a certain amount of permanent displacement of the balls is necessary to alter the steam-supply, and the balls can retain their displaced position only by virtue of a permanent change in the speed. The maximum range of speed depends on that amount of change of n which suffices to alter the configuration

of the governor from the position which gives no steam-supply to the position which gives full steam-supply, and the governor is said to be sensitive if this range is a small fraction of n .

To find the configuration which the governor will assume at any particular speed, or the speed corresponding to a particular configuration,

it is only necessary to determine the whole controlling force F per ball acting along the radius towards the axis for various values of r . Let a curve ab (fig. 44) be drawn showing the relation of F to r . At any assigned value of r set up an ordinate $QC = 4\pi^2 n^2 r M$. Join OC . The point c , in which OC cuts the curve, determines the value of r at which the balls will revolve at the assigned speed n . Or, if that is given, and the value of n is to be found, the line Oc produced will determine C , and then $n^2 = QC/4\pi^2 r M$. The sensibility of the governor is determined by taking points a and b corresponding to full steam and no steam respectively, and drawing lines through them to determine the corresponding values of QA and QB . When the frictional resistance f is known, an additional pair of curves drawn above and below ab , with ordinates $F + f$ and $F - f$ respectively, serve to show the additional variations in speed which are caused by friction. The governor is stable throughout its whole range when the curve ab has a steeper gradient than any line drawn from O to meet it.

79. *Isochronism*.—If, when the balls are displaced, the controlling force F changes proportionally to the radius r , the speed is constant. In other words, the equilibrium of the governor is then neutral; it can revolve in equilibrium at one, and only at one, speed. At this speed it assumes, indifferently, any one of its possible configurations.

opportunity is passed if the cut-off has already occurred, and the control only begins with the next stroke.

When the demand for power suddenly falls, the speed rises so much as to force the governor into a position of over-control, such that the supply of steam is no longer adequate to meet even the reduced demand for power. Then the speed slackens, and the same kind of excessive regulation is repeated in the opposite direction. A state of forced oscillation is consequently set up. The effect is aggravated by the momentum which the governor balls acquire in being displaced. Hunting is to be avoided by giving the governor a fair degree of stability, by reducing as far as possible the static frictional resistances, and by introducing a viscous resistance to the displacement of the governor, which prevents the displacement from occurring too suddenly, without affecting the ultimate position of equilibrium. For this purpose many governors are furnished with a *dash-pot*, which is a hydraulic or pneumatic brake, consisting of a piston connected to the governor, working loosely in a cylinder which is filled with oil or with air.

80. *Regulation by the Governor of the Steam-Supply: Throttle-Valve*.—The throttle-valve, as introduced by Watt, was originally a disk turning on a transverse axis across the centre of the steam-pipe. It is now usually a double-beat valve or a piston-valve. When regulation is effected by varying the cut-off, and an expansion-valve of the slide-valve type is used, the governor generally acts by changing the travel of the valve. In other forms of automatic expansion-gear the lap of the valve is altered; in others the governor acts by shifting the expansion-valve eccentric round on its shaft, and so changing its angular advance.

81. *Trip-Gear*.—In large stationary engines the most usual plan of automatically regulating the expansion is to employ some form of

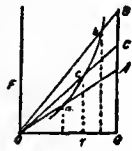

FIG. 44.

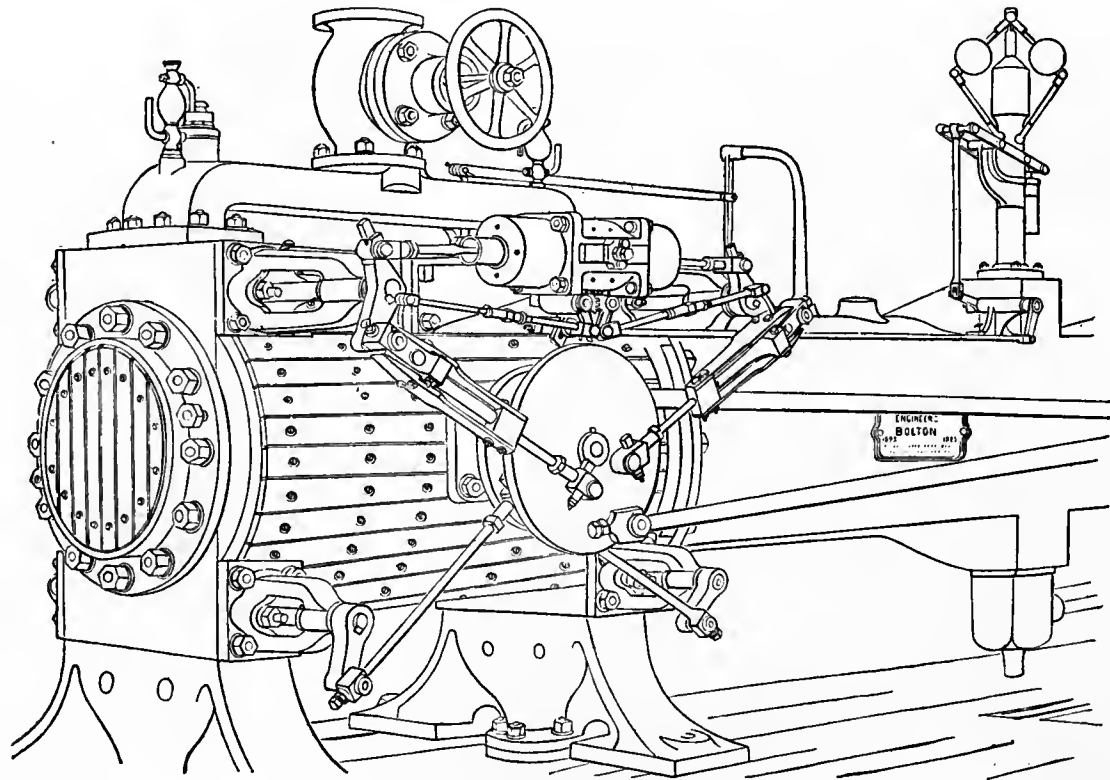

FIG. 45.—Corliss Engine, with Spencer Inglis Trip-Gear.

The slightest variation of speed drives it to the extremity of its range; hence its sensibility is indefinitely great. Such a governor is called *isochronous*. Where springs furnish the controlling force, an approach to isochronism can be secured by adjusting the initial tension of the springs, and this forms a convenient means of regulating the sensibility.

But in practice no governor can be absolutely isochronous. It is indispensable to leave a small margin of stability for the sake of preventing violent change in the supply of steam, especially when there is much frictional resistance to be overcome by the governor, or where the influence of the governor takes much time to be felt by the engine. An over-sensitive governor is liable to fall into a state of oscillation called *hunting*. When an alteration of speed begins to be felt, however readily the governor alters its form, the engine's response is more or less delayed. If the governor acts by closing a throttle-valve, the engine has still a capacious valve-chest on which to draw for steam. If it acts by changing the cut-off, its

trip-gear, the earliest type of which was introduced in 1849 by G. H. Corliss (1817–1888), of Providence, U.S.A. In the Corliss system the valves which admit steam are distinct from the exhaust-valves. The latter are opened and closed by a reciprocating piece which takes its motion from an eccentric. The former are opened by a reciprocating piece, but are closed by springing back when released by a trip- or trigger-action. The trip occurs earlier or later in the piston's stroke according to the position of the governor. The admission-valve is opened by the reciprocating piece with equal rapidity whether the cut-off is going to be early or late. It remains wide open during the admission, and then, when the trip-action comes into play, it closes suddenly. The indicator diagram of a Corliss engine consequently has a nearly horizontal admission-line and a sharply defined cut-off. Generally the valves of Corliss engines are cylindrical plates turning in hollow cylindrical seats which extend across the width of the cylinder. Often, however, the admission-valves in trip-gear engines are of the disk or double-beat type, and spring into their seats when

the trip-gear acts. Messrs Sulzer have developed this type with much success. Many forms of trip-gear have been invented by Corliss himself and by others. One of these, the Spencer Inglis trip-gear, by Messrs Hick, Hargreaves & Co., is shown in figs. 45 and 46. A wrist-plate A, which turns on a pin on the outside of the cylinder, receives a motion of oscillation from an eccentric. It opens the cylindrical rocking-valve B by pulling the link C, which consists of two parts, connected to each other by a pair of spring clips *a, a*. Between the clips there is a rocking-cam *b*, and as the link is pulled down this cam places itself more and more athwart the link, until at a certain point it forces the clips open. Then the upper part of the link springs back and allows the valve B to close by the action of a spring in the dash-pot D. When the wrist-plate makes its return stroke the clips re-engage the upper portion of the link C, and things are ready for the next stroke. The rocking-cam *b* has its position controlled by the governor through the link E in

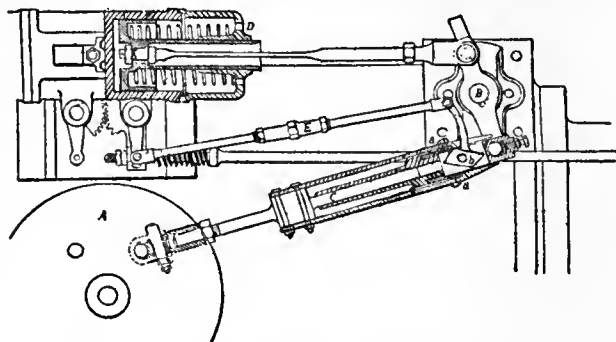

FIG. 46.—Corliss Valve-Gear, Spencer Inglis form.

such a way that when the speed of the engine increases it stands more athwart the link C, and therefore causes the clips to be released at an earlier point in the stroke. A precisely similar arrangement governs the admission of steam to the other end of the cylinder. The exhaust-valves are situated at the bottom of the cylinder, and receive an oscillating motion from a separate wrist-plate, behind A.

82. *Use of Flywheel.*—Besides those variations of speed which occur from stroke to stroke, which it is the business of the governor to check, there are variations within each single stroke due to the varying rate at which work is done on the crank-shaft during its revolution. To limit these is the function of the flywheel, which acts by forming a reservoir of energy to be drawn upon during those parts of the revolution in which the work done on the shaft is less than the work done by the shaft, and to take up the surplus in those parts of the revolution in which the work done on the shaft is greater than the work done by it. This alternate storing and restoring of energy is accomplished by slight fluctuations of speed, whose range depends on the ratio which the alternate excess and defect of energy bears to the whole stock the flywheel holds in virtue of its motion. The effect of the flywheel may be studied by drawing a diagram of crank-effort, which shows the work done on the crank in the same way that the indicator diagram shows the work done on the piston. The same diagram serves another useful purpose in determining the twisting and bending stress in the crank.

The diagram of crank-effort is drawn by representing, in rectangular co-ordinates, the relation between the moment which the connecting-rod exerts to turn the crank and the angle turned through by the crank. The moment exerted to turn the crank is readily found when the direction and magnitude of the thrust exerted by the connecting-rod on the crank-pin is known for successive points in the revolution.

83. *Influence of the Inertia of the Reciprocating Masses.*—This thrust depends not only on the resultant pressure of the steam on the piston but also on the inertia of the reciprocating masses. The mass of the piston, piston-rod, cross-head, and to some extent that of the connecting-rod also, has to be started and stopped in each half revolution, and in high-speed engines the forces concerned in this action are so large as to affect most materially not only the distribution of crank-effort but also the stresses which the various parts have to be proportioned to bear. The calculation of the stresses due to inertia in high-speed engines consequently forms an essential part of engine design. Taking *M* to represent the whole reciprocating mass, and *a* its acceleration at any instant in the direction of the piston's motion, the force required to produce this acceleration is *Ma/g*, and this quantity has to be deducted from the resultant pressure of the steam in finding the effective thrust. The effect is to reduce the effective thrust at the beginning of the stroke and to increase it at the end. The greatest acceleration *a* occurs in the extreme position of the piston, most distant from the crank-shaft centre, and its value there is $4\pi^2 n^2 r(1 + r/l)$ where *r* is the radius of the crank, *l* the length of the connecting-rod and *n* the number of turns per second. When the piston is in the other extreme position, nearest to the shaft, the value of *a* is $4\pi^2 n^2 r(1 - r/l)$. The exact calculation of inertia effects for the connecting-rod is com-

plicated, but its influence on the thrust is approximately found by treating the mass of the rod as divided into two parts, one of which moves with the cross-head and is therefore an addition to the reciprocating system, while the other moves with the crank-pin and is therefore an addition to the revolving system. The mass may be divided for this purpose into parts which are inversely proportional to the distances of the centre of gravity from the cross-head and crank-pin respectively. By combining diagrams of the steam thrust and of the forces due to inertia a diagram is obtained showing the true thrust throughout the stroke. Fig. 47 gives an example: there the line *ab* is drawn to show the inertia forces for an engine in which the connecting-rod has $3\frac{1}{2}$ times the length of the crank. The straight line *cd* shows what the inertia force would be if the connecting-rod were treated as being so long that the deviation from simple-harmonic motion might be neglected.

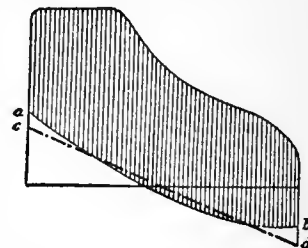

FIG. 47.

The inertia of the reciprocating parts imposes a limit on the lightness of engines of the piston and cylinder type. The proportion of weight to power is reduced by increasing mean piston speeds, but this process cannot be carried beyond a point at which the forces due to inertia become so great as to produce unsafely high alternating stresses in the piston-rods and other parts. In some torpedo-boat destroyers, where the reduction of weight has been carried as far as is practicable, the mean piston speed approaches 1200 ft. per minute with nearly 400 revolutions per minute and an 18-in. stroke. These engines develop 6000 h.p., and the weight of engines and boiler together is only 50 lb per indicated h.p. Such a figure is, however, to be regarded as exceptional; weights of 150 to 200 lb per h.p. are more usual even in conditions like those of high-speed cruisers where saving of weight is specially desirable.

84. *Balancing.*—Another aspect in which the inertia of the reciprocating parts is important is in regard to the balancing of the engine as a whole. Any forces required to accelerate the piston and its attached parts produce reaction on the frame and bed-plate of the engine, which will set up vibrational disturbances in the foundations and ground or the supporting structure. The object of balancing is to group the masses in such a manner that their inertia effects more or less neutralize one another. This is especially important in marine engines, where massive foundations are absent and where it may happen that the periodic impulses due to want of balance find some portion of the hull free to respond synchronously with vibrations so violent as to be inconvenient and even dangerous. Even in land engines a want of balance causes enough vibration to constitute a serious nuisance in the neighbourhood.

85. In considering the question of balance, the system of eccentrically revolving masses and the system of reciprocating masses have to be considered separately. A reciprocating mass such as a piston cannot be balanced by the use of revolving masses, for the forces which are due to the inertia of the piston necessarily act along the line of its stroke, while those due to revolving masses are continually changing their direction. The inertia of each connecting-rod may be approximately treated by resolving its mass into two constituents, one of which moves with the crank-pin, and is therefore an addition to the revolving system, while the other moves with the cross-head, and is therefore an addition to the reciprocating system. The mass of the rod may be divided for this purpose into parts which are inversely proportional to the distances of its centre of gravity from the crank-pin and the cross-head respectively. Let *M*₁, *M*₂, *M*₃, &c., represent the various revolving masses *r*₁, *r*₂, *r*₃, &c., their effective radii of rotation, and *a*₁, *a*₂, *a*₃, &c., their distances from any assumed plane of reference taken perpendicular to the shaft. Then the conditions necessary for balance amongst them are that the vector sum of *M r* shall vanish, and also that the vector sum of *M a r* shall vanish, this latter quantity being the resultant of the moments of the centrifugal forces with respect to the plane of reference. In a four-crank engine there is no serious difficulty in arranging the revolving masses in such a manner that these conditions shall be satisfied, so far as those masses are concerned. The problem, as Professor W. E. Dalby has shown, lends itself readily to graphical treatment (see his treatise on *Balancing of Engines*). With respect to the reciprocating masses, a first approximation towards balance is attained by satisfying the conditions which would secure balance if the motions were simply harmonic. These conditions are identical with those which have just been stated for the revolving masses, when *r* is interpreted as the semi-amplitude of the harmonic motion. When the conditions in question are satisfied, the only remaining source of disturbance is that which comes from the fact that the reciprocating masses are connected to the cranks by rods of finite length; in other words, that the motions are not simply harmonic. For this reason the force required to accelerate each piston is greater when the piston is at the end of the stroke farthest from the shaft than when it is at the other end, and consequently the balance, which would be perfect if the connecting-rods were

indefinitely long, is disturbed by the presence of forces which vary periodically with a frequency twice that of the rotation. When three cranks, 120° apart, are employed, it will be found that the effect of the shortness of the connecting-rods in causing forces to act in the line of the stroke is reduced to a couple tending to tilt the engine in a fore and aft direction, which may in its turn be balanced by using a second set of three cranks on the same shaft, the second set being so arranged that the couple to which it gives rise neutralizes the couple due to the first set. A six-crank engine may be arranged in this way to secure an extremely close approximation to perfect balance, and the same state of balance can be secured when the number of cranks is reduced to five.

86. The most usual arrangement adopted in marine engines, when questions of balance are taken into account, is to have four cranks, and consequently four sets of reciprocating masses. In the "Yarrow-Schlick-Tweedy" system of balancing engines four cranks are employed, and by adjusting the relative weights of the four pistons, as well as their distances apart, and by selecting suitable angles for the relative positions of the cranks (differing somewhat from 90°), a close approximation to complete balance is obtained. In triple expansion this arrangement is readily applied when two low-pressure cylinders are used instead of one, the steam from the intermediate cylinder being divided between them, and it is also of course applicable to quadruple expansion engines.

87. In this connexion mention may be made of a type of engine which has been used in various electric power stations, especially in America, in which a revolving mass might be employed to balance completely the inertia effects of two pistons. This is a compound engine in which the cylinders stand at right angles to one another, one being horizontal and the other vertical. If the piston masses were made equal it is clear that the inertia effect of a revolving mass could be resolved into two components which would balance both. It does not appear, however, that advantage has been taken of this property in the design of actual engines of this type. In the London County Council power station at Greenwich, where the engines are of this class, the unbalanced effects of inertia are so considerable as to affect the instruments at the Observatory half a mile away. One of the conspicuous merits of the steam turbine is that it avoids the use of reciprocating parts and so escapes the inconveniences and limitations to which the inertia of reciprocating parts gives rise.

88. *Types of Engine.*—In classifying engines with regard to their general arrangement of parts and mode of working, account has to be taken of a considerable number of independent characteristics. We have first a general division into *condensing* and *non-condensing* engines, with a subdivision of the condensing class into those which act by surface condensation and those which use injection. Next there is the division into *compound* and *non-compound*, with a further classification of the former as double-, triple- or quadruple-expansion engines. Again, engines may be classed as *single* or *double-acting*, according as the steam acts on one or alternately on both sides of the piston. Again, a few engines—such as steam hammers and certain kinds of steam pumps—are *non-rotative*, that is to say, the reciprocating motion of the piston does work simply on a reciprocating piece; but generally an engine does work on a continuously revolving shaft, and is termed *rotative*. In most cases the crank-pin of the revolving shaft is connected directly with the piston-rod by a connecting-rod, and the engine is then said to be *direct-acting*; in other cases, of which the ordinary beam engine is the most important example, a lever is interposed between the piston and the connecting-rod. The same distinction applies to non-rotative pumping engines, in some of which the piston acts directly on the pump-rod, while in others it acts through a beam. The position of the cylinder is another element of classification, giving *horizontal*, *vertical* and *inclined cylinder* engines. Many vertical engines are further distinguished as belonging to the *inverted cylinder* class; that is to say, the cylinder is above the connecting-rod and crank. In *oscillating cylinder* engines the connecting-rod is dispensed with; the piston-rod works on the crank-pin, and the cylinder oscillates on trunnions to allow the piston-rod to follow the crank-pin round its circular path. In *trunk* engines the piston rod is dispensed with; the connecting-rod extends as far as the piston, to which it is jointed, and a trunk or tubular extension of the piston, through the cylinder cover, gives room for the rod to oscillate. In *rotary* engines there is no piston in the ordinary sense; the steam does work on a revolving piece, and the necessity is thus avoided of afterwards converting reciprocating into rotary motion. *Steam turbines* may, in one sense, be regarded as an extreme

development of the rotary type; but they are distinct from all other steam engines in this that their action depends on the kinetic energy of the steam.

89. *Beam Engines.*—In the single-acting atmospheric engine of Newcomen the beam was a necessary feature; the use of water-packing for the piston required that the piston should move down in the working stroke, and a beam was needed to let the counterpoise pull the piston up. Watt's improvements made the beam no longer necessary; and in one of the forms he designed it was discarded—namely, in the form of pumping engine known as the Bull engine, in which a vertical inverted cylinder stands over and acts directly on the pump-rod. But the beam type was generally retained by Watt, and for many years it remained a favourite with builders of engines of the larger class. The beam formed a convenient driver for pump-rods and valve-rods; and the parallel motion (*g.v.*) invented by Watt as a means of guiding the piston-rod, which could easily be applied to a beam engine, was, in the early days of engine-building, an easier thing to construct than the plane surfaces which are the natural guides of the piston-rod in a direct-acting engine. In modern practice the direct-acting type has to a very great extent displaced the beam type. For mill-driving and the general purposes of a rotative engine the beam type is now rarely chosen. In pumping engines it is somewhat more common, but even there the direct-acting forms are generally preferred.

90. *Direct-Acting Engines.*—Of direct-acting engines the horizontal type has in general the advantage of greater accessibility, but the vertical economizes floor space. In small forms the engine is generally self-contained, that is to say, a single frame or bedplate carries all the parts including the main bearings in which the crank-shaft with its flywheel turns. The frame often takes what is called a girder shape, which brings a portion of it into a favourable position for taking the thrust between the cylinder and the crank-shaft bearings and allows two surfaces to be formed on the frame to serve as guides for the cross-head. When a condenser is used with a horizontal engine it is usually placed behind the cylinder, and the air-pump, which is within the condenser, has a horizontal plunger or piston on a "tail-rod" or continuation of the main piston-rod through the back cover of the cylinder. In large horizontal engines the condenser generally stands in a well below, and its pump, which is vertical, is driven by means of a bell-crank lever attached by a link to the engine cross-head.

91. *Coupled Engines.*—When uniformity of driving effort or the absence of dead points is important, two independent cylinders often work on the same shaft by cranks at right angles to each other. Such engines, which are called "coupled," can start readily from any position; the ordinary locomotive engine is an example. Winding engines for mines and collieries, in which ease of starting, stopping and reversing is essential, are very generally made by coupling a pair of cylinders on opposite sides of the winding drum with link motions as the means of operating the valves.

92. *Compound Engines, Coupled or Tandem.*—Large direct-acting engines are usually compounded either by having a high- and a low-pressure cylinder side by side, with cranks at right angles, or by putting one cylinder behind the other with the axes of both in the same line. The latter is called the *tandem* arrangement. In a tandem engine, since the pistons agree in phase, the steam may expand directly from the small into the large cylinder. But the connecting-pipe and steam chest form a receiver of considerable size, and to avoid loss by "drop" the supply of steam to the large cylinder is cut off long before the end of the stroke. For mill engines the compound tandem and compound coupled types of engine are the most usual. The high-pressure cylinder is very generally fitted with Corliss or other trip-gear.

93. *Jet and Surface Condensation.*—In land engines using condensation the jet form of condenser is common, but surface condensation is resorted to when the available water-supply is unsuited for boiler feed. When there is no large supply of condensing water a very fair vacuum can be obtained by using

an *evaporative condenser*, consisting of a stack of pipes into which the exhaust steam is admitted and over which a small amount of cooling water is allowed to drip. This water is evaporated by the heat which is extracted in condensing the steam within. Such a condenser is placed in the open, generally on a roof where the air has free access. The amount of water it uses need not exceed the amount of steam that is condensed, and is therefore a very small fraction of the amount required in a jet or surface condenser.

94. *High-Speed Direct-Acting Engines.*—Prior to the advent of the steam turbine the demand for engines suitable for driving electric generators without the intervention of a belt led to the introduction of various forms of direct-acting engine adapted to run at a high speed. Some of these were *single acting*, steam being admitted to one side of the piston only, generally the back, with the result that the rods could be kept in a state of thrust throughout the revolution, and alternations of stress in them and at the joints thereby avoided, together with the knocking and wear of the bearing brasses which it is apt to cause. To secure, however, that the connecting-rod should always push and never pull against the crank-pin there had to be much cushioning during the out stroke on account of the fact that from about the middle of that stroke to the end the reciprocating mass was being retarded. In engines designed by P. W. Willans, which were highly successful examples of this class, the cushioning was provided by means of a supplementary piston which compressed air during the out stroke; the energy which the reciprocating masses had to part with in losing their motion during the second half of the out stroke was stored in this air and was restored in the succeeding down stroke.

Willans obtained compound or triple expansion by mounting two or three cylinders in tandem in a vertical line, with the air-compressing piston below them in the form of a trunk which served also as a guide for the cross-head. The piston-rod was hollow and within it there was a valve rod carrying piston valves for the admission and release of the steam. The valve rod was worked by an eccentric on the crank-pin which gave it the proper relative motion with respect to the hollow piston within which it works. The engine was entirely enclosed in a casing the bottom of which formed an oil bath in which the cranks splashed to ensure ample lubrication. These engines for a time had much vogue and gave good results. Many of them are in use in electric light stations and elsewhere, but the tendency now is to use turbines for this class of work, and even in cases where reciprocating engines are preferred they are now more usually of the double-acting type, which has the advantage of giving a greater output of power for the same weight.

95. *Double-Acting High-Speed Engines.*—Of double-acting high-speed engines an interesting form is that of Messrs Belliss and Morcom, the chief distinctive feature of which is the use of forced lubrication at the pin joints and shaft bearings. In a double-acting engine, where the thrust acts alternately on one and the other side of the crank-pins and cross-head pins, high frequency of stroke tends to produce much knocking and wear unless the brasses are very closely adjusted, and in that case the pins are liable to get hot, and to "seize" by expanding sufficiently to fill the small clearance. This difficulty, which exists when lubrication is carried out in the ordinary way, is overcome in the Belliss engine by feeding the bearings with a continuous supply of oil, which is pumped in under a pressure of about 15 lb per sq. in. The presence of a film of oil is thereby continuously secured, and knocking is prevented although the brasses are not set very close. Notable examples in which double action is combined with a relatively high frequency of stroke are found in naval engineering practice, especially in the engines of high-speed cruisers and torpedo-boat destroyers. As a rule these engines employ triple expansion with four cranks and four cylinders, the third stage of the expansion being performed in two cylinders, which divide the steam between them. But in this field also the steam turbine is rapidly displacing the reciprocating type.

96. *Pumping Engines.*—In engines for pumping or for

blowing air it is not essential to drive a revolving shaft, and in many forms the reciprocating motion of the steam piston is applied directly or through a beam to produce the reciprocating motion of the pump-piston or plunger. On the other hand, pumping engines are frequently made rotative for the sake of adding a flywheel.

Fig. 48 shows a compound inverted vertical pumping engine of the non-rotative class by Messrs Hathorn, Davey & Co. Steam is distributed through lift valves, and the distribution

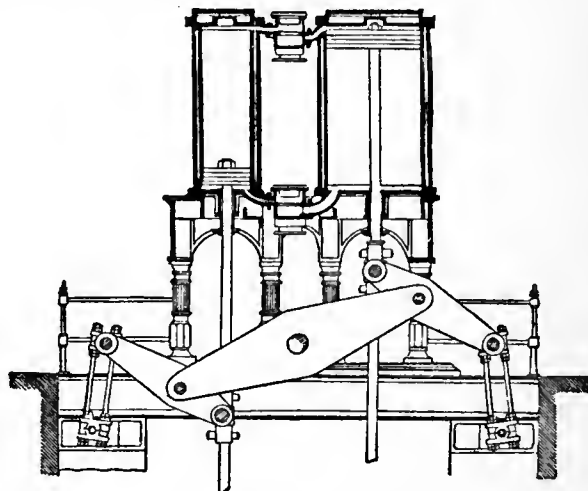

FIG. 48.—Vertical Non-Rotative Pumping Engine.

of steam is controlled by means of a cataract, which makes the pistons pause at the end of each stroke. The pistons are in line with two pump-rods, and are coupled by an inverted beam which gives guidance to the cross-heads by means of an approximate straight-line motion. Engines of this kind, like the old Cornish pump, are able to work expansively against a uniform resistance without a flywheel in consequence of the great inertia of the reciprocating pieces which include long massive pump-rods. Notwithstanding the low frequency of the strokes, enough energy is stored in the moving rods to counterbalance the inequalities of steam thrust, and the rate of acceleration of the system adjusts itself to give, at the plunger end, the nearly uniform effort which the pump requires. In other words, the motion, instead of being almost simple harmonic as it is in rotative engines, is such that the form of the inertia curve when drawn as in fig. 47 is nearly the same as that of the steam curve, with the result that the distance between the two, which represents the net effort on the pump-plunger, is nearly constant. The massive pump-rods act in such a way as to form a reciprocating equivalent of a flywheel.

97. It is, however, only to deep well pumping that this applies, and a very numerous class of direct-acting steam pumps have too little mass in their reciprocating parts to allow such an adjustment to take place. A familiar example is the small donkey pump used for feeding boilers, in which the steam-piston and pump-plunger are on one and the same rod. In some of these pumps a rotative element is introduced, partly to secure steadiness of working and partly for convenience in working the valves. But many pumps of this class are entirely non-rotative, and in such cases the steam is generally admitted throughout the stroke without expansion. In some of them the valve is worked by tappets from the piston-rod. In the Blake steam pump a tappet worked by the piston as it reaches each end of its stroke throws over an auxiliary steam-valve, which admits steam to one or other side of an auxiliary piston carrying the main slide-valve.

98. *Worthington Engines.*—In the Worthington pumping engine two steam cylinders are placed side by side, each working its own pump-piston. The piston-rod of each is connected by a short link to a swinging bar, which actuates the slide-valve of the other steam cylinder. In this way one piston begins its stroke when the motion of the other is about to cease, and a

smooth and continuous action is secured. These engines have been extensively applied, on a large scale, to raise water for the supply of towns and to force oil through "pipe-lines" in the United States. In the larger sizes they are made compound, each high-pressure cylinder having a low-pressure cylinder tandem with it on the same rod. To allow of expansive working a device is added which compensates for the inequality of effort

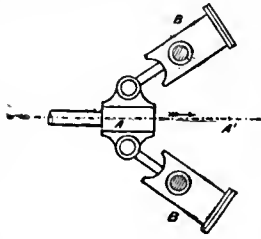

FIG. 49.

resulting from an early cut-off. A cross-head *A* (fig. 49) fixed to each of the piston-rods is connected to the piston-rods of a pair of oscillating cylinders *B, B*, which contain water and communicate with a reservoir full of air compressed to a pressure of about 300 lb per square inch. When the stroke (which takes place in the direction of the arrow) begins the pistons are at first forced in, and work is at first done by the main piston-rod, through the compensating cylinders *B, B*, on the compressed air in the reservoir. This continues until the cross-head has advanced so that the cylinders stand at right angles to the line of stroke. Then for the remainder of the stroke the compensating cylinders assist in driving the main piston, and the compressed air gives out the energy which it stored in the earlier portion. The volume of the air reservoir is so much greater than the volume of the cylinders, *B, B*, that the air pressure remains nearly constant throughout the stroke. Any leakage from the cylinder or reservoir is made good by a small pump which the engine drives.

99. *Pulsometer*.—Hall's "pulsometer" is a peculiar pumping engine without cylinder or piston, which may be regarded as the modern representative of the engine of Savery. The sectional view, fig. 50, shows its principal parts. There are two chambers *A, A'*, narrowing towards the top, where the steam-pipe *B* enters. A ball-valve *C* allows steam to pass into one of the chambers and closes the other. Steam entering (say) the right-hand chamber forces water out of it past the clack-valve *V* into a delivery passage *D*, which is connected with an air-vessel. When the water level in *A* sinks so far that steam begins to blow through the delivery passage, the water and steam are disturbed and so brought into intimate contact, the steam in *A* is condensed, and a partial vacuum is formed. This causes the ball-valve *C* to

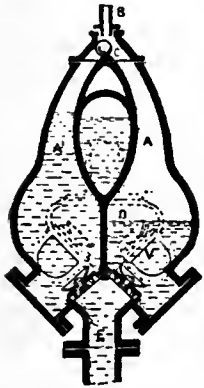

FIG. 50.—Pulsometer.

rock over and close the top of *A*, while water rises from the suction-pipe *E* to fill that chamber. At the same time steam begins to enter the other chamber *A'*, discharging water from it, and the same series of actions is repeated in either chamber alternately. While the water is being driven out there is comparatively little condensation of steam, partly because the shape of the vessel does not promote the formation of eddies, and partly because there is a cushion of air between the steam and the water. Near the top of each chamber is a small air-valve opening inwards, which allows a little air to enter each time a vacuum is formed. When any steam is condensed, the air mixed with it remains on the cold surface and forms a non-conducting layer. The pulsometer is, of course, far from efficient as a thermodynamic engine, but its suitability for situations where other steam-pumps cannot be used, and the extreme simplicity of its working parts, make it valuable in certain cases.

100. *Rotary Engines*.—From the earliest days of the rotative engine attempts have been made to avoid the intermittent reciprocating motion which an ordinary piston engine first produces and then converts into motion of rotation. Murdoch, the contemporary of Watt, proposed an engine consisting of a

pair of spur-wheels gearing with one another in a chamber through which steam passed by being carried round the outer sides of the wheels in the spaces between successive teeth.

In Dudgeon's wheel engine the steam was admitted by ports in side-plates into the clearance space behind teeth in gear with one another, just after they had passed the line of centres. From that point to the end of the arc of contact the clearance space increased in volume; and it was therefore possible, by stopping the admission of steam at an intermediate point, to work expansively. The difficulty of maintaining steam-tight connexion between the teeth and the side-plates on which the faces of the wheels slide is obvious; and the same difficulty has prevented the success of many other forms of rotary engine. These have been devised in immense variety, in many cases, it would seem, with the idea that a distinct mechanical advantage was to be secured by avoiding the reciprocating motion of a piston. In point of fact, however, very few forms entirely escape having pieces with reciprocating motion. In all rotary engines, with the exception of steam turbines—where work is done not by pressure but by the kinetic impulse of steam—there are steam chambers which alternately expand and contract in volume, and this action usually takes place through a more or less veiled reciprocation of working parts. So long as engines work at a moderate speed there is little advantage in avoiding reciprocation; the alternate starting and stopping of piston and piston-rod does not affect materially the frictional efficiency, throws no deleterious strain on the joints, and need not disturb the equilibrium of the machine as a whole. The case is different when very high speeds are concerned; it is then desirable as far as possible to limit the amount of reciprocating motion and to reduce the masses that partake in it.

101. *Types of Marine Engines*.—The early steamers were fitted with paddle-wheels, and the engines used to drive them were for the most part modified beam engines. Bell's "Comet" was driven by a species of inverted beam engine, and another form of inverted beam, known as the *side-lever* engine, was for long a favourite with marine engineers. In the side-lever engine the cylinder was vertical, and the piston-rod projected through the top. From a crosshead on the rod a pair of links, one on each side of the cylinder, led down to the ends of a pair of horizontal beams or levers below, which oscillated about a fixed gudgeon at or near the middle of their length. The two levers were joined at their other ends by a cross-tail, from which a connecting-rod was taken to the crank above. The side-lever engine is now obsolete. In American practice, engines of the beam type, with a braced-beam supported on *A* frames above the deck, are still common in river-steamers and coasters. An old form of direct-acting paddle-engine was the *steeple* engine, in which the cylinder was set vertically below the crank. Two piston-rods projected through the top of the cylinder, one on each side of the shaft and of the crank. They were united by a crosshead sliding in vertical guides, and from this a return-connecting-rod led to the crank. Modern paddle-wheel engines are usually of one of the following types. (1) In *oscillating cylinder* engines the cylinders are set under the crank-shaft, and the piston-rods are directly connected to the cranks. The cylinders are supported on trunnions which give them the necessary freedom of oscillation to follow the movement of the crank. Steam is admitted through the trunnions to slide-valves on the sides of the cylinders. In some instances the mean position of the cylinders is inclined instead of vertical; and oscillating engines have been arranged with one cylinder before and another behind the shaft, both pistons working on one crank. The oscillating cylinder type is best adapted for what would now be considered comparatively low pressures of steam. (2) *Diagonal* engines are direct-acting engines of the ordinary connecting-rod type, with the cylinders fixed on an inclined bed and the guides sloping up towards the shaft.

When the screw-propeller began to take the place of paddle-wheels in ocean steamers, the increased speed which it required was at first supplied by using spur-wheel gearing in conjunction with one of the forms of engines then usual in paddle steamers

After a time types of engine better suited to the screw were introduced, and were driven fast enough to be connected directly to the screw-shaft. The smallness of the horizontal space on either side of the shaft formed an obstacle to the use of horizontal engines, but this difficulty was overcome in several ways. In Penn's *trunk* engine, now obsolete, the engine was shortened by attaching the connecting-rod directly to the piston, and using a hollow piston-rod, called a trunk, large enough to allow the connecting-rod to oscillate inside it. The *return-connecting-rod* engine was another horizontal form at one time used in the British navy. It was a steeple engine placed horizontally, with two, and in some cases four, piston-rods in each cylinder. The piston-rods passed clear of the shaft and the crank, and were joined beyond it in a guided crosshead, from which a connecting-rod returned.

102. *Inverted Vertical Engines*.—Both in the navy and in merchant ocean steamers one general type of engine is universal, where the reciprocating engine has not yet been displaced by the steam turbine. This is the inverted vertical direct-acting engine, with two or more cylinders placed side by side directly over the shaft. Two, three and four cranks are employed, the arrangement with four cranks being specially suitable, as has already been pointed out, when the balance of the engine at high speeds has to be secured. As a rule naval engines are triple compound, and those of merchant vessels either triple or quadruple. In vessels of high speed and power the engines are arranged in twin sets, on two shafts with twin screw propellers.

The marine engine is always furnished with a surface condenser, consisting of a multitude of brass tubes about $\frac{3}{4}$ in. in diameter cooled by sea-water which is caused to circulate through the condenser by means of a circulating pump. This pump and also the air pump are often driven independently of the main engine.

103. It is in marine practice that the largest examples of engines are to be found. The triple expansion engines of the "Campania" and "Lucania," which develop 30,000 h.p., consist of twin sets, on two shafts, each set having three cranks and five cylinders, two of 37 in., one of 79 in. and two of 98 in. diameter, with a stroke of 69 in. In the "Kaiser Wilhelm der Grosse" engines of the same power are arranged in twin sets, each set consisting of four cylinders, one of 52 in. diameter, one of 89 and two of 96.4, the four giving triple expansion and working on four cranks. The "Deutschland" develops 36,000 h.p. with twin sets, each of which comprises two 36.6-in. cylinders, one 73.6-in., one 103.9-in. and two 106.3-in. with a stroke of 72.8 in. In the "Kaiser Wilhelm II." each of the twin shafts is driven by two 3-crank 4-cylinder quadruple expansion engines, the diameters being 37.4, 49.2, 74.8 and 112.2 in. and a stroke of 70.9 in. With a working pressure of 225 lb per square inch these engines develop in all 40,000 h.p. These are examples of the most powerful reciprocating engines used in the propulsion of ships, but the successful application of the Parsons turbine to marine use has enabled even these powers to be greatly surpassed.

104. *Locomotive Engines*.—The ordinary locomotive consists of a pair of direct-acting horizontal or nearly horizontal engines, fixed in a rigid frame under the front end of the boiler, and coupled to the same shaft by cranks at right angles, each with a single slide-valve worked by a link-motion, or by a form of radial gear. The engine is non-condensing, except in a very few special cases, and the exhaust steam, delivered at the base of the funnel through a blast-pipe, serves to produce a draught of air through the furnace. In some instances a portion of the exhaust steam, amounting to about one-fifth of the whole, is diverted to heat the feed-water. In tank engines the feed-water is carried in tanks on the engine itself; in other engines it is carried behind in a tender.

On the shaft are a pair of driving-wheels, whose frictional adhesion to the rails furnishes the necessary tractive force. In some engines a single pair of driving-wheels are used; in many more a greater tractive force is secured by having two equal

driving-wheels on each side, connected by a coupling-rod between pins on the outside of the wheels. In some engines a still greater proportion of the whole weight is utilized to give tractive force by coupling three or more wheels on each side.

It is now general to have under the front of the engine two or four smaller wheels which do not form part of the driving system. These are carried in a *bogie*, that is, a small truck upon which the front end of the boiler rests by a swivel-pin or plate which allows the bogie to turn, so as to adapt itself to curves in the line, and thus obviate the grinding of tyres and danger of derailment which would be caused by using a long rigid wheel base. The bogie appears to have been of English origin;¹ it was brought into general use in America, and is now common in English as well as in American practice. Instead of a four-wheeled bogie, a single pair of leading wheels are also used, carried by a Bissel *pony* truck, which has a swing-bolster pivoted by a radius bar about a point some distance behind the axis of the wheels. This has the advantage of combining lateral with radial movement of the wheels, both being required if the wheel base is to be properly accommodated to the curve. Another method of getting lateral and radial freedom is the plan used by F. W. Webb of carrying the leading axle in a box curved to the arc of a circle, and free to slide laterally for a short distance, under the control of springs, in curved guides.²

In *inside-cylinder* engines the cylinders are placed side by side within the frame of the engine, and their connecting-rods work on cranks in the driving shaft. In *outside-cylinder* engines the cylinders are spread apart far enough to lie outside the frame of the engine, and to work on crank-pins on the outsides of the driving wheels. This dispenses with the cranked axle, which is the weakest part of a locomotive engine. Owing to the frequent alternation of strain to which it is subject, a locomotive crank axle is peculiarly liable to rupture, and has to be removed after a certain amount of use.

The outside-cylinder type is adopted by several British makers; in America it is almost universal. There the cylinders are in castings which are bolted together to form a saddle on which the bottom of the smoke-box sits. The slide-valves are on the tops of the cylinders, and are worked through rocking levers from an ordinary link-motion. Fig. 51, which is a half section through one cylinder of an American locomotive, by the Baldwin Company of Philadelphia, shows the position of the cylinders and valves.

In inside-cylinder engines the slide-valves are frequently placed back to back in a single valve-chest between the cylinders. The width of the engine within the frame leaves little room for them there, and they are reduced to the flattest possible form, in some cases with split ports, half above and half below a partition in a central horizontal plane. In some engines the valves are below the cylinders: in many others the valves work on horizontal planes above the cylinders; this position is specially suitable when some form of radial gear is used instead of the link-motion. Radial valve-gears have the advantage, which is of considerable moment in inside-cylinder engines, that a part of the shaft's length which would otherwise be needed for eccentrics is available to increase the width of main bearings and crank-pins, and to strengthen the crank-cheeks.

The principle of compounding has often been applied to locomotive engines, but without much advantage. On this subject the reader should refer to the article RAILWAY: § *Locomotive Power*. A more important modern departure is the use of highly superheated steam, which in many locomotives has been attended with conspicuous success.

¹ *Proc. Inst. Civ. Eng.*, liii. 3, p. 50.

² *Proc. Inst. Mech. Eng.* (1883).

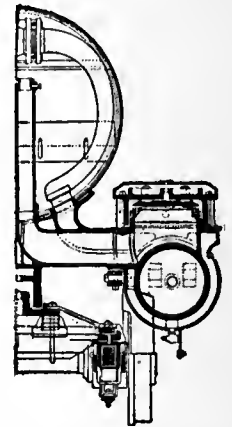

FIG. 51.—American Outside-Cylinder Locomotive.

105. *Steam Turbines.*—Steam turbines are distinguished from all other types of steam engine by the fact that their action involves a double transformation of energy. The heat energy present in the steam is first employed to set the steam itself in motion, giving it kinetic energy, and this in turn is employed to do work on the turbine blades. A brief account of the main principles involved will make the action of the various types of steam turbine more intelligible.

106. *Theory of the Steam-jet.*—Consider an element of steam, of unit mass, acquiring kinetic energy in the expansion of the steam through a nozzle or other channel, from a region of pressure p_1 to a region of lower pressure p_2 . Its volume changes from v_1 to v_2 in the process. The work done upon it by steam from behind is p_1v_1 . The work which it does on the steam in front is p_2v_2 . The net amount of work done upon it is therefore $p_1v_1 - p_2v_2$. Its velocity changes from V_1 to V_2 ; the kinetic energy which it gains is therefore $(V_2^2 - V_1^2)/2g$. The internal energy changes from E_1 to E_2 . Hence by the conservation of energy

$$(V_2^2 - V_1^2)/2g = J(E_1 - E_2) + p_1v_1 - p_2v_2$$

which may be written

$$(V_2^2 - V_1^2)/2g = J(I_1 - I_2),$$

where I is the total heat (§ 31), which is equal to $E + pv/J$. It is assumed here that the action is adiabatic in the sense that no heat is received by the steam or given up by it to other bodies as the process goes on.

It is usual to speak of the change of I as the "heat drop" which the steam undergoes in acquiring velocity. When the heat drop is known the gain in velocity is readily found, as above. In determining the best drop account must, of course, be taken of the wetness of the steam, or of its superheat if it has any. Thus, for superheated steam $I = I_s + \kappa(t' - t)$ where I_s is the total heat of saturated steam at the same pressure and $\kappa(t' - t)$ represents the heat taken up in the process of superheating to the actual temperature t' from the temperature of saturation t . And for wet steam $I = I_w + qL$ where I_w is the total heat of water, L the latent heat, and q is the dryness fraction.

During this process of expansion, which we assume to be adiabatic, the steam becomes wet, and the value of q accordingly falls. As has been shown in § 36, the dryness may be found at any stage in adiabatic expansion from the formula—

$$q = \frac{\tau}{L} \left(\frac{q_1 L_1}{\tau_1} + \log \frac{\tau_1}{\tau} \right),$$

or it may be determined by measurement from the entropy-temperature diagram. A still more convenient diagram in which the heat drop can be directly measured is one introduced by Mollier, in which the co-ordinates are the entropy and the total heat (see Mollier, *loc. cit.*, or Ewing's *Steam Engine*).

The pressure-volume diagram gives a very useful alternative means of finding the heat drop or energy available for transformation. Consider steam or any other gas supplied at pressure p_1 and expanding to pressure p_2 , at which pressure it is discharged. The work which it does is measured by the area ABCD of the pressure-volume diagram (fig. 52), namely,

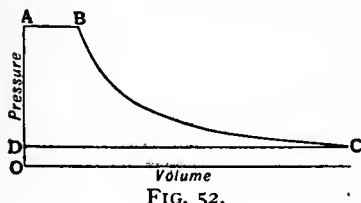

FIG. 52.

$$\int_{p_2}^{p_1} v dp.$$

If this work is wholly done upon this steam in giving it velocity, the kinetic energy acquired is equal to it, that is

$$(V_2^2 - V_1^2)/2g = \int_{p_2}^{p_1} v dp.$$

We have already seen (§ 41) that in adiabatic expansion this integral measures the heat drop, being equal to $I_1 - I_2$.

If the mode of expansion is such as to make $pv^n = \text{constant}$, n being any index, then

$$\begin{aligned} \int_{p_2}^{p_1} v dp &= \frac{n}{n-1} (p_1 v_1 - p_2 v_2) \\ &= \frac{n}{n-1} \left(1 - D^{\frac{n-1}{n}} \right) p_1 v_1, \end{aligned}$$

where D is the ratio in which the pressure falls, namely p_2/p_1 .

Now the adiabatic expansion of steam, starting from an initially dry saturated state, is very approximately represented by the formula $pv^{1.135} = \text{constant}$. Hence the area of the pressure-volume diagram, which under these conditions measures the work theoretically obtainable, is equal to $8.41(1 - D^{0.119})p_1v_1$, a quantity which will be found on evaluation to agree closely with the value of $I_1 - I_2$.

107. *Form of the Jet in Adiabatic Expansion.*—As expansion pro-

ceeds the volume of the steam, per pound, at any stage is found by multiplying the volume of 1 lb of saturated steam, at the pressure then reached, by the dryness fraction q . On comparing the velocity acquired at any intermediate stage of expansion—as calculated from the heat drop down to that stage—with the increase in volume, it will be found that in the earliest stages the gain in velocity is relatively great, but as expansion proceeds the increase in volume outstrips the increase in velocity. Hence the proper form for a nozzle to give adiabatic expansion is one in which the area of section at first contracts and afterwards becomes enlarged. The area of section to be provided for the discharge is found by dividing the volume v at each stage of the velocity V acquired up to that stage, and the ratio v/V at first diminishes and afterwards increases as the expansion proceeds. Take, for instance, as a numerical example, a case in which dry saturated steam is admitted to a nozzle at an absolute pressure of 213 lb per sq. in., and expands adiabatically, giving itself velocity, until the pressure falls to 1.7 per sq. in. It will be found on working out numerical values that until the pressure falls to about 123 lb per sq. in. the steam is gaining velocity so rapidly that though its volume is expanding the stream-lines are convergent. Below that pressure, however, the augmentation of volume is relatively so great that a larger and larger area of section has to be provided for the flow. Thus, when the pressure is 123 lb per sq. in. the dryness q is 0.96, the volume per pound is 3.51 cub. ft., the heat drop is $25\frac{1}{4}$ thermal units, giving a velocity of 1510 ft. per second. Consequently, the area of the stream is 0.00233 sq. ft. per pound of flow, and this is the minimum value. When the pressure falls to 1.7 lb per sq. in. the dryness q is 0.784, the volume per pound is 157.8 cub. ft., the heat drop is 175.7 thermal units, giving a velocity of 3980 ft. per second, and consequently the area of the stream is 0.0396 sq. ft. per pound of flow.

108. *De Laval's Divergent Nozzle.*—It is on this basis that De Laval's divergent nozzle is designed. The "throat" or smallest section is approached by a more or less rounded entrance, allowing the stream-lines to converge, and from the throat outwards the nozzle expands in any gradual manner, generally in fact as a simple cone (fig. 53).

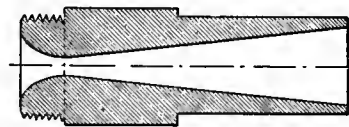

FIG. 53.

In the example just given the final area of section would be seventeen times that of the throat to provide for adiabatic expansion down to a pressure of 1.7 lb per sq. in. With any final area less than this the pressure at exit would be higher than 1.7 lb; it would in fact adjust itself to give a value of v/V corresponding to the area, and the remainder of the pressure drop would be wasted. For expansion to atmospheric pressure (14.7 per sq. in.) the area at exit would be 3.14 times that of the throat.

The equation of velocity

$$\frac{V^2}{2g} = \frac{n}{n-1} \left(1 - D^{\frac{n-1}{n}} \right) p_1 v_1$$

may be applied to calculate generally the discharge per square foot of stream section, and hence to find at what point in the fall of pressure this discharge becomes a maximum—in other words, to determine the pressure at the throat. Since $pv^n = p_1v_1^n$

$$v = v_1/D^{\frac{1}{n}} \text{ where } D = p/p_1.$$

The discharge per square foot when the volume is v is

$$Q = \frac{V}{v} = \frac{VD^{\frac{1}{n}}}{v_1} = \sqrt{\left\{ \frac{2gn}{n-1} \cdot \frac{p_1}{v_1} \left(D^{\frac{2}{n}} - D^{\frac{n+1}{n}} \right) \right\}}.$$

Q will be a maximum when dQ/dD is zero, which occurs when

$$D = \left(\frac{2}{n+1} \right)^{\frac{n}{n-1}}.$$

This result is general for any gas. With saturated steam, n being 1.135, Q is a maximum when $D = 0.577$, that is to say, the pressure at the throat is 57.7% of the initial pressure, a result which agrees with the figures quoted above for a particular case.

The maximum value of Q , namely the discharge in pounds per square foot at the throat, is

$$3.6\sqrt{(p_1/v_1)},$$

and the velocity there is $5.85\sqrt{(p_1/v_1)}$. In these expressions p_1 is the initial pressure in pounds per square foot.

109. From these considerations it follows that, provided the final pressure is less than 0.577 times the initial pressure, the total discharge depends simply on the least area of section of the nozzle and on the initial pressure, and is independent of the final pressure. By continuing the expansion in a divergent nozzle, after the throat is passed, the amount of discharge is not increased, but the steam is caused to acquire a greater velocity of exit, namely the velocity corresponding to the augmented pressure range.

110. When the pressure drop is small (p_2 greater than 0.577 p_1) the full velocity due to the drop is obtained without the use of a

divergent nozzle. This is the case, for instance, in the Parsons turbine, where the whole expansion is divided into many stages each of which involves only a small drop in pressure.

111. *Influence of Friction.*—We have dealt so far with the ideal case of no friction, and have taken the whole work of expansion as going to produce kinetic energy in the jet. But under real conditions there is a progressive dissipation of energy through friction; as expansion proceeds the steam loses part of its kinetic energy which is restored to it as heat. Thus, at every stage in the process the velocity acquired is less than it would be in frictionless adiabatic expansion, but the steam is drier and its volume is greater in consequence of the restored heat. Referring to the entropy-temperature diagram

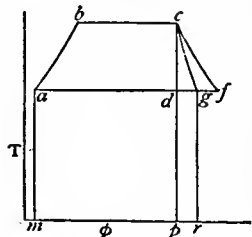

FIG. 54.

(fig. 54) the process of expansion under conditions involving friction is represented not by the adiabatic line *cd* but by some such line as *cg* lying between the adiabatic line and the saturation line *cf*. The final condition of dryness is *ag/af* instead of *ad/af*. During this expansion the effect of friction, as regards the entropy, is equivalent to the communication to the substance of a quantity of heat represented by the area *pcgr*. Hence that area represents the work converted by friction into heat. The whole work done during expansion is the area *abcg*, which is more than before by the area *dgc*. The difference, namely *abcg* minus *pcgr*, represents what may be called the *net* heat drop when friction is allowed for: it represents what is effectively available for giving kinetic energy to the jet. This net area may also be expressed as equal to *abcd* minus *pdgr*. Compared with frictionless adiabatic expansion the net loss resulting from friction is the area *pdgr*. The volume is increased in the ratio of *ag* to *ad*, and this has to be taken account of in determining the proper dimensions of the divergent nozzle.

112. Turning now to the question of utilizing the kinetic energy of steam in a steam turbine, it will be clear from the figures that have been given that if the whole heat drop is allowed to give kinetic energy to the steam in one operation, as in the De Laval nozzle, a velocity of about 4000 ft. per second has to be dealt with. To take advantage of a jet in the most efficient manner in a turbine consisting of a single wheel the velocity of the buckets against which the steam impinges should be nearly one half the velocity of the stream. But a peripheral velocity approaching 2000 ft. per second is impracticable. Apart from the difficulties which it would involve as regards gearing down to such a speed as would serve for the driving of other machines, which are to employ the power, there are no materials of construction fitted to withstand the forces caused by rotation at such a speed.

Hence it is advantageous to divide the process into stages. This may be done by using more than one wheel to absorb the kinetic energy of the jet, as is done in the Curtis turbine, or by dividing the heat drop into many steps, making each of these so small that the steam never acquires an inconveniently great velocity, as is done in the Parsons turbine. Turbines which employ one or other of these two methods, or a combination of both, achieve a greater economy of steam than is practicable with a single wheel.

113. *De Laval Turbine.*—Thanks, however, to the inventions of De Laval, the single expansion single wheel type of turbine, with buckets in the rim, has been brought to a degree of efficiency which, while considerably less than is reached in compound turbines, is still remarkably good. This has been done by the use of the divergent nozzle and with the help of mechanical devices which enable the peripheral speed to be very high, though even with the help of these devices the speed of the buckets falls considerably short of that which would be suitable to the velocity of the jet. In De Laval's turbine the steam expands at one step from the full pressure of the supply to the pressure of the exhaust by discharge in the form of a jet from a divergent nozzle. It then acts on a ring of buckets or blades in much the same way as the jet of water acts on the buckets of a Pelton wheel or other form of pure impulse turbine. To utilize a fair fraction of the kinetic energy of the jet the blades have to run at an enormous velocity, and the speed of the shaft which carries them is so great that gearing down is resorted to before the motion is applied to useful purposes. The general arrange-

ment of the steam nozzle and turbine blades is illustrated in fig. 55. The blades project from the circumference of a disk-shaped wheel and form a complete ring round it, only a few of the blades being shown in the sketch. The increasing section of the nozzle is calculated with reference to the final pressure, according to the principles already explained. The jet impinges at one side of the wheel and escapes at the other after having had its direction of motion nearly reversed. The expansion in the nozzle is carried to atmospheric pressure, or near it, if the turbine is to be used without a condenser; but in many cases an ejector condenser is employed, and when that is done the nozzle is of a form which adapts it to expand the steam to a correspondingly lower pressure. It is only in the smaller sizes of these turbines that a single nozzle is used; in the larger steam turbines, as in large Pelton wheels, several nozzles are applied at intervals along the circumference of the disk. The peripheral velocity of the blades ranges from about 500 ft. per second in the smallest sizes (5 h.p.) up to nearly 1400 ft. per second in turbines of 300 h.p. In a 50 h.p. De Laval turbine the shaft which carries the turbine disk makes 16,000 revolutions per minute; in the 5 h.p. size it makes as many as 30,000 revolutions per minute. A turbine developing 300 h.p. uses a wheel 30 in. in diameter, running at over 10,000 revolutions per minute, with a peripheral speed of nearly 1400 ft. per second. These enormous speeds are made possible by the ingenious device of using a flexible shaft, which protects the bearings and foundations from the vibration which any want of balance would otherwise produce. The elasticity of the shaft is such that its period of transverse vibration is much longer than the time taken to complete a revolution. The high-speed shaft which carries the turbine disk is geared, by means of double helical wheels, with teeth of specially fine pitch, to a second-motion shaft, which runs at one-tenth of the speed of the first; and from this the motion is taken, by direct coupling or otherwise, to the machine which the turbine is to drive. The wheel carrying the buckets is much thickened towards the axis to adapt it to withstand the high stresses arising from its rotation. Turbines of this class in sizes up to 300 or 400 h.p. are now in extensive use for driving dynamos, fans and centrifugal pumps. Compared with the Parsons turbine, De Laval's lends itself well to work where small amounts of power are wanted, and there it achieves a higher efficiency, but in large sizes the Parsons turbine is much the more efficient of the two. Trials of a De Laval turbine used with a condenser, and developing about 63 h.p., have shown an average steam consumption at the rate of about 20 lb per brake-horse-power-hour, and even better results are reported in turbines of a larger size.

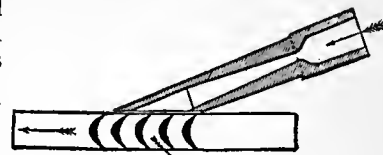

FIG. 55.

ment of the steam nozzle and turbine blades is illustrated in fig. 55. The blades project from the circumference of a disk-shaped wheel and form a complete ring round it, only a few of the blades being shown in the sketch. The increasing section of the nozzle is calculated with reference to the final pressure, according to the principles already explained. The jet impinges at one side of the wheel and escapes at the other after having had its direction of motion nearly reversed. The expansion in the nozzle is carried to atmospheric pressure, or near it, if the turbine is to be used without a condenser; but in many cases an ejector condenser is employed, and when that is done the nozzle is of a form which adapts it to expand the steam to a correspondingly lower pressure. It is only in the smaller sizes of these turbines that a single nozzle is used; in the larger steam turbines, as in large Pelton wheels, several nozzles are applied at intervals along the circumference of the disk. The peripheral velocity of the blades ranges from about 500 ft. per second in the smallest sizes (5 h.p.) up to nearly 1400 ft. per second in turbines of 300 h.p. In a 50 h.p. De Laval turbine the shaft which carries the turbine disk makes 16,000 revolutions per minute; in the 5 h.p. size it makes as many as 30,000 revolutions per minute. A turbine developing 300 h.p. uses a wheel 30 in. in diameter, running at over 10,000 revolutions per minute, with a peripheral speed of nearly 1400 ft. per second. These enormous speeds are made possible by the ingenious device of using a flexible shaft, which protects the bearings and foundations from the vibration which any want of balance would otherwise produce. The elasticity of the shaft is such that its period of transverse vibration is much longer than the time taken to complete a revolution. The high-speed shaft which carries the turbine disk is geared, by means of double helical wheels, with teeth of specially fine pitch, to a second-motion shaft, which runs at one-tenth of the speed of the first; and from this the motion is taken, by direct coupling or otherwise, to the machine which the turbine is to drive. The wheel carrying the buckets is much thickened towards the axis to adapt it to withstand the high stresses arising from its rotation. Turbines of this class in sizes up to 300 or 400 h.p. are now in extensive use for driving dynamos, fans and centrifugal pumps. Compared with the Parsons turbine, De Laval's lends itself well to work where small amounts of power are wanted, and there it achieves a higher efficiency, but in large sizes the Parsons turbine is much the more efficient of the two. Trials of a De Laval turbine used with a condenser, and developing about 63 h.p., have shown an average steam consumption at the rate of about 20 lb per brake-horse-power-hour, and even better results are reported in turbines of a larger size.

114. *Action of the Jet in De Laval's Turbine.*—In entering the turbine the jet is inclined at an angle α to the plane of the wheel. Calling its initial velocity V_1 and the velocity of the buckets u we have, as in fig. 56, V_2 for the velocity of the steam relatively to the wheel on admission. A line *AB* parallel to V_2 therefore, determines the proper angle of the blade or bucket on the entrance side if the steam is to enter without shock. As the steam passes through the blade channel the magnitude of this relative velocity does not change, except that it is a little reduced on account of friction. The action is one of pure impulse; there is no change of pressure during the passage, and consequently no acceleration of the steam through drop in pressure after once it has left the nozzle. Hence V_3 , the relative velocity at exit may (neglecting friction) be taken as equal to V_2 . The direction of V_3 or *BC* is tangent to the exit side of the bucket.

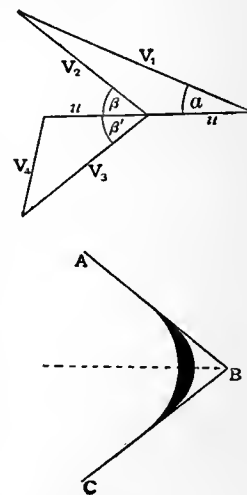

FIG. 56.

Compounding V_3 with u we find V_4 , which is the absolute velocity of the steam after exit, and this should be no greater than is required to get the steam clear of the wheel. The most favourable condition of running would be when the bucket velocity u is such that V_4 is perpendicular to the plane of the wheel, for V_4 would then have its least possible value. Assuming the angle of discharge β' to be equal to β , we should in that event have $u = \frac{1}{2}V_1 \cos \alpha$, which approximates more and more closely to $\frac{1}{2}V_1$ the smaller α is made. The ideal efficiency would be $(V_1^2 - V_4^2)/V_1^2$ or $1 - \sin^2 \alpha$ in a turbine in which the jet enters the buckets without shock and travels over them without friction. In practice α is about 20° . Owing to the impossibility of making the bucket speed so high as the above condition implies the steam enters the buckets of a De Laval turbine with some shock and leaves them with a velocity inclined to the plane of the wheel, with a backward component, and the turbine loses something in efficiency through this exit velocity being greater than the ideal minimum.

Taking a test of a De Laval turbine of 300 h.p. in which the steam consumed was 15.6 lb per horse-power-hour, Stodola estimates that the losses in the nozzle amount to about 15% of the available energy or total heat drop, the losses in the buckets (due to friction and to eddy currents set up by shock) to 21% and the losses due to the velocity retained by the steam at exit to nearly 5%. The losses due to friction in the mechanism consume about 5% more, leaving a net return of about 54% of the available energy.

115. *Curtis Turbine.*—The Curtis turbine, like that of De Laval, is a pure impulse turbine, but the velocity of the jet is extracted not by one ring of buckets but by a series of rings, each of which extracts a certain part. Between the first and second rings of buckets there are fixed guide blades which serve to turn the remaining motion of the steam into a direction proper for its action on the second ring, and so on. The jet, having acquired its velocity in a nozzle in the first place, often acts on three successive rings of moving buckets, with two sets of fixed guide blades between, the three co-operating to extract its kinetic energy. But the Curtis turbine is generally compound in the further sense that the total drop from admission to condenser pressure is itself divided into two, three or more stages, the steam acquiring velocity anew at each stage and then giving up that velocity in passing through a series of impulse turbine rings generally either two or three in number before undergoing the next drop in pressure.

116. *Action of the Steam in the Curtis Turbine.*—In this division of the heat drop or pressure drop into stages Curtis follows Parsons. The distinctive feature in Curtis is the multi-impulse action which occurs at each pressure stage. This is illustrated in the diagram (fig. 57), which shows the nozzle and

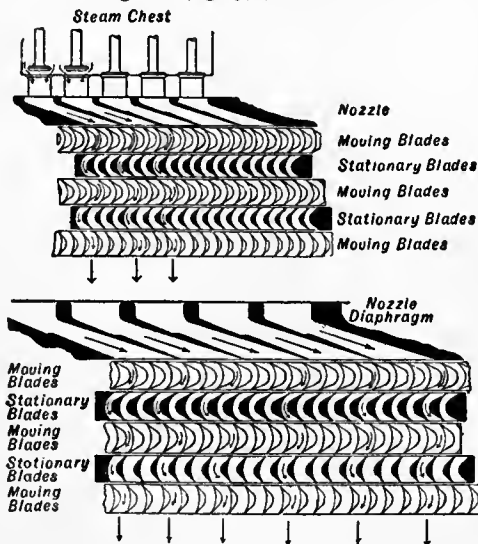

FIG. 57.—Diagram of Steam Nozzles and Blades, Curtis Steam Turbine.

blades of a two-stage Curtis turbine, with three rings of moving blades or buckets in each stage, arranged, of course, round the periphery of a wheel. The velocity acquired in the nozzles is extracted as the steam pursues its sinuous course between moving and fixed blades, and it leaves the third ring in each case with only a small residual velocity, the direction of which is approxi-

mately parallel to the axis of the wheel. The changes of velocity are illustrated in fig. 58, which, for the sake of simplification, is drawn for the ideal case of no friction. There u is the velocity of the buckets, V_1 the initial velocity of the jet, and V_2 the initial relative velocity on entrance to the first moving ring. V_3 is the absolute velocity on entering the second moving ring, and V_4 the relative velocity. V_5 is the absolute velocity on entering the third moving ring and V_6 the relative velocity. Finally, V_7 is the absolute velocity on leaving the third moving

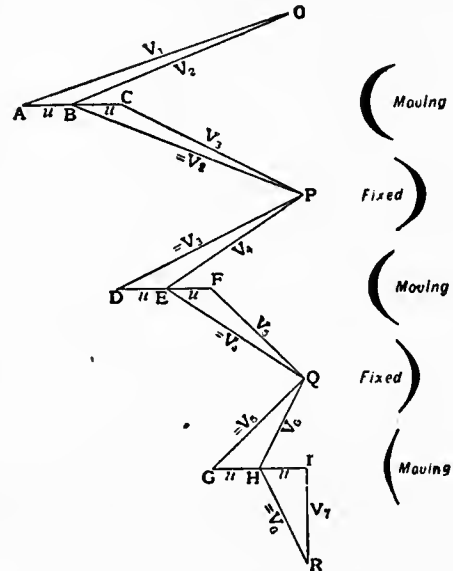

FIG. 58.

ring, and this in the example here drawn is parallel to the axis of the turbine. The first moving blades have sides parallel to OB, BP; the first fixed blades have sides parallel to CP, PD. The second moving blades have sides parallel to PE, EQ; the second fixed blades to FQ, QG, and the third moving blades to QH, HR.

The steam then passes on to a second set of divergent nozzles in which it undergoes a second drop in pressure, acquiring velocity afresh, which it loses as before in passing through a set of three rings of moving buckets. In some Curtis turbines this is followed by a third and often a fourth similar process before the condenser is reached. In a four-stage Curtis turbine the speed of the buckets is usually about 400 ft. per second; the steam issues from each set of nozzles with a velocity of about 2000 ft. per second, and each set of moving rings reduces this by something like 400 ft. per second. The losses due to steam friction are somewhat serious, although the blade speed in each set is sufficient to let the steam enter without shock; on the other hand, the Curtis turbine escapes to a great extent losses due to leakage which are present in the Parsons type. The velocity diagram shown in fig. 58 may readily be modified to allow for effects of friction. Owing to the progressive reduction of velocity in passing from ring to ring a larger and larger area of blade opening is required, and this is provided for by making the height of the blades increase in the successive rings of each series.

117. *Performance of Curtis Turbines.*—Curtis turbines have been successfully applied in large sizes, especially in America, to drive electric generators, with outputs of as much as 9000 kilowatts, and in a few instances they have been adapted to marine propulsion. In large sizes, and using moderately superheated steam, the Curtis turbine has achieved a high degree of efficiency. The advantage of superheating, in any type of turbine, is to reduce the wetness which the steam develops as it expands during work. The prejudicial effect of wetness is chiefly that it increases friction, especially in the later stages of the expansion. Tests of Curtis turbines show that they maintain a very uniform efficiency throughout a wide range of loads, and are capable of being much overloaded without

material increase in the ratio of steam consumption to output. In tests of a 9000 kilowatt Curtis turbine using steam of about 200 lb pressure and 80° C. superheat, with a vacuum of 29½ in. the consumption of steam is reported to have been only 13 lb per kilowatt-hour, and this figure remained almost constant for loads ranging from 8000 to 12,000 kilowatts. In a 5000 kilowatt turbine under very similar conditions the consumption is reported to have been 13½ lb per kilowatt-hour. In the usual arrangement of the Curtis turbine the shaft is vertical and the wheels lie in horizontal planes, the weight of the revolving parts being taken by a footstep bearing with forced lubrication, and the electric generator is mounted on the top. There are usually in the large sizes four stages of expansion, each stage being separated from the one above it by a diaphragm plate containing the nozzles in which the next step in velocity is acquired. The expansion has been divided into as many as seven stages in a Curtis turbine for marine use, the shaft being then horizontal, and in all except the first stage in that example the pressure drop is so comparatively small as not to require divergent nozzles.

118. *Parsons Turbines.*—In the turbines of De Laval and Curtis the action on the moving blades or buckets is entirely one of impulse. No drop of pressure occurs while the steam is passing the moving blades, and its velocity relative to the blade surface undergoes no change except such as is brought about by friction. In the Parsons turbine, on the other hand, there is a reaction effect. The steam acquires relative velocity and loses pressure as it passes each ring of moving blades: in this respect the action in the moving blades is like the action in the fixed blades. Each pair of fixed and moving

comparatively high blade speeds are practicable, as in turbines for driving electric generators, the steam is allowed to acquire a fairly high velocity at each ring of blades, and in such cases so few as 45 stages may be suitable. In large marine turbines, on the other hand, where the number of revolutions per minute has to be kept low in the interests of propeller efficiency, the blade speeds cannot be kept high without making the diameters unduly great, and consequently more stages are required: in such turbines the number of stages may be from 100 to 200. The general relation of fixed to moving blades and the characteristic form of both will be seen from fig. 59.

Fig. 60 shows a complete Parsons turbine of 1000 kilowatts capacity in longitudinal section through the casing. The fixed blades are caulked with separating distance-pieces into grooves turned on the inner surface of the case and project inwards: the moving blades are similarly secured in grooves which are turned on the surface of the rotating drum. Between drum and case there is an annular space fitted in this way with successive rings of fixed and moving blades. There is considerable longitudinal clearance from ring to ring, but over the tips of the blades the clearance is reduced to the smallest possible amount consistent with safety against contact (generally from 15 to 30 thousandths of an inch in turbines of moderate size). Steam enters at A, expands through all the rings of blades in turn and escapes to the condenser at B. To provide for the increase in its volume the size of the blade passages enlarges progressively from the high to the low pressure end. In the example shown this is done partly by lengthening the blades and partly by increasing the circumference of the drum, which has the further effect of increasing the blade velocity, so that the expanded steam not only has a larger area of passage open to it but is also allowed to move faster, and consequently each unit of the area is more effective in giving it vent. Instead of attempting to make the change in passage area continuous from ring to ring, as the ideal turbine would require, it is done in a limited number of steps and the several rings in each step are kept of the same size. Thus in the example shown in the figure the first step consists of seven pairs of rings or stages, the next two also of seven each, the next three of four each, the next of two and so on. This is convenient for constructive reasons and gives a sufficiently good approximation to the ideal conditions as regards the relation of steam volume to blade-passage-area and velocity.

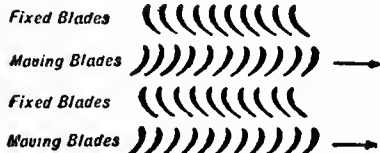

FIG. 59.—Fixed and Moving Blades of Parsons Turbine.

rings makes up what is called a "stage" and may be said to constitute a separate turbine: the whole is a series of many such stages. In each stage the drop in pressure and in heat is divided equally between the fixed and moving element, the exit and entrance angles and the form of the blades generally being alike in both. The number of stages depends on what peripheral speed it is convenient to use. Where

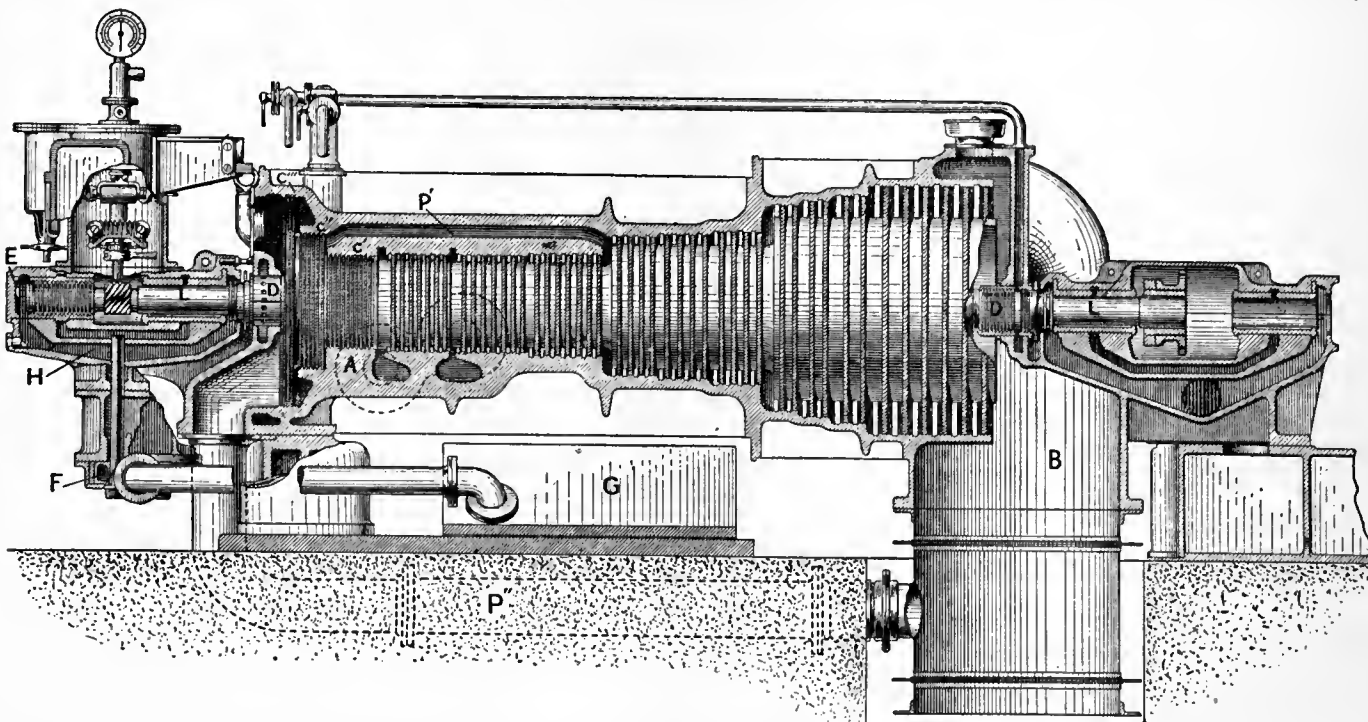

FIG. 60.—Parsons Turbine.

119. *Balance of Longitudinal Forces: Dummies.*—Since the pressure of the steam falls progressively from left to right there is a resultant longitudinal thrust on the drum forcing it to the right, which is balanced by means of "dummy" rings C' C" C'''. These correspond in diameter with the several portions of the bladed drum and are connected with them by steam passages which secure that each dummy shall have the same pressure forcing it to the left as tends on the corresponding part of the drum to force it to the right. No steam-tight fit is practicable at the dummies, but leakage of the steam past them is minimized by the device of furnishing the circumference of each dummy with a series of rings which revolve between a corresponding series of fixed rings projecting inwards from the case. The dummy rings do not touch but the clearance spaces are made as fine as possible and the whole forms a labyrinth which offers great resistance to the escape of steam. Substantially the same device is employed to guard against leakage in the glands DD where the shaft leaves the turbine case. There is a "thrust block" E at one end of the shaft which maintains the exact longitudinal position of the revolving part and allows the fine clearances between fixed and moving dummy rings to be adjusted.

120. *Lubrication.*—The main bearings LL are supplied with oil under pressure kept in circulation by a rotary pump F which draws the oil from the tank G. The pump shaft H, which also carries a spring governor to control the speed of the turbine, is driven by a worm on the main shaft. The same oil is circulated over and over again and very little of it is consumed. No oil mixes with the steam, and in this point the turbine has a marked advantage over piston and cylinder engines, which is especially important in marine use. In small fast-running turbines each bearing consists of a bush on which three concentric sleeves are slipped, fitting loosely over one another with a film of oil between. The whole acts as a cushion which damps out any vibration due to want of balance or alignment. In large turbines this device is dispensed with and a solid brass bearing lined with white metal is employed.

121. *Blades.*—The blades are generally of drawn brass, but copper is used for the first few rows in turbines intended for use with superheated steam. In the most usual method of construction they are put one by one into the grooves, along with distance pieces which hold them at the proper angle and proper distance apart, and the distance pieces are caulked to fix them. The length of the blades ranges from a fraction of an inch upwards. In the longest blades of the largest marine steam turbines it is as much as 22 in. When over an inch or so long they are strengthened by a ring of stout wire let into a notch near the tip and extending round the whole circumference. Each blade is "laced" to this by a fine copper binding wire, and the lacing is brazed. For long blades two and even three such rings of supporting wire are introduced at various distances between root and tip. The tips are fined down nearly to a knife-edge so that in the event of contact taking place at the tips between the "rotor" or revolving part, and the "stator" or case, they may grind without being stripped off. The possible causes of such contact are wear of bearings and unequal expansion in heating up. With a proper circulation of oil the former should not take place, and the clearances are made large enough to provide for the latter. Various plans have been devised to facilitate the placing and fixing of the blades. In one method they are slung on a wire which passes through holes in the roots and in the distance pieces and are assembled beforehand in a curved chuck so as to form a sector of the required ring, and are brazed together along with the supporting wires before the segment is put in place. In another method the roots are fixed in a brass rod in which cuts have been machined to receive them; in another the rod in which the roots are secured has holes of the right shape formed in it to receive the blades by being cast round a series of steel cores of the same shape as the blades: the cores are then removed and the blades fixed in the holes.

122. *Drums.*—In small turbines the drums carrying the revolving blades are solid forgings; in large turbines they are also of forged steel but in the form of hollow cylinders turned true inside as well as out. These are supported on the shafts by means of wheel-shaped steel castings near the ends, over which they are shrunk and to which they are fastened by screws the heads of which are riveted over. The case is of cast iron with a longitudinal joint which allows the upper half to be lifted off.

123. *Governing.*—The governor regulates the turbine by causing the steam to be admitted in a series of blasts, the duration of which is automatically adjusted to suit the demand for power. When working at full power the admission is practically continuous; at lower powers the steam valve is opened and closed at rapidly recurring intervals. Each revolution of the governor shaft causes a cam, attached to the governor, to open and close a relay valve which admits steam to a cylinder controlling the position of the main steam valve, which accordingly opens and closes in unison with the relay. The position of the governor determines how long the relay will admit steam to the controlling cylinder, and consequently how long the main valve will be held open in each period. In turbines driving electric generators the control of the relay-valve is sometimes made to depend on variations of the electric pressure produced instead of variations in the speed. In either case the arrangement secures control in a manner remarkably free from frictional interference, and therefore secures a high degree of uniformity in speed or in electric pressure, as the case may be.

To admit of overloading, that is, of working at powers considerably in excess of the full power for which the turbine is designed, provision is often made to allow steam to enter at the full admission pressure beyond the first set of rows of blades: this increases the quantity admitted, and, though the action is somewhat less efficient, more power is developed. An orifice will be seen in fig. 60 a little to the right of the main steam admission orifice, the purpose of which is to allow steam to enter direct to the second set of blades, missing the first seven stages, so that the turbine may cope with overloads.

124. *Absence of Wear.*—Owing to its low steam velocities the Parsons turbine enjoys complete immunity from wear of the blades by the action of the steam. A jet of steam, especially when wet, impinging at very high velocity against a metal surface, has considerable cutting effect, but this is absent at velocities such as are found in these turbines, and it is found that even after prolonged use the blades show no signs of wear and the efficiency of the turbine is unimpaired.

125. *Blade Velocity.*—Experience has shown that the most economical results are obtained when the velocity of the steam through the blades is about twice the velocity of the blades themselves, and the Parsons turbine is accordingly designed with, as far as possible, a constant velocity ratio of about this value. As already explained, it is convenient in practice to divide the expansion into a comparatively small number of steps (about twelve steps is a usual number), giving a constant area of steam passage to the first few rows, a larger area to the next few, and so on. An effect of this is that the velocity ratio varies slightly above and below the value of two to one, but if the steps are not too great this variation is not sufficient materially to affect the efficiency.

If the spindle or drum carrying the moving blades were of the same diameter throughout, the blades at the exhaust end would have to be exceedingly long in order to give passage to the rarefied steam. By increasing the diameter towards the exhaust end the peripheral velocity is increased, and hence the proper velocity for the steam is also increased. The amount of heat drop per ring is consequently greater towards the low-pressure end: in other words, the number of rings for a given drop is reduced. Taking the turbine as a whole, the number of rings will depend on the blade velocity at each step, the relation being such that $\sum nV_b^2 = \text{constant}$ for a given total drop from admission to exhaust, n being the number of rings whose blade velocity is V_b . It appears that a usual value of this constant is about 1,500,000¹ for the whole range from an admission pressure which may be nearly 200 lb per sq. in. down to condenser pressure.

¹ Speakman, "The Determination of the Principal Dimensions of the Steam Turbine with special reference to Marine Work," *Proc. Inst. Engineers & Shipbuilders in Scotland* (October 1905). On this subject see also Reed, "The Design of Marine Steam Turbines," *Proc. Inst. Civ. Eng.* (February 1909).

The increased diameter at the low-pressure end not only allows the steam velocity to be increased but by enlarging the annulus enables a sufficient area of passage to be provided without unduly lengthening the blades. In the very last stages of the expansion, however, the volume becomes so great that it is not practicable to provide sufficient area by lengthening the blades, and the blades there are accordingly shaped so as to face in a more nearly axial direction and are spaced more widely apart.

The area of the steam passage depends on the angle of the blade. If the blades were indefinitely thin it would be equal to the area of the annulus multiplied by the sine of the angle of discharge, and in practice this is subject to a deduction for the thickness of the blade on the discharge side, as well as to a correction for leakage over the tips. Generally the angle of discharge is about $22\frac{1}{2}^\circ$; and the effective area for the passage of steam is about one-third of the area of the annulus.

Fig. 61 A shows a representative pair of fixed and moving blades of a Parsons turbine, and fig. 61 B the corresponding

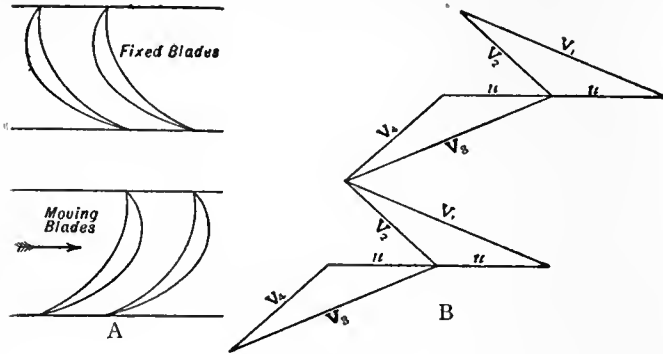

FIG. 61.

velocity diagram for the steam, neglecting effects of friction. V_1 is the exit velocity from the fixed blades, the delivery edges of which are tangent to the direction of V_1 . The blade velocity is u which is $\frac{1}{3}V_1$. V_2 is consequently the relative velocity with which the steam enters the moving blades. Approximately, the back surface of these blades is parallel to V_2 , but the blades are so thick near the entrance side that their front faces have a considerably different slope and there is therefore some shock at entrance. In passing through the moving blades the relative velocity of the steam over the blades changes from V_2 to V_3 . Allowing for the velocity u of the blades themselves, this corresponds to an absolute velocity V_4 , with which the steam enters the next set of fixed blades. In these blades it is again accelerated to V_1 and so on.

126. Calculation of Velocity at each Stage.—The acceleration of the steam in each row of blades results from a definite heat drop. Or, if we look at the matter from the point of view of the pressure-volume diagram, the acceleration results from the work done on the steam by itself during a drop δp in its pressure. The amount of this work per pound is $v\delta p$ where v is the actual volume per pound. It is convenient in practice to write this in the form $(pv)\delta p/p$, for the product pv changes only slowly as expansion proceeds. In designing a turbine a table of the values of pv throughout the range of pressures from admission to exhaust is prepared, and from these numbers it is easy to calculate the work done at each stage in the expansion, the pressure p and drop in pressure δp being known. In the ideal case with no losses we should have

$$\frac{(V_1^2 - V_4^2)/2g = (pv)\delta p/p}{V_1^2 = 2g(pv)\delta p/p + V_4^2}$$

or

where V_4 is the velocity before the acceleration due to the drop δp and V_1 is the velocity after.

But under actual conditions the gain of velocity is less than this, owing to blade friction, shock and other sources of loss. The actual velocity depends on the efficiency and on the shape and angles of the blades. It appears that under the conditions which hold in practice in Parsons turbines it is very nearly such that

$$V_1^2 = 2g(pv)\delta p/p.$$

In this formula, which serves as a means of estimating approximately the velocity for purposes of design, it is to be understood that in calculating the product pv the volume to be taken is that which is actually reached during expansion. The actual volume is affected both by friction and by leakage and is intermediate in value between the volume in adiabatic expansion and the volume corresponding to saturation. In the case of a turbine of 70% efficiency the actual wetness of the steam is, according to Mr Parsons's experience, about 55% of that due to adiabatic expansion in the early stages and 60% in the latest stages. In preparing the table of values of pv figures are accordingly to be taken intermediate between those for saturated steam and for steam expanded adiabatically, and from these is found as above the velocity for any given drop in pressure, and also the volume per pound, for which at each stage in the expansion provision has to be made in designing the effective areas of passage.

The blade speeds used in Parsons turbines rarely exceed 350 ft. per second and are generally a good deal less. In marine forms, where the number of revolutions per minute is limited by considerations of efficiency in the action of the screw propeller, the blade speeds generally range from about 120 to 150 ft. per second, though speeds as low as 80 ft. per second have been used.

127. Parsons Marine Turbines.—Marine turbines are divided into distinct high and low pressure parts through which the steam passes in series, each in a separate casing and each driving a separate propeller shaft. The most usual arrangement is to have three propeller shafts; the middle is driven by the high pressure portion of the turbine, and the steam which has done duty in this is then equally divided between two precisely similar low pressure turbines, each on one of two wing shafts. The rotor drum of each turbine has a uniform diameter throughout its length, but the casing is stepped to allow the lengths of the blades to increase as the pressure falls.

The casing which contains each of the two low pressure turbines contains also a turbine for running astern, so that either or both of the two wing shafts may be reversed. Steam is admitted to the reversing turbine direct from the boiler, the centre shaft being then idle. Each astern-driven turbine consists of a comparatively short series of rings of blades, set for running in the reversed direction, developing enough power for this purpose but making no pretensions to high efficiency. The astern turbine, being connected to the condenser, runs *in vacuo* when the ahead turbine is in use and consequently wastes little or no power.

Figs. 62 and 63 are sections of the high pressure and low pressure portions of a typical Parsons marine steam turbine, as designed for the three-shaft arrangement in which the low pressure portion is duplicated. In each figure A is the fixed casing and B is the revolving drum. Steam enters the high pressure turbine (fig. 62) through J and passes out through H. There are 4 "expansions" or steps, with 9 stages or double rows of blades in the first, 9 in the

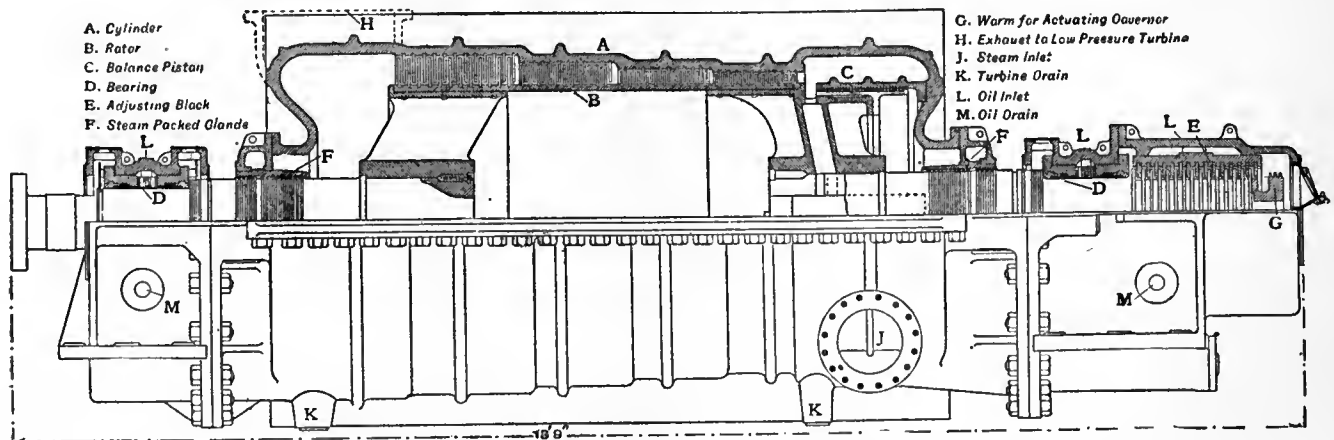

FIG. 62.—Parsons Marine Turbine: High Pressure Part. Upper half: sectional elevation. Lower half: external view.

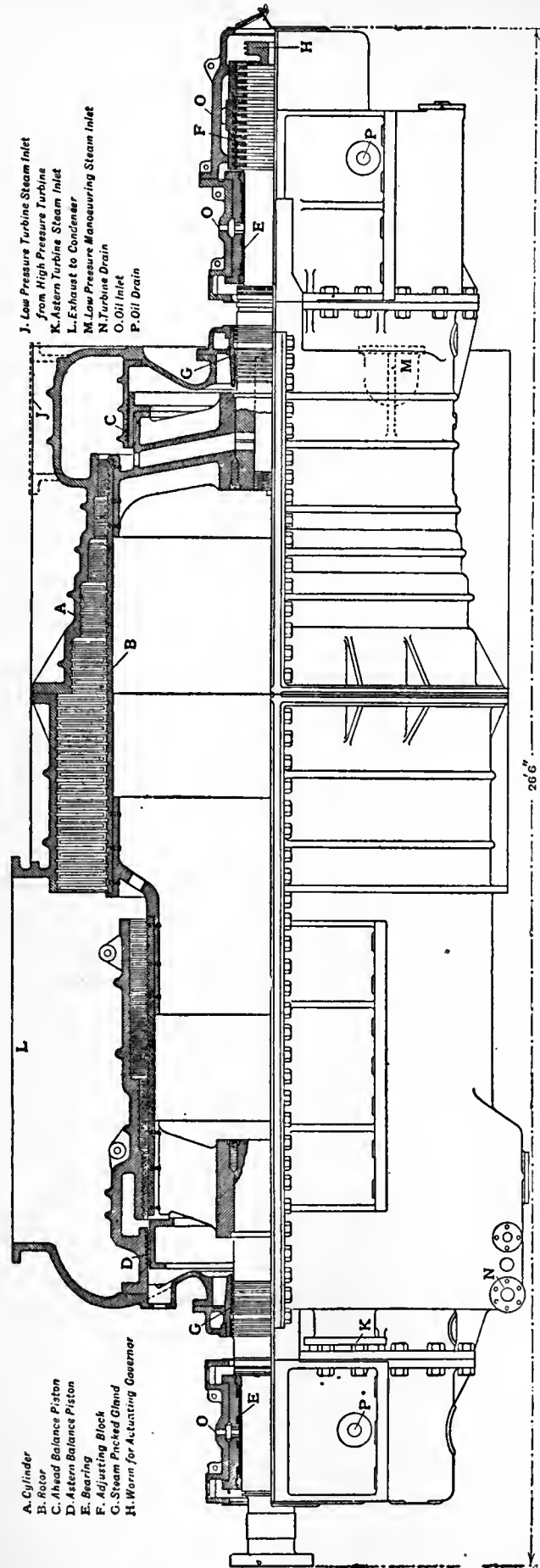

FIG. 63.—Parsons Marine Turbine: Low Pressure and Aster Part.

Upper half: sectional elevation.

Lower half: external view.

second, 8 in the third and 8 in the fourth, or 34 stages in all. The low pressure turbine (fig. 63) comprises 28 more stages stepped as shown in the figure. The reversing turbine which is seen on the left-hand side in fig. 63, at the place where the rotor is reduced in diameter, has 26 stages in 4 steps. These turbines have a total normal horse power of 12,500, and run at 450 revolutions per minute.

128. *Longitudinal Forces in Marine Turbines.*—In a marine steam turbine the size of the dummy is reduced so that instead of balancing the whole steam thrust it leaves a resultant force which nearly balances the propeller thrust. Consequently only a small thrust block has to be provided to take any difference there may be between these forces. This thrust block is shown on the extreme right in each figure, beyond the gland and bearing. The dummy (at D in the figures) is made up of some 22 rings of brass fixed in the case in close proximity to the faces of projecting rings on the rotor (fig. 64) with a longitudinal clearance of 0.015 in. This form of dummy is suitable for the end near the thrust block, where exact longitudinal adjustment is possible, but the astern turbine in fig. 63

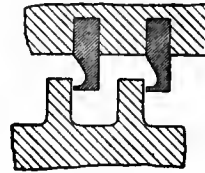

FIG. 64.

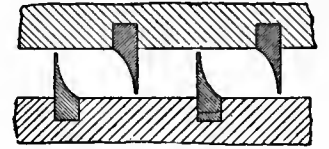

FIG. 65.

requires a different form because some longitudinal play is necessarily brought about there by differences in expansion of the rotor and stator. Accordingly, the astern dummy is of the "radial" form shown in fig. 65 where the fine clearance is round the circumference of the brass rings set in the rotor and stator alternately. The whole dummy includes about sixteen of these rings.

129. *Shaft Arrangement of Marine Turbines.*—Fig. 66 shows the usual three-shaft arrangement, with two low pressure turbines in parallel on the wing shafts, and one high pressure turbine, with which they are jointly in series, on the middle shaft. In very large vessels four shafts are used, and the turbines form two independent sets one on each side of the ship. The outer shaft on each side carries a high pressure turbine, and the inner shaft carries the corresponding low pressure turbine and also a turbine for reversing. This arrangement is followed in the "Lusitania" and "Mauretania" where the low pressure turbines have drums 188 in. in diameter, are about 17½ ft. in diameter over all and 50 ft. long, and weigh 300 tons. Each turbine has 8 steps with about 16 stages in each step in the high pressure turbine and 8 in the low. They run at 180 revolutions per minute.

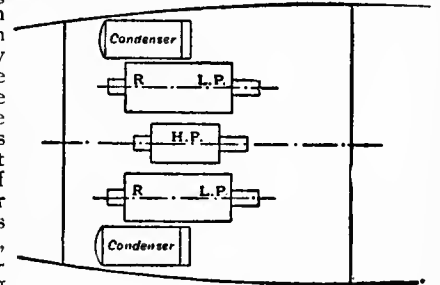

FIG. 66.

130. *Cruising Turbines in War-Ships.*—In turbines for the propulsion of war-ships it is necessary to secure a fairly high economy at speeds greatly short of those for which the turbines are designed when working at full power, for the normal cruising speed of such vessels is usually from half to two-thirds of the speed at full power. To counterbalance the reduced blade velocity, when running under these conditions, the number of rows of blades, has in some cases

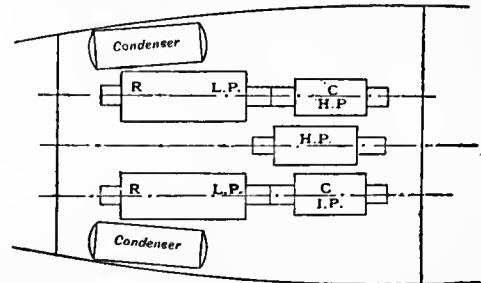

FIG. 67.

been augmented by adding what are called cruising turbines, which are connected in series with the main turbines when the ship is to run at cruising speed. In the three-shaft arrangement the cruising turbines are fitted on the wing propeller shafts, which carry also the low pressure and astern turbines. They form a high and intermediate pressure pair through which the steam may pass in series

before going on to the main turbines. This arrangement is shown in fig. 67, where C.H.P. and C.I.P. are the two cruising turbines. In cruising at low speeds the whole group of turbines is used in series: when the speed is increased a larger amount of power is got by admitting steam direct to the second cruiser turbine; and finally at the highest speed both cruiser turbines are cut out. The arrangement shown in fig. 67 has been used in some torpedo-boat destroyers and small cruisers. In some large cruisers and battleships a four-shaft system is employed and a longitudinal bulkhead divides the whole group into two independent sets. On each of the outer shafts there is a high-pressure ahead and also a separate high-pressure astern turbine. On each of the inner shafts there is a combined low-pressure ahead and astern turbine and also a cruising turbine. All four shafts can be reversed.

131. *Application of Parsons Turbine.*—The Parsons was the earliest steam turbine to be made commercially successful, and it has found a wider range of application than any other. Its chief employment is as an electric generator and as a marine engine, but it has been put to a considerable number of other uses. One of these is to drive fans and blowers for exhausting air, or for delivering it under pressure. The turbine-driven fans and blowers designed by Mr Parsons are themselves compound turbines driven reversed in such a manner as to produce a cumulative difference in the pressure of the air that is to be impelled.

An interesting field for the application of steam turbines is to economize the use of steam in non-condensing engines of the older type, by turning their exhaust to the supply of a turbine provided with an efficient condenser. It is a characteristic of the turbine that it is able to make effective use of low pressure steam. No condensing piston and cylinder can compete with it in this respect; for the turbine continues to extract heat energy usefully when the pressure has fallen so low that frictional losses and the inconveniences attaching to excessive volume make it impracticable to continue expansion to any good purpose under a piston.

132. *Parsons Vacuum Augmenter.*—For the same reason it is especially important in the turbine to secure a good vacuum: any increase in condenser pressure during a turbine test at once shows its influence in making a marked reduction of steam economy. In the region of usual condenser pressures a difference of 1 in. changes the steam consumption by about 5%. With this in mind Mr Parsons has invented a device called a vacuum augmenter, shown in fig. 68. The condensed water

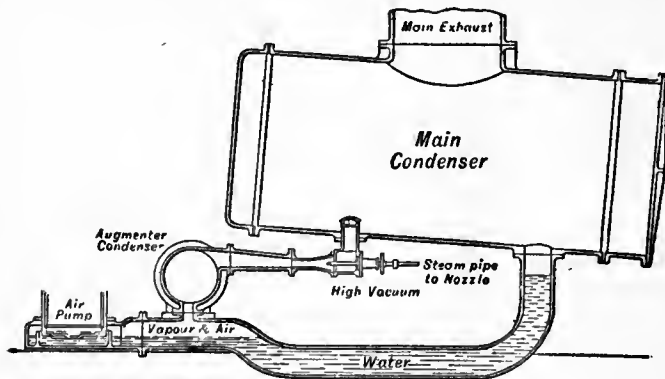

FIG. 68.—Parsons Vacuum Augmenter.

passes to the air-pump through a pipe bent to form a water-seal. The air from the condenser is extracted by means of a small steam jet pump which delivers it into an "augmenter condenser" in which the steam of this jet is condensed. The vacuum in the augmenter condenser is directly produced by the action of the air-pump. The effect of this device is to maintain in the main condenser a higher vacuum than that in the augmenter condenser, and consequently a higher vacuum than the air-pump by itself is competent to produce. This is done with a small expenditure of steam in the jet, but the effect of the augmented vacuum on the efficiency of the turbine is so beneficial that a considerable net gain results.

133. *Rateau and Zölly Turbines.*—Professor Rateau has designed a form of steam turbine which combines some of the

features of the Parsons turbine with those of the De Laval. He divides the whole drop into some twelve or twenty-four stages and at each stage employs an impulse wheel substantially of the De Laval type, the steam passing from one stage to the next through a diaphragm with nozzles. This form can scarcely be called an independent type. It has been applied as an exhaust steam turbine in conjunction with a regenerative thermal accumulator which enables steam to be delivered steadily to the turbine although supplied from an intermittent source. The Zölly turbine, which has found considerable application on a large scale, acts in a precisely similar manner to that of Rateau: it differs only in mechanical details.

134. *Combined Reciprocating and Turbine Engines.*—The combination of a reciprocating engine with a turbine is suggested by Parsons for the propulsion of cargo or other low-speed steamers where the speed of the screw shafts cannot be made high enough to admit of a sufficient blade velocity for the efficient treatment in the turbine of high-pressure steam. With a small speed of revolution blade velocity can be got only by increasing the diameter of the spindle, and a point is soon reached when this not only involves an unduly large size and weight of turbine, but also makes the blades become so short (by augmenting the circumference of the annulus) that the leakage loss over the tips becomes excessive. This consideration confines the practical application of turbines to vessels whose speed is over say 15 knots. But by restricting the turbine to the lower part of the pressure range and using a piston and cylinder engine for the upper part a higher economy is possible than could be reached by the use of either form of engine alone, the turbine being specially well adapted to make the most of the final stages of expansion, whereas the ordinary reciprocating engine in such vessels makes little or no use of pressure below about 7 lb per sq. in.

135. *Consumption of Steam in the Parsons Turbine.*—In large sizes the Parsons turbine requires less steam per horse-power-hour than any form of reciprocating engine using steam under similar conditions. Trials made in April 1900, by the present writer, of a 2000 h.p. turbine coupled to an electric generator showed a consumption of 18½ lb per kilowatt hour, with steam at 155 lb per sq. in. superheated 84° F. Since 1 kilowatt is 1.34 h.p. this consumption is equal to 13.6 lb per electrical horse-power-hour. The best piston engines when driving dynamos convert about 84% of their indicated power into electric power. Hence the above result is as good, in the relation of electric power to steam consumption, as would be got from a piston engine using only 11.4 lb of steam per indicated horse-power-hour. An important characteristic of the steam turbine is that it retains a high efficiency under comparatively light loads. The figures below illustrate this by giving the results of a series of trials of the same machine under various loads.

Load in kilowatts . . .	1450	1250	1000	750	500	250
Steam used per kilo- watt-hour in pounds }	18.1	18.5	19.2	20.3	22.6	34.0

Still better results have been obtained in more recent examples, in turbines of greater power. A Parsons turbine, rated as of 3500 but working up to over 5000 kilowatts tested in 1907 at the Carville power station of the Newcastle-on-Tyne Electric Supply Company, showed a consumption of only 13.19 lb of steam per kilowatt-hour, with steam of 200 lb pressure by gauge and 67° C. superheat (temperature 264.7° C.), the vacuum being 29.04 in. (barometer 30 in.). It is interesting to compare this performance with the ideal amount of work obtainable per pound of steam, or in other words with the ideal "heat drop." At the temperature and pressure of supply the total heat I_1 is 709. After expansion to the pressure corresponding to the stated vacuum (0.96 in.) the total heat of the wet mixture would be 486, the dryness being then 0.792, if the expansion took place under ideal adiabatic conditions. Hence the heat drop $I_1 - I_2$ is 223 units, and this represents the work ideally obtainable under the actual conditions as to temperature and pressure of supply and exhaust. Since 1 kilowatt-hour is 1896 thermal units (lb-degree C.), each pound of steam was generating an amount of electrical energy equivalent to $\frac{1896}{13.19}$ or 143.7 thermal units, and the electric

output consequently corresponds to 64½% of the ideal work. If we allow for the loss in the electric generator by taking the electrical output as 92% of the mechanical power, this implies that 70% of the ideal work in the steam was mechanically utilized.

136. *Torsion Meters for Power.*—No measurement corresponding to the "indicating" of a piston engine is possible with a

steam turbine. In the tests that have been quoted the useful output was determined by electrical means. Direct measurements of the useful mechanical power (the "brake" power) may, however, be obtained by applying a torsion dynamometer to the shaft. Devices are accordingly used in marine turbines for determining the horse-power from observations of the elastic twist in a portion of the propeller shaft as it revolves. In Denny & Johnson's torsion meter two light gun-metal wheels are fixed on the shaft as far apart as is practicable, generally 15 or 20 ft., and their relative angular displacement is found by comparing the inductive effects produced on fixed coils by magnets which are carried on the wheels. In Hopkinson & Thring's torsion meter a short length of shaft—a foot or so—suffices. A small mirror is carried by a collar fixed to the shaft, and a second collar fixed a little way along is geared to the mirror in such a way as to deflect the mirror to an extent proportional to the twist: the deflexion is read by means of a lamp and scale fixed alongside. As the shaft revolves the light reflected from the mirror is momentarily seen at each revolution and its position along the scale is easily read. (J. A. E.)

STEAMSHIP LINES. The shipping company is the outcome of the development of the steamship. In former days, when the packet ship was the mode of conveyance, there were combinations, such as the well-known Dramatic and Black Ball lines, but the ships which were run in them were not necessarily owned by those who organized the services. The advent of the steamship changed all that. It was in the year 1815 that the first steamship began to ply between the British ports of Liverpool and Glasgow. In 1826 the "United Kingdom," a "leviathan steamship," as she was considered at the time of her construction, was built for the London and Edinburgh trade, steamship facilities in the coasting trade being naturally of much greater relative importance in the days before railways. In the year 1823 the City of Dublin Steam Packet Company was inaugurated, though it was not incorporated till ten years later. The year 1824 saw the incorporation of the General Steam Navigation Company, which was intended not only to provide services in British waters, but also to develop trade with the continent. The St George Steam Navigation Company and the British & Irish Steam Packet Company soon followed. The former of these was crushed in the keen competition which ensued, but it did a great work in the development of ocean travelling. Isolated voyages by vessels fitted with steam engines had been made by the "Savannah" from the United States in 1819, and by the first "Royal William" from Canada in 1833, and the desirability of seriously attacking the problem of ocean navigation was apparent to the minds of shipping men in the three great British ports of London, Liverpool and Bristol. Three companies were almost simultaneously organized: the British & American Steam Navigation Company, which made the Thames its headquarters; the Atlantic Steamship Company of Liverpool; and the Great Western Steamship Company of Bristol. Each company set to work to build a wooden paddle steamer in its own port. The first to be launched was the "Great Western," which took the water in the Avon on the 19th of July 1837. On the 14th of October following the "Liverpool" was launched by Messrs Humble, Milcrest & Co., in the port from which she was named, and in May 1838 the Thames-built "British Queen" was successfully floated. The "Great Western" was the first to be made ready for sea.

But the rival ports were determined not to be deterred by delays in getting delivery of their specially built ships. The London company chartered the "Sirius," a 700-ton steamship, from the St George Steam Packet Company, and despatched her from London on the 28th of March 1838. She was thus the first to put to sea. She eventually left Cork on the 4th of April, and reached New York on the 22nd, after a passage of 17 days. The "Great Western" did not leave Bristol till the 8th of April, but under the command of James Hosken, R.N. (1798-1885) she reached New York only a few hours after the "Sirius." The Liverpool people, fired by the action of the other two ports, chartered the "Royal William" from the City of Dublin Steam

Packet Company, and despatched her on the first steam voyage from the Mersey to Sandy Hook on the 5th of July in the same year. The "Liverpool" made her maiden voyage in the following October. But the "British Queen" did not make her initial attempt till the 1st of July 1839. Trouble overtook all three of these early Atlantic lines, and they soon ceased to exist.

Perhaps the most serious factor against them was the success of Mr Samuel Cunard in obtaining the government contract for the conveyance of the mails from Liverpool to Halifax and Boston, with a very large subsidy. The Cunard Line was enabled, and indeed, by the terms of its contract, obliged, to run a regular service with a fleet of four steamships identical in size, power and accommodation. It thus offered conveyance at well-ascertained times and by vessels of known speed. The other companies, with their small fleets of isolated ships and their irregular departures, could not continue the competition. The Atlantic Steamship Company of Liverpool found that the port could not then maintain two steamship lines, and the steamship "Liverpool," with another somewhat similar vessel which they had built, fell into the hands of the P. & O. Company. The Great Western Steamship Company proceeded to build the "Great Britain," an iron screw steamship, which in every way was before her time, and were swamped by financial difficulties, their "Great Western" being sold to the West India Royal Mail Company, to whom she became a very useful servant. The "Great Britain" (which was stranded in Dundrum Bay in September 1846, owing to her captain, Hosken, being misled by a faulty chart and mistaking the lights) eventually drifted into the Australian trade. The London company put a second ship, the "President," on their station. She was lost with all hands, no authentic information as to her end ever being obtained. Her mysterious fate settled the fortunes of her owners, and the "British Queen" was transferred to the Belgian flag. Steam navigation across the Atlantic was now an accomplished fact. But all the three pioneers had been borne down by the difficulties which attend the carrying out of new departures, even when the general principles are sound.

Constant improvement has been the watchword of the ship-owner and the ship-builder, and every decade has seen the ships of its predecessor become obsolete. The mixed paddle and screw leviathan, the "Great Eastern," built in the late 'fifties, was so obviously before her time by some fifty years, and was so under-powered for her size, that she may be left out of our reckoning. Thus, to speak roughly, the 'fifties saw the iron screw replacing the wooden paddle steamer; the later 'sixties brought the compound engine, which effected so great an economy in fuel that the steamship, previously the conveyance of mails and passengers, began to compete with the sailing vessel in the carriage of cargo for long voyages; the 'seventies brought better accommodation for the passenger, with the midship saloon, improved state-rooms, and covered access to smoke-rooms and ladies' cabins; the early 'eighties saw steel replacing iron as the material for ship-building, and before the close of that decade the introduction of the twin-screw rendered break-downs at sea more remote than they had previously been, at the same time giving increased safety in another direction, from the fact that the duplication of machinery facilitated further subdivision of hulls. Now the masts of the huge liners in vogue were no longer useful for their primary purposes, and degenerated first into derrick props and finally into mere signal poles, while the introduction of boat decks gave more shelter to the promenades of the passengers and removed the navigators from the distractions of the social side. The provision of train-to-boat facilities at Liverpool and Southampton in the 'nineties did away with the inconveniences of the tender and the cab. The introduction of the turbine engine at the beginning of the 20th century gave further subdivision of machinery and increase of economy, whereby greater speed became possible and comfort was increased by the reduction of vibration. At the same time the introduction of submarine bell signalling tends to diminish the risk of stranding and collision, whilst wireless telegraphy not only destroys the isolation of the sea but tends

to safety, as was seen by the way in which assistance was called out of the fog when the White Star liner "Republic" was sinking as the result of a collision off Fire Island (1909).

In the following pages some of the ships which first embodied these improvements are mentioned, a brief history of the principal lines is attempted, and reference is made to some of the milestones on the road of improvement.

Allan Line.—The story of the Allan Line is that of the enterprise of one family. Captain Alexander Allan, at the time of the Peninsular War, conveyed stores and cattle to Lisbon for Wellington's army. After 1815 he began to run his vessel between the Clyde and Canada, and as years went on he employed several vessels in the service. Till 1837 the ships ran from Greenock to Montreal, but in that year, after the Clyde was deepened, the ships went to Glasgow, as they have continued to do ever since. Captain Allan and his five sons devoted all their energies to the development of the Canadian trade, and for about forty years the line ran sailing ships only, which were greatly in request for the emigrant traffic. In 1852 the Canadian government requested tenders for a weekly mail service between Great Britain and Canada. That of Sir Hugh Allan of Montreal, one of Captain Allan's sons, was accepted, and the Canadian mail line of steamships came into existence. It may be noted that the Allan Line inaugurated steamers of the "spar-deck" type, *i.e.* with a clear promenade deck above the main deck. This measure of safety was taken as a lesson from the disastrous foundering of the Australian steamship "London" in the Bay of Biscay in the year 1866. The company may claim, too, that their steamship "Buenos Ayrean," built for them in the year 1879 by Messrs Denny of Dumbarton, was the first Atlantic steamship to be constructed of steel. As time went on the company's services were extended to various ports on the eastern shores of North America and in the river Plate; and London, as well as the two strongholds of Glasgow and Liverpool, was taken as a port of departure. In the course of its career it has absorbed the fleet of the old State Line of Glasgow and a great part of the fleet of the Royal Exchange Shipping Company and of the Hill Line. Included in the latter fleet were the first twin-screw steamers constructed for a British North Atlantic line. The "Virginian" and the "Victorian," built for the Allan Line in 1905, were the first transatlantic liners propelled by turbines. The principal ports served by the Allan Line are (in the United Kingdom) Glasgow, Londonderry, Belfast, Liverpool and London; from these their vessels ply to many places in North and South America, including Quebec, Montreal, St Johns (Newfoundland), Halifax, St John (New Brunswick), Portland, Boston, New York, Philadelphia, Baltimore, Montevideo, Buenos Aires and Rosario.

American Line.—Though the American Line, as now constituted, is of comparatively modern origin, it is the successor of several much older organizations. Of these the oldest is the Inman Line, last acquired by it. On the 16th of April 1850 an iron screw steamship of 1609 tons gross register left Glasgow on her maiden trip to New York. This was the beginning of the Inman Line. After a few voyages this ship was sold to Messrs Richardson, Spence & Co. of Liverpool, in which William Inman (1825-1881) was a partner, and the sailings of the steamships were thenceforth for some years between Liverpool and Philadelphia. But in 1857 New York took the place of Philadelphia as a regular terminus. In 1859 the regular call at Queenstown was commenced by this line, which may be said to have been responsible for two other innovations in transatlantic traffic. Before 1850 practically all the steamships crossing the ocean, with the famous exception of the "Great Britain," were paddle-boats. After the advent of the Inman liners the screw began to be everywhere substituted for the paddle. In the second place, the Inman steamers were the first which regularly undertook the conveyance of third-class passengers, to the extinction of the old clipper vessels which had hitherto carried on the traffic. In 1867 the Inman liner "City of Paris" (the first bearing the name) held the westward record with 8 days 4 hours, and in 1869 the "City of Brussels" came home in 7 days 22 hours 3 minutes. Till 1872 these records held good. The "City of Brussels" also had the distinction of being the first Atlantic mail steamer to be fitted with steam steering-gear. About 1875 Mr William Inman turned the concern into a limited company, and in 1886 the business was amalgamated with the International Company, and the vessels, though still flying the red ensign, became the property of a group of United States capitalists, who also acquired the old American Line which had been started in 1873 with four Philadelphia-built steamers. This company had been conducted under the auspices of the Pennsylvania Railroad. It plied between Liverpool and Philadelphia. A third constituent in the Inman and International Steamship Company was the Red Star Line, as the Société Anonyme Belge-Américaine was familiarly called. Its service was from Antwerp to New York. The whole was placed under the management of Messrs Richardson, Spence & Co., who thus after thirty-two years reassumed the direction of the old company. In 1887 the two ships "City of New York" and "City of Paris" were built on the Clyde for the company. At the time of their construction they were the largest vessels ever built, always excepting the

"Great Eastern." The "City of Paris" was the first vessel (1889) to cross the Atlantic in less than six days. The year 1893 was an important one in the history of the company, and indeed of the United States. The two vessels above mentioned were admitted to American registry by Congress, a stipulation being made that two new ships of at least equal tonnage and speed to the pair should be ordered by the company from American firms, and that they should be capable of being employed by the United States government as auxiliary cruisers in case of war. The American flag was hoisted over the "New York" in 1893 by President Harrison, and in the same year the British headquarters of the company were transferred from Liverpool to Southampton. In 1894 the first American-built ocean liner of the new fleet was launched, and was named the "St Louis." In 1898 the American Line had the distinction of supplying the navy of its country with cruisers for use in war. The "St Paul," the only vessel of the four under contract in American waters at the time, was put under the command of Captain Sigsbee, whose own battleship, the "Maine," had been blown up in Havana harbour on the 15th of February. The other three ships were also put into commission, the "Paris" being temporarily renamed the "Yale" and the "New York" the "Harvard." In 1902 with their twin-screw liner "Kensington" the American Line made the first experiments towards fitting Atlantic passenger steamers with appliances for the use of liquid fuel. The express fleet of the line consists of the four vessels, "St Louis" and "St Paul," each of 11,600 tons and a length of 554 ft.; and the "New York" and "Philadelphia," each of 10,800 tons and 560 ft. length. Several still larger but less speedy steamships have been constructed for the intermediate services of the company. In addition to the weekly express service between Southampton and New York, the American Line runs steamers between New York and Antwerp, Philadelphia, Queenstown and Liverpool, and Philadelphia and Antwerp.

Austrian Lloyd Steam Navigation Company.—This company was started in 1837 at Trieste, where its headquarters are still situated. It commenced operations with seven small wooden paddle-boats for the voyage to Constantinople and the Levant. By 1910 they had increased to a fleet of sixty-two iron and steel steamships, with a gross tonnage of about a quarter of a million tons. The whole eastern coast of the Adriatic and the Levant is visited by them with frequent services. There is a line to the west as far as Brazil, and a monthly mail service between Trieste, Brindisi and Bombay. There is also a monthly ordinary service between Trieste, Bombay, China and Japan, and a monthly branch in connexion with it between Colombo, Madras and Calcutta.

Bibby Line.—The name of Bibby has long been known and respected in the shipping world. The first undertaking of the family was the institution of a service from Liverpool to Mediterranean ports about the middle of last century. When Mr (subsequently Sir Edward) Harland took over the ship-building works at Belfast, which he afterwards made famous, Mr Bibby was one of his earliest customers. It was he who gave him practically *carte blanche* in the way of proportion for the new ships built for his service, and it was from the experience acquired and the success achieved with them that the "long ships," with which the White Star Line made its name, were first brought into the region of the practical. In this connexion it may be stated that Sir Edward Harland was born at Scarborough in 1831, his father being a medical practitioner. He learnt the science of ship-building in the yards of Messrs R. Stephenson & Co. of Newcastle, and became first a draughtsman with Messrs J. & G. Thomson, and then manager in a Newcastle yard. In 1854 he went to Belfast, first as manager to Messrs Robert Hickson & Co. Then in 1858 he took over their yard. In 1859 he launched the "Venetian" for Mr Bibby, and in 1860 he took Mr G. W. Wolff into partnership. After a time Mr Bibby retired from the active pursuit of his business, and the line passed into the hands of one of his confidential managers—Mr Leyland (see *Leyland Line*). But the Bibby family, though large shareholders in the White Star Line, could not remain without some active interest in seafaring matters. Hence a new Bibby Line was started. Its first vessel was the "Lancashire," a single-screw steamer of 4244 tons gross register, built—as have been all this fleet—by Messrs Harland & Wolff. She came out in 1889. Her sister was a similar vessel. Subsequent additions to the fleet were all of the twin-screw type; thus the Bibby Line can boast that it was the first to maintain its service, which is now fortnightly, exclusively with twin-screw vessels. In the trade between Liverpool and Rangoon they soon made a name.

The Booth Line is essentially a Liverpool company. It was founded in the year 1866 by Messrs Alfred Booth & Co., who in that year instituted a service to north Brazil. Three years later from the same port was started the Red Cross Line of Messrs R. Singlehurst & Co. to carry on a similar service. In 1901 the two lines were amalgamated under the title of the Booth Steamship Company Limited. Since the year 1882 there has been a connexion by the Booth steamers between north Brazil and New York. Para, Manaus, Maranhão, Paranaíba and Ceará are the chief Brazilian ports served by the company, whilst the steamers make calls on the eastern side of the Atlantic at Cardiff and Havre as well as at Spanish and Portuguese ports. The company carries the British mails to Para

and Manaos, whilst it also takes the United States mails between New York and north Brazil. In addition to its transatlantic passenger traffic the Booth Line is largely developing a tourist trade to Vigo, Oporto and Lisbon in the Peninsula as well as to Madeira. The Yquitos Steamship Company, which is under its management, carries its trade a couple of thousand miles up the River Amazon; a further development will extend to River Plate ports.

British India Steam Navigation Company.—This line maintains, perhaps, a larger network of communications and serves a greater number of ports difficult of access than any in the world. The Persian Gulf, Burma, the Straits of Malacca, and the entire littoral of the East Indies, to say nothing of the east coast of Africa, are among the scenes of its enterprise. Though its ramifications now extend to the ports of northern Australia, the company had its origin in the Indian coasting trade. Its present designation is of comparatively recent origin, but its first operations date from 1855. A project for a mail service between Calcutta and Burma was then first set on foot by the East India Company. Early in the following year a company was formed, under the title of the Calcutta and Burma Steam Navigation Company. Two small steamers of 600 tons each were brought and despatched to India round the Cape in 1857, for a service between Calcutta, Akyab, Rangoon and Moulmein, under a contract with the government of India. At the outbreak of the Mutiny in 1857 the company rendered important service by bringing up from Ceylon to Calcutta the first detachment of European troops which came to the assistance of India from outside. In 1862 an agreement was made between the company and the government, by which the former agreed to convey troops and stores and to perform other services. Under this arrangement steamers were to be despatched regularly from Calcutta to Rangoon, Moulmein, Akyab and Singapore, and from Rangoon to the Andaman Islands. A service was also set on foot to the Persian Gulf, between Bombay and Karachi and Madras and Rangoon. This gave a great impulse to the business of the company. During the Abyssinian campaign of 1867 it proved of the greatest assistance to the government. The opening of the Suez Canal in 1869 produced an entire revolution in the shipping trade of India, and led to a great development of the company's fleet. The s.s. "India" with cargo was waiting at Suez when the canal was opened to traffic, and was the first steamer to arrive in London through the canal with an Indian cargo. In 1872 the company extended its operations to the east coast of Africa, and by an arrangement with the British government began to run a service every four weeks between Aden and Zanzibar. Upwards of one hundred ports are visited by the company's steamers. In all there are twenty-one lines with additional services. They may be classed roughly as those running to ports in (i.) India, Burma and Straits Settlements; (ii.) Straits Settlements and Philippines; (iii.) East Coast of Africa; (iv.) Persian Gulf; (v.) Dutch East Indies and Queensland.

The Canadian Pacific Railway is now one of the big shipping companies of the world, owning, as it does, just under 200,000 tons of steam shipping. Its services divide themselves into several sections. There are those in home waters, such as the Great Lakes, where it employs a fleet of vessels of quite considerable tonnage. Under this head, too, come the local services on the coasts and rivers of the Pacific. Then there are the ocean lines on the Pacific and the Atlantic. The first of these is run from Vancouver via Yokohama and other Japanese ports to Hong-Kong. Sailings are made at about three-weekly intervals. This service is maintained by the three Empresses, the "Empress of India," the "Empress of China" and the "Empress of Japan," sister ships of about 6000 tons and 10,000 i.h.p., specially built with a view to serve as auxiliary cruisers to the British navy in time of war. The great development of the Canadian Pacific, as far as regards ship-owning, took place in 1903, when it took over from Messrs Elder, Dempster & Co. their transatlantic services to Canada. The "deal" affected four twin-screw passenger and cargo steamers, and some ten vessels of a purely cargo type. These steamers ranged in size from the "Monmouth," of just over 4000 tons gross register, to the "Lake Manitoba" of not far short of 10,000 tons. Since their entry into the Atlantic trade the company has added two important mail steamers—the "Empress of Britain" and "Empress of Ireland"—to that side of its fleet.

Castle Line (see also *Union Line* and *Union-Castle Line*).—The Castle Line began its career in 1872 with the "Iceland" and the "Gothland," both vessels of about 1400 tons. At that time the charge for carrying letters to the Cape was about 1s. per half oz., and the contract time between England and the Cape thirty-seven days. The mail contracts were then in the hands of the Union Line exclusively, but in 1873 the House of Commons refused to ratify the extension of the contract signed with them by the chancellor of the exchequer, and their rights thus expired in 1876. Up to 1876 the Cape parliament made an allowance to the Castle Line for the conveyance of letters, and when the postal contract was renewed in that year it was divided between the Union and the Castle lines, an arrangement which was adhered to down to the time when the two lines united their fortunes. The scope of the company's energies has now been extended to all parts of South Africa. The line did great national service in carrying troops and stores to South Africa during the 1899-1902 and previous campaigns. By a resolution passed

at a meeting of shareholders held on the 13th of February 1900 this company was amalgamated with the Union Line. The fleet had grown from two ships in 1876 to twenty ships in 1900, and from a total tonnage of 2800 to one of about 110,000 gross register.

City of Dublin Steam Packet Company.—Among the steamship services in the narrow seas round Great Britain a special interest attaches to this company, which vies with the General Steam Navigation Company in the claim for seniority. The General Steam was undoubtedly the first to receive incorporation in the year 1824, but the undertakings from which the City of Dublin Company sprang were at work in the years immediately prior to these dates. As far as appears, the firm of Bourne & Co.—who fulfilled in Ireland functions for which the Messageries Impériales in France were first formed—were large shareholders in two undertakings which made history in regard to the development of steam navigation. One of these companies was the Dublin & London Steam Packet Company, from which Messrs Wilcox & Anderson, the first managers of the P. & O., chartered the "Royal Tar," the first steamer they despatched to the Peninsula, and the other was the City of Dublin Company, which originally occupied itself in the maintenance of a service of steamships between Dublin and Liverpool. It was this company's "Royal William" which had the distinction of opening the Liverpool service to New York. By absorption, too, this company represents the old St George Company, whose "Sirius" was the first steamer to sail from London towards New York. In the year 1838 the admiralty, which in those days had the management of many of the mail services and continued for a time to keep the Irish day mails in its own hands, gave the City of Dublin Company the contract for the night Irish mails, which were thus despatched via Liverpool. The name of Laird is to this day closely associated with the fortunes of the company, and even at that time a Mr Laird, grandfather of the present partners in the ship-building firm, was a director of the City of Dublin Company. In the year 1848 the government with four steamers endeavoured to run the day and night mails itself via Holyhead. But this arrangement did not work well, and two of its mail steamers were bought by the City of Dublin Company, while the two others were acquired by the Chester & Holyhead railway. It is needless to follow the vicissitudes of the mail service, wavering as it did from the admiralty to the Chester & Holyhead railway, and then to the City of Dublin Company. Suffice it to say that in 1859 an arrangement was entered into whereby the City of Dublin Company undertook the conveyance of both day and night mails via Holyhead, and built four ships, called after the four Irish provinces, for the service. The performances of these four paddle-ships, three of which were built by Messrs Laird, were remarkable indeed. The "Connaught" was the first vessel to do her 18 knots. The "Ulster" made the best passage of them all—doing the journey from Holyhead and Kingston in 3 hours 18 minutes. But the "Leinster" was only two minutes behind her, and the "Munster" only six minutes worse than the "Leinster." Taking the performances of the whole four vessels over the first fourteen years of their existence, and considering the mean of 20,440 passages made as well in winter as in summer, the average time of passage was only 3 hours 56.1 minutes. The contract was renewed from time to time, that coming into operation on the 1st of October 1883 being for an accelerated service. To enable this to be adequately performed, the last paddle-ship of the fleet, the "Ireland," was built by Messrs Laird, who also overhauled and improved the machinery of the older vessels, giving them new boilers adapted for the use of forced draught. In 1895 it was felt that the mode of carrying these important mails again needed revision, and in that year the House of Commons approved of a new contract, under which four new twin-screw vessels were to be built for the service. The work of design and construction was again undertaken by Messrs Laird, and in 1897 the new fleet assumed the duties, and indeed the names, of the vessels which had done such remarkable service during a period of about thirty-eight years. The contract time was now decreased by half an hour, and this meant naturally a very great increase in the speed of the vessels employed. The present ships, capable of a speed of about 24 knots, maintain however with regularity and ease the 20 to 21 knots which are required. Besides the night and day services with the mails the company also maintains its old line between Liverpool and Dublin.

Compagnie Générale Transatlantique.—A French undertaking known as the Compagnie Générale Maritime was founded in 1855. It owed its inception to the brothers Emile and Isaac Pereire. Services were first organized from Rouen to Algeria, between Havre and Hamburg, and between Marseilles and Antwerp, with calls at Spanish and Portuguese ports. In 1861 the company was allowed to change its title to the more comprehensive one under which it is now known, and it then undertook its first contracts for the carriage of the French mails to the United States, the Antilles and Mexico. Some of the earlier vessels employed in the New York service were very fine specimens of the naval architecture of their day. Among them may be instanced the great iron paddle-steamer "Napoleon III.," built in the year 1864 by Messrs Scott & Co. of Greenock, who at that time constructed most of the more important vessels for this service. This vessel with her imperially titled sisters suffered a change of name in the early 'seventies, when several of them were lengthened and altered to screws. In the year 1881, again, there was

a great movement towards the acceleration and improvement of the New York service, and a new fleet was begun with the single-screw steamship "La Normandie," launched at Barrow-in-Furness in 1883. Four larger vessels of much the same class followed, three of them being constructed in the owners' own yard at Penhoet. In 1890 the first twin-screw steamer of the line appeared in "La Touraine," and proving a success, the British-built "L'Aquitaine" was purchased. A new postal contract was arranged in 1898, and under its terms it became necessary for the company to build still larger and faster vessels. Eventually four such ships were to be provided. These vessels are of 22 knots speed on trial, and are among the fastest on the Atlantic. The company maintains a weekly service to New York, as well as the lines to the Antilles and Mexico in the Atlantic. There are also communications with British and Algerian ports.

Cunard Line.—This company derives its name from Samuel Cunard of Halifax, Nova Scotia, an owner of sailing vessels trading from Boston and Newfoundland to Bermuda. He first conceived the idea of a regular despatch of royal mail steamships across the Atlantic, to take the place of the government brigs, which often took six or seven weeks in the transport of mails. This idea he realized with the help of Mr George Burns of Glasgow and Mr David MacIver of Liverpool. On the 4th of July 1840 the first Cunarder, the "Britannia," started on her voyage across the Atlantic with sixty-three passengers, landing them at Boston in a fortnight. The experiment of using the screw for the Atlantic service was made with several cargo steamers in the early 'fifties, and the first Cunard screw steamer for the mail line made her debut in 1862. This was the "China," the gross tonnage of which was 2539, her i.h.p. 2250, and her average speed 13.9 knots. In 1870 the Cunard Company first fitted compound engines to their steamship "Batavia," and in 1881 the "Servia," the first steel vessel in the service, was the pioneer of the larger type which constitutes the present express fleet. Since 1840 the Cunard Company has been under contract with the British government for a mail service. At the present time the contract is for a weekly mail to the United States, via Liverpool and New York. The British post office, however, only pays its contractors for the weight of mails actually carried, and reserves the right to send specially addressed letters by foreign ships. The company's services also include a passenger line to Boston, and frequent despatches to Mediterranean and Levant ports as well as a weekly steamer to Havre, and a passenger service from the Mediterranean to New York. In October 1902, as a result of the formation of the Morgan Shipping Trust, the British government made a new arrangement with the Cunard Line, involving the loan at 2½% of the capital for building two new fast steamers, besides a yearly subsidy of £150,000 for twenty years. The company showed its confidence in the turbine system—then in its infancy—by adopting this principle for these two vessels, the largest and fastest at that time contemplated. The advance in size and power of Atlantic steamships is evidenced by the following comparison:—

		Speed.	Tonnage.	H.P.
1884	"Umbria" and "Etruria"	19	8,127	14,500
1893	"Campania" and "Lucania"	22	12,952	30,000
1907	"Lusitania" and "Mauritania"	25	30,830	68,000

Elder, Dempster & Co.—The remarkable progress of this company, and of the undertakings connected with it, was largely due to the activity of the late Sir Alfred Jones. The oldest business under its management is the African Steamship Company, which was incorporated by royal charter in the year 1852 for the purpose of trading with West African ports. It received a subvention of £30,000 per annum for a monthly mail to the Gold Coast, and began its work with an unambitious little fleet of four 700-ton vessels. These were at first, however, equal to all the traffic which the trade could offer them. As time went on the number and size of the vessels employed was increased. In 1869 such progress had been made that it appeared worth while to start an opposition line under the name of the British and African Steam Navigation Company. This was at first a Glasgow venture, much in the same way as the old concern had made its headquarters in London. But Liverpool has long been the centre of the West African trade, and both companies practically transferred their business thither. In the year 1883 the British & African Company, which was the first of the two to fall under the management of Messrs Elder, Dempster & Company, became a limited company, and not long afterwards the two rivals arrived at a working arrangement whereby their sailings—at that time about three times a fortnight—were worked into one another. The Canary Islands, where the West African steamers called on their voyages, were then becoming known as a resort for tourists and invalids, and the issue of tickets available by either line was commenced for their convenience. The development of the cultivation of the banana for the English market was also begun to be encouraged by the two steamship companies.

But it was in the month of August 1891 that the great movement by the Elder-Dempster Company was made public. It was then announced that the firm had assumed the management of the African Company. The two concerns were, and are, continued as distinct organizations, but they naturally work very closely together. The African Company soon began to break fresh ground, building not only superior vessels for the improving West African service, but also constructing large cargo vessels for the general Atlantic trade. These were soon engaged in the trade between the Mersey and the St Lawrence on the one hand, and between Liverpool and the southern ports of the United States on the other. Meanwhile the development of the possibilities of West Africa and of the Canary Islands was not neglected. Various undertakings, not usually considered part of a shipowner's work, were inaugurated. These included a bank, founded in 1894, for the accommodation of West African traders, oil-mills in Liverpool, where the palm kernels so largely consigned from the coast might be dealt with, and a hotel at Grand Canary for the convenience of the tourist; while, to ensure the disposal of the bananas which their companies brought to England, a fruit brokerage business was opened in Covent Garden. Having already, as has been seen, a footing in the Canadian trade, they began the restoration of the Atlantic trade to Bristol, by giving it a service of steamships to the St Lawrence, employing for the purpose vessels of as great size as their docks could accommodate. At the beginning of 1899 they further strengthened their connexion with the nearest British colony by the purchase, from the liquidator of the insolvent Canada Shipping Company, of the name, house-flag and remains of the old Beaver Line. A new fleet for this service was at once put in hand, a fair representative of the ships being the twin-screw "Lake Erie," a vessel of 7550 tons gross register, built in 1900 by Messrs Barclay, Curle & Co. of Glasgow, which did good work—with many other Elder-Dempster steamers—in the transport service during the Boer War. The Canadian steamers were however in 1903 transferred to the Canadian Pacific railway. At the beginning of the 20th century the firm began trading with the West Indies. By arrangement with the colonial office, for an annual subsidy of £40,000, the "Direct" service of fortnightly steamships was started with the sailing from Avonmouth of the then newly built "Port Morant" in February 1901. The steamships of the new line have good passenger accommodation and hotels were acquired in Jamaica to provide accommodation for those who wished to visit the West Indies under the new management. This provision for tourists was a novel feature. The increase, at once absolute and comparative, in the tonnage of the Elder-Dempster fleet has been very remarkable. On the death of Sir Alfred Jones a limited company was established under the direction of Lord Pirrie, of the great ship-building firm of Harland & Wolff, and of Sir Owen Philipps, chairman of the Royal Mail Steam Packet Company, to carry on the Elder-Dempster Company and take over the various interests concerned. The vessels of the West African lines ply as well from Hamburg and other North Sea continental ports as from Liverpool, while closely connected with the firm, though sailing its vessels under the Belgian flag, is the Compagnie Belge Maritime du Congo, which runs a service from Antwerp to West African ports.

Ellerman Line.—"Lloyd's Register of Shipping" in its issue for 1901-1902 contains no reference to the Ellerman Line. For unlike most other shipping companies it sprang into being in a moment. It was started when Mr (afterwards Sir) John Ellerman, chairman of the Leyland Line, severed his connexion with that company and went his own way, taking with him some nineteen vessels of the fleet, and the Peninsula and Mediterranean connexions of the old company. Forthwith he added to the tale of his ships by taking over the management of the seven steamers of the Papanian Line—which has also long maintained a service to Mediterranean ports. Nine steamers previously managed by Messrs Westcott & Laurence also came into the fold. But this was not all; the direction of two old-established lines to Indian ports was also acquired. These were the fleet of the City Line, which at that time comprised some fifteen vessels, many of them fitted for the passenger trade. This line had been founded by Messrs George Smith & Sons of Glasgow in the first half of the 19th century and had grown up out of a fleet of sailing vessels. The other was the Hall Line of Liverpool, previously managed by Messrs Robert Alexander & Co. It consisted of some eleven steamships of about 4000 tons gross apiece. The various sailings of these different companies have all been maintained and extended, and in 1910, in conjunction with the Harrison and Clan lines, a new development up the East Coast of Africa towards Zanzibar and Mombasa was organized.

The Leyland Line may be said to date from the year 1851, when the first Mr Bibby founded his steamship line with the small vessels "Arno" and "Tiber" for service to the Mediterranean (see *Bibby Line* above). The company extended its business to the North Atlantic and in the early 'seventies changed its name, Mr F. R. Leyland, one of its managers, assuming the control. On his death in 1892 the concern became a limited company. In 1900 it purchased the fleet and connexions of the West India & Pacific Steamship Company—a business which had been founded nearly forty years previously in Liverpool and which served, beside many West

India Islands, the cotton ports of Galveston and New Orleans, having also a connexion to Colon for places on the western coast of America. This company at the date of its absorption had a fleet of twenty-two steamships totalling over 111,000 tons gross register. This amalgamation was the first step towards the great American combine. Mr Ellerman, however, who was chairman of the old Leyland Company, separated himself from it at this juncture, and founded his own line. The Leyland Company had a number of transatlantic services.

General Steam Navigation Company.—This is the oldest existing line. Its first prospectus was issued in 1824, and in 1831 it received its charter of incorporation. It commenced with the passenger trade from London to Margate, and its operations gradually extended to the British coastwise ports and the home trade ports on the Continent. In time the company introduced a regular steam service between Edinburgh and other east coast ports and London, Hamburg, Rotterdam, Antwerp and Havre in the north of Europe. It gradually obtained a strong hold upon the passenger and fine goods trade to the Continent, holding the mail contracts between London and Hamburg, and London and Rotterdam. In the early 'seventies the pressure of foreign competition made itself severely felt, and in 1876 the increase of the American cattle trade told on the profits of the company; but the difficulty was met by obtaining parliamentary leave for an increase of capital, and the company had displayed new enterprise, especially in regard to its passenger facilities. It may claim to have been the pioneer in the promotion of steamship traffic between British home ports and the nearer ones of the Continent. The steamship "Giraffe," built in 1836, brought over the first cargo of live cattle from Rotterdam to Blackwall in 1846. The company runs steamers from London to Edinburgh, Hull and Yarmouth, and from London to Antwerp, Amsterdam, Bordeaux, Havre, Hamburg, Oporto, Ostend, Rotterdam, Charente and the Mediterranean ports. Vessels are also run to some of the ports above-named from Hull and Southampton. There is also a passenger service between Harwich and Hamburg, and excursion services in summer to the watering-places at the mouth of the Thames and on the Kentish coast.

Hamburg-American Line.—The extraordinary progress of Hamburg as a seaport during the last thirty years of the 19th century may be held due in no small measure to the enterprise of this line, which now carries passengers not only to the two American continents, but also to the east of Asia and Africa. It was founded in May 1847. At that time, owing to the political disturbances throughout Germany, there was an enormous exodus of emigrants to the new world; of this the founders took advantage, and they started a regular service of sailing ships between Hamburg and New York. The first ship they owned was the "Deutschland," of 700 tons, built on the Elbe. It is interesting to note that the present "Deutschland" is of 16,502 tons gross register, and is of twenty-three times the capacity of her predecessor. The first sailing took place in October 1848. In 1851 the company's fleet consisted of six vessels, with an aggregate of 4000 tons. In 1856 the first screw steamer in the company's service left Hamburg; this was the "Borussia," a vessel constructed, as were her sisters for many years, on the Clyde. From this time, when the company abandoned sailing ships and took to steam, its prosperity may be said to have dated. It is strange to note that the two first steamships owned by it were chartered by the British and French governments to convey troops to the Crimea. By 1867 the company had ceased to own any sailing ships. The enormous increase of the traffic is indicated by the fact that whilst in 1856 the sailings to New York took place every fortnight, in 1881 there were two a week, and later on three. The company had also by this time considerably extended its operations from the original passage between Hamburg and New York. After the war between France and Germany it started a line to the West Indies, and later to Baltimore, Boston, Montreal and other ports in North America. In 1875 it absorbed the old Eagle Company of Hamburg, which had previously been its rival, and then began to run steamers to Central and South America, and later to China, Japan and the Straits Settlements. To-day the Hamburg-American Line may claim to be the largest steamship company in the world. For its services to New York run by twin-screw steamers it has the "Deutschland," built at Stettin by the Vulcan Company. Her engines develop about 33,000 horse-power, and she was the first Atlantic liner to exceed a speed of 23 knots at sea. Other large steamers built for its Hamburg-Southampton-New York service are the "Kaiserin Augusta Victoria" and the "Amerika," which, though larger, has not the "Deutschland's" speed. A service from Hamburg to New York direct for third-class passengers only is also maintained. The Hamburg Company has extended its influence and enlarged its fleet by purchases from and absorptions of other fleets. Thus it has acquired vessels from the Carr Line and the Hansa Line of Hamburg, the Rickmers Line of Bremen, as well as from the Hamburg South America and the Hamburg-Calcutta companies. In conjunction with the Lloyd Line it took over the fleet of the Kinsing Line. In 1901, with a view to the feeding of its main lines, it acquired the Atlas Line of Liverpool—a company which had developed the trade between New York and the West Indies. Starting from Hamburg, its vessels run to New York, Portland, Baltimore, Boston, Philadelphia,

Galveston and New Orleans, and to Canadian ports. In Central and Southern America, there are lines to Mexico, Venezuela, Brazil, Uruguay and Argentina. Amongst the West Indian Islands Cuba receives special attention from this line. There is a service to Eastern Asia, China and Japan. From Stettin its steamers run to New York, and from New York to the Mediterranean, Brazil and Eastern Asia. From Genoa they run to La Plata direct.

Japan Mail Steamship Company, Limited (Nippon Yusen Kaisha).—From an early period their insular frontiers made the Japanese a seafaring folk, but imperial policy for a long period shut them away from all intercourse with the rest of the world. It was not until about the year 1860 that the life of the West really touched Japan. In 1868 steamship communication was opened between Tōkyō and Osaka; in 1871 the Yubin Kisen Kaisha Steamship Company came into existence under the control of the Imperial Bureau of Communication; and in the same year a private company, called the Mitsubishi Kaisha, was founded. This may be said to have been the beginning of all modern maritime enterprises in Japan. In 1876 the government company gave up the contest, and its fleet passed into the hands of the private company. In 1873 the capacities of this company had been tested in the military expedition to Formosa, when its organization had been found excellent, but its fleet insufficient. The treasury now invited the company to buy up the Yokohama-Shanghai service of the Pacific Mail Steamship Company. In 1876 the company had a fleet of forty-two vessels, including sailing ships. In 1882 the government set on foot another rival line, the Kyodo Unyu Kaisha, but it did not answer, and in 1885 the two were amalgamated into the present "Nippon Yusen Kaisha," or "Japan Mail Steamship Company." In the nine years which passed between this union and the outbreak of the war with China in 1894, the services between Japan and neighbouring countries were extended, and the development of the cotton trade induced the government to inaugurate a service between Japan and Bombay. During the war the vessels of the line were used for the transport of troops, and many additional ships had to be acquired. The result of the war gave an enormous impulse to trade and navigation. The company determined to run vessels to America, Europe and Australia. The capital was greatly increased, and orders were given for the construction of twelve twin-screw steamers of over 6000 tons each for the European line, and three of 3800 tons each for the Australian line. In 1899 the Japanese Diet resolved to grant subsidies to the company's European and American lines. All its lines therefore now, with few exceptions, run under the mail contract of the Japanese government. There is a regular fortnightly service of twin-screw vessels between Yokohama, London and Antwerp; a monthly service between Yokohama and Melbourne; also between Yokohama and Victoria (British Columbia). There are lines to Bombay, Shanghai, Vladivostok, Newchang, Tientsin, and many local lines, touching at all the ports of the islands of Japan.

Royal Mail Steam Packet Company.—Soon after British-owned steamships began to run to America a company was formed by leading business men interested in the West Indies, to carry the mails from England to that part of the world. The charter of this company, to be known as the Royal Mail Steam Packet Company, was granted in 1839. The government believed that the institution of a line carrying the mails regularly to British possessions in the West Indies was likely to prove of benefit to the empire, and granted it a large subsidy. The first contract with the government was entered into in March 1841. No less than fourteen large paddle-steamers capable of carrying the largest guns then used by the Royal Navy were at once ordered, and the service was opened with the "Thames" on the 3rd of January 1842, followed by other vessels in fortnightly succession. These steamers started from Falmouth and returned to Southampton, which was the company's headquarters, though it had no dock accommodation in those days. In 1846 the company began to carry the mails for places on the western coast of South America, the Pacific Steam Navigation Company receiving them at Panama. In January 1851, the company by contract with the government inaugurated a monthly service to Brazil and the river Plate, and new steamers were built which greatly increased the rapidity of transit. This company was therefore the first to institute direct mail communication by steamer between Europe and the countries of South America, as it had also been with the West Indies. The company's vessels were employed continuously during the Crimean War in the transport of troops. It is interesting to note that it was from one of the company's ships, the "Trent," that Slidell and Mason, the commissioners of the Confederate states, were taken on their way to Europe by a United States man-of-war. In 1872 the service to Brazil and the River Plate was doubled. At the beginning of the 20th century the company seemed to be on the downward grade. But a change came over its fortunes. A new chairman, Sir Owen Philipps, took over the reins and new enterprises were started in several directions. The interest of the Pacific Steam Navigation Company in the Orient-Pacific Line to Australia was purchased in January 1906, and steamers despatched once a month from London to Australia through the Suez Canal. This enterprise, however, was discontinued when the new mail contract came into force in May

1909. New twin-screw steamships of much greater tonnage than any they had hitherto owned were constructed for the mail service to South America, and an extension was made into the tourist and cargo trade to Morocco, Madeira and the Canary Islands by the purchase of the old-established Forwood Line. Part of the fleet of the Shire Line to the Far East was also acquired. But the great development took place at the beginning of 1910, when the directors made the startling announcement that they had purchased the whole of the share capital of the Pacific Steam Navigation Company—a business established in Liverpool only a year after the grant of their own royal charter. This absorption brought some forty ships—many of them modern twin-screw steamships of a high class—into the fleet, which was then placed amongst the big lines of the world. Another move was made when Sir Owen Philipps joined Lord Pirrie in organizing a company to take over the numerous enterprises of Sir Alfred Jones. The West India Line steamers leave Southampton for the West Indies every fortnight, and after calling at Cherbourg proceed direct to Barbadoes, thence to Jamaica and Colon, whence they proceed to Savanilla and other local ports. From Barbadoes, Trinidad, La Guaira, branch lines run to Demerara and the islands. The Brazil and River Plate Line comprises a fortnightly service of mail steamers to Pernambuco, Bahia, Rio, Montevideo and Buenos Aires. The Shire Line steamers sail to the Far East every fortnight, as do those of the Islands service, whilst the Pacific Line despatches twin-screw passenger steamers and large cargo vessels alternate weeks from Liverpool to South American ports, besides maintaining local services up the West Coast. There are also cargo services to the West Indies and Mexico, and to the River Plate and intermediate ports.

Messageries Maritimes de France.—Originally known as the Messageries Impériales, this company sprang from a land-transit undertaking. It received its first contract for the conveyance of oversea mails from the French government in 1851. It then extended its services to Italian, Greek, Egyptian and Syrian ports. In the following year it included Salonica in its itinerary. The occurrence of the Crimean War gave an increase to its fleet and a stimulus to its operations. For it was not only given the task of maintaining mail communication with the French forces in the Black Sea, but was largely entrusted by the government with the duty of transporting troops and stores to the seat of war. At that time it was a considerable purchaser of British tonnage. In 1857 it had the French mail contract to Algiers, as well as to the Danube and Black Sea ports, whilst in the same year a new mail contract for a service between Bordeaux and Brazil and the river Plate was granted to it. By this time it had, either afloat or under construction, a fleet of no less than fifty-four steamships of 80,875 tons. In 1861 further employment was found for its vessels in the conveyance of the mail to India and China. By the year 1875 its fleet embraced 175,000 tons of shipping, and also employed a large number of chartered sailing vessels. It was at that time the largest steam shipping company in the world. It had already ceased to employ British shipbuilders and now constructed its own tonnage in its own yards. The extension of its services to Japan followed, and eventually it put forth branches which served Madagascar, Mauritius and Zanzibar, as well as Australian ports and the French colony of New Caledonia. Some of the steamers employed in the mail services to the Far East and South are of a very fine character. In 1909 its fleet traversed 1,019,046 marine leagues and carried 197,320 passengers and over a million tons of cargo.

Morgan Combination.—Under the head of the *American Line* it has been shown how a group of American capitalists acquired the Red Star, Inman and American lines, thus forming a body of shipping which embraced in the year 1901 about 167,000 tons of shipping tonnage, partly under the British and partly under the Belgian and American flags. Another company which drew its capital chiefly from the United States, though its vessels fly the red ensign, is the Atlantic Transport Company, registered under the British Limited Liability Acts in 1889. Its main service is between London and New York, and it is carried on by large and modern twin-screw steamships, several of which have been constructed by Messrs Harland & Wolff of Belfast. These vessels range up to about 14,000 tons gross register, and though they carry large quantities of cargo and of cattle on the eastward voyage, also accommodate a number of passengers in their saloons. Through the connexion of this undertaking with Messrs Harland & Wolff as builders of their vessels, those American capitalists who were interested in the extension of United States interests on the North Atlantic and who purchased the share capital of the Leyland Line were brought into connexion with Lord Pirrie, the managing director of this ship-building firm, and through him approach was made to the managers of the White Star Line in the year 1901. An offer for the purchase of this famous British line was put forward by the American syndicate, headed by Mr J. Pierpont Morgan. The managers of the White Star Company had not merely to consider what many experts believed to be a liberal offer. There was another factor in the situation present to their mind. The New York syndicate, besides having the control of the vessels of the American lines on the Atlantic, had, it was said, secured the management of the trunk lines of railway between the great producing districts of the Western states of America and the eastern seaboard. They

were thus in a position to give to shippers from the United States both the railway journey and the ocean voyage, and there was ground for the belief that if competition were allowed to ensue the British steamship companies—which from the nature of things could receive no corresponding support from the railways of the United Kingdom—might suffer very severely. The White Star Line accordingly threw in its lot with the American and Atlantic Transport Companies, and with the White Star Line went the Dominion Company—a line whose fine passenger vessels were constructed by Messrs Harland & Wolff, and whose management is largely influenced by the partners in that firm. The Dominion Line has services from Liverpool to Boston, Portland (Maine), and St Lawrence ports. The Norddeutscher Lloyd and the Hamburg-American companies were approached by Mr Morgan with a view to their entering into the scheme; but though a working agreement was arranged, the German lines decided to preserve their separate existence. The Morgan combination was eventually incorporated at the end of September 1902 in New Jersey as “The International Mercantile Marine Company,” with a capital of \$120,000,000; and an agreement was come to with the British government, by which the British character of the British ships in it would be preserved. The combine controls about a million tons of steamships.

Navigazione Generale Italiana.—The union of the Florio and Rubattino lines in the year 1882 was the origin of this company. The Rubattino Line finally made Genoa its headquarters, while the Florio Line centred its business at Palermo, and had itself been largely strengthened by the absorption of the Trinacria Company of its own port. The coasting trade of Italy and Sicily, with services to various ports of the Mediterranean and Black Seas, occupies the great part of the company's fleet. But it also runs monthly lines from Genoa through the Suez Canal to Red Sea ports, and so to India and Hong-Kong. Towards the western ocean it has a service maintained in conjunction with that of another Italian company, La Veloce, to Brazil and the River Plate, whereby weekly departures are made from Genoa. In February 1901 a new line was opened by the sailing of the Italian Generale Company's steamship “Liguria”—a new Italian-built vessel of upwards of 5000 tons register—for New York. The object of this line, which is maintained by steamers of the Generale Company, aided by a similar number from the fleet of La Veloce, sailing once a week from Genoa via Naples, is to attempt to retain in Italian hands some of the large traffic which is carried on from these ports in the steamers of the Norddeutscher Lloyd, the Hamburg-American Line, the Cunard and White Star lines.

New Zealand Shipping Company.—This company was established in 1872 for the purpose of maintaining a passenger and cargo service between London and New Zealand. This was before the days when steam vessels could be used with commercial success in the long sea trade. At first it depended on chartered vessels, but gradually it acquired a fleet of fast clipper iron sailing-ships which reduced the voyage to 90 days. These vessels took out a large number of government emigrants between 1874 and 1882. In 1881 one of these ships inaugurated the frozen meat trade from New Zealand, thus opening up a business which has since grown to colossal proportions. The trade increased so rapidly that it was found impossible to conduct it by means of sailing ships, and in January 1883 the company despatched from London the chartered steamship “British King,” of 3559 tons. This vessel accomplished the voyage in 50 days, but it was found necessary to diminish the passage to 45 days out and 42 home. Five steamers were therefore built to fulfil the requirements of the trade. The first of these, the “Tongariro,” of 4163 tons, left England in October 1883. The company about this time received the contract of the New Zealand government for a monthly mail service, with a guaranteed time of 45 days. The managers gradually eliminated all the sailing vessels from the fleet, and more recently replaced the original single-screw mail steamers with large modern twin-screws. In addition to passenger vessels the company owns several cargo boats, some of which are among the largest afloat. In the “Otaki” triple-screw vessel, added to the fleet in 1907, the company initiated a combination of reciprocating engines for using the high-pressure steam and turbines to make use of it subsequently. The company's ships sail from London, calling at Plymouth, Teneriffe, Cape Town, Hobart, on the way out, and sometimes at Montevideo or Rio and Teneriffe on the return voyage. Communication with the different ports of New Zealand, as well as to Australian ports, is carried out by the vessels of the Union Steamship Company of New Zealand.

Norddeutscher Lloyd.—To the enterprise of certain citizens in the city of Bremen this large business owes its existence. The originator was Herr H. H. Meier, who brought into line the various shipping interests of Bremen, and induced them to amalgamate into one company. The associations thus brought together were the Weser Haute Steamship Company, the Unter Weser and Ober Weser Steam Tug Companies and the Ober Weser Universal Shipping Insurance Association. The statutes of the new company were approved by the senate of Bremen on the 18th of February 1857. The original capital was 4,000,000 thalers, but soon after the formation of the new company great depression set in, owing to the commercial crisis in North America. More

than 2500 shareholders in the Lloyd forfeited their shares, but the directors were not dismayed, and had the loyal support of their fellow citizens. Four big ocean steamers were constructed for the American line and three for the English, and large docks for repairs were established at Bremerhaven. The first voyage was made in June 1858, when the "Bremen" started for New York, carrying many steerage passengers, but only one in the saloon. The second ship, the "Hudson," was shortly afterwards burned while lying in harbour. At the end of the first year both lines showed a loss. At the end of the second year matters improved, the English cattle trade especially showing great progress. But the company still commanded little confidence, for the Darmstadt Bank parted with 1,000,000 thalers' worth of shares at a loss of 75%. These the directors themselves took over. But the American Civil War now came, to deal another severe blow at the Lloyd, just when its prospects were growing brighter, and till 1864 no dividend greater than 2½% was paid to the shareholders. After the termination of the war the trade with the United States grew enormously, and the English traffic also revived in a most unexpected way. One result was the foundation of rival lines, which, however, were unable to maintain effective competition, and succumbed. In 1868 a new line was opened. Bremen's staple of commerce is tobacco, and the directors determined to bring their port into direct communication with the tobacco-producing areas in the States; so in that year they inaugurated their line to Baltimore. In the following year a line was started to New Orleans, another great centre of the tobacco and cotton trade. It was necessary to construct three special liners for that service, as the ordinary ships could not pass the bar of the Mississippi. In 1869 a line to Central America and the West Indies was set on foot, and new steamers were ordered to run on it. With the outbreak of the war of 1870 the company naturally had anxious times, as the French fleet blockaded the German coasts; but its vessels often ran the blockade with success. Soon after the war the West Indian service, proving unprofitable, was given up. In 1875 a new line of steamers to Brazil and Argentina was started. This was separated into two distinct services in 1878. In 1880 the approach of the great struggle for supremacy on the Atlantic made itself felt, and the company began to prepare for the contest, and ordered the construction of the "Elbe," the first of its express line of steamers. She commenced running in 1881, and was quickly followed by others. Between 1881 and 1888 an entirely new fleet was placed on the New York line. In 1886 the Australian and East Asian Lines were founded in accordance with a contract with the imperial government. This included a monthly service to China, with a branch service to Japan, and a monthly service to Australia, with a branch line to the Samoan and Tonga Islands. From that time onwards the story of the Norddeutscher Lloyd has been one of increased prosperity. The company's fleet includes four large and fast steamships of about 23 to 23½ knots speed for its weekly express service to New York, whilst it has also large vessels—one, the "George Washington," being of 27,000 tons—for its intermediate service to the same port, built by the Vulcan Company at Stettin. The company runs many lines from its headquarters at Bremen; among them are those to New York—a line of express steamers and a line of ordinary mail steamers, all calling at Southampton or Cherbourg; to Baltimore direct; to Galveston direct—there are no first-class passengers by this line; to Brazil; to the River Plate, calling at principal ports on the way. There are also lines of imperial mail steamers between Bremen and Hamburg and eastern Asia, and Bremen and Australia, and a freight line to east Asia, which runs in connexion with the Hamburg-American Line. In pursuance of the German policy of securing the feeders to maintain traffic, the Norddeutscher Lloyd purchased the ships and business of the Kinsing Line and of the Scottish Oriental Company, when it began seriously to develop its Eastern trade. Feeling in common with all large steamship companies the difficulty of providing efficient personnel for its constantly expanding fleet, and believing in the necessity for seamen of experience in masted ships, the Lloyd has provided itself with a sea-going training-ship. Such success attended this experiment that a second vessel has been added and the idea has since commended itself to certain British steamship companies.

Ocean Steamship Company.—The Ocean Steamship Company is the successor of older steamship enterprises, mainly under the same management and ownership. These began in 1852 with the coasting trade, and extended in following years to French ports, and in 1855 to the West Indies. The last-named line attained some moderate importance, comprising seven vessels; it was sold in 1863, and eventually became the West India & Pacific Steamship Company, which in its turn was absorbed by the Leyland Line in 1900. The managers thereupon, seeking other trades, decided on attempting that to China, and the company under its present title was registered as unlimited in 1875. Up to this date low-pressure jet-condensing engines were alone used, burning perhaps 5 to 5½ lb of coal per indicated horse-power per hour. This rate of consumption would have been fatal to the scheme, since vessels could not have carried any cargo in addition to the coal necessary for so long a voyage as that via the Cape, the Suez Canal not being opened till 1870. A small vessel, the "Cleator," of which the exact speed and consumption with the old type of engine was well known,

was therefore experimentally fitted with new machinery of the compound high-pressure (70 lb), surface-condensing type. The result of the experiment was that her consumption was reduced to about 3 or 3½ lb per i.h.p. per hour, and this warranted the construction of the "Agamemnon," "Ajax" and "Achilles," all 309 ft. long, 38 ft. 6 in. broad, 28 ft. 6 in. deep, fully rigged as barques, with screws outside their rudders. These rigs were subsequently altered to that of barquentines, but the relative positions of the screws and rudders were retained till they were disposed of in 1899. In these vessels the consumption was further reduced to about 2½ lb, which allowed margin for a reasonable cargo. The "Agamemnon" sailed from Liverpool in 1866; the itinerary being Mauritius, Penang, Singapore, Hong-Kong and Shanghai, and, with similar calls, back to London. The cargoes in those days were mainly manufactured goods outwards and tea homewards. The average speed was perhaps 9½ knots, and the consumption about 21½ tons of Welsh coal per day. These and succeeding steamers were at that date the only vessels carrying high-pressure steam on long voyages, and they traded regularly round the Cape, being the only line that did so. When the Suez Canal was opened in 1870 they changed the route. The trade from the United Kingdom to China has since steadily grown, and increasingly large cargoes are also procurable homewards from the Far East, in spite of the successful competition of Indian and Ceylon teas. In 1891 a service was begun from Amsterdam and Liverpool to Java, and this is maintained about once a fortnight, finding employment for about ten of the smaller ships. The vessels in this trade, which is principally between Holland and her eastern possessions, fly the Dutch flag. A limited number of passengers were formerly carried between England and the East, but these ships now take cargo only to and from Europe, though Mahomedan pilgrims are conveyed in considerable numbers to and from Jeddah, the port for Mecca. The ships generally commence loading at Glasgow, and occasionally at other West Coast ports. They usually carry the greater part of the cargo from Liverpool, the most important element being fine goods (manufactured cottons, &c.) from Lancashire and Yorkshire. Abroad the regular service has been extended to the principal Japan ports—Nagasaki, Kobé and Yokohama, and, as opportunity arises, additional ports of call in China and Korea have been added to its itinerary. The following local services have their headquarters at Singapore: (1) Singapore to West Australian ports, including Fremantle. These steamers carry passengers, and bring large quantities of wool and pearl shell from Australia to Singapore for transshipment to the main line steamers bound for London. (2) Singapore to Deli (Sumatra). Three small steamers bring tobacco from Deli for transshipment to Europe. (3) Singapore and Penang to China. The great emigration of Chinese coolies to the British colony of the Straits Settlements keep several steamers regularly employed. The company is colloquially known in the shipping world as the "Blue Funnel" Line, and is also often referred to by the name of Mr Alfred Holt, who has been closely identified with it throughout its history. In 1902 the Ocean Company absorbed its younger rival, the China Mutual Steam Navigation Company, with a fleet of thirteen vessels of 106,870 tons, and shortly afterwards re-registered itself under the Limited Liability Acts. The company's most recent development is in its connexion with Australia. For its direct service thither several 10,000-ton ships fitted with refrigerating apparatus and accommodation for some 300 passengers each are provided.

Orient Line.—The Orient Line of steamers between London and Australia took up the work of the Orient Line of clipper packets, which in the days of sailing-ships used to ply between London and Adelaide. In April 1877 it was announced that "the Orient Line would sail the under-mentioned steamships of the Pacific Steam Navigation Company to Australia." That connexion between the two organizations was continued and strengthened till in 1901 the name of Orient Line was changed to that of Orient-Pacific. In June of 1877 the "Lusitania" was despatched from London to Adelaide, Melbourne and Sydney, via the Cape of Good Hope. Other sailings followed at about two-monthly intervals. In the following year the Orient-Pacific Line came into existence. It was formed by the joint efforts of Messrs Anderson, Anderson & Co. and F. Green & Co., who are the managers of the line. When the service was begun it was intended to be run monthly, but the increase of traffic soon demonstrated that fortnightly sailings would be successful. This extension was determined on in 1880, the year following that in which the "Orient," the first ship specially built for the company's trade, commenced work. Since 1888 the Orient Company has carried the mails to Australia by contract with the English post office, once a fortnight. These despatches, alternating with those of the P. & O., give Australia a weekly mail. Several twin-screw steamers have been built for this service by both the Orient and the Pacific Companies. The latter company subsequently retired from the partnership, the Royal Mail Company taking its place and purchasing the vessels which it employed. In 1910, however, a new mail contract came into operation, and this was undertaken by the Orient Company alone. The Royal Mail withdrawing its ships, the Orient Company replaced them with a new fleet of 12,000-ton steamers, of which the first five are twin-screws and the sixth is to have three propellers driven by a

combination of reciprocating and turbine engines. It was the Orient liner "Ophir" which took the place of a royal yacht for the imperial tour of the Prince and Princess of Wales in 1901. The steamers of the Orient Line call regularly at Plymouth, Gibraltar, Marseilles, Naples, Port Said, Suez, Colombo, Fremantle, Adelaide, Melbourne and Sydney.

Pacific Steam Navigation Company.—This was the pioneer of the steam-trade along the western coast of South America; subsequently its operations were extended to Europe, and finally, in conjunction with the Orient Steam Navigation Company, it established the Orient Line to Australia, from which it withdrew in 1906. It obtained a charter early in 1840, and soon sent out from England two steam vessels, the "Chili" and "Peru." These were paddle-boats of 710 tons and 198 ft. in length. They ran along the coast from Valparaiso to Panama. The early struggles of this company are noteworthy as showing how difficulties, apparently insuperable, may be overcome, and even turned to essential advantage. The great obstacle to the success of these steamers was the difficulty of obtaining supplies of fuel, and in the first five years of its existence no less than £72,000 was lost, the whole capital of the company being but £94,000. But the difficulties were overcome, and all that remained in the mind of the managers was a strong feeling of the importance of economy in coal consumption. Accordingly, in conjunction with the Fairfield firm of Randolph, Elder & Co., they turned their attention in this direction, and were sending out vessels fitted with compound engines some ten or a dozen years before the Atlantic companies adopted them. In 1867, under pressure from the Chilean government, the company sought and obtained powers to extend its operations, and in the same year the "Pacific," of 1630 tons, was constructed. She left Valparaiso for Liverpool in May 1868, the first of the new mail line. In 1870 the voyage was extended, Callao, 11,000 miles from Liverpool, being made the terminal port, and the sailings were increased from one to three a month. In 1873 a weekly service between Liverpool and Callao was instituted, and by 1874 there was a fleet of fifty-four steamers, with an aggregate of 120,000 tons, in commission. Owing, however, to a great decrease in the South American trade the service was reduced to a fortnightly one. The opening of the Transandine railway was expected to have a great effect on the fortunes of shipping companies in South American waters and consolidation of interests seemed desirable. In 1910 the whole of the company's ordinary capital was purchased by the Royal Mail Company, and the line was thus absorbed. In January 1893 the company inaugurated a monthly cargo service to the Brazils, River Plate and the West Coast. This service has been extended to Glasgow. Many ports are served. The principal are La Pallice, La Rochelle, Corunna, Carril, Vigo, Lisbon, St Vincent, Pernambuco, Bahia, Rio de Janeiro, Montevideo, Buenos Aires, Punta Arenas, and the ports of the western coast of South America, Valparaiso and Callao.

Peninsular & Oriental.—The story of the P. & O. Company may be divided into two eras—the first reaching from its foundation to the opening of the Suez Canal; the second from that date to the present day. During almost the whole of its career the company has acted as the agent of the British government in the conveyance of its mails, first to Mediterranean ports, and afterwards to Egypt, India and the Far East. From time to time the government has made efforts to procure some other means for transmitting its mails, but on every occasion it has found it advisable to return to the P. & O. In 1835 Messrs Willcox & Anderson, a firm of London merchants, began to run steamers to the principal ports of the Peninsula. Their vessels observed greater regularity than the sailing-ships then employed to carry the mails, and the first mail contract was entered into on the 22nd of August 1837. This was awarded to them after another company, which was unable to fulfil its obligations, had been engaged for the work. Messrs Willcox & Anderson had shortly before, in concert with Captain Bourne, R.N., founded the Peninsular Company. This contract arranged for a monthly service between Falmouth and Vigo, Oporto, Lisbon and Gibraltar. About two years later another step was taken. Hitherto the mails to Egypt and India had been conveyed by the Peninsular Company to Gibraltar, by an admiralty packet from Gibraltar to Malta, by another admiralty vessel from Malta to Alexandria, and from Egypt to Bombay by one of the East India Company's steamers. It was resolved to substitute for this unsatisfactory mode of conveyance a direct system of carriage by one line of steamers from London to Alexandria. The Peninsular Company again secured the contract, which was put up to public competition, and built two steamers of 1600 tons for the purpose this being a large tonnage for those days. The annual subsidy was fixed at £34,000, by which the government saved £10,000 of the amount formerly expended on their own inefficient means of transport. The company then, by a charter of incorporation, dated December 1840, assumed the name by which it has ever since been known—The Peninsular & Oriental Company. The charter was granted only on the onerous condition that steam communication with India should be established within two years. The first steamer, the "Hindustan," was despatched to India via the Cape of Good Hope on the 26th of September 1842. She was one

of a small fleet destined to ply between Calcutta, Madras, Ceylon, Aden and Suez. It was an adventurous undertaking, for the East India Company promised no definite subsidy, only a small premium on a certain number of voyages.

The obvious advantages of a direct conveyance of mails between Suez and Bombay by a regular sufficient service were becoming evident, and the P. & O. Company offered to effect this at a great saving on the existing system; but, for some reason or other, the East India Company showed the greatest reluctance to allow the control of this route to pass out of their hands, in which, in fact, it remained until 1854. Fortunately for the P. & O. Company the government decided to establish regular monthly steam communication between England and Ceylon, Madras and Calcutta, and also from Ceylon, eastward to Singapore and Hong-Kong. Only the P. & O. could at that time have contemplated undertaking such a service. In 1844 the contract was signed, and by it the company was to receive a subvention of £160,000. The Indian portion of the service opened on the 1st of January 1845, and during that year the extension to China was effected, and nine new steamers were put on the stocks. The organization of the overland route was due to the P. & O. Company, which brought it into regular working in order to convey its passengers from Alexandria to Suez. It was a picturesque but uncomfortable passage by canal-boat and steamer to Cairo, then by a two-wheeled omnibus for ninety miles across the desert to Suez. Even the coal for the boats at Suez had to be transported in this fashion, which was cheaper than sending it by sailing vessel round the Cape. The construction of a railway across the isthmus in 1859 greatly simplified the transit. It may be noted that the company had to establish coaling stations between Suez and the Far East, and also depôts of provisions, a business of no less magnitude than that of the steam service itself. In 1852 the first mail service to Australia was undertaken by the company, and the same contract included an arrangement for a fortnightly service to India and China, though a service running once every two months via Singapore and Sydney was thought sufficient for the requirements of Australia. The year 1854 saw the abolition of the East India Company's service to Bombay, the P. & O. taking its place. This arrangement saved the country £80,000 per annum. The Crimean War made large demands on the company's resources for the conveyance of troops, and the Australian service was for a time interrupted. By 1859 the company was in possession of all the lines of steam communication between England and the East. In 1864 the service to Australia was increased to one sailing a month, and in 1868 the Bombay mail left weekly. About the same time the fourth India and China contract was entered into, and at the end of 1869 the opening of the Suez Canal led to a serious crisis in the company's affairs; and also, after these difficulties had been surmounted, to a complete revolution in its methods. The opening of the canal led to a prolonged controversy with the post-office, which, with true official perversity, would not allow the company to use the canal for the conveyance of its mails. A serious falling-off of the company's revenue was the result, as the competition of the canal steamers was killing its trade. At length in 1874 a new arrangement was made by which the mails were to be carried through the canal, the subsidy granted to the company being at the same time reduced. Under these conditions, however, it was now able to construct vessels capable of competing successfully with its rivals. A prolonged dispute between Victoria and New South Wales for a long time prevented the Australian service from being as efficient as it might have been. Sydney insisted on the Pacific route being adopted. In consequence of this controversy the Australian headquarters of the company were for some time fixed at Melbourne, and it was not till 1888 that a general contract was entered into with the post-master-general, acting at last for all the Australian colonies as well as for the Imperial government. This stipulated for an accelerated service—the India, China and Australian mails being all worked from Aden in connexion with the steamer which conveyed them from Brindisi. There was for long a service between Venice, Brindisi and Egypt, and a mail contract with the Italian government; but this came to an end in March 1900.

The company's first ship, the "William Fawcett," built in 1829, had a gross tonnage of 206 and 60 h.p. Down to 1851 the vessels of the fleet were all constructed with paddles; after that date the screw took their place, though for the Marseilles to Malta express service certain famous fast paddle-steamers were subsequently constructed. A later interesting development was the abandonment of Brindisi as a port of call for the ocean mail steamers, which reverted to Marseilles, whence they run across to Port Said direct. The mails leaving London every Friday night are despatched from Brindisi in specially designed twin-screw vessels, which land them at Port Said little more than 96 hours after their despatch from London. On this service the "Osiris" and "Isis" are employed, and they have the distinction of being the only vessels in the mercantile marine which cross the seas with mails and passengers only. The company is under contract with the British government for the conveyance of mails to India, China and Australia. Its services are as follows—India: Brindisi to Bombay, weekly. China: Brindisi to Shanghai, fortnightly. Australia: Brindisi to

Sydney, fortnightly. Apart from the mail services, the company runs independent lines to Malta, Colombo and Calcutta; also between Bombay, Colombo, Singapore, Hong-Kong and Shanghai; and between Hong-Kong, Nagasaki, Hiogo and Yokohama. There is likewise a direct fortnightly service of through steamers to China and Japan at special rates. The mails are despatched weekly to Bombay, going one week by direct mail steamer and the next by the fortnightly Australian liner as far as Aden. A fast twin-screw vessel—the "Salsette"—built after the idea of the "Isis" but of thrice her tonnage—takes the Bombay mails from Aden on the weeks when there is no steamer. For the Indian and Australian mail services a new type of steamer known as the "M" class has been provided. There are already no less than ten such vessels, all twin-screws of similar design, commencing with the "Moldavia," built 1903, of 9500 tons and 14,000 i.h.p. and running up to 12,500 tons and 15,000 i.h.p. in the "Maloja" and "Medina." In 1910 a new service was acquired, the Blue Anchor fleet of Mr Wilhelm Lund being purchased. This gave the company an entry into the South African trade, the Blue Anchor steamers calling at Cape Town and Durban on their way to Australia, and new and larger vessels are being provided for this branch also of the company's activities.

Shaw, Savill & Albion Company.—The amalgamation of the business of Messrs Shaw, Savill & Co. of London and of the Albion Shipping Company of Glasgow brought this company into its present form at the close of the year 1882. At that time the amalgamating firms owned a large fleet of sailing-ships, and traded chiefly between England and New Zealand. Soon after the amalgamation the company began to acquire steamships, which gradually supplanted their sailing vessels. The Shaw, Savill & Albion Company were among the first in the frozen meat trade, and their vessels are fitted to carry large numbers of carcasses. With this company the White Star Line of Liverpool became associated in the year 1884, and five of their ships now run in the fleet of the Shaw, Savill & Albion Company. In June 1910 an offer was made by Sir John Ellerman to take over the fleet, which at that time consisted of six twin-screw and five single-screw steamships with a total of 51,300 tons gross register, a twelfth vessel being under construction. The route to New Zealand is by the Cape of Good Hope on the outward voyage, returning by Cape Horn, thus going completely round the globe every voyage. After leaving London the steamers call at Plymouth, Teneriffe, Cape Town, Hobart and Wellington; returning from New Zealand, the ports touched are Rio (sometimes Montevideo), Teneriffe, Plymouth, London. The "Arawa," which came out in 1884, made the outward voyage in 38 days, and the run home in 35 days 4 hours steaming time; she thus made the circuit of the world in 73 days 4 hours net time.

Union Steamship Company (see *Castle Line*).—This company first came into existence in 1853 under the name of the Union Steam Collier Company, with a capital of £60,000. At its commencement it possessed a fleet of five small steamers with an aggregate of only 2337 tons. But by the time these vessels were built the Crimean War was being actively carried on, and it was thought advisable to employ them for other purposes than those for which they were originally intended. They ran for a time between Southampton, Constantinople and Smyrna; but the transport service proved more remunerative, and they were used for the conveyance of troops. At the close of the war the company was registered under the Limited Liability Act by its present name. It was then determined to run the vessels between Southampton and Brazil with cargo, but this did not prove profitable, and in 1857 a notable change took place in the status of the company, for in that year it took its place among the great ocean mail companies of England. In that year a contract was completed with the government for a monthly mail service for five years to the Cape of Good Hope at an annual subsidy of £30,000. The "Dane" was the first steamer to leave Southampton with the mails on the 15th of September. In 1858 the subsidy was increased in order that the company's ships might call at St Helena and Ascension for mails on the homeward voyage. When the first contract expired the company secured another for five years. A service between the Cape and Natal, under a temporary arrangement, was inaugurated in 1862, and a seven years' mail service contract with the Natal government was concluded in 1865. In 1873 the House of Commons refused to ratify a contract which the government had entered into with the company for an extended mail service; the company, however, carried out its intention to extend its service to Zanzibar. But in October 1876 a new mail contract with the Cape of Good Hope government was entered into for a fortnightly service between Plymouth and Table Bay, the length of voyage not to exceed twenty-six days. During the Zulu War this company rendered considerable services to Great Britain. In 1878 three ships were employed, and after Isandula they conveyed reinforcements, the "Pretoria" being the only mail steamer to carry an entire regiment, the 91st Highlanders. It was on this company's s.s. "Danube" that the prince imperial sailed, whilst the old s.s. "German" took out the Empress Eugénie when she went to visit the scene of his death. The direct service with the Cape, Natal and Zanzibar was in 1881 discontinued, and in February of that year operations were extended to the Continent, a service from Hamburg was commenced, running

every twenty-eight days, which for a time proved highly successful. A branch service to Antwerp, begun in 1882, was discontinued for a time, but subsequently resumed. At the time of the Panjdeh scare in 1885, when hostilities were threatening with Russia, two of this company's steamships, the "Moor" and the "Mexican" were selected to act as armed cruisers for the defence of South Africa. The former was the only merchant vessel on which the pennant was actually hoisted. In 1889 the company's continental traffic increased so that it not only resumed the despatch of through steamers from Hamburg, but made calls at Rotterdam. This service afterwards became fortnightly, calls being made at Rotterdam, Antwerp and Hamburg. New contracts with the colonial governments were made in 1888, and in the same year Southampton took the place of Plymouth as the outward mail port, while in 1889 the homeward mails were landed at Southampton in place of Plymouth. In 1889, by the construction of the "Scot," the company acquired a much larger vessel than any they had hitherto employed; in 1895 Messrs Harland & Wolff successfully accomplished the task of lengthening this ship by cutting her in two amidships and adding 54 ft. to her length and 1000 tons to her tonnage. She subsequently was altered to adapt her for public yachting purposes and transferred to the German flag under the name of "Oceana." In 1893 the company entered upon its new policy of building a large number of practically sister ships for its intermediate trade. All were built by Messrs Harland & Wolff, and fitted with twin-screws. The series included ten vessels, commencing with the "Gaul" of 4745 tons, and ending with the "Galician" of 6757 tons launched in 1900. Meanwhile from the same yard the mail steamers "Norman," "Briton" and "Saxon" were added to the fleet. The last-named, which came out in 1899, is a vessel of 12,385 tons, with a length of 570 ft. By a resolution passed at a meeting of shareholders held on the 13th of February 1900, this company was amalgamated with the Castle Line (see below). At its absorption its fleet consisted of twenty-three vessels, of which nine were over 6000 tons.

Union-Castle Line.—This company was formed by the amalgamation of the Union and Castle lines. Previously, though practically all the vessels made their final departure from Southampton, the Union Line only made its headquarters at that port, the Castle liners coming round from London. After amalgamation, the mail steamers—to which cargo is not of so much importance—did not come to the Thames at all, the increase in their size and the neglect of the improvement of the river and of the docks by the authorities making it undesirable that they should do so. The cargo (intermediate) liners, on the other hand, all load in London, and many of them, before their final departure from the Thames, visit Hamburg, Antwerp and Rotterdam, for the purpose of picking up cargo. On these North Sea trips passengers are carried, and facilities are given for their accommodation on board during the calls at the various ports. The new company carries out the contracts of its two constituents and thus despatches every Saturday a mail steamer from Southampton via Madeira to the Cape and Natal. An hour or so before the sailing of the mail boat an intermediate steamer departs from the same port. Her places of call are Teneriffe or Las Palmas for certain, and possibly also Ascension and St Helena. These vessels serve the east coast ports of Algoa Bay and East London as well as Natal. Some of them also go to Delagoa Bay, to Beira on the mainland, and to the island of Mauritius. In 1910 a further extension was made, a monthly service being instituted to East Africa through the Canal. Besides the two weekly vessels, however, there are despatches of extra mid-weekly intermediate steamers, and these extra sailings have recently tended to become more frequent. The company's attention has for some time been directed to the trade between the United States and South Africa, and within two years after amalgamation eight new steamships were constructed with a view to the development of the trade between Cape ports and New York. Nor did the union of the two companies stop the improvement of the general fleet. The 10,000-ton twin-screw mail steamers "Kinfauns Castle" and "Kildonan Castle" were delivered to the Castle Company from the Fairfield yard prior to the amalgamation. Messrs Harland & Wolff had the "Saxon," 2000 tons larger than these ships, well in hand at the time. But the "Walmer Castle," a larger and still later addition to the fleet, embodied as far as possible the practice which from experience commended itself to both the old companies. Subsequent additions to the mail fleet have been the sisters "Armada Castle" and "Kenilworth Castle," followed in 1910 by the "Edinburgh Castle" and the "Balmoral Castle" of 13,300 tons each. Provision is now made for the carriage of the mails exclusively in twin-screw vessels. Meanwhile the intermediate fleet has received several vessels of large dimensions and of comfortable accommodation, though of speed inferior of course to the mail steamers. The company proved its capacity in the South African War, when it carried vast bodies of military and civilian passengers by its regular steamers at a time when many of its vessels were chartered by the government as troopships and storeships. In spite of the strain put on the resources of the company by the heavy work entailed by the South African War, both on the vessels employed in their regular service and on those especially taken up for government transport duty, it was found possible already to discard two of their older vessels.

STEAMSHIP LINES

859

White Star Line.—Though perhaps chiefly known in the New York trade, the White Star flag was first hoisted in the middle of last century over a fleet of clippers which sailed to Australia. In 1867 Mr Thomas Henry Ismay took it over, and two years later the great revolution in the constitution of the company took place. It was in 1869 that Mr Ismay formed the Oceanic Steam Navigation Company to run a line of steamers between Liverpool and New York. Immediately on its formation the company entered into arrangements with Messrs Harland & Wolff of Belfast for the construction of a fleet of high-class passenger ships, and it is worthy of notice that the terms upon which Messrs Harland & Wolff built the White Star ships were peculiar. No definite price was

agreed upon, but the actual cost plus a percentage for builders' profit was charged. The first "Oceanic," pioneer steamship of the line, was launched on the 27th of August 1870, and sailed for New York on the 2nd of March 1871. Her advent opened a new era in Atlantic travel. She introduced the midship saloon, which extended the whole width of the ship, thus giving increased light and improved ventilation, and reducing to a minimum the sensation of the vessel's motion. The arrangement thus introduced is now almost universally adopted in the construction of ocean liners. The "Oceanic" was also narrower in proportion to her length than the vessels previously designed for the transatlantic mail service. In 1877 the "Britannic" reduced the passage to 7 days 10 hours and

Fleets of Various Important Steamship Companies in 1891, 1901 and 1910.¹

Company.	No. of Vessels.	Gross Tonnage.	Flag.	1910.			1901.			1891.		
				Numerical Order.	Gross Tonnage.	No. of Vessels.	Numerical Order.	No. of Vessels.	Gross Tonnage.	Numerical Order.	No. of Vessels.	Gross Tonnage.
International Mercantile Marine Co.—												
White Star Line	31	372,045	British	—	—	—	10	25	212,403	17	16	84,902
Leyland Line ²	42	253,803	British	—	—	—	7	55	242,781	23	23	60,511
American Line and Red ³ Star Line	16	164,213	Mixed	—	—	—	15	25	167,105	—	—	—
Atlantic Transport Co.	14	107,650	British	—	—	—	26	17	123,593	32	6	18,111
Dominion and British & North Atlantic Co.	13	86,655	British	—	—	—	27	13	105,430	29	8	28,696
Vessels owned jointly with Shaw, Savill & Albion	7	51,053	British	—	—	—	—	—	—	—	—	—
National S.S. Co.	2	16,005	British	—	—	—	—	3	18,464	—	12	53,522
Training Ship	1	1,814	British	—	—	—	—	—	—	—	—	—
	126	1,053,238		1	1,053,238	126	—	—	—	—	—	—
Hamburg-American Line	—	—	German	2	979,217	168	1	202	541,085	9	42	126,795
Norddeutscher Lloyd	—	—	German	3	752,037	176	2	111	454,936	4	70	198,723
P. & O. Company	—	—	British	4	458,037	64	5	58	313,343	3	49	199,911
British India S.N. Co.	—	—	British	5	423,063	104	4	120	378,770	1	100	234,654
Royal Mail S.P. Co.	45	194,663	British	6	377,897	85	32	28	88,205	19	25	73,384
Pacific Steam Navigation Co.	40	183,234	British				22	42	138,754	15	36	97,793
Alfred Holt & Co.—Ocean S.S. Co.	39	234,808	British	7	340,559	57	16	41	165,143	11	44	109,000
China Mutual Steam Navigation Co.	18	105,751	British				—	—	—	—	—	—
Furness, Withy & Co.	—	—	British	8	340,537	116	—	12	40,994	—	20	44,528
Elder, Dempster & Co. ⁴	—	—	British	9	331,533	108	3	120	382,560	25	48	55,256
Union-Castle Co. ⁵	—	—	British	10	295,360	41	8	41	222,613	—	—	—
Messageries Maritimes	—	—	French	11	293,669	65	6	62	246,277	2	63	202,801
Nippon Yusen Kaisha	—	—	Japanese	12	289,787	73	9	69	218,361	28	52	42,058
Ellerman Lines	—	—	British	13	283,234	78	—	—	—	—	—	—
Lampport & Holt	—	—	British	14	281,412	44	20	47	149,712	12	54	106,648
Nav. Gen. Italiana ⁶	—	—	Italian	15	274,952	106	11	102	205,104	6	106	164,052
Hansa Line	—	—	German	16	247,691	53	18	57	157,037	26	26	50,413
Compagnie Générale Transatlantique	—	—	French	17	245,353	62	13	59	183,343	5	66	174,600
Harrison Line of Liverpool	—	—	British	18	217,085	43	21	31	146,625	22	27	61,643
Austrian Lloyd	—	—	Austrian	19	216,414	66	14	68	169,436	10	76	124,435
Cunard Line	—	—	British	20	209,231	19	25	26	126,332	16	22	85,104
Clan Line	—	—	British	21	202,463	49	17	46	164,487	18	29	76,300
Canadian Pacific Railway	—	—	British	22	198,310	65	—	12	38,089	—	7	24,373
Hamburg South American Line	—	—	German	23	197,703	49	—	32	125,597	—	26	56,938
Wilson Line	—	—	British	24	190,278	87	12	89	189,818	7	73	132,889
Kosmos Line	—	—	German	25	177,704	36	—	29	110,251	—	15	32,963
Allan Line	—	—	British	26	160,570	28	19	36	152,367	13	31	106,346
Ropner's	—	—	British	27	155,440	50	29	36	100,426	21	34	62,717
Maclay & Macintyre	—	—	British	28	144,500	45	24	51	126,917	30	19	26,928
Chargeurs Réunis	—	—	French	29	144,441	25	34	26	81,149	20	30	70,173
Booth Line	—	—	British	30	128,200	37	—	27	64,456	—	10	13,951
Holland-American Line	—	—	Dutch	31	124,136	15	—	9	55,413	—	11	37,891
Prince Line	—	—	British	32	123,909	41	—	33	79,001	—	32	59,221
Bucknall Line	—	—	British	33	122,388	29	33	23	83,207	33	—	—
Anchor Line	—	—	British	34	110,588	19	23	41	132,540	8	44	127,065
Westoll Line	—	—	British	35	90,174	35	31	38	88,306	27	31	48,298
Volunteer Fleet	—	—	Russian	36	84,500	18	35	16	80,424	31	8	23,845
Johnston Line of Liverpool	—	—	British	37	81,000	20	28	24	100,460	24	22	58,621
Compañía Transatlántica	—	—	Spanish	38	79,767	22	30	23	88,453	14	36	101,214

¹ This table is based on that contained in a paper on "Shipping Subsidies," by B. W. Ginsburg, published in the *Journal of the Royal Statistical Society* (September 1901).

² The Leyland Line was formerly the Leyland Line and West India & Pacific Steam Navigation Company.

³ In 1891 the old American Line had 3 steamers of 10,166 tons; the Inman Line 6 steamers of 41,276 tons; the International Line 4 steamers of 12,112 tons; and the Red Star Line 9 steamers of 39,609 tons.

⁴ Messrs Elder, Dempster & Co. now control the fleets of the African, British & African, and Imperial Direct Steamship companies.

⁵ Formerly the Union Line and the Castle Line. In 1891 the Union Line had 23 steamers of 55,576 tons, and the Castle Line 19 steamers of 57,934 tons.

⁶ Formerly known as the Florio-Rubattino Line.

50 minutes, excelling by three hours the best previous Atlantic passage. After the year 1888 the company ceased to build single-screw steamers, all later vessels having been constructed on the twin-screw system, of which the superiority had been clearly demonstrated. About this time also the owners of the line became responsible for an important advance in steamship construction which was afterwards imitated by merchant ships of all the great maritime powers. The "Teutonic" and "Majestic," introduced in 1889 and 1890, were the first merchant ships constructed with a view to their use as possible auxiliaries to the Royal Navy. The former was present, armed with eight quick-firing guns, at the naval inspection by the German emperor in 1889. With the launch of the second "Oceanic" in January 1899 the company's record was still further enhanced. The White Star Line was from 1877 regularly employed under contract with the British government to carry the American mails from Liverpool and Queenstown to New York. Besides this weekly mail and passenger service, a fleet of twin-screw cargo vessels maintained a subsidiary service between Liverpool and New York. These vessels were especially designed for the conveyance of cattle and horses. After 1883 several steamships of the line were employed in the Shaw, Savill & Albion service between London and New Zealand. Three of the company's ships ran in the line of the Occidental & Oriental Company between San Francisco and Yokohama and Hong-Kong. The company inaugurated a service to Australia from Liverpool in 1899. Five ships ran in it (calling at Cape Town) to Albany, Adelaide, Melbourne and Sydney. The ports visited by their vessels in New Zealand will be found detailed under Shaw, Savill & Albion Company. In 1902 the absorption of the White Star fleet and management in the Morgan shipping combine was arranged. Since that time several alterations have taken place. The mail steamers of the line left Liverpool for Southampton in June 1907 and now call at Cherbourg on their way to and from New York. Two services are still maintained between Liverpool and New York—one the old cargo service, and the other a weekly despatch of large passenger and cargo vessels. In addition to these there are two other Atlantic services from Liverpool—one to Boston and the other maintained in conjunction with the Dominion Line to Canadian ports. There is also a line of White Star steamers between New York and the Mediterranean. Several important vessels from other limbs of the combine have been brought under the White Star flag, whilst the company has also practically absorbed the old Aberdeen Line.

Wilson Line.—Thomas Wilson, Sons & Co. is at the present time the largest private ship-owning company in the world. This line traces its origin as far back as 1835. It was founded by Mr Thomas Wilson in conjunction with Messrs Hudson and Beckington, and on the retirement of the two last-named gentlemen it acquired its present title. Early in the 'forties the firm was running three steamships to Gothenburg, and was engaged largely in the iron trade, importing large quantities of Swedish and Russian iron, and running a regular line of sailing boats to Swedish ports. It also despatched a regular service to Dunkirk. Steamships gradually superseded the sailing vessels, and new steamers year by year were placed on the Scandinavian service. About this time the firm secured the mail contract between England and Sweden, which it still holds. After the Crimean War it started the St Petersburg, Stettin and Riga trade. During the Franco-German War the trade to Stettin had to be suspended; and as a set-off the service to Trieste was inaugurated, which has developed into an independent Adriatic and Sicilian service. The Norwegian trade was then improved by the despatch of steamships to Bergen, Stavanger and Trondhjem, and subsequently a service of large steamers began running to Constantinople and the Black Sea. After the opening of the Suez Canal the trade to India, which has since assumed such considerable proportions, was inaugurated. In 1875 the firm launched out into a more hardy enterprise, by commencing to run steamers to America. Its vessels in 1902 ran to New York regularly from Hull and the Tyne ports. The original Calcutta trade was discontinued when the New York line was started, but in 1883 a service was established between Hull and Bombay. In 1891 the firm became a private limited company and in 1894 took over the coasting trade between Hull and Newcastle. The company employs a number of large and swift ships in the Norwegian passenger traffic, which in the summer season now reaches very considerable proportions. It has frequent services of passenger and cargo vessels to the ports of northern Europe, carrying passengers in the season as far north as the North Cape. Of course the winter season necessitates considerable variation of summer services to Baltic ports. In 1903 the fleet of the old-established Hull firm of Messrs Bailey & Leatham was absorbed, and in 1908 that of the North-Eastern Railway Company. There are also steamers leaving Grimsby, Manchester and Liverpool regularly for Scandinavian and Baltic ports; weekly services to Ghent, Liverpool and Newcastle; and services to Mediterranean and Black Sea ports. Besides the New York line there are ocean services to Boston, to New Orleans and the river Plate. There is also a weekly service to and from London and Boston in conjunction with the Furness-Leyland Line.

Conclusion.—The scope of this article will not allow of any detailed reference to many of the important foreign lines which in a complete history should be mentioned. The Hansa Company of Bremen; the Chargeurs Réunis of Havre; the Holland-American Line, which has of recent years added to the fleet several fine twin-screw liners, built at the Belfast yard; the Compañía Transatlántica of Barcelona, which performed so great a feat in the transport of troops from Barcelona to Cuba in the latter days of Spain's dominion over that island; the Pacific Mail Company of the United States; and many others might be noticed. A whole article might be devoted to the work of the lines on the North American inland waters, while there are several other English companies which might well claim attention, both from the magnitude of their operations and the extent to which they have developed types of ships suitable for the peculiarities of the trades in which their vessels are engaged. The Clan Line, for example, has largely adopted the turret-decked ship, which is the design of Messrs W. Doxford & Co. of Sunderland. This type of ship is intended to carry large cargoes on a small registered tonnage and a light draught, without paying for it by a sacrifice of weatherly qualities. The same object is aimed at by the design of the trunk steamers built by Messrs Ropner of Stockton. The Isherwood system of construction and the cantilever type of cargo steamer are other devices for attaining the same object. Then there are the tank steamers constructed for the carriage of oil in bulk. Many of these ships are adapted not only for the carriage of oil, but also for its consumption in their furnaces in place of coal. We have already referred to some of the vessels fitted with refrigerating apparatus for the carriage of dead meat, and to the cargo steamers of the Atlantic companies, which are supplied with conveniences for carrying valuable racehorses and cattle. The experience of many years has enabled the owners of some of these lines to exhibit a wonderfully low record of loss, the percentage of deaths at sea to numbers carried being small beyond the dreams of, say, the 'seventies. A tenth of 1% over a somewhat extended period is not an unprecedented average.

The table shows something of the recent growths of companies, and at the same time records some of the amalgamations which have been so frequent. It should be explained that the table does not pretend to be exhaustive. The fleets embraced in it are not necessarily all those whose tonnage reaches above the lower limit shown. There are now a number of lines whose total exceeds 100,000 tons which are not shown in the list. Amongst them may be cited the Hamburg-Pacific Line, the German line to Australia, the Union Company of New Zealand—which contains many small vessels, the Forende Company of Copenhagen and the Anglo-American Oil Company. The table shows how whilst the principal lines are largely increasing their fleets, one or two companies are falling back in their gross amount of tonnage. The figures, moreover, are subject to certain reservations. The count was not necessarily taken by the various companies at the same period of each year. Some of the figures given may include numbers and tonnages of tugs and tenders, while others may exclude them. Again, some of the companies may have returned in their fleets the vessels which they had under construction, whilst others may not have counted them. But none of these considerations can much affect the general significance of the figures shown. The growth in the average size of individual ships is as marked as that of the aggregate tonnage of the companies.

AUTHORITIES.—The following books throw much light on the history of the leading steamship lines: *History of Merchant Shipping*, by W. S. Lindsay (London, Sampson Low & Co.); *La Navig. comm. au XIX. siècle* (Paris, 1901); A. J. Maginnis, *The Atlantic Ferry* (3rd ed., London, Whittaker & Co.); E. R. Jones, *The Shipping World Year-Book; Lloyd's Register of British and Foreign Shipping* (published annually). Also see a comprehensive article on this subject in the *Quarterly Review* for January 1900. Perhaps the fullest information is, as a rule, to be obtained from the handbooks issued by the companies themselves. (B. W. G.)

STEARIC ACID, *n*-Octodecylic acid $\text{CH}_3(\text{CH}_2)_{16}\text{CO}_2\text{H}$, an organic acid found as its glyceride stearin, mixed with palmitin and olein, in most tallows (hence its name, from Gr. *στέαρ*, tallow). The so-called "stearin" of candles is a mixture of stearic and palmitic acids (see CANDLE).

STEATOPYGIA (Gr. *στέαρ*, fat, *πυγή* rump), an unusual accumulation of fat in and around the buttocks. The deposit of fat is not confined to the gluteal regions, but extends to the outside and front of the thighs, forming a thick layer reaching sometimes to the knee. This curious development constitutes a racial characteristic of the Bushmen (*q.v.*). It is specially a feature of the women, but it occurs in a less degree in the males. It is also common among the Hottentots, and has been noted among the pygmies of Central Africa. In women it is regarded among them as a beauty: it begins in infancy and is fully developed on the first pregnancy. It is often accompanied by

the peculiar formation known as "the Hottentot-apron," hypertrophy of the nymphae (Tablier). No satisfactory explanation of these malformations has been offered. Steatopygia would seem to have been a characteristic of a race which once extended from the Gulf of Aden to the Cape of Good Hope, of which stock Bushmen and pygmies are remnants. The discovery in the caves of the south of France of figures in ivory presenting a remarkable development of the thighs, and even the peculiar prolongation of the nymphae, has been used to support the theory that a steatopygous race once existed in Europe. What seems certain is that steatopygia in both sexes was fairly widespread among the early races of man. While the Bushmen and Hottentots afford the most noticeable examples of its development, it is by no means rare in other parts of Africa, and occurs even more frequently among Bastards of the male sex than among Hottentot women.

STEDMAN, EDMUND CLARENCE (1833-1908), American poet and critic, was born at Hartford, Connecticut, on the 8th of October 1833. He studied two years at Yale; became a journalist in New York, especially on the staffs of the *Tribune* and *World*, which latter paper he served as field correspondent during the first years of the Civil War; and was a banker in Wall Street from 1869 to 1900. His first book, *Poems, Lyrical and Idyllic*, appeared in 1860, followed by successive volumes of similar character, and by collected editions of his verse in 1873, 1884 and 1897. His longer poems are *Alice of Monmouth: an Idyl of the Great War* (1864); *The Blameless Prince* (1869), an allegory of good deeds, supposed to have been remotely suggested by the life of Prince Albert; and an elaborate commemorative ode on Hawthorne, read before the Harvard Phi Beta Kappa Society in 1877. An idyllic atmosphere is the prevalent characteristic of his longer pieces, while the lyric tone is never absent from his songs, ballads and poems of reflection or fancy. As an editor he put forth a volume of *Cameos* from Landor (with T. B. Aldrich, 1874); a large *Library of* (selections from) *American Literature* (with Ellen M. Hutchinson, 11 vols., 1888-1890); a *Victorian Anthology* (1895); and an *American Anthology, 1787-1890* (1900); the two last-named volumes being ancillary to a detailed and comprehensive critical study in prose of the whole body of English poetry from 1837, and of American poetry of the 19th century. This study appeared in separate chapters in *Scribner's Monthly* now the *Century Magazine*, and was reissued, with enlargements, in the volumes entitled *Victorian Poets* (1875; continued to the Jubilee year in the edition of 1887) and *Poets of America* (1885), the two works forming the most symmetrical body of literary criticism yet published in the United States. Their value is increased by the treatise on *The Nature and Elements of Poetry* (Boston, 1892)—a work of great critical insight as well as technical knowledge. He died in New York on the 18th of January 1908.

See Laura Stedman and G. M. Gould, *The Life and Letters of Edmund Clarence Stedman* (2 vols., N. Y., 1910).

STEEL, FLORA ANNIE (1847-), English writer, was born on the 2nd of April 1847, the daughter of George Webster. In 1867 she married an Indian civilian, and for the next twenty-two years lived in India, chiefly in the Punjab, with which most of her books are connected; her interest in the education of women, as an inspectress of schools, gave her a special insight into native life and character. Some of her best work is contained in two collections of short stories: *From the Five Rivers* (1893) and *Tales from the Punjab* (1894); while her most ambitious effort was her novel, *On the face of the Waters* (1896), describing incidents of the Indian Mutiny. She also wrote a popular history of India. Later works are *In the Permanent Way* (1897), *Voices in the Night* (1900), *The Hosts of the Lord* (1900), *In the Guardianship of God* (1903), *A Sovereign Remedy* (1906).

STEEL CONSTRUCTION. The use of steel construction in the erection of large buildings is the natural consequence of the conditions imposed upon owners of property lying within sections of large cities, and the result of the introduction of new materials and devices. Apart from the aesthetic considerations to which has been due the construction of spires, towers,

domes, high roofs, &c., the form and height of buildings have always been largely controlled by a practical consideration of their value for personal use or rental. The cost of buildings of the same class and finish is in direct proportion to their cubic contents, and each cubic foot constructed is commercially unprofitable which does not do its part in paying interest on the capital invested. Until the latter half of the 19th century, these considerations practically limited the height of buildings on city streets to five or six storeys. The manufacture of the wrought-iron "I" beam in 1855 made cheaper fire-proof construction possible, and, with the introduction of passenger lifts (see **ELEVATORS; LIFTS OR HOISTS**) about ten years later, led to the erection of buildings to be used as hotels, flats, offices, factories, and for other commercial purposes, containing many more storeys than had formerly been found profitable. The practical limit of height was reached when the sectional area of the masonry of the piers of the exterior walls in the lower storey had to be made so great, in order to support safely the weight of the dead load of the walls and floors and the accidental load imposed upon the latter in use, as to affect seriously the value of the lower storeys on account of the loss of light and floor space. This limit was found to be about ten storeys. Various devices were successively made to reduce the size of the exterior piers. In 1881 the walls of a very large courtyard were constructed by building a braced cage of iron and filling the panels with masonry, a system of construction which had been used in the early part of the century for a tall shot-tower erected in the city of New York. Subsequently several buildings were erected in which the entire weight of the floors and roofs was carried by a system of metal columns placed against the inner surface of the exterior walls. The walls thus supported no load but their own weight, and were tied to the inner cage formed by the wall columns, interior columns, girders, and floors by anchors arranged to provide for the shrinkage of masonry in drying out which always occurs to a greater or less extent. By the use of this form of construction buildings were carried to the height of eighteen or nineteen storeys.

Iron or steel as a substitute for wood for constructive purposes was long thought to be fire-proof or fire-resisting because it is incombustible, and for this reason it has not only replaced wood in many features of building construction but is also used as a substitute for masonry. In time, however, it was realized that iron by itself is not fire-proof, but requires to be protected by means of fire-resisting coverings; but as soon as satisfactory forms of these were invented their development progressed hand in hand with that of iron and steel forms and combinations.

Buildings in steel are either of "skeleton" or "cage" construction. These terms may be defined as follows: In "skeleton" construction the columns and girders are built without proper or adequate inter-connexion and would not be able to carry the required weights without the support afforded by the walls; or, as in more recent construction, the walls are self-supporting and the other portions of the building are carried on by the skeleton steelwork. "Cage" construction consists of a complete and well-connected framework of iron or steel capable of carrying not only the floors but the walls, roof, and every other part of the building, and efficiently constructed with wind bracing to secure its independent safety under all conditions of loading and exposure, all loads being transmitted to the ground through columns at predetermined points. In America under this system the walls can be built independently from any level (see fig. 4), but in England the requirements of the building acts as to the thickness of walls prevents the general use of this form of construction.

Skeleton construction is defined by the Chicago building ordinance as follows:—

"The term 'skeleton construction' shall apply to all buildings wherein all external and internal loads and strains are transmitted from the top of the building to the foundations by a skeleton or framework of metal. In such metal framework the beams and girders shall be riveted to each other at their respective junction points. If pillars made of rolled iron or steel are used, their different parts shall be riveted to each other and the beams and girders

resting upon them shall have riveted or bolted connexions to unite them with the pillar. If cast-iron pillars are used, each successive pillar shall be bolted to the one below it by at least four bolts not less than three-fourths of an inch in diameter, and the beams and girders shall be bolted to the pillars. At each line of floor- or roof-beams, lateral connexion between the ends of the beams and girders shall be made by passing wrought-iron or steel straps across or through the cast-iron column, in such a manner as to rigidly connect the beams and girders with each other on the direction of their length. These straps shall be made of wrought-iron or steel, and shall be riveted or bolted to the flanges or to the webs of the beams or girders.

"If buildings are made fire-proof entirely, and have skeleton construction so designed that their enclosing walls do not carry the weight of the floors or roof, then their walls shall be not less than twelve inches in thickness; and provided, also, that such walls shall be thoroughly anchored to the iron skeleton, and provided, also, that, whether the weight of such walls rests upon beams or pillars, such beams or pillars must be made strong enough in each storey to carry the weight of wall resting upon them without reliance upon the walls below them. All partitions must be of incombustible material."

With the introduction of cheap structural steel, steel cage construction came rapidly into use. The dimensions of the exterior piers ceased to control the height of the building, which was limited alone by the possibility of securing adequate foundations, and by a consideration of the amount of floor space which could be devoted without too great loss to a system of passenger lifts of sufficient capacity to afford speedy access to all parts of the building. The advantages that led to the very rapid introduction of this system were not only the power of greatly reducing the size of the piers, but the enormous facility afforded for quick construction, the small amount of materials relatively used and the proportionately small load upon the foundations, and the fact that as the walls are supported at each storey directly from the cage, the masonry can be begun at any storey independently of the masonry below it. It is a disadvantage of the system that defects of proportion, material, or workmanship, which would be of less moment in an old-fashioned construction, may become an element of danger in building with the steel cage, while the possibility of securing a permanent protection of all parts of the cage from corrosion is a most serious consideration. The safety of the structure depends upon the preservation of the absolute integrity of the cage. It must not only be strong enough to sustain all possible vertical loads, but it must be sufficiently rigid to resist without deformation or weakening all lateral disturbing forces, the principal of which are the pressure of wind, the possible sway of moving crowds or moving machinery, and the vibration of the earth from the passage of loaded vans and trolleys, and slight earthquakes which at times visit almost all localities. In buildings wide in proportion to their height it is the ordinary practice to make the floors sufficiently rigid to transfer the lateral strains to the walls, and to brace the wall framings to resist them. In buildings of small width in proportion to their height this method of securing rigidity is generally found to be inadequate, and the frame is also braced at right angles to the outer walls to take up the strains directly. In each case all strains are carefully computed. The bracing is accomplished by the introduction at the angles of the columns and girders or beams of gusset plates or knee braces, or by diagonal straps or rods properly attached by rivet or pin connexions. All portions of the frame are united by hot rivets of mild steel or wrought iron, care being taken that the sum of the sectional areas of rivets affords in each case a sufficient amount of metal for the safe transfer of the stresses. The greatest care should be taken to see that all rivet holes are accurately punched, and if necessary that they are rhymed so that each rivet will have its full value.

For the proper and successful erection of the frame much depends upon an accurate alinement of the column bases. These should be properly tested as to position and level. The bases are either grouted with cement, or bolted to the foundations, but where cast column bases rest on masonry piers or footings any considerable grouting is not advisable. The only grouting that should be permitted in tall buildings would be in

levelling up the tops of the concrete footings to receive the masonry courses, or in a very thin layer between the column pedestal and the masonry bed. The cap stones should always be brought to the most accurate bed possible, with grouting used as a thin cement and not as a backer. Accurate redressing of the cap stones after setting is much to be preferred.

All riveting and punching of the steel members is done at the shop, where also they receive the usual coat of oil or paint. This leaves the assembling and field riveting to be done on the ground, together with the adjustment of the lateral or wind-bracing, the placing of tie rods and the field painting.

After erection the steelwork should receive one or two coats of paint; two coats are to be recommended, in which case they should be of different colours. Red lead is best for the priming coat and oxide paint for the finishing coat. In German specifications it is required that the steelwork should first receive a coat of boiled linseed oil, in order that the red lead coating should be more coherent with the steel.

Steelwork that has to come in contact with brickwork or concrete should not be painted, but should receive a wash of cement as the brickwork or concrete-work proceeds. The steelwork which is exposed to the weather should be painted about every three years, but when it is under cover an interval of five years may elapse.

To secure painting of permanent value a clean scaleless and rustless surface is first necessary. Steel plates and shapes, when delivered from the rolls which form them to the cooling beds, are largely covered with scales, which, adhering only partially to the surface, offer the intervening cracks or joints as vulnerable points for rust. After being rolled, structural steel is stored or handled out of doors for a varying period both at the mill and then again at the shop before the building is started. This period of open-air exposure allows the process of rust to start under the scales. If the rust so covered up has not begun to pit the iron the chances are that it will do no harm; but, if it is already well developed and of some thickness, it will have enough oxidizing agents in its pores to develop more oxide, and to swell up and crack the paint. The first requirement, therefore, for efficient painting is the careful removal of all mill-scale, rust, grease, or foreign substance, before even the priming coat is applied. It is agreed that the first step in the preservation of metal-work against deterioration or corrosion is the obtaining of absolute cleanness of metal before the application of paint or oil.

The following are the requirements of the New York building law in regard to the protection of iron or steelwork against corrosion, &c.:—

"All structural metal-work shall be cleaned of all scale, dirt and rust, and be thoroughly coated with one coat of paint. Cast-iron columns shall not be painted until after inspection by the Department of Buildings. Where surfaces in riveted work come in contact they shall be painted before assembling. After erection all work shall be painted with at least one additional coat. All iron or steel used under water shall be enclosed with concrete."

The Chicago ordinance makes no mention of paint or coating to prevent rust in metal framework. The London Building Acts do not set out any special requirements, but suggestions have been made at the Royal Institution of British Architects for the regulation of skeleton buildings and they are drawn up upon a more scientific basis than the bulk of the existing acts.

In transferring the loads from the column bases to the bottom of the footings the greatest care must be taken in all systems of construction that the stresses throughout at no point exceed the safe limits of stress for the various materials used. Steel is generally used for columns in preference to cast iron, because it affords greater facility for securing satisfactory connexions, because its defects of quality or workmanship are more surely detected by careful test and inspection, and because, on account of its superior elasticity and ductility, its fibre is less liable to fracture from slight deformations. It is used in preference to wrought iron on account of its lesser cost.

Steel Cage Construction.

Protection from Corrosion.

Columns.

Columns are generally built of riveted work of zedbars, channels, angles, plates, or lattice, of such form as will make the simplest and most easily constructed framing in the particular position in which the column is placed. The columns are sometimes run through two or more storeys and arranged to break joints at the different floors. In buildings to be used as offices, hotels, apartments, &c., it is usual in establishing the loads for the purpose of computation to assume that the columns carrying the roof and the upper storey will be called upon to sustain the full dead load due to material and the maximum computed variable load, but it is customary to reduce the variable loads at the rate of about 5% storey by storey towards the base, until a minimum of about 20% of the entire variable load is reached, for it is evidently impossible that the building can be loaded by a densely-packed moving crowd in all of its storeys simultaneously. In the case of factories and buildings used for storage purposes the maximum variable load which can be imposed for any serious length of time on each floor must be used without reduction in computing the loads of the lower column, and proper allowances must be made for vibrating loads. In the case of very tall exposed buildings of small depth, the vertical load on the columns due to wind pressure in the opposite side of the building must be computed and allowed for, and in case the lower columns are without lateral support their bending moment must be sufficient to resist the lateral pressure due to wind and eccentricity of loading. In computing the column sections a proper allowance must be made for any eccentricity of loading. It is usual to limit the height of sections of columns without lateral support to 30 diameters, and to limit the maximum fibre stress to 12,000 lb per sq. in. The sectional areas are computed by the use of the ordinary formulae for columns and struts.

The standard sections in use are numerous and varied, and from time to time a steel user has occasion to design a new steel shape because no existing section is suitable. The experiments given by Professor Burr indicate that a closed column is stronger than an open one, but practice does not always support theory, and many other questions besides mere form arise in connexion with the choice of a section; special considerations in the use of columns in buildings sometimes call for a form very different from the circular section, and such include the transfer of loads to the centre of the section, the maximum efficiency under loading, and the requirements for pipe space around or included in the column form. Lattice bars, fillers, brackets, &c., add just so much more weight without increasing the section, and must be allowed for; the method of riveting the sections together must also be taken into account.

For girders of small spans "I" beams or channels are generally used, but for greater spans girders are built of riveted work

Girders. in the form of boxes with top and bottom plates, side plates, and angles with proper stiffening bars on the side plates, or "I's," or lattice, or other forms of truss work. In girders and beams the maximum fibre stress is usually limited to 16,000 lb. In very short girders the shear must be computed, and in long girders the deflexion, particularly the flexure from the variable load, since a flexure of more than $\frac{1}{100}$ of the length is liable to crack the plastering of the ceilings carried by the girders. The same necessity for computing shear and flexure applies to the floor beams. The floors between the girders are constructed of "I" beams, spaced generally about 5 ft. between centres; their ends are usually framed to fit the form of the girders, and rest either upon their lower flanges, or upon seats formed of angles riveted to their webs, being secured to them by a pair of angles at each end of the beam riveted to its web and to the web of the girder. Sometimes the beams rest upon the girders, and are riveted through the flanges to it; in this case the abutting ends of beams are spliced by scarf plates placed on each side of the webs and secured by rivets. A similar construction is followed for flat roofs, the grades being generally formed in the girder and beam construction, and a flat ceiling secured by hanging from them, with steel straps, a light tier of ceiling beams. The floor beams are tied laterally by rods in continuous lines placed at or above

their neutral axis. It is usual in both girders and beams to provide not only for the safe support of the greatest possible distributed load, but for the greatest weight, such as that of a safe or other heavy piece of furniture which may be moved over the floor at its weakest points, the centres of the girders and beams. It must always be borne in mind that the formulae for the ultimate strength of the "I" beams only hold good when the upper chord or flange is supported laterally.

Considerable improvement has been made in the design of rolled steel shapes; for example the rolling of a 16-in. joist was formerly deemed a remarkable achievement, though now there are several works producing 24-in. joists with flanges 7 and $7\frac{1}{2}$ in. wide. The Broad Flange Differdange Beams are claimed by the manufacturers to be stronger and to minimize weight for use as girders; they are made in twenty-one different sizes with flanges from $8\frac{3}{8}$ to 12 in. wide.

The introduction of steel construction has simplified many details of architectural treatment, such as projections for cornices, bay windows and galleries. These may be supported by bracket-angles attached to the columns with a system of anchors to tie them back; the material must be carried in such a manner as to make it independent of the general structure, and must be constructed as light as possible. If the supporting member is a floor beam or girder the girder should be rigidly connected to the floor system to prevent any twisting due to the weight of the projection.

The arrangement of the building and floor framings is in a great measure governed by the architectural effect sought and by the arrangement and proper planning of the **Floors.** interior according to the intended uses; the positions of columns, girders and floor beams are usually the result of particular requirements, and unless complicated and expensive framing is to be expected the distance between columns must be kept within the limits of simple girder construction. The position of the columns having been determined, the girders must next be located; these serve to support the floor beams which transfer the loads direct to the columns, and also to brace the columns during erection. The spacing, or distance from centre to centre of the floor beams, will depend upon the type of fire-proof flooring employed; it also depends to a considerable extent upon the amount and character of the floor load and the length of span. If the loads to be carried are largely stationary, and if the span is small, the floor joists can be readily proportioned by means of tables given in the handbooks issued by many steel companies. The distance between joists should be limited to 5 or 6 ft.; horizontal bracing by means of diagonal rods is sometimes used, but should be avoided. The following are the usual assumptions made in good practice for superimposed loads:—

Floors of dwellings and offices	70 lb per sq. ft.
" " churches, theatres and ball-rooms	125 " " " "
" " warehouses	200 to 250 " " " "
" " for heavy machinery	250 to 400 " " " "

The relation between the velocity of wind and the pressure exerted upon surfaces must be considered in steel construction, and designers differ in regard to the forces to be resisted and the material to be used. Every building offers its own peculiar condition; the height, width, shape and situation of the structure, and character of the enclosing walls, will determine the amount of wind pressure to be provided against, and the internal appearance and the planning of the various floors will largely influence the manner in which the bracing is to be treated. There are many and varied forms of bracing, each designer adopting methods peculiar to his own ideas. One form consists of adjustable diagonals, rods or bars, properly fastened to the columns in the building; these diagonals may run through one floor and be attached to the columns at the floor above. Another form is known as portal bracing; this is usually braced between adjacent columns in halls or passage-ways and extends from the foundations up from floor to floor to such a height that the stability of the **Wind-bracing.**

building itself is sufficient to resist the assumed wind pressure. In general, if the building is square or nearly so wind-bracing should be placed close to the corners. In case neither of the above methods can be applied, brackets should be used at each floor level or a continuous deep beam or girder carried all around the building. Some architects depend solely upon partitions, and a building with a well-constructed iron frame should be safe if provided with brick partitions or if the exterior of the iron framework is covered with well-built masonry of sufficient thickness.

Truss rods, portals, or lattice or plate girders constitute the more definite types of wind-bracing ordinarily employed; the bracing must reach to some solid connexion at the ground. The greatest wind pressure to which a building is subjected is that from a horizontal wind. The maximum pressure is not uniform from the ground level to the roof but is greatest at the centre; it is diminished near the ground level by the frictional resistance of the ground, and at the eaves by the eddies formed by the air escaping over the roof. The change in direction of the air when striking a flat surface such as the side of a building will form a cushion to diminish the effects of impulses and shocks from local gusts.

The building laws of the city of New York require the following provisions as regards wind forces:—

“All structures exposed to wind shall be designed to resist a horizontal wind pressure of thirty pounds for every square foot of surface thus exposed, from the ground to the top of the same, including roof, in any direction. In no case shall the overturning moment due to wind pressure exceed seventy-five per centum of the moment of stability of the structure. In all structures exposed to wind, if the resisting moments of the ordinary materials of construction, such as masonry, partitions, floors and connexions, are not sufficient to resist the moment of distortion due to wind pressure, taken in any direction on any part of the structure, additional bracing shall be introduced sufficient to make up the difference in the moments. In calculations for wind pressures, the working stresses set forth in the code may be increased by fifty per centum. In buildings under one hundred feet in height, provided the height does not exceed four times the average width of the base, the wind pressure may be disregarded.”

The steel used throughout the entire structure should be subjected to the most thorough chemical and mechanical tests and inspection, first at the mill and subsequently at the fabricating shops and the building, to ensure that it shall not contain more than 0.08% of phosphorus or 0.06% of sulphur, that it shall have an ultimate strength of between 60,000 and 70,000 lb per sq. in., with an elastic limit of not less than 35,000 lb per sq. in., and an elongation before fracture of not less than 25% in 8 in. of length, and that a piece of the material may be bent cold 180° over a mandril equal to the thickness of the piece tested without fracture of the fibres on the outside of the bend. At least two pieces are taken from each melt or blow at the mill, and are stamped or marked, and all the various sections rolled from the melt or blow are required to bear a similar stamp or mark for identification. All finished material is carefully examined to see that it possesses a smooth surface, and that it is free from cracks, seams and other defects, and that it is true to section throughout. Rivets are either of wrought iron or of extra soft steel, with an ultimate tensile strength of 55,000 lb per sq. in. The material must be sufficiently tough to bend cold 180° flat on itself without sign of fracture. The greatest care is taken that no steel is left in a brittle condition by heating and cooling without proper annealing. All abutting joints in riveted work are faced to exact lengths and absolutely at right angles to the axis of the piece, and are spliced by scarf plates of proper dimensions adequately secured by rivets. The work should be so accurate that no packing pieces are necessary. If the conditions are such that a packing or filling piece must be used, the end of one piece is cut to a new and true surface, and the filling piece is planed to fill the space accurately. Where cast iron is used it must be of tough grey iron free from defects. In testing it pieces 14 in. long and 1 in. square are cast from each heat and supported on blunt knife edges spaced 12 in. apart;

under a load in the centre of the piece of 2500 lb the deflexion must not exceed $\frac{1}{8}$ in.

The filling between the girders and floor beams consists of segmental arches of brick, segmental or flat arches of porous (sawdust) terra-cotta, or hard-burned hollow terra-cotta voussoirs, or various patented forms of concrete floors containing ties or supports of steel or iron. In all cases it is customary to fill on top of the arches with a strong Portland cement concrete to a uniform level, generally the top of the deepest beam; the floor filling is constructed and carried to this level immediately upon the completion of each tier of beams, for the purpose not only of stiffening the frame laterally, and of adding to its stability by the imposition of a static load, but also to afford constantly safe and strong working platforms at regular and convenient intervals for use throughout the entire period of the construction. In cases in which the lateral rigidity of the floors is depended upon to transfer the horizontal strains to the exterior walls which are framed to resist them, no form of floor construction should be used which is not laterally strong and rigid. With very rapid building, no method of construction of floors furrings, or partitions should be adopted which will not dry out with great speed. In flat forms of masonry floor construction the level of its bottom is placed somewhat below the bottom of the “I” beams and girders, so that when it is plastered a continuous surface of at least an inch of mortar will form a fire-proof protection for the lower flanges of the beams and girders. Where the width of the flange is considerable it is first covered with metal lath secured to the under side of the floor masonry. Girders projecting below the floor are usually encased in from 1 to 2 in. of fire-proof material, 2 or 4 in. of which is also put on all columns. Such fire-proof coverings, and also interior partitions, are composed of hollow, hard-burned terra-cotta blocks, of porous (sawdust) terra cotta, or various plastic compositions applied to metallic lath, many of which are patented both as to material and method of application. The most simple test for the value of a system of fire-proof coverings, and of partitions and furrings, is to erect a large sample of the work and to subject it alternately to the continued action of an intensely hot flame which is allowed to impinge upon it, and to a stream of cold water directed upon it from the ordinary service nozzle of a steam fire engine. It is important in all fire-proofing of columns and girders, and in all floor construction, furring and partitions, that there shall be no continuous voids, either vertical or horizontal, which may possibly serve as flues for the spread of heat or flame in case of fire. All furrings and partitions must be started on the solid masonry of the floors to prevent the possible passage of fire from the room in which it may occur. The failure to make this provision has been the cause of very serious losses in buildings which were supposed to be fire-proof.

Steel construction possesses great advantages in time required for erection. When once the site is cleared and the foundations prepared and set, work can be pushed on the walls at different storeys at one and the same time, and often main cornices and filling-in work are fixed before special details and ornamentation. In the Commercial Cable Building, New York, seven complete tiers aggregating 7000 tons were erected in nine weeks. In the Unity Building, Chicago, of seventeen storeys, the metal framework from basement columns to finished roof was accomplished in nine weeks. In the Fisher Building, Chicago, the entire steel skeleton above the first floor, nineteen storeys and attic, was erected in twenty-six days.

Owing to the low price of steel it is possible to make a steel column of equivalent strength cheaper than one in cast iron. The question of cost is purely a commercial one, but the cost of the raw material will practically never determine the relative cost between various forms, as the expense of manufacture and the detail and duplication of members will all influence the ultimate cost to a much greater extent than the simple cost of the plain materials. The steelwork for a building of any considerable size is almost invariably rolled to order.

**Floor-filling
and
Partitions.**

**Time and
Cost of
Erection.**

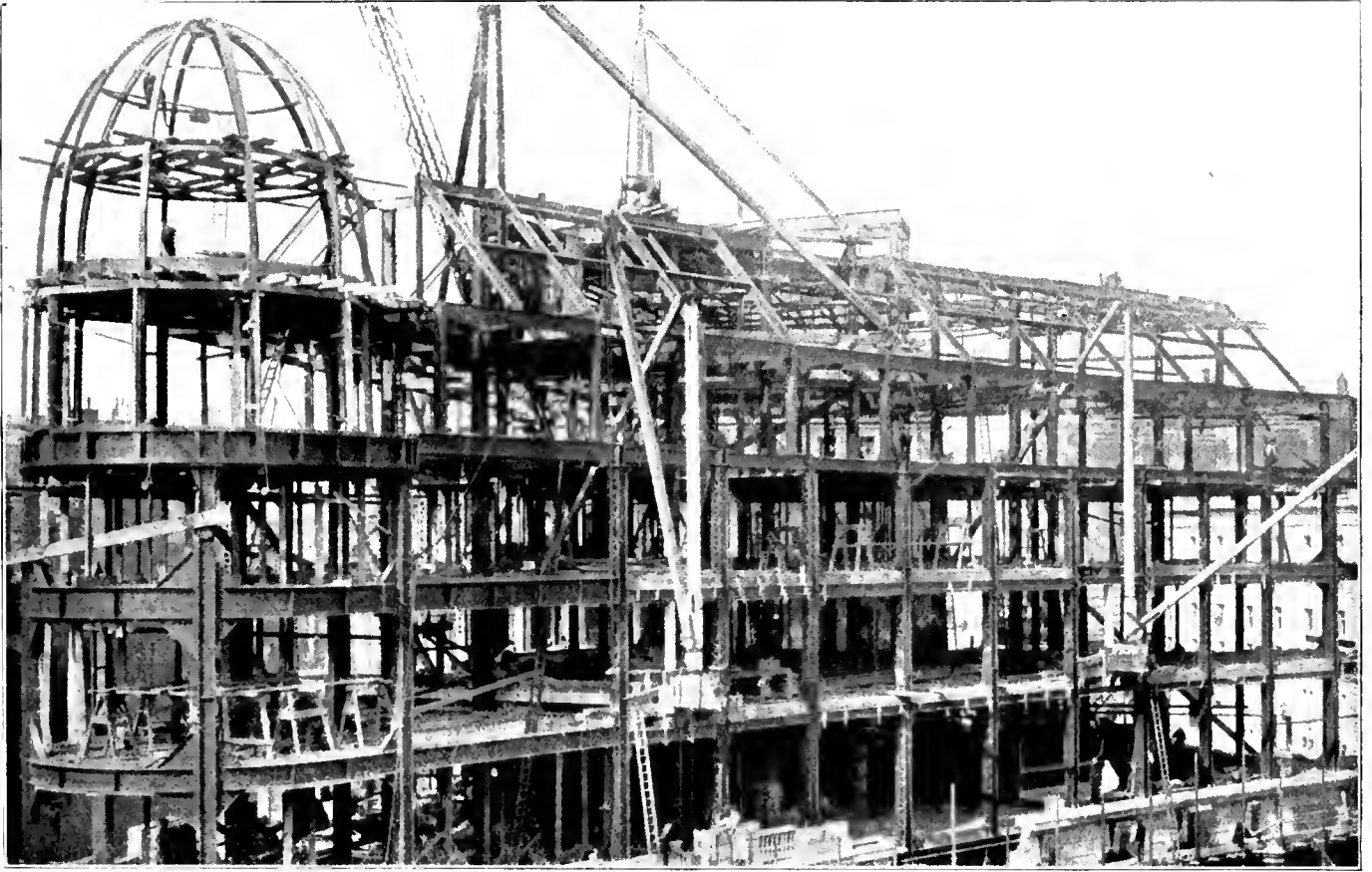

FIG. 1.—THE MORNING POST BUILDING, LONDON.

Mewes & Davis, Architects.

Waring White Building Co. Ltd., Contractors.

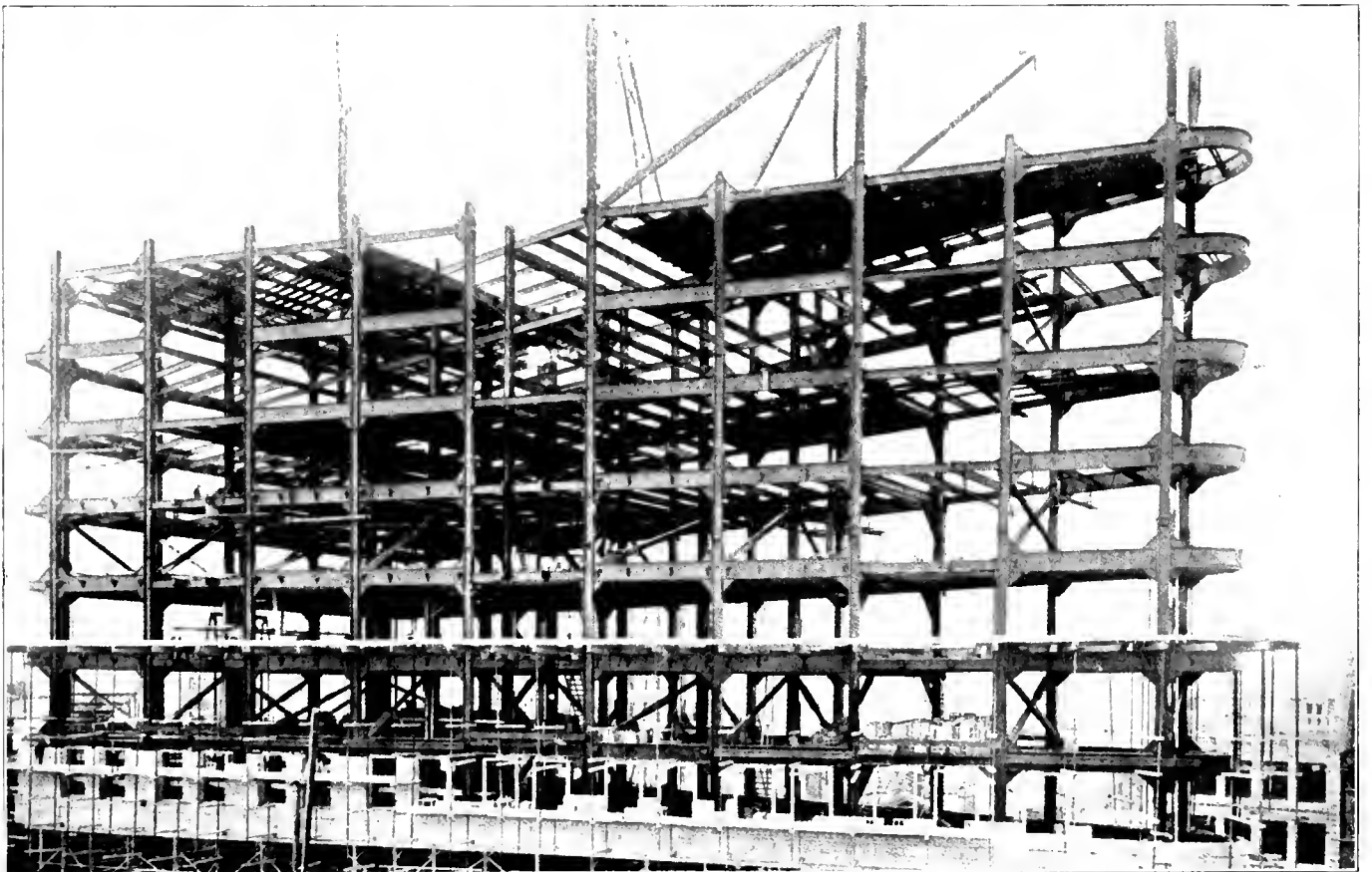

FIG. 2.—THE FLATIRON BUILDING, NEW YORK CITY.

D. H. Burnham & Co., Architects.

Geo. A. Fuller & Co., Contractors.

STEEL CONSTRUCTION

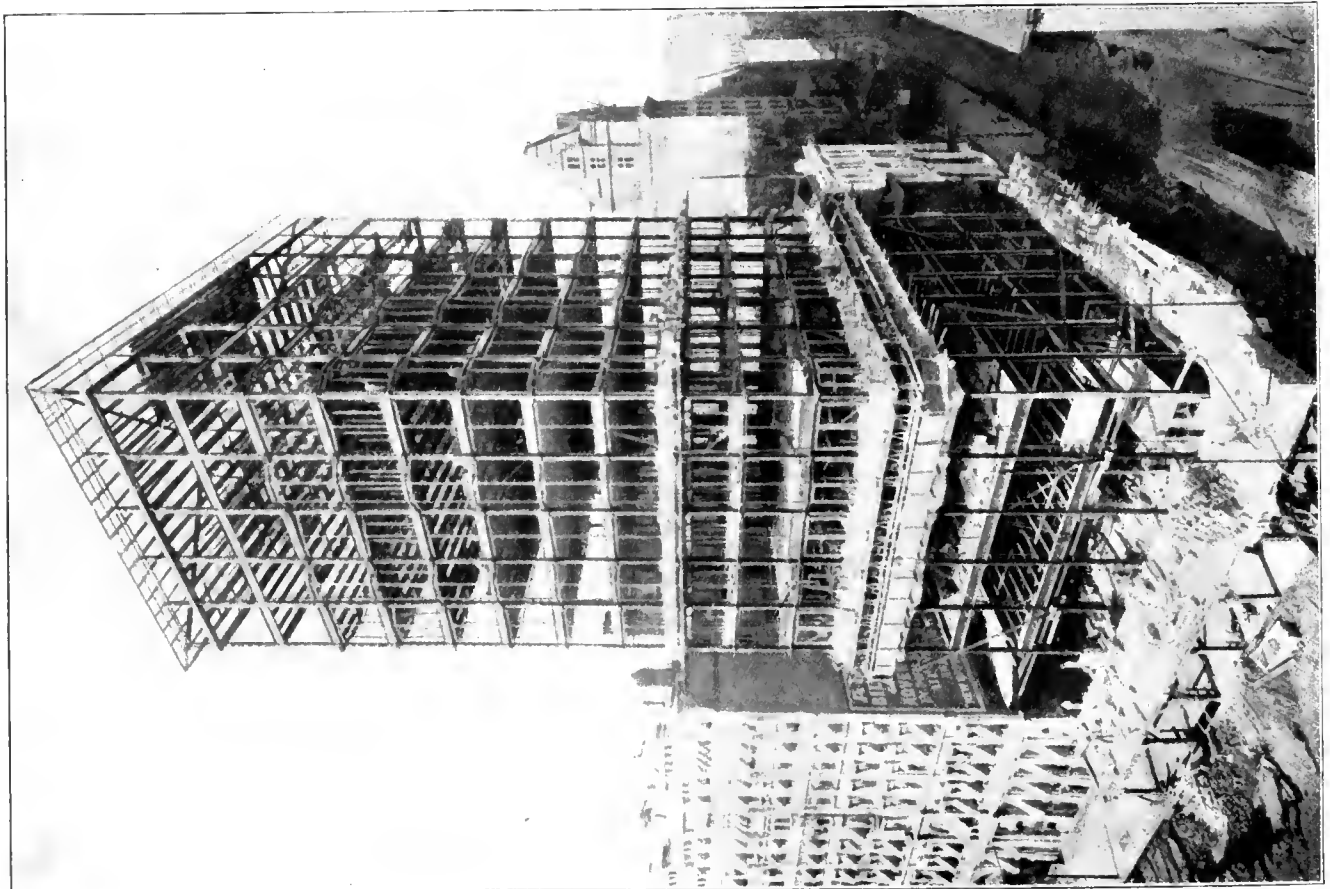

FIG. 3.—LAND TITLE BUILDING, PHILADELPHIA.
D. H. Burnham & Co., Architects.
Charles McCaul & Co., Contractors.

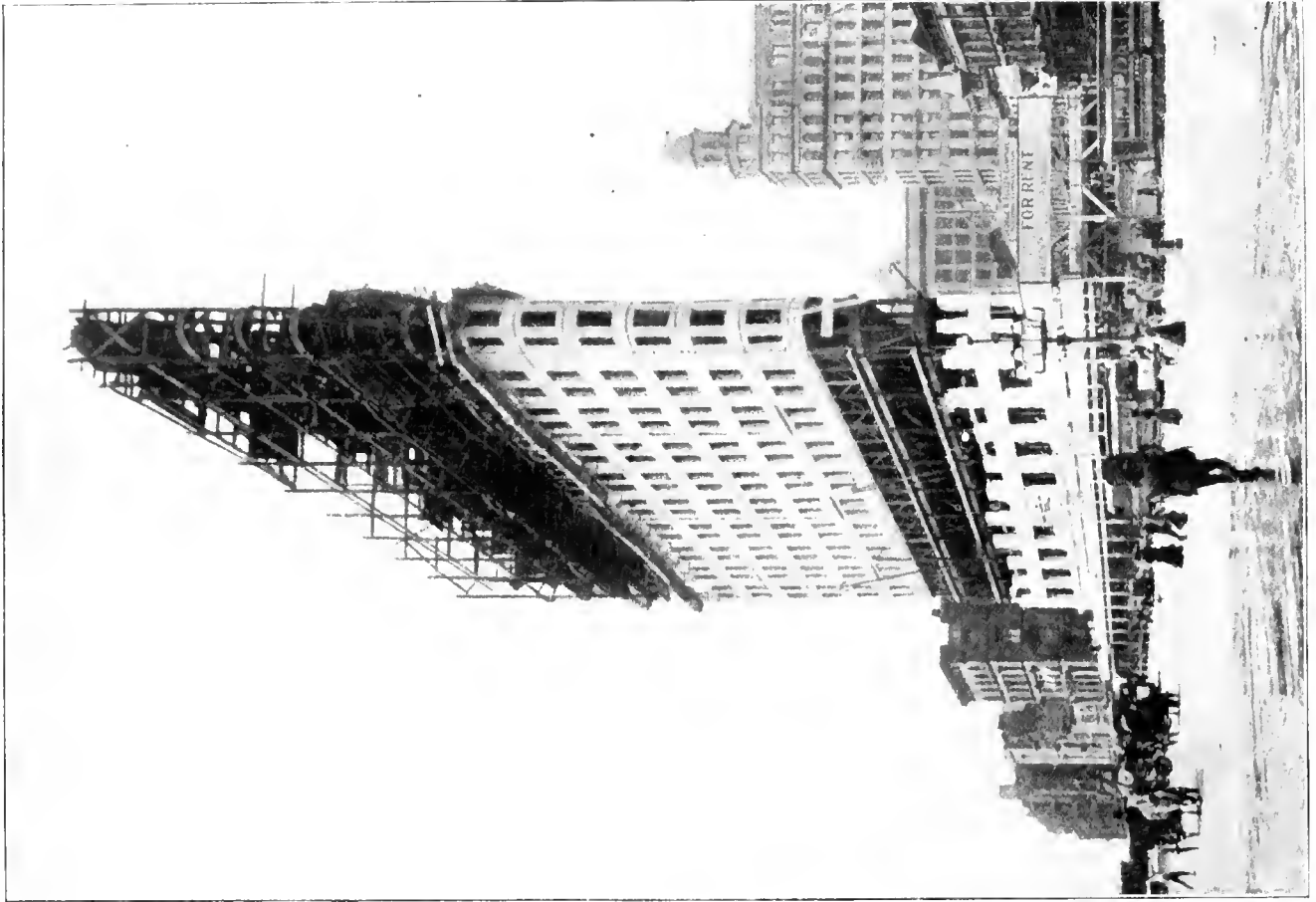

FIG. 4.—FLATIRON BUILDING, NEW YORK CITY.
D. H. Burnham & Co., Architects.
Geo. A. Fuller Co., Contractors.
(For illustration of finished building, see ARCHITECTURE, FIG. 131, PLATE XV.)

Steel construction and the rapid development of engineering practice has affected not only the erection of tall buildings, but has also produced improvement in the erection of factory and workshop premises. Modern workshops consist of wider buildings of greater height with plenty of roof-light, efficient ventilation, and artificial heating, and as the heavy loads can be carried by the reinforcing material, heavy walls become unnecessary. Gradually, therefore, the modern steel-framed factory has been evolved, capable of supporting all the loads, the outer walls being required only for protection against weather. Light steel roof trusses have replaced the timber trusses, and with the columns form a rigid framework to resist the structural and wind loads as well as those from the cranes and shafting.

In Germany skeleton steel-framed factory buildings may be erected with half brick (12 cm.), with a restriction that when such buildings are abutting or are in the immediate neighbourhood, *i.e.* within 20 ft. of a neighbouring building, the outside walls on the sides affected shall be full brick (25 cm.).

The permissible height to which a building may be erected on the continent of Europe depends largely on the breadth of the road on which such buildings are situated. As a rule it is not permissible to erect a building wider than the road, measured from building line to building line.

In American practice the use of steel in buildings of ten or more storeys, or in manufacturing plant where the floor loads are heavy and frequently "live" in the sense of causing vibration, has led to more careful specifications as to the quality of materials and character of workmanship, and it is the custom of the leading architects to have the structural frame inspected and tested during manufacture at the foundries, rolling-mills and shops by a firm of engineers making a speciality of such inspections.

The illustrations (see Plates I. and II.) will give a good idea of the general construction as now carried out in England and America.

AUTHORITIES.—See Birkmore, *The Planning and Construction of High Office Buildings*; Farnworth, *Constructional Steel Work*; J. K. Frietag, *Architectural Engineering*; Kitchin, *Steel Mill Buildings*; *Carnegie Steel Company's Pocket Companion*; *Pencoyd Iron Works Handbook*. (J. Bt.)

STEELE, ANNE (1717–1778), English hymn writer, was born at Broughton, Hampshire, in 1717. The drowning of her betrothed a few hours before the time fixed for her marriage deeply affected an otherwise quiet life, and her hymns rather emphasize the less optimistic phases of Christian experience. In 1760 she published *Poems on Subjects Chiefly Devotional* under the name "Theodosia," and her complete works (144 hymns, 34 metrical psalms and 50 moral poems) appeared in one volume in London (1863). She was a Baptist, and her hymns are much used by members of that communion, though some of them, *e.g.* "Father of mercies, in Thy word," have found their way into the collections of other Churches. She has been called the Frances Ridley Havergal of the 18th century.

STEELE, SIR RICHARD (1672–1729), English man of letters in the reign of Queen Anne, is inseparably associated in the history of literature with his personal friend Addison. He cannot be said to have lost in reputation by the partnership, because he was inferior to Addison in purely literary gift, and it is Addison's literary genius that has floated their joint work above merely journalistic celebrity; but the advantage was not all on Steele's side, inasmuch as his more brilliant coadjutor has usurped not a little of the merit rightly due to him. Steele's often-quoted generous acknowledgment of Addison's services in the *Tatler* has proved true in a somewhat different sense from that intended by the writer: "I fared like a distressed prince who calls in a powerful neighbour to his aid; I was undone by my auxiliary; when I had once called him in I could not subsist without dependence on him." The truth is that in this happy alliance the one was the complement of the other; and the balance of mutual advantage was much more nearly even than Steele claimed or posterity has generally allowed.

The famous literary pair were born in the same year. Steele, the senior by less than two months, was baptized on the 12th of March 1672 in Dublin. His father, also Richard Steele, was an attorney. He died before his son had reached his sixth year, but the boy found a protector in his maternal uncle, Henry Gascoigne, secretary and confidential agent to two successive dukes of Ormond. Through his influence he was nominated to the Charterhouse in 1684, and there first met with Addison. Five years afterwards he proceeded to Christ Church, Oxford, and was a postmaster at Merton when Addison was a demy at Magdalen. Their schoolboy friendship was continued at the university, and probably helped to give a more serious turn to Steele's mind than his natural temperament would have taken under different companionship. Addison's father also took an interest in the warm-hearted young Irishman; but their combined influence did not steady him sufficiently to keep his impulses within the lines of a regular career; without waiting for a degree he volunteered into the army, and served for some time as a cadet "under the command of the unfortunate duke of Ormond" (*i.e.* the first duke's grandson, who was attainted in 1715). This escapade was made without his uncle's consent, and cost him, according to his own account, "the succession to a very good estate in the county of Wexford in Ireland." Still, he did not lack advancement in the profession he had chosen. A poem on the funeral of Queen Mary (1695), dedicated to Lord Cutts, colonel of the Coldstream Guards, brought him under the notice of that nobleman, who took the gentleman trooper into his household as a secretary, made him an officer in his own regiment, and ultimately procured for him a captaincy in Lord Lucas's regiment of foot. His name was noted for promotion by King William, but the king's death took place before anything had been done for Captain Steele. A duel which he fought with Captain Kelly in Hyde Park in 1700, and in which he wounded his antagonist dangerously, inspired him with the dislike of the practice that he showed to the end of his life.

Steele probably owed the king's favour to a timely reference to his majesty in *The Christian Hero*, his first prose treatise, published in April 1701. The "reformation of manners" was a cherished purpose with King William and his consort, which they tried to effect by proclamation and act of parliament; and a sensible well-written treatise, deploring the irregularity of the military character, and seeking to prove by examples—the king himself among the number—"that no principles but those of religion are sufficient to make a great man," was sure of attention. Steele complained that the reception of *The Christian Hero* by his comrades was not so respectful; they persisted in trying him by his own standard, and would not pass "the least levity in his words and actions" without protest. His uneasiness under the ridicule of his irreverent comrades had a curious result: it moved him to write a comedy. "It was now incumbent upon him," he says "to enliven his character, for which reason he writ the comedy called *The Funeral*." Although, however, it was Steele's express purpose to free his character from the reproach of solemn dullness, and prove that he could write as smartly as another, he showed greater respect for decency than had for some time been the fashion on the stage. The purpose, afterwards more fully effected in his famous periodicals, of reconciling wit, good humour and good breeding with virtuous conduct was already deliberately in Steele's mind when he wrote his first comedy. It was produced and published in 1701, and received on the stage with favour. In his next comedy, *The Lying Lover; or, the Ladies' Friendship*, based on Corneille's *Menteur*, produced two years afterwards, in December 1703, Steele's moral purpose was directly avowed, and the play, according to his own statement, was "damned for its piety." *The Tender Husband*, an imitation of Molière's *Sicilien*, produced eighteen months later (in April 1705), though not less pure in tone, was more successful; in this play he gave unmistakable evidence of his happy genius for conceiving and embodying humorous types of character, putting on the stage the parents or grandparents of Squire Western, Tony Lumpkin and Lydia Languish. It was seventeen years before Steele

again tried his fortune on the stage with *The Conscious Lovers*, the best and most successful of his comedies, produced in December 1722.

Meanwhile the gallant captain had turned aside to another kind of literary work, in which, with the assistance of his friend Addison, he obtained a more enduring reputation. There never was a time when literary talent was so much sought after and rewarded by statesmen. Addison had already been waited on in "his humble lodgings in the Haymarket," and advanced to office, when his friend the successful dramatist was appointed to the office of gazetteer. This was in April or May 1707. It was Steele's first connexion with journalism. The periodical was at that time taking the place of the pamphlet as an instrument for working on public opinion. The *Gazette* gave little opening for the play of Steele's lively pen, his main duty, as he says, having been to "keep the paper very innocent and very insipid"; but the position made him familiar with the new field of enterprise in which his inventive mind soon discerned materials for a project of his own. The *Tatler* made its first appearance on the 12th of April 1709. It was partly a newspaper, a journal of politics and society, published three times a week. Steele's position as gazetteer furnished him with special advantages for political news, and as a popular frequenter of coffee-houses he was at no loss for social gossip. But Steele not only retailed and commented on social news, a function in which he had been anticipated by Defoe and others; he also gradually introduced into the *Tatler* as a special feature essays on general questions of manners and morality. It is not strictly true that Steele was the inventor of the English "essay"—there were essayists before the 18th century, notably Cowley and Temple; but he was the first to use the essay for periodical purposes, and he and Addison together developed a distinct species, to which they gave a permanent character, and in which they had many imitators. As a humbler motive for this fortunate venture Steele had the pinch of impecuniosity, due rather to excess of expenditure than to smallness of income. He had £300 a year from his gazetteership (paying a tax of £45), £100 as gentleman waiter to Prince George, £850 from the Barbadoes estates of his first wife, a widow named Margaret Stretch, and some fortune by his second wife—Mrs Mary Scurlock, the "dear Prue" of his charming letters. But Steele lived in considerable state after his second marriage, and before he started the *Tatler* was reduced to the necessity of borrowing. The assumed name of the editor was Isaac Bickerstaff, but Addison discovered the real author in the sixth number, and began to contribute in the eighteenth. It is only fair to Steele to state that the success of the *Tatler* was established before Addison joined him, and that Addison contributed to only forty-two of the two hundred and seventy-one numbers that had appeared when the paper was stopped, obscurely, in January 1711. Some papers satirizing Harley appeared in the *Tatler*, and Steele lost or resigned the post of gazetteer. It is possible that this political recklessness may have had something to do with the sudden end of the venture.

Only two months elapsed between the stoppage of the *Tatler* and the appearance of the *Spectator*, which was the organ of the two friends from the 1st of March 1711 till the 6th of December 1712. Addison was the chief contributor to the new venture, and the history of it belongs more to his life. Nevertheless, it is to be remarked as characteristic of the two writers that in this as in the *Tatler* Addison generally follows Steele's lead in the choice of subjects. The first suggestion of Sir Roger de Coverley was Steele's although it was Addison that filled in the outline of a good-natured country gentleman with the numerous little whimsicalities that convert Sir Roger into an amiable and exquisitely ridiculous provincial oddity. Steele had neither the fineness of touch nor the humorous malice that gives life and distinction to Addison's picture; the Sir Roger of his original hasty sketch has good sense as well as good nature, and the treatment is comparatively commonplace from a literary point of view, though unfortunately not commonplace in its charity. Steele's suggestive

vivacity gave many another hint for the elaborating skill of his friend.

The *Spectator* was followed by the *Guardian*, the first number of which appeared on the 12th of March 1713. It had a much shorter career, extending to only a hundred and seventy-six numbers, of which Steele wrote eighty-two. This was the last of his numerous periodicals in which he had the material assistance of Addison. But he continued for several years to project journals, under various titles, some of them political, some social in their objects, most of them very short-lived. Steele was a warm partisan of the principles of the Revolution, as earnest in his political as in his other convictions. The *Englishman* was started in October 1733, immediately after the stoppage of the *Guardian*, to assail the policy of the Tory ministry. The *Lover*, started in February 1714, was more general in its aims; but it gave place in a month or two to the *Reader*, a direct counterblast to the Tory *Examiner*. The *Englishman* was resuscitated for another volume in 1715; and he subsequently projected in rapid succession three unsuccessful ventures—*Town Talk*, the *Tea Table* and *Chit Chat*. Three years later he started his most famous political paper the *Plebeian*, rendered memorable by the fact that it embroiled him with his old ally Addison. The subject of controversy between the two lifelong friends was Sunderland's Peerage Bill. Steele's last venture in journalism was the *Theatre*, 1720, the immediate occasion of which was the revocation of his patent for Drury Lane. Besides these journals he wrote also several pamphlets on passing questions—on the disgrace of Marlborough in 1711, on the fortifications of Dunkirk in 1713, on the "crisis" in 1714, *An Apology for Himself and his Writings* (important biographically) in the same year, and on the South Sea mania in 1720.

The fortunes of Steele as a zealous Whig varied with the fortunes of his party. Over the Dunkirk question he waxed so hot that he threw up a pension and a commissionership of stamps, and went into parliament as member for Stockbridge to attack the ministry with voice and vote as well as with pen. But he had not sat many weeks when he was expelled from the house for the language of his pamphlet on the *Crisis*, which was stigmatized as seditious. The *Apology* already mentioned was his vindication of himself on this occasion. With the accession of the House of Hanover his fortunes changed. Honours and substantial rewards were showered upon him. He was made a justice of the peace, deputy-lieutenant of Middlesex, surveyor of the royal stables, governor of the royal company of comedians—the last a lucrative post—and was also knighted (1715). After the suppression of the Jacobite rebellion he was appointed one of the commissioners of forfeited estates, and spent some two years in Scotland in that capacity. In 1718 he obtained a patent for a plan for bringing salmon alive from Ireland. Differing from his friends in power on the question of the Peerage Bill he was deprived of some of his offices, but when Walpole became chancellor of the exchequer in 1721 he was reinstated. With all his emoluments however the imprudent, impulsive, ostentatious and generous Steele could never get clear of financial difficulties, and he was obliged to retire from London in 1724 and live in the country. He spent his last years on his wife's estate of Llangunnor in Wales, and, his health broken down by a paralytic seizure, died at Carmarthen on the 1st of September 1729.

A selection from Steele's essays, with a prefatory memoir, has been edited by Mr Austin Dobson (1885; revised 1896). Mr Dobson contributed a fuller biography to Mr Andrew Lang's series of *English Worthies*, in 1886. In 1889 another and more exhaustive life was published by Mr G. A. Aitken, who has also edited Steele's plays (1898) and the *Tatler* (1898). (W. M.; A. D.)

STEELE, THOMAS (1788–1848), Irish politician and writer, a member of a Somerset family which settled in Ireland during the 17th century, was born on the 3rd of November 1788. He was educated at Trinity College, Dublin, and at Magdalene College, Cambridge, and succeeded to a large estate in Co. Clare. As a volunteer he fought against the Bourbons in Spain in 1823, and, returning to Ireland, he became an enthusiastic worker for Roman Catholic emancipation, helping greatly to

return Daniel O'Connell to parliament for Co. Clare at the famous election of 1828. It is interesting to note that Steele himself was a Protestant. Having ruined his fortune by contributing liberally to the causes in which he was interested, he died in London on the 15th of June 1848. He wrote *Notes of the War in Spain* (1824) and some essays on Irish questions.

STEELE, WILLIAM (d. 1680), lord chancellor of Ireland, was a son of Richard Steele of Sandbach, Cheshire, and was educated at Caius College, Cambridge. In 1648 he was chosen recorder of London, and he was one of the four counsel appointed to conduct the case against Charles I. in January 1649, but illness prevented him from discharging this duty. However, a few days later he took part in the prosecution of the duke of Hamilton and other Royalists. Steele was M.P. for the City of London in 1654, was chief baron of the exchequer in 1655, and was made lord chancellor of Ireland in 1656. After the fall of Richard Cromwell he was one of the five commissioners appointed in 1659 to govern Ireland. At the end of this year he returned to England, but he refused to sit on the committee of safety to which he had been named. At the Restoration he obtained the full benefits of the Act of Indemnity, but he thought it advisable to reside for a time in Holland. However, he had returned to England before his death towards the end of 1680.

See O. J. Burke, *History of the Lord Chancellors of Ireland* (Dublin, 1879).

STEELE, a town of Germany, in the Prussian Rhine Province on the navigable Ruhr, 4 m. by rail E. of Essen, at the junction of the lines Duisburg-Dortmund and Vohwinkel-Hagen. Pop. (1905), 12,988. It contains a Gothic parish church (Roman Catholic), a high school and a Roman Catholic hospital. It has coal-mines, iron and steel works, and makes fireproof bricks. A Diet of the empire was held here in the year 938 by the emperor Otto I.

STEELTON, a borough of Dauphin county, Pennsylvania, U.S.A., on the Susquehanna river, 3 m. S.E. of Harrisburg. Pop. (1890), 9250; (1900), 12,086, of whom 2300 were foreign-born and 1508 were negroes; (1910 census), 14,246. Steelton is served by the Pennsylvania and the Philadelphia & Reading railways, and is connected with Harrisburg by electric line. The city has a public library. Steelton is in an agricultural district, but its industrial importance is due primarily to the vast steel works of the Pennsylvania Steel Company. Other manufactures are flour and grist mill products, bricks, planing-mill products, &c. In 1905 the total value of the borough's factory products was \$15,745,628; the capital invested in manufacturing increased from \$6,266,068 in 1900 to \$18,642,853 in 1905, or 197.5%. There is a large limestone quarry within the borough limits. The municipality owns its waterworks and filtration plant. The place was laid out in 1866 under the name of Baldwin, but when it was incorporated as a borough, in 1880, the present name was adopted.

STEELYARD, MERCHANTS OF THE, Hanse merchants who settled in London in 1250 at the steelyard on the river-side, near Cosin Lane, now Ironbridge Wharf. Henry III. in 1259, at the request of his brother Richard of Cornwall, king of the Romans, conferred on them important privileges, which were confirmed by Edward I. It was chiefly through their enterprise that the early trade of London was developed, and they continued to flourish till, on the complaint of the Merchant Adventurers in the reign of Edward VI., they were deprived of their privileges. Though Hamburg and Lübeck sent ambassadors to intercede for them, they were not reinstated in their monopolies, but they succeeded in maintaining a footing in London till expelled by Elizabeth in 1597. Their beautiful guildhall in Thames Street, adorned with allegorical pictures by Holbein, and described by Stow, was made a naval storehouse. The land and buildings still remained the property of the Hanseatic League, and were subsequently let to merchants for business purposes. Destroyed in the Great Fire of 1666 they were rebuilt as warehouses, and were finally sold to the South-Eastern Railway Company in 1852 by the Hanseatic towns, Lübeck, Bremen and

Hamburg. The site is now occupied by Cannon Street railway station.

See Lappenburg, *Urkundliche Geschichte des hansischen Stahlhofes zu London* (Hamburg, 1851); Stow, *Survey of London* (1598); Pauli, *Pictures of Old London* (1851); Ehrenberg, *Hamburg und England im Zeitalter der Königin Elizabeth* (Jena, 1896).

STEEN, JAN HAVICKSZ (1626–1679), Dutch subject-painter, was born at Leiden in 1626, the son of a brewer of the place. He studied at Utrecht under Nicolas Knupfer, a German historical painter. Dr Bode suggests that, before entering Knupfer's studio, Jan Steen took drawing lessons from Jacob de Wet in Haarlem. He bases his theory on the internal evidence of such early pictures as the "Market at Leiden" (Staedel Institute, Frankfurt), the "Kermesse" (A. von Goldschmidt-Rothschild, Berlin), "Calling for the Bride" (Six Collection, Amsterdam), and "St John's Sermon" (Dessau Castle). About the year 1644 Steen went to Haarlem, where he worked under Adrian van Ostade and under Jan van Goyen, whose daughter he married in 1649. In the previous year he had joined the painters' guild of the city. In 1667 he is said to have been a brewer at Delft; in 1669 a small debt of ten florins owing to an apothecary led to the seizure and sale of his pictures; and in 1672 he received municipal authority to open a tavern. In 1673 he took a second wife, Maria van Egmont, the widow of a bookseller in Leiden. The accounts of his life, however, are very confusing and conflicting. Some biographers have asserted that he was a drunkard and of dissolute life, but the number of his works—Van Westheene, in his *Jan Steen, étude sur l'art en Hollande*, has catalogued nearly five hundred and Hofstede de Groot about double that number—seems sufficient in itself to disprove the charge. His later pictures bear marks of haste and are less carefully finished than those of his earlier period. He died at Leiden in 1679.

The works of Jan Steen are distinguished by correctness of drawing, admirable freedom and spirit of touch, and clearness and transparency of colouring. But their true greatness is due to their intellectual qualities. In the wide range of his subjects, and their dramatic character, he surpasses all the Dutch figure-painters, with the single exception of Rembrandt. His productions range from the stately interiors of grave and wealthy citizens to tavern scenes of jollity and debauch. He painted chemists in their laboratories, doctors at the bedside of their patients, card-parties, marriage feasts, and the festivals of St Nicholas and Twelfth Night—even religious subjects, though in these he was least successful. His rendering of children is especially delightful. Dealing often with the coarser side of things, his work is full of humour; he depicts the comedy of human life in a spirit of very genial toleration, but now and again there appear keenly telling touches of satire which recall a pictorial moralist such as Hogarth. Portraits from his brush are comparatively rare. The best known is the portrait of himself at the Rijksmuseum in Amsterdam.

The National Gallery contains three pictures by Jan Steen, of which the "Music Master" is the most important, and other excellent examples of his art in England are preserved in the Royal, the Bute, and the Northbrook collections, at Apsley House and Bridgewater House, and in the galleries of the Hague, Amsterdam, and the Hermitage, St Petersburg. A remarkably fine example of his work, which appeared at the Royal Academy Winter Exhibition in 1907, is the "Grace Before Meat."

STEENKIRK (STEENKERKE), a village in the Belgian province of Hainaut, on the river Senne, famous for the battle of Steenkirk (Steinkirk, Estinkerke) fought on July 23rd/August 3rd 1692 between the Allies (see GRAND ALLIANCE, WAR OF THE) under William III. of England and the French commanded by the duke of Luxembourg. Previous to the battle the French army lay facing north-west, with its right on the Senne at Steenkirk and its left towards Enghien, while the army of William III. was encamped about Hal. In accordance with the strategical methods of the time, the French, not wishing to fight after having achieved the immediate object, the capture of Namur, took up a strong position, supposing the enemy would not dare to attack it, while the Allies, who would otherwise

in all probability have done as the French marshal desired, were by the fortune of war afforded the opportunity of surprising a part of the enemy's forces. For in the 17th century, when the objects of a war were as far as possible secured without the loss of valuable lives, and general decisive battles were in every way considered undesirable, a brilliant victory over a part, not the whole, of the enemy's forces was the tactical idea of the best generals, and accordingly William, having completely misled the enemy by forcing a detected spy to give Luxemburg false news, set his army in motion before dawn on July 23rd/ August 3rd to surprise the French right about Steenkirk. The advanced guard of infantry and pioneers, under the duke of Württemberg, deployed close to the French camps ere Luxemburg became aware of the impending blow; at this moment the main body of the army farther back was forming up after the passage of some woods. When the fight opened, Luxemburg was completely surprised, and he could do no more than hurry the nearest foot and dragoons into action as each regiment came on the scene. But the march of the Allies' main body had been mismanaged; while Württemberg methodically cannonaded the enemy, waiting for support and for the order to advance, and the French worked with feverish energy to form a strong and well-covered line of battle at the threatened point, the Allies' main body, which had marched in the usual order, one wing of cavalry leading, the infantry following, and the other wing of cavalry at the tail of the column, was being hastily sorted out into infantry and cavalry, for the ground was only suitable for the former. A few battalions only had come up to support the advanced guard when the real attack opened (12.30). The advanced guard had already been under arms for nine hours, and the march had been over bad ground, but its attack swept the first French line before it. The English and Danes stubbornly advanced, the second and third lines of the French infantry giving ground before them, but Luxemburg was rapidly massing his whole force to crush them, and meanwhile the confusion in the allied main body had reached its height. Count Solms, who commanded it, ordered the cavalry forward, but the mounted men, scarcely able to move over the bad roads and heavy ground, only blocked the way for the infantry. Some of the English foot, with curses upon Solms and the Dutch generals, broke out to the front, and Solms, angry and excited, thereupon refused to listen to all appeals for aid from the front. No attempt was made to engage and hold the centre and left of the French army, which hurried, regiment after regiment, to take part in the fighting at Steenkirk. William's counter-order that the infantry was to go forward, the cavalry to halt, only made matters worse, and by now the advanced guard had at last been brought to a standstill. At the crisis Luxemburg had not hesitated to throw the whole of the French and Swiss guards, led by the princes of the royal house, into the fight, and as, during and after this supreme effort, more and more French troops appeared from the side of Enghien, the Allies were driven back, contesting every step by weight of numbers. Those troops of the main body, foot and dragoons, which succeeded in reaching the front, served only to cover and to steady the retreat of Württemberg's force, and, the *coup* having manifestly failed, William ordered the retreat. The Allies retired as they had come, their rear-guard showing too stubborn a front for the French to attack. The latter were indeed in no state to pursue. Over eight thousand men out of only about fifteen thousand engaged on the side of the Allies were killed and wounded, and the losses of the French out of a much larger force were at least equal. Contemporary soldiers affirmed that Steenkirk was the hardest battle ever fought by infantry, and the battle served not only to illustrate the splendid discipline of the old professional armies, but also to give point to the reluctance of the generals of those days to fight battles in which, once the fighting spirit was unchained, the armies shot each other to pieces before either would give way.

STEEPLE (akin to "steep"), a general architectural name (Fr. *clocher*, Ital. *campanile*, Ger. *Glockenturm*) for the whole arrangement of tower, belfry, spire, &c.

STEEPLECHASE, a variety of horse-racing not run on the flat, but either across country or on a made course with artificial fences, water-jumps, &c. (see **HORSE-RACING**). The origin of the sport and the name is due to matches run by owners of hunters, the goal being some prominent landmark, such as a neighbouring church steeple. There is an early record of such a match in 1752 in Ireland, when the course was $4\frac{1}{2}$ m., "from the Church of Buttevaut to the spire of St Leger Church." The name is sometimes used of cross-country running or of a race on a made course over hurdles and other obstacles. It is also given to an English variation of the old French game of Goose (*q.v.*). It is played with two dice on a board, on which is depicted a race-course with hurdles, water-jumps and other obstacles. The course is marked in 60 compartments by means of radii, and the game is won by the player whose horse makes the circuit in the fewest throws. Each player is provided with a marker, usually in the form of a jockey on horseback, which is moved forward after each throw to the space to which the number thrown entitles it.

STEER, PAUL WILSON (1860-), English painter, was born at Birkenhead. He was trained first at the Gloucester school of art and afterwards in Paris at the Académie Julian, and in the École des Beaux Arts under Cabanel. After 1886, before which date he had shown three pictures at the Royal Academy, practically the whole of his work was seen in the exhibitions of the New English Art Club, of which he is a prominent member. His figure subjects and landscapes show great originality and technical skill (see **PAINTING: Recent British**). His portrait of himself is included in the collection in the Uffizi Gallery, Florence.

STEEVENS, GEORGE (1736-1800), English Shakespearian commentator, was born at Poplar on the 10th of May 1736, the son of an East India captain, afterwards a director of the company. He was educated at Eton and at King's College, Cambridge, where he resided from 1753 to 1756. Leaving the university without a degree, he settled in chambers in the Temple, removing later to a house on Hampstead Heath, where he collected a valuable library, rich in Elizabethan literature. He also accumulated a large collection of Hogarth prints, and his notes on the subject were incorporated in John Nichols's *Genuine Works of Hogarth*. He walked from Hampstead to London every morning before seven o'clock, discussed Shakespearian questions with his friend, Isaac Reed, and, after making his daily round of the booksellers' shops, returned to Hampstead. He began his labours as a Shakespearian editor with reprints of the quarto editions of Shakespeare's plays, entitled *Twenty of the Plays of Shakespeare . . .* (1766). Dr Johnson was impressed by the value of this work, and suggested that Steevens should prepare a complete edition of Shakespeare. The result, known as Johnson's and Steevens's edition, was *The Works of Shakespeare with the Corrections and Illustrations of Various Commentators* (10 vols., 1773), Johnson's contributions to which were very slight. This early attempt at a variorum edition was revised and reprinted in 1778, and further edited in 1785 by Isaac Reed; but in 1793 Steevens, who had asserted that he was now a "dowager-editor," was persuaded by his jealousy of Edmund Malone to resume his labours. The definitive result of his researches was embodied in an edition of fifteen volumes. He made changes in the text sometimes apparently with the sole object of showing how much abler he was as an emendator than Malone, but his wide knowledge of Elizabethan literature stood him in good stead, and subsequent editors have gone to his pages for parallel passages from contemporary authors. His deficiencies from the point of view of purely literary criticism are apparent from the fact that he excluded Shakespeare's sonnets and poems because, he wrote, "the strongest act of parliament that could be framed would fail to compel readers into their service." In the twenty years between 1773 and 1793 he was less harmlessly engaged in criticizing his fellows and playing malicious practical jokes on them. Dr Johnson, who was one of his stanchest friends, said he had come to live the life of an outlaw, but he was generous and to a small circle

of friends civil and kind. He was one of the foremost in exposing the Chatterton-Rowley and the Ireland forgeries. He wrote an entirely fictitious account of the Java upas tree, derived from an imaginary Dutch traveller, which imposed on Erasmus Darwin, and he hoaxed the Society of Antiquaries with the tombstone of Hardicanute, supposed to have been dug up in Kennington, but really engraved with an Anglo-Saxon inscription of his own invention. He died at Hampstead on the 22nd of January 1800. A monument to his memory by Flaxman, with an inscription commemorating his Shakespearian labours, was erected in Poplar Chapel. The sale catalogue of his valuable library is in the British Museum.

Steevens's Shakespeare was re-issued by Isaac Reed in 1803, in 21 volumes, with additional notes left by Steevens. This, which is known as the "first variorum" edition, was reprinted in 1813. Steevens's notes are also incorporated in the edition of 1821, begun by Edmund Malone and completed by James Boswell the younger.

STEEVENS, GEORGE WARRINGTON (1860–1900), English journalist, was born at Sydenham, near London, on the 10th of December 1860, and was educated at the City of London School and Balliol College, Oxford, of which he was a scholar. He first began to write in undergraduate periodicals. In 1893 he was elected a fellow of Pembroke College, Oxford, and in the same year spent some time at Cambridge, editing a weekly periodical, the *Cambridge Observer*, and becoming a contributor to the *National Observer*, then edited by Mr W. E. Henley. He then married and went to London, and joined the staff of the *Pall Mall Gazette*, contributing also to the *New Review* and *Blackwood's Magazine*. Some of his articles were reprinted in *Monologues of the Dead*. In 1896 he joined the staff of the *London Daily Mail*, then just started, and went on various special missions for that paper, which resulted in more than one series of articles, afterwards turned into books. In this way he published *The Land of the Dollar* (1897), *With the Conquering Turk* (1897), *Egypt in 1898*, and *With Kitchener to Khartoum* (1899). In September 1899 he went to South Africa and joined Sir George White's force in Natal as war-correspondent, being subsequently besieged in Ladysmith. He died during the siege, of enteric fever, on the 15th of January 1900. The articles he had sent home from South Africa were published posthumously in a volume called *From Capetown to Ladysmith*. Steevens had a remarkable gift of seizing the salient facts and principal characteristics in anything he wished to describe, and putting them in a vivid and readable way. His early death removed an interesting personality in English journalism.

STEFANIE, BASSO NÆBOR, or CHUWAHA, a lake of East Africa, lying in 37° E., between 4° 25' and 5° N., and measuring some 40 m. by 15. It is the southernmost and lowest (1880 ft.) of a series of lakes which lie in what appears to be a north-easterly continuation of the great East African rift valley, although this loses its clearly marked character in about 3° N. There is, however, a well defined watershed extending from the hills east of Stefanie to the Harrar range. The character of the lake, which has no outlet, varies greatly according to the amount of water brought down by its principal feeder, the Dulei, which enters at its north end, being there a fairly rapid stream 50 yds. wide and 3½ ft. deep. At low water the western part of the lake is dry. The Dulei, which rises north of 6° N., is joined in about 36° 55' E., 5° 8' N. by the Galana Sagan or Galana Amara. The Sagan in times of flood receives the overflow of the next lake in the series, Chambo or Ganjule, which lies, at a height of 3460 ft., 70 m. north-north-east of Stefanie. Chambo in turn receives the waters of a larger lake—Abai, Abaya, Pagade or Regina Margherita—through the river Walo, across a plain only 2 m. wide. Abai lies 4200 ft. above the sea, is 45 m. long and 18 m. across at its greatest width. It is cut by 38° E. There are a number of islands on the lake. All the lakes of the series are shut in by high mountains, those surrounding Lake Abai, together with the islands with which its surface is broken, being clothed with luxuriant vegetation. The chief feeder of Abai, the Bilate, rises in about 8° N. North-east of Abai are several smaller lakes unconnected with the more southerly system.

Lake Stefanie was discovered by Count Samuel Teleki in 1881, and has since, with others of the series, been explored by Donaldson Smith, V. Bottego, M. S. Welby, Oscar Neumann and others. J. J. Harrison in 1899 found the lake quite dried up, and two years later Count Wickenburg found water only in the northern part. An agreement of 1907 with Great Britain recognized the lake as within the Abyssinian Empire.

See *Geographical Journal* (Sept. 1896, Sept. and Dec. 1900, Sept. 1901, Oct. 1902). L. von Höhnel, *Discovery of Lakes Rudolf and Stefanie* (London, 1894); L. Vannutelli and C. Citerini, *L'Omo* (Milan, 1899); British War Office map, Africa, sheet 79.

STEFFANI, AGOSTINO (1653–1728), Italian ecclesiastic, diplomatist and musical composer, was born at Castelfranco on the 25th of July 1653. At a very early age he was admitted as a chorister at St Mark's, Venice. In 1667 the beauty of his voice attracted the attention of Count Tattenbach, by whom he was taken to Munich, where his education was completed at the expense of Ferdinand Maria, elector of Bavaria, who appointed him "Churfürstlicher Kammer- und Hofmusikus" and granted him a liberal salary. After receiving instruction from Johann Kaspar Kerl, in whose charge he lived, he was sent in 1673 to study in Rome, where Ercole Bernabei was his master, and among other works he composed six motets, the original manuscripts of which are now in the Fitzwilliam Museum at Cambridge. On his return to Munich in 1674 he published his first work, *Psalmodia vespertina*, a part of which was reprinted in Martini's *Saggio di contrappunto* in 1674. In 1675 he was appointed court organist. The date when he was ordained priest, with the title of Abate of Lepsing, is not precisely known. His ecclesiastical status did not prevent him from turning his attention to the stage, for which, at different periods of his life, he composed work which undoubtedly exercised a potent influence upon the dramatic music of the period. Of his first opera, *Marco Aurelio*, written for the carnival and produced at Munich in 1681, the only copy known to exist is a manuscript score preserved in the royal library at Buckingham Palace. It was followed by *Solone* in 1685, by *Audacia e rispetto, prerogative d'amore* and *Servio Tullio* in 1686, by *Alarico* in 1687, and by *Niobe* in 1688; but of these works no trace can now be discovered. Notwithstanding the favour shown to him by the elector Maximilian Emanuel, he accepted in 1688 the appointment of Kapellmeister at the court of Hanover, where he speedily improved an acquaintance dating from 1681 with Ernest Augustus, duke of Brunswick-Lüneburg (afterwards elector of Hanover), winning also a pleasant footing with the duchess Sophia Charlotte (afterwards electress of Brandenburg), the philosopher Leibnitz, the Abate Ortensio Mauro, and many men of letters and intelligence, and where, in 1710, he showed great kindness to Handel, who was then just entering upon his glorious career. He inaugurated a long series of triumphs in Hanover by composing, for the opening of the new opera house in 1689, an opera called *Enrico il Leone*, which was produced with extraordinary splendour and achieved an immense reputation. For the same theatre he composed *La Lotta d'Ercole con Achilleo* in 1689, *La Superbia d'Alessandro* in 1690, *Orlando generoso* in 1691, *Le Rivali concordi* in 1692, *La Libertà contenta* in 1693, *I Trionfi del fato* and *I Bacchanali* in 1695, and *Briseide* in 1696. The libretto of *Briseide* is by Palmieri. Those of most if not all the others are by the Abate Mauro. The scores are preserved at Buckingham Palace, where, in company with five volumes of songs and three of duets, they form part of the collection brought to England by the elector of Hanover in 1714. But it was not only as a musician that Steffani distinguished himself in his new home. The elevation of Ernest Augustus to the electorate in 1692 led to difficulties, for the arrangement of which it was necessary that an ambassador should visit the various German courts, armed with a considerable amount of diplomatic power. The accomplished abate was sent on this delicate mission in 1696, with the title of envoy extraordinary, and he fulfilled his difficult task so well that Pope Innocent XI., in recognition of certain privileges he had secured for the Hanoverian Catholics, consecrated him bishop of Spiga in the Spanish West Indies.

In 1698 he was sent as ambassador to Brussels, and after the death of Ernest Augustus in the same year he entered the service of the elector palatine, John William, at Düsseldorf, where he held the offices of privy councillor and protonotary of the holy see. Invested with these high honours, Steffani could scarcely continue to produce dramatic compositions in public without grievous breach of etiquette. But his genius was too importunate to submit to repression; and in 1709 he ingeniously avoided the difficulty by producing two new operas—*Enca* at Hanover and *Tassilone* at Düsseldorf—in the name of his secretary and amanuensis Gregorio Piva, whose signature is attached to the scores preserved at Buckingham Palace. Another score—that of *Arminio*—in the same collection, dated Düsseldorf, 1707, and evidently the work of Steffani, bears no composer's name.

Steffani did not accompany the elector George to England; but in 1724 the Academy of Antient Musick in London elected him its honorary president for life; and in return for the compliment he sent the association a magnificent *Stabat Mater*, for six voices and orchestra, and three fine madrigals. The manuscripts of these are still in existence, and the British Museum possesses a very fine *Confitebor*, for three voices and orchestra, of about the same period. All these compositions are very much in advance of the age in which they were written; and in his operas Steffani shows an appreciation of the demands of the stage very remarkable indeed at a period at which the musical drama was gradually approaching the character of a merely formal concert, with scenery and dresses. But for the manuscripts at Buckingham Palace these operas would be utterly unknown; but Steffani will never cease to be remembered by his beautiful chamber-duets, which, like those of his contemporary Carlo Maria Clari (1669–1745), are chiefly written in the form of cantatas for two voices, accompanied by a figured bass. The British Museum (Add. MSS. 5055 seq.) possesses more than a hundred of these charming compositions, some of which were published at Munich in 1679. Steffani visited Italy for the last time in 1727, in which year Handel, who always gratefully remembered the kindness he had received from him at Hanover, once more met him at the palace of Cardinal Ottoboni in Rome. This was the last time the two composers were destined to meet. Steffani returned soon afterwards to Hanover, and died on the 12th of February 1728 while engaged in the transaction of some diplomatic business at Frankfort.

Steffani stands somewhat apart from contemporary Italian composers (e.g. Alessandro Scarlatti) in his mastery of instrumental forms. His opera overtures, &c., show a remarkable combination of Italian suavity with a logical conciseness of construction which is due to French influence. In vocal music he is certainly inferior to Scarlatti, and none of his famous duets, despite their charm, can compare for seriousness of intention with the Sicilian's master's chamber-cantatas. His instrumental music, however, is historically important as a factor in the artistic development of Handel.

STEFFENS, HENRIK (1773–1845), German philosopher, scientist and poet, of Norwegian extraction, was born on the 2nd of May 1773 at Stavanger, and died in Berlin on the 13th of February 1845. At the age of fourteen he went with his parents to Copenhagen, where he studied theology and natural science. In 1796 he lectured at Kiel, and a year later went to Jena to study the natural philosophy of Schelling. He went to Freiberg in 1800, and there came under the influence of Werner. After two years he returned to Copenhagen, but his lectures excited so much disapproval that he took a professorship at Halle in 1804. During the War of Liberation he served as a volunteer in the cause of freedom, and was present at the capture of Paris. From 1811 he was professor of physics at Breslau until 1832, when he accepted an invitation to Berlin. Steffens was one of the so-called Philosophers of Nature, a friend and adherent of Schelling and Schleiermacher. More than either of these two thinkers he was acquainted with the discoveries of modern science, and was thus enabled to correct or modify the highly imaginative speculations of Schelling. He held that, throughout the scheme of nature and intellectual life, the main

principle is Individualization. As organisms rise higher in the scale of development, the sharper and more distinct become their outlines, the more definite their individualities. This principle he endeavoured to deduce from his knowledge of geology, in contrast to Lorenz Oken, who developed the same theory on biological grounds. The influence of his views was considerable. Not only did Schelling and Schleiermacher modify their theories in deference to his scientific deductions, but the intellectual life of his contemporaries was considerably affected. His lectures in Copenhagen in 1802 were attended by many leading Danish thinkers, such as Oehlenschläger and Grundtvig. Schleiermacher was so much struck by their excellence that he endeavoured, unsuccessfully, to obtain for Steffens a chair in the new Berlin University in 1804, in order that his own ethical teachings should be supported in the scientific department.

His chief scientific and philosophical works are: *Beiträge zur innern Naturgeschichte der Erde* (1801); *Grundzüge der philos. Naturwissenschaft* (1806); *Anthropologie* (1824). He wrote also *Ueber die Idee der Universitäten* (1835), and *Ueber geheime Verbindungen auf Universitäten* (1835); works on religious subjects, *Karikaturen des Heiligsten* (1819–1821); *Wie ich wieder Lutheraner wurde und was mir das Lutherthum ist* (1831); *Von der falschen Theologie und dem wahren Glauben* (new ed., 1831); poetical works, *Die Familien Walseth und Leith* (1827); *Die vier Norweger* (1828); *Malcolm* (1831), collected in 1837 under the title of *Novellen*. During the last five years of his life he wrote an autobiography, *Was ich erlebte*, and after his death was published *Nachgelassene Schriften* (1846). See Tietzen, *Zur Erinnerung an Steffens*; Petersen, *Henrik Steffens* (Ger. trans., 1884); Dilthey, *Leben Schleiermachers*.

STEIBELT, DANIEL (c. 1764–1823), German pianist and composer, was born at the earliest in 1764 or 1765 in Berlin. He was indebted to the crown prince Frederick William for his musical education. Very little is known of his artistic life before 1790, when he settled in Paris and attained great popularity as a *virtuoso* by means of a pianoforte sonata called *La Coquette*, which he composed for Queen Marie Antoinette; his dramatic opera entitled *Roméo et Juliette*, produced at the Théâtre Feydeau in 1793, was equally successful. In 1796 Steibelt removed to London, where his pianoforte-playing attracted great attention. In 1798 he produced his concerto (No. 3, in E flat) containing the famous "Storm Rondo"—a work that ensured his popularity. In the following year Steibelt started on a professional tour in Germany; and, after playing with some success in Hamburg, Dresden, Prague and Berlin, he arrived in May 1800 at Vienna, where he challenged Beethoven to a trial of skill. His discomfiture was complete and he retired to Paris. During the next eight years he lived alternately in that city and in London. In 1808 he was invited by the emperor Alexander to St Petersburg, succeeding Boieldieu as director of the royal opera in 1811. Here he resided in the enjoyment of a lucrative appointment until his death on the 20th of September 1823.

Besides his dramatic music, Steibelt left behind him an enormous number of compositions for the pianoforte. His playing, though brilliant, was wanting in the higher qualities which characterized that of his contemporaries, John Cramer and Muzio Clementi; but he was gifted with talents of a high order, and the reputation he enjoyed was fully deserved.

STEIN, CHARLOTTE VON (1742–1827), the friend of Goethe, was born at Weimar on the 25th of December 1742, the eldest daughter of the Hofmarschall (master of the ceremonies) von Schardt. She became in her sixteenth year lady-in-waiting to the duchess Anna Amalia, the accomplished mother of Duke Karl August of Saxe-Weimar. In 1764 she married Freiherr Friedrich von Stein, master of the horse to the duke, and seven children were the issue of the union. Goethe, who arrived in Weimar in 1775, was soon captivated by the charm of this lady, his senior by seven years, and the *Seelenbund* (union of souls) they formed exercised a furthering and ennobling influence upon Goethe's life and work. For more than ten years Charlotte von Stein was his constant companion, and by her bright and genial nature and friendship she stimulated his efforts and assuaged his cares. On Goethe's return from Italy in 1788 the previous intimate

relations between them were relaxed, and the poet's connexion with Christiane Vulpius still further estranged them. Charlotte's jealousy and indignation at first knew no bounds, and it was only by slow degrees that friendship was restored. Charlotte von Stein was also intimate with Schiller and his wife, and numerous interesting letters from her are to be found in *Charlotte von Schiller und ihre Freunde* (vol. ii., 1862). She became a widow in 1793, but continued to live at Weimar until her death there on the 6th of January 1827.

Goethe's letters to Frau von Stein form one of the most interesting volumes of the poet's correspondence. Her own letters addressed to him were returned to her at her request and destroyed shortly before her death. A prose tragedy, *Dido*, written by her in 1792 (published 1867), is of little poetical value.

Goethe's *Briefe an Frau von Stein aus den Jahren 1776-1820* were edited by A. Schöll (3 vols., 1848-1851; 2nd ed. by W. Fielitz, 1883-1885; 3rd ed., by J. Wahle, 1900). See H. Düntzer, *Charlotte von Stein* (2 vols., 1874); id., *Charlotte von Stein und Corona Schröter* (1876); G. H. Calvert, *Charlotte von Stein* (Boston and New York, 1877); and A. Sauer, *Frauenbilder aus der Blütezeit der deutschen Literatur* (1885); W. Bode, *Charlotte von Stein* (1910).

STEIN, HEINRICH FRIEDRICH KARL, BARON VOM UND ZUM (1757-1831), German statesman, was born at the family estate near Nassau, on the 26th of October 1757. He was the ninth child of Karl Philipp, Freiherr vom Stein; the maiden name of his mother was von Simmern. His father was a man of stern and irritable temperament, which his far more famous son inherited, with the addition of intellectual gifts which the father entirely lacked. The family belonged to the order of imperial knights of the Holy Roman Empire, who occupied a middle position between sovereign princes and subjects of the empire. They owned their own domains and owed allegiance only to the emperor, but had no votes for the diet. In his old age he expressed his gratitude to his parents for "the influence of their religious and truly German and knightly example." He added, "My view of the world and of human affairs I gathered as a boy and youth, in the solitude of a country life, from ancient and modern history, and in particular I was attracted by the incidents of the eventful history of England." The influence of English ideas, which was so potent a factor in the lives of Voltaire, Rousseau, Talleyrand and many others in the 18th century, was therefore potently operative in the early career of Stein. He does not seem to have gone to any school; but in 1773 he went with a private tutor to the university of Göttingen in Hanover, where he studied jurisprudence, but also found time to pursue his studies in English history and politics, whereby, as he wrote, "my predilection for that nation was confirmed." In 1777 he left Göttingen and proceeded to Wetzlar, the legal centre of the Holy Roman Empire, in order to see the working of its institutions and thereby prepare himself for the career of the law. Next, after a stay at each of the chief South German capitals, he settled at Regensburg (Ratisbon) in order to observe the methods of the Imperial diet. In 1779 he went to Vienna, gave himself up to the gay life of that capital, and then proceeded to Berlin early in 1780.

There his admiration for Frederick the Great, together with his distaste for the pettiness of the legal procedure at Wetzlar, impelled him to take service under the Prussian monarch. He was fortunate in gaining an appointment in the department of mines and manufactures, for at the head of this office was an able and intelligent administrator, Heinitz, who helped him to master the principles of economics and civil government. In June 1785 he was sent for a time as Prussian ambassador to the courts of Mainz, Zweibrücken and Darmstadt, but he soon felt a distaste for diplomacy, and in 1786-1787 he was able to indulge his taste for travel by a tour in England, where he pursued his researches into commercial and mining affairs. In November 1787 he became Kammerdirektor, i.e. director of the board of war and domains for the king's possessions west of the river Weser; and in 1796 he was appointed supreme president of all the Westphalian chambers dealing with the commerce and mines of those Prussian lands. Among the benefits which he conferred on these districts, one of the chief was the canalization of the river Ruhr, which thenceforth became an important outlet for

the coal of that region. He also improved the navigation of the Weser, and kept up well the main roads committed to his care. On the 8th of June 1793 he married the countess Wilhelmine, daughter of Field Marshal Count Johann Ludwig von Wallmoden-Gimborn, a natural son of King George II. of Great Britain.

Stein's early training, together with the sternly practical bent of his own nature, made him completely impervious to the enthusiasm which the French Revolution had aroused in many minds in Germany. He disliked its methods as an interruption to the orderly development of peoples. Nevertheless he carefully noted the new sources of national strength which its reforms called forth in France.

Meanwhile Prussia, after being at war with France during the years 1792-95, came to terms with it at Basel in April 1795, and remained at peace until 1806, though Austria and South Germany continued the struggle with France for most of that interval. Prussia, however, lost rather than gained strength at this time; for Frederick William III., who succeeded the weak and sensual Frederick William II. in November 1797, was lacking in foresight, judgment and strength of character. He too often allowed public affairs to be warped by the advice of secret and irresponsible counsellors; and persisted in the policy of subservience to France inaugurated by the treaty of Basel. It was under these untoward circumstances that Stein in 1804 took office at Berlin as minister of state for trade. He soon felt constrained to protest against the effects of the Gallophil policy of the chief minister, Haugwitz, and the evil influences which clogged the administration. Little, however, came of Stein's protests, though they were urged with his usual incisiveness and energy. Prussian policy continued to progress on the path which led to the disaster at Jena (Oct. 14, 1806).

The king then offered to Stein the portfolio for foreign affairs, which the minister declined to accept on the ground of his incompetence to manage that department unless there was a complete change in the system of government. The real motive for his refusal was that he desired to see Hardenberg take that office and effect, with his own help, the necessary administrative changes. The king refused to accept Hardenberg, and, greatly irritated by Stein's unusually outspoken letters, dismissed him altogether, adding that he was "a refractory, insolent, obstinate and disobedient official." Stein now spent in retirement the months during which Napoleon completed the ruin of Prussia; but he saw Hardenberg called to office in April 1807 and important reforms effected in the cabinet system. During the negotiations at Tilsit, Napoleon refused to act with Hardenberg, who thereupon retired. Strange to say, the French emperor at that time suggested Stein as a possible successor. No other strong man was at hand who could save the ship of state; and on the 4th of October 1807 Frederick William, utterly depressed by the terrible terms of the treaty of Tilsit, called Stein to office and entrusted him with very wide powers.

Stein was now for a time virtually dictator of the reduced and nearly bankrupt Prussian state. The circumstances of the time and his own convictions, gained from study and experience, led him to press on drastic reforms in a way which could not otherwise have been followed. First came the Edict of Emancipation, issued at Memel on the 9th of October 1807, which abolished the institution of serfdom throughout Prussia from the 8th of October 1810. All distinctions affecting the tenure of land (noble land, peasants' land, &c.) were also swept away, and the principle of free trade in land was established forthwith. The same famous edict also abrogated all class distinctions respecting occupations and callings of any and every kind, thus striking another blow at the caste system which had been so rigorous in Prussia. Stein's next step was to strengthen the cabinet by wise changes, too complicated to be enumerated here. He also furthered the progress of the military reforms which are connected more especially with the name of Scharnhorst (*q.v.*); they refashioned the Prussian army on modern lines, with a reserve system. Stein's efforts were directed more towards civil affairs; and in this sphere he was able to

issue a measure of municipal reform (Nov. 19, 1808) which granted local self-government on enlightened yet practical lines to all Prussian towns, and even to all villages possessing more than 800 inhabitants.

Shortly afterwards the reformer had to flee from Prussia. In August 1808 the French agents, who swarmed throughout the land, had seized one of his letters, in which he spoke of his hope that Germany would soon be ready for a national rising like that of Spain. On the 10th of September Napoleon gave orders that Stein's property in the new kingdom of Westphalia should be confiscated, and he likewise put pressure on Frederick William to dismiss him. The king evaded compliance; but the French emperor, on entering Madrid in triumph, declared (December 16) *le nommé Stein* to be an enemy of France and the Confederation of the Rhine; and ordered the confiscation of all his property in the Confederation. Stein saw that his life was in danger and fled from Berlin (Jan. 5, 1809). Thanks to the help of his former colleague, Count Friedrich Wilhelm von Reden, who gave him an asylum in his castle in the Riesengebirge, he succeeded in crossing the frontier into Bohemia.

For three years he lived in the Austrian Empire, generally at Brünn; but in May 1812 he received an invitation from the emperor Alexander I. to visit St Petersburg, seeing that Austria was certain to range herself on the side of France in the forthcoming Franco-Russian War. At the crisis of that struggle Stein may have been one of the influences which kept the tsar determined never to treat with Napoleon. When the miserable remains of the Grand Army reeled back into Prussia at the close of the year, Stein urged the Russian emperor to go on and free Europe from the French domination.

Events now brought Stein rapidly to the front. On the 30th of December 1812 the Prussian general Yorck signed at Taugoggen a convention with the Russian general Diebich for neutralization of the Prussian corps at and near Tilsit, and for the free passage of the Russians through that part of the king's dominions. The Russian emperor thereupon requested Stein to act as provisional administrator of the provinces of East and West Prussia. In that capacity he convened an assembly of representatives of the local estates, which on the 5th of February 1813 ordered the establishment of a militia (*Landwehr*), a militia reserve and a final levy (*Landsturm*). The energy which Stein infused into all around him contributed not a little to this important decision, which pushed on the king's government to more decided action than at that time seemed possible. Stein now went to Breslau, whither the king of Prussia had proceeded; but the annoyance which Frederick William felt at his irregular action lessened his influence. The treaty of Kalisch between Russia and Prussia cannot be claimed as due to his actions, which were reprehended in court circles as those of a fanatic. At that time the great patriot fell ill of a fever and complained of total neglect by the king and court. He recovered, however, in time to take part in the drafting of a Russo-Prussian convention (March 19, 1813) respecting the administration of the districts which should be delivered from French occupation. During the varying phases of the campaign of 1813 Stein continued to urge the need of war *à outrance* against Napoleon. The Allies, after the entry of England and Austria into the coalition, conferred on Stein the important duties of superintending the administration of the liberated territories. After the great battle of Leipzig (Oct. 16-19, 1813) Stein entered that city the day after its occupation by the Allies and thus expressed his feelings on the fall of Napoleon's domination: "There it lies, then, the monstrous fabric cemented by the blood and tears of so many millions and reared by an insane and accursed tyranny. From one end of Germany to the other we may venture to say aloud that Napoleon is a villain and the enemy of the human race."

He now desired to see Germany reconstituted as a nation, in a union which should be at once strong for purposes of defence and founded on constitutional principles. His statesmanlike projects were foiled, partly by the short-sightedness of German

rulers and statesmen, but also by the craft whereby the Austrian statesman Metternich (*q.v.*) gained the alliance of the rulers of south and central Germany for his empire, on the understanding that they were to retain their old governing power unimpaired. Thus it was in vain that Stein, during the congress of Vienna, pressed for an effective union of the German people. Austria and the secondary German states resisted all proposals in this direction; and Stein blamed the Prussian chancellor Hardenberg for betraying an indefiniteness of purpose which probably resulted from the same unfortunate defect in Frederick William of Prussia. Stein shared in the desire of all Prussian statesmen at that time to have Saxony wholly absorbed in their kingdom. In that, as in other matters, he was doomed to disappointment. On the 24th of May 1815 he sent to his patron, the emperor Alexander, a detailed criticism of the federal arrangements proposed for Germany, showing that they fulfilled not one of the requirements for real union and constitutional government which had been so loudly demanded by the German people during the struggle of 1813.

The remainder of Stein's career must be briefly dismissed. He passed into retirement after the congress of Vienna, and saw with pain and disgust the postponement of the representative system of government which Frederick William had promised to Prussia in May 1815. He refused to act as Prussian representative at the Frankfort diet, which he regarded as a mere travesty of the central federal institution which he had hoped to see. By indirect means he did what he could to check the violence of political reaction, but he was conscious of his weakness, and that fact embittered the later days of a man who was intensely proud and self-assertive. His chief interest was in the study of history, and in 1818-1820 he worked hard to establish the society for the encouragement of historical research and the publication of the *Monumenta Germaniae historica*, of which his future biographer, Pertz, became the director. Stein died on the 29th of June 1831. He left three daughters.

In some respects there has been a tendency to magnify the achievements of Stein. As usually happens with men of great force of character, the work of less noteworthy individuals is ascribed to the one commanding personality. This was so even during the fourteen months of phenomenal activity, October 1807 to December 1808. More painstaking research has shown that the credit for originating many of the far-reaching reforms then promulgated must be shared with Heinrich Theodor von Schön and many others.¹ It is now recognized that the king himself at that time rendered unsuspectedly large services to the cause of reform. A popular legend named him as the founder of the Tugendbund, an institution which he always distrusted. But when this is granted, it still remains true that Stein's enlightenment, insight into the needs of the time, and almost superhuman energy, imparted to the reform movement a momentum which ensured its triumph at the most critical period which Prussia or any great European state passed through in the 19th century. All his contemporaries were impressed, or even awed by the determination and intellectual power of this remarkable man. His conversation had the effect of calling out all the powers of his interlocutors. "A conversation with him (wrote Varnhagen von Ense) was a continual contest, a continual danger." This mental pugnacity sometimes degenerated into rudeness; and on several occasions his impetuosity led him to take false steps. Still, when we take into consideration the magnitude of his achievements; when we recollect that in 1808 he intended his municipal reform to serve as the foundation for free institutions for the Prussian provinces, and thereafter for the whole kingdom; when we realize the grandeur of his schemes in 1813-1815 for the union of the German people in a federal

¹ Thus Schön's memorandum on the abolition of serfdom was the basis of the law of emancipation; and Stein's *Politisches Testament* was also based on a draft by Schön. Schön was born in 1773, entered the Prussian civil service in 1793, and subsequently held various high ministerial appointments. He was made castellan (*Burggraf*) of Marienburg on his retirement in 1842, and died in 1856. The share claimed by him in Stein's reforms has been the subject of some controversy.

system which would combine strength with political liberty—we shall find it difficult to overrate the importance of his contribution to the solution of the most complex political problem of modern times.

The chief authority on Stein is the biography by G. H. Pertz (6 vols., 1849–1855), but few English readers will find the need of going beyond the admirable *Life of Stein*, by Sir John Seeley (3 vols., Cambridge, 1878), which contains a full bibliography. These works are corrected at a few points by Max Lehmann's *Leben Steins* (Leipzig, 1902–1903). For side-lights on his career and character, see H. F. K., Baron vom Stein, *Lebenserinnerungen* (Hagen, 1901); C. T. Perthes, *Politische Zustände und Personen in Deutschland zur Zeit der französischen Herrschaft* (2 vols., Gotha, 1862); *Denkwürdigkeiten des Staatskanzlers Fürsten von Hardenberg*, ed. by L. von Ranke (5 vols., Leipzig, 1877); Varnhagen von Ense, *Denkwürdigkeiten* (6 vols., Mannheim, 1837–1842; English ed., London, 1847); A. Stern, *Abhandlungen und Aktenstücke aus der preussischen Reformzeit 1807–1815* (Leipzig, 1885); M. Philippson, *Geschichte des preussischen Staatswesens 1786–1813* (2 vols., Leipzig, 1880); M. Lehmann, *Knesbeck und Schön* (Leipzig, 1875); J. P. Hassel, *Geschichte der preussischen Politik, 1807–1815* (Leipzig, 1881); the Vicomte Jean d'Ussel, *Études sur l'année 1813; la défection de la Prusse* (Paris, 1907). (J. H. L. R.)

STEINER, JAKOB (1796–1863), Swiss mathematician, was born on the 18th of March 1796 at the village of Utzendorf (canton Bern). At eighteen he became a pupil of Heinrich Pestalozzi, and afterwards studied at Heidelberg. Thence he went to Berlin, earning a livelihood there, as in Heidelberg, by giving private lessons. Here he became acquainted with A. L. Crellé, who, encouraged by his ability and by that of N. H. Abel, then also staying at Berlin, founded his famous *Journal* (1826). After Steiner's publication (1832) of his *Systematische Entwicklungen* he received, through Jacobi's exertions, who was then professor at Königsberg, an honorary degree of that university; and through the influence of G. J. Jacobi and of the brothers Alexander and Wilhelm von Humboldt a new chair of geometry was founded for him at Berlin (1834). This he occupied till his death, which took place in Bern on the 1st of April 1863.

Steiner's mathematical work was confined to geometry. This he treated synthetically, to the total exclusion of analysis, which he hated, and he is said to have considered it a disgrace to synthetical geometry if equal or higher results were obtained by analytical methods. In his own field he surpassed all his contemporaries. His investigations are distinguished by their great generality, by the fertility of his resources, and by such a rigour in his proofs that he has been considered the greatest geometrical genius since the time of Apollonius.

In his *Systematische Entwicklung der Abhängigkeit geometrischer Gestalten von einander* he laid the foundation of modern synthetic geometry. He introduces what are now called the geometrical forms (the row, flat pencil, &c.), and establishes between their elements a one-one correspondence, or, as he calls it, makes them projective. He next gives by aid of these projective rows and pencils a new generation of conics and ruled quadric surfaces, "which leads quicker and more directly than former methods into the inner nature of conics and reveals to us the organic connexion of their innumerable properties and mysteries." In this work also, of which unfortunately only one volume appeared instead of the projected five, we see for the first time the principle of duality introduced from the very beginning as an immediate outflow of the most fundamental properties of the plane, the line and the point.

In a second little volume, *Die geometrischen Constructionen ausgeführt mittelst der geraden Linie und eines festen Kreises* (1833), republished in 1895 by Ottingen, he shows, what had been already suggested by J. V. Poncelet, how all problems of the second order can be solved by aid of the straight-edge alone without the use of compasses, as soon as one circle is given on the drawing-paper. He also wrote *Vorlesungen über synthetische Geometrie*, published posthumously at Leipzig by C. F. Geiser and H. Schroeter in 1867; a third edition by R. Sturm was published in 1887–1898.

The rest of Steiner's writings are found in numerous papers mostly published in *Crellé's Journal*, the first volume of which contains his first four papers. The most important are those relating to algebraical curves and surfaces, especially the short paper *Allgemeine Eigenschaften algebraischer Curven*. This contains only results, and there is no indication of the method by which they were obtained, so that, according to L. O. Hesse, "they are, like P. Fermat's theorems, riddles to the present and future generations." Eminent analysts succeeded in proving some of the theorems, but it was reserved to L. Cremona to prove them all, and that by a

uniform synthetic method, in his book on algebraical curves. Other important investigations relate to maxima and minima. Starting from simple elementary propositions, Steiner advances to the solution of problems which analytically require the calculus of variation, but which at the time altogether surpassed the powers of that calculus. Connected with this is the paper *Vom Krümmungsschwerpunkte ebener Curven*, which contains numerous properties of pedals and roulettes, especially of their areas.

Steiner's papers were collected and published in two volumes (*Gesammelte Werke*, 1881–1882) by the Berlin Academy.

See C. F. Geiser's pamphlet *Zur Erinnerung an J. Steiner* (Zurich, 1874).

STEINMETZ, KARL FRIEDRICH VON (1796–1877), Prussian general field-marshal, was born at Eisenach on the 27th of December 1796 and educated at the cadet school of Stolp in Pomerania from 1807 to 1811, in the midst of the misery and poverty caused by the French occupation. At the outbreak of the War of Liberation he and his elder brother made their way through the French posts to Breslau, where, in spite of their poverty, they were at once appointed to the army, the elder as ensign on probation, the younger to the substantive rank of second lieutenant. After a vain attempt to obtain a transfer to the Blücher Hussars, for which regiment he had conceived an intense boyish admiration when it was quartered at Stolp, he was ordered to report himself to York, who treated him and the other officers sent from Breslau with coldness, until young Steinmetz asked "when he was to return to the king who had sent him?" The brothers took part in the hardest fighting of the campaign of 1813, the elder being killed at Leipzig and the younger being more than once wounded. The short halt on the Rhine he utilized in improving his military and general education. In the battles in France he won the second class of the Iron Cross. After the peace he entered Paris but once, fearing to infringe upon the ten ducats that he saved monthly from his pay to send to his mother. For the same reason he held aloof from the pleasures of his more fortunate comrades. His avoidance of youthful excesses enabled him to overcome his earlier bad health and to acquire a physical vigour which he kept to the end of his long career as a soldier. His character as well as his physique was strengthened by his Spartan way of life, but his temper was naturally embittered by the circumstances which imposed this self-restraint. His poverty and want of influence were the more obvious as he was, shortly after the wars, assigned to the 2nd Foot Guards, stationed in Berlin. He rigorously devoted himself to study and to the routine duties of his profession. From 1820 to 1824 he studied with distinction at the General War Academy, and was at the end of the course appointed to the topographical section of the general staff. General von Müffling reported of him that he was arrogant and that he resented "encouragement"—which he probably regarded as patronage—but that his ability would enable him to outdistance his comrades. Steinmetz was too poor to mount himself on the small allowance granted to general staff officers, and had to remain with his regiment in consequence. But shortly after this his marriage to his cousin Julie, the daughter of Lieutenant-General K. F. F. von Steinmetz (1768–1837), not only tempered his fierce and resentful state of mind, but in a measure improved his material prospects, for his father-in-law was generous to the young couple, and his appointment as captain at the Guard Landwehr dépôt at Potsdam, near where the general lived, brought them into daily contact. His brigade commander too, General von Röder, was an excellent soldier, and Steinmetz often spoke in later days of the thorough training he received at his hands. After this from about 1830 his regimental work and his promotion went on without incident for several years in various garrisons, until in 1839 he became major and battalion commander. In this position he had many official differences with his immediate superiors, for he urged a strenuous war training for the troops, in season and out of season, too vigorously for his more conservative comrades, but off parade his relations with all, thanks chiefly to the social gifts of his wife, were of the most pleasant character. In 1848 he was in command of a guard battalion during the disturbances in Berlin, but was not engaged, and soon found more active employment in the Danish

War. At Schleswig he so distinguished himself that Wrangel, the commander-in-chief, told him that he had "decided the battle." He distinguished himself again at Düppel, and Prince William himself decorated him with the order *pour le mérite* on parade. For his campaign journals and letters see supplement to *Militär Wochenblatt* for 1878. On returning he was entrusted with the difficult command of the troops at Brandenburg during the sitting of a democratic popular convention at that place, and after this with the control of some troops that were known to be affected by the prevalent spirit of revolution. At the time of the Olmütz-Bronzell incident of 1850 he was employed as military governor of Cassel, and in 1851, becoming colonel commandant of the cadet school of Berlin, he at once set about the reformation of the prevailing system of instruction, the defects of which he had openly condemned as early as 1820. Though more than fifty years of age, he now learned Latin and English in order to be a more competent instructor. In 1854, after forty-one years of active service, he was promoted major-general. At Magdeburg, as at Berlin, his reforming zeal made him many enemies, and in October of this year he sustained a loss which almost unhinged his mind in the death of his youngest and only surviving child, a girl of twenty-six. From Magdeburg he was removed to the command of a guard brigade at Berlin (1857), and thence almost immediately to a divisional command in the I. Corps. Early in 1858 he was promoted lieutenant-general, and for the five years that he held this command he devoted himself particularly to acquiring knowledge of the cavalry arm. About 1863, learning that von Bonin, his senior by date, but his junior in age and length of service, was about to be appointed to command the I. Corps, he meditated retirement, but the authorities at the same time as they appointed Bonin made Steinmetz commander of the II. Corps, and shortly afterwards, when the crown prince of Prussia took over this post, commander of the V. Corps at Posen. Shortly after this his wife died. He was promoted general of infantry in 1864, and led the V. Corps to the war against Austria in 1866. This was the chance of his lifetime. His skilful and resolute leadership was displayed in his three battles, won on three successive days, of Nachod, Skalitz and Schweinschädel (see SEVEN WEEKS' WAR), and opened the way through the mountains in spite of the defeat of Steinmetz's rival Bonin at Trautenau. In 1867, in his loneliness, the "Lion of Nachod," as he was popularly called, contracted a second marriage with Elise von Krosigk (who after his death married Count Brühl). He was now, for the first time in his life, a fairly wealthy man, having been awarded a money grant for his brilliant services in 1866. About this time he was elected a member of the North German Confederation parliament.

At the outbreak of the war of 1870 Steinmetz was appointed to command one of the three armies assembled on the Rhine, the others being led by Prince Frederick Charles and the crown prince. It was not long before serious differences arose between Steinmetz and Prince Frederick Charles. The former, embittered by a lifelong struggle against the influences of wealth and position, and perhaps somewhat *grisé* by his successes in 1866, considered an order to clear the roads for the prince's army as an attempt to crowd a humbler comrade out of the fighting line, and various incidents added day by day to his growing resentment until at last on the field of Gravelotte (see METZ and FRANCO-GERMAN WAR for an account of these quarrels) he lost his temper and wasted his troops. After this there was no alternative but to relieve him of the command of the I. Army and to send him home as governor-general of the V. and VI. Army Corps districts. In April 1871 he was retired at his own request, but his great services were not forgotten when victory had softened animosities, and he was promoted general field-marshal, given a pension of 2000 thalers and made a member of the upper chamber. In the spirit of loyalty which had guided his whole career as a soldier he made no attempt to justify his conduct in 1870 either against the criticisms of the general staff history or against unofficial attacks. His life in retirement was quiet and happy, and he retained his bodily health to the

last. He died at Bad Landeck on the 2nd of August 1877. The 37th Fusiliers of the German army bear his name as part of their regimental title.

See supplement of *Militär Wochenblatt* (1877 and 1878).

STEINSCHNEIDER, MORITZ (1816-1907), Jewish bibliographer, was born in Moravia in 1816. He was the most accomplished bibliographer in the realm of Hebrew literature. His greatest work was his Catalogue of the Hebrew Collection of the Bodleian Library, Oxford (1852-1860). In this masterly work he settled many questions as to the locality, date and authorship of early printed books, and provided a vast mass of biographical materials. His *Jewish Literature* (published in German in Ersch and Gruber in 1850, in English in 1857, and in Hebrew in 1899) is a complete survey of its subject. Steinschneider prepared many other catalogues (Leiden, Munich, Hamburg and Berlin). He wrote much on Arabic literature, and was the author of bibliographies on a great variety of subjects. Among them may be named bibliographies of Jewish mathematicians and travellers. His most extensive work after his Bodleian Catalogue was his treatise on Hebrew translations in the middle ages (*Die hebräischen Übersetzungen des Mittelalters*, 2 vols., 1893). Much of his work appeared in his periodical *Hebräische Bibliographie* (1859-1882). He died in Berlin in 1907. (I. A.)

STEINTHAL, HEYMANN (1823-1899), German philosopher and philologist, was born at Gröbzig in Anhalt on the 16th of May 1823. He read philosophy and philology at the university of Berlin, where he graduated in 1850. From 1852 to 1855 he studied Chinese (language and literature) in Paris, and in 1863 became extraordinary professor of philology at Berlin. In his philosophic theories he sympathized with Moritz Lazarus, in conjunction with whom he founded in 1859 the *Zeitschrift für Völkerpsychologie und Sprachwissenschaft*. Like Lazarus and the Herbartian school in general, he attached supreme value to psychology, and especially to the psychology of society, the study of which, combined with comparative philology, alone could give trustworthy results. In philology he was an admirer and disciple of Wilhelm von Humboldt, on whose methods he wrote several books.

His principal works are *Der Ursprung der Sprache im Zusammenhang mit den letzten Fragen alles Wissens* (1851; 4th ed., 1888); *Klassifikation der Sprachen* (1850); *Charakteristik der hauptsächlichsten Typen des Sprachbaues* (1860); *Die Entwicklung der Schrift* (1852); *Grammatik, Logik, Psychologie, ihre Prinzipien, &c.* (1885); *Geschichte der Sprachwissenschaft bei den Griechen und Römern* (1863; 2nd ed., 1889-1891); *Die Mande-Negersprachen, psychologisch und phonetisch betrachtet* (1867); *Abriß der Sprachwissenschaft* (2nd ed., 1881); *Allgemeine Ethik* (1880); *Zu Bibel und Religionsphilosophie* (1890 and 1895). His books on von Humboldt appeared in 1848, 1864 and 1867, and in 1884 he published an edition of his works.

STELE, the Greek name (*στήλη*) for a pillar or vertical slab of stone or marble, sometimes decorated with bas-reliefs and bearing inscriptions, and generally terminated with a cresting (*ἐπιθήμα*) enriched with the anthemion plant. In later times the stele was crowned with a small pediment. The Way of the Tombs at Athens was lined with stelae, some of them in memory of prominent citizens.

STELLENBOSCH, a town of the Cape province, South Africa, 31 m. by rail E. of Cape Town. Pop. (1904), 7573, of whom 2497 were whites. It lies 360 ft. above the sea in a pleasant upland valley on the Atlantic slope of the coast range, and is, next to the capital, the oldest settlement in the province, having been founded by order of Commandant Simon van der Stell in 1681 and named after him and his wife, whose maiden name was Bosch. The streets are lined with magnificent oaks, while many of the houses with heavy, thatched gables date from the 17th century. Stellenbosch is the headquarters of the Cape branch of the Dutch Reformed Church, and is also an important educational centre. The chief buildings, besides the churches, are the Dutch theological seminary, Victoria College, Bloemhof girls' school, agricultural college and school of mines, laboratory and school of science and the S.A. conservatorium of music. The surrounding district is largely devoted to viticulture and

fruit-growing. The vineyards have been replanted with American stocks. The Stellenbosch valley is closed in by ranges of hills beyond which, eastward, lies Frenchhoek valley, with a village of the same name. This district was the headquarters of the Huguenot refugees who settled in South Africa at the close of the 17th century.

In the early days of the Boer War (1899-1902) Stellenbosch was one of the British military bases, and was used as a "remount" camp; and in consequence of officers who had not distinguished themselves at the front being sent back to it, the expression "to be Stellenbosched" came into use; so much so, that in similar cases officers were spoken of as "Stellenbosched" even if they were sent to some other place. The remount dépôt is maintained; horses and mules thrive here.

STEM (O. Eng. *stæfn*, *stemn*, cf. Du. *stam*, Ger. *Stamm*, &c., probably related to "staff"), in popular language the stalk of a plant, the trunk of a tree (for the technical use of the term in botany see below). There are many transferred uses of the word, such as for the slender structure which joins the foot or base of a vase or goblet to the bowl, a stock or branch of a family, or, in philology, a derivative from a root, the unchanged part in a series of inflected forms. The stem of a ship is the prow, properly a curved piece of timber or metal to which the two sides are attached at its foremost end. This was a Scandinavian use early adopted in English; the word meant simply post, and custom alone restricted it to the bows rather than to the stern; in Danish the distinction is made between *fram stam* and *bak stam* and also in German, *Vorder-steven* *Hinter-steven*.

In botany a stem may be defined as an axis bearing leaves. The stem with its leaves is known as the shoot. Structurally it differs from a root in having no development of cells forming a cap over the growing-point. Under the term *caulome* (stem-structure) are included all those parts of a plant morphologically equivalent in bearing leaves. The stem generally ascends, seeking air and light, and has therefore been termed the *ascending axis*. Stems have usually considerable firmness and solidity, but sometimes they are weak, and either lie prostrate on the ground, thus becoming *procumbent*, or climb on plants and rocks by means of rootlets, like the ivy, being then called *scandent*, or twist round other plants in a spiral manner like woodbine, when they are *twining*. Twining plants turn either from right



FIG. 1.—Orchid with pseudobulbs, *p*.

to left, as the French bean, convolvulus, dodder and gourd; or from left to right, as honeysuckle, twining polygonum, hop and black bryony (*Tamus*). In other cases climbing plants are supported by tendrils, as in vine, bryony, passion-flower, or by the tendril-like leaf-stalks, as in clematis and *Tropaeolum*. In warm climates twining plants (*Vianas*) often form thick woody stems, while in temperate regions they are generally herbaceous. Some stems are developed more in diameter than in height, and present a peculiar shortened and thickened aspect, as *Testudinaria* or tortoise-plant, cyclamen, *Melocactus*, *Echinocactus* and other Cactaceae; while in many orchids (fig. 1) the stem assumes an oval or rounded form, and is called a *pseudobulb*.

Names are given to plants according to the nature and duration of their stems. *Herbs*, or *herbaceous* plants, have stems which die down annually. In some of them the whole plant perishes after flowering; in others, the lower part of the stem forming the *crown of the root* remains, bearing buds from which the stem arises next season. In *biennial* herbs the whole plant perishes after two years, while in *perennial* herbs the crown is capable of producing stems for many years, or new annual products are repeatedly added many times, if not indefinitely, to the old stems. The short permanent stem of herbaceous plants is covered partially or completely by the soil, so as to protect the buds. Plants producing permanent woody stems are called *trees* and *shrubs*. The latter produce branches from or near the ground; while the former have conspicuous trunks. Shrubby

plants of small stature are called *under-shrubs* or *bushes*. The limits between these different kinds of stem are not always well defined; and there are some plants occupying an intermediate position between shrubs and trees, to which the name of *arborescent* shrubs is occasionally given.

The stem is not always conspicuous. Plants with a distinct stem are *caulescent*; those in which it is inconspicuous are *acaulescent*, as the primrose, cowslip and dandelion. A similar term is given in ordinary language to plants whose stems are buried in the soil, such as cyclamen or sowbread. Some plants are truly stemless, and consist only of expansions of cellular tissue representing stem and leaf, called a *thallus*, and hence are denominated *Thallogens*, or *Thallophytes*.

The first rudiment of the young shoot of the embryo appears from the seed after the radicle (young root) has protruded. It is termed the *plumule* (fig. 2), and differs from the radicle in the absence of a root-cap and in its tendency to ascend. The apical growing portion constitutes the terminal bud of the plant, and by its development the stem increases in height; projections appear at regular intervals, which are the rudimentary leaves, and in addition there is a provision for the production of lateral buds, which develop into lateral shoots more or less resembling the parent stem, and by these the branching of the plant is determined (fig. 3). These buds are found in the *axil* of previously-formed leaves; or, in other words, in the angle formed between the stem and leaf. They are hence called *axillary*. They are produced like the leaves from the outer portion of the stem (exogenous), and at first consist entirely of cellular tissue, but in the progress of growth vascular bundles are formed in them continuous with those of the stem, and ultimately branches are produced, which in every respect resemble the axis whence the buds first sprang. In the Lycopods branching takes place by forking of the growing-point, the main axis being thus replaced by two equivalent axes (fig. 4); in most cases the new axes develop unequally, the weaker becoming pushed aside and appearing later as a lateral branch of the stronger. The place of origin of the leaf is called a *node*; the intervals between nodes are called *internodes*. The stem, although it has a tendency to rise upwards when first developed, in many instances becomes prostrate, and either lies along the ground partially covered by the soil, or runs completely underneath its surface, giving off roots from one side and buds from the other. Some stems are therefore subterranean, and are distinguished from roots by the provision made for regular leaf-buds.

Growth in length of the stem is due to elongation of the internodes; the zone of most rapid growth is at some distance below the apex; below this the rate of growth gradually diminishes until the portion is reached where growth in length no longer takes place. In some cases, as in the stems of grasses, growth in length persists for a longer time in a small region at the base of the internodes; this is known as *intercalary* growth. In the dwarf or short shoots, such as those of the larch, the internodes do not elongate and the leaves remain close together. Lateral buds give rise to *branches*, from which others, called *branchlets* or *twigs*, arise. The terminal bud, after producing leaves, sometimes dies at the end of one season, and the whole plant, as in annuals, perishes; or part of the axis is persistent, and remains for two or more years, each of the leaves before its decay producing a bud in its axil. This bud

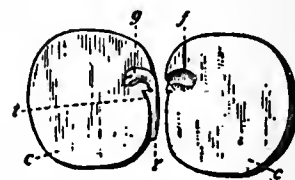
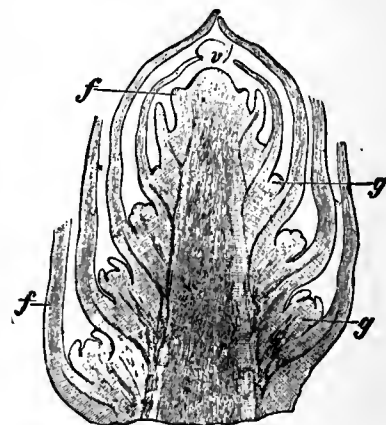

FIG. 2.—The Embryo of the Pea laid open.

c, c, The two fleshy cotyledons, or seed-lobes, which remain underground when the plant sprouts.

r, The young root or radicle.

t, The axis bearing the young shoot or plumule, *g*, which lies in a depression of the cotyledons, *f*.



(From Strasburger's *Lehrbuch der Botanik*, by permission of Gustav Fischer.)

FIG. 3.—Apex of a shoot of a phanerogamic plant. (X10.)

v, Extreme apex, so-called vegetative cone.

f, Leaf rudiment.

g, Rudiment of an axillary bud.

Some stems are therefore subterranean, and are distinguished from roots by the provision made for regular leaf-buds.

Growth in length of the stem is due to elongation of the internodes; the zone of most rapid growth is at some distance below the apex; below this the rate of growth gradually diminishes until the portion is reached where growth in length no longer takes place. In some cases, as in the stems of grasses, growth in length persists for a longer time in a small region at the base of the internodes; this is known as *intercalary* growth. In the dwarf or short shoots, such as those of the larch, the internodes do not elongate and the leaves remain close together. Lateral buds give rise to *branches*, from which others, called *branchlets* or *twigs*, arise. The terminal bud, after producing leaves, sometimes dies at the end of one season, and the whole plant, as in annuals, perishes; or part of the axis is persistent, and remains for two or more years, each of the leaves before its decay producing a bud in its axil. This bud

continues the growth in spring. In ordinary trees, in which there is provision made for the formation of numerous lateral buds, any injury done to a few branches is easily repaired; but in palms, which only form terminal buds, and have no provision for a lateral formation of them, an injury inflicted on the terminal bud is more likely to have a prejudicial effect on the future plant. In the trees of temperate and cold climates the buds which are developed during one season lie dormant during the winter, ready to burst out under the genial warmth of spring. They are generally protected by external modified leaves in the form of scales, which frequently exhibit a firmer and coarser texture than the leaves themselves. They serve a temporary purpose, and usually fall off sooner or later, after the leaves are expanded. The bud is often protected by a coating of resinous matter, as in the horse-chestnut and balsam poplar, or by a thick downy covering, as in the willow. Linnaeus called leaf-buds *hibernacula*, or the *winter quarters* of the young branch. In some plants, as in the plane, the buds destined to live through the winter are so completely surrounded

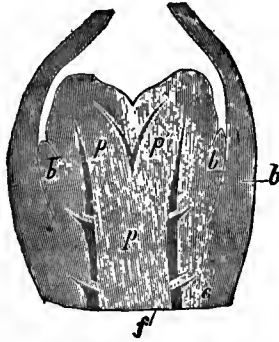

(From Strasburger's *Lehrbuch der Botanik*, by permission of Gustav Fischer.)

FIG. 4.—Longitudinal section of a bifurcating shoot (*p*) of *Lycopodium alpinum*, showing equal development of the rudimentary shoots, *p'*, *p''*. *b*, Leaf rudiments; *c*, Cortex; *f*, Vascular strands. (X 60.)

by the base of the petiole as not to be visible until the leaf has fallen off. These are said to be *intrapetiolar*.

In the bud of a common tree, as the sycamore (fig. 5), there is seen the cicatrix or scar left by the leaf of the previous year *c*, then the



FIG. 5.—Leaf-bud of Sycamore (*Acer Pseudo-platanus*) covered with scales.

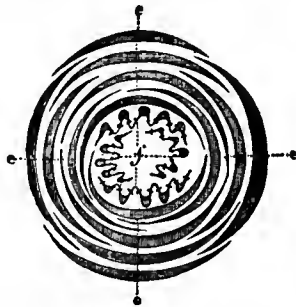

FIG. 6.—Transverse section of the same leaf-bud, with scales.

scales *e, e*, arranged in alternate pairs and overlying each other in what is called an *imbricated* manner. On making a transverse section of the bud (fig. 6), the overlying scales *e, e, e, e*, are distinctly seen surrounding the leaves *f*, which are plaited or folded round the axis or growing-point. In plants of warm climates the buds are often formed by the ordinary leaves without any protecting appendages; such buds are called *naked*. A bud may be removed in a young state from one plant and grafted upon another by the process of *budding*, so as to continue to form its different parts; and it may even be made to grow in the soil, in some instances, immediately after removal. In some trees of warm climates, as papawtree, palms and tree-ferns, growth by terminal buds is well seen. In these plants the elongation of the stem is generally regular and uniform, so that the age of the plant may be estimated by its height; as there is no great increase in the leaf area owing to absence of branching, there is no need for a great increase in the diameter of the stem.

Although provision is made for the regular formation of buds, there are often great irregularities in consequence of many being abortive or remaining in a dormant state. Such buds are called *latent*, and are capable of being developed in cases where the terminal bud, or any of the branches, have been injured or destroyed. In some instances, as in firs, the latent buds follow a regular system of alternation; and in plants with opposite leaves it frequently happens that the bud in the axil of one of the leaves only is developed, and the different buds so produced are situated alternately on opposite sides of the stem. Occasionally, after a partial development as branches, buds are arrested and form knots or nodules. The so-called embryo buds or woody nodules in the bark of the beech, elm, olive and other trees are of this nature. They are partially developed buds, in which the woody matter is pressed upon by the surrounding tissue, and thus acquires a very hard and firm texture. When a section is made, they present woody circles arranged around a central pith, and traversed by medullary rays. The nodules sometimes form *knots* on the surface of the stem, at

other times they appear as large *excrescences*, and in some cases twigs and leaves are produced by them.

When the terminal bud is injured or arrested in its growth the elongation of the main axis stops, and the lateral branches often acquire increased activity. By continually cutting off the terminal buds a woody plant is made to assume a bushy appearance, and thus *pollard* trees are produced. Pruning has the effect of checking the growth of terminal shoots, and of causing lateral ones to push forth. The peculiar bird-nest appearance often presented by the branches of the common birch depends on an arrestment in the terminal buds, a shortening of the internodes, and a consequent clustering or fasciculation of the twigs. In some plants there is a natural arrestment of the main axis after a certain time, giving rise to peculiar shortened stems. Thus the crown of the root is a stem of this nature, forming buds and roots. Such is also the case in the stem of cyclamen, *Testudinaria*, and in the tuber of the potato. The production of lateral in place of terminal buds sometimes gives the stem a remarkable zigzag aspect.

The mode in which branches come off from the stems gives rise to various forms of trees, as pyramidal, spreading or weeping—the angles being more or less acute or obtuse. In the Italian poplar and cypress the branches are erect, forming acute angles with the upper part of the stem; in the oak and cedar they are spreading or patent, forming nearly a right angle; in the weeping ash and elm they come off at an obtuse angle; while in the weeping willow and birch they are pendulous from their flexibility. The comparative length of the upper and under branches also gives rise to differences in the contour of trees, as seen in the conical form of spruce, and the umbrella-like form of the Italian or Stone pine (*Pinus Pinea*). The branching of some trees is peculiar. In the Amazon district many Myristicaceae and Monimiaceae have whorled branches coming off in fives. This is also seen in the Chili pine.

Branches are sometimes long and slender, and run along the ground, producing buds with roots and leaves at their extremity. This is seen in the *runner* (*flagellum*) of the strawberry. In the house-leek (*Sempervivum*) there is a similar prostrate branch of a shorter and thicker nature, known as an *offset*, producing a bud at its extremity capable of independent existence. In many instances the branch decays, and the young plant assumes a separate existence. Gardeners propagate plants by the process of *layering*, which consists in bending a twig, fixing the central part of it into the ground, and, after the production of roots, cutting off its connexion with the parent. A *stolon* differs from these in being a branch which curves towards the ground, and, on reaching a moist spot, takes root and forms an upright stem, and ultimately a separate plant. This is a sort of natural layering, and the plant producing such branches is called *stoloniferous*. In the rose and mint a subterranean branch arises from the stem, which runs horizontally to a certain extent, and ultimately sends up an aerial stem, which becomes an independent plant. Such branches are denominated *suckers*, and the gardener divides the connexion between the sucker and the parent stem, in order to propagate these plants. In the case of asparagus and other plants which have a perennial stem below ground, subterranean buds are annually produced which appear above ground as shoots or branches covered with scales at first, and ultimately with true leaves. These branches are herbaceous and perish annually, while the true stem remains below ground ready to send up fresh shoots next season. In bananas and plantains the apparent aerial stem is a shoot sent up by an underground stem, and perishes after ripening fruit. Branches are sometimes arrested in their development, and, in place of forming leaves, become transformed into *spines* or *thorns*, as in the hawthorn. Plants which have spines in a wild state, as the apple and pear, often lose them when cultivated, in consequence of their being changed into branches; in some cases, as in the sloe (*Prunus spinosa*) (fig. 7), a branch bears leaves at its lower portion, and terminates in a spine. In some climbing plants some of the shoots are transformed into tendrils, which help the plant to climb by twining about a support, as in passion-flower and vine; or, as in *Ampelopsis Veitchii*, by forming adhesive disks at the tips of their branchlets which enable them to cling to flat supports. In some cases branches become flat and leaf-like, taking the place in the plant economy of the leaves, which are reduced to small scales or spines, as in butcher's broom; branches showing this modification are termed cladodes or phylloclades (fig. 8). In Cactaceae (e.g. *Opuntia*, prickly pear, fig. 9) and fleshy euphorbias, where the leaves are reduced to spines, the fleshy stems become green and perform the functions of leaves; they also serve as water reservoirs for the plants, which are natives of very dry countries.

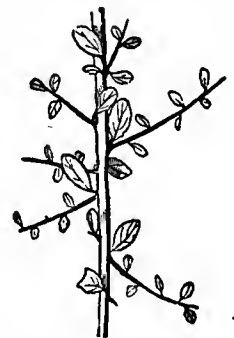

FIG. 7.—Branch of the Sloe (*Prunus spinosa*) producing spines or thorns, which are abortive branches, as shown by their bearing leaves.

Buds sometimes become extra-axillary in consequence of the non-appearance or abortion of one or more leaves, or on account of the



FIG. 8.—Twig of Butcher's Broom (*Ruscus aculeatus*)' slightly enlarged, showing cladodes, *c*.

adhesion of the young branch to the parent stem. In place of one bud there are occasionally several accessory ones produced in the axil, giving origin to numerous branches. By the union of several such buds branches are produced having a thickened or flattened appearance, as is seen in the fir, ash and other trees. In some cases, however, these *fasciated* branches are owing to the abnormal development of a single bud.

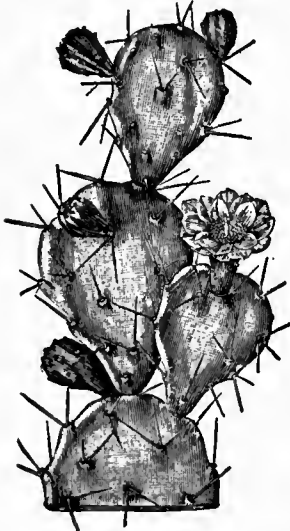

(From Strasburger's *Lehrbuch der Botanik*, by permission of Gustav Fischer.)

FIG. 9.—*Opuntia monacantha*, showing flower and fruit. The leaves are reduced to thorns. ($\frac{1}{2}$ nat. size.)

The typical form of stems is rounded. They are sometimes compressed or flattened laterally (fig. 9), while at other times they are angular. Various terms are applied to the forms of stems, as *cylindrical* or *terete*, *quadrangular* or *square*, *jointed* or *articulated*, &c. The following are some of the more important modifications of stems: The *crown of the root* is a shortened stem, often partially underground, which remains in some plants after the leaves, branches and flower-stalks have withered. In this case the internodes are very short, and the nodes are crowded together, so that the plant appears to be stemless. It is seen in perennial plants, the leaves of which die down to the ground annually. A *rhizome* or *root-stock* (fig. 10) is a horizontal stem usually sending out numerous roots and leaf-buds from its upper surface. It occurs in ferns, iris, *Hedychium*, *Acorus* or sweet flag, ginger, waterlily, many species of

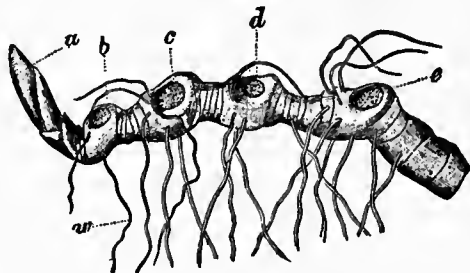

FIG. 10.—Rhizome of *Polygonatum multiflorum* (Solomon's Seal), forming buds and adventitious roots. *a*, bud which will form the aerial shoot next season; *b, c, d, e*, scars of successive aerial shoots; *w*, root.

Carex, rushes, anemone, &c. The leaves are reduced to scales and by their presence, and the absence of a root-cap, a rhizome can be

distinguished from a root. A rhizome such as occurs in Solomon's seal (fig. 10) is not a single stem, *i.e.* the product of a single bud, but is composed of portions of successive axes, the aerial parts of which have died off, leaving their scars (fig. 10, *b, c, d, e*). Rhizomes are well seen in British ferns. A rhizome sometimes assumes an erect form, as in *Scabiosa succisa*, in which the so-called *praemorse* root is in reality a rhizome, with the lower end decaying. The erect rhizome of *Cicuta virosa* (water-hemlock) shows hollow internodes, separated by partitions. In the coral-root orchid *Corallorhiza*, which grows in soil rich in humus, no roots are developed, the coral-like branching rhizome acting as the absorbing organ (fig. 13). A *pseudobulb* (fig. 1) is an enlarged bulbous-like aerial stem, common in epiphytic orchids; it is covered with a thick epidermis and acts as a water-store for the plant, which from its growth on branches of trees and in similar positions is often unable to get sufficient water for its immediate needs. A *sobole* is a creeping underground stem, sending roots from one part and leaf-buds from another, as in couch-grass, *Carex arenaria*, and *Scirpus lacustris*. It is often called a creeping root, but is really a rhizome with narrow elongated internodes. A *tuber* is a thickened stem or branch produced by the approximation of the nodes and the swelling of the internodes, as in the potato. The eyes of the potato are leaf-buds. Tubers are sometimes aerial, occupying the place of branches. The ordinary herbaceous stem of the potato, when cut into slips and planted, sends off branches from its base, which assume the form of tubers. Tubers frequently store up a quantity of starch, as in *Maranta arundinacea*, whence arrowroot is derived. Another form of thickened underground stem is the *corm*, as seen in the autumn crocus (*Colchicum*, fig. 11), gladiolus, &c. Structurally it is composed of a solid more or less rounded axis covered by a layer of thin membranous scales (fig. 12, *h, h*). A corm is only of one year's duration, giving off buds annually in



FIG. 11.—Corm of Meadow Saffron or Autumn Crocus (*Colchicum autumnale*). *a*, Old corm shrivelling. *b*, Young corm produced laterally from the old one.

the form of young corms. In autumn the young corm gives origin to leaves, the lower of which (*s, s', s''*) form sheaths round the corm and flower stalk, the upper (*l', l''*) remaining very small; and in the axil of the uppermost leaves the flowering-stem develops and bears the flowers (*b, b'*). Meanwhile in the axil of one of the middle leaves on the corm, a bud—the rudiment of a new corm—appears (*k''*). The flowering-stem dies down, and the young corm *k'* from which it arose enlarges greatly during the winter at the expense of its parent corm (*k*), which thus becomes shrivelled. In spring the leaves produced on it (*l', l''*), which were merely rudiments in autumn, appear above ground as conspicuous large leaves. At the end of spring these leaves die down, the bases of the lower ones

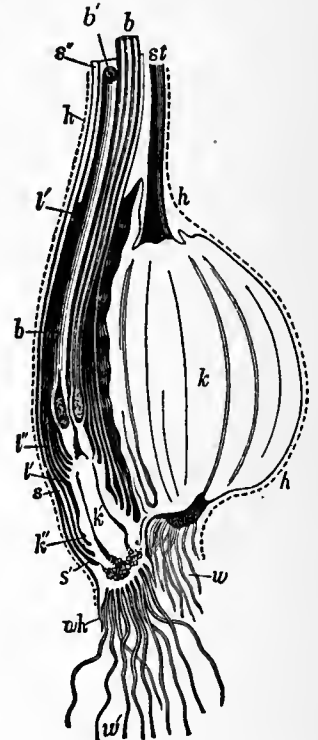

(After Sachs.)

FIG. 12.—Corms of *Colchicum autumnale* in autumn when the plant is in flower.

- k*, Oldest corm.
- h, h'*, Brown scales covering it.
- w*, Its roots.
- st*, Its withered flowering stem.
- k'*, Younger corm produced from *k*.
- w'*, Roots from *k'*, which grows at expense of *k*.
- s, s', s''*, Sheathing leaves.
- l', l''*, Foliage leaves.
- b, b'*, Flowers.
- b''*, Young corm produced from *k'* in autumn, which in succeeding autumn will produce flowers.

alone remaining, and constituting thin brown scales around the corm (as at *h*). Meanwhile, the young bud-corm (*k''*) in the axil of the middle leaf grows rapidly at the expense of its parent corm (*k'*), but it does not attain a great size. In autumn it produces new leaves, which remain small, but

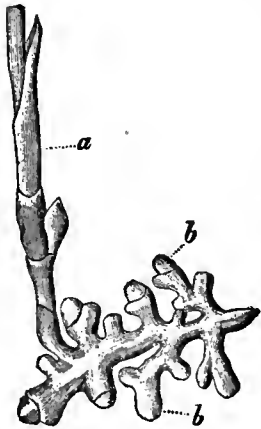

(From Strasburger's *Lehrbuch der Botanik* by permission of Gustav Fischer.)

FIG. 13.—Rhizome of *Corallorhiza innata*. (Nat. size.)

a, Floral shoot.
b, Rudiments of new rhizome branches.

from the axil of the two upper the flowering stem rises up and bears flowers; whilst in the axil of one of its middle leaves a new bud-corm appears, which will the following autumn produce young leaves, flowering stem, and a new bud-corm, and thus the cycle goes on. The buds or new corms formed from the old corms may be produced either laterally, as in *Colchicum autumnale*, or terminally, as in crocus and gladiolus. The bulb is another form of underground stem or bud. The axis in this case is much shortened, and the internodes are hardly developed. The bases of the leaves rising from the stem are quite close together, and become succulent and enclose the axis. In the lily the thick and narrow scales are arranged separately in rows, and the bulb is called *scaly*; while in the leek, onion, squill and tulip the scales are broad, and enclose each other in a concentric manner, the outer ones being thin and membranous, and the bulb is *tunicated*. In the axils of these fleshy scales new lateral shoots arise, forming new bulbs. The lateral buds or *cloves* sometimes remain attached to the axis, and produce flowering stems, so that apparently the same bulb continues to flower

for many years, as in the hyacinth and tulip; at other times the young bulbs are detached, and form separate plants. In the axil of the leaves of *Lilium bulbiferum*, *Dentaria bulbifera*, and some other plants, small conical or rounded bodies are produced, called *bulbils* or *bulblets* (fig. 14, *b*). They resemble bulbs in their aspect, and consist of a small number of thickened scales enclosing a growing-point. These scales are frequently united closely together, so as to form a solid mass. Bulbils are therefore transformed leaf-buds, which are easily detached, and are capable of producing young plants when placed in favourable circumstances. The scales in bulbs vary in number. In *Gagea* there is only one scale; in the tulip and *Fritillaria imperialis* they vary from two to five; while in lilies and hyacinths there are a great number of scales. In the tulip a bud is formed in the axil of an outer scale, and this gives rise to a new flowering axis, and a new bulb, at the side of which the former bulb is attached in a withered state.

Adventitious shoots are those which arise elsewhere than in the normal predetermined place, as from old stems, or roots. Such shoots are frequent on the roots of elm, poplar, plum and other fruit-trees. Occasionally adventitious buds are produced on the edges of leaves, as in *Bryophyllum calycinum* (fig. 15), *Malaxis paludosa*, and various species of *Asplenium*, and on the surface of leaves, as in *Ornithogalum thyrsoides*. These are capable of forming independent plants. Similar buds are also made to appear on the leaves of *Begonia*, *Gesnera*, *Gloxinia* and *Achimenes*, by wounding various parts of them, and placing them in moist soil; this is the method often pursued by gardeners in their propagation. The ippecacuanha plant has been propagated by means of leaves inserted in the soil. In this case the lower end of the leaf becomes thickened like a corm, and from it roots are produced, and ultimately a bud and young plant.

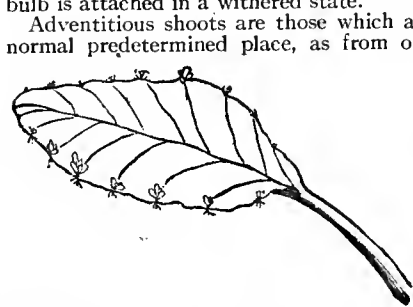

FIG. 15.—Leaf of *Bryophyllum calycinum*, producing buds along the margin, at the extremities of the primary veins.

the United Provinces. Returning to Sweden he entered the army, and in 1688 became major. He served with the Swedes in the Low Countries and on the Rhine, distinguishing himself for skill and courage at Fleurus. During the War of the Grand Alliance he was employed not only in the field but also as a confidential agent in diplomatic missions. Soon afterwards as colonel of the Dalecarlian regiment he led it in the astonishing victory of Narva. He distinguished himself still more at Dinamünde, Klissow and Cracow. In 1703 he fought the successful battle of Pultusk, and three years later, having reached the rank of general of infantry, was made governor-general of the province of Scania, which he delivered from the Danish invaders by the decisive victory of Helsingborg. He was a great favourite with Charles XII. in the earlier campaigns, but later the two drifted somewhat apart. It is recorded that the king, before whom General Lagercrona accused Stenbock of drunkenness, replied that "Stenbock drunk was more capable of giving orders than Lagercrona sober." His activities were not confined to war and diplomacy; the university of Lund was under his care for some years, and he had no mean skill as a painter and a poet. He became councillor in 1710, and Charles gave him his field marshal's bâton in 1712. In the same year he invaded Mecklenburg (with but 9000 men) in order to cover Stralsund. He won the brilliant action of Gadebusch, but numbers prevailed against him in the end. Cut off in Tönning he was forced to surrender after a gallant resistance, and passed into captivity. Five years of harsh treatment in Copenhagen brought his life to a close in 1717.

See Loenbom, *Magni Stenbocks lefverne* (1757-1765); Lilljestråle, *Magnus Stenbock* (Helsingborg, 1890).

STENCIL, a thin plate or sheet of metal, leather, paper or other material cut or pierced with a pattern or design; this is laid upon a surface and colour or ink is brushed or rubbed over it, thus leaving the ground colour of the surface imprinted with the design or pattern cut out. In ceramics the stencil is produced by coating the biscuit with a preparation which prevents the transfer-paper or enamelling from adhering to the surface at those parts where the original colour of the biscuit is to be preserved. According to Skeat (*Elym. Dict.*, 1910) the word stands for an earlier *stinsel*, and is to be derived from Old French *estinceller*, to sparkle, to powder with stars, an old term in heraldry, from Latin *scintilla*, a spark. The same French word has given the English "tinsel," strips, disks or pieces of thin glittering metallic substances used for the decoration of fabrics, hence any gaudy, showy and pretentious material or substance.

STENDAL, a town of Germany, in the province of Prussian Saxony, picturesquely situated on the Uchte, 70 m. W. of Berlin on the main line of railway to Hanover and at the junction of lines to Bremen, Magdeburg and Wittenberge. Pop. (1905), 23,281. Among the relics of its former importance are the cathedral, built in 1420-1424 (though originally founded in 1188), restored in 1893 and now housing the archaeological collection of the Altmark, the Gothic church of St Mary, founded in 1447, a "Roland column" of 1535, and two fortified gateways, dating from the 13th century. The last form the chief remains of the ancient fortifications, the site of which is now mostly occupied by promenades. A monument to the archaeologist Johann Joachim Winckelmann (1717-1768) commemorates his birth in the town. Stendal is the seat of a large railway workshop, and carries on various branches of textile industry, besides the manufacture of tobacco, machinery, stoves, gold-leaf, &c. The earliest printing-press in the Altmark was erected here, and published an edition of the *Sachsenspiegel* in 1488 as its first book.

Stendal was founded in 1151 by Albert the Bear, on the site of a Wendish settlement, and soon afterwards acquired a municipal charter. Becoming capital of the Altmark and a frequent imperial residence, it rose to a considerable degree of prosperity, in part recently restored to it by its railway connexions. When the mark was divided in 1258, Stendal became the seat of the elder or Stendal branch of the house of Ascania, which, however, became extinct in 1320. The original Wends were gradually

STENBOCK, MAGNUS GUSTAFSSON, COUNT (1664-1717), Swedish soldier, was educated at Upsala and at Paris, chose the military profession, and spent some years in the service of

fused with the later Saxons, although the Platea Slavonica, mentioned in 1475, was still distinguished as the Wenden Strasse in 1567. The population still exhibits a marked Slavonic element.

See Götze, *Urkundliche Geschichte der Stadt Stendal* (Stendal, 1873).

STENO, NICOLAUS (1631–1686), Danish naturalist, was born at Copenhagen in 1631, and studied medicine and anatomy in that city and in Paris. After a period of travel he settled in Italy (1666) at first as professor of anatomy at Padua, and then in Florence as house-physician to the grand-duke Ferdinand II. of Tuscany. He returned to his native city in 1672 to become professor of anatomy, but, having become a Roman Catholic, he found it expedient to return to Florence, and was ultimately made apostolic vicar of Lower Saxony. He died at Schwerin in Mecklenburg, on the 25th of November 1686. His fame rests on *De solido intra solidum naturaliter contento*, published at Florence in 1669. In this notable work Steno described various gems, minerals and petrifications (fossils) enclosed within solid rocks. He compared the fossil with the living organisms, and distinguished marine and fluviatile formations. He argued also in favour of the original horizontality of sedimentary deposits.

See *Di Nicola Stenone e dei suoi studii geologici in Italia*, by G. Capellini (1870); K. A. von Zittel's *History of Geology and Palaeontology* (Eng. ed., 1901); and W. J. Sollas, in *Science Progress* for Jan. 1898.

STENOGRAPHY (from Gr. *στενός*, close, narrow, and *γράφειν*, to write), the system or art of writing by signs representing single sounds or groups of sounds, single words or groups of words, sometimes also styled "brachygraphy" (Gr. *βραχύς*, short); it is a general term including all the various systems of shorthand writing (see SHORTHAND).

STENTOR, one of the Greeks before Troy (*Iliad*, v. 783), whose voice was as loud as that of fifty men. It is said that he came by his death as the result of challenging Hermes, the crier of the gods, to a contest. Possibly, like Hermes himself, Stentor is a personification of the wind. The name is used in modern times of any one possessing a particularly loud voice (stentorian).

STENTOR, a genus of heterotrichous ciliate Infusoria (*q.v.*), so named by R. Oken. It possesses a large moniliform meganucleus, accompanied by numerous micronuclei, and has a trumpet shape, when at rest, anchored by pseudopodial outgrowths from the narrow end. It is relatively large, and is much utilized to demonstrate myonemes, and had been also the object of interesting studies on regeneration, any piece, containing with a fragment of the meganucleus at least one micronucleus, regenerating the whole animal (see REGENERATION). *S. polymorphus* often inhabits a gelatinous sheath and may be green with zoochlorella; it attains a length of $\frac{1}{16}$ in. *S. caeruleus* and *igneus* are coloured blue and scarlet respectively by pigment granules in the ectosarc: E. R. Lankester made a study of the pigment of the former (blue stentorin).

STEPHAN, HEINRICH VON (1831–1897), German statesman, was born at Stolp, in Pomerania, on the 7th of January 1831. From his earliest years he showed that talent for languages to which he owed so much of his success in life, and before he went to school had acquired a considerable knowledge of Italian, Spanish and English. He was educated at the grammar school of his native town, and at the age of sixteen entered the service of the Prussian post office. His promotion was rapid; he was transferred to East Prussia, and thence to Cologne. Here he added to his salary by writing dramatic criticism, and here he obtained his first acquaintance with the system, or rather lack of system, which with its complication of charges made all international postal correspondence so expensive and uncertain—a system which he was in later years to revolutionize. After passing the examinations which admitted him to the higher branches of the service he was transferred to Frankfort-on-the-Oder, and in 1856 to Berlin. Many different stories are told of the manner in which his exceptional

knowledge of European languages was brought to the knowledge of the postmaster-general, who at once saw that capacity and attainments of the kind could best be used at headquarters. During the next few years he was entrusted with very important duties; he was chosen as Prussian representative when a postal treaty was arranged with Spain and Portugal. In 1864 he was given the task of reorganizing the postal service in the conquered duchies of Schleswig and Holstein, and in 1866 it fell to his lot to extend the Prussian system to the newly annexed provinces; he had to take over and replace the system by which for three hundred years the family of Thurn and Taxis had conducted the postal service of central Germany. He also found time to write works on the history of postal matters, viz. a *History of the Prussian Post Office* (1859), and articles on the means of communication in ancient and medieval times, which appeared in Raumer's *Historisches Taschenbuch* (1868). He was one of the invited guests at the opening of the Suez Canal, and in 1872 published a work on modern Egypt.

In 1870, at the early age of thirty-nine, Stephan was made postmaster-general of the North German confederation, and in the next year of the newly founded empire; in 1878, at the general reorganization of the imperial administration (see article GERMANY) the post office was made a separate department, and his title was altered to that of secretary of state. His great powers of organization were at once shown in the arrangement of the admirable *Feld Post*, which during the war with France maintained communication with the army in the field. In eight months 89,000,000 letters, 2,500,000 post-cards, and £10,000,000 in money passed through the department, and it was his boast that letters were delivered to and collected from the soldiers with almost unflinching regularity, sometimes even on the field of battle. In this way he began what was the great work of his life, that of making the post office in the truest sense of the word popular, and henceforth he was unremittingly occupied in devising and adopting new contrivances for the convenience and use of the people. The introduction of post-cards was his first innovation. In this he had been anticipated by Austria, but the idea was his own, and had been adopted by the Austrians in consequence of a suggestion made by him at a postal conference in 1865. The development of the parcel post and of the system of money orders was his next work, and in this he was so successful that in 1883 the German post office dealt with 79,000,000 parcels, while in all the other countries of the world together only 52,000,000 went through the post. While in this and other ways he extended the use of the post office at home, he gained a wider celebrity in being the chief promoter of the International Postal Union. He presided at the first conference, which met at Bern in 1874.

The alacrity of Stephan's intelligence and his enthusiasm for the institution over which he presided were shown by the readiness with which he applied or took over all new inventions which might be of public service, such as telegraphs, telephones and pneumatic tubes. His pride in the post office showed itself in the immediate interest which he took in the design and plan of the new offices which were erected in all parts of Germany; it was always his ambition that the post office in each town should be the most conspicuous and the handsomest of public buildings, even at the sacrifice of economy. He warmly supported Bismarck in his policy of extending and promoting national industry and foreign trade, and arranged the subsidies by which a direct postal service was established between Germany and China and Australia. His national feeling also showed itself in the support which he gave to the movement for purifying the German language of foreign words—but he did not always succeed in avoiding the exaggeration verging on the ridiculous into which this movement so easily degenerates. While he stood aloof from ordinary party politics, he was a frequent speaker in the Reichstag on the affairs of his own department, and was a member of the Bundesrat. Though never on terms of intimate friendship with Bismarck, his mastery in his own department won for him the appreciation of the chancellor, and he was allowed more independence than most

of the officials. By the power of working out broad and general principles in detail and idealizing the routine work of administration he may fairly be placed among the great administrators by whom (far more than by statesmen and politicians) the Prussian state has been built up, and he was singularly fortunate in that his life fell at a time when by perfecting the administration of the newly founded imperial post he took no small part in strengthening the national idea and binding together the German nation. In 1897 blood-poisoning, arising from a wound in the foot, made amputation of the leg necessary, and he died from the effects of the operation, on the 8th of April 1897.

See E. Knickerberg, *H. v. Stephan* (Berlin, 1897). (J. W. HE.)

STEPHANITE, a mineral consisting of silver sulphantimonite, Ag_5SbS_4 ; containing 68.5 % of silver, and sometimes of importance as an ore of this metal. Under the name *Schwarzerz* it was mentioned by G. Agricola in 1546, and it has been variously known as "black silver ore" (Ger. *Schwarzgültigerz*), brittle silver-ore (*Sprödglanzerz*), &c. The name stephanite was proposed by W. Haidinger in 1845 in honour of the archduke Stephan of Austria; French authors use F. S. Beudant's name *psaturose* (from the Greek *ψαθυρός*, fragile). It frequently occurs as well-formed crystals, which are orthorhombic and occasionally show indications of hemimorphism: they have the form of six-sided prisms or flat tables terminated by large basal planes and often modified at the edges by numerous pyramid-planes. Twinning on the prism-planes is of frequent occurrence, giving rise to pseudo-hexagonal groups like those of aragonite. The colour is iron-black, and the lustre metallic and brilliant; on exposure to light, however, the crystals soon become dull. The mineral has a hardness of $2\frac{1}{2}$ and is very brittle; the specific gravity is 6.3. Stephanite occurs with other ores of silver in metalliferous veins. Localities which have yielded good crystallized specimens are Freiberg and Gersdorf near Rosswein in Saxony, Chañarcillo in Chile, and exceptionally Cornwall. In the Comstock lode in Nevada massive stephanite and argentite are important ores of silver.

(L. J. S.)

STEPHANUS BYZANTINUS (STEPHEN OF BYZANTIUM), the author of a geographical dictionary entitled *Ἐθνικά*, of which, apart from some fragments, we possess only the meagre epitome of one Hermolaus. This work was first edited under the title *Περὶ πόλεων* (Aldus, Venice, 1502); the best modern editions are by W. Dindorf and others (4 vols., Leipzig, 1825), A. Westermann (Leipzig, 1839), and A. Meineke (vol. i., Berlin, 1849). Hermolaus dedicates his epitome to Justinian; whether the first or second emperor of that name is meant is disputed, but it seems probable that Stephanus flourished in the earlier part of the 6th century, under Justinian I. The chief fragments remaining of the original work (which certainly contained lengthy quotations from classical authors and many interesting topographical and historical details) are preserved by Constantine Porphyrogenetos, *De administrando imperio*, ch. 23 (the article *Ἰβηρία δύο*) and *De thematibus*, ii. 10 (an account of Sicily); the latter includes a passage from the comic poet Alexis on the Seven Largest Islands. Another respectable fragment, from the article *Δύμη* to the end of Δ , exists in a MS. of the Seguerian library.

See the editions of Westermann, Dindorf and Meineke, above noticed; the article "Stephanus Byzant." in Smith's *Dictionary of Ancient Biography*, vol. iii.; E. H. Bunbury, *History of Ancient Geography*, i. 102, 135, 169; ii. 669-671 (London, 1883); Riese, *De Stephani Byzanti auctoribus* (Kiel, 1873); J. Geffcken, *De Stephano Byzantio* (Göttingen, 1886); Spuridon Kontogones, *Διορθωτικά εἰς τὰ Ἐθνικά* (Erlangen, 1890); Paul Sakolowski, *Fragmenta d. S. von B.*; E. Stemplinger, *Studien zu d. Ἐθνικά*.

STEPHEN, the "proto-martyr" (as he is called in certain MSS. of Acts xxii. 20), in some senses the greatest figure in primitive Christianity prior to Paul's conversion, was one of "the Seven" (xxi. 8, nowhere called "deacons") set over the "daily ministration" towards the needy members of the Jerusalem community. But, like Philip and perhaps others of his colleagues (vi. 3), he had higher gifts than his office would suggest. We read that he was "full of faith and of the holy

Spirit"; and as his spiritual power seems to have shown itself in mighty deeds as well as words (vi. 5, 8), he became a marked man in Jerusalem. Himself a Jew of Greek culture, he naturally tried to win over his fellow Hellenists (vi. 9).

It is here that Stephen's advance upon the Apostolic teaching becomes apparent. His special "wisdom" lay in greater insight into the merely relative nature and value of the externals of Israel's religion, and particularly those connected with the Temple. His fellow Hellenists were as a body eager to disprove the feeling of the native "Hebrews" that they were only half Jews; accordingly teaching which minimized the value of the sacred "customs which Moses had delivered" (vi. 14)—by making salvation turn immediately upon faith in Jesus as Messiah—would cause deep resentment in such circles, in spite of their more liberal attitude to things non-Jewish. They may have met Stephen's appeal for faith in Jesus as Messiah by saying that full fellowship with God was theirs by observance of the Mosaic customs, centring in the Temple, which in Jerusalem overshadowed men's thoughts touching the Divine presence. To this he would reply by warning them in Jesus' own words, supported by those of the prophets, that the heart is the true seat of the Shekinah; and that if they refused God manifest in His Messiah, the final embodiment of Divine righteousness, no holy "customs"—no, not the Temple itself—could save them from the displeasure of the living God. Nay, God might have to make good Messiah's words as to His person being more essential to fellowship with God than the Temple itself (cf. Matt. xii. 6), which might even be destroyed, as it had been in the past, without loss to true religion. In all this he was but reasserting the prophetic rather than the scribal view of the Mosaic Law and its institutions, viz. that the inner spirit, that which could be written on the heart, was the only thing really essential. But they could not rise to this conception and treated his words as "blasphemous against Moses and against God," and roused "the people and the elders and the scribes" against him.

He was seized and brought before the Sanhedrin on the charge of speaking "against the Temple and the Law" (vi. 11-14). His defence against this twofold charge took the form of a survey of Israel's religious past, with a view to show: (1) that "the God of Glory" had covenant relations with their forefathers before they had either Holy Place (Land or Temple) or Law (vii. 1-17); (2) that the first form of visible meeting place between God and His people was far other than that for which absolute sanctity was now claimed. Nay, the form of "the tabernacle of testimony in the wilderness" (no Holy Land) had more divine sanction¹ than any later Temple (44-47); (3) that, after all, the presence of "the Most High" was in no way bound up with any structure of human hands, as Isaiah witnessed (48-50). The moral of all this was plain: Israel's forms of fellowship with the Most High had all along been relative and subject to change. Particularly was this so with the external forms of cultus then represented by the Temple. Hence there was no "blasphemy" in suggesting that in the Messianic age yet another change might come about, and that observance of Temple services could prove little as to acceptance with God. But there is another and more actual line of pleading. This is found in the elaborate section dealing with the person and work of Moses, the great lawgiver (17-38)—a section full of extra-biblical touches—followed by one on Israel's hardness of heart towards him and the "living oracles" he mediated, together with its result, the Exile (39-43). Pure and original Mosaism, embodied in Moses and his ministry to Israel, is represented as something which in its full spiritual intention had been frustrated by Israel's stiffneckedness (39, 42 seq.). The figure of Moses is made to stand forth in ideal outlines, the thinly-veiled Christian application shining through. "This is that Moses who said unto the children of Israel, 'A prophet

¹ The solemn language in v. 44 suggests that to Stephen, as to the writer to the Hebrews (and perhaps Hellenists generally), the Biblical Sanctuary, as corresponding to the heavenly archetype, was more sacred than the Temple of Herod, which owed what sanctity it had to the older features it still preserved.

shall God raise up unto you . . . like unto me.' This is he that was in the Church in the wilderness with the angel which spake to him in the Mount Sinai, and with our fathers; who received living oracles to give unto us: to whom our fathers would not be obedient, but thrust him from them, and turned back in their hearts. . ." (38 seq.). Here we have the very situation as between Stephen and his hearers; and it is made unmistakable by the speaker's closing words (51-53). They will have nothing to say to the greater Mediator of the Divine oracles in Messianic clearness and power. But if so, the reason is not their fidelity to the Mosaic Law, but their infidelity to its spiritual substance. Had they kept the Law dutifully they would have believed on Him in whom true Mosaism was fulfilled and transcended.

In all this there are points both of contact and divergence between Stephen and Paul. Alike they are champions of the "spirit" against the "letter"; and alike they tax unbelieving Judaism with failure to keep the Law in its real sense. But here difference begins. Quite apart from the externalism of Temple worship, to which Paul never alludes, they start from different conceptions of the Law. Stephen, the Hellenist, views it idealistically and with the spiritual freedom of the prophets and of Jesus Himself. But Paul took it more strictly (see PAUL). Thus in spite of general kinship of spirit, Stephen is not really Paul's forerunner. He has no sense of antithesis between law and grace; and he makes no reference to the Gentiles. It is rather the author of the Epistle to Hebrews (*q.v.*) who recalls Stephen. Both deal largely with the Temple and its worship; both expose the externalism of the legal rites of Judaism, as tending to spiritual unreality; and both view the Gospel as the sublimation of the Law on ideal lines. Only, the later thinker contrasts even pure Mosaism with the Gospel of Christ, as old with new, as the Covenant of shadow with that of reality.

As to the authenticity of Stephen's speech, it is generally admitted to be accurate in substance, if not in the words that he uttered. We may suppose it lived in the memory of some associate in such discussions, who would often repeat its tenor in his work as one of the preachers scattered (viii. 4, xi. 19) by the persecution which Stephen's preaching brought on the Jerusalem community, particularly on its Hellenistic section as most identified with the revolutionary aspect which faith in Jesus the Nazarene now for a time assumed in public estimation (contrast ii. 47). It would finally be committed to writing, largely because it was so representative of the Hellenistic view of the relations of Judaism and Christianity. As such it was given prominence in the book of Acts—a work which shows the greatness of the contributions to the Apostolic age not only of Paul, but also of the Hellenists, those mediators between Jews and Gentiles. Possibly also Paul had spoken in Luke's hearing of Stephen's martyrdom and his own close relations to it (vii. 58, 60, cf. vi. 9).

Stephen's actual martyrdom is described as tumultuary in character, though the legal forms of stoning for blasphemy were observed (58). This is quite consistent with a trial before the Sanhedrin; nor is it inconceivable that an act exceeding the rights of that body under the Romans should have taken place at the impulse of religious fanaticism. Our knowledge of Jewish history is not full enough to warrant denial of the historicity of this feature of the narrative simply on the score of its illegality. Neither is there good reason to assume that the hearing before the Sanhedrin is a touch added by the author of Acts to the source on which he has drawn in the main.

LITERATURE.—All requisite materials will be found in articles in the *Ency. Bib.* vol. iv., and Hauck's *Realencykl. f. protestant. Theol. u. Kirche*, vol. xix. The former in particular examines the Midrashic elements (adding to or diverging from the O. T. data) in Stephen's speech, the linguistic features of Acts vi. 1, viii. 3, and various theories as to the source or sources used therein. It also refers to the worthless legends touching Stephen's death and the finding of his relics, collected in Tillemont, *Mémoires* (Eng. ed., 1735), pp. 353-359. (J. V. B.)

STEPHEN (1097?-1154), king of England, was the third son of Stephen Henry, count of Blois and Chartres, and, through

his mother Adela, a grandson of William the Conqueror. Born some time before 1101, he was still a boy when he was taken into favour by his uncle, Henry I. of England. From Henry he received the honour of knighthood and the county of Mortain. In 1118 he severed his connexion with Blois and Chartres, renouncing his hereditary claims in favour of his elder brother Theobald. But he acquired the county of Boulogne by marrying Matilda (*c.* 1103-1152), the heiress of Count Eustace III. and a niece of Henry's first wife. The old king arranged this match after the untimely loss of his son, William Atheling, in the tragedy of the White Ship; until 1125 Stephen was regarded as the probable heir to the English throne. But the return of the widowed empress Matilda (*q.v.*) to her father's court changed the situation. Henry compelled Stephen and the rest of his barons to acknowledge the empress as their future ruler (1126). Seven years later these oaths were renewed; and in addition the ultimate claims of Matilda's infant son, Henry of Anjou, were recognized (1133). But the death of Henry I. found the empress absent from England. Stephen seized the opportunity. He hurried across the Channel and began to canvass for supporters, arguing that his oaths to Matilda were taken under coercion, and that she, as the daughter of a professed nun, was illegitimate. He was raised to the throne by the Londoners, the official baronage and the clergy; his most influential supporters were the old justiciar, Robert, bishop of Salisbury, and his own brother Henry, bishop of Winchester. Innocent II. was induced by Bishop Henry to ratify the election, and Stephen thus cleared himself from the stain of perjury. Two charters of liberties, issued in rapid succession, confirmed the King's alliance with the Church and earned the good will of the nation. But his supporters traded upon his notorious facility and the unstable nature of his power. Extortionate concessions were demanded by the great barons, and particularly by Earl Robert of Gloucester, the half-brother of the empress. The clergy insisted that neither their goods nor their persons should be subject to secular jurisdiction. Stephen endeavoured to free himself from the control of such interested supporters by creating a mercenary army and a royalist party. This led at once to a rupture between himself and Earl Robert (1138), which was the signal for sporadic rebellions. Soon afterwards the king attacked the bishops of Salisbury, Ely and Lincoln—a powerful family clique who stood at the head of the official baronage—and, not content with seizing their castles, subjected them to personal outrage and detention. The result was that the clergy, headed by his brother, the bishop of Winchester, declared against him (1139). In the midst of these difficulties he had left the western marches at the mercy of the Welsh, and the defence of the northern shires against David of Scotland had devolved upon the barons of Yorkshire. Stephen was thoroughly discredited when the empress at length appeared in England (Sept. 30, 1139). Through a misplaced sense of chivalry he declined to take an opportunity of seizing her person. She was therefore able to join her half-brother at Gloucester, to obtain recognition in the western and south-western shires, and to contest the royal title for eight years. Stephen's initial errors were aggravated by bad generalship. He showed remarkable energy in hurrying from one centre of rebellion to another; but he never ventured to attack the headquarters of the empress. In 1141 he was surprised and captured while besieging Lincoln Castle. The empress in consequence reigned for six months as "Lady (*Domina*) of the English"; save for her faults of temper the cause of Stephen would never have been retrieved. But, later in the year, his supporters were able to procure his release in exchange for the earl of Gloucester. After an obstinate siege he expelled Matilda from Oxford (Dec. 1142) and compelled her to fall back upon the west. The next five years witnessed anarchy such as England had never before experienced. England north of the Ribble and the Tyne had passed into the hands of David of Scotland and his son, Prince Henry; Ranulf earl of Chester was constructing an independent principality; on the west the raids of the Angevin party, in the east and midlands the

excesses of such rebels as Geoffrey de Mandeville, earl of Essex, turned considerable districts into wildernesses. Meanwhile Geoffrey of Anjou, the husband of the empress, completed the conquest of Normandy (1144). In 1147 the situation improved for Stephen; Robert of Gloucester, the ablest of the Angevin partisans, died, and the empress left England in despair. But her son soon appeared in England to renew the struggle (1149) and conciliate new supporters. Soon after his return to Normandy Henry was invested by his father with the duchy (1150). He succeeded to Anjou in 1151; next year he acquired the duchy of Aquitaine by marriage. Stephen struggled hard to secure the succession for Eustace, his elder son. But he had quarrelled with Rome respecting a vacancy in the see of York; the pope forbade the English bishops to consecrate Eustace (1151); and there was a general unwillingness to prolong the civil war. Worn out by incessant conflicts, the king bowed to the inevitable when Henry next appeared in England (1153). Negotiations were opened; and Stephen's last hesitations disappeared when Eustace was carried off by a sudden illness. Late in 1153 the king acknowledged Henry as his heir, only stipulating that the earldom of Surrey and his private estates should be guaranteed to his surviving son, William. The king and the duke agreed to co-operate for the repression of anarchy; but Stephen died before this work was more than begun (Oct. 1154).

On his great seal Stephen is represented as tall and robust, bearded, and of an open countenance. He was frank and generous; his occasional acts of duplicity were planned reluctantly and never carried to their logical conclusion. High spirited and proud of his dignity, he lived to repent, without being able to undo, the ruinous concessions by which he had conciliated supporters. In warfare he showed courage, but little generalship; as a statesman he failed in his dealings with the Church, which he alternately humoured and thwarted. He was a generous patron of religious foundations; and some pleasing anecdotes suggest that his personal character deserves more commendation than his record as a king.

See the *Gesta Stephani*, Richard of Hexham, Ælred of Rievaulx' *Relatio de Standardo*, and the chronicle of Robert de Torigni, all in R. Howlett's *Chronicles of the Reigns of Stephen, &c.* (4 vols., London, 1884-1889); Orderic Vitalis's *Historia ecclesiastica*, ed. Le Prévost (5 vols., Paris, 1838-1855); William of Malmesbury's *Historia novella*, ed. W. Stubbs (London, 1889); John of Worcester's *Continuation of Florence*, ed. J. H. Weaver (Oxford, 1908); the *Peterborough Chronicle*, ed. C. Plummer (1892-1899). Of modern works see Miss K. Norgate's *England under the Angevin Kings*, vol. i. (London, 1887); O. Rössler's *Kaiserin Mathilde* (Berlin, 1897); J. H. Round's *Geoffrey de Mandeville* (London, 1892); H. W. C. Davis's "The Anarchy of Stephen's Reign" in *Eng. Hist. Review* for 1903.

STEPHEN, the name of nine popes.

STEPHEN I., bishop of Rome from about 254 to 257, followed Lucius I. He withdrew from church fellowship with Cyprian and certain Asiatic bishops on account of their views as to the necessity of rebaptizing heretics (Euseb. *H. E.* vii. 5; Cypr. *Epp.* 75). He is also mentioned as having insisted on the restoration of the bishops of Merida and Astorga, who had been deposed for unfaithfulness during persecution but afterwards had repented. He is commemorated on August 2. His successor was Sixtus II.

STEPHEN II., pope from March 752 to April 757, was in deacon's orders when chosen to the vacant see within twelve days after the death of Zacharias.¹ The main difficulty of his pontificate was in connexion with the aggressive attitude of Aistulf, king of the Lombards. After unsuccessful embassies to Aistulf himself and appeals to the emperor Constantine, he, though in feeble health, set out to seek the aid of Pippin, by whom he was received in the neighbourhood of Vitry le Brulé in the beginning of 754. He spent the winter at St Denis. The result of his negotiations was the Frankish invasion of Aistulf's territory and the famous "donation" of Pippin. The death of Stephen took place not long after that of Aistulf. He was succeeded by Paul I.

¹A priest named Stephen, elected before him, died three days after, without having received the episcopal consecration.

STEPHEN III., pope from the 7th of August 768 to the 3rd of February 772, was a native of Sicily, and, having come to Rome during the pontificate of Gregory III., gradually rose to high office in the service of successive popes. On the deposition of Constantine II. Stephen was chosen to succeed him. Fragmentary records are preserved of the council (April 769) at which the degradation of Constantine was completed, certain new arrangements for papal elections made, and the practice of image-worship confirmed. Stephen inclined to the Lombard rather than to the Frankish alliance. He was succeeded by Adrian I.

STEPHEN IV., pope from June 816 to January 817, succeeded Leo III. He did not continue Leo's policy, which was more favourable to the clergy than to the lay aristocracy. Immediately after his consecration he ordered the Roman people to swear fidelity to Louis the Pious, to whom he found it prudent to betake himself personally in the following August. After the coronation of Louis at Reims in October he returned to Rome, where he died in the beginning of the following year. His successor was Paschal I.

STEPHEN V., pope from 885 to 891, succeeded Adrian III., and was in turn succeeded by Formosus. In his dealings with Constantinople in the matter of Photius, as also in his relations with the young Slavonic Church, he pursued the policy of Nicholas I. His Italian policy wavered between his desire for the protection of the German king Arnulf against Guy of Spoleto, king of Italy, and fear of offending Guy. Guy was crowned emperor in 891.

STEPHEN VI., pope from May 896 to July-August 897, succeeded Boniface VI., and was in turn followed by Romanus. His conduct towards the remains of Formosus, his last predecessor but one (see FORMOSUS) excited a tumult, which ended in his imprisonment and death by strangling.

STEPHEN VII. (January 929 to February 931) and **STEPHEN VIII.** (July 939 to October 949) were virtually nonentities, who held the pontificate while the real direction of the pontifical state was in the hands of Marozia and, afterwards, of her son Alberic, senator of the Romans.

STEPHEN IX., pope from August 1057 to March 1058, succeeded Victor II. (Gebhard of Eichstädt). His baptismal name was Frederick, and he was a younger brother of Godfrey, duke of Upper Lorraine, marquis of Tuscany (by his marriage with Beatrice, widow of Boniface, marquis of Tuscany). Frederick, who had been raised to the cardinalate by Leo IX., acted for some time as papal legate at Constantinople, and was with Leo in his unlucky expedition against the Normans. He shared his brother's fortunes, and at one time had to take refuge from Henry III. in Monte Cassino. Five days after the death of Victor II. (who had made him cardinal-priest and abbot of Monte Cassino) he was chosen to succeed him. He showed great zeal in enforcing the Hildebrandine policy as to clerical celibacy, and was planning the expulsion of the Normans from Italy and the elevation of his brother to the imperial throne when he was seized by a severe illness. He died at Florence on the 29th of March 1058.¹

STEPHEN I. [ST STEPHEN] (977-1038), king of Hungary, was the son of Geza, duke of Hungary, and of Sarolta, one of the few Magyar Christian ladies, who obtained the best teachers for her infant son. These preceptors included the German priest Bruno, the Czech priest Radla, and an Italian knight, Theodate of San Severino, who taught him arms and letters (a holograph epistle by Stephen existed in the Vatican Library as late as 1513). In 996 Stephen married Gisela, the daughter of Duke Henry II. of Bavaria, and in the following year his father died and the young prince was suddenly confronted by a formidable pagan reaction under Kupa in the districts between the Drave and Lake Balaton. Stephen hastened against the rebels, bearing before him the banner of St Martin of Tours, whom he now chose to be his patron saint, and routed the rebels at Veszprem (998), a victory from which the foundation of the Hungarian monarchy must be dated, for Stephen assumed the royal title immediately afterwards. In 1001 his envoy Asztrik

obtained Pope Silvester II.'s confirmation of this act of sovereignty. Silvester at the same time sent Stephen a consecrated crown, and approved of the erection of an independent Hungarian church, divided into the two provinces of Esztergom and Bács. But the power of pagan Hungary could not be broken in a day. The focus of the movement was the Maros region, where the rebel Ajtony built the fortress of Marosvár. The struggle proceeded for more than twenty-five years, the difficulties of Stephen being materially increased by the assistance rendered to the rebels by the Greek emperors, his neighbours since their reconquest of Bulgaria. As early as 1015 Stephen had appointed the Italian priest Gellert bishop of Maros, but he was unable to establish the missionary in his see till 1030. The necessity of christianizing his heathen kingdom by force of arms engrossed all the energies of Stephen and compelled him to adopt a pacific policy towards the emperors of the East and West. When the emperor Conrad, with the deliberate intention of subjugating Hungary, invaded it in 1030, Stephen not only drove him out, but captured Vienna (now mentioned for the first time) and compelled the emperor to cede a large portion of the Ostmark (1031). Of the five sons borne to him by Gisela, only Emerich reached manhood, and this well-educated prince was killed by a wild boar in 1031. Stephen thereupon appointed as his successor his wife's nephew Peter Orseolo, who settled in Hungary, where his intrigues and foreign ways made him extremely unpopular. Stephen died at his palace at Esztergom in 1038 and was canonized in 1083. For an account of his epoch-making reforms see HUNGARY: *History*.

See Gyula Pauler, *History of the Hungarian Nation*, vol. i. (Hung.; Pest, 1893); Lajos Balics, *History of the Roman Catholic Church in Hungary*, vol. i. (Hung.; Pest, 1885); Antal Pór, *Life of St Stephen* (Hung.; Pest, 1871); János Karácsonyi, *Documents issued by Stephen I.* (Hung.; Pest, 1892), idem, *Life of St Gellert* (Hung.; Pest, 1887); E. Horn, *St Etienne, roi apostolique de Hongrie* (Paris, 1899); W. J. Winkler de Kétrszynski, *Vita sancti Stephani* (Cracow, 1897). (R. N. B.)

STEPHEN V. (1239–1272), king of Hungary, was the eldest son of Béla IV., whom he succeeded in 1270. As crown prince he had exhibited considerable ability, but also a disquieting restlessness and violence. In 1262 he compelled his father, whom he had assisted in the Bohemian War, to surrender twenty-nine counties to him, so that Hungary was virtually divided into two kingdoms. Not content with this he subsequently seized the southern banate of Macso, which led to a fresh war between father and son in which the latter triumphed. In 1268 he undertook an expedition against the Bulgarians, conquering the land as far as Tirnova and styling himself henceforth king of Bulgaria. Stephen was a keen and circumspect politician, and for his future security contracted, during his father's lifetime, a double¹ matrimonial alliance with the Neapolitan princes of the House of Anjou, the chief partisans of the pope. He certainly needed exterior support; for on his accession to the Hungarian throne, as he himself declared, every one was his enemy. This hostility was due to the almost universal opinion of western Europe that Stephen was a semi-pagan. His father had married him while still a youth (c. 1255) to Elizabeth, daughter of the Kumanian chieftain Köteny, with a view to binding the Kumanians (who could put in the field 16,000 men; see HUNGARY: *History*) more closely to the dynasty in the then by no means improbable contingency of a second Tatar invasion. The lady was duly baptized and remained a Christian; but the adversaries of Stephen, especially Ottakar II. of Bohemia, affected to believe that Stephen was too great a friend of the Kumanians to be a true Catholic. Ottakar endeavoured, with the aid of the Magyar malcontents, to conquer the western provinces of Hungary, but after some successes was utterly routed by Stephen in 1271 near Mosony, and by the peace of Pressburg, the same year, relinquished all his conquests. Stephen died suddenly on the 6th of August

¹ Charles, the son of Charles of Anjou, was to marry Stephen's daughter Maria, while Stephen's infant son Ladislaus was to marry Charles's daughter Elizabeth. Another of his daughters, Anna, married the Greek emperor Andronicus Palaeologus.

1272, just as he was raising an army to recover his kidnapped infant son Ladislaus from the hands of his rebellious vassals.

See Ignacz Acsády, *History of the Hungarian Realm*, vol. i. (Hung.; Budapest, 1903). (R. N. B.)

STEPHEN, SIR JAMES (1789–1859), English historian, was the son of James Stephen, master in chancery, author of *The Slavery of the West India Colonies* and other works, and was born in London on the 3rd of January 1789. He was educated at Trinity Hall, Cambridge, graduating B.A. in 1812, after which he studied for the bar and was called at Lincoln's Inn. He obtained an extensive practice as a chancery barrister, being ultimately counsel to the colonial department and counsel to the board of trade. In 1834 he became assistant under-secretary for the colonies, and shortly afterwards permanent under-secretary. On his retirement in 1847 he was made a knight commander of the Bath. In 1849 he was appointed regius professor of modern history in the university of Cambridge, having already distinguished himself by his brilliant studies in ecclesiastical biography contributed to the *Edinburgh Review*, which were published that year under the title *Essays in Ecclesiastical Biography and Other Subjects*; a 4th edition, with a short memoir, appeared in 1860. He was also the author of *Lectures on the History of France* (2 vols., 1851; 3rd ed., 1857), and *Desultory and Systematic Reading*, a lecture (1853). He died at Coblenz on the 15th of September 1859.

STEPHEN, SIR JAMES FITZJAMES, BART. (1829–1894), English lawyer, judge and publicist, was born in London on the 3rd of March 1829, the third child and second son of Sir James Stephen (q.v.). Fitzjames Stephen was for three years (1842–1845) at Eton, and for two years at King's College, London. In October 1847 he entered at Trinity College, Cambridge. Notwithstanding exceptional vigour in mind and body, he did not attain any of the usual scholastic or athletic distinctions. The only studies then seriously prosecuted in the university course were mathematics and classics. Neither of these attracted him in their academical forms, nor did he care for competitive sport. But his Cambridge time was fruitful in other ways. He was already acquainted with Sir Henry Maine (q.v.), six years his senior, and then newly appointed to the chair of civil law. This acquaintance now ripened into a perfect friendship, which ended only with Maine's death in 1888. No two men's intellectual tempers ever presented a stronger contrast. As Stephen himself said, it took them a long time to know when they really agreed. Maine was subtle, swift and far-reaching; Stephen was massive, downright, indefatigable and sincere even to unnecessary frankness. Their qualities were an almost exact complement of one another, but neither of them would take opinions on trust, or acquiesce in commonplace methods of avoiding difficulties; and it might have been said of either of them without exaggeration that, if all his technical and professional requirements could be taken away, a born man of letters would be left. By Maine's introduction, Stephen became a member of the Cambridge society known as the Apostles, in form not very different from many other essay societies, in substance a body with an unformulated but most individual tradition of open-mindedness and absolute mutual tolerance in all matters of opinion. Perhaps the golden age of the society was a few years before Stephen's election, but it still contained a remarkable group of men who afterwards became eminent in such different ways as, for instance, James Clerk Maxwell and Sir William Harcourt. Stephen formed friendships with some of its members, which were as permanent, though in few cases so little subject to external interruption, as his intimacy with Maine. Probably the Apostles did much to correct the formalism inevitably incident to the evangelical traditions of the first Sir James Stephen's household.

After leaving Cambridge, Fitzjames Stephen, having practically to choose between the Church and the bar, decided for the bar. He was called in 1854, after the usual haphazard preparation which was then (and still practically is) considered in England alone, and even in England for one kind of learning

alone, a sufficient introduction to the duties of a learned profession. His own estimate of his strictly professional success, written down in later years, was that in spite of such training as he could get, rather than because of it, he became a moderately successful advocate and a rather distinguished judge. As to the former branch of the statement, it is correct but ambiguous to those who do not know the facts. Stephen's work was always distinguished in quality, though his amount of business was never great in quantity. After his return from India and before he became a judge he had what is called a good practice, but still not a large one. In his earlier years at the bar he was attracted by the stop-gap of journalism. It was no common journalism, however, that enlisted Stephen as a contributor to the *Saturday Review* when it was founded in 1855. He was in company with Maine, Sir William Harcourt, G. S. Venables (a writer of first-rate quality who never set his name to anything), C. S. C. Bowen, E.A. Freeman, Goldwin Smith and others whose names have since become well known. Strangely enough, the first and the last books published by Stephen were selections from his papers in the *Saturday Review* (*Essays by a Barrister*, 1862, anonymous; *Horae sabbaticae*, 1892). These volumes embodied the results of his studies among publicists and theologians, chiefly English, from the 17th century onwards. They never professed to be more than the occasional products of an amateur's leisure, but they were of greater value when they were first published than is easily recognized at this day by a generation familiar with the resources of later criticism.

For exactly three years (1858-1861) Stephen served as secretary to a royal commission on popular education, which was more fortunate than most commissions in having prompt effect given to its conclusions. In 1859 he was appointed recorder of Newark. In 1863 he published his *General View of the Criminal Law of England* (not altogether superseded by the second edition of 1890, which was practically a new book). This was really the first attempt that had been made since Blackstone to explain the principles of English law and justice in a literary form, and it had a thoroughly deserved success. All this time Stephen kept up a great deal of miscellaneous writing, and the foundation of the *Pall Mall Gazette* in 1865 gave him a new opening. He was one of the principal contributors for some years, and an occasional one till he became a judge. So far he was a literary lawyer, also possibly with chances (diminished by his vehement dislike for party politics) of regular professional advancement, possibly not free from the temptation to turn wholly to literature. The decisive point of his career was in the summer of 1869, when he accepted the post of legal member of council in India. Fitzjames Stephen's friend Maine was his immediate predecessor in this office. Guided by Maine's comprehensive genius, the government of India had entered on a period of systematic legislation which was to last about twenty years. The materials for considerable parts of this plan had been left by Maine in a more or less forward condition. Stephen had the task of working them into their definite shape and conducting the bills through the Legislative Council. This he did with wonderful energy, with efficiency and workmanship adequate to the purpose, if sometimes rough according to English notions, and so as to leave his own individual mark in many places. The Native Marriages Act of 1872 was the result of deep consideration on both Maine's and Stephen's part. The Contract Act had been framed in England by a learned commission (apparently not having much special Indian information, or not much regarding that which it had), and the draft was materially altered in Stephen's hands before, also in 1872, it became law. The Evidence Act of the same year was entirely Stephen's own. It not only consolidated the rules of judicial proof, but endeavoured to connect them by legislative authority with a logical theory of probability set forth in the act itself. This part of the act has been criticized both as to the principle (which, indeed, seems open to much doubt) and as to the success of the draftsman in applying it. At any rate it is characteristic of Stephen's anxiety never to shirk a difficulty. To some extent

the Contract Act may be charged with similar over-ambition; but its more practical defects are evidently due to the acceptance by the original framers of unsatisfactory statements which, coming to India with a show of authority, naturally escaped minute criticism amid the varied business of the legislative department. If the success of the later Anglo-Indian Codes has not been quite so complete as that of the Penal Code, they have, on the whole, done excellent service, and they are at least as good as any European codification prior to the very recent achievements of scientific lawyers in Italy and Germany. Besides the special work of legislation, Stephen had to attend to the current administrative business of his department, often heavy enough to occupy the whole of an ordinary able man's attention, and he took his full share in the general deliberations of the viceroy's council. His last official act was the publication of a minute on the administration of justice which pointed the way to reforms not yet fully realized, and is still most valuable for every one who wishes to understand the judicial system of British India. Stephen, mainly for family reasons, came home in the spring of 1872. During the voyage he made a pastime of meditating and writing a series of articles which took the form of his book entitled *Liberty, Equality, Fraternity* (1873-1874)—a protest against J. S. Mill's neo-utilitarianism which was really in the nature of an appeal from the new to the old utilitarians, if any such were left, or perhaps rather to Hobbes. It was, however, too individual to be systematic, and made no serious attempt at reconstruction.

Indian experience had supplied Stephen with the motive for his next line of activity, which future historians of the common law may well regard as his most eminent title to remembrance. The government of India had been driven by the conditions of the Indian judicial system to recast a considerable part of the English law which had been informally imported. Criminal law procedure, and a good deal of commercial law, had been or were being put in a shape intelligible to civilian magistrates, and fairly within the comprehension of any intelligent man who would give a moderate amount of pains to mastering the text of the new codes. The rational substance of the law had been preserved, while the disorder and the excessive technicalities were removed. Why should not the same procedure be as practicable and profitable in England? It was Bentham's ideal of codification, to be put in practice with the knowledge of actual business and legal habits, and the lack of which had made Bentham's plans unworkable. For the next half-dozen years Fitzjames Stephen was an ardent missionary in this cause. The mission failed for the time as to the specific undertakings in which Stephen made his experiments, but it had a large indirect success which has not yet been adequately recognized. Stephen published, by way of private exposition, digests in code form of the law of evidence and the criminal law. There were transient hopes of an evidence act being brought before parliament, and in 1878 the digest of criminal law became a ministerial bill. This was referred to a very strong judicial commission, with the addition of Stephen himself: the revised bill was introduced in 1879 and 1880. It dealt with procedure as well as substantive law, and provided for a court of criminal appeal (after several years of judicial experience Stephen changed his mind as to the wisdom of this). However, no substantial progress was made. In 1883 the part relating to procedure was brought in separately, and went to the grand committee on law, who found there was not time to deal with it satisfactorily in the course of the session. Criminal appeal has since (1907) been dealt with; otherwise nothing has been done with either part of the draft code since. The historical materials which Stephen had long been collecting took permanent shape the same year (1883) in the *History of the Criminal Law of England*, which, though not free from inequalities and traces of haste, must long remain the standard work on the subject. A projected digest of the law of contract (which would have been much fuller than the Indian Code) fell through for want of time. Thus, none of Stephen's own plans of English codification took effect. Nevertheless they bore fruit indirectly. Younger

men dealt with other chapters of the law in the systematic form of the Anglo-Indian codes; and a digest of the law of partnership by Sir Frederick Pollock, and one of the law of negotiable instruments by Sir M. D. Chalmers, who some time afterwards filled the post of legal member of council in India, became the foundation of the Bills of Exchange Act of 1882 and the Partnership Act of 1890. Lord Herschell passed a Sale of Goods Act on similar lines, also drafted by Chalmers, in 1893; and a Marine Insurance Act, prepared in like manner in 1894, finally became law in 1906. Nothing really stands in the way of a practically complete code of maritime and commercial law for the United Kingdom but the difficulty of finding time in the House of Commons for non-contentious legislation; and whenever this is achieved, the result will in substance be largely due to Sir James Stephen's efforts. Meanwhile, in addition to his other occupations, Stephen was an active member of the Metaphysical Society (see KNOWLES), and he carried on an intimate correspondence with Lord Lytton, then viceroy of India, during the critical period of the second Afghan War. In connexion with the Metaphysical Society, and otherwise, Fitzjames Stephen took an active interest in many topics of current controversy. This led him to produce a great number of occasional articles, of which a list may be found at the end of Sir Leslie Stephen's *Life*. The matters dealt with covered a wide field, from modern history and politics, with a predilection for India, to philosophy, but the prevailing mood was theologico-political. All these writings were forcible expositions of serious and thoroughly definite views, and therefore effective at the time and valuable even to those who least agreed with them. As to the philosophical part of them, the grounds of discussion were shifting then, and have continued to shift rapidly. Much of Stephen's vigorous polemic has already incurred the natural fate of becoming as obsolete as the arguments against which it was directed. Pure metaphysical speculation, as an intellectual exercise, had little attraction for him; and, though he was fully capable of impartial historical criticism, he seldom applied it outside the history of law.

In 1877 Stephen was made a Knight Commander of the Star of India, and in 1878 he received the honorary degree of D.C.L. at Oxford. Early in 1879 he was appointed judge of the queen's bench division. He held that office a little more than eleven years. The combination of mature intellectual patience and critical subtlety which marked the great masters of the common law was not his, and it cannot be said that he made any considerable addition to the substance of legal ideas. His mind was framed for legislation rather than for systematic interpretation and development. Therefore he can hardly be called a great judge; but he was a thoroughly just and efficient one; and if none of his judgments became landmarks of the law, very few of them were wrong. Especially in criminal jurisdiction, he was invariably anxious that moral as well as legal justice should be done. He found time, in 1885, to produce a book on the trial of Nuncomar, for the purpose of rehabilitating Sir Elijah Impey's memory against the attack made on him in Macaulay's essay on Warren Hastings, which for most English readers is the first and last source of information on the whole matter. Mr G. W. Forrest's later research in the archives of the government of India had tended to confirm the judicial protest, at any rate as regards Macaulay's grosser charges.

The one thing of which Stephen was least capable—among other things possible to a good man and a good citizen—was sparing himself. He had one or two warnings which a less energetic man would have taken more seriously. In the spring of 1891 his health broke down, the chief symptom being sudden lapses of memory of which he was himself quite unconscious. In obedience to medical advice he resigned his judgeship in April, and was created a baronet. He lived in retirement till his death on the 11th of March 1894, having filled a not very long life with a surprising amount of work, of which a large proportion was of permanent value. Perhaps the most individual part of Stephen's character was his absolute sincerity. He would not allow himself even innocent dissimulation; and this gave to those who knew him but slightly an impression of hardness

which was entirely contrary to his real nature. Sir James Stephen married Mary Richenda Cunningham in 1855. On his death his eldest son, Herbert, succeeded to the baronetcy. A second son of brilliant literary promise, James Kenneth Stephen (1859–1892), died in his father's lifetime: his principal literary achievements consisted in two small volumes of verse—*Lapsus calami* and *Quo Musa tendis*, the former of which went through five editions in a very short time. The third son, Mr H. L. Stephen, was appointed in 1901 judge of the High Court of Calcutta.

See Sir Leslie Stephen, *Life of Sir James Fitzjames Stephen* (London, 1895), with bibliographical appendix, a model Biography; same author's article in the *Dict. Nat. Biog.*; *Letters with biographical Notes*, by his daughter, Caroline Emelia Stephen (1907). See also Sir C. P. Ilbert, "Sir James Stephen as a Legislator," *Law Quart. Rev.* x. 222. (F. Po.)

STEPHEN, SIR LESLIE (1832–1904), English biographer and literary critic, grandson of James Stephen (1758–1832), master in chancery, a friend of Wilberforce, and author of a book called *Slavery Delineated*, and son of Sir James Stephen (1789–1859), colonial under-secretary for many years, and author of *Essays on Ecclesiastical Biography*, was born at Kensington Gore on the 28th of November 1832. At his father's house he saw a good deal of the Abolitionists and other members of the Clapham sect, and the Macaulays, James Spedding, Sir Henry Taylor and Nassau Senior were intimate friends of his family. After education at Eton, King's College, London, and Trinity Hall, Cambridge, where he graduated B.A. (20th wrangler) 1854, M.A. 1857, Stephen remained for several years a fellow and tutor of his college. He has recounted the experiences of a resident fellow at that period in a delightful chapter in his *Life of Fawcett* as well as in some less formal *Sketches from Cambridge: By a Don* (1865). These sketches were reprinted from the *Pall Mall Gazette*, to the proprietor of which, George Smith, he had been introduced by his brother (Sir) James Fitzjames Stephen. It was at Smith's house at Hampstead that Stephen met his first wife, Harriet Marion (d. 1875), daughter of W. M. Thackeray; after her death he married Julia Prinsep, widow of Herbert Duckworth. While still a fellow he had taken holy orders, which he relinquished in March 1875 upon the passing of the Clerical Disabilities Act. In the meantime (after a visit to America, where he formed lasting friendships with Lowell and Eliot Norton) he settled in London, and wrote largely, not only for the *Pall Mall Gazette* and the *Saturday Review*, but also for *Fraser*, *Macmillan*, the *Fortnightly* and other periodicals. He was already known as an ardent mountaineer, as a contributor to *Peaks, Passes and Glaciers* (1862), and as one of the earliest presidents of the Alpine Club, when in 1871, as a vindication in some sort of the mountaineering mania, and as a commemoration of his own first ascents of the Schreckhorn and Rothhorn, he published his fascinating *Playground of Europe* (republished with additions, 1894). In the same year he was appointed editor of the *Cornhill Magazine*, the reputation of which he maintained by enlisting R. L. Stevenson, Thomas Hardy, W. E. Norris, Henry James and James Payn among his contributors. During the eleven years of his editorship, in addition to three sharp and penetrating volumes of critical studies, reprinted mainly from the *Cornhill* under the title of *Hours in a Library* (1874, 1876 and 1879), and some *Essays on Freethinking and Plain Speaking* (1873 and 1897, with introductory essays by J. Bryce and H. Paul), which included the very striking "A Bad Five Minutes in the Alps" (reprinted from *Fraser* and the *Fortnightly* in 1873), he made two valuable contributions to philosophical history and theory, *The History of English Thought in the Eighteenth Century* (1876 and 1881) and *The Science of Ethics* (1882); the second of these was extensively adopted as a textbook on the subject. The first was generally recognized as an important addition to philosophical literature, and led immediately to Stephen's election at the Athenaeum Club in 1877. In 1879 he set on foot a Sunday Walking Club, which contained well-known names, among them Sir F. Pollock, F. W. Maitland, Croom Robertson and Cotter Morison.

In the autumn of 1882 he abandoned the direction of the *Cornhill* to James Payn, having accepted the more responsible duty of the editor of the *Dictionary of National Biography*, for the first planning and conception of which he was largely responsible. The first volume of the *Dictionary* was published in January 1885, and twenty quarterly volumes followed under Stephen's sole editorship. Five volumes were then published under the joint editorship of Leslie Stephen and of Mr Sidney Lee, whom he had appointed as his assistant in March 1883. Early in 1891, after eight and a half years' service, Stephen, whose health had been impaired by the labour inseparable from the direction of such an undertaking, resigned the responsibility to his coadjutor. Not a trained historian, he often found it difficult to curb his impatience with Carlyle's old enemy Dryasdust. Fortunately for the success of the work, re-established health enabled him to remain a contributor to the *Dictionary*. Among his lives are those of Addison, Bolingbroke, Burns, Charlotte Brontë, Byron, Carlyle, Marlborough, Coleridge, Defoe, Dickens, Dryden, Fielding, George Eliot, Gibbon, Goldsmith, Hobbes, Hume, Johnson, Landor, Locke, Macaulay, the two Mills, Milton, Pope, Scott, Swift, Adam Smith, Thackeray, Warburton, Wordsworth and Young. Many of these are salted with irony, and most of them are characterized by felicitous phrases, by frequent flashes of insight (especially of the sardonic order), and by the good fortune which attends a consummate artist in his special craft. His particular style of treatment is more appropriate, perhaps, to the self-complacent worthies of the 18th century than to quietists such as Law and Wordsworth; but where space demands that a character should be inscribed upon a cherry-stone, Stephen seldom if ever failed to rise to the occasion. For the "English Men of Letters" he wrote lives of Swift, Pope and Johnson—the last well described as "the peerless model of short biographies"—and subsequently George Eliot and Hobbes (1904). During his tenure of the editorship of the *Dictionary* he was appointed first Clark lecturer at Cambridge (1883), and lectured upon his favourite period—Berkeley, Mandeville, Warburton and Hume; a few years later, upon one of several visits to his intimate friends and old correspondents, Norton and Lowell, he received (1890) a doctor's degree from Harvard University. After Lowell's death in 1891 Stephen was mainly instrumental in having a memorial window placed in Westminster Abbey.

In 1885 he brought out his standard *Life of Fawcett*, in 1893 his *Aguastic's Apology and other Essays*, and in 1895 the *Life* of his brother, Sir James Fitzjames Stephen, which, less essayistic in manner than the *Life of Fawcett*, contains his most finished biographical work. In the same year, in succession to Lord Tennyson, Stephen was elected president of the London Library, and shortly afterwards appointed a trustee of the National Portrait Gallery. Some of his experiences as an editor were embodied in *Studies of a Biographer*, issued in 1898, while in 1900 appeared an important work which he had long had in preparation in continuation of his *English Thought in the Eighteenth Century*, entitled *The English Utilitarians*, being full-length studies of Bentham and the two Mills. As a thinker Leslie Stephen showed himself consistently a follower of Hume, Bentham, the Mills and G. H. Lewes, but he accepted the older utilitarianism only as modified by the application of Darwinian principles, upon lines to some extent indicated by Herbert Spencer (see ETHICS). The negative character of his teaching, his anti-sacerdotal bias, his continual attitude of irony, and even the very subtlety of his thought, have co-operated to retard the recognition of his value as rivalled only by Bagehot among critics of the incisive school. For blowing the froth off the flagon of extravagant or inflated eulogy he certainly met no equal in his generation. Voluminous as his work is, it is never dull. While making self-depreciation a fine art, and perpetually laughing in his sleeve at the literary bias and the literary foible, he fulfilled with exceptional conscience the literary duty of never writing below his best. Brought up in a rigid and precise school which scorned all pretence and discouraged enthusiasm as the sign of an ill-regulated mind, he

produced no *magnum opus*, but he enriched English literature with a fine gallery of literary portraits, not all of them perhaps wholly accurate, but restrained, concise and always significant. Besides being a member of the Metaphysical Society, he was for some years president of the Ethical Society (many of his addresses to which were published as *Social Rights and Duties* in 1896). In addition to his separate works, he superintended a large number of editions, among them Clifford's *Essays* (1879), Fielding (1882), Richardson (1883), Payn's *Backwater of Life* (1899), and J. R. Green's *Letters* (1901). In 1896 he wrote a memoir of his friend James Dykes Campbell for the second edition of Campbell's *Coleridge*, and in 1897 he contributed a preface to the English translation of *The Early Life of Wordsworth*, by M. Legouis.

His name was included in the Coronation honours list of June 1902, when he was made K.C.B. In December of this year he had to undergo an operation, after which his health began to wane rapidly. In 1903 his Ford lectures, one last luminous talk about the 18th century, were delivered by his nephew, H. L. Fisher. He told a nurse that his enjoyment of books had begun and would end with Boswell's *Johnson*. Like Johnson, under a brusque exterior and a coltish temper, he concealed a sympathetic and humorous soul. In spite of "natural sorrows"—the loss of two much loved wives, he pronounced his life to have been a happy one. He died at his house, 22 Hyde Park Gate, on the 22nd of February 1904, and his remains were buried at Golders Green. A Leslie Stephen memorial lectureship was founded at Cambridge in 1905. Under an austere form and visage Stephen was in reality the soul of susceptibility and of an almost freakish fun. This is shown very clearly in the fantastic marginal drawings with which he delighted to illustrate his life for the amusement of young people.

See *Life and Letters*, by F.W. Maitland (1906); and *Dictionary of National Biography*, postscript to Statistical Account in the 1908-1909 reissue. (T. SE.)

STEPHEN BAR SŪDHAILĒ, a Syrian mystical writer, who flourished about the end of the 5th century A.D. The earlier part of his career was passed at Edessa, of which he may have been a native.¹ He afterwards removed to Jerusalem, where he lived as a monk, and endeavoured to make converts to his peculiar doctrines, both by teaching among the community there and by letters to his former friends at Edessa. He was the author of commentaries on the Bible and other theological works. Two of his eminent contemporaries, the Monophysites Jacob of Sērūgh (451-521) and Philoxenus of Mabbōgh (d. 523), wrote letters in condemnation of his teaching. His two main theses which they attacked were (1) the limited duration of the future punishment of sinners, (2) the pantheistic doctrine that "all nature is consubstantial with the Divine essence"—that the whole universe has emanated from God, and will in the end return to and be absorbed in him.

The fame of Stephen as a writer rests on his identification with the author of a treatise which survives in a single Syriac MS. (Brit. Mus. Add. MSS. 7189, written mainly in the 13th century). "The book of Hierotheus on the hidden mysteries of the house of God." The work claims to have been composed in the 1st century A.D. by a certain Hierotheus who was the disciple of St Paul and the teacher of Dionysius the Areopagite. But, like the works which pass under the name of Dionysius, it is undoubtedly pseudonymous, and most Syriac writers who mention it attribute it to Stephen. An interesting discussion and summary of the book have been given by A. L. Frothingham (*Stephen bar Sudhaili*, Leiden, 1886), but the text is still (1910) unpublished. From Frothingham's analysis we learn that the work consists of five books; after briefly describing the origin of the world by emanation from the Supreme Good it is mainly occupied with the description of the stages by which the mind returns to union with God, who finally becomes "all in all." "To describe the contents in a few words: at the beginning we find the statement regarding absolute existence, and the emanation from primordial essence of the spiritual and material universes: then comes, what occupies almost the entire work, the experience of

¹ He is described as "Stephen the Edessene" in the 8th-century MS. which contains the letter of Philoxenus to Abraham and Orestes.

the mind in search of perfection during this life. Finally comes the description of the various phases of existence as the mind rises into complete union with, and ultimate absorption into, the primitive essence. The keynote to the experience of the mind is its absolute identification with Christ; but the son finally resigns the kingdom unto the Father, and all distinct existence comes to an end, being lost in the chaos of the Good" (Frothingham, p. 92). One of the most curious features of the work is the misguided skill with which the language of the Bible is pressed into the service of pantheistic speculation. In this and other respects the book harmonizes well with the picture of Stephen's teaching afforded by the letter of Philoxenus to the Edessene priests Abraham and Orestes (Frothingham, pp. 28-48). The *Book of Hierotheus* is probably an original Syriac work, and not translated from Greek. Its relation to the Pseudo-Dionysian literature is a difficult question; probably Frothingham (p. 83) goes too far in suggesting that it was prior to all the pseudo-Dionysian writings (cf. Ryssel in *Zeitschrift für Kirchengeschichte*).

The unique MS. in which the book of Hierotheus survives furnishes along with its text the commentary made upon it by Theodosius, patriarch of Antioch (887-896), who appears to have sympathized with its teaching. A rearrangement and abridgment of the work was made by the great Monophysite author Barhebraeus (1226-1286), who expunged or garbled much of its unorthodox teaching. It is interesting to note that the identical copy which he used is the MS. which now survives in the British Museum. (N. M.)

STEPHEN (ISTVÁN) BÁTHORY (1533-1586), king of Poland and prince of Transylvania, the most famous member of the Somlyó branch of the ancient Báthory family, now extinct, but originally almost coeval with the Hungarian monarchy. István Báthory spent his early years at the court of the emperor Ferdinand, subsequently attached himself to Janos Zapolya, and won equal renown as a valiant lord-marcher, and as a skilful diplomatist at the imperial court. Zapolya rewarded him with the voivodeship of Transylvania, and as the loyal defender of the rights of his patron's son, John Sigismund, he incurred the animosity of the emperor Maximilian, who kept him in prison for two years. On the 25th of May 1571, on the death of John Sigismund, Báthory was elected prince of Transylvania by the Hungarian estates, in spite of the opposition of the court of Vienna and contrary to the wishes of the late prince, who had appointed Gaspar Békesy his successor. Békesy insisting on his claims, a civil war ensued in which Báthory ultimately drove his rival out of Transylvania (1572). On the flight of Henry of Valois from Poland in 1574, the Polish nobility, chiefly at the instigation of the great chancellor, Jan Zamoyski, elected Báthory king of Poland (1575) in opposition to the emperor Maximilian, the candidate of the senate. On hearing of his altogether unexpected elevation, Báthory summoned the Transylvanian estates together at Medgyes and persuaded them to elect his brother Christopher prince in his stead; then hastening to Cracow, he accepted the onerous conditions laid upon him by the Polish Diet, espoused the princess Anne, the elderly sister of the last Jagiello, Sigismund II., and on the 1st of May was crowned with unprecedented magnificence. At first his position was extremely difficult; but the sudden death of the emperor Maximilian at the very moment when that potentate, in league with the Muscovite, was about to invade Poland, completely changed the face of things, and though Stephen's distrust of the Habsburgs remained invincible, he consented at last to enter into a defensive alliance with the empire which was carried through by the papal nuncio on his return to Rome in 1578. The leading events of Stephen Báthory's glorious reign can here only be briefly indicated. All armed opposition collapsed with the surrender of Danzig. "The Pearl of Poland," encouraged by her immense wealth, and almost impregnable fortifications, as well as by the secret support of Denmark and the emperor, had shut her gates against the new monarch, and was only reduced (Dec. 16, 1577) after a six months' siege, beginning with a pitched battle beneath her walls in which she lost 5000 of her mercenaries. Danzig was compelled to pay a fine of 200,000 gulden, but her civil and religious liberties were wisely confirmed. Stephen was now able to devote himself to foreign affairs. The difficulties with the sultan were temporarily adjusted by a truce signed on the 5th of November 1577; and the Diet of Warsaw was

persuaded to grant Stephen subsidies for the inevitable war against Muscovy. Two campaigns of wearing marches, and still more exhausting sieges ensued, in which Báthory, although repeatedly hampered by the parsimony of the Diet, was uniformly successful, his skilful diplomacy at the same time allaying the suspicions of the Porte and the emperor. In 1581 Stephen penetrated to the very heart of Muscovy, and, on the 22nd of August, sat down before the ancient city of Pskov, whose vast size and imposing fortifications filled the little Polish army with dismay. But the king, despite the murmurs of his own officers, and the protestations of the papal nuncio, Possevino, whom the curia, deluded by the mirage of a union of the churches, had sent expressly from Rome to mediate between the tsar and the king of Poland, closely besieged the city throughout a winter of arctic severity, till, on the 13th of December 1581, Ivan the Terrible, alarmed for the safety of the third city in his empire, concluded peace at Zapoli (Jan. 15, 1582), thereby ceding Polotsk and the whole of Livonia. The chief domestic event of Stephen's reign was the establishment in Poland of the Jesuits, who alone had the intelligence to understand and promote his designs of uniting Poland, Muscovy and Transylvania into one great state with the object of ultimately expelling the Turks from Europe. The project was dissipated by his sudden death, of apoplexy, on the 12th of December 1586.

See I. Polkowski, *The Martial Exploits of Stephen Báthory* (Pol.; Cracow, 1887); Paul Pierling, *Un Arbitrage pontifical au xviii^{me} siècle* (Brussels, 1890); Lajos Szadeczky, *Stephen Báthory's election to the Crown of Poland* (Hung.; Budapest, 1887). (R. N. B.)

STEPHENS, ALEXANDER HAMILTON (1812-1883), American statesman, vice-president of the Confederate States during the Civil War, was born in Wilkes (now Taliaferro) county, Georgia, on the 11th of February 1812. He was a weak and sickly child of poor parents, and from his sixth to his fifteenth year, when he was left an orphan, he worked on a farm. After his father's death he went to live with an uncle in Warren county. The superintendent of the local Sunday school sent him to an academy at Washington, Wilkes county, for one year and in the following year (1828) he was sent by the Georgia Educational Society to Franklin College (university of Georgia), where he graduated in 1832. Deciding not to enter the ministry, he paid back the money advanced by the society. He was a schoolmaster for about two years, and then, after studying law for less than four months, was admitted to the bar in 1834. Although delicate in health, his success at the bar was immediate and remarkable. In 1836 he was elected to the Georgia House of Representatives after a campaign in which he was vigorously opposed because he had attacked the doctrine of nullification, and because he had opposed all extra-legal steps against the abolitionists. He was annually re-elected until 1841; in 1842 he was elected to the state Senate, and in the following year, on the Whig ticket, to the National House of Representatives. In this last body he urged the annexation of Texas, chiefly as a means of achieving more power for the South in Congress. He was denounced as a traitor to his party because of his support of annexation, but he later became the leader of the Whig opposition to the war with Mexico. He vigorously supported the Compromise Measures in 1850, and continued to act with the Whigs of the North until they, in 1852, nominated General Winfield Scott for the presidency without Scott's endorsement of the Compromise. Stephens and other Whigs of the South then chose Daniel Webster, but a little later they joined the Democrats. In 1854 Stephens helped to secure the passage of the Kansas-Nebraska Bill. Before the Georgia legislature in November 1860, and again in that state's secession convention in January 1861, he strongly opposed secession, but when Georgia seceded he "followed his state," assisted in forming the new government, and was elected vice-president of the Confederate States. He greatly weakened the position of the Confederacy by a speech delivered at Savannah (March 21, 1861) in which he declared that slavery was its corner-stone. Throughout the war, too, he was so intensely concerned about states' rights and civil liberty that he opposed the exercise of

extra-constitutional war powers by President Jefferson Davis lest the freedom for which the South was fighting should be destroyed. His policy was to preserve constitutional government in the South and strengthen the anti-war party in the North by convincing it that the Lincoln administration had abandoned such government; to the same end he urged, in 1864, the unconditional discharge of Federal prisoners in the South. Stephens headed the Confederate commission to the peace conference at Hampton Roads in February 1865. In the following May, after the fall of the Confederacy, he was arrested at his home and taken to Fort Warren, in Boston harbour, where he was confined until the 12th of October. He accepted the result of the war as a practical settlement of the question of secession, exercised a beneficent influence on the negroes of his section, and promoted reconciliation between the North and the South. In 1866 he was elected to the United States Senate, but was not permitted to take his seat. He was a representative in Congress, however, from 1873 to 1882, and was governor of Georgia in 1882-1883, dying in office, at Atlanta, on the 4th of March 1883. He was remarkable for both his moral and physical courage, and in politics was notable for his independence of party. From 1871 to 1873 he edited the *Atlanta Daily Sun*, and he published *A Constitutional View of the Late War between the States* (2 vols., 1868-1870), perhaps the best statement of the southern position with reference to state sovereignty and secession; *The Reviewers Reviewed* (1872), a supplement to the preceding work; and *A Compendium of the History of the United States* (1875; new ed., 1883).

See Louis Pendleton, *Alexander H. Stephens* (Philadelphia, 1908); R. M. Johnston and W. H. Browne, *Life of Alexander H. Stephens* (Philadelphia, 1878; new ed., 1883); and Henry Cleveland, *Alexander H. Stephens in Public and Private, with Letters and Speeches* (Philadelphia, 1866).

STEPHENS, JOHN LLOYD (1805-1852), American traveller, was born on the 28th of November 1805, at Shrewsbury, New Jersey. Having been admitted to the bar, he practised for about eight years in New York City. In 1834, the state of his health rendering it advisable that he should travel, he visited Europe, and for two years made a tour through many countries of that Continent, extending his travels to Egypt and Syria. On his return to New York he published in 1837 (under the name of "George" Stephens) *Incidents of Travel in Egypt, Arabia Petraea, and the Holy Land*. This work was followed next year by the publication of *Incidents of Travel in Greece, Turkey, Russia and Poland*. In 1839 Stephens arranged with Frederick Catherwood of London, who had accompanied him on some of his travels, and illustrated the above-mentioned publications, to make an exploration in Central America, with a view to discovering and examining the antiquities said to exist there. Stephens, meantime, was appointed to a mission to Central America. The joint travels of Stephens and Catherwood occupied some eight months in 1839 and 1840. As the result of these researches Stephens published in 1841 *Incidents of Travels in Central America, Chiapas and Yucatan*. In the autumn of 1841 the two travellers made a second exploration of Yucatan, and a work followed in 1843—*Incidents of Travel in Yucatan*. This work describes the most extensive travels executed till that date by a stranger in the peninsula, and, as the author claims, "contains account of visits to forty-four ruined cities or places in which remains or vestiges of ancient populations were found." It enjoyed a wide popularity, and Stephens was urged to prosecute his researches of American antiquities in Peru, but was disinclined to so distant an expedition. He became a director of the newly-formed American Ocean Steam Navigation Company, which established the first American line of transatlantic steamships. He visited Panama to reconnoitre the ground with a view to the construction of a railway across the isthmus, and, first as vice-president and then as president of the Panama Railway Company, spent the greater part of two years in superintending the project. His health was, however, undermined by exposure to the climate of Central America, and he died at New York on the 10th of October 1852.

STEPHENSON, GEORGE (1781-1848), English engineer, was the second son of Robert Stephenson, fireman of a colliery engine at Wylam, near Newcastle, where he was born on the 9th of June 1781. In boyhood he was employed as a cowherd, and afterwards he drove the ginhorse at a colliery. In his fourteenth year he became assistant fireman to his father at a shilling a day, and in his seventeenth year he was appointed plugman, his duty being to attend to the pumping engine. As yet he was unable to read, but, stimulated by the desire to obtain fuller information regarding the inventions of Boulton and Watt, he began in his eighteenth year to attend a night school and made remarkably rapid progress. In 1801 he obtained a situation as a brakesman, in 1802 he became an engineman at Willington Quay, where he took up watch and clock cleaning, and in 1804 he moved to Killingworth, where in 1812 he was appointed engine-wright at the High Pit at a salary of £100 a year. It was at Killingworth that he devised his miner's safety lamp, first put to practical tests in the autumn of 1815, at the same time that Sir Humphry Davy was producing his lamp. There was considerable controversy as to which of the two men was entitled to the honour of having first made an invention which was probably worked out independently, though simultaneously, by both, and when the admirers of Davy in 1817 presented him with a service of plate, those of Stephenson countered with an address and £1000 early in 1818. In 1813 his interest in the experiments with steam traction that were being carried on at Wylam led him to propose an experiment of the same kind to the proprietors of the Killingworth colliery, and he was authorized to incur the outlay for constructing a "travelling engine" for the tramroads between the colliery and the shipping port 9 m. distant. The engine, which he named "My Lord," ran a successful trial on the 25th of July 1814. In 1822 he succeeded in impressing the advantages of steam traction on the projectors of the Stockton & Darlington railway, who had contemplated using horses for their wagons, and was appointed engineer of the railway, with liberty to carry out his own plans, the result being the opening, on the 27th of September 1825, of the first railway over which passengers and goods were carried by a locomotive. His connexion with the Stockton & Darlington railway led to his employment in the construction of the Liverpool & Manchester railway, which, notwithstanding prognostications of failure by the most eminent engineers of the day, he carried successfully through Chat Moss. When the line was nearing completion he persuaded the directors, who were rather in favour of haulage by fixed engines, to give the locomotive a trial. In consequence they offered a prize of £500 for a suitable machine, and in the competition held at Rainhill in October 1829 his engine "The Rocket" met with approval. On the 15th of September in the following year the railway was formally opened, the eight engines employed having been made at the works started by Stephenson with his cousin Thomas Richardson (1771-1853) and Edward Pease (1767-1858) at Newcastle in 1823. Subsequently Stephenson was engineer of, among others, the Grand Junction, the London & Birmingham (with his son Robert), Manchester to Leeds, Derby to Leeds, Derby to Birmingham, and Normanton to York; but he strongly disapproved of the railway mania which ensued in 1844. He was also consulted in regard to the construction of railways in Belgium and Spain. The last year or two of his life was spent in retirement at Tapton House, Chesterfield, in the pursuit of farming and horticulture, and there he died on the 12th of August 1848. Stephenson was thrice married, his only son Robert being the child of Fanny Henderson, his first wife, who died in 1806. A nephew, George Robert Stephenson, who was born at Newcastle in 1819 and died near Cheltenham in 1905, was placed by him on the engineering staff of the Manchester & Leeds line in 1837, and subsequently constructed many railways in England, New Zealand and Denmark. He was president of the Institution of Civil Engineers in 1876-1877.

See *Story of the Life of George Stephenson*, by Samuel Smiles (1857, new ed., 1873); and Smiles's *Lives of British Engineers*, vol. iii.

STEPHENSON, ROBERT (1803–1859), English engineer, only son of George Stephenson (*q.v.*), was born at Willington Quay on the 16th of October 1803. His father, remembering his own early difficulties, bestowed special care on his son's education, and sent him in his twelfth year to Mr Bruce's school in Percy Street, Newcastle, where he remained about four years. In 1819 he was apprenticed to Nicholas Wood, a coal-viewer at Killingworth, after which he was sent in 1822 to attend the science classes at the university of Edinburgh. On his return he assisted his father in surveying the Stockton & Darlington and Liverpool & Manchester lines, but in 1824 he accepted an engagement in South America to take charge of the engineering operations of the Colombian Mining Association of London. On account of the difficulties of the situation he resigned it in 1827, and returned to England via New York in company with Richard Trevithick, whom he had met in a penniless condition at Cartagena. He then undertook the management of his father's factory in Newcastle, and greatly aided him in the improvement of the locomotives. His practice was not confined to his own country, but extended also to Sweden, Denmark, Belgium, Switzerland, Piedmont and Egypt. In this connexion his most remarkable achievements were his railway bridges, especially those of the tubular girder type. Among his more notable examples are the Royal Border bridge at Berwick-on-Tweed, the High Level bridge at Newcastle-on-Tyne, the Britannia tubular bridge over the Menai Straits, the Conway tubular bridge, and the Victoria tubular bridge over the St Lawrence at Montreal. In 1847 he entered the House of Commons as member for Whitby, retaining the seat till the end of his life. In 1855 he was elected president of the Institution of Civil Engineers, of which he became a member in 1830. He died in London on the 12th of October 1859, and was buried in Westminster Abbey.

See *The Story of the Life of George Stephenson, including a Memoir of his Son Robert Stephenson*, by Samuel Smiles (1857; new ed., 1873); Jeaffreson, *Life of Robert Stephenson* (2 vols., 1864); and Smiles's *Lives of British Engineers*, vol. iii.

STEPNEY, GEORGE (1663–1707), English poet and diplomatist, son of George Stepney, groom of the chamber to Charles II., was born at Westminster in 1663. He was admitted on the foundation of Westminster School in 1676, and in 1682 became a scholar of Trinity College, Cambridge, becoming a fellow of his college in 1687. Through his friend Charles Montagu, afterwards earl of Halifax, he entered the diplomatic service, and in 1692 was sent as envoy to Brandenburg. He represented William III. at various other German courts, and in 1702 was sent to Vienna, where he had already acted as envoy in 1693. In 1705 Prince Eugène desired his withdrawal on the ground of his alleged partiality to the Hungarian insurgents, but the demand was taken back at the request of Marlborough, who had great confidence in Stepney. He was, nevertheless, removed in 1706 to the Hague. In the next year he returned to England in the hope of recovering from a severe illness, but died in Chelsea, London, on the 15th of September 1707, and was buried in Westminster Abbey. Stepney had a very full and accurate knowledge of German affairs, and was an excellent letter-writer. Among his correspondents was Baron Leibnitz, with whom he was on the friendliest terms. Much of his official and other correspondence is preserved in the letters and papers of Sir John Ellis (Brit. Mus. Add. MSS. 28875–28947), purchased from the earl of Macclesfield in 1872, and others are available in the record office. He contributed a version of the eighth satire of Juvenal to the translation (1693) of the satires "by Mr Dryden and several other eminent hands." Dr Johnson, who included him in his *Lives of the Poets*, called him a "very licentious translator," and remarked that he did not "recompense his neglect of the author by beauties of his own."

His poems appear in Chalmers's *English Poets*, vol. viii., and other collections of the kind. Some of his correspondence is printed by J. M. Kemble in *State Papers and Correspondence . . . from the Revolution to the Accession of the House of Hanover* (1857). A list of the Macclesfield letters is to be found in the Report of the

Hist. MSS. Commission, No. i., app. pp. 34–40. For an account of Stepney's family and circumstances, see R. Harrison, *Some Notices of the Stepney Family* (1870), pp. 22–28.

STEPNEY, an eastern metropolitan borough of London, England, bounded N. by Bethnal Green, E. by Poplar, S. by the river Thames, and W. by the City of London and Shoreditch. Pop. (1901), 298,600. It forms part of the "East End" of London; the parish, indeed, formerly covered practically the whole area so termed. Here are squalid streets and mean houses typical of the poorest class of inhabitants. The thoroughfares of Mile End Road and Whitechapel Road and that of Commercial Road East traverse the borough from the east and converge near the City boundary, where stood the ancient Aldgate. In the north Stepney includes the districts of Spitalfields, Whitechapel and Mile End; and in the south Wapping, Shadwell, Ratcliff and Limehouse. The southern districts are occupied by sailors and labourers in the St Katherine and London Docks and the wharves and factories lining the river-bank. The parish church of St Dunstan, Stepney, is a perpendicular building, much restored, containing many monuments and curious inscriptions. The church of St Anne, Limehouse (1730) is by Nicholas Hawksmoor. The district of Spitalfields has an old association with the silk-weaving industry; a trade in singing birds is also characteristic of this district; and in Ratcliff the well-known naturalist's firm of Jamrach is situated. In the extreme west the borough includes within its bounds the historic Tower of London, the Royal Mint and the fine Tower Bridge over the Thames. There is no bridge below this, but the construction of the Rotherhithe Tunnel was authorized in 1900. The Thames Tunnel is used by the East London railway. Among institutions the principal is the People's Palace, Mile End Road, opened by Queen Victoria in 1887 as a place of intellectual and physical recreation and education. The Drapers' Company contributed largely to the cost of erection. Toynbee Hall, Commercial Street, was founded in 1884 under the trusteeship of the Universities Settlements Association and named after Arnold Toynbee (d. 1883), a philanthropist who devoted himself to work in this part of London. Other institutions are the London Hospital, Whitechapel, the East London children's hospital, the headquarters of Dr Barnardo's Homes, Stepney Causeway, and Her Majesty's Hospital for waifs connected therewith; the Stepney training college of the Society for Promoting Christian Knowledge, and the Spitalfields trade and technical school. There is a fish market in Shadwell, and a vegetable market in Spitalfields. Stepney is a suffragan bishopric in the diocese of London. The municipal borough comprises the Stepney, Whitechapel, Mile End, Limehouse and St George divisions of the Tower Hamlets parliamentary borough, each division returning one member. The borough council consists of a mayor, 10 aldermen, and 60 councillors. Area, 1765.6 acres.

The name appears in Domesday and later as *Stevenhethel*. The suffix is thus the common form *hythe*, a haven; but for the prefix no certain derivation is offered. At Mile End, so called from its distance from the City (Aldgate), the rebels from Essex under the leadership of Wat Tyler assembled (1381), and here Richard II. first met them in parley. Pepys records the village as a favourite place of resort.

STEPNIAK, SERGIUS (1852–1895), Russian revolutionist, whose real name was Sergius Michaelovitch Kravchinski, was born in South Russia, of parents who belonged to a noble family. He received a liberal education, and, when he left school, became an officer in the artillery; but his sympathy with the peasants, among whom he had lived during his boyhood in the country, developed in him at first democratic and, later, revolutionary opinions. Together with a few other men of birth and education, he began secretly to sow the sentiments of democracy among the peasants. His teaching did not long remain a secret, and in 1874 he was arrested. He succeeded in making his escape—possibly he was permitted to escape on account of his youth—and immediately began a more vigorous campaign against autocracy. His sympathetic nature was influenced by indignation against the brutal methods adopted

towards prisoners, especially political prisoners, and by the stern measures which the government of the tsar felt compelled to adopt in order to repress the revolutionary movement. His indignation carried him into accord for a time with those who advocated the terrorist policy. In consequence he exposed himself to danger by remaining in Russia, and in 1880 he was obliged to leave the country. He settled for a short time in Switzerland, then a favourite resort of revolutionary leaders, and after a few years came to London. He was already known in England by his book, *Underground Russia*, which had been published in London in 1882. He followed it up with a number of other works on the condition of the Russian peasantry, on Nihilism, and on the conditions of life in Russia. His mind gradually turned from belief in the efficacy of violent measures to the acceptance of constitutional methods; and in his last book, *King Stork and King Log*, he spoke with approval of the efforts of politicians on the Liberal side to effect, by argument and peaceful agitation, a change in the attitude of the Russian government towards various reforms. Stepniak constantly wrote and lectured, both in Great Britain and the United States, in support of his views, and his energy, added to the interest of his personality, won him many friends. He was chiefly identified with the Socialists in England and the Social Democratic parties on the Continent; but he was regarded by men of all opinions as an agitator whose motives had always been pure and disinterested. Stepniak was killed by a railway engine at a level crossing at Bedford Park, Chiswick, where he resided, on the 23rd of December 1895. He was cremated at Woking on the 28th of December. (H. H. F.)

STEPPE (from the Russ. *stepi*, a waste), the name given to the level treeless plains in certain parts of the Russian Empire, and thence sometimes, though not commonly, extended, in physical geography, to signify similar plains elsewhere. The name is most commonly applied specifically to the plains in the south and south-east of European Russia and in the south-west of Asiatic Russia, and in this connexion the term sometimes connotes semi-desert conditions. Otherwise the Russian steppes may be considered as kindred to and connected with the *Heiden* (heaths) of northern Germany.

STEPPE, GENERAL-GOVERNORSHIP OF, a portion of Russian Central Asia which includes both what was formerly known as the Kirghiz Steppe, and the region around Omsk, which was formerly part of Western Siberia. It consists of four provinces: Akmolinsk, Semipalatinsk, Turgai and Uralsk, having a total area of 711,000 sq. m. and a total population of 2,472,931 in 1897. Details are given under the names of the provinces respectively. Omsk is the capital.

STEREOBATE (Gr. *στερεός*, solid, and *βάσις*, a base), the term in architecture given to the substructure of rough masonry of a Greek temple.

STEREOCHEMISTRY (Gr. *στερεός*, solid, and chemistry), a branch of chemistry which considers the spatial arrangement of the atoms composing a molecule (see STEREO-ISOMERISM).

STEREO-ISOMERISM, or STEREOMERISM, a term introduced by Victor Meyer (by way of his denomination stereo-chemistry for "chemistry in space") to denote those cases of isomerism, *i.e.* the difference of properties accompanying identity of molecular formulae, where we are forced to admit the same atomic linking and can only ascribe the existing difference to the different relative position of atoms in the molecule.

Historical.—Considerations concerning the relative position of atoms have been traced back as far as Swedenborg (1721); in more recent times the first proposal in this direction seems due to E. Paternò (1866), followed by Auguste Rosenstiehl and by Alexis Gaudin (1873). The step made by J. A. Le Bel and J. H. van't Hoff (1874) brought considerations of this kind in the reach of experimental test, and so led to "stereo-chemistry." The work of Louis Pasteur on molecular asymmetry in tartaric acid (1860) touched stereo-chemistry so nearly that, had structural chemistry been sufficiently developed then, stereo-chemistry might have originated fourteen years earlier; it happened, however, that Wislicenus's investigation of lactic

acids (1866) immediately stimulated Van't Hoff's views. The fundamental conceptions of Le Bel and Van't Hoff differ in that the former are based on Pasteur's notions of molecular asymmetry, the latter on structural chemistry, especially as developed by August Kekulé for quadrivalent carbon. Both seem to lead to the same conclusions as to stereo-isomerism, but the latter has the advantage of allowing a more detailed insight, whereas the former, which is free from hypothetical conceptions, is of absolute reliability.

As our knowledge of stereo-isomerism originated in the chemistry of carbon compounds and found the largest development there, this part will be treated first.

Stereo-isomerism in Carbon Compounds.

1. *The Asymmetric Carbon Atom.*—Though stereo-chemistry is based on the notion of atoms, there is not the least danger that it may break down when newer notions about those atoms are introduced. Even admitting that they are of a compound nature, *i.e.* built up from smaller electrical particles or anything else and able to split up under given conditions, their average lapse of existence is long enough to consider them as reliable building-stones of the molecule, though these building-stones may give way now and then, as our best ordinary ones by the action of an earthquake. Another thing which stereo-chemistry abstracts beforehand is the movement of atoms, which is generally accepted to exist, but becoming less as the temperature sinks and disappearing at absolute zero. And so the following symbols, representing atoms in a fixed position, may correspond to these last circumstances, whereas at ordinary temperatures atoms may vibrate, for instance, with these fixed positions as centres.

The first development from structural to stereo-chemistry was to consider the relative position of atoms in methane, CH₄. Structural chemistry had proved that the four atoms of hydrogen were linked

to carbon and not to each other, thus $\text{C} \begin{matrix} \text{H} \\ \text{H} \\ \text{H} \\ \text{H} \end{matrix}$ and not, for example,

$\text{H}-\text{H}-\text{C} \begin{matrix} \text{H} \\ \text{H} \end{matrix}$, but how the four were grouped remained to decide.

The decision is derived as follows:—

If the four hydrogen atoms are supposed to be in a plane on one side of the carbon atom as above, two methylchlorides CH₃Cl should be possible, *viz.*—

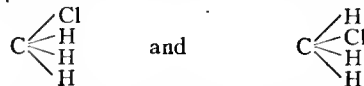

Such isomeric compounds have never been found, but they appear as soon as the four atoms (or groups of atoms) to which carbon is combined are different, for example in CHFCIBr, fluorochlorbromomethane. Then and only then two isomeric compounds have been regularly observed, and the sole notion about relative position of atoms in methane which explains this fact is that the four groups combined with carbon are placed at the summits of a tetrahedron whose centre is formed by carbon. The two possibilities are then represented by:—

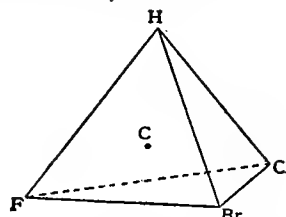

FIG. 1.

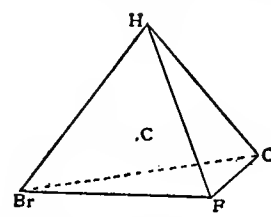

FIG. 2.

These groupings have the character of enantiomorphism, *i.e.* they are non-identical mirror images. If any of the two differences in the summits is given up, for example, F substituted by Cl with the formation of CHCl₂Br, the enantiomorphism disappears.

The isomerism corresponding to this difference in relative position is the simplest case of stereo-isomerism. The carbon atom in the special condition described, linked to four different atoms or groups, is denominated "asymmetric carbon," and will be denoted in the following formulae as C. Stereo-isomerism exists in tartaric acid, HO₂C·CH(OH)·CH(OH)·CO₂H (studied by Pasteur), in the lactic acid, CH₃·CH·OH·CO₂H (studied by Wislicenus), while the simplest case at present known is the chlorobromofluoroacetic acid, C·Cl·Br·F·CO₂H, obtained by Schwartz. This stereo-isomerism, due to the presence of asymmetric carbon, is of a characteristic kind, which is in perfect accordance with the theory of its origin, being the most complete identity combined with the difference that exists between the left and right hand. All the properties which

cannot differ in this last sense are identical, viz.: melting and boiling point, specific gravity, &c. But the crystalline form, which may show enantiomorphism, indeed shows this difference in the isomers in question; and especially the behaviour (in the amorphous state) towards polarized light differs in the sense that the plane of polarization is turned to the left by the one isomer, and exactly as much to the right by the other, so that they may be termed "optical antipodes." All these differences disappear with the asymmetric carbon, and the succinic acid, HO₂C·CH₂·CH₂·CO₂H, from tartaric acid is optically inactive and shows no stereo-isomerism.

2. *Compounds with more than one Asymmetric Carbon Atom.*—Stereo-isomerism and the space relation of atoms in compounds with higher asymmetry can best be developed by aid of graphic representations, founded on the notion of space relations in ethane, H₃C·CH₃. A consequence of the tetrahedral grouping in methane is the configuration given in fig. 3, where the six hydrogen atoms are substituted by six atoms or groups R₁, . . . R₆. The second (above) carbon atom is supposed to be at the top of the lower tetrahedron, and vice versa. Each other position, obtained by turning R₁R₂R₃ around the C—C axis, is also possible, but since no isomerism due to this difference of relative position, which might already show itself in ethane, has been observed, we may admit that one of the positions obtained by the above rotation is the stable one, and fig. 3 may represent it. For simplicity's sake this figure may be projected on a plane by moving R₃ and R₆ respectively upward and downward, with R₁R₂ and R₄R₅ as

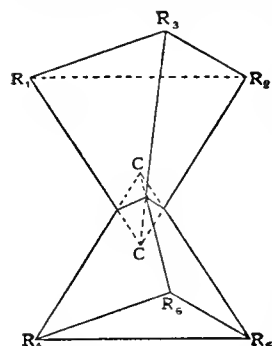
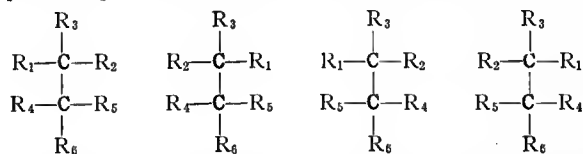

FIG. 3.

axes, which leads to the first of the four configurations representing the stereo-isomers possible in the above case. They differ in the two possible spatial arrangements of R₁R₂R₃ and R₄R₅R₆:



As one asymmetric carbon introduces two stereo-isomers and two introduce four, *n* asymmetric carbon atoms will lead to 2^{*n*} isomers. They are grouped in pairs presenting enantiomorphous figures in space, as do the first and the last of the above symbols, which correspond to the character of optical antipodes, whereas the first and second correspond to greater differences in melting points, &c. A well-studied example is offered by the dibromides of cinnamic acid, C₆H₅·CHBr·CHBr·CO₂H. They have been obtained by Liebermann in two antipodes melting at 92°, and two other antipodes, differing in optical rotation from the first, and melting at 195°.

A simplification is introduced when the structural formula shows symmetry, as is the case in R₁R₂R₃C·CR₃R₂R₁. The four above-mentioned symbols then are reduced to three:

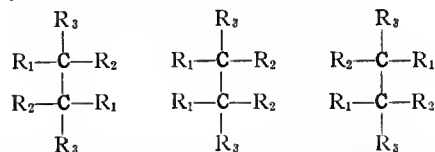

of which the first and last show the enantiomorphism corresponding to the character of optical antipodes, while the second shows symmetry and corresponds to an inactive type. A well-studied example is offered here by tartaric acid; the two antipodes, often denoted as *d* and *l*, have been found, viz. in the ordinary dextrogyre form and the laevogyre form, prepared by Pasteur from racemic acid, while the third corresponds to mesotartaric acid; such internally compensated compounds are generally termed "meso."

3. *Cyclic Compounds.*—Three or more carbon atoms may link together so as to produce ring systems such as

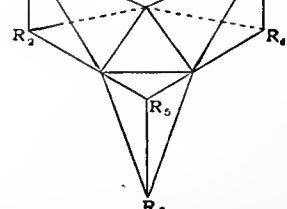
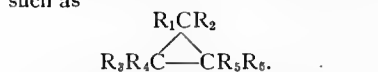
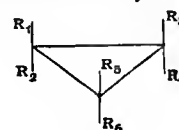

FIG. 4.



It is in these cases that the principle of the asymmetric carbon, which in the above case leads to 2³=8 stereo-isomers, is easily applied by means of graphical representations in a plane, derived from the space relation shown in fig. 4. The six groups, R₁ . . . R₆, are either under

or above the plane in which the carbon ring is supposed to be situated, and this may be indicated by the following symbol:—



where the carbon atoms are supposed half-way between R₁ and R₂, R₃ and R₄, R₅ and R₆.

One of the most simple examples is offered by the trimethylene-dicarboxylic acids

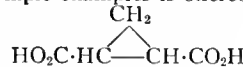

for which three formulae can be deduced:—

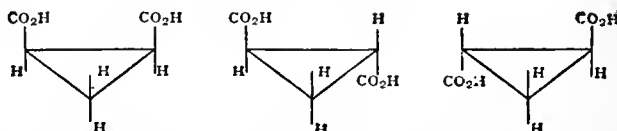

the first, where the carboxyl groups ·CO₂H lie on the same side of the carbon ring, called, as Von Baeyer proposed, the *cis*-form, the others *trans*-forms. The *trans*-forms show enantiomorphism and correspond to optical antipodes, whereas the first symbol may be considered as corresponding to mesotartaric acid, symmetrical in configuration and inactive; this third stereo-isomer has also been met with.

Special attention has been given to those ring systems of the general form:—

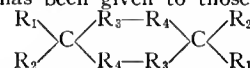

This *trans*-form corresponds to a *cis*-form, where both R₂ and R₁ are on the same side of the plane containing the ring. These latter are enantiomorphous in the ordinary sense of the word, but the particular feature is that the *trans*-form, though offering no plane of symmetry, is yet identical with its mirror image, and thus not enantiomorphous and not corresponding to optical antipodes but to the *meso*-form.

These correspondences have been realized by Emil Fischer in derivatives of alanine; H₃C·CH(NH₂)·CO₂H, which exists in two antipodes *d* and *l*. Two of these molecules can be combined to ananyl-alanine: H₃C·CH·NH(COC·H·NH₂·CH₃)·CO₂H, which, as containing two asymmetric carbons, may be had in four stereo-isomers *dd*, *ll*, *dl* and *ld*. In their anhydrides

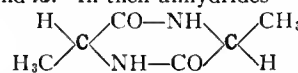

we meet the above type, and find that *dd* and *ll* formed the predicted antipodes, while the anhydride of *dl* and *ld* is one and the same substance, without any optical activity. Such cases are often termed "pseudo-asymmetric."

4. *Isolation of Optical Antipodes.*—The optical antipodes are often found as natural products, as is the case with the ordinary or *d*-tartaric acid; generally only one of the two forms appears, the second form (and, more generally both forms) being obtained synthetically. This is a problem of particular difficulty, since the artificial production of a compound with asymmetric carbon, from another which has no asymmetric carbon, always produces the two antipodes in equal quantity, and these antipodes, by their identity in most properties, e.g. melting and boiling point, solubility, and also on account of their analogous chemical behaviour, cannot be separated by customary methods, the application of which is rendered still more difficult by the formation of a so-called racemic compound.

The method called "spontaneous separation" was first observed by Pasteur with racemic acid, which in its double sodium and ammonium salt crystallized from its aqueous solution in two enantiomorphous forms, which could be separated on examination. One of the two proved to be the ordinary sodium-ammonium-tartrate, the other its laevogyre antipode; thus *l*-tartaric acid was discovered, and racemic acid proved to be a combination of *d*- and *l*-tartaric acid. The further examination of this particular transformation showed that it had a definite temperature limit. Only below 27° is Pasteur's observation corroborated, while above 27° a racemate appears; these changes are due to a chemical action taking place at the given temperature between the solid salts:—

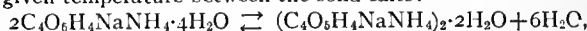

one molecule of the *d*- and one of the *l*-tartrate forming above 27°, the racemate with loss of water, while under 27° the opposite change occurs. This temperature limit, generally called transition-point, was discovered by Van't Hoff and Van Deventer. It is the limit where the possibility of spontaneous separation begins, and is relatively rare, so that this way of separation is an exceptional one, most antipodes forming a racemic compound stable at all temperatures that come into question.

The use of optically active compounds in separating antipodes

7. *Doubly-Linked Carbon Atoms.*—When carbon atoms are doubly linked, as in derivatives of ethylene, $H_2C:CH_2$, the two tetrahedra representing the four groups around each carbon may be supposed to have two summits combined, as was supposed with one in simple linking. Fig. 5 represents this supposition, from which follows that the six atoms in question are situated in a plane and may be represented by a plane figure:—



The chief consequence is that as soon as the two atoms or groups attached to each carbon are different, two stereo-isomers may be looked for:—



Such has been found to be the case, fumaric and maleic acids,

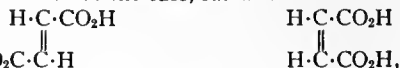

forming the oldest and one of the most simple examples; the simplest is *a*-chlorpropylene ($H_3C)HC:CH$.

The nature of this stereo-isomerism is quite different from that in antipodes. There is no enantiomorphism in the supposed configurations, and so no rotatory power, &c., in the corresponding compounds, which, on the other hand, show differences far deeper than antipodes do, having different melting points, solubility, heat of formation, chemical properties, &c., behaving in these as ordinary isomers. These isomers, having some relation to those in cyclic compounds, may be also denoted as *cis*-(maleic) and *trans*-(fumaric) forms, a close analogy existing indeed in those ring systems of which the simplest type is:—

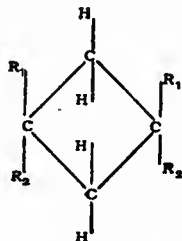

this has been realized in the 1, 3-tetramethylene dicarboxylic acids, which exist in a *trans*- and *cis*-form:—

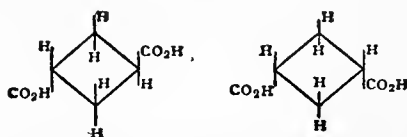

When two double carbon linkings are present, as in $H_2C:C:CH_2$, the four hydrogen atoms form the summits of a tetrahedron according to the development in fig. 4; and consequently the introduction of different groups may bring enantiomorphism and optical antipodes. This has been realized in the compound 1-methyl-*cyclo*-hexylidene-4-acetic acid (formula I.), first prepared by W. H. Perkin and W. J. Pope in 1908, and resolved into its components by fractional crystallization of its brucine salt by Perkin, Pope and Wallach. The substance resolved by W. Marckwald and R. Meth in 1906, which was regarded as this acid, was really the isomeric 1-methyl- Δ^3 -*cyclo*-hexene-4-acetic acid (formula II.), which contains asymmetric carbon atoms (see *Journ. Chem. Soc.*, 1909, 95, p. 1791; cf. *ibid.*, 1910, 97, p. 486).

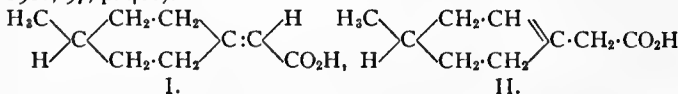

8. *Numerical Value of Optical Rotation.*—To express the value of optical rotation either specific or molecular rotation may be chosen, the first being the deviation caused by a layer of 1 decimetre in length when the substance in question is supposed to be present with specific gravity 1, the latter is this value multiplied by one-hundredth of the molecular weight. Specific rotation is indicated by $[\alpha]_D^t$, where the suffix indicates the wave-length of the light in question, D being that of the sodium line, and *t* the temperature; $[M]_D^t$ is the corresponding value of molecular rotation. Both values vary with the solvent used, and probably are most adapted to solve problems touching relations of rotatory power and configuration, when they apply to extreme dilution in the same liquid.

One of the most general rules, relating to rotatory power, is that for electrolytes, *i.e.* salts in aqueous solution, *viz.* the limiting rotation in dilute solution only depends on the active radicle. Oudemans found that for such active bases as quinine in its salts with hydro-

chloric, nitric, chloric, acetic, formic, sulphuric, oxalic, phosphoric, perchloric acids the specific rotation (calculated for the base) only varies from -272° to -288° ; H. H. Landolt found the same thing for active acids, the mono lithium, sodium, potassium and ammonium tartrates varying only between 27.5° and 28.5° (calculated for the acid). A corresponding rule may be expected where both base and acid have rotatory power; the molecular rotation will be the sum of those for base and acid in salts with inactive radicles. Each of these rules finds sufficient explanation in Arrhenius's view of electrolytic dissociation, which admits that diluted electrolytes are split up in their ions, and so the salts of quinine (Q) owe their

rotatory power to the ion QH^+ , those of acid tartrates to the ion $C_4H_2O_6$, and quinine-tartrate to both.

With non-electrolytes relations are less evident. One general observation is that non-saturation, especially cyclic structure, augments rotatory power. The saturated compounds, hydrocarbons, alcohols, ethers, amines and acids rarely show specific rotations higher than 10° , and some of them, as mannite, $CH_2OH(CHOH)_4CH_2OH$, for instance, show such small values that only a more thorough investigation, due to the theoretical probability of rotatory powers in asymmetric natural products, has detected the optical activity.

Unsaturated compounds generally show larger rotative powers; amyl alcohol with -5° produces an aldehyde with 15° ; succinic (diamyl) ether with 9° produces fumaric ether with 15° , &c. Cyclic configuration especially leads to the highest values known: the lactic acid with 3° leads to a lactone with -86° ,

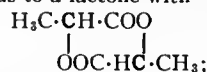

mannosaccharic acid, $HO_2C(CHOH)_4CO_2H$, to a dilactone (with two rings, formed by the loss of two molecules of water) with 202° , whereas the original acid only shows a small rotation.

A second conception, which connects rotation with configuration in non-electrolytes, is due to Alexander Crum Brown and P. A. Guye. It starts from the simple assumption that, as rotatory power is due to the difference of the four groups around the asymmetric carbon, so its amount may correspond to the amount in this. So, generally speaking, take some property, denoted by K_1, \dots, K_4 respectively, a function:—

$$(K_1 - K_2) (K_1 - K_3) (K_1 - K_4) (K_2 - K_3) (K_2 - K_4) (K_3 - K_4)$$

would express what is wanted. It becomes zero when two groups are equal; it changes its sign, retaining its value, when K_1 is interchanged with K_2 , &c. The chief difficulty in application is to point out that property which is here dominating. It has been supposed to be weight, and then the above expression divided by $(K_1 + K_2 + K_3 + K_4)^6$ might be proportional to specific rotation. This explains, for instance, that in the homologous series of glyceric

ethers $HO \begin{array}{c} \diagup \\ \diagdown \end{array} \begin{array}{c} CH_2OH \\ CO_2R \end{array}$, augmenting the heaviest group, $\cdot CO_2R$, first

augments the specific rotation, which then passes through a minimum (the theoretical limit being zero):—

Ether of methyl, ethyl, propyl, butyl, hexyl, octyl,

$$[\alpha]_D = -4.8^\circ, -9.2^\circ, -12.9^\circ, -13.2^\circ, -11.3^\circ, -10.2^\circ.$$

But the serious objection is met that groups of equal weight and different structure often allow considerable rotatory power as in methyl acetylammogdalate, with -146° , though in the formula $C_6H_5HC(OC_2H_5O)(CO_2CH_3)$ the third and fourth groups are of equal weight. It is in this way especially that other properties might be tested, such as volume or density, and perhaps qualities related to light, such as refractive power and the dielectric constant. Attempts to connect the rotatory power of a compound with more asymmetric carbons to the action of each of these separately, *i.e.* by the so-called optical superposition have not been very successful. In the four stereo-isomeric acids $CO_2H(CHOH)_3CH_2OH$ of the following configurations

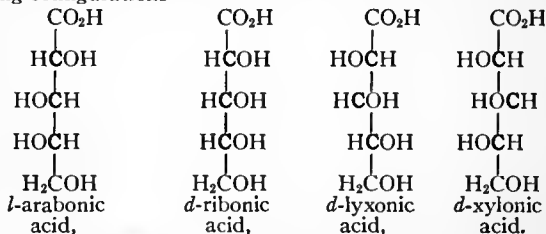

We might suppose the upper asymmetric carbon to produce a rotation $+A$ or $-A$, the other $\neq B$ and $\neq C$. The rotations then were $A - B - C, A + B + C, -A - B + C$ and $-A + B - C$ or zero in total. This supposition is in so far related to that of Crum Brown and Guye that it admits that the smallest conceivable change, *i.e.* stereo-isomeric change, in one group does not influence the rotation caused by the asymmetric carbon attached to it. It has not been tested in this case, but substances as propyl- and isopropyl-glycerate only differ in specific rotation from -12.9° to

-11.8°, and might prove identical in the same solvent; the sharpest test might be afforded by propylisopropylacetic acid.

9. *Steric Hindrance*.—The difference in the relative positions of atoms not only explains the different behaviour of optical antipodes, as has been indicated, but also gives some indication where no optical activity is concerned.

In the stereo-isomerism of ethylene compounds, taking maleic and fumaric acid as examples, space relations chiefly indicate that in one of the two the carboxyl groups CO₂H are nearer. Such seems indeed to characterize maleic acid. It easily gives an an-

hydride of the cyclic formula $\begin{array}{c} \text{HC}-\text{CO} \\ \parallel \quad \diagup \\ \text{HC}-\text{CO} \quad \text{O} \end{array}$ and, inversely, when cyclic

compounds such as benzene are broken down by oxidizing agents, it is maleic and not fumaric acid that appears. On the other hand the presence of the two negative carboxyls makes maleic acid the stronger acid but less stable, with a pronounced tendency to change over into fumaric acid; this goes hand in hand, according to a general rule, with smaller heat of formation, lower melting point and increased solubility.

In the cyclic compounds analogous phenomena occur. The formation of lactones, *i.e.* cyclic anhydrides derived from oxy-acids by interaction of hydroxyl and carboxyl, presents one of them. In the oxy-acids of the fatty series a particular feature is that from the isomers, denoted as α , β and γ , &c. HO₂C·CHOH(CH₂)_nCH₃, HO₂C·CH₂·CHOH·C(H₂)_{n-1}CH₃, HO₂C·(CH₂)₂·CHOH(CH₂)_{n-2}CH₃, &c., the γ -compounds most easily form a lactone, though in the α -series carboxyl and hydroxyl run nearer. The tetrahedral arrangement, however, as shown in fig. 6, explains that A, one of the groups attached to the carbon atom C₁, is fairly near C₅, one of the groups attached to the carbon atom C₄ (the angle A being 35°); A would correspond to the hydroxyl forming part of carboxyl around C₁; C₅ to the hydroxyl linked with the carbon atom in the γ -position.

A third consideration on analogous ground is that of "steric hindrance." It was introduced by Victor Meyer's discovery that derivatives of benzoic acid, having two substituents (X and Y) in the immediate neighbourhood of carboxyl:—



FIG. 6.

are unable to form ethers in the ordinary way, by treating with methyl alcohol and hydrochloric acid, whereas the isomers having only one of the substituents Y in 4 (X in 6) readily do; it was suggested that the presence of X and Y near CO₂H prevented the access to the latter. This argument has not been completely established, but a large amount of quantitative corroboration has been brought together by N. A. Menshutkin, who has found that in alcohols the more the hydroxyl group is surrounded by substituents (for instance CH₃) the slower esterification (with acetic anhydride in acetone at 100°) takes place, the ratio of rates being

Methyl alcohol	H ₃ C·OH	. . .	100
Ethyl alcohol	H ₃ C·CH ₂ ·OH	. . .	48
Dimethyl carbinol	(H ₃ C) ₂ CH·OH	. . .	14
Trimethyl carbinol	(H ₃ C) ₃ C·OH	. . .	0.8

Stereo-isomerism in Other Elements.

Phenomena analogous to those observed in carbon compounds might also exist in derivatives of other quadrivalent elements; and only the relative stability of carbon-compounds makes every form of isomer, which often is unstable, more easily obtainable in organic chemistry. Nevertheless it has been possible to obtain stereo-isomers with different elements, but, as expected from the above, especially in derivatives containing carbon. Some of them have the character of optical antipodes and are more easily considered from a theoretical point of view; others have not.

1. *Optically Active Stereo-isomers*.—Most closely related to the phenomena with carbon are those with sulphur, selenium, tin and silicon, when these elements behave as quadrivalent. S. Smiles (*Journ. Chem. Soc.*, 1900, 77, pp. 1072, 1174; 1905, 87, p. 450) split up such derivatives of methylethyl-thetine as

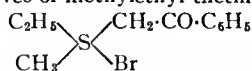

obtained by condensing methylethyl sulphide with ω -bromacetophenone, by means of the salt with *d*-bromocamphosphonic acid, into optical antipodes.

W. J. Pope and A. Neville (*Journ. Chem. Soc.*, 1902, 18, p. 198) succeeded in the same way with a selenium compound

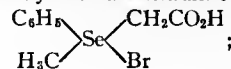

W. J. Pope and S. J. Peachey (*Journ. Chem. Soc.*, 1900, 16, pp. 42, 116) with a compound of tin (tin methylethylpropyl iodide)

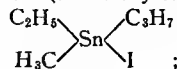

Kipping (*Journ. Chem. Soc.*, 1904, 20, p. 15; 1907, 23, p. 9) with one of silicon (benzylethylpropyl silicol)

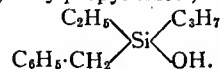

These facts may be explained in the same way as with carbon, by admitting tetrahedral grouping. A special feature, however, wanting with carbon, is that compounds with one atom only of the element in question have been obtained as antipodes. A second observation of some interest is that the compounds in question are electrolytes and that, as in solutions, where they are split up into ions, activity must be due to the last, the ionic complex, for instance, R₁R₂R₃S, must cause optical rotation.

Optical antipodes have also been obtained with quinquevalent nitrogen in compounds of the type: R₁R₂R₃R₄NR₅. Le Bel observed these in methylethylpropyl-isobutylammonium chloride; since then Pope and Peachey and Wedekind studied the same question more thoroughly, and as a general result it is now stated that ammonium compounds with four different radicals behave as asymmetric carbon compounds. The explanation may be that the four radicals arrange themselves in the two possible tetrahedral configurations, and that the fifth element or group, *e.g.* chlorine or hydroxyl, more loosely linked, finds its fittest place, as shown in figs. 7 and 8.

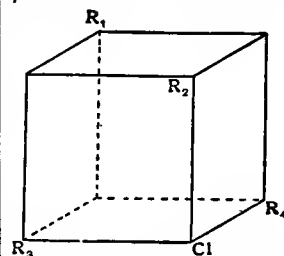

FIG. 7.

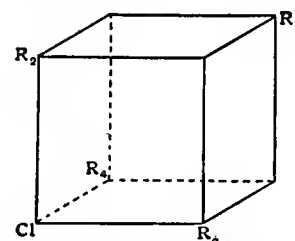
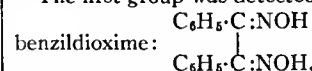

FIG. 8.

2. *Stereo-isomers Without Optical Activity*.—The chief cases here belong to the derivatives of nitrogen with double linking and the metallic compounds which have been chiefly studied by Werner.

The nitrogen compounds showing stereo-isomerism belong to two classes, according to the structural formulae, containing C:N or N:N; in their general behaviour they seem related to the ethylene derivatives.

The first group was detected by Victor Meyer and Goldschmidt in



Later investigations, especially by Hantzsch, showed that a grouping



gives rise to stereo-isomerism, the supposed difference being that X is either more close to R₁ or to R₂. This peculiarity is observed in the aldoximes and ketoximes, derived from aldehydes and ketones on treatment with hydroxylamine, and the two simplest examples are ethyl-aldoxime H₃C·CH:NOH, and phenyl-benzyl-ketoxime, (C₆H₅)₂C·CH:NOH. As the behaviour of these stereo-isomers much resembles that of ethylene-compounds, they are often indicated as *cis*- and *trans*-forms.

The second stereo-isomerism in nitrogen-compounds was detected by Schraube in potassium benzenediazotate, and may perhaps be reproduced by the following symbols:—

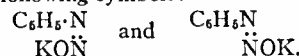

The last group of stereo-isomers, in which insight is most difficult yet, is that of Werner's complex metallic compounds, observed with cobalt, platinum and chromium. No enantiomorphous character throws light here, and there is no relation to ethylene derivatives.

With cobalt the fact is that in the hexammine cobalt salts, *e.g.* Co(NH₃)₆Cl₃, when NH₃Cl is substituted by NO₂ isomerism appears as soon as the number of substituents is two; Jørgensen's flavo-salts Co(NH₃)₄(NO₂)₂Cl, and Gibbs's isomeric croceo-salts offer examples. Werner puts forward that a grouping of (NH₃)₆ at the summits of a regular octahedron around Co may explain this.

Platinum compounds such as $(\text{H}_3\text{N})_2\text{PtCl}_2$ have been obtained in two forms, Werner admitting here the following plane configurations:—

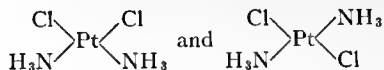

Chromium shows a behaviour analogous to that of cobalt, and analogous space-formulae may be used here. But, in a general way, at present it is extremely difficult to decide upon their value.

BIBLIOGRAPHY.—The standard authority is C. A. Bischoff and P. Walden, *Handbuch der Stereochemie* (1894), with the two supplementary volumes (by Bischoff) entitled *Materialien der Stereochemie* (1904), containing abstracts of papers up to 1902. A. W. Stewart, *Stereochemistry* (1908), is a comprehensive survey. The views of A. Hantzsch and A. Werner are developed in Hantzsch, *Grundriss der Stereochemie* (1904), and Werner, *Lehrbuch der Stereochemie* (1904). Other works are: H. Landolt, *Optische Drehungsvermögen* (2nd ed., 1898); Eng. trans. *Optical Activity and Chemical Composition* (1900); J. H. van't Hoff, with a preface by J. Wislicenus, *Die Lagerung der Atome im Raume* (3rd ed., 1908), Eng. trans. (with an appendix by Werner dealing with stereo-isomerism among other elements) by A. Eiloart, entitled *The Arrangement of Atoms in Space* (1898); J. B. Cohen, *Organic Chemistry* (1907), pp. 56–171. Pamphlets, &c., dealing with special subjects, are W. van Ryn, *Die Stereochemie des Stickstoffs* (1897); E. Wedekind and Fröhlich, *Zur Stereochemie des fünfwerthigen Stickstoffs* (1907); Jones, "The Stereochemistry of Nitrogen," *Brit. Assoc. Rep.* (1903); M. E. Scholtz, "Die optisch-aktiven Verbindungen des Schwefels, Selen, Zinns, Silizium und Stickstoffs," *Ahrens' Sammlung* (1898, 1907); A. Ladenburg, "Über Racemie," *Ahrens' Sammlung* (1903); Meyerhoffer, *Gleichgewichte der Stereoisomeren* (1907); lectures delivered by Walden and Werner in the German Chemical Society (*Ber.*, 1905, 38, p. 345; 1907, 40, p. 15). For the stereo-isomerism exhibited by amino compounds see COBALT and PLATINUM; also Werner, *Ann.*, 1910, 375, p. 1. Recent progress is reported in *The Annual Reports of the Chemical Society* (annual since 1904). (J. H. VAN'T H.)

STEREOSCOPE (Gr. *στερεός*, solid, *σκοπεῖν*, to see).¹ The fundamental property of stereoscopic vision, or simultaneous vision with both eyes, is the direct perception of the relative distances of near objects.

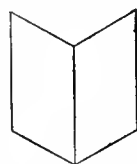

FIG. 1.

Of course, ideas of the different distances of objects also occur in vision with a single eye, but these are the result of other experiences and considerations. These representations are also not always unequivocal (see fig. 1). For instance they may arise from the former knowledge of the shape and size of a distant object, from the partial covering of one object by another; and they very often occur where stereoscopic observation fails; this latter is involuntary, *i.e.* the observer is unconscious of it. We will now investigate the conditions necessary for the perception of depth.

If the head is held still only one portion of space can be observed stereoscopically. The single eye, when moved, surveys, including indirect vision, a field which measures 180° in a horizontal direction, and 135° in a vertical direction. The two fields overlap and a smaller conical space is formed, with the nose as vertex (B V S in fig. 2), in which both eyes can see simultaneously; and outside this space stereoscopic vision is impossible. The shape and size of this space are very different in men and animals. According to Armin Tschermak the horizontal extent of the space surveyed with both eyes is only 34° in a rabbit as compared with 90° in man, 15° in a fowl and about 5° in a carp (measured in water). There is a further difference between the eyes of men and animals. The optic axis of the eye is the line joining the centres of the curves, but the direction in which the eye can see most clearly does not always coincide with this, being determined by the spot on the retina which is most susceptible to light, the so-called yellow spot (*Fovea*, F in fig. 2). In man this spot is still near the axis, although not always exactly on it. It is not perfectly known how it is situated in animals, but in many the axes of the eyes diverge (especially strongly in geese), and the portions of the retina utilized in stereoscopic vision lie far distant from the axis, as in many animals the eyes are only slightly movable.

Every time that the eyes are directed on one spot (P in

¹ The subject of stereoscopy has been extensively developed by the author of this article, who, curiously enough, having lost the sight of one eye through an accident, could no more enjoy the beauties of stereoscopic sight.—Ed.

fig. 2) this point is seen simply, together with a number of other points which together form the so-called "horopter." According to Joh. Müller, Helmholtz, Hering, Volkmann and others, these are those points of the object-space (*e.g.* Q and R in fig. 2), whose images fall on *identical* or corresponding spots on the retina, by which are meant those points on the retina whose *nerve filaments* are united and which are equidistant in the same direction from the centre of the yellow spot (see EYE; VISION). The horopter varies according to the position of the fixed spot in the object-space; for example, it is the ground

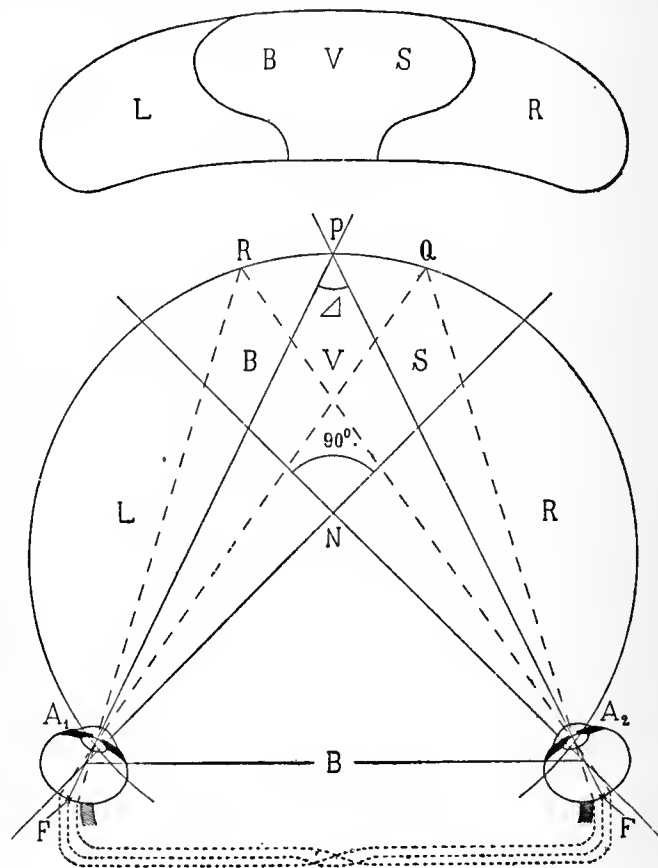

FIG. 2.

itself for a man standing erect and looking straight ahead. All object-points situated outside the horopter fall on points of the retina which are not identical, but the two images are only seen as real double images in exceptional cases. As a rule the effect is that these points are also seen simply, but at other distances than that of the fixed point P. The differences of the images arise in the moving of the image-points in the direction of the connecting line of the two eyes. For this reason the eyes cannot recognize the space between parallel shining telegraph wires if the connecting line of the two eyes be parallel to the wires, whilst the perception of the depth occurs involuntarily if the connecting line of the eyes is more or less perpendicular to the wires. These differences of images which have been mentioned are therefore necessary and are sufficient for the perception of depth. The explanation that the perception of depth was due to a difference between the two retinal images was first given by Ch. Wheatstone in 1833; but it was contradicted by E. Brücke (1841), Sir David Brewster (1843) and others, who stated that when observing an object the angle of convergence of the axes of the eyes continually changed, and through this and also by the exertion of the muscles and the accommodation of the eye there was a simultaneous touching of the object, which gave rise to the perception of its depth. This latter theory, however, was contradicted by H. W. Dove, who showed that a stereoscopic viewing was also possible with momentary illumination of the object; and still less does it agree with the

fact, to which Wheatstone first called attention, that facsimiles also have a stereoscopic influence, in spite of the fact that the images retain their position on the retina unchanged. Numerous experiments show the same result, and it follows that even a change of the angle of convergence is not always observed as a change of depth.

There are two kinds of stereoscopic vision, direct and indirect, according to whether the point seen indirectly, *e.g.* H in fig. 3, is compared with the fixed point P, or with another point seen indirectly, *e.g.* J in fig. 3. In both kinds of stereoscopic vision the exactness of the observation of the depth is greater as the point J approaches H, and the point H approaches P. As a matter of fact a man's eyes are naturally never perfectly still. They move in their sockets, and the point P, where the axes intersect, is continually changing. Direct stereoscopic vision arises from indirect stereoscopic vision and vice versa, and the accuracy of the discernment of the depth increases and decreases. As in this the eye does not revolve round its lens but round the centre of the sphere situated 10 mm.

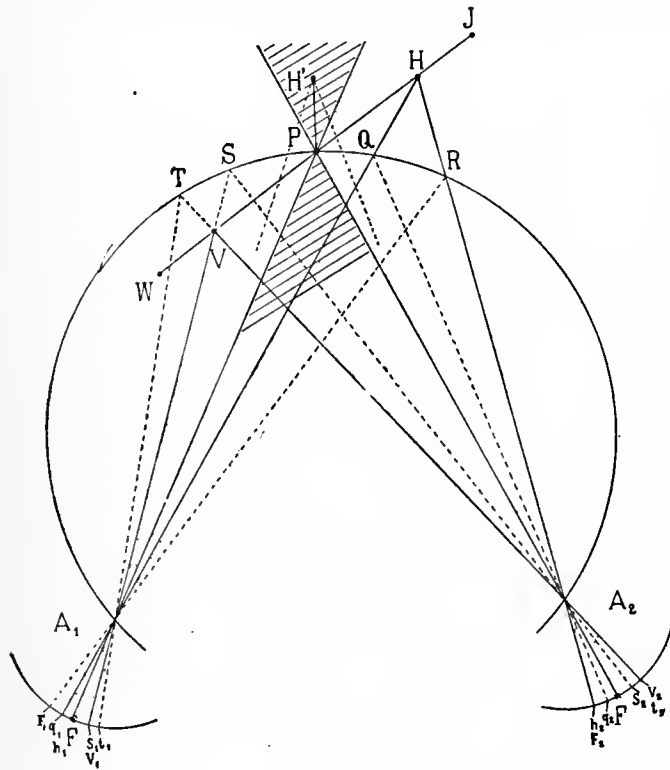

FIG. 3.

behind it, the entrance-pupil of the eye moves slightly to and fro and up and down, and many experiments have been made to produce a perception of depth for a single eye from the relative movements of the images consequent on this motion. As these movements of the images only occur in indirect vision, it can be understood they are not seen by most people. This, however, cannot be regarded as an actual perception of depth, because these viewings necessitate a consideration for each individual interpretation, which is quite foreign to stereoscopic vision.

Indirect stereoscopic vision is of great importance. It makes it possible to recognize any sudden danger or obstacle outside the direction in which one is looking. Even with the stereotelemeter (see below) the position of the range through which, for example, a bird flies, could not always be accurately given, if one were solely dependent upon direct stereoscopic vision. If the attention and eyes are directed upon a certain object, as, for instance, in manual labour and in measuring the image-space with the so-called "travelling mark" on the stereocomparator, then direct stereoscopic vision only is concerned.

Stereoscopic vision is in many ways similar to the monocular observation of a preparation under the microscope, and yet

there is a great difference. In an unchanged focused microscope it cannot be distinguished which of the indistinct objects are above and which are below the plane focused for. In stereoscopic vision, however, this can be seen directly. How does this happen? Why does the point H in fig. 3 appear behind and the point V in front of the point P when both eyes are fixed on the point P?

As is shown in fig. 3 the image-points on both sides lie further apart for H or nearer together for V than the image-points for P, and for all the points on the horopter (Q, R, S, T &c.), whether the points H and V are situated inside or outside the horopter. In other words, if the point H be formed in the object-space by the moving of the related points Q (or R) towards H, then a movement of the image-point takes place in the right eye (or the left), in both eyes in the direction of the nose, so long as the point H is outside the horopter. On the contrary an external movement of the image-point, *i.e.* towards the temples, takes place when the points S and T are substituted by the point V situated inside the horopter. This differentiation of the retinal images of the points H and V respectively inside and outside the horopter must suffice, and the question as to how the idea of space is conveyed to the brain is a physiological and psychological subject.

If the images of the line PH in both eyes (or of the line PV) are very different in length, the double images of the point H (or V) are seen without great attention. But the stereoscopic effects are in these cases always the same as before. There is, however, an exception in which the observer sees only two images and in which stereoscopic observation is completely excluded. This exception is important because it occurs in the space in the immediate proximity of P. If for example the second point (H' in fig. 3) is situated behind or in front of the point P, so that it falls between the two optic axes, or on one of them, then only double images can be seen, either of P or of H', according to whether the optic axis cuts at P or H', or double images of both points if the optic axes intersect at any other point of the line PH', but the representation of the difference of depth of the two points P and H' is never obtained.

This fact can be easily realized if a stick, *e.g.* a lead pencil, be held before the eyes of an observer with good stereoscopic sight so that its lengthwise axis falls exactly on a point between the eyes or in the middle of one of the two eyes. The double images can be seen still more clearly if two small balls on thin threads are suspended behind one another so that their connecting line retains the position mentioned above. In this experiment it can be seen directly how inconvenient these double images are to the observer. He involuntarily tries to evade them by moving the head. The reason for this is that, when P (or H') is fixed, the images of H' (or P) are always separated from one another by the centre of the yellow spot. The distances of the two images from the yellow spot have consequently opposite signs, whilst for all other objects (*e.g.* H) which lie outside the two axes the distances have the same signs. The difference of the sign is, however, not alone decisive, for if the connecting line PH' is moved a little higher or lower out of the plane PPF the signs remain different, but the stereoscopic effect is immediately regained. Therefore in all cases in which the connecting line PH' is seen with one eye as a point and with the other as a line, or with both eyes as a line, but from two diametrically opposite sides, there is no stereoscopic effect, but double images are seen; and that for stereoscopic observation it is essential to see the connecting line PH' with both eyes simultaneously from one and the same side, from above or below, from the left or the right. This condition is provided for in the stereotelemeter by the arrangement of a zigzag measuring scale, so that the connecting-line of the marks slightly ascends. Care must be taken when using this instrument (as also when using any stereoscopic measuring instrument) that the index hangs close to or above the object to be measured, so that the latter is only touched and in no way covered by the mark.

The power of perception of depth in man is most accurate. This has been ascertained by the approximately equal keenness of vision of all normal-sighted people and by the interpupillary distance. The angle which serves as a measure for the keenness of vision is that under which appear two neighbouring points of the object-space which are still seen by the single eye as a double point; according to the older experiments of Helmholtz, this angle is about $1'$. When measured on the retina the keenness of vision is determined by the diameter of the nerve filaments situated in straight rows close to one another in the fovea (fig. 4). The diameter of these filaments amounts to roughly 0.005 mm., or in angular measure $1'$. More recent experiments for keenness of vision and power of perception of depth have given considerably higher values (Wülfing, Pulfrich, Heine and others); thus Pulfrich in 1899, when first introducing

stereoscopic instruments for measuring distance, proved that as a rule persons with normal eyes have a power of perception of depth of 10" and still less in unrestricted vision. This is explained as follows (Hering, Heine):—

It is unimportant for perception where the filament mentioned above is illuminated. In order to see two objects lying close to one another it is not essential that the two image-points should be separated from one another by the distance of the two nerve filaments of the eyes. This happens whenever the line separating two objects passes through the two points (see fig. 4). It is natural that the perception of depth has no fixed limits, for the position of the images shown in fig. 4 changes with the movement of the eyeball, and the closer the two points are to one another, the more

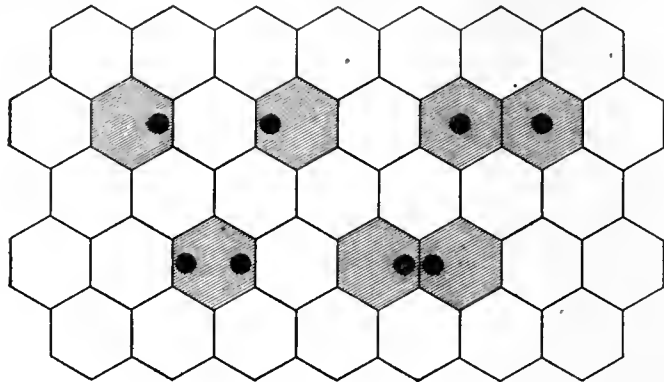

FIG. 4.

rarely it occurs. If the angle of convergence of the optic axes Δ , the (average) distance between the eyes $B=65$ mm., $\delta=\frac{1}{2}$ ' relatively $=1:7000$ (the perception of depth easily attained by normal sight) and E =the normal distance of the point P from B in fig. 2, then from $E=B/\Delta$, the change of depth dE gives:—

$$dE = B \cdot \delta / \Delta^2 = E \cdot \delta / \Delta = E^2 \cdot \delta / B.$$

If the angle Δ has the value δ then all perception of depth ceases. At this distance objects are only still distinguishable from those lying behind them, which together form a surface but cannot always be seen as a surface because our representations of the depths of distant objects are not conclusively controlled by stereoscopic sight. This distance is called the radius of the stereoscopic field, and is calculated by the formula $R=B/\delta$, whence $R=450$ metres. From the above formulae it can be directly seen that the variation dE increases with E^2 , and the proportional variation dE/E increases with E . The numerical values can be easily calculated when either Δ or E is given thus:

$$dE/E = \delta/\Delta \text{ or } dE/E = E/R.$$

The limits of stereoscopic vision defined above can be extended and under the name of "stereoscope" every binocular instrument is included which serves this end. Those instruments should first be mentioned which have restored the more or less lost power of stereoscopic vision. It is necessary for those with normal sight to wear spectacles when the eyes cease to accommodate themselves to objects near at hand. Spectacles which only cover the lower half of the eye and leave the upper

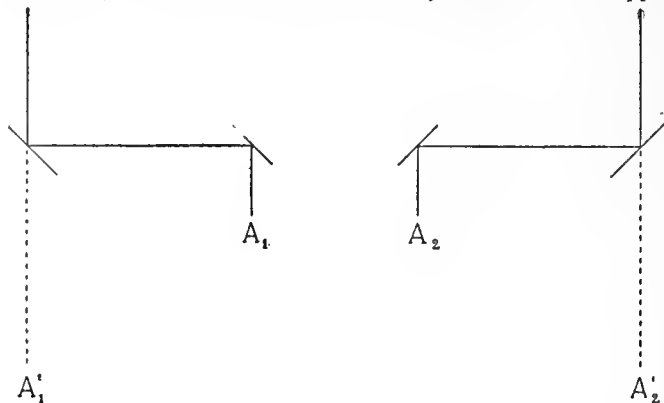

FIG. 5.

half free to look out into space are the best. For those who have been operated on for cataract, and for excessively shortsighted persons, the "telescope-spectacles" devised by M. v. Rohr (of Zeiss, Jena) are a great assistance. There are two

methods of extending the limits of stereoscopic vision and of increasing the accuracy of the perception of depth. (1) by augmenting the keenness of sight by the aid of a telescope or microscope, and (2) by increasing the interpupillary distance by several reflections after the plan shown by Helmholtz in his mirror stereoscope (1857) (see fig. 5). When binocular telescopes and microscopes are used, erect images are formed when the two instruments are contiguous. If this is not the case, the order of depth is reversed and the same false or pseudo-images are formed as when the pictures in a stereoscopic view are interchanged or a correctly combined stereoscopic picture is observed in a so-called pseudo-stereoscope. If, however, in this case the axes of both instruments intersect in front of the eyes, then reversed pictures are obtained, but the correct order of depth is recovered.

Telescope magnification (m times) and base magnification (n times) bring the radius R of the stereoscopic field to m or n times respectively the value above given, and if both are simultaneously active to mn times. The errors for a certain distance E are accordingly reduced to $1/mn$. Of course these expedients do not increase the capability of the observer, but the values of the convergence angle Δ and δ in the object-space are different. It is therefore quite natural that the three-dimensional images, which appear in the binocular vision-space of the observer, vary with reference to their dimensions and the distance of the separate parts from each other. In this respect the action of the base magnification is fundamentally different from that of the telescope magnification. Both bring the objects m or n times respectively nearer to the observer, but in the first case the areal dimensions are diminished in the same proportion as the distances are lessened, whilst in the other case the real dimensions remain unchanged. In the first case the three-dimensional image is a model proportionately diminished in all its dimensions and brought nearer to the observer: in the other case the objects appear pushed together to the front like the wings of a theatre. The remark made in Helmholtz's *Physiological Optics* that when $m=n$ the three-dimensional image would look like the object seen without any instrument at a distance of $1/n$ is consequently not correct. What is remarkable is that this observation, to which as a so-called "Helmholtz rule" great importance was for a long while attached, and to a certain extent still is, does not correctly express the views of Helmholtz, which he states very clearly in his earlier essay on the tele-stereoscope, and which agree with the explanation here given.

Spectacles and binocular telescopes were the first binocular instruments (see BINOCULAR INSTRUMENTS). The latter with chromatic lenses had already been constructed in the 17th and 18th centuries. The Dutch double-telescope (opera glasses), which were almost exclusively used up to the 'nineties of the 19th century, were introduced in the 'thirties by Fr. Voigtländer. The binocular microscope appeared in the early 'fifties. The introduction of the Porro prism (four reflections with reversion of the picture and lateral transposition of the rays) by Abbe in 1893 was of great importance for the binocular telescope and microscope. It led to the construction of the prism field-glasses and other telescopes which, in comparison with the Galileo binocular telescopes till then in use, not only had a considerably increased perception of depth but also a substantially larger field of vision. Similarly by inserting the Porro inverting system between the eyepiece and the objective, the binocular microscope constructed by H. S. Greenough and S. Czapski was produced. Recently binocular glasses (after Fritsch and Zeiss) have come into use for slight magnifications, in which, following the example given by Wenham (1853), the interpupillary distance and the angle of convergence are diminished by four reflections (the course of the rays reversed as in fig. 5).

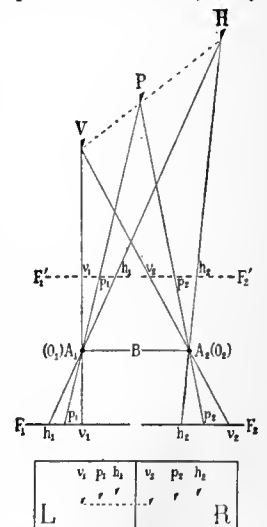

FIG. 6.

All of the instruments mentioned above are used exclusively for the observation of three-dimensional objects with two eyes. Wheatstone (1838) first showed that the same spatial impression could be produced by two views of the object taken

from two different points and he called the instrument a stereoscope. Let us imagine in fig. 6 a plane $F_1' F_2'$ between the two eyes A_1 and A_2 and the points P, H and V in the object-space, and on this plane the perspective projections of P, H and V produced towards A_1 and A_2 —as, for example, by photographing on the plates F_1 and F_2 with objectives O_1 and O_2 at A_1 and A_2 —then the object can be taken away and we obtain from the projections the same spatial effect as when observing the object itself. The change of accommodation of the eye which, however, has no influence on the power of perception of depth, is excluded, and a further difference (according to I. I. Opperl, 1854) is that in unrestricted vision the image-points not situated on the yellow spot undergo slight displacement in consequence of the difference of the position of the pupil and of the centre of rotation of the eye, which is taken as the centre of projection. This can in no way be imitated in the pictures. In order to obtain a stereoscopic effect from such pictures apparatus is not always necessary. When the pictures L and R in fig. 6 are at a distance equal to that of distinct vision, the stereoscopic effect can be obtained by observing them when the optic axes of the eyes are parallel, and if the pictures are interchanged, when the axes intersect. The second of these methods, which were discovered by Wheatstone, was later widely used for the stereoscopic observation of large wall pictures.

The 1852 model of the Wheatstone stereoscope is shown diagrammatically in fig. 7. This differs from the original model in that the pictures L and R can be placed at different inclinations to the mirrors s_1 and s_2 and at different distances from them in order to observe the pictures under exactly the same inclination of the image and the same angle of convergence as when the picture was taken. Photographs with a large base line and converging axes were then often taken (in Germany first by L. Moser). This mirror stereoscope had no practical result worth mentioning on account of its awkward shape and of the difficulty in obtaining equal illumination of both pictures. It was also inconvenient that the pictures had to be placed separately and reversed in the apparatus. These difficulties are for the greater part avoided in the L. Pigeon

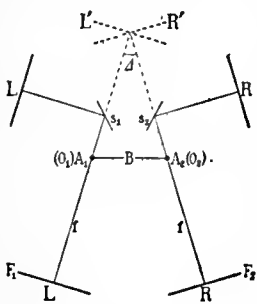

FIG. 7.

(Nancy, 1905) new mirror-stereoscope for large pictures, which can be purchased in book form. Fig. 8 shows diagrammatically the arrangement by which one picture is seen direct and the other in a mirror (H. W. Dove, Sir David Brewster and W. Rollmann). The disadvantage attached to this, that the picture observed in the mirror must be reversed, can according to Pulfrich¹ be obviated by rotating the correct picture through 180° in its own plane and placing it in the position of the picture L and by using a so-called roof-prism in the place of the mirror.

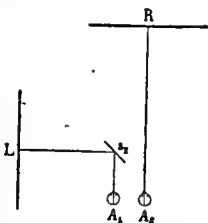

FIG. 8.

Incorrect stereoscopic effects easily arise when using pictures. If for instance the distance of a picture from the centre of projection is different at the time of observation from what it was when the photograph was taken (see fig. 9), objects appear to be either too much in relief or too flat even in monocular vision, just as when looking first through the objective of a telescope and then through the eyepiece. An excellent example is provided by the stereoscopic observation of the moon, first performed by Warren de la Rue (1858) to show that the three-dimensional image is modified by altering the angle of convergence and by placing the pictures obliquely. If the pictures obtained with converging axes are placed further apart on the same plane, the stereoscopic image of the moon has the shape of an egg; this, however, immediately disappears and changes into an approximate sphere, if the picture be broken in the middle and both sides bent back. If the pictures are observed, as by Warren de la Rue, in a Wheatstone stereoscope under exactly the same conditions as when the photographs were taken, the impression of a sphere is obtained.

M. von Rohr (*Die binocularen Instrumente*, 1907) drew attention to the optics of the older stereoscopists and in particular to the works of Wheatstone, and it is to be regretted that so

¹ This fact is published here for the first time.

little notice was taken of these older works during the recent development of most binocular instruments. It would, however, be erroneous to demand that the above-mentioned conditions for the observation of three-dimensional images should always be considered. This is impossible, for example, in the stereocomparator in which the three-dimensional image is only seen in portions, and never all at once. Neither does it concern stereoscopic measuring instruments, and it is a curious coincidence that the stereo-planigraph (see fig. 15) constructed after Wheatstone's stereoscope, and correct as to the so-called orthomorphy of the three-dimensional image, was of no use as a measuring instrument.

A lens-stereoscope invented in 1849 by Sir David Brewster and constructed by J. Dubosq is very largely used. The causes of its success were its convenient form and the fact that a series of adjusted stereoscopic pictures (landscapes, machines,

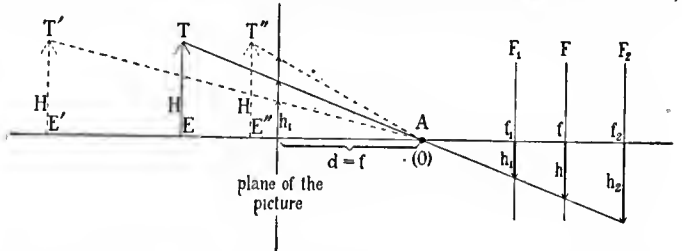

FIG. 9.

&c.) could be observed in rapid succession. The Brewster stereoscope, by making an easy observation of stereoscopic pictures possible when the distance between identical points on both pictures was considerably greater than that between the observer's eyes, supported to a certain extent the inclination of photographers not to detract from the pictures. If the lenses shown in fig. 10, on the focal plane of which the stereoscopic image is formed, are large enough, and the distance between the image-points h_1 and h_2 is not greater than the distance between the centres of the two lenses (avoiding the divergence of the axes of the eyes), then the distance between the eyes is secondary and the observer sees the distant points with the axes of the eyes parallel. These apparent advantages, however, are counteracted by the defect that the picture seen through the lenses is eccentric, and consequently an incorrect impression of the picture is obtained, and an alteration in the three-dimensional image occurs.

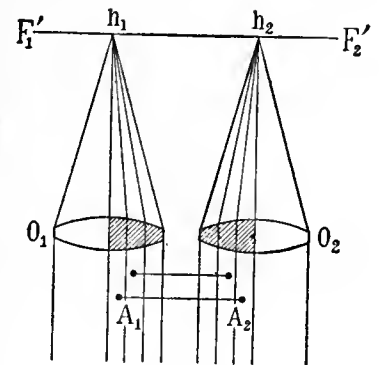

FIG. 10.

Wheatstone showed later in his controversy with Brewster that this disadvantage in the lens-stereoscope could be avoided by

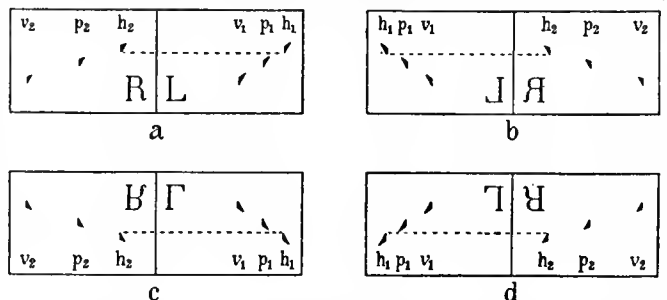

FIG. 11.

adjusting the lenses and distant points to the distance between the observer's eyes. This same condition was fulfilled in the "double-verant" constructed by v. Rohr and A. Köhler (1905),

in which the lenses, in accordance with A. Gullstrand's rule, are so arranged that the centre of rotation of the eye always coincides with the nodal point of the lenses. If every one had the same interpupillary distance there would be nothing more perfect than this stereoscope.

If in fig. 6 the two pictures L and R are interchanged in both pictures (a or b in fig. 11), then the image-points for H are closer together than those for V; thus in stereoscopic vision H appears in front of P, and V behind it. No change is made to the relief by turning the picture upside down (c and d in fig. 11). In fig. 11d, the pictures are in the same positions as when the photographs are taken (F₁, F₂ in fig. 6). Obviously transparent pictures can be easily reversed; in other cases it must be effected by mirrors (Wheatstone, Dove and others) or by an erecting reflection prism. The original unbroken plate (fig. 11d) can be seen in the pseudo-stereoscope shown in fig. 12, and the correct relief is obtained if it is rotated about the connecting line of the two pictures before placing in the stereoscope. If a symmetrical body be observed in the pseudo-stereoscope, for example a pyramid, the relief is still reversed. But if a prism be dispensed with the object appears flat, and a plane drawing appears in relief.



FIG. 12.

These pseudo-stereoscopic phenomena are of the greatest importance for the study of the principles of stereoscopy, for they demonstrate that the perception of depth can be aided by a direct presentation and hindered by a reverse presentation. If a plate of the dolomites, for example, with a large base line, arranged as in 11a and 11b is taken, and the apparatus and the eyes are directed upwards, then the pseudomorphic image in space looks like the roof of a stalactite cave. On the other hand, when arranged as 11c and 11d the image appears correctly represented, but it is a little more difficult to see the horizon in the foreground of the pseudomorphic image. Reference can only be made here to the physiologically interesting phenomena of colour-tones, which are a result of the chromatism of the eye and occur in monocular and binocular vision (Dove and, more recently, A. Brückner).

A comparatively simple solution to the problem of putting pictures seen in a stereoscope in motion is provided in the *mutoscope* for a single observer. The other problem—to make one stereoscopic picture visible to several people simultaneously—can be met in various ways, most simply (according to Rollmann [1853] and D'Almeida [1858]) by portraying the two stereoscopic pictures in different colours one over the other, and giving each observer spectacles of different coloured glass for each eye, with which it is only possible to see one picture with each eye. Another method suggested by I. Anderton (1891), in which polarization and a Nicol prism must be used to separate the pictures, has met with little success, and F. E. Ives's novel proposal (1903) to separate the pictures when being taken and also observed by a ruled grating placed immediately in front of the photographic plate is not practicable. A method devised by D'Almeida, which depended upon the alternate visibility of the two pictures, demands a mechanism for each observer, exactly synchronous with the intermittent illumination. This principle was successfully adopted by J. Mackenzie Davidson and H. Boas (1900) for a direct stereoscopic observation of Röntgen radiographs. Immediately after the discovery of the Röntgen rays in 1895, E. Mach made stereoscopic investigations of these radiographs.

The development of stereoscopy has in no way been uniform; on the contrary, a long period, during which practically no interest was taken in stereoscopy or stereoscopic phenomena, was preceded during the middle part of the 19th century by a period of universal interest. The reason for this was not so much the realization of the defects of the stereoscopes in themselves, and the trivial manner in which they were put on the market, as, for example, a closing stereoscope containing confectionery, as the fact that the public did not know how to make use of the pictures seen in the stereoscope. This state of affairs was altered when Zeiss, of Jena, as a result of the investigations of E. Abbe and C. Pulfrich, succeeded in constructing apparatus which made it possible to measure the three-dimensional images.

The stereotelemeter, constructed after H. de Grouilliers' idea, appeared in 1899. This is a double telescope with the distance between the objectives increased, and a number of rows of marks in the plane of the image which appear as

real objects floating at fixed distances above the landscape, from which the distances of the objects in the view can be easily read. In 1905 Pulfrich devised a method of stereoscopic measurement which is specially interesting from a physiological point of view, but which can only be employed for isolated objects, such as beacons, signals, &c. This method has the peculiarity that no marks are necessary for the measurement. The binocular telescope is so arranged that it always produces two three-dimensional images of the object which is to be measured close to one another, which as a rule are seen as though they were at different distances and of different sizes. The measurement is made by causing the difference of relief of the two images to disappear either by bringing the instrument nearer to the object or by readjusting the apparatus. The equal size of the two three-dimensional images can be regarded as a criterion of their equal distances; and it is of further advantage to the method that the images to be compared are equal as to definition and colour.

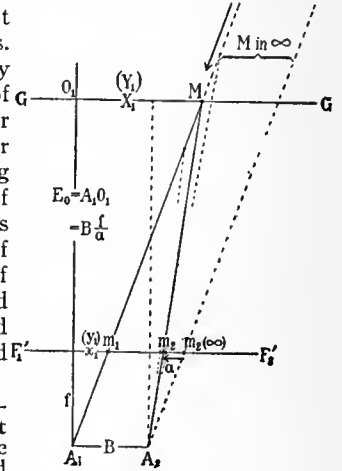

FIG. 13.

A consequence of these instruments, which are chiefly important for military surveying, was the Pulfrich stereocomparator devised in 1901. The stereoscopic measuring machine invented by H. G. Fourcade of Capetown (1902) is similar to this in many points. These instruments inaugurated the successful measurement of the distances of distant objects and the uses of stereoscopy were consequently increased. Measurement is not made of the objects themselves, but on photographic plates which are taken with special instruments—field- and stand-phototheodolites—at the extremities of a baseline which is always selected according to the distance of the object

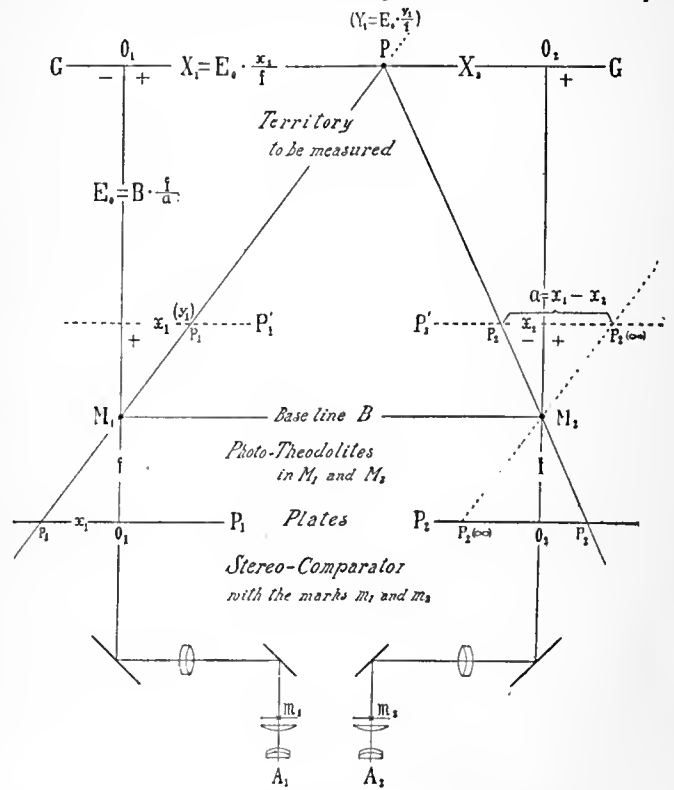

FIG. 14.

and the exactitude of measurement needed. For measuring the pictures a binocular microscope, adjusted to the dimensions and the distance between the two plates, is used, and a fixed mark is placed in each image plane which combine in binocular view to a virtual mark in the three-dimensional image. If the plates are correctly

adjusted, by moving the plates perpendicular to one another and by altering the distance of the plates from one another, this so-called "travelling mark" can be placed on any point of the landscape, and then used for the measurement of solidity of the objects, or the production of plans and models, just as formerly, for example, the measuring staff was used for geodetic observations, with the difference that in the stereocomparator the mark is regulated by the observer only and is not hindered in its movements by any undulations, &c., of the land.

Fig. 13 shows how the lateral movement of the mark m_2 is transformed in a movement towards and away from the observer in the three-dimensional image M. Fig. 14 shows the theory of measuring a stereophotograph. The axes are horizontal when the photograph is taken, and the plates are in one plane. It shows the method of calculating the position of the point P in the object-space from the co-ordinates x_1 and y_1 of image-point on the left plate and the so-called parallel axis $a = x_1 - x_2$; the last is constant for all points in the vertical plane GG through P at right angles to M_1O_1 . The two microscopes in fig. 14 really produce erect pictures, and the two plates are so placed in the stereocomparator as to be seen from P_1' and P_2' .

The use of the stereocomparator is unlimited for the measurement of relief. It is extended similarly to all objects and phenomena, large and small, distant and near, in motion or stationary, to those which retain their shape for a long period or which are constantly changing, or to those which are only visible for a short time. For a large number of experiments of this sort—mountain photography (Von Hübl, &c.), coastal measurements, photographing a battle from a ship, geodesy, study of the waves (Kohlschütter, Laas), the trajectory of a shot (Neuffer, Krupp, Neesen), the use in building railways or on voyages of discovery, &c.—the stereocomparator has given new fields to be opened up for it. A further advance has been made in the stereophotogrammetric method by providing the stereocomparator with a drawing apparatus (F. V. Thomson, E. v. Orel and Carl Zeiss), with which contours can be automatically drawn from the stereophotogrammetric photographs. E. Deville's (1903) stereoplanigraph (fig. 15), designed for the same purpose, is only used as

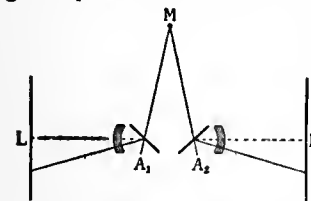

FIG. 15.

a demonstration apparatus. The mirrors are transparent for the observation of a source of light, &c., which is moved in the object-space.

The stereometer may be regarded as a modification of the stereocomparator, and is constructed for the measurement of men and animals, and also for sculpture, and for the observation of complete stereoscopic photographs. The motion of the mark is effected by a lateral movement of one of the two objectives forming the picture. Pulfrich has recently provided the Greenough binocular microscope with a point or a circular mark situated exactly in the centre of the field of view for the purpose of the direct gauging of small preparations which cannot be directly brought into contact with a mark. This contact with the preparation is effected by displacing either the preparation or the microscope, and the separate distances are read with a vernier.

The earlier suggestions for making the stereoscope a measuring instrument were not realized though decisive improvements were made. Brewster was unconsciously near the solution of the problem when he prepared ghosts or vistas by placing one transparent picture over another. More important than these trivial pictures are the superposed pictures (of conic sections, machines, anatomical preparations, &c.) contrived by E. Mach (1866) in which sections of the same solid object are successively photographed on one plate so that in a stereoscope one can see, as it were, through the opaque surface of the solid into the interior. To A. Rollet (1861) is due the merit of constructing the first stereoscopic measuring scale. It was a sort of ladder, whose rungs gave the distances of objects. Shortly after Mach suggested using the mirror image of a wire model observed in a transparent mirror for the measurement of the dimensions of a body placed behind the glass plate.

The works of I. Harmer (1881) and F. Stolze (1884 and 1892) are of importance for the history of the development of stereoscopic measurement. Harmer used a scale of depth consisting of a series of squares arranged one behind the other in order to measure in the stereoscope a picture of the clouds taken with a large base-line (about 15 metres). Stolze placed gratings in front of the two semi-pictures of a mirror stereoscope, one of

which could be moved by a micrometer, and he thus discovered the device called the "travelling mark." Apparently independent of all earlier experimenters T. Marie and H. Ribaut had the idea of the "travelling mark" in 1899 and 1900 and used it for measuring the Röntgen radiographs.

Of the applications of stereoscopy we may notice the utilization of spatial effects and troubles in stereoscopic vision (agitation and lustrous appearances) in the discovery of differences and alterations in pictures. The method was first used by Brewster to recognize irregularities in carpet patterns, and later by Dove and others for distinguishing the original from a copy, for testing coins, cheques, &c. Moreover, with the development of celestial photography, the stereoscope came to be applied to the discovery of planets, comets, variable stars, errors in plates, the proper motions and parallaxes of the fixed stars (Harmer, Kummel, Wolf and Lenard, Förster and others).

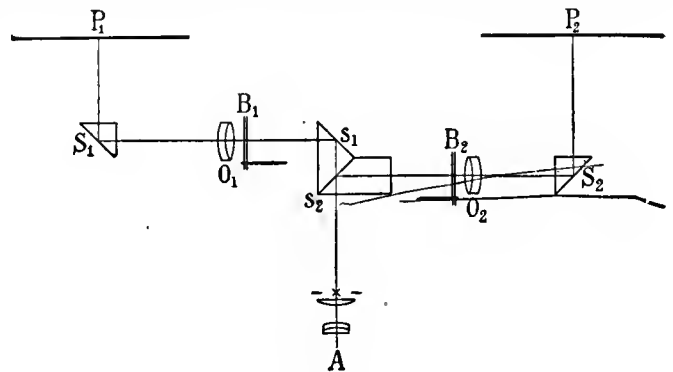

FIG. 16.

The stereocomparator has also been employed in astrometry, and a planetoid discovered by its aid was named Stereoscopia in recognition of this application. Since 1904 binocular observation of stellar plates to determine differences in the images of the objects reproduced has been gradually discarded for the method devised by Pulfrich, which consists in the monocular observation of the two plates in the stereocomparator with the assistance of the so-called "blink" microscope (fig. 16). In this microscope the two pictures are seen simultaneously, or individually by alternately opening the screens B_1 and B_2 . In the second case all differences of the two images are immediately distinguished by a sudden oscillation of the image-point or by a sudden appearance and disappearance of single points like flash lights at sea or the modern illuminated sky lights in towns, and there is now no merit in discovering new planets, comets and variable stars by this method.

The blink microscope is far more useful than the stereomicroscope for such purposes, for there is not one special direction in which differences can be best distinguished. It is better therefore for the stereo method to be restricted to the work for which it is specially suitable, and for which it will never be replaced, and for such experiments as we have just discussed to be solely performed with the aid of the blink microscope. (C. P.*)

STERLING, ANTOINETTE (d. 1904), Anglo-American vocalist, was born at Sterlingville, New York state. She studied with Mme Marchesi, with Mme Viardot Garcia and with Manuel Garcia, and after singing for two years in America came in 1873 to England, where she made her first appearance at Covent Garden under Sir Julius Benedict and rapidly became a popular favourite among the contraltos of the day. She gained her greatest successes as a ballad-singer, especially in such songs as "Caller Herrin," "The Three Fishers" and "The Lost Chord." She was a woman of deep religious feeling and many enthusiasms, and her name was constantly associated with philanthropic enterprise. She died on the 10th of January 1904. In 1875 she had married Mr John Mackinlay, and her life was written by her son, Mr Sterling Mackinlay, in 1906.

STERLING, JOHN (1806–1844), British author, was born at Kames Castle in Bute on the 20th of July 1806. He belonged to a family of Scottish origin which had settled in Ireland during the Cromwellian period. His father, Edward Sterling (1773–1847), had been called to the Irish bar, but, having fought as a militia captain at Vinegar Hill, afterwards volunteered with his company into the line. On the breaking up of his regiment he went to Scotland and took to farming at Kames Castle. In 1804 he married Hester Coningham. In 1810 the family removed to Llanblethian, Glamorganshire, and during his residence there Edward Sterling, under the signature of "Vetus," contributed a number of letters to *The Times*, which were reprinted in 1812, and a second series in 1814. In the latter year he removed to Paris, but on the escape of Napoleon from Elba in 1815 took up his residence in London, obtaining a position on the staff of *The Times* newspaper; and during the late years of Thomas Barnes's administration he was practically editor. His fiery, emphatic and oracular mode of writing conferred those characteristics on *The Times* which were recognized in the sobriquet of the "Thunderer." John Sterling was his second son, the elder being Colonel Sir Anthony Coningham Sterling (1805–1871), who besides serving in the Crimea and as military secretary to Lord Clyde during the Indian Mutiny, was the author of *The Highland Brigade in the Crimea* and other books. After studying for one year at the university of Glasgow, John Sterling in 1824 entered Trinity College, Cambridge, where he had for tutor Julius Charles Hare. At Cambridge he took a distinguished part in the debates of the union, and became a member of the "Apostles" Club, forming friendships with Frederick Denison Maurice and Richard Trench. He removed to Trinity Hall with the intention of graduating in law, but left the university without taking a degree. During the next four years he resided chiefly in London, employing himself actively in literature and making a number of literary friends. With Maurice he purchased the *Athenaeum* in 1828 from J. Silk Buckingham, but the enterprise was not a pecuniary success. He also formed an intimacy with the Spanish revolutionist General Torrijos, in whose unfortunate expedition he took an active interest. But he did not accompany it, as he was kept in England by his marriage to Susannah, daughter of Lieut.-General Barton. Shortly after his marriage in 1830 symptoms of pulmonary disease induced him to take up his residence in the island of St Vincent, where he had inherited some property, and he remained there fifteen months before returning to England. After spending some time on the Continent in June 1834 he was ordained and became curate at Hurstmonceaux, where his old tutor Julius Hare was vicar. Acting on the advice of his physician he resigned his clerical duties in the following February, but, according to Carlyle, the primary cause was a divergence from the opinions of the Church. There remained to him the "resource of the pen," but, having to "live all the rest of his days as in continual flight for his very existence," his literary achievements were necessarily fragmentary. He published in 1833 *Arthur Coningsby*, a novel, which attracted little attention, and his *Poems* (1839), the *Election*, a *Poem* (1841), and *Strafford*, a tragedy (1843), were not more successful. He had, however, established a connexion in 1837 with *Blackwood's Magazine*, to which he contributed a variety of papers and several tales of extraordinary promise not fulfilled in his more considerable undertakings. Among these papers were "The Onyx Ring" and "The Palace of Morgana." He died at Ventnor on the 18th of September 1844, his wife having died in the preceding year.

His son, Major-General John B. Sterling (b. 1840), after entering the navy, went into the army, and had a distinguished career (wounded at Tel-el-Kebir in 1882), both as a soldier and as a writer on military subjects.

John Sterling's papers were entrusted to the joint care of Thomas Carlyle and Archdeacon Hare. *Essays and Tales*, by John Sterling, collected and edited, with a memoir of his life, by Julius Charles Hare, appeared in 1848 in two volumes. So dissatisfied was Carlyle with the memoir that he resolved to give his own "testimony"

about his friend, and his vivid *Life* (1851) has perpetuated the memory of Sterling more than any of the latter's own writings.

STERLING, a city of Whiteside county, Illinois, U.S.A., on the north bank of Rock river, 109 m. by rail W. of Chicago. Pop. (1900), 6309, of whom 815 were foreign-born and 23 were negroes; (1910), 7467. Sterling is served by the Chicago & North-western and the Chicago, Burlington & Quincy railways, and by inter-urban electric railway to Dixon, 12 m. N.N.W. Across the river is Rock Falls (pop. in 1900, 2176), practically a suburb of Sterling, with foundries and machine-shops and manufactories of agricultural implements, barbed wire and bolts and rivets. Three bridges cross the river. The river is tapped here by the feeder of the Illinois & Michigan Canal, so that there is direct water communication with Chicago and St Louis. Two great dams on the river (one built by the Federal government) provide good water power. The public library (1878) had 12,000 volumes in 1910. In the city are large ironworks, and numerous other manufactures. Sterling was formed in 1839 by the consolidation of two towns, Harrisburg and Chatham, founded here in 1836 and 1837 respectively; it was chartered as a city in 1857.

STERLING, a term used to denote money of standard weight or quality, especially applied to the English gold sovereign, and hence with the general meaning of recognized worth or authority, genuine, of approved excellence. The word has been generally derived from the name of "Easterlings" given to the North German merchants who came to England in the reign of Edward I. and formed a *hansa* or guild in London, modelled on the earlier one of the merchants of Cologne. Their coins were of uniform weight and excellence (cf. Matthew Paris, ann. 1247, *moneta esterlingorum, propter sui materiem desiderabilem, &c.*), and thus it is supposed gave the name of the moneyers to a coinage of recognized fineness. This theory is based on the statement of Walter de Pinchbeck, a monk of the time of Edward I., "sed moneta Angliae fertur dicta fuisse a nominibus opificum, ut Floreni a nominibus Florentiorum, ita *Sterlingi* a nominibus Esterlingorum nomina sua contraxerunt, qui hujusmodi monetam in Anglia primitus componebant" (quoted in Wedgwood, *Dict. of Eng. Etym.*). The word, however, occurs much earlier. The *Roman de Rou* (1180) has "Pour ses estellins recevoir," and "in Anglia unus Sterlingus per solvetur" occurs in an ordinance of Philip of France and Henry II. of England of 1184, both quoted in Du Cange (*Gloss. s.v. Esterlingus*). The "sterling" was a coin, the silver penny, 240 of which went to the "pound sterling" of silver of 5760 grains, 925 fine, and described in a statute of Edward I., quoted in Du Cange, as "Denarius Angliae qui vocatur Sterlingus." The word was borrowed by all European languages and applied to the English coin and to coins in general of a standard quality; thus we find not only O. Fr. *estorlin* or *estellin* but M. H. G. *sterlinc* or *staerlinc*, Ital. *sterlino*, &c. It would seem therefore that the term was applied to a coin of recognized quality before the North German merchants were established in London and that its origin should be found in a native English word. Two suggestions have been made; one that it represents an O. Eng. *steorling*, i.e. little star, from a device on an early coin, such as is found on some of William II., or O. Eng. *staerling*, starling, from the birds, which however may be doves, on the coins of Edward the Confessor. (See Du Cange, *Gloss. s.v. Esterlingus*; and Skeat, *Etym. Dict.* 1910, *s.v. Sterling*.)

STERNBERG, a town of Austria, in Moravia, 73 m. N.E. of Brünn by rail. Pop. (1900), 15,195, almost exclusively German. It is the chief seat of the Moravian cotton industry, and it also carries on the manufacture of linen, stockings, liqueurs, sugar and bricks. Fruit, especially cherries, and tobacco are grown in the neighbourhood. Sternberg is said to have grown up under the shelter of a castle founded by Yaroslav of Sternberg on the site of his victory over the Mongols in 1241.

STERNE, LAURENCE (1713–1768), English humorist, was the son of Roger Sterne, an English officer, and great-grandson of an archbishop of York. Nearly all our information about the first forty-six years of his life before he became famous as the author of *Tristram Shandy* is derived from a short memoir

jotted down by himself for the use of his daughter. It gives nothing but the barest facts, excepting three anecdotes about his infancy, his school days and his marriage. He was born at Clonmel, Ireland, on the 24th of November 1713, a few days after the arrival of his father's regiment from Dunkirk. The regiment was then disbanded, but very soon after re-established, and for ten years the boy and his mother moved from place to place after the regiment, from England to Ireland, and from one part of Ireland to another. The familiarity thus acquired with military life and character stood Sterne in good stead when he drew the portraits of Uncle Toby and Corporal Trim. After ten years of wandering, he was fixed for eight or nine years at a school at Halifax in Yorkshire. His father died when he was in his eighteenth year, and he was indebted for his university education to one of the members of his father's family. His great-grandfather the archbishop had been master of Jesus College, Cambridge, and to Jesus College he was sent. He was admitted to a sizarship in July 1733, took his B.A. degree in 1736 and proceeded M.A. in 1740. One of his uncles was precentor and canon of York. Young Sterne took orders, and through this uncle's influence obtained in 1738 the living of Sutton-in-the-Forest, some 8 m. north of York. Two years after his marriage in 1741 to a lady named Elizabeth Lumley he was presented to the neighbouring living of Stillington, and did duty at both places. He was also a prebendary of York Cathedral.

Sutton was Sterne's residence for twenty uneventful years. He kept up an intimacy which had begun at Cambridge with John Hall-Stevenson (1718-1785), a witty and accomplished epicurean, owner of Skelton Hall ("Crazy Castle") in the Cleveland district of Yorkshire. Skelton Hall is nearly 40 m. from Sutton, but Sterne, in spite of his double duties, seems to have been a frequent visitor there, and to have found in his not too strait-laced friend a highly congenial companion. Sterne is said to have never formally become a member of the circle of gay squires and clerics at Skelton known as the "Demoniacks"; but no doubt he shared their festivities. Stevenson's various occasional sallies in verse and prose—his *Fables for Grown Gentlemen* (1761-1770), his *Crazy Tales* (1762), and his numerous skits at the political opponents of Wilkes, among whose "macaronies" he numbered himself—were collected after his death, and it is impossible to read them without being struck with their close family resemblance in spirit and turn of thought to Sterne's work, inferior as they are in literary genius. Without Stevenson, Sterne would probably have been a more decorous parish priest, but he would probably never have written *Tristram Shandy* or left any other memorial of his singular genius. In 1747 Sterne published a sermon preached in York under the title of *The Case of Elijah*. This was followed in 1750 by *The Abuses of Conscience*, afterwards inserted in vol. ii. of *Tristram Shandy*. In 1759 he wrote a skit on a quarrel between Dean Fountayne and Dr Topham, a York lawyer, over the bestowal of an office in the gift of the archbishop. This sketch, in which Topham figures as Trim the sexton, and the author as Lorry Slim, gives an earnest of Sterne's powers as a humorist. It was not published until after his death, when it appeared in 1769 under the title of *A Political Romance*, and afterwards the *History of a Warm Watch-Coat*. The first two volumes of *Tristram Shandy* were issued at York in 1759 and advertised in London on the 1st of January 1760, and at once made a sensation. York was scandalized at its clergyman's indecency, and indignant at his caricature as "Slop" of a local physician (Dr John Burton); London was charmed with his audacity, wit and graphic unconventional power. He went to London early in the year to enjoy his triumph, and found himself at once a personage in society—was called upon and invited out by lion-hunters, was taken to Windsor by Lord Rockingham, and had the honour of supping with the duke of York.

For the last eight years of his life after this sudden leap out of obscurity we have a faithful record of Sterne's feelings and movements in letters to various persons, published in 1775 by his sole child and daughter, Lydia Sterne de Medalle, and in the

Letters from Yorick to Eliza (1766-1767), also published in 1775. At the end of the sermon in *Tristram* he had intimated that, if this sample of Yorick's pulpit eloquence was liked, "there are now in the possession of the Shandy family as many as will make a handsome volume, at the world's service, and much good may they do it." Accordingly, when a second edition of the first instalment of *Tristram* was called for in three months, two volumes of *Sermons* by Yorick were announced. Although they had little or none of the eccentricity of the history, they proved almost as popular. Sterne's clerical character was far from being universally injured by his indecorous freaks as a humorist: Lord Fauconberg presented the author of *Tristram Shandy* with the perpetual curacy of Coxwold. To this new residence he went in high spirits with his success, "fully determined to write as hard as could be," seeing no reason why he should not give the public two volumes of Shandyism every year and why this should not go on for forty years. By the beginning of August 1760 he had another volume written, and was so "delighted with Uncle Toby's imaginary character that he was become an enthusiast." The author's delight in this wonderful creation was not misleading; it has been fully shared by every generation of readers since. For two years in succession Sterne kept his bargain with himself to provide two volumes a year. Vols. iii. and iv. appeared in 1761; vols. v. and vi. in January 1762. But his sanguine hopes of continuing at this rate were frustrated by ill-health. He was ordered to the south of France; it was two years and a half before he returned; and he came back with very little accession of strength. His reception by literary circles in France was very flattering. He was overjoyed with it. "'Tis comme à Londres," he wrote to Garrick from Paris; "I have just now a fortnight's dinners and suppers upon my hands." Through all his pleasant experiences of French society, and through the fits of dangerous illness by which they were diversified, he continued to build up his history of the Shandy family, but the work did not progress as rapidly as it had done. Not till January 1765 was he ready with the fourth instalment of two volumes; and one of them, vol. vii., leaving the Shandy family for a time, gave a lively sketch of the writer's own travels to the south of France in search of health. This was a digression of a new kind, if anything can be called a digression in a work the plan of which is to fly off at a tangent whenever and wherever the writer's whim tempts him. In the first volume, anticipating an obvious complaint, he had protested against digressions that left the main work to stand still, and had boasted—not without justice in a Shandean sense—that he had reconciled digressive motion with progressive. But in vol. vii. the work is allowed to stand still while the writer is being transported from Shandy Hall to Languedoc. The only progress we make is in the illustration of the buoyant and joyous temper of Tristram himself, who, after all, is a member of the Shandy family, and was due a volume for the elucidation of his character. Vol. viii. begins the long-promised story of Uncle Toby's amours with the Widow Wadman. After seeing to the publication of this instalment of *Tristram* and of another set of sermons—more pronouncedly Shandean in their eccentricity—he quitted England again in the summer of 1765, and travelled in Italy as far as Naples. The ninth and last and shortest volume of *Tristram*, concluding the episode of Toby Shandy's amours, appeared in 1767. This despatched, Sterne turned to a new project, which had probably been suggested by the ease and freedom with which he had moved through the travelling volume in *Tristram*. The *Sentimental Journey through France and Italy* was intended to be a long work: the plan admitted of any length that the author chose, but, after seeing the first two volumes through the press in the early months of 1768, Sterne's strength failed him, and he died in his lodgings at 41 Old Bond Street on the 18th of March, three weeks after the publication. The loneliness of his end has often been commented on; it was probably due to its unexpectedness. He had pulled through so many sharp attacks of his "vile influenza" and other lung disorders that he began to be seriously alarmed only three days before his death.

Sterne's character defies analysis in brief space. It is too subtle and individual to be conveyed in general terms. For comments upon him from points of view more or less diverse the reader may be referred to Thackeray's *Humourists*, Professor Masson's *British Novelists* (1859), and H. D. Traill's sketch in the "English Men of Letters" Series. The fullest biography is Mr Percy Fitzgerald's (1864). But the reader who cares to have an opinion about Sterne should hesitate till he has read and re-read in various moods considerable portions of Sterne's own writing. This writing is so singularly frank and unconventional that its drift is not at once apparent to the literary student. The indefensible indecency and overstrained sentimentality are on the surface; but after a time every repellent defect is forgotten in the enjoyment of the exquisite literary art. In the delineation of character by graphically significant speech and action, introduced at unexpected turns, left with happy audacity to point their own meaning, and pointing it with a force that the dullest cannot but understand, he takes rank with the very greatest masters. In Toby Shandy he has drawn a character universally lovable and admirable; but Walter Shandy is almost greater as an artistic triumph, considering the difficulty of the achievement. Dr Ferriar, in his *Illustrations of Sterne* (published in 1798), pointed out several unacknowledged plagiarisms from Rabelais, Burton and others; but it is only fair to the critic to say that he was fully aware that they were only plagiarisms of material, and do not detract in the slightest from Sterne's reputation as one of the greatest of literary artists.

A revised edition of Mr Percy Fitzgerald's *Life of Sterne*, containing much new information, appeared in 1896. There is also a valuable study of Sterne by M. Paul Stapfer (1870, 2nd ed., 1882); and many fresh particulars as to Sterne's relations with his wife and daughter, and also with the lady known as "Eliza" (Mrs Elizabeth Draper), are collected in Mr Sidney Lee's article in the *Dict. Nat. Biog.* Sterne's original journal to Mrs Draper ("The Bramine's Journal"), after she had gone back to India, and extending from the 13th of April to the 4th of August 1767, is now in the department of MSS., British Museum (addit. MS. 34,527). A convenient edition of Sterne's works, edited by Professor George Saintsbury, was issued in six volumes in 1894. See also Wilbur L. Cross, *The Life and Times of Laurence Sterne* (New York, 1909); and Walter Sichel, *Sterne: a Study* (1910). (W. M.; A. D.)

STERNE, RICHARD (c. 1596–1683), English divine, archbishop of York, was born at Mansfield, Nottinghamshire, and was educated at the free-school in that town and at Trinity College, Cambridge. He was elected fellow of Corpus Christi College in 1620; in 1633 he became chaplain to Archbishop Laud and in 1634 master of Jesus College, Cambridge, and rector of Yelverton, Somerset. For his zeal in helping the royalist cause with college plate he suffered imprisonment at the order of parliament and lost his appointments. He attended Laud at his execution, and during the Commonwealth kept a school at Stevenage, Hertfordshire. At the Restoration he was reinstated as master of Jesus College and soon after was made bishop of Carlisle. With George Griffith, bishop of St Asaph, and Brian Walton, bishop of Chester, he was appointed by Convocation to revise the Prayer Book. In 1664 he was raised to the archbishopric of York. He had impoverished Carlisle, and in his new see, according to Burnet (who calls him "a sour ill-tempered man"), "minded chiefly the enriching of his family." For his regard to the duke of York's interests he was suspected of leaning towards Roman Catholicism. He died on the 20th of June 1683. He helped Brian Walton with the *Polyglot Bible* and wrote a book on logic, *Summa logicae* (London, 1685).

He has also been credited with *The Whole Duty of Man*, which must, however, be assigned to the royalist divine Richard Allestree (1619–1681), provost of Eton College, whose original was considerably altered by his literary executor, John Fell (1625–1686), bishop of Oxford.

STESICHORUS (c. 640–555 B.C.), Greek lyric poet, a native of Himera in Sicily, or of Madaurus a Locrian colony in the south of Italy. According to Suidas, his name was originally Tisias, but was changed to Stesichorus ("organizer of choruses"). His future eminence as a poet was foretold when a nightingale perched upon his lips and sang (Pliny, *Nat. Hist.*, x. 43). We are told that he warned his fellow-citizens against Phalaris,

whom they had chosen as their general, by relating to them the well-known fable of the horse, which, in its eagerness to punish the stag for intruding upon its pastures, became the slave of man (Aristotle, *Rhetoric*, ii. 20). But his warnings had no effect; he himself was obliged to flee to Catana, where he died and was buried before the gate called after him the Stesichorean. The story that he was struck blind for slandering Helen in a poem and afterwards recovered his sight when, in consequence of a dream, he had composed a palinode or recantation (in which he declared that only Helen's phantom had been carried off to Troy), is told by Plato (*Phaedrus* 243 A.), Pausanias (iii. 19, 13), and others. We possess about thirty fragments of his poems, none of them longer than six lines. They are written in the Doric dialect, with epic licences; the metre is dactylico-trochaic. Brief as they are, they show us what Longinus meant by calling Stesichorus "most like Homer"; they are full of epic grandeur, and have a stately sublimity that reminds us of Pindar. Stesichorus indeed made a new departure by using lyric poetry to celebrate gods and heroes rather than human feelings and passions; this is what Quintilian (*Instit.* x. 1, 62) means by saying that he "sustained the burden of epic poetry with the lyre." Several of his poems sung of the adventures of Heracles; one dealt with the siege of Thebes, another with the sack of Troy.¹ The last is interesting as being the first poem containing that form of the story of Aeneas's flight to which Virgil afterwards gave currency in his *Aeneid*. The popular legends of Sicily also inspired his muse; he was the first to introduce the shepherd Daphnis who came to a miserable end after he had proved faithless to the nymph who loved him. Stesichorus completed the form of the choral ode by adding the epode to the strophe and antistrophe; and "you do not even know Stesichorus's three" passed into a proverbial expression for unpardonable ignorance (unless the words simply mean, "you do not even know three lines, or poems, of Stesichorus"). He was famed in antiquity for the richness and splendour of his imagination and his style, although Quintilian censures his redundancy and Hermogenes remarks on the excessive sweetness that results from his abundant use of epithets.

Fragments in T. Bergk, *Poetae Lyrici Graeci*, iii.; see also S. Bernage, *De Stesichoro Lyrico* (1880); O. Crusius, "Stesichorus und die epodische Composition in der griechischen Lyrik," in *Commentationes Philologicae*, dedicated to O. Ribbeck (1888).

STETHOSCOPE (Gr. *στήθος*, chest, and *σκοπεῖν*, to look, examine), a medical instrument used in auscultation (*q.v.*). The single stethoscope is a straight wooden or metal tube with a flattened bell, the surface of which is usually covered with ivory or bone at the end which is placed against the body of the patient, and a small cup at the other to fit the ear of the observer. In the "binaural" stethoscope, which has the advantage of flexibility, the tube is divided above the bell into two flexible tubes which lead to both ears.

STETTIN, a seaport of Germany, capital of the Prussian province of Pomerania, on the Oder, 17 m. above its entrance into the Stettiner Haff, 30 m. from the Baltic, 84 m. N.E. of Berlin by rail, and at the junction of lines to Stargard-Danzig and Küstrin-Breslau. Pop. (1885), 99,475; (1890), 116,228; (1900)—including the incorporated suburbs—210,680; (1905) 224,078. The main part of the town occupies a hilly site on the left bank of the river, and is connected by four bridges, including a massive railway swing-bridge, with the suburbs of Lastadie ("lading place" from *lastadium*, "burden,") and Silberwiese, on an island formed by the Parnitz and the Dunzig, which here diverge from the Oder to the Dammsche-See. Until 1874 Stettin was closely girdled by very extensive and strong fortifications, which prevented the expansion of the town, but the steady growth of its commerce and manufactures encouraged the foundation of numerous industrial suburbs beyond the

¹ The *tabula Iliaca*, a stucco bas-relief found in the ruins of an ancient temple on the site of the ancient Bovillae and so called because it represents the chief events of the Trojan War, is a sort of commentary upon this (see O. Jahn and A. Michaelis, *Griechische Bilderchroniken*, 1873; and M. F. Paulcke, *De tabula iliaca quaestiones Stesichoreae*, 1897, an exhaustive treatise).

line of defence and these now combine with Stettin to form one industrial and commercial centre. Since the removal of the fortifications their site has been built upon. Apart from its commerce Stettin is comparatively an uninteresting city, although its appearance, owing to its numerous promenades and open spaces, is very pleasant. Among its nine Evangelical churches that of St Peter, founded in 1124 and restored in 1816-1817, has the distinction of being the oldest Christian church in Pomerania. Both this and the church of St James, dating from the 14th century, are remarkable for their size. Three of the Evangelical churches are fine new buildings, and there are also churches belonging to the Roman Catholics and other religious bodies. The old palace, now used as public offices, is a large but unattractive edifice, scarcely justifying the boast of an old writer that it did not yield in magnificence even to the palaces of Italy. Among the modern buildings are the theatre, the barracks, the bourse, a large hospital, the new town-hall, superseding a building of the 13th century, and the new government buildings. Statues of Frederick the Great, of Frederick William III. and of the emperor William I. adorn two of the fine squares, the Königsplatz and the Kaiser Wilhelmsplatz. Other squares are the Paradeplatz, and the Rathausplatz with a beautiful fountain. Two gateways, the Königstor and the Berliner Tor, remains of the old fortifications, are still standing. As a prosperous commercial town Stettin has numerous scientific, educational and benevolent institutions.

Stettin, regarded as the port of Berlin, is one of the principal ship-building centres of Germany and a place of much commercial and industrial activity. The foremost place in its chief industry, ship-building, is taken by the Vulcan yard, situated in the suburb of Bredow, which builds warships for the German navy. The business was begun in 1851 and now employs about 8000 hands, the works extending over 70 acres and the covered workshops over 650,000 sq. ft. In 1897 a floating dock was fitted up capable of holding vessels of 12,000 tons. Locomotives, boilers and machinery of all kinds are made in other great establishments. Other industries are the manufacture of clothing, cement, bricks, motor-cars, soap, paper, beer, sugar, spirits and cycles. Most of the mills and factories are situated in the suburbs, Grabow, Bredow and others. The sea-borne commerce of Stettin is of scarcely less importance than her industry and a larger number of vessels enter and clear here than at any other German port, except Hamburg and Bremerhaven. Swinemünde serves as its outer port. Its principal exports are grain, wood, chemicals, spirits, sugar, herrings and coal, and its imports are iron goods, chemicals, grain, petroleum and coal. A great impulse to its trade was given in 1898 by the opening of a free harbour adjoining the suburb of Lastadie on the east bank of the Oder; this embraces a total area of 150 acres and quays with a length of 14,270 ft. It has two basins, with the necessary accompaniment of cranes, storehouses, &c., and the deepening of the Oder from Stettin to the Haff to 24 ft. was practically completed by 1903. With the view of still further increasing the commercial importance of Stettin, it is proposed to construct a ship canal giving the town direct communication with Berlin. A feature in the mercantile life of Stettin is the large number of insurance companies which have their headquarters in the town.

The forest and river scenery of the neighbourhood of Stettin is picturesque, but the low level and swampy nature of the soil render the climate bleak and unhealthy.

Stettin is said to have existed as a Wendish settlement in the 9th century, but its first authentic appearance in history was in the 12th century, when it was known as Stedyn. From the beginning of the 12th century to 1637 it was the residence of the dukes of Pomerania, one of whom, Duke Barnim I., gave it municipal rights in 1243. Already a leading centre of trade it entered the Hanseatic League in 1360. The Pomeranian dynasty became extinct in 1637, when the country was suffering from the ravages of the Thirty Years' War, and by the settlement of 1648 Stettin, the fortifications of which had been improved by Gustavus Adolphus, was ceded to Sweden. In

1678 it was taken from Sweden by Frederick William, elector of Brandenburg, but it was restored in 1679, only, however, to be ceded to Prussia in 1720 by the peace of Stockholm. It was fortified more strongly by Frederick the Great, but in 1806 it yielded to France without any resistance and was held by the French until 1813. Stettin was the birthplace of the empress Catherine II. of Russia.

See Berghaus, *Geschichte der Stadt Stettin* (Würzen, 1875-1876); W. H. Meyer, *Stettin in alter und neuer Zeit* (Stettin, 1887); T. Schmidt, *Zur Geschichte des Handels und der Schifffahrt Stettins 1786-1846* (Stettin, 1875); and C. F. Meyer, *Stettin zur Schwedenzeit* (Stettin, 1886).

STEUART, SIR JAMES DENHAM, BART. (1712-1780), English economist, was the only son of Sir James Steuart, solicitor-general for Scotland under Queen Anne and George I., and was born at Edinburgh on the 21st of October 1712. After passing through the university of Edinburgh he was admitted to the Scottish bar at the age of twenty-four. He then spent some years on the Continent, and while in Rome entered into relations with the Pretender. He was in Edinburgh in 1745, and so compromised himself that, after the battle of Culloden, he found it necessary to return to the Continent where he remained until 1763. It was not indeed until 1771 he was fully pardoned for any complicity he may have had in the rebellion. He died at his family seat, Coltness, in Lanarkshire, on the 26th of November 1780. In 1767 was published Steuart's *Inquiry into the Principles of Political Economy*. It was the most complete and systematic survey of the science from the point of view of moderate mercantilism which had appeared in England. But the time for the mercantile doctrines was past. Nine years later the *Wealth of Nations* was given to the world. Adam Smith never quotes or mentions Steuart's book; being acquainted with Steuart, whose conversation he said was better than his book, he probably wished to keep clear of controversy with him. German economists have examined Steuart's treatise more carefully than English writers; and they have recognized its high merits, especially in relation to the theory of value and the subject of population. They have also pointed out that, in the spirit of the best modern research, he has dwelt on the special characters which distinguish the economies proper to different nations and different grades in social progress.

The Works, Political, Metaphysical and Chronological, of the late Sir James Steuart of Coltness, Bart., now first collected, with Anecdotes of the Author, by his Son, General Sir James Denham Steuart, were published in 6 vols. 8vo in 1805. Besides the Inquiry they include—A Dissertation upon the Doctrine and Principles of Money applied to the German Coin (1758), Apologie du sentiment de M. le Chevalier Newton sur l'ancienne chronologie des Grecs (4to, Frankfurt-on-the-Main, 1757), The Principles of Money applied to the Present State of Bengal, published at the request of the East India Company (4to, 1772), A Dissertation on the Policy of Grain (1783), Plan for Introducing Uniformity in Weights and Measures within the Limits of the British Empire (1790), Observations on Beattie's Essay on Truth, A Dissertation concerning the Motive of Obedience to the Law of God, and other treatises.

STEBEN, FREDERICK WILLIAM AUGUSTUS HENRY FERDINAND, BARON VON (1730-1794), German soldier, was born at Magdeburg, Prussia, on the 15th of November 1730, the son of William Augustine Steuben (1699-1783), also a soldier. At fourteen he served as a volunteer in a campaign of the Austrian Succession War. He became a lieutenant in 1753, fought in the Seven Years' War, was made adjutant-general of the free corps in 1754 but re-entered the regular army in 1761, and became an aide to Frederick the Great in 1762. Leaving the army after the war, he was made canon of the cathedral of Havelberg, and subsequently was grand-marshal to the prince of Hohenzollern-Hechingen. In 1777 his friend, the count St Germain, then the French minister of war, persuaded him to go to the assistance of the American colonists, who needed discipline and instruction in military tactics. Steuben arrived at Portsmouth, New Hampshire, on the 1st of December 1777, and offered his services to Congress as a volunteer. In March 1778 he began drilling the inexperienced soldiers at Valley Forge; and by May, when he was made inspector-general, with the rank of major-general, he had established a thorough system of discipline and economy.

Results of his work were shown in the next campaign, particularly at Monmouth, where he rallied the disordered, retreating troops of General Charles Lee. His *Regulations for the Order and Discipline of the Troops of the United States* (1779) was of great value to the army. He was a member of the court-martial which tried Major John André in 1780, and after General Horatio Gates's defeat at Camden was placed in command of the district of Virginia, with special instructions "to collect, organize, discipline and expedite the recruits for the Southern army." In April 1781 he was superseded in command of Virginia by La Fayette and later took part in the siege of Yorktown. Retiring from the service after the war, he passed the last years of his life at Steubenville, New York, where he died on the 28th of November 1794. New York, Virginia, Pennsylvania and New Jersey gave him grants of land for his services, and Congress passed a vote of thanks and gave him a gold-hilted sword in 1784 and later granted him a pension of \$2400.

See Frederick Kapp, *The Life of Frederick William von Steuben* (New York, 1859); and George W. Greene, *The German Element in the War of American Independence* (Cambridge, Massachusetts, 1876).

STEUBENVILLE, a city and the county-seat of Jefferson county, Ohio, U.S.A., on the west bank of the Ohio river, about 40 m. W. of Pittsburgh. Pop. (1880), 12,093; (1890), 13,394; (1900), 14,349, of whom 1815 were foreign-born and 736 were negroes; (1910 U.S. census) 22,391. It is served by the Wheeling & Lake Erie (Wabash system), the Pittsburg, Cincinnati, Chicago & St Louis (Pennsylvania system), and the Pennsylvania railways, and by inter-urban electric railways. A suspension bridge crosses the Ohio river here. Steubenville is on a high plain (the second terrace of the river), surrounded by hills 300–500 ft. high, in a good farming country, rich in bituminous coal, natural gas, building-stone, petroleum and clay. The City has a Carnegie library, Gill hospital, a Y.M.C.A. building and Stanton and Altamont parks. The value of its factory products increased from \$4,547,049 in 1900 to \$12,369,677 in 1905, or 172 %—the greatest increase during this period for any city, with a population of 8000 or over in 1900, in the state; during the same period the capital invested in manufacturing industries increased from \$2,302,563 to \$12,627,048 or 448.4 %. Among manufactures are iron and steel, tin and terne plate, glass, paper and wood pulp, and pottery. Near the city limits are building-stone quarries and coal-mines. The municipality owns and operates the waterworks. Steubenville was platted as a town in 1797, immediately after the erection of Jefferson county, and was built on the site of Fort Steuben, erected in 1786–1787, and named in honour of Baron Frederick William von Steuben; it received a city charter in 1851, and its city limits were much enlarged in 1871.

See W. H. Hunter, "The Pathfinders of Jefferson County," and "The Centennial of Jefferson County," in *Ohio Archaeological and Historical Review*, vol. vi. Nos. 2, 3 (Columbus, 1898).

STEUCCO [in Latin *STEUCHUS* or *EUGUBINUS*], **AGOSTINO** (1496–1549), Italian scholar and divine, was born at Gubbio in Umbria. In 1513 he entered the congregation of the canons of St Saviour, and for some years earned his living by teaching Oriental languages, theology and antiquities. In 1525 he became librarian of the convent of Sant' Antonio at Venice, returning later to Gubbio as prior of his congregation. In 1538 he was made bishop of Chisamo in Crete, but returned after a year or two to Rome, where in 1542 he succeeded Alessandro as prefect of the Vatican Library. He wrote many works on sacred antiquities and Bible exegesis.

See Hoefler, *Nouvelle biographie générale* (Paris, 1857–1870).

STEVEDORE, a person who is engaged in the stowage of cargo on board a ship, one who loads and unloads vessels in port. The word is an adaptation of the Spanish *estivador*, literally a packer, *estivar*, to press or pack closely, Latin *stipare*, to press. The Spanish word was particularly applied to the packers of wool, when Spain was a great wool-exporting country, and thus came into general mercantile use.

STEVENAGE, an urban district in the Hitchin parliamentary division of Hertfordshire, England, 28½ m. N. of London by the

Great Northern railway. Pop. (1901), 3957. The church of St Nicholas, with a graceful tower and spire, is mainly Early English, but has Norman and later portions. There is a grammar school, founded in 1558. By the North Road, south of the town, is a row of six large barrows, considered to be of Danish construction.

STEVENS, ALFRED (1818–1875), British sculptor, was born at Blandford in Dorset on the 28th of January 1818. He was the son of a house painter, and in the early part of his career he painted pictures in his leisure hours. In 1833, through the kindness of the rector of his parish, he was enabled to go to Italy, where he spent nine years in study at Naples, Rome, Florence, Milan and Venice. He had never been at an English school. In 1841 Thorwaldsen employed him for a year in Rome. After this he left Italy for England, and in 1845 he obtained a tutorial position in the School of Design, London. This post he occupied until 1847. In 1850 he became chief artist to a Sheffield firm of workers in bronze and metal. In 1852 he returned to London. To this period belongs his design for the vases on the railings in front of the British Museum, and also the lions on the dwarf posts which were subsequently transferred to the inside of the museum. In 1856 occurred the competition for the Wellington monument, originally intended to be set up under one of the great arches of St Paul's Cathedral, though it was only consigned to that position in 1892. Stevens agreed to carry out the monument for £20,000—a quite inadequate sum, as it afterwards turned out. The greater part of his life as a sculptor Stevens devoted to this grand monument, constantly harassed and finally worn out by the interference of government, want of money and other difficulties. Stevens did not live to see the monument set up—perhaps fortunately for him, as it was for many years placed in a small side chapel, where the effect of the whole was utterly destroyed and its magnificent bronze groups hidden from view. Stevens was aware of the position finally decided on for the work, and he suppressed the equestrian group intended for the summit and left the model for the latter feature in a rough state. On the removal of the monument from the chapel to the intercolumnar space on the north side of the nave for which it was originally designed, the model of horse and man was placed in the hands of an able young sculptor, trained mainly in another school, to be worked upon and cast in bronze. The incongruity of the idea did not strike those responsible for the proceeding. Its completion was still not carried into effect in 1910, after years of work and polemics, and it was feared that it would have a disastrous result on the masterpiece as a whole. Indeed the president of the Royal Institute of British Architects declared that the structure would not bear the weight of the addition. The monument itself consists of a sarcophagus supporting a recumbent bronze effigy of the duke, over which is an arched marble canopy of late Renaissance style on delicately enriched shafts. At each end of the upper part of the canopy is a large bronze group, one representing Truth tearing the tongue out of the mouth of Falsehood, and the other Valour trampling Cowardice underfoot. The two virtues are represented by very stately female figures modelled with wonderful beauty and vigour; the vices are two nude male figures treated in a very massive way. The vigorous strength of these groups recalls the style of Michelangelo, but Stevens's work throughout is original and has a very distinct character of its own. Owing to the many years he spent on this one work Stevens did not produce much other sculpture. In Dorchester House, Park Lane, there is some of his work, especially a very noble mantelpiece supported by nude female caryatids in a crouching attitude, modelled with great largeness of style. He also designed mosaics to fill the spandrels under the dome of St Paul's. Stevens died in London on the 1st of May 1875.

See *SCULPTURE: British*; Sir William Armstrong, *Alfred Stevens* (London, 1881); H. Stannus, *Alfred Stevens* (London, 1891).

STEVENS, ALFRED (1828–1906), Belgian painter, was born in Brussels on the 11th of May 1828. His father, an old officer in the service of William I., king of the Netherlands, was passionately fond of pictures, and readily allowed his son to draw in the

studio of François Navez, director of the Brussels Academy. In 1844 Stevens went to Paris and worked under the instruction of Camille Roqueplan, a friend of his father's; he also attended the classes at the École des Beaux Arts, where Ingres was then professor. In 1849 he painted at Brussels his first picture, "A Soldier in Trouble," and in the same year went back to Paris, where he definitely settled, and exhibited in the Salons. He then painted "Ash-Wednesday Morning," "Burghers and Country People finding at Daybreak the Body of a Murdered Gentleman," "An Artist in Despair," and "The Love of Gold." In 1855 he exhibited at the Antwerp Salon a little picture called "At Home," which showed the painter's bent towards depicting ladies of fashion. At the Great Exhibition in Paris, 1855, his contributions were remarkable, but in 1857 he returned to graceful female subjects, and his path thenceforth was clear before him. At the Great Exhibition of 1867 he was seen in a brilliant variety of works in the manner he had made his own, sending eighteen exquisite paintings; among them were the "Lady in Pink" (in the Brussels Gallery), "Consolation," "Every Good Fortune," "Miss Fauvette," "Ophelia," and "India in Paris." At the Paris International Exhibitions of 1878 and 1889, and at the Historical Exhibition of Belgian Art, Brussels, 1880, he exhibited "The Four Seasons" (in the Palace at Brussels), "The Parisian Sphinx," "The Japanese Mask," "The Japanese Robe," and "The Lady-bird" (Brussels Gallery). He died on the 24th of August 1906. "Alfred Stevens is one of the race of great painters," wrote Camille Lemonnier, "and like them he takes immense pains with the execution of his work." The example of his finished technique was salutary, not merely to his brethren in Belgium, but to many foreign painters who received encouragement from the study of his method. The brother of Alfred Stevens, Joseph Stevens, was a great painter of dogs and dog life.

See J. du Jardin, *L'Art flamand*; Camille Lemonnier, *Histoire des beaux arts en Belgique*.

STEVENS, HENRY (1819-1886), American bibliographer, was born in Barnet, Vermont, on the 24th of August 1819. He studied at Middlebury College, Vermont, in 1838-1839, graduated at Yale in 1843 and studied at the Cambridge (Massachusetts) Law School in 1843-1844. In 1845 he went to London, where he was employed during most of the remainder of his life as a collector of Americana for the British Museum and for various public and private American libraries. He was engaged by Sir Anthony Panizzi, librarian of the British Museum, to collect historical books, documents, journals, &c., concerning North and South America; and he was purchasing agent for the Smithsonian Institution and for the library of Congress, as well as for James Lenox, of New York, for whom he secured much of the valuable Americana in the Lenox library in that city, and for the John Carter Brown library, at Providence, Rhode Island. He became a member of the Society of Antiquaries in 1852, and in 1877 was a member of the committee which organized the Caxton Exhibition, for which he catalogued the collection of Bibles. He died at South Hampstead, England, on the 28th of February 1886.

His principal compilations and publications were: an *Analytical Index to the Colonial Documents of New Jersey in the State Paper Office in England* (1858), constituting vol. v. of the New Jersey Historical Society's *Collections*; *Collection of Historical Papers relating to Rhode Island . . . 1640-1775* (6 vols.), for the John Carter Brown library; historical indexes of the colonial documents relating to Maryland (10 vols.), now in the library of the Maryland Historical Society; and a collection of papers relating to Virginia for the period 1585-1775, incomplete, deposited in the Virginia state library in 1858; a valuable *Catalogue of American Maps in the Library of the British Museum* (1856); catalogues of American, of Mexican and other Spanish-American and of Canadian and other British North American books in the library of the British Museum; *Historical and Geographical Notes on the Earliest Discoveries in America, 1453-1530, with Comments on the Earliest Maps and Charts, &c.* (1869); *Sebastian Cabot - John Cabot = o* (1870); *The Bibles in the Caxton Exhibition, 1877* (1878); and *Recollections of Mr James Lenox, of New York, and the Formation of his Library* (1886).

His brother, BENJAMIN FRANKLIN STEVENS (1833-1902), also a bibliographer, was born at Barnet, Vermont, on the

19th of February 1833, was educated at the university of Vermont, and in 1860 became associated with his brother in London. For about thirty years he was engaged in preparing a chronological list and alphabetical index of American state papers in English, French, Dutch and Spanish archives, covering the period from 1763 to 1784, and he prepared more than 2000 facsimiles of important American historical manuscripts found in European archives and relating to the period between 1773 and 1783. He also acted as purchasing agent for various American libraries, and for about thirty years before his death was United States despatch agent at London and had charge of the mail intended for the vessels of the United States navy serving in Atlantic or European stations. He died at Surbiton, Surrey, England, on the 5th of March 1902.

His principal publications include *Campaign in Virginia, 1781: an Exact Reprint of Six Rare Pamphlets on the Clinton-Cornwallis Controversy, with . . . Manuscript Notes by Sir Henry Clinton; with a Supplement containing Extracts from the Journals of the House of Lords* (1888); *Facsimiles of Manuscripts in European Archives Relating to America, 1773-1783, with Descriptions, References and Translations* (25 vols., 1889-1898); *General Sir William Howe's Orderly Book at Charlestown, Boston and Halifax* (1890); and *Columbus: His Own Book of Privileges, 1502* (1893).

STEVENS, THADDEUS (1792-1868), American political leader, was born in Danville, Vermont, on the 4th of April 1792. He graduated at Dartmouth College in 1814, removed to York, Pennsylvania, was admitted to the bar (in Maryland), and for fifteen years practised at Gettysburg, Pennsylvania. He was a leader of the Anti-Masons in Pennsylvania, and was prominent in the national Anti-Masonic Convention at Baltimore in 1831. He served in the Pennsylvania House of Representatives, first as an Anti-Mason and later as a Whig, in 1833-1835, 1838-1839 and 1841-1842. On the 11th of April 1835 he made an eloquent speech in defence of free public education. A partner's venture in the iron business having involved him in a debt of \$217,000, he retired from public life in 1842 and practised law in Lancaster, Pennsylvania, with such success as within six years to reduce this debt to \$30,000. He frequently appeared in behalf of fugitive slaves before the Pennsylvania courts, and previously, in the state constitutional convention of 1837, he had refused to sign the constitution limiting the suffrage to white freemen. In 1840 he did much in Pennsylvania to bring about the election of W. H. Harrison, and in the campaign of 1844 Stevens again rendered marked services to the Whig ticket. He was a Whig representative in Congress in 1849-1853, and was leader of the radical Whigs and Free-Soilers, strongly opposing the Compromise Measures of 1850, and being especially bitter in his denunciations of the Fugitive Slave Law. In 1855 he took a prominent part in organizing the Republican party in Pennsylvania, and in 1856 was a delegate to the Republican National Convention, in which he opposed the nomination of John C. Frémont. He returned to the National House of Representatives in 1859 and bitterly criticized the vacillation of Buchanan's administration. He became chairman of the ways and means committee on the 4th of July 1861, and until his death was, as James G. Blaine said, "the natural leader who assumed his place by common consent." During the Civil War he was instrumental in having necessary revenue measures passed in behalf of the administration. He was not, however, in perfect harmony with Lincoln, who was far more conservative as well as broader minded and more magnanimous than he; besides this Stevens felt it an injustice that Lincoln in choosing a member of his cabinet from Pennsylvania had preferred Cameron to himself. During the war Stevens urged emancipation of the slave, and earnestly advocated the raising of negro regiments. He not only opposed the president's "ten per cent. plan" in Louisiana and Arkansas (*i.e.* the plan which provided that these states might be reorganized by as many as 10% of the number of voters in 1860 who should ask for pardon and take the oath of allegiance to the United States), but he also refused to accept the Wade-Davis Bill as being far too moderate in character. On the motion of Stevens (Dec. 4, 1865), the two houses appointed a joint committee on reconstruction, and Stevens

was made chairman of the House committee. In his speech of the 18th of December 1865 he asserted that rebellion had *ipso facto* blotted out of being all states in the South, that that section was then a "conquered province," and that its government was in the hands of Congress, which could do with it as it wished. He introduced from the joint committee what became, with changed clause as to the basis of representation, the Fourteenth Amendment, and also the Reconstruction Act of the 6th of February 1867. He also advocated the Freedmen's Bureau bills and the Tenure of Office Act, and went beyond Congress in favouring the confiscation of the property of the Confederate States and "of the real estate of 70,000 rebels who own above 200 acres each, together with the lands of their several states," for the benefit of the freedmen and loyal whites and to reimburse, it was said, the sufferers from Lee's invasion of Pennsylvania, during which Stevens's own ironworks at Chambersburg had been destroyed. He led Congress in the struggle with the president, and after the president's removal of Secretary of War Stanton he reported the impeachment resolution to the house and was chairman of the committee appointed to draft the articles of impeachment. He was one of the managers appointed to conduct the case for the House of Representatives before the Senate, but owing to ill-health he took little part in the trial itself. He died at Washington, D.C., on the 11th of August 1868, and was buried at Lancaster, Pennsylvania.¹

Stevens was an extreme partisan in politics; and his opponents and critics have always charged him with being vindictive and revengeful toward the South. Instead of obtaining political and social equality for the negro, his policy intensified racial antagonism, forced practically all of the white people of the South into the Democratic party, and increased the difficulties in the way of a solution of the race problem; the policy, however, was the result of the passions and political exigencies of the time, and Stevens cannot be held responsible except as the leader of the dominant faction in Congress. He was an able, terse, forcible speaker, master of bitter sarcasm, irony, stinging ridicule, and, less often used, good-humoured wit.

See S. W. McCall's *Thaddeus Stevens* (Boston and New York, 1899), in the American Statesmen Series, a sympathetic, but judicious biography; also J. F. Rhodes, *History of the United States from the Compromise of 1850*, especially vol. v. (New York, 1904).

STEVENSON, ADLAI EWING (1835—), American political leader, was born in Christian county, Kentucky, on the 23rd of October 1835. He removed with his family to Bloomington, Illinois, in 1852; was educated at the Illinois Wesleyan University at Bloomington and at Centre College, Danville, Kentucky; and was admitted to the Illinois bar in 1857. He was master in chancery for Woodford county, Illinois, in 1860-1864, and district-attorney for the twenty-third judicial district of that state from 1865 to 1869, when he removed to Bloomington. He was a Democratic representative in Congress from Illinois in 1875-1877 and again in 1879-1881; was first assistant postmaster-general in 1885-1889, and was severely criticized for his wholesale removal of Republican postmasters. He was a delegate to the national Democratic conventions in 1884 and 1892, and in the latter year was elected vice-president of the United States on the ticket with Cleveland, serving from 1893 to 1897. In 1897 he was a member of the commission (Senator Edward O. Wolcott and General Charles J. Paine being the other members) appointed by President McKinley to confer with the governments of Great Britain, France and Germany with a view to the establishment of international bimetalism. He

¹ In accordance with his own wish he was buried in a small graveyard rather than in one of the regular city cemeteries, and on his tombstone is the following epitaph written by himself: "I repose in this quiet and secluded spot, not from any natural preference for solitude, but, finding other cemeteries limited as to race by charter rules, I have chosen this, that I might illustrate in my death the principles I advocated through a long life—Equality of man before his Creator." He bequeathed a part of his estate to found a home for white and negro orphans—the present Thaddeus Stevens industrial school—at Lancaster.

was again Democratic nominee for vice-president in 1900, but was defeated. He published *Something of Men I have Known; With Some Papers of a General Nature, Political, Historical and Retrospective* (1909).

STEVENSON, ROBERT (1772-1850), Scottish engineer, was the only son of Alan Stevenson, partner in a West Indian house in Glasgow, and was born in that city on the 8th of June 1772. He was educated at Anderson's College, Glasgow, and Edinburgh University. In his youth he assisted his stepfather, Thomas Smith, in his lighthouse schemes, and at the age of nineteen was sent to superintend the erection of a lighthouse on the island of Little Cumbrae. Subsequently he succeeded Smith, whose daughter he married in 1799, as engineer to the Commissioners of Northern Lighthouses, and during his period of office, from 1797 to 1843, he designed and executed a large number of lighthouses, the most important being that on the Bell Rock, begun in 1807. For its illumination he introduced an improved apparatus, and he was also the author of various valuable inventions in connexion with lighting, including the intermittent and flashing lights, and the mast lantern for lightships. As a civil engineer he improved the approaches to Edinburgh, including that by the Calton Hill, constructed harbours, docks and breakwaters, improved river and canal navigation, and constructed several important bridges. In consequence of observations made by him George Stephenson advocated the use of malleable- instead of cast-iron rails for railways, and he was the inventor of the movable jib and balance cranes. Chiefly through his interposition an admiralty survey was established, from which the admiralty sailing directions for the coasts of Great Britain and Ireland have been prepared. Stevenson published an *Account of the Bell Rock Lighthouse* in 1824, and, besides contributing important articles on engineering subjects to Brewster's *Edinburgh Encyclopaedia* and the *Encyclopaedia Britannica*, was the author of various papers read before learned societies. He died at Edinburgh on the 12th of July 1850.

Of his family, three sons, Alan, David and Thomas, attained distinction as lighthouse engineers. The eldest, ALAN (1807-1865), eventually became a partner with his father, whom he succeeded as engineer to the Commissioners of Northern Lighthouses in 1843. The most noteworthy lighthouse designed by him is Skerryvore on the west coast of Scotland, an isolated tower of which the first stone was laid in 1840 and which first showed its light in 1843. He published an *Account of the Skerryvore Lighthouse* in 1848, and a *Rudimentary Treatise on the History, Construction and Illumination of Lighthouses* in 1850, and he wrote the article on lighthouses in the 8th edition of the *Encyclopaedia Britannica*. The third son, DAVID (1815-1886), was at first engaged on land and marine surveys and in railway work. In 1837 he made a tour in North America, which gave rise to his *Sketch of the Civil Engineering of North America* (1838), and on his return became a partner in his father's business. In 1853 he and his youngest brother Thomas were appointed joint engineers to the Commissioners of Northern Lighthouses in succession to their brother Alan, and he designed many lighthouses not only in Scotland but also in New Zealand, India and Japan. His books include *Marine Surveying* (1842), *Canal and River Engineering* (1858), *Reclamation and Protection of Agricultural Land* (1874), and *Life of Robert Stevenson* (1878), and he was also a contributor to the 8th and 9th editions of the *Encyclopaedia Britannica*. The youngest son, THOMAS (1818-1887), joined his father's business in 1846, and as joint engineer to the Commissioners of Northern Lighthouses from 1853 to 1885 introduced various improvements in lighthouse illumination, which were described in the article on lighthouses he wrote for the 9th edition of the *Encyclopaedia Britannica*. He was also deeply interested in meteorology, and in 1864 designed the Stevenson screen widely used for the sheltering of thermometers. He was the father of Robert Louis Stevenson.

STEVENSON, ROBERT LEWIS BALFOUR (1850-1894), British essayist, novelist and poet, was the only child of Thomas Stevenson, civil engineer, and his wife, Margaret Isabella Balfour. He was born at 8 Howard Place, Edinburgh, on the 13th of

November 1850. He suffered from infancy from great fragility of health, and nearly died in 1858 of gastric fever, which left much constitutional weakness behind it. From the age of six he showed a disposition to write. He went to school, mainly in Edinburgh, from 1858 to 1867, but his ill-health prevented his learning much, and his teachers, as his mother afterwards said, "liked talking to him better than teaching him." He often accompanied his father on his official visits to the lighthouses of the Scottish coast and on longer journeys, thus early accustoming himself to travel. As his health improved it was hoped that he would be able to adopt the family profession of civil engineering, and in 1868 he went to Anstruther and then to Wick as a pupil engineer. In 1871 he had so far advanced as to receive the silver medal of the Edinburgh Society of Arts for a paper suggesting improvements in lighthouse apparatus. But long before this he had started as an author. His earliest publication, the anonymous pamphlet of *The Pentland Rising*, had appeared in 1866, and *The Charity Bazaar*, a trifle in which his future manner is happily displayed, in 1868. From about the age of eighteen he dropped his baptismal names of Lewis Balfour and called himself Robert Louis, but was mostly known to his relatives and intimate friends as "Louis." Although he greatly enjoyed the outdoor business of the engineer's life it strained his physical endurance too much, and in 1871 was reluctantly exchanged for study at the Edinburgh bar, to which he was called in 1875. In 1873 he first met Mr Sidney Colvin, who was to prove the closest of his friends and at last the loyal and admirable editor of his works and his correspondence; and to this time are attributed several of the most valuable friendships of Stevenson's life.

He was now labouring, with extreme assiduity, to ground himself in the forms and habits of literary style. In 1875 appeared, anonymously, his *Appeal to the Clergy of the Church of Scotland*, and in that year he made the first of many visits to the forest of Fontainebleau. Meanwhile at Mentone in the winter of 1873-1874 he had grown in mind under the shadow of extreme physical weakness, and in the following spring began to contribute essays of high originality to one or two periodicals, of which the *Cornhill*, then edited by Sir Leslie Stephen, was at first the most important. Stevenson made no attempt to practice at the bar, and the next years were spent in wanderings in France, Germany and Scotland. Records of these journeys, and of the innocent adventures which they encouraged, were given to the world as *An Inland Voyage* in 1878, and as *Travels with a Donkey in the Cevennes* in 1879. During these four years Stevenson's health, which was always bettered by life out of doors, gave him little trouble. It was now recognized that he was to be an author, and he contributed many essays, tales and fantasies to various journals and magazines. At Fontainebleau in 1876 Stevenson had met Mrs Osbourne, the lady who afterwards became his wife; she returned to her home in California in 1878, and in August of the following year, alarmed at news of her health, Stevenson hurriedly crossed the Atlantic. He travelled, from lack of means, as a steerage passenger and then as an emigrant, and in December, after hardships which seriously affected his health, he arrived in San Francisco. In May 1880 he married, and moved to the desolate mining-camp which he has described in *The Silverado Squatters*. As Mr Colvin has well said, these months in the west of America were spent "under a heavy combined strain of personal anxiety and literary effort." Some of his most poignant and most enchanting letters were written during this romantic period of his life. In the autumn of 1880 he returned to Scotland, with his wife and stepson, who were received at once into the Edinburgh household of his parents. But the condition of his health continued to be very alarming, and they went almost immediately to Davos, where he remained until the spring of 1881. In this year was published *Virginibus puerisque*, the earliest collection of Stevenson's essays. He spent the summer months in Scotland, writing articles, poems, and above all his first romance, *The Sea-Cook*, afterwards known as *Treasure Island*; but he was driven back to Davos in October. In 1882 appeared *Familiar Studies of*

Men and Books and *New Arabian Nights*. His two winters at Davos had done him some good, but his summers in Scotland invariably undid the benefit. He therefore determined to reside wholly in the south of Europe, and in the autumn of 1882 he settled near Marseilles. This did not suit him, but from March 1883 to July 1884 he was at home at a charming house called La Solitude, above Hyères; this was in many ways to be the happiest station in the painful and hurrying pilgrimage of Stevenson's life. *The Silverado Squatters* was published in 1883, and also the more important *Treasure Island*, which made Stevenson for the first time a popular writer. He planned a vast amount of work, but his schemes were all frustrated in January 1884 by the most serious illness from which he had yet suffered. He was just pulled through, but the attack was followed by long prostration and incapacity for work, and by continued relapses. In July he was brought back to England, and from this time until August 1887 Stevenson's home was at Bournemouth. In 1885 he published, after long indecision, his volume of poems, *A Child's Garden of Verses*, an inferior story, *The Body Snatcher*, and that admirable romance, *Prince Otto*, in which the peculiar quality of Stevenson's style was displayed at its highest. He also collaborated with W. E. Henley in some plays, *Beau Austin*, *Admiral Guinea* and *Robert Macaire*. Early in 1886 he struck the public taste with precision in his wild symbolic tale of *The Strange Case of Dr Jekyll and Mr Hyde*. In the summer of the same year he published *Kidnapped*, which had been written at Bournemouth.

This, however, was a period of great physical prostration, so that 1886 and 1887 were perforce among the least productive years of Stevenson's life. In the early months of 1887 Stevenson was particularly ill, and he was further prostrated by being summoned in May to the deathbed of his father, who had just returned to Edinburgh from the south. He printed privately as a pamphlet, in June 1887, a brief and touching sketch of his father. In July he published his volume of lyrical poems called *Underwoods*. The ties which bound him to England were now severed, and his health was broken to such a discouraging degree that he determined to remove to another hemisphere. Accordingly, having disposed of Skerryvore, his house at Bournemouth, he sailed from London, with his wife, mother and stepson, for New York on the 17th of August 1887. He never set foot in Europe again. His memoir of his friend Professor Fleeming Jenkin was published soon after his departure. After resting at Newport, he went for the winter to be under the care of a physician at Saranac Lake in the Adirondacks for the winter. Here he was very quiet, and steadily active with his pen, writing both the greater part of the *Master of Ballantrae* and many of his finest later essays. He had undertaken, for a regular payment greatly in excess of anything which he had hitherto received, to contribute a monthly essay to *Scribner's Magazine*, and these essays, twelve in number, were published continuously throughout the year 1888. Early in that year was begun *The Wrong Box*, a farcical romance in which Mr Lloyd Osbourne participated; Stevenson also began a romance about the Indian Mutiny, which he abandoned. His attitude about this time to life and experience is reflected in *Pulvis et umbra*, one of the noblest of all his essays. In April 1888 he was at the coast of New Jersey for some weeks, and in June started for San Francisco, where he had ordered a schooner, the "Casco," to be ready to receive him. On the 28th of the month, he started, as Mr Colvin has said, "on what was only intended to be a pleasure excursion . . . but turned into a voluntary exile prolonged until the hour of his death": he never again left the waters of the Pacific. The "Casco" proceeded first to the Marquesas, and south and east to Tahiti, passing before Christmas northwards to Honolulu, where Stevenson spent six months and finished *The Master of Ballantrae* and *The Wrong Box*. It was during this time that he paid his famous visit to the leper settlement at Molokai. In 1889, "on a certain bright June day," the Stevensons sailed for the Gilbert Islands, and after six months' cruising found themselves at Samoa, where he landed for the first time about Christmas Day 1889. On this occasion, however, though

strongly drawn to the beautiful island, he stayed not longer than six weeks, and proceeded to Sydney, where, early in 1890, he published, in a blaze of righteous anger, his *Father Damien: an Open Letter to the Rev. Dr Hyde of Honolulu*, in vindication of the memory of Father Damien and his work among the lepers of the Pacific. At Sydney he was very ill again: it was now obvious that his only chance of health lay within the tropics. For nearly the whole of the year 1890 the Stevensons were cruising through unfamiliar archipelagos [on board a little trading steamer, the "Janet Nicholl." Meanwhile his volume of *Ballads* was published in London.

The last four years of his unquiet life were spent at Samoa, in circumstances of such health and vigour as he had never previously enjoyed, and in surroundings singularly picturesque. It was in November 1890 that he made his abode at Vailima, where he took a small barrack of a wooden box 500 ft. above the sea, and began to build himself a large house close by. The natives gave him the name of Tusitala. His character developed unanticipated strength on the practical side; he became a vigorous employer of labour, an active planter, above all a powerful and benignant island chieftain. He gathered by degrees around him "a kind of feudal clan of servants and retainers," and he plunged, with more generous ardour than coolness of judgment, into the troubled politics of the country. He took up the cause of the deposed king Mataafa with extreme ardour, and he wrote a book, *A Footnote to History: Eight Years of Trouble in Samoa* (1892), in the endeavour to win over British sympathy to his native friends. In the autumn of this year he received a visit at Vailima from the countess of Jersey, in company with whom and some others he wrote the burlesque extravagance in prose and verse, called *An Object of Pity*, privately printed in 1893 at Sydney. Whenever the cultivation of his estate and the vigorous championship of his Samoan retainers gave him the leisure, Stevenson was during these years almost wholly occupied in writing romances of Scottish life. *The Wrecker*, an adventurous tale of American life, which mainly belonged to an earlier time, was written in collaboration with Mr Lloyd Osbourne and finally published in 1892; and towards the close of that very eventful and busy year he began *The Justice Clerk*, afterwards *Weir of Hermiston*. A portion of the old record of emigrant experiences in 1879, long suppressed for private reasons, also appeared in book form in 1892. In 1893 Stevenson published the important Scottish romance of *Catriona*, written as a sequel to *Kidnapped*, and the three tales illustrative of Pacific Ocean character, *Island Nights' Entertainments*. But in 1893 the uniform good fortune which had attended the Stevensons since their settlement in Samoa began to be disturbed. The whole family at Vailima became ill, and the final subjugation of his protégé Mataafa, and the destruction of his party in Samoan politics, deeply distressed and discouraged Stevenson. In a series of letters to *The Times* he exposed the policy of the chief justice, Mr Cedercrantz, and the president of the council, Baron Senfft. He so influenced public opinion that both were removed from office. In the autumn of that year he went for a change of scene to the Sandwich Islands, but was taken ill there, and was only too glad to return to Samoa. In 1894 he was greatly cheered by the plan, suggested by friends in England and carried out by them with the greatest energy, of the noble collection of his works in twenty-eight volumes, since known as the Edinburgh editions. In September 1894 was published *The Ebb Tide*, the latest of his books which he saw through the press. Of Stevenson's daily avocations, and of the temper of his mind through these years of romantic exile, a clear idea may be obtained by the posthumous *Vailima Letters*, edited by Mr Sidney Colvin in 1895. Through 1894 he was engaged in composing two romances, neither of which he lived to complete. He was dictating *Weir of Hermiston*, apparently in his usual health, on the day he died. This was the 3rd of December 1894; he was gaily talking on the verandah of his house at Vailima when he had a stroke of apoplexy, from which he never recovered consciousness, and passed away painlessly in the course of the evening. His body was carried next day by sixty sturdy

Samoans, who acknowledged Stevenson as their chief, to the summit of the precipitous peak of Vaea, where he had wished to be buried, and where they left him to rest for ever with the Pacific Ocean at his feet.

The charm of the personal character of Stevenson and the romantic vicissitudes of his life are so predominant in the minds of all who knew him, or lived within earshot of his legend, that they made the ultimate position which he will take in the history of English literature somewhat difficult to decide. That he was the most attractive figure of a man of letters in his generation is admitted; and the acknowledged fascination of his character was deepened, and was extended over an extremely wide circle of readers, by the publication in 1890 of his *Letters*, which have subdued even those who were rebellious to the entertainment of his books. It is therefore from the point of view of its "charm" that the genius of Stevenson must be approached, and in this respect there was between himself and his books, his manners and his style, his practice and his theory, a very unusual harmony. Very few authors of so high a class have been so consistent, or have made their conduct so close a reflection of their philosophy. This unity of the man in his work makes it difficult, for one who knew him, to be sure that one rightly gauges the purely literary significance of the latter. There are some living who still hear in every page of Stevenson the voice of the man himself, and see in every turn of his language his flashing smile. So far, however, as it is possible to disengage one's self from this captivation, it may be said that the mingling of distinct and original vision with a singularly conscientious handling of the English language, in the sincere and wholesome self-consciousness of the strenuous artist, seems to be the central feature of Stevenson as a writer by profession. He was always assiduously graceful, always desiring to present his idea, his image, his rhapsody, in as persuasive a light as possible, and, particularly, with as much harmony as possible. He had mastered his manner and, as one may say, learned his trade, in the exercise of criticism and the reflective parts of literature, before he surrendered himself to that powerful creative impulse which had long been tempting him, so that when, in mature life, he essayed the portraiture of invented character he came to it unhampered by any imperfection of language. This distinguished mastery of style, and love of it for its own sake within the bounds of good sense and literary decorum, gave him a pre-eminence among the story-tellers of his time. No doubt it is still by his romances that Stevenson keeps the wider circle of his readers. But many hold that his letters and essays are finer contributions to pure literature, and that on these exquisite mixtures of wisdom, pathos, melody and humour his fame is likely to be ultimately based. In verse he had a touch far less sure than in prose. Here we find less evidence of sedulous workmanship, yet not infrequently a piercing sweetness, a depth of emotion, a sincere and spontaneous loveliness, which are irresistibly touching and inspiring.

The personal appearance of Stevenson has often been described: he was tall, extremely thin, dark-haired, restless, compelling attention with the lustre of his wonderful brown eyes. In the existing portraits of him those who never saw him are apt to discover a strangeness which seems to them sinister or even affected. This is a consequence of the false stability of portraiture, since in life the unceasing movement of light in the eyes, the mobility of the mouth, and the sympathy and sweetness which radiated from all the features, precluded the faintest notion of want of sincerity. Whatever may be the ultimate order of reputation among his various books, or whatever posterity may ultimately see fit to ordain as regards the popularity of any of them, it is difficult to believe that the time will ever come in which Stevenson will not be remembered as the most beloved of the writers of that age which he did so much to cheer and stimulate by his example.

His cousin R. A. M. Stevenson (1847-1900) was an accomplished art-critic, who in 1889 became professor of fine arts at University College, Liverpool; he published several works on art (*Rubens*, 1898; *Velasquez*, 1895; *Raeburn*, 1900).

R. L. Stevenson's other works include: *Memories and Portraits* (1887); *The Merry Men and other Tales and Fables* (1887); *The Black Arrow* (1888); *Edinburgh: Picturesque Notes* (1889); *Across the Plains, with other Memories and Essays* (1892), and the posthumous works, *Songs of Travel and other Verses* (1896), *St Ives* (1899), completed by Sir A. T. Quiller Couch; *A Stevenson Medley* (1899); *In the South Seas: experiences . . . on the "Casco"* (1888) and the *Equator* (1889) (1900). See the *Letters of Stevenson to his Family* (1899), with the critical and biographical preface by Mr Sidney Colvin; *Vailima Letters, to Sidney Colvin* (1895), and the *Life of Robert Louis Stevenson* by Graham Balfour (1901). See also Professor Walter Raleigh, *R. L. Stevenson* (1895), and *Memories of Vailima* (1903), by Isobel Strong and Lloyd Osbourne. A complete edition of Stevenson's works was issued at Edinburgh in 1894-1898. *A Bibliography of the works of R. L. Stevenson* by Colonel W. F. Prideaux appeared in 1903. (E. G.)

STEVENS POINT, a city and the county-seat of Portage county, Wisconsin, U.S.A., on both banks of the Wisconsin river, about 110 m. N. of Madison. Pop. (1890), 7896; (1900), 9524, of whom 2205 were foreign-born; (1910 U.S. census), 8692. Stevens Point is served by the Green Bay & Western and the Minneapolis, St Paul & Sault Ste Marie railways. It is attractively situated, has a fine public school system, including a high school, a manual training school, a domestic science department, and kindergarten and day schools for the deaf. It is the seat of one of the state normal schools (1894), of St Joseph's Academy (Polish), and of the Stevens Point Commercial College, and has a Carnegie library (1904), the Portage county court-house, a city hospital, and a tuberculosis sanatorium. The city is situated in the borders of the pine timber region, and the lumber industry predominates. There are railway repair shops here, and various manufactures. The city has a considerable wholesale jobbing trade, and is an important point of shipment for the products of the agricultural country in the vicinity. Stevens Point was first settled by George Stevens in 1839, was incorporated as a village in 1847, and was first chartered as a city in 1858.

STEVENSTON, a manufacturing town of Ayrshire, Scotland. Pop. (1901), 6554. It is situated about 1 m. from Saltcoats on the coast of the Firth of Clyde, 29 m. S.W. of Glasgow by the Glasgow & South-Western railway. There are coal-mines, several ironworks—one is among the largest in Scotland—and, on the sandhills along the shore, the works of Nobel's Explosives Company, which cover an area of a mile, the separate-hut principle being adopted to minimize the risks attendant upon so dangerous an occupation.

STEVINUS, SIMON (1548-1620), Dutch mathematician, was born in 1548 at Bruges (where the Place Simon Stevin contains his statue by Eugen Simonis) and died in 1620 at the Hague or in Leiden. Of the circumstances of his life very little is recorded; the exact day of his birth and the day and place of his death are alike uncertain. It is known that he left a widow with two children; and one or two hints scattered throughout his works inform us that he began life as a merchant's clerk in Antwerp, that he travelled in Poland, Denmark and other parts of northern Europe, and that he was intimate with Prince Maurice of Orange, who asked his advice on many occasions, and made him a public officer—at first director of the so-called "waterstaet," and afterwards quartermaster-general. The question whether Stevinus, like most of the rest of the prince's followers, belonged to the Protestant creed hardly admits of a categorical answer. A Roman Catholic would perhaps not have been so ready as Stevinus to deny the value of all authority. A Roman Catholic could not well have boasted, as Stevinus in a political pamphlet did, that he had always been in harmony with the executive power. But against these considerations it might be urged that a Protestant had no occasion to boast of a harmony most natural to him, while his further remark to the effect that a state church is indispensable, and that those who cannot belong to it on conscientious grounds ought to leave the country rather than show any opposition to its rites, seems rather to indicate the crypto-Catholic. The same conclusion is supported by the fact that Stevinus, a year before his death, bequeathed a pious legacy to the church of Westkerke in Flanders out of the revenues of which masses were to be said.

His claims to fame are varied. His contemporaries were most struck by his invention of a carriage with sails, a little model of which was preserved at Scheveningen till 1802. The carriage itself had been lost long before; but we know that about the year 1600 Stevinus, with Prince Maurice of Orange and twenty-six others, made use of it on the seashore between Scheveningen and Petten, that it was propelled solely by the force of the wind, and that it acquired a speed which exceeded that of horses. Another idea of Stevinus, for which even Hugo Grotius gave him great credit, was his notion of a bygone age of wisdom. The goal to be aimed at is the bringing about of a second age of wisdom, in which mankind shall have recovered all its early knowledge. The fellow-countrymen of Stevinus were proud that he wrote in their own dialect, which he thought fitted for a universal language, as no other abounded like Dutch in monosyllabic radical words.

Stevinus was the first to show how to model regular and semiregular polyhedra by delineating their frames in a plane. Stevinus also distinguished stable from unstable equilibrium. He proved the law of the equilibrium on an inclined plane. He demonstrated before Pierre Varignon the resolution of forces, which, simple consequence of the law of their composition though it is, had not been previously remarked. He discovered the hydrostatic paradox that the downward pressure of a liquid is independent of the shape of the vessel, and depends only on its height and base. He also gave the measure of the pressure on any given portion of the side of a vessel. He had the idea of explaining the tides by the attraction of the moon. Stevinus seems to be the first who made it an axiom that strongholds are only to be defended by artillery, the defence before his time having relied mostly on small firearms. He was the inventor of defence by a system of sluices, which proved of the highest importance for the Netherlands. His plea for the teaching of the science of fortification in universities, and the existence of such lectures in Leiden, have led to the impression that he himself filled this chair; but the belief is erroneous, as Stevinus, though living at Leiden, never had direct relations with its university.

Book-keeping by double entry may have been known to Stevinus as clerk at Antwerp either practically or through the medium of the works of Italian authors like Lucas Paccioli and Girolamo Cardan. He, however, was the first to recommend the use of impersonal accounts in the national household. He practised it for Prince Maurice, and recommended it to Sully, the French statesman.

His greatest success, however, was a small pamphlet, first published in Dutch in 1586, and not exceeding seven pages in the French translation. This translation is entitled *La Disme enseignant facilement expédier par Nombres Entiers sans rompre tous Comptes se rencontrent aux Affaires des Hommes*. Decimal fractions had been employed for the extraction of square roots some five centuries before his time, but nobody before Stevinus established their daily use; and so well aware was he of the importance of his innovation that he declared the universal introduction of decimal coinage, measures and weights to be only a question of time. His notation is rather unwieldy. The point separating the integers from the decimal fractions seems to be the invention of Bartholomaeus Pitiscus, in whose trigonometrical tables (1612) it occurs and it was accepted by John Napier in his logarithmic papers (1614 and 1619). Stevinus printed little circles round the exponents of the different powers of one-tenth. For instance, $237\frac{5}{10}\frac{7}{10}\frac{8}{10}$ was printed $237 \textcircled{5} \textcircled{7} \textcircled{8}$; and the fact that Stevinus meant those encircled numerals to denote mere exponents is evident from his employing the very same sign for powers of algebraic quantities, e.g. $9 \textcircled{4} - 14 \textcircled{3} + 6 \textcircled{1} - 5$ to denote $9x^4 - 14x^3 + 6x - 5$. He does not even avoid fractional exponents ("Racine cubique de $\textcircled{2}$ serait $\frac{2}{3}$ en circle"), and is ignorant only of negative exponents.

Stevinus wrote on other scientific subjects—optics, geography, astronomy, &c.—and a number of his writings were translated into Latin by W. Snellius. There are two complete editions in French of his works, both printed at Leiden, one in 1608, the other in 1634.

by Albert Girard. See Steichen, *Vie et travaux de Simon Stevin* (Brussels, 1846); M. Cantor, *Geschichte der Mathematik*. (M. CA.)

STEWART, STUART or **STEUART**, the surname of a family which inherited the Scottish and ultimately the English crown. Their descent is traced to a Breton immigrant, Alan the son of Flaald, which Flaald was a brother of Alan, steward (or seneschal) of Dol in Brittany. This elder Alan, whose name occurs in Breton documents before 1080, went on crusade in 1097, and was apparently succeeded by his brother Flaald, whose son, the younger Alan, enjoyed the favour of Henry I., who bestowed on him Mileham and its barony in Norfolk, where he founded Spole Priory. By the daughter of Ernulf de Hesdin (in Picardy), a Domesday baron, he was father of at least three sons: Jordan, who succeeded to the family office of steward of Dol; William, who inherited Mileham and other estates in England, and who founded the great baronial house of Fitz Alan (afterwards earls of Arundel); and Walter, who was made by David I. steward (*dapifer*) or seneschal of Scotland. The Scottish king conferred on Walter various lands in Renfrewshire, including Paisley, where he founded the abbey in 1163. Walter, his grandson, third steward, was appointed by Alexander II. justiciary of Scotland, and, dying in 1246, left four sons and three daughters. The third son, Walter, obtained by marriage the earldom of Menteith, which ultimately came by marriage to Robert, duke of Albany, son of Robert II. Alexander, fourth steward, the eldest son of Walter, third steward, inherited by his marriage with Jean, granddaughter of Somerled, the islands of Bute and Arran, and on the 2nd of October 1263 led the Scots against Haakon IV., king of Norway, at Largs. He had two sons, James and John. The latter, who commanded the men of Bute at the battle of Falkirk in 1298, had seven sons: (1) Sir Alexander, whose grandson George became in 1389 earl of Angus, the title afterwards passing in the female line to the Douglasses, and in 1761 to the duke of Hamilton; (2) Sir Alan of Dreghorn, ancestor of the earls and dukes of Lennox, from whom Lord Darnley, husband of Queen Mary, and also Lady Arabella Stuart, were descended; (3) Sir Walter, who obtained the barony of Garlies, Wigtownshire, from his uncle John Randolph, earl of Moray, and was the ancestor of the earls of Galloway, younger branches of the family being the Stewarts of Tonderghie, Wigtownshire, and also those of Physgill and Glenturk in the same county; (4) Sir James, who fell at Dupplin in 1332, ancestor of the lords of Lorn, on whose descendants were conferred at different periods the earldoms of Athole, Buchan and Traquair, and who were also the progenitors of the Stewarts of Appin, Argyllshire, and of Grandtully, Perthshire; (5) Sir John, killed at Halidon Hill in 1333; (6) Sir Hugh, who fought under Edward Bruce in Ireland; and (7) Sir Robert of Daldowie, ancestor of the Stewarts of Allanton and of Coltness. James Stewart, the elder son of Alexander, fourth steward, succeeded his father in 1283, and, after distinguishing himself in the wars of Wallace and of Bruce, died in 1309. His son Walter, sixth steward, who had joint command with Sir James Douglas of the left wing at the battle of Bannockburn, married Marjory, daughter of Robert the Bruce, and during the latter's absence in Ireland was entrusted with the government of the kingdom. He died in 1326, leaving an only son, who as Robert II. ascended the throne of Scotland in 1371. Sir Alexander Stewart, earl of Buchan, fourth son of Robert II., who earned by his ferocity the title of the "Wolf of Badenoch," inherited by his wife the earldom of Ross, but died without legitimate issue, although from his illegitimate offspring were descended the Stewarts of Belladrum, of Athole, of Garth, of Urrard and of St Fort. On the death of the "Wolf of Badenoch" the earldom of Buchan passed to his brother Robert, duke of Albany, also earl of Fife and earl of Menteith, but these earldoms were forfeited on the execution of his son Murdoch in 1425, the earldom of Buchan again, however, coming to the house of Stewart in the person of James, second son of Sir James Stewart, the black knight of Lorn, by Joan or Joanna, widow of King James I. From Murdoch, duke of Albany, were descended the Stewarts of Ardvoirlich and other families of the name in Perthshire, and also

the Stewarts of Inchbreck and Laithers, Aberdeenshire. From a natural son of Robert II. were descended the Steuarts of Dalguise; Perthshire, and from a natural son of Robert III. the Shaw Stewarts of Blackhall and Greenock. The direct male line of the royal family terminated with the death of James V. in 1542, whose daughter Mary was the first to adopt the spelling "Stuart." Mary was succeeded in her lifetime in 1567 by her only son James VI., who through his father Lord Darnley was also head of the second branch, there being no surviving male issue of the family from progenitors later than Robert II. In James V., son of James IV. by Margaret, daughter of Henry VII., the claims of Margaret's descendants became merged in the Scottish line, and on the death of Queen Elizabeth of England, the last surviving descendant of Henry VIII., James VI. of Scotland, lineally the nearest heir, was proclaimed king of England, in accordance with the arrangements made by Lord Burghley and Elizabeth's other advisers. The accession of James, was, however, contrary to the will of Henry VIII., which favoured the heirs of his younger sister Mary, wife of Charles Brandon, duke of Suffolk, whose succession would probably have marvelously altered the complexion of both Scottish and English history. As it was, the only result of that will was a tragedy initiated by Elizabeth and consummated by James. In the Scottish line the nearest heir after James VI., both to the Scottish and English crowns, was Arabella Stuart, only child of Charles, earl of Lennox, younger brother of Lord Darnley—Lady Margaret Douglas, the mother of Darnley and his brother, having been the daughter of Archibald, sixth earl of Angus, by Margaret of England, queen dowager of James IV. James VI. (I. of England) was thus nearest heir by a double descent, Arabella Stuart being next heir by a single descent. On account of the descent from Henry VII., the jealousy of Elizabeth had already caused her to imprison Arabella's mother Elizabeth, daughter of Sir William Cavendish, on learning that she had presumed to marry Lennox. The daughter's marriage she was determined by every possible means to prevent. She objected when King James proposed to marry her to Lord Esme Stuart, whom he had created duke of Lennox, but when the appalling news reached her that Arabella had actually found a lover in Edward Seymour, grandson of Catherine Grey, heiress of the Suffolks, she was so deeply alarmed and indignant that she immediately ordered her imprisonment. This happened immediately before Elizabeth's death, after which she obtained her release. Soon after the accession of James a conspiracy, of which she was altogether ignorant, was entered into to advance her to the throne, but this caused no alteration in her treatment by James, who allowed her a maintenance of £800 a year. In February 1610 it was discovered that she was engaged to Seymour, and, although she then promised never to marry him without the king's consent, the marriage took place secretly in July following. In consequence of this her husband was sent to the Tower and she was placed in private confinement. Though separated, both succeeded in escaping simultaneously on the 3rd of June 1611; but, less fortunate than her husband, who got safe to the Continent, she was captured in the straits of Dover and shut up in the Tower of London. Her hopeless captivity deprived her of her reason before her sorrows were ended by death, on the 27th of September 1615.

By the usurpation of Cromwell the Stewarts were excluded from the throne from the defeat of Charles I. at Naseby in 1645 until the restoration of his son Charles II. in 1660. Carlyle refers to the opinion of genealogists that Cromwell "was indubitably either the ninth or the tenth or some other fractional part of half a cousin of Charles Stuart," but this has been completely exploded by Walter Rye in the *Genealogist* ("The Steward Genealogy and Cromwell's Royal Descent," new series, vol. ii. pp. 34-42). On the death of Charles II. without issue in 1685, his brother James, duke of York, ascended the throne as James II. but he so alienated the sympathies of the nation by his unconstitutional efforts to further the Roman Catholic religion that an invitation was sent to the prince of Orange to come "to the rescue of the laws and religion of England."

Next to the son of James II., still an infant under his father's control, Mary, princess of Orange, elder daughter of James II., had the strongest claim to the crown; but the claims of the prince of Orange also, even apart from his marriage, were not very remote, since he was the son of Mary, eldest daughter of Charles I. The marriage had strengthened the claims of both, and they were proclaimed joint sovereigns of England on the 12th of February 1689, Scotland following the example of England on the 11th of April. They left no issue, and the Act of Settlement passed in 1701, excluding Roman Catholics from the throne, secured the succession to Anne, second daughter of James II., and on her death without issue to the Protestant house of Hanover, descended from the princess Elizabeth, daughter of James I., wife of Frederick V., count palatine of the Rhine. On the death of Anne in 1714, George, elector of Hanover, eldest son of Sophia (youngest child of the princess Elizabeth), and Ernest, elector of Brunswick-Lüneburg, or Hanover, consequently became sovereign of Great Britain and Ireland, and, notwithstanding somewhat formidable attempts in behalf of the elder Stuart line in 1715 and 1745, the Hanoverian succession has remained uninterrupted and has ultimately won universal assent. The female issue of James II. ended with the death of his daughter, Queen Anne. James, called James III. by the Jacobites and the Old Pretender by the Hanoverians, had two sons—Charles Edward, the Young Pretender, who died without legitimate issue in 1780, and Henry Stuart, titular duke of York, commonly called Cardinal York, on whose death in 1807 the male line of James II. came to an end. Henry was also the last descendant in the lineal male line of any of the crowned heads of the race, so far as either England or Scotland was concerned. In the female line, however, there are among the descendants of James I. representatives of the royal Stuarts who are senior to the house of Hanover, for Philip, duke of Orleans (brother of Louis XIV.), married, as his first wife, Henrietta daughter of Charles I., and, as his second, Charlotte, granddaughter and heiress of the princess Elizabeth (daughter of James I.). By the former, through their daughter, the queen of Sardinia, he was ancestor, among others, of the princess Maria Theresa of Bavaria, who in 1910 was "heir of line" of the house of Stuart, her eldest son, Prince Rupert, being heir to the throne of Bavaria; and from his second marriage descends the house of Orleans. In addition to those descended from these two marriages there are also the descendants of Edward, a brother of the electress Sophia. The male representation of the family, being extinct in the royal lines, is claimed by the earls of Galloway and also by the Stuarts of Castlemilk, but the claims of both are more than doubtful.

See Sir George Mackenzie, *Defence of the Royal Line of Scotland* (1685), and *Antiquity of the Royal Line of Scotland* (1686); Crawford, *Genealogical History of the Royal and Illustrious Family of the Stuarts* (1710); Duncan Stewart, *Genealogical Account of the Surname of Stewart* (1739); Andrew Stuart, *Genealogical History of the Stuarts* (1798); Stodart, *House of Stuart* (privately printed, 1855); *An Abstract of the Evidence to Prove that Sir William Stewart of Jedworth, the Paternal Ancestor of the Present Earl of Galloway, was the Second Son of Sir Alexander Stewart of Darnley* (1801); Riddell, *Stewartiana* (1843); W. Townend, *Descendants of the Stuarts* (1858); R. W. Eyton, *History of Shropshire* (1858), vol. vii.; Bailey, *The Succession to the English Crown* (1879); Skelton, *The Royal House of Stuart* (1890); J. H. Round, *Studies in Peerage and Family History* (1901); and S. Cowan, *The Royal House of Stuart* (1908). The best chart pedigree of the house is that which was prepared for the Stuart Exhibition by W. A. Lindsay.

STEWART, ALEXANDER TURNEY (1803–1876), American merchant, was born, of Scotch descent, at Lisburn, near Belfast, Ireland, on the 12th of October 1803. He studied for the ministry for about two years at Trinity College, Dublin, emigrated to New York in 1823, and in 1825 opened a small dry goods store. In 1848 he built at the corner of Chambers Street and Broadway a store which became the wholesale department upon the completion in 1862 of the large store on Broadway between Ninth and Tenth Streets. The business grew to enormous proportions for those days, with foreign branches in Manchester, Belfast, Glasgow, Berlin, Paris and Lyons. Stewart

was chairman of the commission sent by the United States to the Paris Exposition of 1867. In 1869 he was appointed secretary of the treasury by President U. S. Grant, but the Senate refused to confirm the appointment because of an old law excluding from the office any one interested in the importation of merchandise. Grant asked Congress to repeal the law, and Stewart offered to transfer his business to trustees and to give its proceeds while he held office to charitable institutions, but the nomination was never confirmed. Stewart sent to Ireland a shipload of provisions during the famine of 1846; he manufactured and sold to the government, at less than the prevailing rates, great quantities of cotton cloth for the use of the army during the Civil War; he took an active part in the prosecution of the "Tweed Ring" in New York; he sent a shipload of flour to the French sufferers from the Franco-German War, and he gave \$50,000 to the sufferers from the Chicago fire of 1871. In 1869 he bought some 7000 acres on the Hempstead Plain, Long Island, New York, and established Garden City for working men. The cathedral of the Incarnation (Protestant Episcopal) dedicated in 1885, was erected in Garden City by Stewart's widow as a memorial to him. He died in New York on the 10th of April 1876,¹ leaving the bulk of his great fortune to his widow, Mrs Cornelia (Clinch) Stewart (1802–1886)². His large art collection was sold by auction in New York in 1887.

See William O. Stoddard, "Alexander Turney Stewart," in *Men of Business* (New York, 1893); "A Merchant Prince," in *Chambers's Journal* (1876), vol. liii.; Edward Crapsey, "A Monument of Trade," in *The Galaxy* (1882), vol. ix.; "Stewart's," in *The Nation* (1882), vol. xxxiv.; "The Story of a Millionaire's Grave," in *Chambers's Journal* (1888), vol. lxxv.; and George W. Walling, *Recollections of a New York Chief of Police* (New York, 1887).

STEWART, BALFOUR (1828–1887), Scottish physicist, was born in Edinburgh on the 1st of November 1828, and was educated at the university of that city. The son of a tea merchant, he was for some time engaged in business in Leith and in Australia, but, returning to his studies of physics at Edinburgh, he became assistant to J. D. Forbes in 1856. Forbes was especially interested in questions of heat, meteorology, and terrestrial magnetism, and it was to these that Stewart also mainly devoted himself. Radiant heat first claimed his attention, and by 1858 he had completed his first investigations into the subject. These yielded a remarkable extension of Pierre Prévost's "Law of Exchanges," and enabled him to establish the fact that radiation is not a surface phenomenon, but takes place throughout the interior of the radiating body, and that the radiative and absorptive powers of a substance must be equal, not only for the radiation as a whole, but also for every constituent of it. In recognition of this work he received in 1868 the Rumford medal of the Royal Society, into which he had been elected six years before. Of other papers in which he dealt with this and kindred branches of physics may be mentioned "Observations with a Rigid Spectroscope," "Heating of a Disc by Rapid Motion in Vacuo," "Thermal Equilibrium in an Enclosure Containing Matter in Visible Motion," and "Internal Radiation in Uniaxial Crystals." In 1859 he was appointed director of Kew Observatory, and there naturally became interested in problems of meteorology and terrestrial magnetism. In 1870, the year in which he was very seriously injured in a railway accident, he was elected professor of physics at Owens

¹ On the 6th of November 1878 his body was stolen from St Mark's churchyard in New York, but recovered in 1881 upon the payment of \$20,000, and buried in the crypt of the cathedral in Garden City.

² Upon her death she left a small part of her estate to her other relatives and her servants, about \$4,631,000 to Charles J. Clinch, a kinsman, and about \$9,262,000 to Judge Henry Hilton (1824–1899), a business associate of Stewart, who had received a legacy of \$1,000,000 from Stewart, and who managed Mrs Stewart's business affairs after her husband's death. Clinch and Hilton were executors, and it was understood that Hilton should complete the cathedral at Garden City and endow schools there. A nephew of Mrs Stewart in 1887 sued to break the will on the ground that Hilton had unduly influenced her; the case was compromised out of court in 1890 and Mrs Stewart's relatives received more of her estate than they would have got under the terms of the testament.

College, Manchester, and retained that chair until his death, which happened near Drogheda, in Ireland, on the 19th of December 1887. He was the author of several successful textbooks of science, and also of the article on "Terrestrial Magnetism" in the ninth edition of this Encyclopaedia. In conjunction with Professor P. G. Tait he wrote *The Unseen Universe*, at first published anonymously, which was intended to combat the common notion of the incompatibility of science and religion.

STEWART, CHARLES (1778–1869), American naval officer, was born at Philadelphia, Pennsylvania, on the 28th of July 1778, of poor Irish parents. At the age of thirteen he shipped as cabin boy on a merchant vessel, and soon commanded a ship in the India trade. He entered the United States navy in March 1798 as lieutenant on the frigate "United States," and in 1800, when in command of the "Experiment," took the French privateers "Deux Amis" and "Diane." In 1802–4 he served against Tripoli, first as executive officer of the "Constellation" and then as commander of the "Siren." In 1806 he became a captain. From 1808 to 1812 he was in the merchant service, but on the outbreak of hostilities against Great Britain returned to the navy, and with Commander William Bainbridge is said to have persuaded President Madison to send the navy to sea instead of using it only for harbour defence. Placed in the command of the "Constellation," he was closely blockaded at Norfolk, Virginia. In 1813 he was placed in command of the "Constitution," and in February 1815 captured the "Cyane" and the "Levant," though the "Levant" was retaken. Later he commanded the Mediterranean squadron, the Pacific squadron, the home squadron and the Philadelphia navy yard. He was retired in 1855, and became rear-admiral on the retired list in 1862. He died in Bordentown, New Jersey, on the 6th of November 1869. His daughter, Delia Tudor, married, in 1834, John Henry Parnell, and became the mother of the Irish leader, Charles Stewart Parnell.

STEWART, SIR DONALD MARTIN (1824–1900), British field marshal, son of Robert Stewart of Forres, Elginshire, was born at Mount Pleasant, near Forres, on the 1st of March 1824. Educated at schools at Findhorn, Dufftown and Elgin, and at Aberdeen University, he entered the Bengal army in 1840, and served in 1854 and 1855 in the frontier expeditions against the Mohmands, and Afridis Aka and Bari Khel (medal and clasp). In the Indian Mutiny in 1857 Stewart, after a famous ride from Agra to Delhi with despatches, served on the staff at the siege and capture of Delhi and of Lucknow, and afterwards through the campaign in Rohilkhand (medal and two clasps, and brevet-major and lieutenant-colonel). For nine years he was assistant and deputy-adjutant-general of the Bengal army, commanded the Bengal brigade in the Abyssinian expedition in 1867 (medal and C.B.), and became a major-general in 1868. He reorganized the penal settlement of the Andaman Islands, where he was commandant when Lord Mayo was assassinated, and, after holding the Lahore command, was promoted lieutenant-general in 1877, and commanded the Kandahar field force in the Afghan War in 1878 (K.C.B. and thanks of parliament). In 1880 he made a difficult march from Kandahar to Kabul, fighting on the way the battles of Ahmed Khel and Urzu, and held supreme military and civil command in northern Afghanistan. On hearing of the Maiwand disaster, he despatched Sir Frederick Roberts with a division on his celebrated march from Kabul to Kandahar, and himself led the rest of the army back to India by the Khyber Pass (medal with clasp, G.C.B., C.I.E., baronetcy, and thanks of parliament). Promoted general in 1881, he was for five years commander-in-chief in India, and afterwards member of the council of the secretary of state for India until his death. He was made G.C.S.I. in 1885, promoted to be field marshal in 1894, and appointed governor of Chelsea Hospital in 1895. He died at Algiers on the 26th of March 1900.

See G. R. Elsmie, *Sir Donald Stewart* (1903).

STEWART, DUGALD (1753–1828), Scottish philosopher, was born in Edinburgh on the 22nd of November 1753. His father, Matthew Stewart (1715–1785), was professor of mathematics in the university of Edinburgh (1747–1772). Dugald Stewart was

educated in Edinburgh at the high school and the university, where he read mathematics and moral philosophy under Adam Ferguson. In 1771, in the hope of gaining a Snell exhibition and proceeding to Oxford to study for the English Church, he went to Glasgow, where he attended the classes of Thomas Reid. While he owed to Reid all his theory of morality, he repaid the debt by giving to Reid's views the advantage of his admirable style and academic cloquence. In Glasgow Stewart boarded in the same house with Archibald Alison, author of the *Essay on Taste*, and a lasting friendship sprang up between them. After a single session in Glasgow, Dugald Stewart, at the age of nineteen, was summoned by his father, whose health was beginning to fail, to conduct the mathematical classes in the university of Edinburgh. After acting three years as his father's substitute he was elected professor of mathematics in conjunction with him in 1775. Three years later Adam Ferguson was appointed secretary to the commissioners sent out to the American colonies, and at his urgent request Stewart lectured as his substitute. Thus during the session 1778–1779, in addition to his mathematical work, he delivered an original course of lectures on morals. In 1783 he married Helen Bannatyne, who died in 1787, leaving an only son, Colonel Matthew Stewart. In 1785 he succeeded Ferguson in the chair of moral philosophy, which he filled for a quarter of a century and made a centre of intellectual and moral influence. Young men were attracted by his reputation from England, and even from the Continent and America. Among his pupils were Sir Walter Scott, Jeffrey, Cockburn, Francis Horner, Sydney Smith, Lord Brougham, Dr Thomas Brown, James Mill, Sir James Mackintosh and Sir Archibald Alison. The course on moral philosophy embraced, besides ethics proper, lectures on political philosophy or the theory of government, and from 1800 onwards a separate course of lectures was delivered on political economy, then almost unknown as a science to the general public. Stewart's enlightened political teaching was sufficient, in the times of reaction succeeding the French Revolution, to draw upon him the undeserved suspicion of disaffection to the constitution. The summers of 1788 and 1789 he spent in France, where he met Suard, Degérando, Raynal, and learned to sympathize with the revolutionary movement.

In 1790 Stewart married a second time. Miss Cranstoun, who became his wife, was a lady of birth and accomplishments, and he was in the habit of submitting to her criticism whatever he wrote. A son and a daughter were the issue of this marriage. The death of the former in 1809 was a severe blow to his father, and was the immediate cause of his retirement from the active duties of his chair. Before that, however, Stewart had not been idle as an author. As a student in Glasgow he wrote an essay on *Dreaming*. In 1792 he published the first volume of the *Elements of the Philosophy of the Human Mind*; the second volume appeared in 1814, and the third not till 1827. In 1793 he printed a textbook, *Outlines of Moral Philosophy*, which went through many editions; and in the same year he read before the Royal Society of Edinburgh his account of the *Life and Writings of Adam Smith*. Similar memoirs of Robertson the historian and of Reid were afterwards read before the same body and appear in his published works. In 1805 Stewart published pamphlets defending Mr (afterwards Sir John) Leslie against the charges of unorthodoxy made by the presbytery of Edinburgh. In 1806 he received in lieu of a pension the nominal office of the writership of the *Edinburgh Gazette*, with a salary of £300. When the shock of his son's death incapacitated him from lecturing during the session of 1809–1810, his place was taken, at his own request, by Dr Thomas Brown, who in 1810 was appointed conjoint professor. On the death of Brown in 1820 Stewart retired altogether from the professorship, which was conferred upon John Wilson, better known as "Christopher North." From 1809 onwards Stewart lived mainly at Kinneil House, Linlithgowshire, which was placed at his disposal by the duke of Hamilton. In 1810 appeared the *Philosophical Essays*, in 1814 the second volume of the *Elements*, in 1815 the first part and in 1821 the second part of the "Dissertation" written for the *Encyclopaedia Britannica* "Supplement,"

entitled "A General View of the Progress of Metaphysical, Ethical, and Political Philosophy since the Revival of Letters." In 1822 he was struck with paralysis, but recovered a fair degree of health, sufficient to enable him to resume his studies. In 1827 he published the third volume of the *Elements*, and in 1828, a few weeks before his death, *The Philosophy of the Active and Moral Powers*. He died in Edinburgh on the 11th of June 1828. A monument to his memory was erected on Calton Hill.

Stewart's philosophical views are mainly the reproduction of his master Reid (for his ethical views see ETHICS). He upheld Reid's psychological method and expounded the "common-sense" doctrine, which was attacked by the two Mills. Unconsciously, however, he fell away from the pure Scottish tradition and made concessions both to moderate empiricism and to the French ideologists (Laromiguière, Cabanis and Destutt de Tracy). It is important to notice the energy of his declaration against the argument of ontology, and also against Condillac's sensationalism. Kant, he confessed, he could not understand. Perhaps his most valuable and original work is his theory of taste in the *Philosophical Essays*. But his reputation rests rather on his inspiring eloquence and the beauty of his style than on original work.

Stewart's works were edited in 11 vols. (1854-1858) by Sir William Hamilton and completed with a memoir by John Veitch. Matthew Stewart (his eldest son) wrote a life in *Annual Biography and Obituary* (1829), republished privately in 1838. For his philosophy see McCosh, *Scottish Philosophy* (1875), pp. 162-173; A. Bain, *Mental Science*, pp. 208, 313 and app. 29, 65, 88, 89; *Moral Science*, pp. 639 seq.; Sir L. Stephen, *English Thought in the XVIIIth Century*.

STEWART, SIR HERBERT (1843-1885), British soldier, eldest son of the Rev. Edward Stewart, was born on the 30th of June 1843 at Sparsholt, Hampshire. He was educated at Winchester and entered the army in 1863. After serving in India with his regiment (37th Foot) he returned to England in 1873, having exchanged into the 3rd Dragoon Guards. In 1877 he entered the staff college and also the Inner Temple. In 1878 he was sent out to South Africa, served in the Zulu War and against Sikukuni. As chief staff officer under Sir G. Pomeroy Colley he was present at Majuba (Feb. 27, 1881), where he was made prisoner by a Boer patrol and detained until the end of March. In August 1882 he was placed on the staff of the cavalry division in Egypt. After Tel-el-Kebir (Sept. 13, 1882) he headed a brilliant advance upon Cairo, and took possession of the town and citadel. He was three times mentioned in despatches, and made a brevet-colonel, C.B., and aide-de-camp to the queen. In January 1884 he was sent to Suakin in command of the cavalry under Sir Gerald Graham, and took part as brigadier in the actions from El Teb to the advance on Tamaneb. His services were recognized by the honour of K.C.B., and he was assistant adjutant and Q.M.G. in the south-eastern district in England from April to September 1884. He then joined the expedition for the relief of Khartum, and in December, when news from Gordon decided Lord Wolsley to send a column across the desert of Metemma, Stewart was entrusted with the command. On the 16th of January 1885, he found the enemy in force near the wells of Abu Klea, and brilliantly repulsed their fierce charge on the following morning. Leaving the wounded under guard, the column moved forward on the 18th through bushy country towards Metemma, 23 m. off. Meanwhile the enemy continued their attacks, and on the morning of the 19th Stewart was wounded and obliged to hand over the command to Sir Charles Wilson. He lingered for nearly a month, living long enough to hear of his promotion to the rank of major-general "for distinguished service in the field." He died on the way back from Khartum to Korti on the 16th of February, and was buried near the wells of Jakdul. In the telegram reporting his death Lord Wolsley summed up his character and career in the words: "No braver soldier or more brilliant leader of men ever wore the Queen's uniform."

STEWART, J. (?JAMES), of Baldynneis (*fl.* 1590), Scottish verse writer, is known as the translator of Ariosto's *Orlando Furioso*. The work is an abridgment in twelve cantos and has

the historical interest of having preceded Sir John Harington's translation (1591). The volume containing this version and other poems (of indifferent quality) is preserved in the Advocates' Library, Edinburgh. It bears the title *Ane Abbregement of Roland Furios, translat out of Aroist: togither with sym Rapsodies of the Auther's yowthfull braine, and last ane Schersing out of trew Felicitie; composi in Scotis meiter be J. Stewart of Baldynneis*. This MS. appears to be the original which was once in the possession of James VI. Extracts are printed in Irving's *History of Scottish Poetry* (1861).

STEWART, JOHN (1749-1822), British traveller, was born in London of humble parentage. After an unruly career at school he entered the service of the East India Company at Madras in 1763, but he threw up his position about two years later and became interpreter to Hyder Ali, afterwards serving as a general in his army; subsequently he served the nabob of Arcot, whose chief minister he became. Having enriched himself in this capacity, he began a series of travels through India, Persia, Ethiopia and Abyssinia, which earned him the nickname of "Walking Stewart." About 1783 he returned to Europe, where he cut a curious figure by wearing Armenian dress. He crossed over to America in 1791 and had various adventures, but soon came back to Europe, and made the acquaintance of Wordsworth in Paris and later of De Quincey in Bath. Becoming short of money, he again went to America, where he supported himself by lecturing. Having returned to Europe, Stewart's fortunes began to mend. In 1813 a claim he had made against the nabob of Arcot was settled by the East India Company for £10,000, and he took rooms in London and settled down to enjoy life, airing his opinions on literature and art. He died on the 20th of February 1822. De Quincey (see *Collected Writings*, 1890, vol. iii.) gives various particulars of him.

STEWART, JULIUS L. (1855-), American artist, was born at Philadelphia on the 6th of September 1855. His father, William Hood Stewart, was a distinguished collector of the fine arts, an early patron of Fortuny and the Barbizon artists, and lived in Paris during the latter part of his life. The son was a pupil of J. L. Gérôme, at the École des Beaux Arts, and of Raymondo de Madrazo. Among his principal paintings are "The Hunt Ball," Essex Club, Newark, New Jersey; "Full Speed," in James Gordon Bennett's collection; "Five o'clock Tea," and "Court in Cairo."

STEWART, WILLIAM (c. 1480-c. 1550), Scottish poet and translator, descendant of one of the illegitimate sons of Alexander Stewart, earl of Buchan, the "Wolf of Badenoch," was a member of the university of St Andrews. He was in orders, and a hanger-on at the court of James V. The last entry of the payment of a pension of £40 appears in the accounts of 1541. He was known as a poet in his own day: Lyndsay and Rolland refer to him. Portions of his minor verse are preserved in the Bannatyne and Maitland Folio MSS. His chief work is a metrical translation of Hector Boece's *History*, in obedience to the command of James V., who entrusted Bellenden with its translation into Scots prose.

Stewart's version remained in MS. till 1858, when it was edited by W. Turnbull for the "Rolls Series" (3 vols.). The MS. is now in the library of the university of Cambridge.

STEWART, SIR WILLIAM (c. 1540-c. 1605), Scottish politician, began life as a soldier in the Netherlands, where he became a colonel and entered into communications with Lord Burghley on the progress of affairs. In the year 1582 he was in Scotland, where James VI. made him captain of his guard. Having visited the English court in the king's interest in 1583, Stewart helped to free James from William Ruthven, earl of Gowrie, and to restore James Stewart, earl of Arran, to power; he was made a privy councillor and for a time assisted Arran to govern Scotland. In 1584 he captured Gowrie at Dundee. In 1585 he and Arran lost their power, and Stewart went to Denmark and France on secret errands for the king. He commanded the ships which conveyed James and his bride Anne from Denmark in 1590, and the same year was sent

on an embassy to the German princes. Twice he went on missions to the Netherlands, and in 1594 he was knighted and was given lands at Houston. He died before 1606. His only son, Frederick (c. 1590–1625), who was created a peer as Lord Pittenweem in 1609, died childless in December 1625.

Sir William Stewart of Houston is often confused with Sir William Stewart of Monkton (d. 1588), a brother of James Stewart, earl of Arran, who was killed in a fight in Edinburgh in July 1588, and also with Sir William Stewart of Caverstoun.

STEWARTON, a municipal and police burgh, in the Cunningham district of Ayrshire, Scotland. Pop. (1901), 2858. It is situated on Annick Water, 19 m. S.W. of Glasgow by the Glasgow & South-Western railway. The town lies in a fine agricultural district, famed for its dairy produce. Two cattle and two horse fairs are held yearly; at the October cattle fair there is the largest show of Ayrshire dairy stock in Scotland. About 2 m. north by west is Dunlop (pop. 473), which gave its name to a cheese that at one time commanded a large market.

STEYN, MARTINUS THEUNIS (1857–), last president of the Orange Free State, was born at Winburg in that state on the 2nd of October 1857. He was a student in Holland and later in England at the Inner Temple, and was called to the English bar in November 1882. After his return to South Africa he practised as a barrister at Bloemfontein, and in 1889 was appointed state attorney of the Free State. A few months afterwards he became second puisne judge, and in 1893 first puisne judge of the high court. His decisions won him a reputation for ability and sound judgment. In 1895, upon the resignation of President F. W. Reitz, Steyn was the candidate of the pan-Dutch party for the vacant post. The election resulted (February 1896) in a decisive victory for Steyn. As president he linked the fortunes of his state with those of the Transvaal, a policy which led to the extinction of the republic. After the occupation of Bloemfontein by Lord Roberts Steyn wandered about South Africa, carrying on a semblance of government, and on occasion taking charge of military operations. More than once he narrowly escaped capture. Regarded as one of the most irreconcilable of the Boer leaders, he took part, however, in the preliminary peace negotiations at Klerksdorp in April 1902, but was prevented by illness from signing the instrument of surrender at Pretoria on the 31st of May. At that date he was suffering from locomotor ataxy, brought on by his constant exertions; and in the July following he sailed for Europe, where he remained until the autumn of 1904. He then took the oath of allegiance to the British crown, and returning to South Africa partially restored to health resumed an active participation in politics. In 1908–1909 he was vice-president of the Closer Union Convention, where he was distinguished for his statesmanlike and conciliatory attitude, while maintaining the rights of the Dutch community.

STEYNING, a small market town in the mid parliamentary division of Sussex, England, 10½ m. W.N.W. of Brighton by the London, Brighton & South Coast railway. Pop. (1901), 1705. The church of St Andrew retains a very fine series of Norman pier-arches in the nave. Some picturesque old houses remain in the town. Brewing and the manufacture of parchment are carried on.

The Anglo-Saxon church of Steyning (Stoeningas, Stoenium, Staninges, Stenyges, Stenyng) mentioned in Domesday is attributed to St Cuthman, who is said to have settled here before the 9th century, and whose shrine became a resort for pilgrims. The later prosperity of the town was due to its harbour. Alfred bequeathed Steyning to his nephew, but it evidently reverted to the Crown, as it was granted by Edward the Confessor to the abbot and convent of Fécamp, with whom it remained until the 15th century. By 1086 Steyning was a thriving port. It had a market, a mint and two churches, and the borough contained 123 burgages. The decay of the town began in the 14th century owing to the recession of the sea, and it received another blow in the suppression of its priory by Henry IV. It was afterwards granted to the abbey of Sion, which held it until the dissolution. From the reign of Edward IV. to that of Richard III. there is

evidence that the town was governed by a bailiff elected annually in the borough-court. Steyning returned two representatives to parliament from 1298 until it was disfranchised in 1832. In the 14th century the abbot of Fécamp held weekly markets in the borough on Wednesdays and Saturdays, and fairs at the Nativity of the Virgin and the Feast of St Michael, by prescriptive right. The present market day is Wednesday, for stock, and a cattle fair is held on the 11th of October.

STEYR, or **STEIER**, a town in Upper Austria, 28 m. S.E. of Linz by rail. Pop. (1900), 17,592. It is situated at the confluence of the Steyr with the Enns, and on an eminence rises the castle of the princes of Lamberg, dating from the 10th century. The parish church is in Gothic style and was built in 1443–1522. Steyr is the chief centre of the steel and iron industry of Upper Austria. The rifle factory, founded in 1830 by Josef Werndl, is the largest in Austria, and since 1882 it has added the manufacture of bicycles and electrical plant. It is the birthplace of the poet Alois Blumauer (1755–1798). Steyr was founded at the end of the 10th century and was the capital of a countship, first belonging to Styria, but annexed to Austria in 1192.

STIBNITE, a mineral consisting of antimony sulphide, Sb_2S_3 , occurring as bladed or acicular orthorhombic crystals; an important ore of antimony. It was mentioned by Dioscorides and Pliny under the names *stimmi*, *stibi* and *platyophthalmon* (*πλατυόφθαλμον*); the last name refers to the use which the ancients made of the powdered mineral for darkening the eyebrows to increase the apparent size of the eyes. Antimonite is a name in common use for this species. The crystals are prismatic in habit, deeply furrowed longitudinally, and usually terminated by acute pyramidal planes. There is a perfect cleavage (010) parallel to the length of the crystals, and the basal plane (001) is a plane of gliding; the latter gives rise to very characteristic transverse striations or nicks on the cleavage surfaces of crystals which have been bent. The colour is lead-grey, and the lustre metallic and brilliant: crystals become dull on prolonged exposure to light. Cleavage flakes of extreme thinness transmit a small amount of red light, but are more transparent for heat rays. The mineral is quite soft ($H. = 2$), and has a specific gravity of 4.6. Stibnite occurs with quartz in beds and veins in gneisses and schists, or with blende, galena, &c., in metalliferous veins. Magnificent groups of brilliant crystals, up to 20 in. in length, are abundant in the extensive antimony mine of Ichinokawa, province of Iyo, Japan. Large, but dull, crystals have also been found at Lubilhac in Haute-Loire, France. Prismatic and acicular crystals often penetrating tabular crystals of barytes, are common at Felsöbánya near Magy-Bánya and Kremnitz in Hungary. (L. J. S.)

STICHOMETRY, a term applied properly to the measurement (*μέτρον*) of ancient texts by *στίχοι* (lit. "rows") or verses of a fixed standard length. It was the custom of the Greeks and Romans to estimate the length of their literary works by measured lines. In poetical works the number of metrical verses was computed; in prose works a standard line had to be taken, for no two scribes would naturally write lines of the same length. On the authority of Galen (*de Placit. Hipp. et Plat.* viii. 1) we learn that the unit of measurement among the Greeks was the average Homeric line, consisting of about 36 letters, or 16 syllables. The lines so measured were called *στίχοι* or *ἔπη*. The practice of thus computing the length of a work can be traced back to the 4th century B.C. in the boast of Theopompus that he had written more *ἔπη* than any other writer. The number of such *στίχοι* or *ἔπη* contained in a papyrus roll was recorded at the end of the work; and at the end of a large work extending to several rolls the grand total was given. The object of such stichometrical calculations was a commercial one, viz. to assess the pay of the scribe and the market value of the MS. Callimachus, when he drew up his catalogue of the Alexandrian libraries in the 3rd century B.C., registered the total of the *στίχοι* in each work. Although he is generally lauded for thus carefully recording the numbers and setting an example to all who should follow him, it has been suggested that this very act was the cause of their general disappearance from MSS.; for that, when his

πινakes were published, scribes evidently thought it was needless to repeat what could be found there; and thus it, is that so few MSS. have descended to us which are marked in this way. A more natural reason for the scarcity of such details is that scribes and booksellers suppressed them in order to impose upon their customers.

The application of the system to Latin MSS. was fully recognized. The unit of measurement was the average Virgilian line. This is recorded in an interesting memorandum written in the 4th century, found in a MS. in the Phillipps Library at Cheltenham, containing a computation of the *στίχοι* in the books of the Bible and the works of Cyprian. The writer states that in the city of Rome it had become the practice not to record the number of verses in the MSS., and that elsewhere also, for greed of gain, the numbers were suppressed. Therefore he has made a calculation of the contents of the text under his hand and has appended to the several books the number of Virgilian hexameters which would represent its length. The rate of pay of the scribes in Diocletian's reign was fixed by his edict *de pretiis rerum venalium* at 25 denarii for 100 *στίχοι* in writing of the first quality, and at 20 denarii for the second quality; what the difference was between the two qualities does not appear.

The system of measurement described above has been called "total stichometry," in distinction from "partial stichometry," which was the calculation and marking off in the margins of the *στίχοι* from point to point, just as we mark off the lines in a poem at convenient intervals and number the verses of the chapters of the Bible. This method was for convenience of literary reference. Instances of such "partial stichometry" are not very numerous among existing MSS., but they are sufficient to show that the system was in vogue. In the Bankes Homer in the British Museum the verses are numbered in the margin by hundreds, and the same practice was followed in other Homeric papyri. In the Ambrosian Pentateuch of the 5th century at Milan the book of Deuteronomy is likewise numbered at every hundredth *στίχος*. Euthalius, a deacon of Alexandria of the 5th century, marked the *στίχοι* of the Pauline epistles by fifties. In the Codex Urbinus of Isocrates, and in the Clarke Plato of A.D. 888, at Oxford, there are indications of partial stichometry.

There was also in use in biblical texts and in rhetorical works a stichometrical system different from that described above, in which the *στίχοι*, as we have seen, were lines of measurement or *space-lines*. This other system, which is more correctly entitled *colometry* (see MANUSCRIPT), consisted in the division or breaking up of the text into short sentences or lines according to the *sense*, with a view to a better understanding of the meaning and a better delivery in public reading. The Psalms, Proverbs and other poetical books were anciently thus written, and hence received the title of *βιβλοι στιχηρα*, or *στιχηρα*; and it was on the same plan that St Jerome wrote, first the books of the prophets, and subsequently all the Bible of his version, *per cola et commata* "quod in Demosthene et Tullio solet fieri." In the Greek Testament also Euthalius, in the 5th century, introduced the method of writing *στιχηδόν*, as he termed it, into the Pauline and Catholic epistles and the Acts. The surviving MSS. which contain the text written in short sentences show by the diversity of the latter that the rhythmical sentences or lines of sense were differently calculated by different writers; but the original arrangement of St Jerome is thought to be represented in the Codex Amiatinus at Florence, and that of Euthalius in the Codex Claromontanus at Paris. With regard to St Jerome's reference to the division *per cola et commata* of the rhetorical works of Demosthenes and Cicero, it should be noticed that there are still in existence MSS. of works of the latter in which the text is thus written, one of them being a volume of the *Tusculans* and the *De senectute* in the Bibliothèque Nationale at Paris. The same arrangement of the text of the orations of Demosthenes is also mentioned by the rhetoricians of the 5th and subsequent centuries.

AUTHORITIES.—C. Graux in *Revue de philologie* (1878), ii. 97; T. Mommsen in *Hermes*, xxi. 142; W. Sanday in *Studia biblica* (1891), iii. 217; J. Rendel Harris, *Stichometry* (1893). (E. M. T.)

STICKÉ, a game played in an enclosed court, taking its name from "sphairstiké," the parent of lawn-tennis. The implements are an ordinary lawn-tennis racket and lawn-tennis balls not covered with flannel. The walls of the court may be made of wood, cement or brick to the height of 9 or 10 ft., with netting above—unless the court is roofed—to prevent the balls from going out: the floor may be of wood, cement or asphalt, perfect accuracy not being essential. The dimensions of the court are 78 ft. by 27 ft.; it is bisected longitudinally by a painted line, laterally by a net 3 ft. 6 in. high, above which is stretched a tape 8 ft. from the ground. In each of the corners a 9-ft. square (the

"service" court) is painted, and 18 ft. from each back wall lines ("service" lines) are drawn across the breadth of the court. The rules are similar to those of lawn-tennis, except that a ball can only be "out of court" if it is struck over the walls.

STICK-INSECT, the name given to certain orthopterous insects of the family Phasmidae, of extremely variable form and size, and deriving their name from a resemblance to the branches and twigs of the trees in which they live and feed. The resemblance is produced by the great length and slenderness of the body and legs. Protection is afforded to some species, like *Heteropteryx grayi* from Borneo, by sharp thornlike spines. The anterior wings, when present, are always small; but the posterior wings are sometimes of large size and very beautifully coloured. The colouring, however, is only visible when the wings are expanded and in use. Many species are wingless at all ages. As in the leaf-insects, to which the stick-insects are closely allied, the egg-cases are very similar to seeds. Stick-insects are intolerant of cold, and attain their largest size and greatest profusion of species in the tropics, one West African species, *Palophus centaurus*, reaching a length of 9 in. Species of small size are found in southern Europe, one belonging to the genus *Bacillus* advancing as far north as the middle of France.

STICKLEBACK, the name applied to a group of small fishes (*Gastrosteus*) which inhabit the fresh and brackish waters as well as the coasts of the temperate zone of the northern hemisphere. As far as the European kinds are concerned, all may be met with in the brackish water of certain littoral districts. The majority have a compressed well-proportioned body, which in the marine species is of a more elongate form, leading to the allied group of flute-mouths (*Fistulariidae*), which are, in fact, gigantic marine sticklebacks. Their mouth is of moderate width, oblique, and armed with small but firmly set teeth. The head is almost entirely protected by hard bone; even the cheeks are cuirassed by the dilated infraorbital bones. There are no scales developed on any part of the body, but a series of hard and large scutes protects a greater or lesser portion of the sides. The first dorsal fin and the ventrals are transformed into pointed formidable spines, and joined to firm horny plates of the endoskeleton. With regard to the degree in which this armature is developed, not only do the species differ from each other, but almost every species shows an extraordinary amount of variation. About ten kinds may be taken to be specifically distinct.

So far as is known at present, all sticklebacks construct a nest for the reception of the spawn, which is jealously guarded by the male until the young are hatched, which event takes place in from ten to eighteen days after oviposition. He also protects them for the first few days of their existence.

Sticklebacks are short-lived animals; they are said to reach an age of only three or four years; yet their short life, at least that of the males, is full of excitement. During the first year of their existence, before the breeding season begins, they live in small companies in still pools or gently flowing brooks. But with the return of the warmer season each male selects a territory, which he fiercely defends against all comers, especially against intruders of his own species and sex, and to which he invites all females, until the nest is filled with ova. At this period he also assumes a bridal dress, painted with blue and red tints. The eggs are of comparatively large size, one female depositing from 50 to 100.

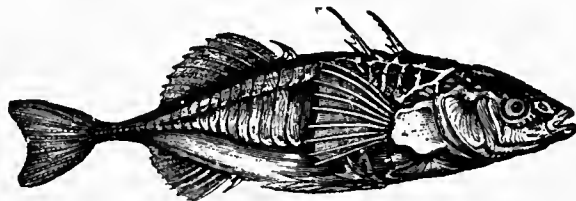

Gastrosteus aculeatus, var. *noveboracensis*, Three-Spined Stickleback.

Of the species known not one has so wide a geographical range, and has so well been studied, as the common British three-spined stickleback (*Gastrosteus aculeatus*). It is found everywhere in northern and central Europe, northern Asia, and North

America. The development of its scutes and spines varies exceedingly, and specimens may be found without any lateral scutes and with short spines, others with only a few scutes and moderately sized spines, and again others which possess a complete row of scutes from the head to the caudal fin, and in which the fin-spines are twice as long and strong as in other varieties. On the whole, the smooth varieties are more numerous in southern than in northern localities. This species swarms in some years in prodigious numbers; in Pennant's time amazing shoals appeared in the fens of Lincolnshire every seven or eight years. No instance of a similar increase of this fish has been observed in our time, and this possibly may be due to the diminished number of suitable breeding-places in consequence of the introduction of artificial drainage. This species usually constructs its nest on the bottom, excavating a hollow in which a bed of grass, rootlets or fibres is prepared; walls are then raised, and the whole is roofed over with the like material. The nest is an inch and more in diameter, with a small aperture for an entrance.

The ten-spined stickleback (*Gastrosteus pungitius*) is so called from the number of spines usually composing its first dorsal fin, which, however, may be sometimes reduced to eight or nine or increased to eleven. It is smaller than the three-spined species, rarely exceeding 2 in. in length. Its geographical range nearly coincides with that of the other species, but it is more locally distributed, and its range in northern Asia is not known. Its nest is generally placed among weeds above the bottom of the water. Breeding males are readily recognized at a distance by the intensely black colour of the lower parts of their body.

Both these species are extremely voracious. A small stickleback kept in an aquarium devoured, in five hours' time, 74 newly-hatched dace, which were about a quarter of an inch long. Two days after it swallowed 62 and would probably have eaten as many every day could they have been procured.

The sea-stickleback (*Gastrosteus spinachia* or *Spinachia vulgaris*) attains to a length of 7 in., and is armed with fifteen short spines on the back. It is extremely common round the British coasts, but never congregates in large shoals. At suitable localities of the coast which are sheltered from the waves and overgrown with seaweed, especially in rock-pools, one or two males establish themselves with their harems, and may be observed without difficulty, being quite as fearless as their freshwater cousins. Harbours and shallows covered with *Zostera* are likewise favourite haunts of this species, although the water may be brackish. The nest is always firmly attached to seaweed, and sometimes suspended from an over-hanging frond. The materials are bound together by a tough white thread which is formed by a secretion of the kidneys of the male. This species inhabits only the northern coasts of Europe.

STIER, RUDOLF EWALD (1800-1862), German Protestant divine and mystic, was born at Fraustadt in Posen on the 17th of March 1800. He studied at Halle and Berlin, first law and afterwards theology; and he continued his theological studies later at the pastoral seminary of Wittenberg. In 1824 he was made professor in the Missionary Institute at Basel. Afterwards he held pastorates at Frankleben near Merseburg (1829) and at Wichlinghausen in the Wupperthal (1838). In 1850 he was appointed superintendent at Schkeuditz, and in 1859 at Eisleben. He published a new edition of Luther's Catechism and a translation of the Bible based on that of Luther; but he is noted chiefly for his thoughtful, devotional and mystical commentary on the words of the Lord (*Reden des Herrn*, 3 vols., 1843; 3rd ed., 7 vols., 1870-1874; Eng. trans., 8 vols., 1855-1858; 3 vols., 1869). He died at Eisleben on the 16th of December 1862.

His other works, besides commentaries on the Psalms, Second Isaiah, Proverbs, Ephesians, Hebrews, Epistles of James and Jude, include: *Die Reden der Apostel* (2 vols., 1824-1830; Eng. trans., 1869) and *Die Reden der Engel in der heiligen Schrift* (1862). Cf. J. P. Lacroix, *The Life of R. Stier* (New York, 1874).

STIFTER, ADALBERT (1805-1868), Austrian author, was born at Oberplan in Bohemia on the 23rd of October 1805, the son of a linen weaver. Having studied at the university of Vienna, he became tutor to Richard, eldest son of Prince Metternich, and obtained in 1849 the appointment as school inspector

with the title of *Schulrat* in Linz, where he lived until his death on the 28th of January 1868. As early as 1840 Stifter had made his name known by his *Feldblumen*, a collection of charming little sketches, but his fame chiefly rests upon his *Studien* (1844-1851) in which he gathered together his early writings. These sketches of scenery and rural life are among the best and purest examples of German prose. Among other of his works may be cited *Bunte Steine* (1853), *Nachsommer* (1857), *Witiko* (1864-1867), and *Briefe*, which appeared posthumously in 1869.

Stifter's *Sämliche Werke* were published in 17 vols. in 1870. There are also editions of selected works in 4 vols. (1887) and in 6 vols. (1899). A critical edition by A. Sauer is in preparation. Stifter's letters were published by J. Aprent in 3 vols. (1869). See E. Kuh, *Zwei Dichter Österreichs* (1872); K. Pröll, *A. Stifter, der Dichter des Böhmerwaldes* (Vortrag, 1891); J. K. Markus, *A. Stifter* (2nd ed., 1879); A. R. Hein, *A. Stifter* (1904); T. Klaiber, *A. Stifter* (1905); W. Kosch, *A. Stifter und die Romantik* (1905).

STIGAND (d. 1072), archbishop of Canterbury, is first mentioned in 1020. He was then chaplain to Canute and afterwards to his son, Harold Harefoot, and after the death of the former king appears to have acted as the chief adviser of his widow, Emma. In 1043 he was consecrated bishop of Elmham and in 1047 was translated to Winchester; he supported Earl Godwine in his quarrel with Edward the Confessor, and in 1052 arranged the peace between the earl and the king. In this year the archbishop of Canterbury, Robert of Jumièges, having been outlawed and driven from England, Stigand was appointed to the archbishopric; but, regarding Robert as the rightful archbishop, Pope Leo IX. and his two successors refused to recognize him. In 1058, however, Benedict X. gave him the pall, but this pope was deposed in the following year. Stigand is said by Norman writers to have crowned Harold in January 1066; but it is now probable that this ceremony was performed by Aldred, archbishop of York. Stigand submitted to William, and assisted at his coronation. But the Conqueror was anxious to get rid of him, although he took him in his train to Normandy in 1067. In 1070 he was deposed by the papal legates and was imprisoned at Winchester, where he died, probably on the 22nd of February 1072. Stigand was an avaricious man and a great pluralist, holding the bishopric of Winchester after he became archbishop of Canterbury, in addition to several abbeys.

See E. A. Freeman, *The Norman Conquest* (1870-1876), vols. ii., iii. and iv.; and J. R. Green, *The Conquest of England* (1899), vol. ii.

STIGMATIZATION, the infliction of *stigmata*, i.e. marks tattooed or branded on the person, the term being used with specific reference to the supposed supernatural infliction of wounds like those of Christ.

An ancient and widespread method of showing tribal connexion, or relation to tribal deities, was by marks set upon the person; thus Herodotus, in describing a temple of Hercules in Egypt (ii. 113), says that it is not lawful to capture runaway slaves who take refuge therein if they receive certain marks on their bodies, devoting them to the deity. The practice is alluded to by Paul (Gal. vi. 17) in the words, "from henceforth let no man trouble me, for I bear branded on my body the stigmata of Jesus"; and some writers have understood the passage as referring to stigmatization in the modern sense (Molanus, *De historia ss. imaginum et picturarum*, ed. Paquot, iii. 43, p. 365). Branding, as indicative of servitude, was forbidden by Constantine.

In the period of persecution Christian martyrs were sometimes branded with the name of Christ on their foreheads (Pontius, "De vit. S. Cypriani," *Biblioth. veterum patrum*, vol. iii. p. 472, § vii.). Wounds of this sort were sometimes self-inflicted as a disfigurement by nuns for their protection, as in the case of St Ebba, abbess of Coldingham (see Baronius, *Annales*, xv. 215, ann. 870, also Tert. *De vel. virg.*). Some Christians likewise marked themselves on the hands or arms with a cross or the name of Christ (Procopius, *In Esaiam*, ed. Curterius, p. 496), and other voluntary mutilations for Christ's sake are mentioned (Matt. xix. 12; Fortunatus, *Life of St Rhadegund*, ed. Migne, col. 508; Palladius, *Lausiaca History*, cxii.; Jerome's *Letter to St Eustochium*, &c.).

In St Francis of Assisi we have the first example of the alleged miraculous infliction of stigmata. (For an earlier instance pronounced by the Church to be an imposture see Fleury, *Hist. Eccl.* lxxviii. § 56, *ann.* 1222.) While meditating on the sufferings of our Lord, in his cell on Mount Alverno in 1224, we are told by his biographers, Thomas of Celano and Bonaventura, that the Lord appeared to Francis as a seraph and produced upon his body the five wounds of Christ; of these we are told that the side wound bled occasionally, though Bonaventura calls it a scar, and the wounds in the feet had the appearance and colour of nails thrust through. After his death St Clare endeavoured, but in vain, to extract one of these. Pope Alexander IV. and other witnesses declared that they had seen these marks both before and after his death (Raynaldus, *ad ann.* 1255, p. 27). The divinely attested sanctity of their founder gave to the newly established order of Franciscans a powerful impulse, so that they soon equalled and threatened to overshadow in influence the previously founded order of St Dominic.

The reputation of the latter order was, however, similarly raised in the next century by the occurrence of the same wonder in the case of a sister of the third rule of St Dominic, Catherine Benincasa—better known as St Catherine of Siena. From her biographer's account we gather that she was subject to hysterio-epileptic attacks, in one of which, when she was twenty-three years old, she received the first stigma (see v. 230). In spite of her great reputation, and the number of attesting witnesses, this occurrence was not universally believed in. Pope Sixtus IV. published a bull in 1475 ordering, on pain of anathema, the erasure of stigmata from pictures of St Catherine, and prohibiting all expressions of belief in the occurrence. Pope Innocent VIII. similarly legislated "ne de caetero S. Catherina cum stigmatibus depingatur; neve de ejus stigmatibus fiat verbum, aut sermo, vel praedicatio ad tollendam omnem scandali occasionem" (see references in Raynaud, *De Stigmatisme*, cap. xi. 1665). In the years which followed cases of stigmatization occurred thick and fast—now a Franciscan, now a Dominican, very rarely a religieuse of another order, showing the marks. Altogether about ninety instances are on record, of which eighteen were males and seventy-two females. (There are about thirty other cases sometimes included in the catalogue, of which there are no particulars recorded.) Most of them occurred among residents in religious houses, after the austerities of Lent, usually on Good Friday, when the mind was intently fixed on our Lord's Passion; and the possibility of the reception of the marks was constantly before the eyes and thoughts of the members of the two orders to which St Francis and St Catherine belonged. The order of infliction in the majority of cases was that of the crucifixion, the first token being a bloody sweat, followed by the coronation with thorns; afterwards the hand and foot wounds appear, that of the side being the last. The grade of the infliction varied in individual cases, and they may be grouped in the following series:—

1. As regards full stigmatization, with the visible production of the five wounds, and generally with the mark of the crown as well, the oldest case, after St Francis, is that of Ida of Louvain (1300), in whom the marks appeared as coloured circles; in Gertrude von Oosten of Delft (1344) they were coloured scars, and, as in the case of St Catherine, disappeared in answer to prayer as they also did on Dominica de Paradis; in Sister Pierona, a Franciscan, they were blackish grey. They were true wounds in Margaret Ebnerin of Nuremberg (d. 1351; see her *Life*, Augsburg, 1717), in Brigitta, a Dominican tertiary (1390), and also in Lidwina. An intermission is described in the marks on Johanna della Croce of Madrid (1524), in whom the wound in the side was large, and the others were rose-coloured circular patches. The marks appeared on each Friday and vanished on Sunday. These emitted an odour of violets; but in Sister Apollonia of Volaterra they were fetid while she lived. Angela della Pace (1634) was fully stigmatized at nine years of age, being even marked with the sponge and hyssop on the mouth; while Joanna de Jesu-Maria at Burgos (1613), a widow, who had entered the convent of Poor Clares, was marked in her sixtieth year. To her in vision two crowns were offered—one of flowers and one of thorns; she chose the latter and immediately was seized with violent pain and her confessor heard a sound as of her skull breaking. This case was investigated by the officers of the Inquisition. The stigmatiza-

tion of Veronica Giuliani (1696) was also the subject of inquiry, and in this case the nun drew on a paper a representation of the images which she said were engraved on her heart. On a post-mortem examination being made in 1727 by Professor Gentili and Dr Bordiga, the image of the cross, the scourge, &c., were said to have been impressed on the right side of the organ (*Vita della Veronica Giuliani*, by Salvatori, Rome, 1803). The case of Christina Stumbelen, a Dominican at Cologne, is noteworthy, as on her skull there was found a raised ridge or crown which was at first green, with red dots. In Lucia di Narni (1546) the marks were variable, as they also were on Sister Maria di S. Dominic. On the body of St Margaret of Hungary the stigmata were found fresh and clear when her body was exhumed some time after her death for transportation to Presburg. Other stigmatized persons were Elizabeth von Spalbeck, a Cistercian; Sister Coleta, a Poor Clare; Matilda von Stanz; Margaret Bruch of Endring (1503); Maria Razzi of Chios (1582); Catharina Januensis; Elizabeth Reith of Allgau; Stieva zu Hamm in Westphalia; Sister Mary of the Incarnation at Pontoise; Archangela Tardera in Sicily (1608); Catharina Ricci in Florence (1590); and Joanna Maria della Croce, a Poor Clare at Roveredo (d. 1673), upon whom the markings of the thorn crown and spear wound were especially deep.

2. In some cases, although the pains of stigmatization were felt, there were no marks apparent. This occurred to Helen Brunsen (1285); Helena of Hungary (1270); Osanna of Mantua (1476); Columba Rocasani; Magdalena de Pazzis; Anna of Vargas; Hieronyma Carvaglio; Maria of Lisbon, a Dominican; Joanna di Vercelli; Stephania Soncinas, a Franciscan; Sister Christina, a Carthusian; and Joanna Rodriguez, a Poor Clare. In the case of Ursula Aguir de Valenza, a tertiary of St Dominic (1608), and Catharine Cialina (d. 1619) the pain was chiefly that of the crown of thorns, as it was also in Amelia Bicchieri of Vercelli, an Augustinian.

3. In a third series some of the marks were visible on the body, while others were absent or only subjectively indicated by severe pains. The crown of thorns only was marked on the head of Vincentia Ferreria at Valencia (d. 1515) and Philippa de Santo Tomaso of Montemor (1670), while according to Torellus the Augustinian Ritta von Cassia (d. 1430) had a single thorn wound on the forehead. The crown was marked on Catharina of Raconizio (b. 1486), who also suffered a severe bloody sweat. In the case of Stephano Quinzani, in Soncino (1457), there was a profuse bloody sweat and the wounds were intermitting, appearing on Friday and Saturday, vanishing on Sunday. Blanche Gazinan, daughter of Count Arias de Sagavedra (1564), was marked only on the right foot, as also was Catherine, a Cistercian nun. The heart wound was visible in Christina Mirabilis (1232). Gabriella de Piezolo (d. 1473) died from the bleeding of such a wound, and similar wounds were described in Maria de Aconsin in Toledo; Eustochia, a tertiary of St Francis; Clara de Bugny, a Dominican (1514); Cecilia Nobili, a Poor Clare of Nuceria (d. 1655). In the last instance the heart wound was found after death—a three-cornered puncture. A similar wound was seen in the heart of Martina de Arilla (d. 1644). Maria Villana, a Poor Clare, daughter of the margrave of La Pella, was marked with the crown and the spear thrust, and after her death the impresses of the spear, sponge and reed were found on her heart (d. 1670). The wound was usually on the left side, as in Sister Masrona of Grenoble, a tertiary of St Francis (1627); it was on the right in Margareta Columna, also a Clare. In Maria de Sarmiento it was said to have been inflicted by a seraph in a vision.

4. In a fourth set of cases the imprints were said to have been found on the heart, even though there was no surface marking. Thus the Dominican Paula de St Thomas was said to have had the stigmata on her heart. The heart of Clare of Montfaucon (1308) was said to have been as large as a child's head and impressed with the cross, the scourge and the nails. Similar appearances were found in Margaret of Citta di Capello and Johanna of Yepes (1591).

The instances of masculine stigmatization are few. Benedict di Rhegio, a Capuchin at Bologna, had the marks of the crown (1602); Carolus Sazia, an ignorant lay brother, had the wound in his side. Dodo, a Praemonstratensian lay brother, was fully stigmatized, as also was Philip de Aqueria. The marks after death were found on the heart of Angelos del Pas, a minorite of Perpignan, as also on Matheo Carery in Mantua, Melchior of Arazel in Valentia, Cherubin de Aviliana (an Augustinian), and Agolini of Milan. Walter of Strassburg, a preaching friar (1264), had the heart-pain but no mark, and the same was the case with a Franciscan, Robert de Malatestis (1430), and James Stephanus. On Nicholas of Ravenna the wounds were seen after death, while John Gray, a Scotsman, a Franciscan martyr, had one wound on his foot.

Several later instances have been recorded. Anna Katherina Emmerich, a peasant girl born at Münster in 1774, afterwards an Augustinian nun at Agnetenberg, was even more famous for her visions and revelations than for the stigmata. Biographies,

with records of her visions, have been published by Brentano at Munich in 1852 and the Abbé Cazalès at Paris (1870). Colombe Schanolt of Bamberg (1787) was fully stigmatized, as also was Rose Serra, a Capuchin of Ozieri in Sardinia (1801), and Madeleine Lorgier (1806). Two well-known cases occurred in Tirol—one "L'Ecstatica" Maria von Mörl of Caldaro, a girl of noble family, stigmatized in 1839, the other "L'Addolorata" Maria Dominica Lazzari, a miller's daughter at Capriana, stigmatized in 1835 (see Boré, *Les Stigmatisées du Tyrol*, Paris, 1846). A case of the second class is that of Elizabeth Eppinger of Niederbrunn in Bavaria (1814), reported on by Kuhn. An interesting example of stigmatic trance also occurred in the case of a Protestant young woman in Saxony in 1820, who appeared as if dead on Good Friday and Saturday, and revived on Easter Sunday.

The last case recorded is that of Louise Lateau, a peasant girl, at Bois de Haine, Hainault, upon whom the stigmata appeared on the 24th of April 1868. This case was investigated by Professor Lefebvre of Louvain, who for fifteen years was physician to two lunatic asylums. In her there was a periodic bleeding of the stigmata every Friday, and a frequent recurrence of the hystero-cataleptic condition. Her biography has been written by Lefebvre and published at Louvain (1870).

On surveying these ninety cases we may discount a certain number, including all those of the second class, as examples of subjective sensations suggested by the contemplation of the pains of crucifixion. A second set, of which the famous case of Jetzer (Wirz, *Helvetische Kirchengeschichte*, 1810, iii. 389) is a type, must be also set aside as obvious and intentional frauds produced on victims by designing persons. A third series, and how large a group we have not sufficient evidence to decide, we must regard as due to the irresponsible self-infliction of injuries by persons in the hystero-epileptic condition, those perverted states of nervous action which Charcot has done so much to elucidate. To any experienced in this form of disease, many of the phenomena described in the records of these examples are easily recognizable as characteristic of the hystero-epileptic state.

There are, however, some instances not easily explained, where the self-infliction hypothesis is not quite satisfactory. Parallel cases of physical effects due to mental suggestion are well authenticated. Beaunis vouches for rubefaction and vesication as produced by suggestion in the hypnotic state, and Bourru and Burot describe a case of bloody sweat, and red letters marked on the arm by simple tracing with the finger. See *Congrès scientifique de Grenoble, progrès médicale* (Aug. 29, 1885), and Berjon's *La Grande hystérie chez l'homme* (Paris, 1886). We know so little of the trophic action of the higher nerve centres that we cannot say how far tissue nutrition can be controlled in spots. That the nerve centres have a direct influence on local nutrition is, in some cases, capable of experimental demonstration, and, in another sphere, a few of the recorded instances of connexion between maternal impression and congenital deformity seem to indicate that this trophic influence may have wider limits and a more specific capacity of localization than at first sight seems possible.

LITERATURE.—See references to each name in *Acta sanctorum* or Hueber, *Menologium franciscanorum* (1698); Henriquez, *Menologium cisterciense*; Marchese, *Sagro diario*; Steill, *Ephemerides dominicano sacrae* (Dillingen, 1692); Petrus de Alva y Astorga, *Prodigium naturae portentium gratiae* (Strassburg, 1664); Thiepolus, *De passione Christi*, tract. xii.; Meyer, *Blätter für höhere Wahrheit*, vii. 5; Hurter, *Tableau des institutions et des mœurs de l'église au moyen âge* (Paris, 1842); Görres, *Die christliche Mystik*, ii. 410 sqq. (Ratisbon); Franciscus Quaresmius, *De vulneribus domini*, i. 4 (Venice, 1652); Raynaud, *Opera*, vol. xiii. (Lyons, 1665); Dublin Review (1871), p. 170; Maury, *Magie et astrologie*; Beaunis, *Recherches exp. sur l'activité cérébrale* (Paris, 1886); Bourbeyre, *Les Stigmatisées* (Paris, 1886); Ennemoser, *Der Magnetismus im Verhältnis zur Religion*, § 92 (Stuttgart, 1853); Tholuck's *Vermischte Schriften*, p. 97 (Hamburg, 1839); Schmieder, in *Evang. Kirchenzeitung*, pp. 180, 345 (Berlin, 1875); *Comptes rendus de la société de biologie* (July 12, 1885); Barthélemy, *Étude sur le dermatographe ou dermo-neurose toxi-vaso-motrice* (Paris, 1898); Imbert-Goarbeyre, *Les Stigmatisées* (1873).

(A. MA.)

STILBITE, a mineral of the zeolite group consisting of hydrated calcium aluminium silicate, $\text{CaAl}_2(\text{SiO}_3)_6 + 6\text{H}_2\text{O}$. Usually a small proportion of the calcium is replaced by sodium. Crystals are monoclinic, and are invariably twinned, giving rise to complex groups and characteristic sheaf-like aggregates. The colour is usually white, sometimes red, and on the perfect cleavage (parallel to the plane of symmetry) the lustre is markedly pearly; hence the name stilbite given by R. J. Haiiy in 1796, from Gr. *στίλβειν*, to shine. After the separation of heulandite from this species in 1818, the name desmine (from *δέσμη*, a bundle) was proposed, and this name is now employed in Germany. The hardness is $3\frac{1}{2}$ and the specific gravity 2.2. Stilbite is a mineral of secondary origin, and occurs with other zeolites in the amygdaloidal cavities of basic volcanic rocks; it is sometimes found in granite and gneiss, and exceptionally in metalliferous veins. It is abundant in the volcanic rocks of Iceland, Faeroe Islands, Island of Skye, Bay of Fundy, in Nova Scotia and elsewhere. Beautiful, salmon-pink crystals occur with pale green apophyllite in the Deccan traps near Bombay and Poona; white sheaf-like groups encrust the calcite (Iceland-spar) of Berufjord near Djupivogur in Iceland; and crystals of a brick-red colour are found at Old Kilpatrick in Dumbartonshire. (L. J. S.)

STILE, a series of steps of stone or wood, or a combination of bars and steps used for passing over a fence or wall without the necessity of a permanent open passage or of opening or shutting a gate. The Old English, *stigel* is formed from *stigan*, to climb, ascend; stair (O. Eng. *staeger*) and stirrup are from the same root. Stile (Lat. *stilus*, a pointed instrument) is really the correct spelling of style (*q.v.*).

STILES, EZRA (1727-1795), American clergyman and educationalist, seventh president of Yale College, was born on the 29th of November 1727 in North Haven, Connecticut, where his father, Isaac Stiles (d. 1760), was minister of the Congregational Church. He graduated at Yale in 1746; studied there for the three years following; was licensed to preach in 1749 and was a tutor at Yale in 1749-1755. He preached in 1750 to the Indians at Stockbridge, later studied law, was admitted to the bar in 1753, and practised in New Haven for two years. He was pastor of the Second Congregational Church of Newport, Rhode Island, from 1755 to 1777; in 1776-1777 he preached occasionally in Dighton, Massachusetts, whither he had removed his family after the British occupation of Newport; and in April 1777 he became pastor of the North Church of Portsmouth, New Hampshire. In 1778 he became president of Yale College and professor of ecclesiastical history there, having insisted that no theological statement be required of him except assent to the Saybrook platform of 1708; in 1780-1782 he was professor of divinity, and he lectured besides on astronomy and philosophy. He died in New Haven on the 12th of May 1795. His wise administration as president made possible the speedy recovery of Yale College after the War of Independence, and his intellectual and theological breadth helped to secularize and strengthen the college. As an undergraduate he became deeply interested in astronomy; he observed the comet of 1759 and the transit of Venus of June 1769, and left a quarto volume of astronomical notes. He experimented successfully with the electrical apparatus presented to Yale by Benjamin Franklin, whose intimate friend he became. He carefully kept thermometric and meteorological statistics; he imported silkworms and books on silk culture; he corresponded with many litterati—notably with Dr Nathaniel Lardner and with Sir William Jones, of whom he besought information of all kinds, but especially any that would lead to the discovery of the whereabouts of the ten lost tribes; and he undertook the study of Hebrew at the age of forty and became an able scholar. On Franklin's recommendation he was made a doctor of divinity by the university of Edinburgh in 1765; he had received a master's degree at Harvard in 1754, and was made doctor of divinity in 1780 by Dartmouth and in 1784 by the college of New Jersey (now Princeton University).

Dr Stiles published several sermons, notably, a *Discourse on the Christian Union* (1761), which has remarkable ecclesiastical breadth of view; an *Account of the Settlement of Bristol, Rhode Island* (1785); and a *History of Three of the Judges of King Charles I.: Major-General Whalley, Major-General Goffe and Colonel Dixwell* (1794). He began in 1768 but never finished an *Ecclesiastical History of New England and British America*. His *Literary Diary* was published in New York in 3 vols. in 1901, being edited by F. B. Dexter, who quotes largely from Dr Stiles's *Itineraries*, a daily account of his travels; the *Diary* gives a valuable picture of the life of New England in 1769-1795 and many interesting estimates of Stiles's contemporaries. See the *Life of Ezra Stiles* (Boston, 1798), by his daughter's husband, Abiel Holmes, the father of Oliver Wendell Holmes.

STILETTO (an Italian diminutive of *stilo*, dagger, Lat. *stilus*, a pointed instrument), a short stabbing dagger, the blade of which is either triangular or square in form. The term is also applied to a pointed bodkin of ivory, bone or metal used for making eyelet holes, &c.

STILICHO, FLAVIUS (?-408), Roman general and statesman, was the son of a Vandal who had served as an officer in the army of the emperor Valens (364-378). He himself entered the imperial army at an early age and speedily attained high promotion. He had already become master of the horse when in 383 he was sent by Theodosius (379-395) at the head of an embassy to the Persian king, Sapor III. His mission was very successful, and soon after his return he was made count of the domestics and received in marriage Serena, the emperor's niece and adopted daughter. In 385 he was appointed master of the soldiery (*magister militum*) in Thrace, and shortly afterwards directed energetic campaigns in Britain against Picts, Scots and Saxons, and along the Rhine against other barbarians. Stilicho and Serena were named guardians of the youthful Honorius when the latter was created joint emperor in 394 with special jurisdiction over Italy, Gaul, Britain, Spain and Africa, and Stilicho was even more closely allied to the imperial family in the following year by betrothing his daughter Maria to his ward and by receiving the dying injunctions of Theodosius to care for his children. Rivalry had already existed between Stilicho and Rufinus, the praetorian praefect of the East, who had exercised considerable influence over the emperor and who now was invested with the guardianship of Arcadius. Consequently in 395, after a successful campaign against the Germans on the Rhine, Stilicho marched to the east, nominally to expel the Goths and Huns from Thrace, but really with the design of displacing Rufinus, and by connivance with these same barbarians he procured the assassination of Rufinus at the close of the year, and thereby became virtual master of the empire. In 396 he fought in Greece against the Visigoths, but an arrangement was effected whereby their chieftain Alaric was appointed master of the soldiery in Illyricum (397). In 398 he quelled Gildo's revolt in Africa and married his daughter Maria to Honorius. Two years later he was consul. He thwarted the efforts of Alaric to seize lands in Italy by his victories at Pollentia and Verona in 402-3 and forced him to return to Illyricum, but was criticized for having withdrawn the imperial forces from Britain and Gaul to employ against the Goths. He manoeuvred so skilfully in the campaign against Radagaisus, who led a large force of various Germanic peoples into Italy in 405, that he surrounded the barbarian chieftain on the rocks of Fiesole near Florence and starved him into surrender. Early in 408 he married his second daughter Thermania to Honorius. It was rumoured about this time that Stilicho was plotting with Alaric and with Germans in Gaul and taking other treasonable steps in order to make his own son Eucherius emperor. There are conflicting accounts of the plots and counterplots and of the court intrigues, the relative truth of which will probably never be known. It is certain, however, that he was suspected by Honorius and abandoned by his own troops, and that he fled to Ravenna, and, having been induced by false promises to quit the church in which he had taken sanctuary, was assassinated on the 23rd of August 408.

The principal sources for the life of Stilicho are the histories of Zosimus and of Orosius and the flattering verses of Claudian. See T. Hodgkin, *Italy and her Invaders*, vols. i. and ii. (Oxford, 1880);

E. Gibbon, *Decline and Fall of the Roman Empire*, edited by J. B. Bury, vol. iii. (London, 1902); P. Villari, *The Barbarian Invasions of Italy*, translated by L. Villari, vol. i. (New York, 1902); S. Dill, *Roman Society in the last century of the Western Empire* (London, 1899). (C. H. HA.)

STILL. (1) (O. Eng. *stille*, a word appearing in many Teutonic languages, all derived from the root, meaning to set in position or rest, seen in "stall," Ger. *stellen*, &c.), motionless, noiseless, or when used of wines or mineral waters, having little or no effervescence. As an adverb, "still" has preserved the original sense of "that which preserves its position," and thus means continually, permanently, now as before. (2) From the shortened form of "distil," Lat. *distillare*, to drip, trickle down, *stilla*, a drop, dim. of *stiria*. The older word for a "still" in English was *stillatory*, Medieval Latin *stillatorium*, an apparatus for heating substances and condensing the vapours (see DISTILLATION and SPIRITS).

STILL, JOHN (c. 1543-1608), bishop of Bath and Wells, formerly reputed to be the author of *Gammer Gurton's Needle*, was born about 1543 at Grantham, Lincolnshire. He became a student of Christ's College, Cambridge, where he graduated B.A. in 1562, M.A. in 1565, and D.D. in 1575. In 1561 he became a fellow of his college and took holy orders. He was appointed in 1570 Lady Margaret professor of divinity, subsequently held livings in Suffolk and Yorkshire, and was master successively of St John's College (1574) and of Trinity College (1577). Still was vice-chancellor of his university in 1575-1576 and again in 1592-1593, and was raised to the bishopric of Bath and Wells in 1593. He died on the 26th of February 1608, leaving a large fortune from lead mines discovered in the Mendip Hills.

Gammer Gurton's Needle is the second extant English comedy, properly so called. Still, whose reputation as a serious churchman cannot be easily reconciled with the buffoonery of *A Ryght Pithy, Pleasaunt and merie Comedie: Intytuled Gammer Gurtons Nedle*, was first credited with its authorship by Isaac Reed in his edition (1782) of Baker's *Biographia dramatica*. The title-page of the piece, which was printed by Thomas Colwell in 1575, states that it was played not long ago at Christ's College, Cambridge, and was "made by Mr S. Mr of Art." A play was acted at Christmas 1567, and Still was chosen as being the only M.A. on the register at that time whose name began with S. There are reasons to suppose however that the play had been in Colwell's hands some time before it was printed, and it may well be identical with the *Dycon of Bedlam* for which he took out a licence in 1562-1563, "Diccon the Bedlem" being the first of the dramatis personae of *Gammer Gurton*. In the accounts of Christ's College for 1559-1560 is the entry, "Spent at Mr Stevenson's plaie, 5s." William Stevenson was born at Hunwick, Durham, matriculated in 1546, took his M.A. degree in 1553, and became B.D. in 1560. Stevenson was a fellow of Christ's College from 1559 to 1561, and is perhaps to be identified with a William Stevenson who was a fellow from 1551 to 1554. If such is the case, there is reason to think that the composition of *Gammer Gurton's Needle* should be referred to the earlier period. He was made prebendary of Durham in 1560-1561, and died in 1575. Contemporary Puritan writers in the Marprelate tracts allude to Dr John Bridges, dean of Salisbury, author of *A Defence of the Government of the Church of England*, as the reputed author of *Gammer Gurton's Needle*, but he obviously could not be properly described as "Mr S." Dr Bridges took his M.A. degree at Pembroke College, Cambridge, in 1560, and the witty and sometimes coarse character of his acknowledged work makes it reasonable to suppose that he may have been a coadjutor of the author.

For the argument on behalf of William Stevenson's authorship, see Henry Bradley's essay prefixed to his edition of the play in *Representative English Comedies* (1903). The piece is also reprinted in Dodsley's *Old Plays* (vol. i., 1744; vol. ii., 1780); in *Ancient British Drama* (1810), vol. i.; and in J. M. Manly's *Specimens of the Pre-Shakespearean Drama* (Boston, U.S.A., 1897).

STILICIDIUM. a dripping of water from the eaves (*stilla*, drop, *cadere*, to fall), the term in architecture given by Vitruvius (iv. 7) to the dripping eaves of the roof of the Etruscan temple.

Similar dripping eaves existed in most of the Greek Doric temples in contradistinction to the Ionic temples, where the water of the roof was collected in the cymatium or gutter and thrown out through the mouths of lions, whose heads were carved on the cymatium.

STILLINGFLEET, EDWARD (1635-1699), English divine, was born at Cranborne, Dorset, on the 17th of April 1635. There and at Ringwood he received his early education, and at the age of thirteen was entered at St John's College, Cambridge. He took his B.A. in 1652, and in the following year was elected to a fellowship. After residing as tutor first in the family of Sir Roger Burgoyne in Warwickshire and then with the Hon. Francis Pierrepont at Nottingham, he was in 1657 presented by the former to the living of Sutton in Bedfordshire. Here he published (1659) his *Irenicum*, in which he sought to give expression to the prevailing weariness of the faction between Episcopacy and Presbyterianism, and to find some compromise in which all could conscientiously unite. He looks upon the form of church government as non-essential, but condemns Nonconformity. In 1662 (the year of the Act of Uniformity) he reprinted the *Irenicum* with an appendix, in which he sought to prove that "the church is a distinct society from the state, and has divers rights and privileges of its own." Stillingfleet's actions were as liberal as his opinions, and he aided more than one ejected minister. In later years he was not so liberal. But, though in 1680 he published his *Unreasonableness of Separation*, his willingness to serve on the ecclesiastical commission of 1689, and the interpretation he then proposed of the damnatory clauses of the Athanasian creed, are proof that to the end he leaned towards toleration. His rapid promotion dates from 1662, when he published *Origines sacrae, or a Rational Account of the Christian Faith as to the Truth and Divine Authority of the Scriptures and the Matters therein contained*. Humphrey Henchman, bishop of London, employed him to write a vindication of Laud's answer to John Fisher, the Jesuit. In 1665 the earl of Southampton presented him to St Andrew's, Holborn, two years later he became prebendary of St Paul's, in 1668 chaplain to Charles II., in 1670 canon residentiary, and in 1678 dean of St Paul's. He was also preacher at the Rolls Chapel and reader at the Temple. Finally he was consecrated bishop of Worcester on the 13th of October 1689. During these years he was ceaselessly engaged in controversy with Nonconformists, Romanists, Deists and Socinians. His unrivalled and various learning, his dialectical expertness, and his massive judgment, rendered him a formidable antagonist; but the respect entertained for him by his opponents was chiefly aroused by his recognized love of truth and superiority to personal considerations. He was one of the seven bishops who resisted the proposed Declaration of Indulgence (1688). The range of his learning is most clearly seen in his *Bishop's Right to Vote in Parliament in Cases Capital*. His *Origines Britannicae, or Antiquities of the British Church* (1685), is a strange mixture of critical and uncritical research. He was so handsome in person as to have earned the sobriquet of "the beauty of holiness." In his closing years he had some controversy with John Locke, whom he considered to have impugned the doctrine of the Trinity. He died at Westminster on the 28th of March 1699, and was buried at Worcester. His manuscripts were bought by Robert Harley (afterwards earl of Oxford), his books by Narcissus Marsh, archbishop of Armagh.

A collected edition of his works, with life by Richard Bentley, was published in London (1710); and a useful edition of *The Doctrines and Practices of the Church of Rome Truly Represented* was published in 1845 by William Cunningham.

STILLMAN, WILLIAM JAMES (1828-1901), American painter and journalist, was born at Schenectady, New York, on the 1st of June 1828. His parents were Seventh-Day Baptists, and his early religious training influenced him all through his life. He was sent to school in New York by his mother, who made great sacrifices that he might get an education, and he graduated at Union College, Schenectady, in 1848. He studied art under Frederick E. Church and early in 1850 went to England, where he made the acquaintance of Ruskin, whose *Modern Painters* he

had devoured, was introduced to Turner, for whose works he had unbounded admiration, and fell so much under the influence of Rossetti and Millais that on his return home in the same year he speedily became known as the "American Pre-Raphaelite." In 1852 Kossuth sent him on a fool's errand to Hungary to dig up crown jewels, which had been buried secretly during the insurrection of 1848-1849. While he was awaiting a projected rising in Milan, Stillman studied art under Yvon in Paris, and then, as the rising did not take place, he returned to the United States and devoted himself to landscape painting on Upper Saranac Lake in the Adirondacks and in New York City, where he started the *Crayon*. It numbered Lowell, Aldrich and Charles Eliot Norton among its contributors, and when it failed for want of funds, Stillman removed to Cambridge, Massachusetts. There he passed several years, but a fit of restlessness started him off once more to England. He renewed his friendship with Ruskin, and went with him to Switzerland to paint and draw in the Alps, where he worked so assiduously that his eyesight was affected. He then lived in Paris and was in Normandy in 1861 when the American Civil War broke out. He made more than one attempt to serve in the Northern ranks, but his health was too weak; in the same year he was appointed United States consul in Rome. In 1865 a dispute with his government led to his resignation, but immediately afterwards he was appointed to Crete, where, as an avowed champion of the Christians in the island and of Cretan independence, he was regarded with hostility both by the Mussulman population and by the Turkish authorities, and in September 1868 he resigned and went to Athens, where his first wife (a daughter of David Mack of Cambridge), worn out by the excitement of life in Crete, committed suicide. He was an editor of *Scribner's Magazine* for a short time and then went to London, where he lived with D. G. Rossetti. In 1871 he married a daughter of Michael Spartali, the Greek consul-general. When the insurrection of 1875 broke out in Herzegovina he went there as a correspondent of *The Times*, and his letters from the Balkans aroused so much interest that the British government was induced to lend its countenance to Montenegrin aspirations. In 1877-1883 he served as the correspondent of *The Times* at Athens; in 1886-1898 at Rome. He was a severe critic of Italian statesmen, and embroiled himself at various times with various politicians, from Crispi downwards. After his retirement he lived in Surrey, where he died on the 6th of July 1901. He wrote *The Cretan Insurrection of 1866-1868* (1874). *On the Track of Ulysses* (1888), *Billy and Hans* (1897) and *Francesco Crispi* (1899).

See his *Autobiography of a Journalist* (2 vols., Boston, 1901).

STILLWATER, a city and the county-seat of Washington county, Minnesota, U.S.A., at the head of Lake St Croix, on the west bank of the St Croix river, 20 m. above its mouth, and about 20 m. N.E. of St Paul. Pop. (1890) 11,260; (1900) 12,318; (1905 state census) 12,435, 3,586 being foreign-born (1189 Swedes, 849 Germans, 828 Canadians); (1910 U.S. census) 10,198. It is served by the Northern Pacific, the Chicago, St Paul, Minneapolis & Omaha, and the Chicago, Milwaukee & St Paul railways, and is connected by electric line with St Paul and Minneapolis. The city is picturesquely situated on bluffs rising from the St Croix and commanding fine views. Among the public buildings are a handsome public library, the city hall, the county court-house, the Federal building, an auditorium, and the city hospital, and the city is the seat of the Stillwater business college, and of the Minnesota state prison, established in 1851, in which a system of parole and of graded diminution of sentences is in force, and in connexion with which is maintained a school and a library. Commercially Stillwater is important as a centre of the lumber trade and as a shipping point for cereal products. The valuable water-power is utilized by its varied manufactories. In 1905 the value of the factory products was \$2,784,113 an increase of 54.6% since 1900. Stillwater, the first town platted in Minnesota, was permanently settled in 1843, and was laid out in 1848 by Joseph Renshaw Brown (1805-1870), a pioneer editor and soldier. Here met in 1848 the "Stillwater Convention," famous in Minnesota history

as the first step in the erection of Minnesota Territory. Stillwater was chartered as a city in 1854. The first electric railway in the state was completed here in 1889, but failed later.

STILO PRAECONINUS, LUCIUS AELIUS, (c. 154-74 B.C.), of Lanuvium, the earliest Roman philologist, was a man of distinguished family and belonged to the equestrian order. He was called Stilo (*stilus*, pen), because he wrote speeches for others, and Praeconinus from his father's profession (*praeco*, public crier). His aristocratic sympathies were so strong that he voluntarily accompanied Q. Caecilius Metellus Numidicus into exile. At Rome he divided his time between teaching (although not as a professional schoolmaster) and literary work. His most famous pupils were Varro and Cicero, and amongst his friends were Coelius Antipater, the historian, and Lucilius, the satirist, who dedicated their works to him. According to Cicero, who expresses a poor opinion of his powers as an orator, Stilo was a follower of the Stoic school. Only a few fragments of his works remain. He wrote commentaries on the hymns of the Salii, and (probably) on the Twelve Tables; and investigated the genuineness of the Plautine comedies, of which he recognized 25, four more than were allowed by Varro. It is probable that he was the author of a general glossographical work, dealing with literary, historical and antiquarian questions. The rhetorical treatise *Ad Herennium* has been attributed to him by some modern scholars.

See Cicero, *Brutus*, 205-207, *De legibus*, ii. 23, 59; Suetonius, *De grammaticis*, 2; Gellius iii. 3, 1. 12; Quintilian, *Inst. orat.* x., 1, 99; monographs by J. van Heusde (1839) and F. Mentz (1888); Mommsen, *Hist. of Rome*, bk. iv. ch. 12, 13; J. E. Sandys, *History of Classical Scholarship* (2nd ed., 1906); M. Schanz, *Geschichte der römischen Literatur* (1898), vol. i.; Teuffel, *Hist. of Roman Literature* (Eng. trans., 1900), p. 148.

STILPO [STILPON], Greek philosopher of the Megarian school (*q.v.*), was a contemporary of Theophrastus and Crates. Intellectually in agreement with the Megarian dialectic, he followed the practical ethics of the Cynics both in theory and in practice. He extolled the Cynic ἀπαθelia (loosely, self-control) as the principal virtue. Cicero (*De fato*, 5) describes him as a man of the highest character. Suidas attributes twenty dialogues to him, but of these no fragments remain. Among his followers were Menedemus and Asclepiades, the leaders of the Eretrian school of philosophy. Seneca (*Epistle* 9) shows how closely allied Stilpo was to the Stoics (*q.v.*).

STILT, or LONG-LEGGED PLOVER, a bird so-called (see STILTS) for reasons obvious to anyone who has seen it, since, though not very much bigger than a snipe, the length of its legs (their bare part measuring 8 in.), in proportion to the size of its body exceeds that of any other bird's. The first name (a translation of the French *écharpe*, given in 1760 by M. J. Brisson) seems to have been bestowed by J. Rennie only in 1831; but, recommended by its definiteness and brevity, it has wholly supplanted the second and older one. The bird is the *Charadrius himantopus*¹ of Linnaeus, the *Himantopus candidus* or *melanopterus* of modern writers, and belongs to the group *Limicolae*, having been usually placed in the family *Scolopacidae*, though it might be quite as reasonably referred to the *Charadriidae*, and, with its allies to be immediately mentioned, would seem to be not very distant from *Haematopus*, notwithstanding the wonderful development of its legs and the slenderness of its bill.

The stilt obtains its food by wading in shallow water and seizing the insects that fly over or float upon its surface or the small crustaceans that swim beneath, for which purpose its slender extremities are, as might be expected, admirably adapted. Widely spread over Asia, North Africa, and Southern Europe, it has many times visited Britain—though always as a straggler, for it is not known to breed to the northward of the Danube valley—and its occurrence in Scotland (near Dumfries)

¹ The possible confusion by Pliny's transcribers of this word with *Haematopus* is referred to under OYSTERCATCHER. *Himantopus*, with its equivalent *Loripes*, "by an awkward metaphor," as remarked by Gilbert White, "implies that the legs are as slender and pliant as if cut out of a thong of leather."

was noticed by Sibbald so long ago as 1684. It chiefly resorts to pools or lakes with a margin of mud, on which it constructs a slight nest, banked round or just raised above the level so as to keep its eggs dry (*Ibis*, 1859, p. 360); but sometimes they are laid in a tuft of grass. They are four in number, and, except in size, closely resemble those of the oystercatcher (*q.v.*). The bird has the head, neck, and lower parts white, the back and wings glossy black, the irides red, and the bare part of the legs pink. In America the genus has two representatives, one²



(After Gosse.) FIG. 1.—Black-necked American Stilt.

(fig. 1) closely resembling that just described, but rather smaller and with a black crown and nape. This is *H. nigricollis* or *mexicanus*, and occurs from New England to the middle of South America, beyond which it is replaced by *H. brasiliensis*, which has the crown white. The stilt inhabiting India is now recognized to be *H. candidus*, but Australia possesses a distinct species, *H. novae-hollandiae*, which also occurs in New Zealand, though that country has in addition a species peculiar to it, *H. novae-zelandiae*, differing from all the rest by assuming in the breeding-season an altogether black plumage. Australia, however, presents another form, which is the type of the genus *Cladorhynchus*, and differs from *Himantopus* both in its style of plumage (the male having a broad bay pectoral belt), in its shorter tarsi, and in having the toes (though, as in the stilt's feet, three in number on each foot) webbed.

Allied in many ways to the stilts, but differing in many undeniably generic characters, are the birds known as Avocets,³ forming the genus *Recurvirostra* of Linnaeus. Their bill, which is perhaps the most slender to be seen in the whole class, curves upward towards the end, and has given the oldest known species two names which it formerly bore in England,—“cobbler's-awl,” from its likeness to the tool so called, and “scooper,” because it resembled the scoop with which mariners threw water on their sails. The legs, though long, are not extraordinarily so, and the feet, which are webbed, bear a small hind toe.

This species (fig. 2), the *R. avocetta* of ornithology, was of old time plentiful in England, though doubtless always restricted to certain localities. Charleton in 1668 says that when a boy he had shot not a few on the Severn, and Plot mentions it so as to lead one to suppose that in his time (1686) it bred in Staffordshire, while F. Willughby (1676) knew of it as being in winter on the eastern coast, and T. Pennant in 1769 found it in great numbers opposite to Fosdyke Wash in Lincolnshire, and described the birds as hovering over the sportsman's head like lapwings. In this district they were called “Yelpers” from their cry;⁴ but whether that name was

² This species was made known to Ray by Sloane, who met with it in Jamaica, where in his day it was called “long-legs.”

³ This word is from the Bolognese *Avocetta*, which is considered to be derived from the Latin *avis*—the termination expressing a diminutive of a graceful or delicate kind, as *donnetta* from *donna* (Professor Salvadori in *epist.*).

⁴ Cf. “yarwhelp” (see GODWIT) and “yaup” or “whaup” (see CURLEW). “Barker” and “clinker” seem to have been names used in Norfolk.

elsewhere applied is uncertain. At the end of the last century they frequented Romney Marsh in Kent, and in the first quarter of the present century they bred in various suitable spots in Suffolk and Norfolk—the last place known to have been inhabited by them being Salthouse, where the people made puddings of their eggs, while the birds were killed for the sake of their feathers, which were used in making artificial flies for fishing. The extirpation of this settlement took place between 1822 and 1825 (cf. Stevenson, *Birds of Norfolk*, ii. 240, 241). The avocet's mode of nesting is much like that of the stilt, and the eggs are hardly to be distinguished from those of the latter but by their larger size, the bird being about as big as a lapwing (*q.v.*), white, with the exception of its crown, the back of the neck, the inner scapulars, some of the wing-coverts and

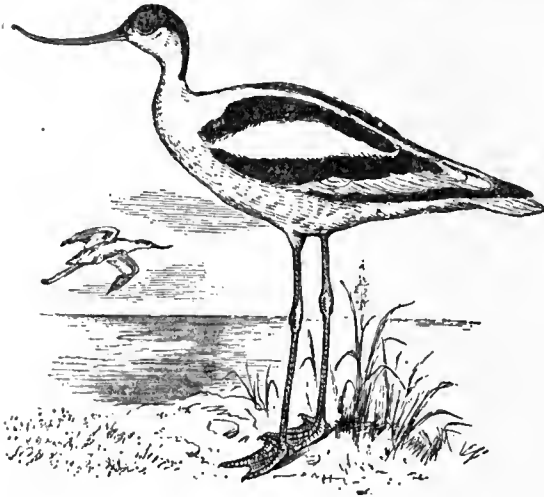

(After Naumann.)

FIG. 2.—Avocet.

the primaries, which are black, while the legs are of a fine light blue. It seems to get its food by working its bill from side to side in shallow pools, and catching the small crustaceans or larvae of insects that may be swimming therein, but not, as has been stated, by sweeping the surface of the mud or sand—a process that would speedily destroy the delicate bill by friction. Two species of avocet, *R. americana* and *R. andina*, are found in the New World; the former, which ranges so far to the northward as the Saskatchewan, is distinguished by its light cinnamon-coloured head, neck and breast, and the latter, confined so far as known to the mountain lakes of Chile, has no white in the upper parts except the head and neck. Australia produces a fourth species, *R. novae-hollandiae* or *rubricollis*, with a chestnut head and neck; but the European *R. avocetta* extends over nearly the whole of middle and southern Asia as well as Africa. (A. N.)

STILTED, a term in architecture, given to anything raised above its usual level; it is usually applied to the arch, which is said to be stilted when its centre is raised above the capital or impost. In Byzantine architecture this was frequently done in order to give more importance to the twin arches of the windows, and less to the shaft which divided them. In Romanesque and Gothic work the stilted arch was often employed in the semi-circular apses, where in consequence of the closer juxtaposition of the columns round the apse the arches were much narrower than those of the choir; in order, however, that the apex of all the arches should be of the same height, the apse arches were stilted.

STILTS, poles provided at a certain distance above the ground with steps or stirrups for the feet, for the purpose of walking on them. As a means of amusement stilts have been used by all peoples in all ages, as well as by the inhabitants of marshy or flooded districts. The city of Namur in Belgium, which formerly suffered from the overflowing of the rivers Sambre and Meuse, has been celebrated for its stilt-walkers for many centuries. Not only the towns-people but also the soldiers used stilts, and stilt-fights were indulged in, in which parties of a hundred or more attacked each other, the object being to overset as many of the enemy as possible. The governor of Namur having promised the archduke Albert (about 1600) a company of soldiers that should neither ride nor walk, sent a detachment on stilts, which so pleased the archduke that he conferred upon the city perpetual exemption from the beer-tax, no small privilege at that time.

The home of stilt-walking at the present day is the department of Landes in Gascony, where, owing to the impermeability of the subsoil, all low-lying districts are converted into marshes, compelling the shepherds, farmers and marketmen to spend the greater part of their lives on stilts. These are strapped to the leg below the knee, the foot resting in a stirrup about five feet from the ground. Their wearers, who are called *ichangues* (long-legs) in the Gascon dialect, also carry long staves, which are often provided with a narrow piece of board, used as a seat in case of fatigue. In the last quarter of the 19th century stilt-races, for women as well as men, became very popular in the Landes district, and still form an important feature of every provincial festivity. One winner of the annual championship races accomplished 490 kilometres (more than 304 m.) in 103 hours, 36 minutes. Silvain Dornon, a baker of the Landes, walked on stilts from Paris to Moscow in 58 days in the spring of 1891. The rapids of the Niagara have been waded on stilts. In many of the Pacific islands, particularly the Marquesas, stilts are used during the rainy season. Stilts used by children are very long, the upper half being held under the arms; they are not strapped to the leg. Stilts play an important part in the Italian masquerades, and are used for mounting the gigantic figures in the grotesque processions of Lisle, Dunkirk, Louvain and other cities.

STINDE, JULIUS (1841–1905), German author, was born at Kirchmüchel near Eutin on the 28th of August 1841, the son of a clergyman. Having attended the gymnasium at Eutin, he was apprenticed in 1858 to a chemist in Lübeck. He soon tired of the shop, and went to study chemistry at Kiel and Giessen where he proceeded to the degree of doctor of philosophy. In 1863 Stinde received an appointment as consulting chemist to a large industrial undertaking in Hamburg; but, becoming editor of the *Hamburger Gewerbeblatt*, he gradually transferred his energies to journalism. His earliest works were little comedies, dealing with Hamburg life, though he continued to make scientific contributions to various journals. In 1876 Stinde settled in Berlin and began the series of stories of the Buchholz family, vivid and humorous studies of Berlin middle-class life by which he is most widely known. He died at Olsberg near Kassel on the 7th of August 1905.

The first of the series *Buchholzens in Italien* (translated by H. F. Powell, 1887) appeared in 1883 and achieved an immense success. It was followed by *Die Familie Buchholz* in 1884 (translated by L. D. Schmitz, 1885); *Frau Buchholz im Orient* in 1888; *Frau Wilhelmine (Der Familie Buchholz letzter Teil)*; translated by H. F. Powell, 1887) in 1886; *Wilhelmine Buchholz' Memoiren*, in 1894; and *Hotel Buchholz; Ausstellungenserlebnisse der Frau Wilhelmine Buchholz*, in 1896. Under the pseudonyms of Alfred de Valmy, Wilhelmine Buchholz and Richard E. Ward, he also published various other works of more or less merit, among which his *Naturphilosophie* (1898) deserves special mention; his *Waldnovellen* (1881) have been translated into English.

STINK-WOOD, in botany, a South African tree, known botanically as *Ocotea bullata*, and a member of the family Laurineae. Other names for it are Cape Walnut, Stinkhout, Cape Laurel and Laurel wood. It derives its name from having a strong and unpleasant smell when fresh felled. It is used for building in South Africa and is described by Stone (*Timbers of Commerce*, p. 174) as "the most beautiful dark-coloured wood that I have yet met with." It is said to be a substitute for teak and equally durable. The wood is dark walnut or reddish brown to black with a yellow sap-wood, and the grain extremely fine, close, dense and smooth.

STIPEND, a fixed periodical payment or salary for services rendered. The word is particularly used of the income from an ecclesiastical benefice or of the salary paid to any minister of religion. In the United Kingdom a paid magistrate or justice of the peace, appointed by the Crown on the advice of the home secretary for certain boroughs are termed "stipendiaries" or "stipendiary magistrates" (see JUSTICE OF THE PEACE). The Latin *stipendium* (for *stipendium*) is derived from *stips*, a gift, contribution (originally a heap of coins, *stipare*, to press; mass together) and *pendere*, to weigh out, pay. This was applied first to the pay of the army, and hence was used in the sense of

military service, in such phrases as *stipendia facere*, and of a campaign, e.g. *vicena stipendia meritis* (Tac. Ann. i. 17). It also meant a tax or impost, payable in money.

STIRLING, MARY ANNE [FANNY] (1815–1895), English actress, was born in London, the daughter of a Captain Kehl. After some experience at outlying theatres, she appeared in London in 1836. Having been successful as Celia in *As You Like It* and Sophia in *The Road to Ruin*, Macready gave her an opportunity to play Cordelia to his Lear, and Madeline Weir to his James V. in the Rev. James White's *King of the Commons*. In 1852 she created Peg Woffington in Reade and Taylor's *Masks and Faces*. Meanwhile she had married Edward Stirling (d. 1894), an actor, manager and dramatic author. In later years Mrs Stirling gained a new popularity as the nurse in Irving's presentation (1882) of *Romeo and Juliet*, and again (1884) with Mary Anderson; and she was the Martha in Irving's production of *Faust* (1885). She died on the 30th of December 1895, having in the previous year married Sir Charles Hutton Gregory (1817–1898).

STIRLING, JAMES (1692–1770), Scottish mathematician, third son of Archibald Stirling of Garden, and grandson of Sir Archibald Stirling of Keir (Lord Garden, a lord of session), was born at Garden, Stirlingshire, in 1692. At eighteen years of age he went to Oxford, where, chiefly through the influence of the earl of Mar, he was nominated (1711) one of Bishop Warner's exhibitioners at Balliol. In 1715 he was expelled on account of his correspondence with members of the Keir and Garden families, who were noted Jacobites, and had been accessory to the "Gathering of the Brig o' Turk" in 1708. From Oxford he made his way to Venice, where he occupied himself as a professor of mathematics. In 1717 appeared his *Lineae tertii ordinis Newtonianae, sive . . .* (8vo, Oxford). While in Venice, also, he communicated, through Sir Isaac Newton, to the Royal Society a paper entitled "Methodus differentialis Newtoniana illustrata" (*Phil. Trans.*, 1718). Fearing assassination on account of having discovered a trade secret of the glass-makers of Venice, he returned with Newton's help to London about the year 1725. In London he remained for ten years, being most part of the time connected with an academy in Tower Street, and devoting his leisure to mathematics and correspondence with eminent mathematicians. In 1730 his most important work was published, the *Methodus differentialis, sive tractatus de summatione et interpolatione serierum infinitarum* (4to, London), which, it must be noted, is something more than an expansion of the paper of 1718. In 1735 he communicated to the Royal Society a paper "On the Figure of the Earth, and on the Variation of the Force of Gravity at its Surface." In the same year he was appointed manager for the Scots Mining Company at Leadhills. We are thus prepared to find that his next paper to the Royal Society was concerned, not with pure, but with applied science—"Description of a Machine to blow Fire by the Fall of Water" (*Phil. Trans.* 1745). His name is also connected with another practical undertaking, since grown to vast dimensions. The accounts of the city of Glasgow for 1752 show that the very first instalment of ten millions sterling spent in making Glasgow a seaport, viz. a sum of £28, 4s. 4d., was for a silver tea-kettle to be presented to "James Stirling, mathematician, for his service, pains, and trouble in surveying the river towards deepening it by locks." Stirling died in Edinburgh on the 5th of December 1770.

See W. Fraser, *The Stirlings of Keir, and their Family Papers*, (Edinburgh, 1858); "Modern History of Leadhills," in *Gentleman's Magazine* (June, 1853); Brewster, *Memoirs of Sir Isaac Newton*, ii. 300, 307, 411, 516; J. Nicol, *Vital Statistics of Glasgow* (1881–1885), p. 70; *Glasgow Herald* (Aug. 5, 1886).

Another edition of the *Lineae tertii ordinis* was published in Paris in 1797; another edition of the *Methodus differentialis* in London in 1764; and a translation of the latter into English by Halliday in London in 1749. A considerable collection of literary remains, consisting of papers, letters and two manuscript volumes of a treatise on weights and measures, are still preserved at Garden.

STIRLING, JAMES HUTCHISON (1820–1909), Scottish philosopher, was born at Glasgow on the 22nd of June 1820. He was educated at Glasgow University, where he studied medicine

and philosophy. For a short time he practised as a doctor in Wales, but gave up his profession in order to continue his philosophical studies in Germany and France. From 1888 to 1890 he was Gifford lecturer at the university of Edinburgh and published his lectures in 1890 (*Philosophy and Theology*). He was an LL.D. of Edinburgh University, and foreign member of the Philosophical Society of Berlin. He died in March 1909. His principal works are: *The Secret of Hegel* (1865; new ed. 1893); *Sir William Hamilton: The Philosophy of Perception*; a translation of Schwegler's *Geschichte der Philosophie* (1867; 12th ed., 1893); *Jerrold, Tennyson and Macaulay*, &c. (1868); *On Materialism* (1868); *As Regards Protoplasm* (1869; 2nd ed., 1872); *Lectures on the Philosophy of Law* (1873); *Burns in Drama* (1878); *Text-Book to Kant* (1881); *Philosophy in the Poets*; *Darwinianism*; *Workmen and Work* (1894); *What is Thought? Or the Problem of Philosophy*; *By Way of a Conclusion So Far* (1900); *The Categories* (1903). Of these the most important is *The Secret of Hegel*, which is admitted, both in England and in Germany, to be among the most scholarly and valuable contributions to Hegelian doctrine and to modern philosophy in general. In the preface to the new edition he explains that he was first drawn to the study of Hegel by seeing the name in a review, and subsequently heard it mentioned with awe and reverence by two German students. He set himself at once to grapple with the difficulties and to unfold the principles of the Hegelian dialectic, and by his efforts he introduced an entirely new spirit into English philosophy. Closely connected with the *Secret* is the *Text-Book to Kant*, which comprises a translation of the *Critique* with notes and a biography. In these two works Dr Stirling endeavoured to establish an intimate connexion between Kant and Hegel, and even went so far as to maintain that Hegel's doctrine is merely the elucidation and crystallization of the Kantian system. "The secret of Hegel," he says in the preliminary notice to his great work, "may be indicated at shortest thus: Hegel made *explicit* the *concrete* universal that was *implicit* in Kant."

The sixth part of the *Secret* contains valuable criticisms on the Hegelian writings of Schwegler, Rosenkranz and Haym, and explains by contrast much that has been definitely stated in the preceding pages. Of Dr Stirling's other works the most important is the volume of Gifford Lectures, in which he developed a theory of natural theology in relation to philosophy as a whole. *As Regards Protoplasm* contains an attempted refutation of the *Essay on the Physical Basis of Life* by Huxley.

STIRLING, WILLIAM ALEXANDER, EARL OF (c. 1567–1640), most generally known as Sir William Alexander, Scottish poet and statesman, son of Alexander Alexander of Menstrie (Clackmannanshire), was born at Menstrie House, near Stirling, about 1567. The family was old and claimed to be descended from Somerled, lord of the Isles, through John, lord of the Isles, who married Margaret, daughter of Robert II. William Alexander was probably educated at Stirling grammar school. There is a tradition that he was at Glasgow University; and, according to Drummond of Hawthornden, he was a student at the university of Leiden. He accompanied Archibald, 7th earl of Argyll, his neighbour at Castle Campbell, on his travels in France, Spain and Italy. He married, before 1604, Janet, daughter of Sir William Erskine, one of the Balgonie family. Introduced by Argyll at court, Alexander speedily gained the favour of James VI., whom he followed to England, where he became one of the gentlemen-extraordinary of prince Henry's chamber. For the prince he wrote his *Paraenesis to the Prince . . .* (1604), a poem in eight-lined stanzas on the familiar theme of princely duty. He was knighted in 1609. On the death of Henry in 1612, when he wrote an elegy on his young patron, he was appointed to the household of prince Charles. In 1613 he (in conjunction with Thomas Foulis and Paulo Pinto, a Portuguese) received from the king a grant of a silver-mine at Hilderston near Linlithgow, from which, however, neither the Crown nor the undertakers made any profit. In 1613 he began a correspondence with the poet Drummond of Hawthornden, which ripened into a lifelong intimacy after their meeting (March 1614) at Menstrie House, where Alexander was on one of his

short annual visits. In 1614 Alexander was appointed to the English office of master of requests, and in July of the following year to a seat on the Scottish privy council. In 1621 he received from James I. enormous grants of land in America embracing the districts of Nova Scotia, New Brunswick, and the Gaspé Peninsula, accompanied by a charter appointing him hereditary lieutenant of the new colony. This territory was afterwards increased on paper, so as to include a great part of Canada. Alexander proceeded to recruit emigrants for his "New Scotland," but the terms he offered were so meagre that he failed to attract any except the lowest class. These were despatched in two vessels chartered for the purpose, and in 1625 he published an *Encouragement to Colonies* in which he vainly painted in glowing colours the natural advantages of the new territory. The enterprise was further discredited by the institution of an order of baronets of Nova Scotia, who were to receive grants of land, each 6 sq. m. in extent, in the colony for a consideration of £150. An attempt made by the French to make good their footing in the colony was frustrated (1627) by Captain Kertch, and Alexander's son and namesake made two expeditions to Nova Scotia. But Alexander found the colony a constant drain on his resources, and was unable to obtain from the treasury, in spite of royal support, £6000 which he demanded as compensation for his losses. He received, however, a grant of 1000 acres in Armagh. He was the king's secretary for Scotland from 1626 till his death, and in 1630 was created Viscount Stirling and Lord Alexander of Tullibody. In the same year he was appointed master of requests for Scotland, and in 1631 an extraordinary judge of the Court of Session. Meanwhile French influence had gained ground in America. In 1631 Charles sent instructions to Alexander to abandon Port Royale, and in the following year, by a treaty signed at St Germain-en-Laye, the whole of the territory of Nova Scotia was ceded to the French. Alexander continued to receive substantial marks of the royal favour. In 1631 he obtained a patent granting him the privilege of printing a translation of the *Psalms*, of which James I. was declared to be the author. There is reason to believe that in this unfortunate collection, which the Scottish and English churches refused to encourage, Alexander included some of his own work. He had been commanded by James to submit translations, when James was carrying out his long entertained wish to supplant the popular version of Sternhold and Hopkins; but these the royal critic had not preferred to his own. It has been assumed from the scanty evidence that when Alexander was entrusted with the editing and publishing of the *Psalms* by Charles I. he had introduced some of his own work. In 1633 he was advanced to the rank of earl, with the additional title of Viscount Canada, and in 1639 he became earl of Doan. His affairs were still embarrassed and he had begun to build Argyll House at Stirling. In 1623 he received the right of a royalty on the copper coinage of Scotland, but this proved unproductive. He therefore secured for his fourth son the office of general of the Mint, and proceeded to issue small copper coins, known as "turners," which were put into circulation as equivalent to two farthings, although they were of the same weight as the old farthings. These coins were unpopular, and were reduced to their real value by the privy council in 1639. Alexander died in debt on the 12th of February 1640, at his London house in Covent Garden.

He was succeeded in the title by his grandson William, who died a few months later, and then by his son Henry (d. 1644), who became the 3rd earl. When Henry's grandson Henry, the 5th earl (1664-1739), died, the earldom became dormant, and in 1759 it was claimed by William Alexander (see below). In 1825 the earldom was claimed by Alexander Humphreys-Alexander, who asserted that his mother was a daughter of the first earl. The charter of 1639, however, on which his title rested, was declared in 1839 to be a forgery. See W. Turnbull, *Stirling Peerage Claim* (1839).

All Alexander's literary work was produced after 1603 and before his serious absorption in politics about 1614. The verse may be classed in three groups, (a) poetical miscellanies and minor verse,

(b) dramas, (c) the heroic fragment on *Jonathan* and the long poem on *Doomesday*.

a. His earliest effort was *Aurora*, containing the first fancies of the author's youth (London, 1604), a miscellany of sonnets, songs and elegies, showing considerable formal felicity, if little originality, in the favourite themes of the Elizabethan sonneteers. To this may be added the *Paraenesis to Prince Henry* (u.s.), *An Elegie on the Death of Prince Henrie* (u.s.), and shorter pieces, including a sonnet to Michael Drayton, who had called Alexander "a man of men," and lines on the *Report of the Death of Drummond of Hawthornden*.

b. He wrote four tragedies, *Darius* (1603), *Croesus* (1604), *The Alexandraean* (1605), and *Julius Caesar* (1607). The first and second were published together in 1604 as the *Monarchie Tragedies*, a title which was afterwards given by Alexander to a print of the four works in the editions of 1607 and 1616. They are didactic poems rather than plays, a sequence of reflections of the type of the *Falls of Princes*, the *Mirror for Magistrates*, or Lyndsay's *Dialog between Experience and a Courteour* (known also as the "Monarchie"). It is very probable that the last suggested both motif and title. The pieces are dialogues rather than dramas: the choruses are of the "Moralitas" type of Renaissance verse rather than classical; and the varied versification is unsuitable for representation. Yet they contain not a few fine passages in the soliloquies, notably one in *Darius*, (IV., iii.) on the vanishing of "Those golden palaces, those gorgeous halls" as "vapours in the air," which recall Shakespeare's later lines in the *Tempest*.

c. Of *Jonathan*, an *Heroicke Poeme intended*, only the first book (105 eight-lined stanzas) was written. *Doomesday*, or *The Great Day of the Lord's Judgement* (1614) is a dreary production in twelve books or "hours," extending to nearly 12,000 lines. It is written in eight-lined stanzas.

In addition to the pamphlet on Colonization, he wrote (1614) a continuation or "completion" to the third part of Sidney's *Arcadia*, which appears in the fourth and later editions of the Romance; and a short critical tract entitled *Anacrisis*, a "censure" of poets, ancient or modern.

A collected edition of his works appeared in his lifetime (1637) with the title *Recreations with the Muses* (folio). *Aurora* and the *Elegie* were not included. A complete modern reprint *The Poetical Works . . . now first collected and edited* (but without the editor's name on the title-page) was published in 3 vols. 8vo. in 1870 (Glasgow: Maurice Ogle & Co.).

His *Encouragement to Colonies* was edited for the Bannatyne Club by David Laing (1867), and by Edmund F. Slafter, in *Sir W. Alexander and Amer. Colonization* (Prince Society, Boston, Massachusetts, 1865). See also E. F. Slafter, *The Copper Coinage of the Earl of Stirling, 1632* (1874); *The Earl of Stirling's Register of Royal Letters relative to the Affairs of Scotland and Nova Scotia from 1615-1635* (ed. C. Rogers, with biographical introduction (1884-1885); C. Rogers, *Memorials of the Earl of Stirling* (1877); the introduction to the *Works* (1870) referred to above; the *Register of the Privy Council of Scotland, passim*; and the bibliography for William Drummond (q.v.) of Hawthornden. (A. B. G.; G. G. S.)

STIRLING, WILLIAM ALEXANDER, (titular) EARL OF (1726-1783), American soldier, was born in New York City. He was the son of James Alexander (1690-1756), at one time surveyor-general of New York and New Jersey, a noted colonial lawyer who was disbarred for a year for his conduct of the defence in the famous trial of John Peter Zenger. William served first as commissary and then as aide-de-camp to Governor William Shirley at the beginning of the French and Indian War, and in 1756 he accompanied Shirley to England, where he was persuaded to claim the earldom of Stirling (see above). In 1759 an Edinburgh jury declared him to be the nearest heir to the last earl of Stirling, and in 1761 he returned to America and assumed the title, although the House of Lords in 1762 forbade him to use it until he had proved his legal right. Soon after his return to America he settled at Basking Ridge, New Jersey, and became a member of the New Jersey Provincial Council and surveyor-general of the colony. Warmly espousing the colonial cause at the outbreak of the War of Independence, he was appointed in November 1775 colonel of the first regiment of continental troops raised in New Jersey, and in the following January distinguished himself by the capture of an armed British transport in New York Bay. In March he became brigadier-general, and for some time was in command at New York and supervised the fortification of the city and harbour. At the battle of Long Island he was taken prisoner, but was soon afterward exchanged, and in February 1777 became a major-general. He participated in the battles of Trenton, Princeton, Brandywine and Germantown, and especially

distinguished himself at Monmouth. He took an active part in exposing the Conway Cabal, presided over the court-martial of General Charles Lee, and enjoyed the confidence of Washington to an unusual degree. In October 1781 he took command of the northern department at Albany to check an expected invasion from Canada. He died at Albany on the 15th of January 1783. He was a member of the board of governors of King's College (now Columbia University) and was himself devoted to the study of mathematics and astronomy.

See W. A. Duer, "Life of William Alexander, Earl of Stirling," in vol. ii. of the *Collections of the New Jersey Historical Society* (New York, 1847).

STIRLING, a royal, municipal and police burgh, river port and county town of Stirlingshire, Scotland. Pop. (1901), 18,697. It is finely situated on the right bank of the Forth, 39½ m. N.W. of Edinburgh and 29½ m. N.E. of Glasgow, being served by the North British and the Caledonian railways. The old town occupies the slopes of a basaltic hill (420 ft. above the sea) terminating on the north and west in a sheer precipice. The modern quarters have been laid out on the level ground at the base, especially towards the south. Originally the town was protected on its vulnerable sides by a wall, of which remains still exist at the south end of the Black Walk. Formerly there were two main entrances—the South Port, 100 yds. to the west of the present line of Port Street, and the "auld brig" over the Forth to the north, a quaint high-pitched structure of four arches, now closed to traffic. It dates from the end of the 14th century and was once literally "the key to the Highlands." It still retains the gateway towers at both ends. Just below it is the new bridge erected in 1829 from designs by Robert Stevenson, and below this again the railway viaduct. According to local tradition, a bridge stood at Kildean, 1 m. up the river, not far from the field of the battle of Stirling Bridge (1297). The castle crowning the eminence is of unknown age; but from the time that Alexander I. died within its walls in 1124 till the union of the crowns in 1603 it was intimately associated with the fortunes of the Scottish monarchs. It is one of the fortresses appointed by the Act of Union to be kept in a state of repair, and is approached from the esplanade, on which stands the colossal statue of Robert Bruce, erected in 1877. The main gateway, built by James III., gives access to the lower and then to the upper square, on the south side of which stands the palace, begun by James V. (1540) and completed by Mary of Guise. The east side of the quadrangle is occupied by the parliament house, a Gothic building of the time of James III., now used as a barrack-room and stores. On the north side of the square is the chapel royal, founded by Alexander I., rebuilt in the 15th century and again in 1594 by James VI. (who was christened in it), and afterwards converted into an armoury and finally a store-room. Beyond the upper square is the small castle garden, partly destroyed by fire in 1856 but restored, in which William, 8th earl of Douglas, was murdered by James II. (1452). Just below the castle on the north-east is the path of Ballangeich, which is said to have given private access to the fortress, and from which James V. took his title of "Guidman of Ballangeich" when he roved incognito. Below it is Gowan Hill, and beyond this the Mote or Heading Hill, on which Murdoch Stuart, 2nd duke of Albany, his two sons, and his father-in-law the earl of Lennox, were beheaded in 1425. In the plain to the south-west were the King's Gardens, now under grass, with an octagonal turf-covered mound called the King's Knot in the centre. Farther south lies the King's Park, chiefly devoted to golf, cricket, football and curling, and containing also a race-course. On a hill of lower elevation than the castle and separated from the esplanade by a depression styled the Valley—the tilting-ground of former times—a cemetery has been laid out. Among its chief features are the Virgin Martyrs' Memorial, representing in white marble a guardian angel and the figures of Margaret M'Lauchlan and Margaret Wilson, who were drowned by the rising tide in Wigtown Bay for their fidelity to the Covenant (1685); the large pyramid to the memory of the Covenanters, and the Ladies' Rock, from which

ladies viewed the jousts in the Valley. Adjoining the cemetery on the south is Greyfriars, the parish church, also called, since the Reformation (1656), when it was divided into two places of worship, the East and West churches. David I. is believed to have founded (about 1130) an earlier church on their site dedicated to the Holy Rood, or Cross, which was burned in 1406. The church was rebuilt soon afterwards and possibly some portions of the preceding structure were incorporated in the nave. The choir (the East church) was added in 1494 by James IV., and the apse a few years later by James Beaton, archbishop of St Andrews, or his nephew, Cardinal David Beaton. At the west stands the stately battlemented square tower, 90 ft. high. The nave (the West church), divided from the aisles by a double row of massive round pillars, is a transition between Romanesque and Gothic, with pointed windows. The crow-stepped Gothic gable of the south transept affords the main entrance to both churches. The choir is in the Decorated and Perpendicular styles and is higher than the nave. The parish church is 200 ft. long, 55 ft. broad and 50 ft. high. Within its walls Mary Queen of Scots was crowned in 1543, when nine months old, and in the same year the earl of Arran, regent of Scotland, abjured Protestantism; in 1544 an assembly of nobles appointed Mary of Guise queen-regent; on the 29th of July 1567 James VI. was crowned, John Knox preaching the sermon, and in August 1571 and June 1578 the general assembly of the Church of Scotland met. James Guthrie (1612-1661), the martyr, and Ebenezer Erskine (1680-1794), founder of the Scottish Secession Church, were two of the most distinguished ministers. To the south-west of the church is Cowane's Hospital, founded in 1639 by John Cowane, dean of gild, for twelve poor members of the gildry; but the deposition of the charity has been modified and the hall serves the purpose of a gildhall. Adjoining it is the military prison. Near the principal entrance to the esplanade stands Argyll's Lodging, erected about 1630 by the 1st earl of Stirling. On his death in 1640 it passed to the 1st marquess of Argyll and is now a military hospital. Broad Street contains the ruins of Mar's Work, the palace built by John Erskine, 1st (or 6th) earl of Mar, about 1570, according to tradition, out of the stones of Cambuskenneth Abbey; the old town house, erected in 1701 instead of that in which John Hamilton, the last Roman Catholic archbishop of St Andrews, was hanged for alleged complicity in the murders of Darnley and the regent Moray; the town cross, restored in 1891, and the house which was, as a mural tablet says, the "nursery of James VI. and his son Prince Henry." The important buildings include: the high school; the trades hall, founded by Robert Spittal, James IV.'s tailor, in the Back Walk; the burgh buildings, with a statue of Sir William Wallace over the porch; the National Bank, occupying the site of the Dominican monastery, founded in 1223 by Alexander II. and demolished at the Reformation; the Smith Institute, founded in 1873 by Thomas Stewart Smith, an artist, containing a picture-gallery, museum and reading-room; the public halls; the Royal Infirmary and various charitable institutions. Woollen manufactures (carpets, tartans, shawls) are the staple industry, and tanning, iron-founding, carriage-building and agricultural implement-making are also carried on, in addition to furniture factories, cooperage and rubber works. The harbour being accessible only at high water, and then merely to vessels of small tonnage, the shipping trade is inconsiderable.

Stirling is under the jurisdiction of a council with provost and bailies, and, along with Culross, Dunfermline, Inverkeithing and Queensferry (the Stirling burghs) returns a member, to Parliament. The Abbey Craig, an outlying spur of the Ochils, 1½ m. north-east of Stirling, is a thickly-wooded hill (362 ft. high), on the top of which stands the Wallace monument (1869), a baronial tower, 220 ft. high, surmounted with an open-work crown. The Valhalla, or Hall of Heroes, contains busts of eminent Scotsmen. Cambuskenneth Abbey is situated on the left bank of the Forth, about 1 m. east-north-east of Stirling by ferry across the river. The name is derived from the Gaelic and means "the Crook of Kenneth," or Cairenachus, a friend

of St Columba and patron of Kilkenny in Ireland. The abbey, which was in the Early Pointed style, was founded by David I. in 1147 for monks of the order of St Augustine. Several Scots parliaments met within its walls, notably that of 1326, the first attended by burgesses from the towns. At the Reformation Mary Queen of Scots bestowed it on the 1st earl of Mar (1562), who is said to have used the stones for his palace in Stirling. In 1709 the town council of Stirling purchased the land and ruins. All that remains of the abbey is the massive, four-storeyed tower—which is 70 ft. high, and 35 ft. square, and was painted and repaired in 1864—the graceful west doorway and the foundations of some of the walls. The bones of James III. and his queen, Margaret of Denmark, who were buried within the precincts, were discovered in 1864 and re-interred next year under a tomb erected by Queen Victoria at the high altar.

Earlier forms of the name of Stirling are Strivilen, Estriuelen, Striviling and Sterling, besides the Gaelic Struithla. It was known also as Snowdown, which became the official title of the Scots heralds. The Romans had a station here (*Benobara*). In 1119 it was a royal burgh and under Alexander I. was one of the Court of Four Burghs (superseded under James III. by the Convention of Royal Burghs). In 1174 it was handed over to the English in security for the treaty of Falaise, being restored to the Scots by Richard I. The earliest known charter was that granted in 1226 by Alexander II., who made the castle a royal residence. The fortress was repeatedly besieged during the wars of the Scottish Independence. In 1304 it fell with the town to Edward I. The English held it for ten years, and it was in order to raise the Scottish siege in 1314 that Edward II. risked the battle at Bannockburn. Edward Baliol surrendered it in 1334 in terms of his compact with Edward III., but the Scots regained it in 1339. From this time till the collapse of Queen Mary's fortunes in 1568, Stirling almost shared with Edinburgh the rank and privileges of capital of the kingdom. It was the birthplace of James II. in 1430 and probably of James III. and James IV. In 1571 an attempt was made to surprise the castle by Mary's adherents, the regent Lennox being slain in the fray, and seven years later it was captured by James Douglas, 4th earl of Morton, after which a reconciliation took place between the Protestants and Roman Catholics. It was occupied in 1584 by the earls of Angus and Mar, the Protestant leaders, who, however, fled to England on the approach of the king. Next year they returned with a strong force and compelled James VI. to open the gates, his personal safety having been guaranteed. In 1594 Prince Henry was baptized in the chapel royal, which had been rebuilt on a larger scale. After the union of the crowns (1603) Stirling ceased to play a prominent part on the national stage. The privy council and court of session met in the town in 1637 on account of the disturbed state of Edinburgh. In 1641 Charles I. gave it its last governing charter, and four years afterwards parliament was held in Stirling on account of the plague in the capital, but the outbreak of the pest in Stirling caused the legislators to remove to Perth. During the Civil War the Covenanters held the town, to which the committees of church and state adjourned after Cromwell's victory at Dunbar (1650), but in August next year the castle was taken by General Monk. In 1715 the 3rd duke of Argyll held it to prevent the passage of the Forth by the Jacobites, and in 1746 it was ineffectually besieged by Prince Charles Edward. In 1773, in consequence of an intrigue on the part of three members of the council to retain themselves in office, the town was deprived of its corporate privileges, which were not restored until 1781.

See *History of the Chapel Royal, Stirling* (Grampian Club, 1882); *Charters of Stirling* (1884); John Jamieson, *Bell the Cat* (Stirling, 1902); *The Battle of Stirling Bridge—the Kildean Myth* (Stirling Natural History and Archaeological Society, 1905).

STIRLING-MAXWELL, SIR WILLIAM, BART. (1818–1878), Scottish man of letters and virtuoso, the only son of Archibald Stirling of Keir, Perthshire, and of Elizabeth, third daughter of Sir John Maxwell, seventh baronet of Pollok, Renfrewshire, was born at Kenmure, near Glasgow, on the 8th of March,

1818. William Stirling was educated privately and at Trinity College, Cambridge, where he graduated in 1839. On leaving Cambridge he spent some years abroad, chiefly in Spain and Syria. Having succeeded his father as proprietor of Keir in 1847, when he was made vice-lieutenant of Perthshire, he in 1852 entered parliament as member for that county; and he was several times re-elected. On the death of his uncle in 1865 he succeeded to the baronetcy and estates of Pollok, assuming the additional name of Maxwell. In the same year he became deputy-lieutenant of Lanarkshire, and a like office was conferred on him in Renfrewshire in 1870. He married in 1865 Anna Maria, daughter of the 10th earl of Leven and Melville. She died in 1874, and in 1876 Sir William married Caroline Norton. In 1862 he was chosen lord rector of St Andrews, in 1872 the same honour was conferred by Edinburgh, and in 1876 he became chancellor of Glasgow. He was a trustee of the British Museum, of the National Gallery, and member of the senate of London University. In 1876 he was created a Knight of the Thistle, being the only commoner of the order. He died at Venice on the 15th of January 1878.

Sir W. Stirling-Maxwell's works, which are invariably characterized by thorough workmanship and excellent taste, were in some cases issued for private circulation only, and almost all of them are now exceedingly rare. They include an early volume of verse (*Songs of the Holy Land*, 1848), and several volumes containing costly reproductions of old engravings, along with valuable explanatory matter. His best-known publications are *Annals of the Artists of Spain* (1848), *The Cloister Life of Charles V.* (1852). Part of the *Annals* was revised and published as *Velasquez and his Works* (1855). *The Cloister Life* was at once recognized as a valuable contribution to history, but its importance was lessened by the appearance a year or two later of Mignet's *Charles-Quint* and L. P. Gachard's *Retraite et mort de Charles-Quint. A life of Don John of Austria*, from his posthumous papers, edited by Sir G. W. Cox, appeared in 1883. A collected edition of his works, with a short memoir, appeared in 1891.

STIRLINGSHIRE, a midland county of Scotland, bounded N. by Perthshire, N.E. by Clackmannanshire and the Firth of Forth, S.E. by Linlithgowshire, S. by Lanarkshire and the detached part of Dumbartonshire and S.W. and W. by Dumbartonshire; area 288,842 acres, or 451.3 sq. m. In the north-west a spur of the Grampians culminates in Ben Lomond (3192 ft.), and the centre is occupied by a group known as the Lennox Hills, consisting of Gargunnoch Hills (1591), Fintry Hills (1676), Kilsyth Hills (1870), and Campsie Fells (1894). The chief river is the Forth, the windings of which constitute most of the northern boundary. The other important streams are the Carron, which rises in Campsie Fells and flows mainly east for 25 m. to the Forth of Grangemouth; the Endrick, which, rising in Fintry Hills, first flows east, then south and finally bends round to the west, a direction which it maintains for most of its course of 31 m. till it empties itself into Loch Lomond; the Kelvin, which, from its source in Kilsyth Hills, flows south-west to the Clyde at Glasgow after a run of 22 m., and the Avon, rising in the detached portion of Dumbartonshire, and flowing for 21 m. east and then north to the Forth. The principal lochs include the greater part of the eastern waters of Loch Lomond, from Endrick mouth to a point 2 m. north of Inversnaid; a small portion of the upper end of Loch Katrine, from a point in the centre of the lake opposite to Stronachlachar to Glengyle at the head; Loch Arklet, in the north-west area, 1 m. long by $\frac{1}{2}$ m. wide, forming part of the water supply of Glasgow; the small Loch Coulter, in the parish of St Ninians, and Black Loch, partly in Lanarkshire. The Forth and Clyde Canal crosses the south-eastern corner of the county from Grangemouth to Castlecary.

Geology.—The oldest rocks in the county are the Dalradian schists which occupy the north-west beyond a great fault which runs across from near the bottom end of Loch Lomond in a north-easterly direction passing not far from Aberfoyle. These schists are less altered and micaceous near the fault and there is some evidence for believing them to be of Ordovician age. On the south-eastern side of the fault are the conglomerates and sandstones of Lower Old Red Sandstone age, which are more highly inclined and coarser nearer the fault. Resting uniformly on the lower series is

the Upper Old Red series of sandstones; but the junction between the two is faulted between Balfron and Kippen; the fault runs E.N.E.—W.S.W. Then follows the Carboniferous system which occupies the rest of the county. The lowest member, the Calciferous Sandstone group, consisting of clays and marls with cement nodules, may be seen on both sides of the Campsie Fells; it is well exposed near Strathblane in Ballagan Burn. These beds are succeeded by alternating beds of contemporaneous tuffs and sandstones and then by great sheets of diabase-porphyrity which attain a considerable thickness and form well-marked ridges on the southern side of the Campsie Hills; they are best developed north of Kilsyth and east of Fintry. Meikle Bin and Dungleil mark the sites of the vents from which some of these volcanic rocks were erupted. The Carboniferous Limestone series is the next in order and the lower beds may be found resting upon the volcanic rocks except where the junction is faulted and this series is let down, as it is between Strathblane and the Carron Water. As in the neighbouring counties, this series consists of a lower limestone group—with the Index, Calmy and Castle Cary limestones—a middle group with coals and clay ironstones and an upper limestone group with the Hosie and Hurler limestones; below the latter is a bed of alum shale. These rocks are considerably folded about Kilsyth and in the directions of Banton and Cairnbeg; the "Riggin" near Kilsyth is a noteworthy example of an anticlinal fold. The next series is the Millstone Grit—sandstones with some coal-seams and fireclays—which occurs towards the eastern boundary. The true Coal-measures are well developed between Grangemouth and Stenhousemuir and about Falkirk. The more important seams are the Virtuewell (the highest), the Splint, Crow and Coxhead coals. Intrusive sheets of basalt have penetrated the Carboniferous rocks and are now quarried for road metal; Abbey Craig and Stirling Castle hill are formed of one of the more important of these intrusions. Later basalt dikes of Tertiary age are not uncommon. A good deal of boulder clay covers the older rocks and an interesting blue marine clay is found beneath it in the Endrick valley. The Carse of Stirling is overlaid by the muds and sands of the 50 ft. raised beach; and traces of the 100 ft. beach are also to be found.

Climate and Agriculture.—The rainfall for the year varies from 35 in. in the far east to 55 in. in the Highland region in the extreme north-west. The mean annual temperature is 47.5° F.; for January 38° F., for July 59° F. The arable soils are of two kinds, locally distinguished as "carse" and "dryfield," the rest of the land being composed of pasture, moor and peat. The "carse" extends along the valley from Buchlyvie to the eastern boundary, a distance of 32 m. (by the river), with a breadth of 1 to 4 m. The soil consists of the finest clays, without stones, but interspersed with strata of marine shells. It has been largely stripped of the overlying peat, and by draining, subsoil ploughing and the use of lime has been converted into a rich soil, especially adapted for wheat and beans. The "dryfield," mostly reclaimed since the beginning of the 18th century, occupies the valleys and the higher ground bordering the carse. It is fertile and well suited for potatoes and turnips. In the order of their importance the grain crops are oats, barley and wheat. Beans are also extensively grown. Livestock is raised in increasing numbers. The sheep are chiefly black-faced, the cattle Irish, short-horns and cross-breeds. Ayrshires are the principal breed on the "dryfield" farms, where butter-making is largely carried on. Horses are kept only for farming operations or for stock, and a considerable number of pigs are reared. The average size of the holdings is from 70 to 80 acres. The area under wood is small. Birches grow naturally on the lower slopes of the mountains in Buchanan and Drymen, and oaks freely on the banks of Loch Lomond. Larch and Scots fir are the leading trees in modern plantations.

Other Industries.—The coalfield of the south-east supplies the staple industry. Iron ore, fireclay and oil-shale are also obtained, while limestone is extensively wrought in the Campsie district, and sandstone is quarried in many parts. The ironworks at Carron and Falkirk are important. Woollens are manufactured at Stirling and Bannockburn; calico-printing and bleaching are established in the south-west, especially at Lennoxton, Strathblane and Milton. There are chemical works at Falkirk, Stirling, Denny and Lennoxton. Throughout the county there are several breweries and distilleries, and at Grangemouth, the principal port, shipbuilding is carried on. The southern and south-eastern districts are served by the North British railway from Edinburgh to Glasgow (via Falkirk) and the Caledonian railway from Glasgow to Stirling (via Larbert), while branches connect Grangemouth, Denny and other places with the through-lines. The Forth & Clyde railway crosses the shire, mostly in the north, from Stirling to Balloch, and the North British also runs from Glasgow to Aberfoyle. In the tourist season there is a steamer service from Leith to Stirling (37 m.).

Population and Administration.—In 1891 the population numbered 118,021, and in 1901 it was 142,291, or 315 persons to the square mile, an increase for the decade exceeded only by the shires of Linlithgow and Lanark. In 1901 there were ten persons who spoke Gaelic only and 2014 Gaelic and English.

The principal towns are Falkirk (pop. 29,380), Stirling (18,697), Grangemouth (8386), Kilsyth (7292), Stenhousemuir (5184), Denny and Dunipace (5158), Bridge of Allan (3240), and Bonnybridge (3009). The shire returns a member to parliament, and Stirling and Falkirk respectively belong to the Stirling and Falkirk district groups of parliamentary burghs. The police burghs include Falkirk, Grangemouth, Kilsyth, Denny and Dunipace and Bridge of Allan. The shire forms a sheriffdom with the counties of Dumbarton and Clackmannan, but there is a resident sheriff-substitute at Stirling and another at Falkirk. The shire is under schoolboard jurisdiction, and there are secondary as well as science and art schools at Stirling and Falkirk. The town councils of Stirling and Kilsyth subsidize classes in science and art, besides manual instruction, and Denny and Dunipace maintains a mining instruction class.

History and Antiquities.—The wall of Antonius, built by Lollius Urbicus, in A.D. 142, connecting the Forth and Clyde, passed through the south-east of the county, in which it is locally known as Graham's Dyke. At Castlecary and Camelon, which were both stations of consequence on the line of the wall, many interesting relics have been found. The Camelon causeway, a Roman road, ran eastwards from Castlecary, crossed the rampart at Camelon, whence it proceeded northwards to Stirling and the Forth, where there was a station near the present bridge of Drip. Thence it crossed the river to Keir and Dunblane in Perthshire. To the north-east of the Carron foundry there stood, till its demolition in 1743, a fine circular Roman building called Arthur's Oon (oven), or Julius's Hof, but the two mounds in Dunipace parish supposed to have been raised as monuments of peace between the Romans and Caledonians are probably of natural origin. After the withdrawal of the Romans the county once more fell into the hands of the Picts, the original inhabitants, who, however, gradually retired before the advance of the Saxons and Scots. By the time of Malcolm Canmore (d. 1093) the lowland area had become settled, but the highland tract remained a disturbed and disturbing region until the pacification following the Jacobite rising of 1745-46. The county played a conspicuous part in the struggle for Scottish independence, being particularly associated with many of the exploits of Sir William Wallace and Robert Bruce. The three great battles of the independence were fought in the shire—Stirling Bridge (1297), Falkirk (1298), Bannockburn (1314). James III. was stabbed to death in a cottage in the village of Milton after the battle of Sauchieburn (1488), but apart from the disastrous defeat of the Covenanters at Kilsyth (1645) and the transitory triumph which Prince Charles Edward won at Falkirk (1746), the history of the shire practically centres in that of the county town.

BIBLIOGRAPHY.—Sir Robert Sibbald, *Description of Stirlingshire* (1710); Nimmo, *History of Stirlingshire* (1777, 1880); *Registrum Monasterii S. Marie de Cambuskenneth* (Edinburgh, 1872); W. Rowand Anderson, *Stirling Castle* (1893); J. S. Fleming, *Old Lodgings of Stirling* (Stirling, 1897), *Old Nook of Stirling* (Stirling, 1898); J. W. Small, *Old Stirling* (1897).

STIRRUP (O. Eng. *stirap*, *stigrap*, M. Eng. *stirop*, *styrope*, &c., *i.e.* a mounting or climbing-rope; O. Eng. *stigan*, to mount, climb, and *rap*, rope, cf. Du. *stijbeugel*, literally mounting bow or loop, Ger. *Steigbügel*), a loop usually of metal, suspended by an adjustable strap from the saddle and used as a support for the foot of a rider of a horse when seated in the saddle and as an aid in mounting. The earliest use of stirrups seems to have been in the East, for they are mentioned in early Chinese literature and examples which must be earlier than the 7th century A.D. have been found in Japan. The Greeks and Romans did not use them but mounted by vaulting or from a mounting block (see SADDLERY AND HARNESS). The earliest evidence of their use in Europe is in the *Art of War* of the emperor Maurice (A.D. 582-602). They were probably brought into use by the nomad horsemen of Asia. The stirrup of the early middle ages seems to have been light and semicircular or triangular in shape. By the 14th century the footplate became broader and the sides heavier and ornamented. By the 16th century this ornamentation increases

and open metal-work is used. The Arab stirrup is very large, affording a rest for the entire sole of the foot; sometimes the heel part projects and terminates in a sharp point used as a spur.

See the plates in F. Hotteuroth, *Trachten, Haus- Feld- und Kriegsgeräthschaften*, &c. (1901); and R. Zschille, *Die Steigbügel in ihrer Formen-Entwicklung* (1896).

STJERNHJELM, GEORG (1598–1672), Swedish poet and scholar, whose original name was Göran Lilja, was born at Wika in Dalecarlia on the 7th of August 1598. He took his degree at Greifswald, and spent some years in travelling over every quarter of Europe. On his return in 1626 he maintained a correspondence with Salmasius, Heinsius, and other scholars. He taught at Vesterås, and then at Stockholm, attracting the notice of Gustavus Adolphus, who gave him a responsible post at Dorpat in 1630, and raised him next year to the nobility. After the king's death, Christina attached him, as a kind of poet laureate, to her court in Stockholm. His property lay in Livonia, and when the Russians plundered that province in 1656 the poet, who was in temporary disgrace at court, was reduced to extreme poverty for two or three years. He subsequently became judge at Trondhjem, member of the council of war (1661), and president (1667) of the College of Antiquities at Stockholm. He died at Stockholm on the 22nd of April 1672. His greatest poem *Hercules*, is a didactic allegory in hexameters, written in very musical verse, and with almost Oriental splendour of phrase and imagery. The *Hercules*, which deals with the familiar story of the dispute for the hero between Duty and Pleasure, was first printed at Upsala in 1653 but was finished some years earlier. *Bröllops-Besvär's Ihugkommelse*, a sort of serio-comic epithalamium in the same measure, is another very brilliant work. His masques, *Then fångne Cupido* (Cupid Caught) (1649), *Freds-afl* (The Birth of Peace) (1649), and *Parnassus triumphans* (1651), were written for the entertainment of Queen Christina. He can scarcely be said to have been successful in his attempt, in the first two of these, to introduce unrhymed song-measures.

Stjernhjelm was an active philologist, and left a great number of works on language, of which only a few have been printed. He also wrote on history, mathematics, philosophy and natural science, producing original and valuable work on every subject he attempted. Among his numerous works are Letter A of the *Lexicon vocabulorum antiquorum gothicorum* (1643, &c.), *Archimedes reformatum* (1644), *Runa suetica* (Lübeck, 1700), and an edition of *Wäst Götha Lagbok* (1663). His works were partially edited by P. Hanselli (*Samlade vitterhets arbeten af Svenska Författare*, vol. i., 1871), by L. Hammar-sköld (Stockholm, 1818), by F. Tamm (Upsala, 1891). See also C. J. Lénström, *Litterärt Porträttgalleri* (Upsala, 1838); there is a full list of his writings in the *Svenskt biographiskt Lexikon*, vol. xv. (Upsala, 1848).

STOA, the term in Greek architecture (Lat. *porticus*) given to a building, the roof of which is supported by one or more rows of columns, the stoa at Elis described by Pausanias being important examples.

STOBAEUS, JOANNES, so called from his native place Stobi in Macedonia, the compiler of a valuable series of extracts from Greek authors. Of his life nothing is known, but he probably belongs to the latter half of the 5th century A.D. From his silence in regard to Christian authors, it is inferred that he was not a Christian.

The extracts were intended by Stobaeus for his son Septimius, and were preceded by a letter briefly explaining the purpose of the work and giving a summary of the contents. From this summary (preserved in Photius's *Bibliotheca*) we learn that Stobaeus divided his work into four books and two volumes. In most of our MSS. the work is divided into three books, of which the first and second are generally called 'Εκλογαί φυσικαί καὶ ἠθικαί (Physical and Moral Extracts), and the third 'Αρθολόγιον (*Florilegium* or *Sermones*). As each of the four books is sometimes called 'Αρθολόγιον, it is probable that this name originally belonged to the entire work; the full title, as we know from Photius, was 'Εκλογῶν ἀποφθεγμάτων ὑποθηκῶν βιβλία τέτταρα (*Four Books of Extracts, Sayings and Precepts*). The modern arrangement is somewhat arbitrary and there are several marked discrepancies between it and the account given

by Photius. The introduction to the whole work, treating of the value of philosophy and of philosophical sects, is lost, with the exception of the concluding portion; the second book is little more than a fragment, and the third and fourth have been amalgamated by altering the original sections. From these and other indications it seems probable that what we have is only an epitome of the original work, made by an anonymous Byzantine writer of much later date. The didactic aim of Stobaeus's work is apparent throughout. The first book teaches physics—in the wide sense which the Greeks assigned to this term—by means of extracts. It is often untrustworthy: Stobaeus betrays a tendency to confound the dogmas of the early Ionic philosophers, and he occasionally mixes up Platonism with Pythagoreanism. For part of this book and much of book ii. he depended on the works of Aëtius, a peripatetic philosopher, and Didymus. The third and fourth books, like the larger part of the second, treat of ethics; the third, of virtues and vices, in pairs; the fourth, of more general ethical and political subjects, frequently citing extracts to illustrate the pros and cons of a question in two successive chapters. In all, Stobaeus quotes more than five hundred writers, generally beginning with the poets, and then proceeding to the historians, orators, philosophers and physicians. It is to him that we owe many of our most important fragments of the dramatists, particularly of Euripides.

Editio princeps (1609); *Eclogae*, ed. T. Gaisford (1822), A. Meineke, (1860–1864); *Florilegium*, ed. T. Gaisford (1850); A. Meineke (1855–1857), C. Wachsmuth and O. Hense (1884–1894, and 1909).

STOCKBRIDGE, a township of Berkshire county, in western Massachusetts, U.S.A. Pop. (1900), 2081; (1910, U.S. census) 1933. It comprises an area of 24 sq. m. Lake Mahkeenac, or Stockbridge Bowl, is about 2 m. north of Stockbridge village. Immediately south of the village, in a cleft in the north-western part of Bear Mountain, is Ice Glen, with caverns ice-lined even in midsummer. In the southern part of the township, on the boundary of Great Barrington, is Monument Mountain (1710 ft.). Stockbridge village is on the Housatonic river, about 13 m. south by east of Pittsfield, and is served by the New York, New Haven & Hartford railway, and by an interurban electric line. It is well known as a summer resort, with a casino and golf links, a war monument, a bell tower erected by David Dudley Field to commemorate the Indian mission, a monument in the old burial ground of the Stockbridge Indians, a public library, and the Stockbridge Academy. Jonathan Edwards (commemorated by a monument, 1871) was the pastor (1750–1758), and wrote his *Freedom of the Will* here; the Sedgwick mansion, the home of Theodore Sedgwick (1746–1813), is at Stockbridge; his daughter, the author, Catherine M. Sedgwick, was born (and buried) here; and Stockbridge was the birthplace of Mark Hopkins and of Cyrus W. Field, who presented a park to the village. The "village improvement society" movement seems to have originated at Stockbridge in 1853. The Stockbridge (or Muh-he-kan-ne-ok) Indians, survivors of the Mohican tribe, removed to the Housatonic Valley from the west bank of the Hudson river soon after the first white settlements were made in New York; and in 1734 a mission was established among them in what is now the township of Great Barrington by John Sergeant (1710–1749), who translated part of the Bible into their language. In 1736 a town 6 m. square (including the present Stockbridge) was laid out for them. Lands were held in severalty, the Indians were guaranteed the civil rights of whites; they had a church (under the charge of Jonathan Edwards in 1750–1758), and a school. In 1739 their township was incorporated under the name of Stockbridge, possibly adopted because of a resemblance to the country about Stockbridge, England. Many of the Indians fought on the American side in the War of Independence. In 1783–1788 nearly all of them removed to the Brother-ton settlement (established 1775), 14 m. south of what is now Utica, New York; there they built New Stockbridge. By 1829 nearly all had left New York for Wisconsin, settling near what is now South Kaukauna. By 1859 they had removed to

the reservation in Shawano county, Wisconsin, where they now live.

See E. F. Jones, *Stockbridge Past and Present* (Springfield, 1854); and J. N. Davidson, *Muhhekanook: a History of the Stockbridge Indians* (Milwaukee, 1863).

STOCK EXCHANGE, a market for the purchase and sale of all descriptions of negotiable securities (see MARKET). In the immense majority of cases the securities so dealt in are what are known as "stocks, bonds and shares," on which interest, or dividend, is payable when earned; but bills issued by governments and municipal corporations are also occasionally dealt in. Many years ago, when the British government was in the habit of issuing exchequer bills, a now obsolete form of security, these bills were quoted in the official list of the London Stock Exchange; this was possible because though nominally bills, they were really bonds with a variable rate of interest fixed half-yearly in advance by the treasury. The inconvenience of this arrangement led to their being abandoned as a portion of the system of British government finance. Markets for dealing in securities have existed for some hundreds of years. Their organization was loose, there was no specific body of persons forming the market, and there were no special rules governing their procedure until within the last hundred and fifty years.

London.—Previous to 1773 the London stockbrokers conducted their business in and about the Royal Exchange, but in that year, having formed themselves into an association under the designation of the Stock Exchange, they, after temporarily locating their headquarters in Sweeting Alley, Threadneedle Street, removed to Capel Court, Bartholomew Lane. The growth of business necessitating improved accommodation, a capital of £20,000 in four hundred shares of £50 each was raised in 1801 for the purpose of erecting a new building in Capel Court, which was finished and occupied in the following year, the members at that date numbering about five hundred. With the occupation of the new building new rules came into force; all future members were admitted by ballot, while both members and their authorized clerks were required to pay a subscription of ten guineas each. As only the wealthier members of the association had provided the capital for the new building, the Stock Exchange henceforth consisted of two distinct bodies—proprietors and subscribers. In 1854 the membership having increased to about one thousand persons, an extension of the premises in Capel Court was effected at a cost of £16,000. A very extensive increase in the accommodation was made in 1885, when what was for many years afterwards known as the "new house" was erected. It occupies by far the greater portion of the triangular area of which Throgmorton Street, Bartholomew Lane, part of Threadneedle Street and part of Old Broad Street form the sides. Sections of the external parts of this area are in the hands of banks, insurance companies and other places of business, but most of the south side of Throgmorton Street and most of the north side of that portion of Old Broad Street which lies between Throgmorton Street and Threadneedle Street are Stock Exchange premises. Since 1885 various alterations in the use of the space available have been made, but there has been no considerable extension to the building. A portion of the share and loan department occupies premises in Austin Friars.

The Stock Exchange site and buildings are the property of the holders of the share capital in the company called the Stock Exchange (Limited), which is under the control of nine "trustees and managers," who are appointed by the shareholders. There are now 20,000 shares of unlimited amount on which £12 has been paid up; no one person may hold more than 200 shares, and only members of the Stock Exchange can hold shares, except in the case of the representatives of proprietors who acquired their shares before the 31st of December 1875. When a proprietor dies his shares must be sold to a member within twelve months of his decease. As the dividends are handsome, there is rarely any difficulty in finding a buyer for such shares. The income of the company is derived from the annual

subscriptions of members and their clerks, from entrance fees paid by new members, and from rents and investments.

The business and discipline of the Stock Exchange is under the control of the "committee for general purposes," shortly known as "the committee." This body is composed of thirty persons, and is elected annually. It is entirely distinct from the "managers." The committee, when called upon, settles disputes between members and sometimes between members and their clients. It does not move in any matter until this is brought to its notice, and even then it frequently declines to act. It does part of its work through sub-committees, but all questions are finally settled in full meeting. Its powers are very wide, ranging from the granting or refusing of a quotation to a new stock, to the expulsion of a member, and the suspension of a "special settlement," as well as such trifles as reprimanding young members overburdened with animal spirits, and the closing of the "house" for holidays other than those provided for by the rules. The committee has an enormous amount of routine work to do or superintend; the "official list" of prices and the marking of "business done," for which the share and loan department is responsible, is supervised by it; the "official assignees," who are appointed to deal with the assets of defaulting members, act under the orders of the committee.

Membership of the Stock Exchange is for twelve months only; everyone without exception who wishes to remain a member must be re-elected annually; the year ends on the 25th of March. New members may be elected, (a) by the nomination of a member who retires in favour of the new member, or of a former member, or of the legal personal representative of a deceased member. The candidate must be recommended by three members, who also become sureties for him during the first four years from the date of his admission for £500 each. (b) A certain number of admissions are made each year, without nomination, of candidates with two sureties; under this arrangement clerks who have completed four years' service are admitted.

Since the 23rd of November 1904, every member has been obliged to become the owner of at least one share in the Stock Exchange (Limited). This arrangement is the outcome of the long-standing controversy respecting the "dual management" of the Stock Exchange, the managers and the committee being, as already explained, independent authorities. The arrangement is, no doubt, anomalous, but it has worked efficiently. Its principal drawback is the fact that, as the managers are proprietors and represent the body of proprietors who were, and still are, a minority of the members, they may be unconsciously biased in favour of increasing the number of members, since the dividends on the Stock Exchange shares are derived from this source. In 1904 the number of members had become, temporarily, at any rate, too great, relatively to the business to be done by them, and it was decided to introduce the principle of limitation, not directly, but by the methods briefly described above. It is hoped that, if the shares are all gradually distributed among the members, the slight difference between the interests of the managers and the rest of the Stock Exchange will disappear. The plan adopted involves of course the difficulty that it may not be easy at all times for a candidate to obtain his qualifying shares except at a high price. The new system, however, appears to work well.

The London Stock Exchange is remarkable for having developed spontaneously a special mode of doing business, namely the differentiation of members into jobbers and brokers. A jobber is a member of the Stock Exchange who, according to the rules of that body, does business only with other members, as opposed to a broker who does business with the public as well as with his fellow members. Any member may at any time make known his intention to act as either jobber or broker, but he must not act as both simultaneously. The business of a jobber (who is sometimes called a dealer) is to be prepared to "make prices" and deal in certain classes of securities selected by himself, in which he causes it to be known that he is a jobber. He thus

The Managers, the Members and Committee.

Jobbers and Brokers.

becomes a jobber in "the American market," or in the "South African market," or in the "Consols market"; or in any other market which he chooses. At the beginning of his career he usually has to rely for business on such friends as he has made in the house, while serving his time as a clerk to a broker; but if he shows ability for the work he soon becomes known to a wider circle and may eventually make for himself a position of considerable importance in the house. A jobber's method of doing business is simple in appearance. All he has to do is to remain in or near that portion of the Stock Exchange where other jobbers in the class of stocks he is concerned with congregate, during the greater part of the day, and wait for brokers to propose transactions to him. If he is in the Home Railways market and a broker tells him that he wants to deal in, say 1000 "Easterns," meaning Great Eastern ordinary, he replies that they are 80 to 80½, or whatever the price is at the moment; this means that he will sell at the higher and buy at the lower of these prices the amount of shares mentioned, not knowing "which way" the broker wishes to operate. On the latter saying that he will sell, or buy, as the case may be, the bargain is made, and is noted by both parties in memorandum books for completion at the next "settlement." The broker is understood to be, and usually is, acting for a client outside the house, and is paid for his trouble by a brokerage fixed by rules and paid by the client. The jobber's profit consists in the "turn," that is, the difference between the two prices quoted. But it is obvious that the realization of this profit by the jobber depends on his being able to effect a counter-sale, or purchase, with some other broker in 1000 "Easterns," and it is in so fixing the prices he quotes that, on the average of the day's or fortnight's transactions, his book shows a balance on the right side that his ability is displayed. If he has sold the stock and has not got it on his books already, he must procure it by the next settlement in order to deliver it; if he cannot procure it he must borrow it (backwardation). If he has bought it he must pay for it by the next settlement, and should it have gone down in the interval he will evidently have made nothing on the transaction, so far as that settlement is concerned; he will have the stock "on his book" and will have to carry it over (contango) and wait till someone wants to buy it of him in order to "undo" the bargain. If he is possessed of capital he may pay for and hold the stock until its price has risen considerably, but as a rule a jobber tries to make quick profits. A jobber is not obliged to make a price, and in times of serious trouble the weaker ones among them refuse to do so, or merely stay away. A jobber has another defence against the risk of making a bargain which he thinks he will not be able to "undo" promptly; he can quote a "wide" price, that is, he could quote for 1000 "Easterns" "79½-80½," a price no broker would be likely to deal at. The extent of a jobber's business depends on the reputation he has acquired. Good brokers, in their own as well as their client's interest, always "pick their man," especially in times of danger and difficulty. A broker may be acquainted with several men in a particular market any one of whom he considers quite safe to deal with in ordinary times, but he will be very careful whom he chooses to execute an order with, when, owing to money being dear, or for some other reason, markets are "bad." The usefulness of the jobber has from time to time been denied by critics, who have pointed out that in other stock exchanges no differentiation of members into brokers and jobbers has taken place. It has also been alleged that his "turn" is too easily earned, which is not true, and that it is often too large; as to the latter statement, it may safely be said that no jobber who habitually quoted prices which were too "wide" would get much business.

Since 1900 a controversy has arisen as to the propriety of jobbers dealing direct with members of country stock exchanges, and of brokers dealing direct with financial houses with "Outside Parties." known to have certain shares to sell. The difficulty as regards the latter chiefly affected the mining share market. It may be argued that both parties are wrong according to the letter of Stock Exchange law,

but their action can be defended. The broker who goes for a particular share direct to a financial house (colloquially called "the shop") may get better terms for his client, and though he also gets a second commission for himself, provided he makes known this latter fact to the client, the transaction is an innocent one. The jobber's action in regard to provincial stock exchanges, known in Stock Exchange slang as "shunting" business, may be regarded as a rough compensatory operation for loss of business he may incur through the broker's desertion of him for the financial houses. The quarrel would not have arisen but for the great increase in the members of the Stock Exchange and the fact that business during and for some years after the South African War was insufficient to give a living to so many competitors for it.

The hours of business on the Stock Exchange have varied little since the early days of the institution. They now begin at 11 a.m. and end at 3.30 p.m. on ordinary days except Saturday, but the house remains open until 4 p.m. On Saturdays the closing hour is 1.30. During the settlement (see ACCOUNT) the house is kept open till 4.30 p.m. Bargains are "marked," that is, the prices at which they are "done" are recorded in the official list, between 11 a.m. and 3.30 p.m. on ordinary days, and 11 a.m. and 1 p.m. on Saturdays; the marking of a bargain is effected at the request of the broker who made it; whenever investment purchases are made a large proportion of them are usually marked, as brokers like to be able to show that they did the business at the price stated in the "contract note" sent to the client. The amount of trouble a broker takes for a client is not always realized. An investment order gives much more trouble to a broker than a speculative order. In the former case the broker after arranging the purchase or sale has to perform various operations before the whole transaction is complete. He has to procure transfer forms, get them properly signed and witnessed, obtain the certificates, if the security dealt in is registered stock or shares, or the bonds if the security is "to bearer." There may be delay in the delivery of securities bought for which he is not responsible, but for which he may be blamed by an inconsiderate client. In cases of serious and unreasonable delay a broker has the drastic remedy open to him of calling upon the officials of the "buying-in and selling-out department" to buy the stock at whatever price may be necessary, the other party, that is, the jobber with whom he dealt, paying any difference between the agreed price and the price at which the security was "bought-in." Inscribed stock may be bought in on the day following the day specified for delivery of it. Bearer securities not punctually delivered may, in some cases, be bought in on the day they were due for delivery. Similar rules apply to unreasonable delay in payment for securities sold, which may be ended by a demand that the stock shall be "sold out." These rules are intended for use in extreme cases, and are not often resorted to.

Every bargain which a broker executes for a client is understood to be "for the account," unless otherwise specified; that is, the completion of the bargain is understood as intended to take place on the next "settling day." There are two settlements in securities generally, and one in consols and British government securities, India stock, &c., each month (see ACCOUNT). The interval between two settlements varies from 12 days to 19 days, but the normal interval is 14 days, and the settlement is usually spoken of as "the fortnightly settlement" or "account." In most securities it would not be easy to deal "for money," that is, to obtain cash or stock on the day of the transaction; but this can always be done in consols and other British government securities; "money" bargains in these are sometimes very numerous. Of late the practice of dealing in consols for next ordinary (not consols) account has become fairly common, and is now recognized officially.

All bargains for sale or purchase of stock are supposed prima facie to be investments, that is, the form of contract is the same in all cases. But if a client has bought or sold speculatively he will when the settlement arrives either "close

the account" by effecting a sale, or purchase, of the stock he has operated in, or he may request his broker to "carry over" the bargain or "continue" it until the next account. This operation may be repeated as often as the client chooses, provided the broker is ready to give the required facilities. But the broker is under no obligation to carry over, and in times of difficulty, when money is dear, or politics threatening, he would very likely decline to do so. Since about 1890 an increasing number of speculative transactions have been effected in a manner which disguises their real character; the security is, to all appearance, bought and paid for in the Stock Exchange, but the client has, as a matter of fact, obtained the money by "pawning" the security with a bank. For many years the relations between the Stock Exchange and the money market in its wider sense (see MARKET) have been becoming closer; banks now lend more freely than they used to, and on a wider range of securities; but they also lend more often direct to the holder of the securities borrowed on, and not through a member of the Stock Exchange. Formerly the usual practice of those banks which had considerable business with the Stock Exchange was to lend large sums on high-class stocks to wealthy brokers, who employed the money inside the house in carrying over the accounts of their clients, or to other brokers whom they trusted. This class of business is still very large, but clients are not now always satisfied to borrow through their brokers; they not infrequently go direct to banks and borrow from them. This practice has its inconveniences: formerly it was possible for the jobbers in all important markets on the Stock Exchange to form a good idea, by comparing notes at each settlement, of what the condition of the speculative account really was, but it is less easy to do so now, because so much stock is "pawned" with banks that the conclusions arrived at by the jobbers from examining only what they are carrying over themselves are liable to be falsified through their finding (a) that the account is either lighter than they expected, stock having been taken off the market temporarily by means of loans obtained from banks; or (b) that it is much heavier than they were prepared for, the banks having suddenly refused to lend any longer on a mass of stock they had hitherto been carrying. Banks are apt to be more capricious in their action as regards this class of business than the big "money brokers"; they cannot so well feel the pulse of the market, and are therefore liable to sudden fits of alarm, and also to hurried changes of policy on the part of their boards, which may be, and usually are, based on sound principles, but are not infrequently carried out without sufficient regard to the circumstances existing at the moment chosen for putting them in practice.

Speculative dealings sometimes take the form of "options." An option is a right to buy or sell a specified quantity of a specified security at a certain price, within a specified period; for this right a sum of cash is paid which is usually quoted as a percentage on the face value of the security. Having paid this sum the purchaser of the option watches the market during the period fixed; if a rise or fall sufficient to show a profit occurs he sells or buys an amount of the security equal to that bargained for in the option contract and informs the broker with whom he "did the option" that he "calls" the security from, or "puts" it on him. If no movement, or an insufficient movement, occurs in the price during the specified period, the "option" is "abandoned." This form of transaction is often a useful one for a business man, but attempts have been made to represent it as a "safe" way of making money on the ground that "risk is limited," and, as such, it has been recommended to inexperienced persons who are foolish enough to wish to speculate without comprehending the nature of speculation. Option dealings are neither more nor less "safe" than other speculative operations. Brokers who quote prices for an option always fix them at a level which will, on the average, make their own positions safe, and their clients, unless they are unusually acute and well informed, are not more likely to make exceptional, or any, profits than by the more usual speculative methods.

During recent years the volume of transactions in interest-bearing securities has grown enormously in all the great cities of the world. In London the membership of the Stock Exchange, the number of securities quoted in the official list, and the number of securities dealt in, have expanded greatly, and the markets in New York and Paris, especially the former, have acquired enhanced importance. The Berlin Bourse, the business of which was steadily growing during the 'eighties and early 'nineties, was checked in its expansion after 1896 by drastic legislation passed in July of that year against bargains for future delivery, and much of the business of German speculators has been done since then in other exchanges, especially London, Amsterdam and Brussels, but it has grown nevertheless, and if the existing restrictions are removed will grow more. Communication between the various great cities of the world is much closer than it was before the telephone came into use; what is known as arbitrage business having attained very large proportions. This class of business consists in watching closely the fluctuations in certain securities which are dealt in in two big markets, and simultaneously selling in one and buying in the other. Previous to 1884 and 1885 it was chiefly confined to operations between London and Paris, the difference in the times of London and New York having up till then prevented the growth of a similar business between those cities, as New York morning prices do not reach London till about 3.15 p.m., and the London Stock Exchange is shut at 4 p.m. But in London, about the middle of the 'eighties, the practice of staying in "the street," after the Stock Exchange was shut, to deal in "Americans," began to become common, though many old-fashioned brokers set their faces against it. It is worth noting that in most of the foreign cities there has always been a disposition to stay later than in London, where it was formerly the rule to cease business definitely at a more or less fixed hour. Since 1885 there has been more laxity in this respect, but it is not even yet the practice to do business in the evening. In Paris, dealing "on the boulevard" goes on intermittently in summer as late as 9 p.m. when trade is active.

The market for mining shares had, up to about 1888, held a very small place in the business of the Stock Exchange, but the discovery of an extensive goldfield on the Witwatersrand in the Transvaal produced a great change. At first, although the transactions in the new group of securities were very large, and enormous sums of money were won and lost in them, the "Kaffir circus," as it was called, was regarded with contempt by the older *habitues* of the Stock Exchange, and it was not until the winter of 1894-1895, when the number of brokers engaged in the new market had become greater than those in any other, that special recognition was given to the mining department by a rule that the arrangements for carrying over bargains in mining shares should begin the day before the regular settlement commenced (see ACCOUNT). Even with these new facilities the Stock Exchange clearing house found it difficult to cope with the huge mass of work thrown on it in 1895, and once or twice it broke down temporarily. Much of the trouble to all concerned arose from the fact that mining shares, like nearly all securities dealt in in London, were "registered" and not "to bearer." The offices of the companies were naturally not equipped with the staffs that would have enabled them to furnish certificates promptly in the enormous quantities unexpectedly required: it must be remembered that the preparation of a certificate for 50 or 100 shares of £1 each is just as troublesome as the preparation of one for 500 or 1000. The new feature, which upset all calculations, was the extraordinary number of small speculative investors who bought and paid for their shares, very often to their subsequent regret. If the shares had been "to bearer," the work could have been done with comparative ease.

Another remarkable feature of the "boom," to use the slang which came into general use during the great speculative mania for South African shares in 1895, was the fact that of the 200 or 300 shares dealt in, less than a dozen were officially quoted.

The Growth of Stock Markets.

The Mining Market.

As a rule no quotation was asked for, though a "special settlement" was obtained. Most of the companies concerned had been registered under the laws of the then existing Mining Shares not Quoted Officially. South African Republic. After the Jameson raid business in the South African market slackened somewhat, and there were few new "Kaffir" companies introduced; but the volume of mining transactions was kept up by the discovery of the Coolgardie goldfields of West Australia, which led to the creation of a great number of companies, whose shares were "introduced" in London from 1895 onwards. Very few of these also were, or are, quoted in the official list. A minor "boom" occurred in the winter of 1900-1901 in West African shares, but although it created a good deal of noise, it was not to be compared in magnitude to the South African and West Australian movements. The West African goldfields are expected by the best authorities to be very productive eventually, but are at present in an early stage of development.

Recent events have been very unfavourable to the South African market, which has ceased to attract the attention it met with before the South African War. Many jobbers have left it for other markets, and the volume of business in it is so small that the additional day granted for the settlement of bargains in mining shares is said by some to be no longer necessary. Though the older mining markets are comparatively quiet, some new ones have come into existence, especially that for Siberian, British Columbian and New Zealand properties. There has also been an attempt to establish a market for Egyptian securities, chiefly those of land and financial companies; an extraordinary speculation took place in Cairo during 1905-1906, and collapsed in the early part of 1907 with unfortunate results to those who financed it. In 1910 a rubber market became active.

Paris.—The Paris Bourse is an institution of enormous strength, but it plays a smaller part in international business than might be expected, owing to the deep-rooted conservatism and caution of the French people in money matters. It is true that they are liable to occasional outbursts of imprudence, such as led to the loss of great sums in the Panama Canal Company; but, as a rule, it is difficult to induce the average Frenchman to place his money in anything which he does not think a safe interest-yielding security under French law: he almost always wants to invest, not to speculate. In Great Britain and America the distinction between the two is too frequently forgotten. Since the Panama collapse in 1894 the French investor—that is, the bulk of the French nation—has been very prudent. The French have gone on saving money, and have been very difficult to satisfy in the matter of the securities offered to them. Appeals to patriotism have drawn from some French capitalists a considerable amount of money from time to time for Russian government loans, but these appeals were backed by assurances given by large banking institutions like the Crédit Lyonnais, the Comptoir d'Escompte, and the Société Générale, in addition to the Bank of France, that the interest was secure. As a rule, investments outside France are not popular with the French peasantry and middle classes; but there has always been a minority ready to speculate from time to time, besides the body of professional operators on the Bourse. The dimensions of this minority increased during the last eight or ten years of the 19th century, owing to the attractions presented by the South African goldfields. Operators and speculative investors in France were large holders of South African mining shares when the Boer War broke out in 1899, and though they sold them freely in consequence of the war, they did so with the intention of "coming in" again, and on more than one occasion made tentative purchases. The great banking firms and institutions of Paris have been occupied a good deal with the finances of Spain, Portugal, Egypt, Turkey and other minor countries. They are often large purchasers of British Treasury bills, which during the first two years of the South African War afforded an extraordinary opportunity to the investor, it being possible to buy them at prices yielding a rate equal to $3\frac{3}{4}$ % per annum during the currency of the bills.

The Paris Bourse exists in virtue of the decree of the 7th of October, 1890, to regulate the execution of article 90 of the Code du Commerce and of the law of the 28th of March 1885, on *marchés à terme*, as modified by the decree of the 29th of June 1898. *Agents de change*, who form the members of the official bourses in France, must be Frenchmen over twenty-five years of age, and must be in possession of civil and political rights. They are "nominated" by decrees countersigned by the minister of finance or the minister of commerce and industry. In a bourse possessing six or more *agents de change à parquet* may be formed, that is, a portion of the bourse may be railed off to which only *agents de change* have the right of entry, the rest of the bourse being known as the *coulisse*. A bourse provided with a *parquet* elects a *chambre syndicale*, or committee, composed of a syndic and members varying in number according to the number of *agents* in the bourse. The maximum, when there are over sixty *agents*, is eight. In Paris there were only sixty *agents de change* until 1898, but in that year the number was raised to seventy, owing to the volume of securities to be dealt with on the bourse having expanded considerably. The individual members are not, in law, responsible for any liabilities that may be incurred by fellow-members, but the practice is that the *chambre syndicale* meets the liabilities of any defaulting member. Each member owns what is called a *charge*, for which he has paid a sum varying from 1,500,000 fr. to 2,000,000 fr. (£60,000 to £80,000) to his predecessor by a private arrangement. In addition the new member must deposit 250,000 fr. (£10,000) as caution money, and 120,000 fr. (£4800) in the *caisse commune* of the *chambre syndicale*. The *agents de change* have a monopoly of many kinds of legal business; they have various privileges denied to the dealers in the *coulisse*, as, for instance, the right to sell or buy certain securities for cash, the *coulissiers* being allowed only to deal for delivery at the settlement. The securities dealt in by the *coulisse* are known as *valeurs en banque*, and the *coulisse* is often called the *marché en banque*. The *agents de change* are responsible for the production of the official price list of the bourse, but the *coulisse* also issues a list of its own. A much bigger business is done in the *coulisse* than in the *parquet*, the market for foreign securities being in their hands; many *coulissiers* are wealthy men.

All continental securities are "to bearer," and when it is desired to induce French capitalists to take an interest in British securities which are inscribed or registered, it has been found necessary to convert a part of the stocks into bearer bonds or shares. The fact that all securities are to bearer has led to special arrangements being made for guarding against the delivery of bonds to which the seller's title may be considered doubtful. A journal called the *Bulletin officiel des oppositions* is published by the *syndicat des agents de change*, giving the designations and numbers of securities which have been *frappés d'opposition*, that is, whose currency on the bourse is temporarily stopped, either because they have been stolen or for other reasons. It is always necessary, before taking delivery in London of foreign bonds, to look through this list to see whether the bonds in question are included in it. Settlement (*liquidation*) in Paris takes place twice a month; that at the end of the month lasts five days, and that in the middle of the month four days. French *rentes* are "settled" at the end of the month.

New York.—The New York Stock Exchange is a wealthy association consisting of members, who must be citizens of the United States, of twenty-one years of age or more. Their number cannot be increased except by the governing committee, which consists of the president, treasurer and secretary of the Stock Exchange, and forty members. There are twelve standing committees to deal with various departments of administration, the more important of these being the Admission, Arbitration and Clearing House committees.

Persons attain membership by election, or by transfer from a member who has died or resigned. Various dues and charges are payable by a new member. A member who is admitted by transfer pays an "initiation fee" of \$2000 (£400). When a

transfer is made the approval of the governing committee must be obtained before it can be completed. The person to whom the transfer is made pays a sum to the transferor for his "seat in the house," the amount of which is a matter of private arrangement; as much as \$90,000 (£18,000) has been paid for a "seat" when business is active, but when it is quiet the price falls considerably below this. A member may transfer his seat to his son (if the committee approve) without charging anything for it; but in all cases the transferee pays the above-mentioned initiation fee of \$2000.

The gratuity fund is an arrangement for providing for the families of deceased members. Every member on election pays \$10 to this fund; when a member dies an assessment of \$10 is levied on all other members, and the Stock Exchange hands over \$10,000 (£2000) to the family of the deceased.

The New York Stock Exchange building is opened at 9.30 a.m., but business does not begin until 10 a.m. The daily session continues until 3 p.m. No transactions must be entered into before 10 a.m. or after 3 p.m. (with certain exceptions) under severe penalties. The object of this is to enable all members to feel secure that no business has been done except within the official period, during which they are prepared to watch the market or provide for its being watched. Loans of money or securities, that is, what is called in London contango and backwardation business, may be arranged after 3 p.m. This latter provision is a necessary result of the settling arrangements on the Exchange.

Transactions may be: (a) for cash, in which case payment is made or stock delivered the same day; (b) "the regular way," i.e. the transaction is to be completed on the following day to that on which the bargain was made; (c) "three days," in this case the bargain must be carried out in three days; (d) in the case of options bargains may be made up to a limit of sixty days. If no time is specified when the bargain is made it is treated as being "regular way." It will be seen that these arrangements differ materially from those in London, Paris and Berlin, where business is done on the basis of fortnightly or, in the case of some classes of securities, monthly settlements. New York has a daily settlement for the bulk of its transactions.

All leading banking and finance houses in New York have one partner who is a member of the Stock Exchange and attends to the firm's stock business. All partnerships in which a member is interested must be disclosed to the governing committee, who have very wide disciplinary powers which they can use if anything is done which is contrary to the rules, or the spirit of the rules, of the Exchange.

The Exchange building is situated in Wall Street, and the Exchange is colloquially known as "Wall Street," just as the London Exchange is sometimes called "Throgmorton Street" or "Capel Court." It has in it accommodation including a telephone installation for each member and a large staff of messengers, &c., for their service. The Exchange has met in the past with difficulties of the same kind as have troubled the London Exchange. In 1808 it was found necessary to regulate the growth of direct dealings with provincial exchanges, which were held to constitute a breach of the rules relating to commissions. Dealing for "outside" exchanges of an irregular character was forbidden in 1896.

The New York Exchange is often the scene of gigantic speculative movements, and enormous sums are won and lost on it from time to time; but a huge investment business, or, at any rate, what is intended to be investment business, is done in Wall Street. Too frequently, however, the ideas of the purchaser as to what constitutes an investment are not very clear, and he finds that he has acquired a speculative article; this is inevitable in a country which still contains a good deal of dormant wealth which must sometimes be developed by new methods whose merits, when expressed in terms of capital expenditure, are not always as great as their enthusiastic authors imagined they would prove.

Berlin.—The business of the Berlin Börse is conducted under the strict regulations of the Imperial German law of the 22nd of

June 1896, a measure which was intended to put a check on speculation in stocks and commodities in the supposed interests of the community. The term "Börse" is applied equally to the *Effectenbörse* (or *Fondsbörse*), that is, the "market for securities" (the Stock Exchange), and to the *Warenbörse* in which commodities are dealt in. "Börse" is, in fact, a term equivalent to "exchange" as used in the expressions "stock exchange," "corn exchange," "wool exchange," &c. The brokers (*Makler*) who carry on business at the Berlin Bourse are under the supervision of the *Ober-President* of the province of Brandenburg and the *Ober-President* of the city of Berlin, in accordance with the terms of the *Maklerordnung für die Kursmakler an der Berliner Börse*, which was issued in the form of a decree (Dec. 4, 1896) of the ministers of trade and industry.

The Bourse opens at 11.50 a.m. and closes at 3 p.m. for official dealings, and a quarter of an hour before and half an hour after those hours for "unofficial dealings." The unimportant part which the Berlin Bourse plays in the world of finance, owing to the legislative shackles with which it is loaded, has led to a movement in favour of a reform of the law, which would give more freedom to legitimate speculation in commodities as well as in securities. (W. Ho.)

STOCKHOLM, the capital of Sweden, on the east coast, not far south of the junction of the Baltic Sea and the Gulf of Bothnia. It is celebrated for the beauty and remarkable physical characteristics of its situation. The coast is here thickly fringed with islands (the *skärgård*), through which a main channel, the Saltsjö, penetrates from the open sea, which is nearly 40 m. from the mainland. A short stream with a fall normally so slight as to be sometimes reversed by the tide, drains the great lake Mälär into the Saltsjö. The scenery of both the lake and the *skärgård* is similar, the numerous islands low, rocky, and generally wooded, the waterways between them narrow and quiet. The city stands at the junction of the lake and the sea, occupying both shores and the small islands intervening. From the presence of these islands a fanciful appellation for this city is derived—"the Venice of the North"; but actually only a small part is insular. There are three main divisions, Staden, the ancient nucleus of the city, properly confined to Stadholmen (the city island) which divides the stream from Mälär into two arms, Norrström and Söderström; Norrmalm on the north shore of the channel, and Södermalm on the south.

The ancient origin of Staden is apparent in the narrow and winding streets, though the individual houses are not very old, owing to the ravages of frequent fires. A few, however, preserve antique narrow fronts with gables, as in some of the North German towns. The old market, still called Stortorg (great market) is now one of the smallest in Stockholm. At the north angle of the island is the Royal Palace (*Slott*). The original building was destroyed by fire in 1697, the body of Charles XI. being with difficulty rescued from the flames. A new palace after designs of Nicodemus Tessin the younger (d. 1728) was not completed, owing to wars and the general distress, until 1754; while a restoration carried out in 1901 included many ornamental details devised by the architect, and executed at the expense of King Oscar II. The palace is quadrangular with two wings towards the east and four (two straight and two curving) towards the west. The style, that of the Italian Renaissance, is noble and refined, the royal apartments rich in treasures of art. In the north-east wing is a museum of armour and costume, one of the finest of the kind existing. West of the palace are the offices of the majority of the ministries, some of them in the former buildings of the Royal Mint. Beyond these, on the west side of the island, is a square named from the palace on its northern side, the Riddarhustorg. The Riddarhus (house of the nobility) was the meeting-place of the Council of the Nobles until 1866, and its hall is adorned with the armorial bearings of noble families. In the northern forecourt is a statue (1890) of Axel Oxenstjerna, the chancellor, by J. Börjeson. The town-hall is also in Riddarhustorg, and a statue of Gustavus Vasa, unveiled in 1773 on the 250th anniversary of his accession to the throne, stands here. South-west of

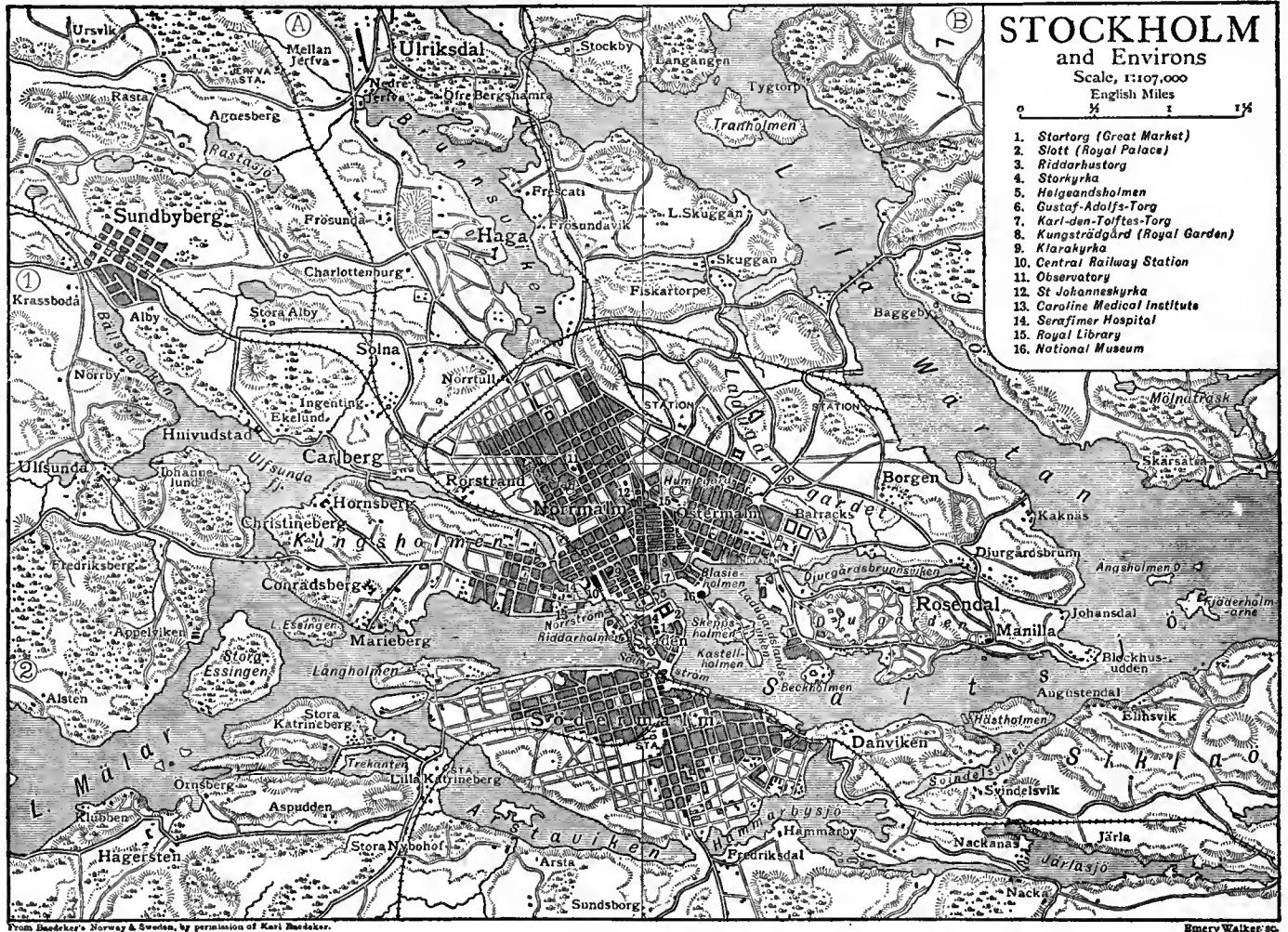

the Royal Palace is the Storkyrka (great church), dedicated to St Nicholas, the oldest church of Stockholm, though greatly altered from its original state. The date of its foundation is 1264; but it was practically rebuilt in 1726-1743. Within it is richly adorned with paintings and wood-carving. Staden is the commercial centre of the city. At the broad shipping quay (*Skeppsbro*) which flanks the palace on the north and east, most of the sea-going steamers lie; and the exchange, custom-house, numerous banks and merchants' offices are in the immediate vicinity. Riddarholmen (nobles' island), lying immediately west of Stadholmen, contains the old Franciscan church (*Riddarholmskyrka*), no longer used for regular service, which since the time of Gustavus Adolphus has been the burial-place of the royal family. It contains many trophies of the European wars of Sweden. On one side of it stands the old house of parliament; on the other a statue of Birger Jarl, the reputed founder of the city. On Riddarholm also are various government offices, and most of the steamers for Mälars and the inland navigation lie alongside its quays.

Staden is connected with Norrmalm by the Norrbro (north bridge) and Vasabro, the first crossing Helgeandsholmen (the island of the Holy Spirit), on which are the new *Norrmalm*. Houses of Parliament and the Bank of Sweden. A third bridge connects with the main thoroughfare of Norrmalm, Drottningsgatan (Queen Street). The Norrbro gives upon Gustaf-Adolfs-Torg, where a statue of that king stands between the royal theatre, royal opera house and the palace of the crown prince. Norrmalm is the finest quarter of the city, with broad straight streets, several open spaces with gardens, and handsome buildings. East and north of the theatre royal, the

Karl-den-Tolftes-Torg and Kungsträdgård (royal garden) form the most favoured winter promenade. There are a statue of Charles XII. and a fountain with allegorical figures, by J. P. Molin, also a statue of Charles XIII., and in the small Berzelii Park close at hand one of the chemist J. J. Berzelius. Near Drottningsgatan is the Klara church, the burial-place of the poet K. M. Bellman, and west of this, occupying one side of a square, is the central railway station. In the building of the academy of science is the national museum of natural history, including mineralogical, zoological, and ethnographical departments. Drottningsgatan terminates at the observatory, on a rocky eminence, near which are the offices for the distribution of the Nobel fund. To the east the modern Gothic church of St Johannes, with a lofty spire, stands conspicuously on the Brunkebergsås, one of the highest points in the city. To the north is the small Vanad's Park. To the west is the modern quarter of Vasastad, with its park. On the island of Kungsholm, south of Vasastad, are the Caroline medical institute, several hospitals, the principal of which is the Serafimer (1752), the royal mint and factories. Östermalm, lying east, that is, on the seaward side, of Norrmalm, is a good residential quarter, containing no public buildings of note, save the barracks of the Swedish Guards and the fine royal library, which is entitled to receive a copy of every work printed in Sweden. The library stands in the beautiful park of Humlegård (hop-garden), in which is also a statue of Linnaeus. South of Östermalm, and east of the Kungsträdgård and Staden, lies the peninsula of Blasieholm (formerly an island) and, connected by bridges, the islands of Skeppsholm and Kastellholm, the three forming the foreground in the beautiful seaward view from the Norrbro. On the first

is the national museum (1866), a Renaissance building, containing historical, numismatic and art-industrial collections, with ancient and modern sculptures, picture-gallery and engravings. The numismatic collection is notable for its series of Anglo-Saxon coins. About 11,000 pieces came from the island of Gotland, some dating from 901-924, but the majority are later. In front of the museum is a bronze cast of the famous group of J. P. Molin (1859), the Bältespännare (belt-bucklers), representing an early form of duel in Scandinavia, in which the combatants were bound together by their belts. On Skeppsholm are naval and military depots, and on Kastellholm a small citadel. East of Skeppsholm an inlet, Ladugårdslandsviken, so named from the proximity of the former royal farm-yard (*ladugård*), and bordered on the mainland by a quay with handsome houses called Strandvägen, throws off a narrow branch (Djurgårdsbrunnsviken) and separates from the mainland an island about 2 m. in length by $\frac{3}{4}$ m. broad. This is mainly occupied by Djurgården (the deer-park), a beautiful park containing the buildings of the northern museum, a collection of Scandinavian costumes and domestic and agricultural utensils, and a biological museum housed in a wooden building imitating the early Norwegian timber churches (*stavekirke*). Here also is Skansen, an ingenious reproduction in miniature of the salient physical features of Sweden with its flora, fauna, and characteristic dwellings inhabited by peasants in the picturesque costumes of the various districts. Both the northern museum and Skansen were founded by Dr Arthur Hazelius (1833-1901). There is a bust of the poet K. M. Bellman, whose festival is held on the 26th of July. Södermalm, the southern quarter, is principally residential. Rocky heights rise to 120 ft. above the water, and two steam lifts, Katarina-Hissen and Maria-Hissen, surmount them.

Environs.—The beautiful environment of sea and lake is fully appreciated by the inhabitants. To the north of the city, accessible by rail and water, are the residential suburbs of Haga and Ulriksdal, with royal *chateaux*, and Djursholm. Saltsjöbaden, 9 m. east of Stockholm, on Baggensfjörd, is the nearest and most favoured seaside resort, but Dalarö (20 m. south-east) and Nynäshamn (39 m. south) are much frequented. Vaxholm, 12 m. north-east by water, is a pleasant fishing-village where numerous villas have been built. A fortification on one of the islands here was erected by Gustavus Vasa, but has been modernized and is maintained.

Educational and Scientific Institutions.—Stockholm has no state university. A private university (*Högskoler*) was founded in 1878, and was brought under state control in 1904. The president of the governing body is appointed by the government, while the appointment of the remaining members is shared by the Swedish Academy, the Academy of Sciences and the City Council. The faculties are four—philosophy and history, philology, mathematics and natural sciences, and jurisprudence. The Caroline Institute (*Karolinska Mediko-Kirurgiska Institutet*) is a medical foundation dating from 1815, which ranks since 1874 with the state universities of Upsala and Lund in the right to hold examinations and confer degrees in its special faculty. Special and secondary education is highly developed; there are schools of agriculture, mining and forestry, military schools, technical schools, a veterinary school, a school of pharmacy, &c. Among the public colleges under state control, one, the Nya Elementarskolan, was founded experimentally in 1828, after the Education Committee of 1825-1828, among the members of which were Tegner and Berzelius, had reported on the want of such schools. This school retains its separate governing board; whereas others of the class are under a central board. The control of the primary schools in the parishes is similarly centralized; whereas in Sweden generally each parish has its school-board. Stockholm is the seat of the principal learned societies and royal academies (see SWEDEN). There are schools of painting, sculpture and architecture under the direction of the Royal Academy of Arts; a conservatory of music under that of the Royal Academy of Music; and experimental gardens and laboratories under the Royal Society of Agriculture. The Natural History Museum, the observatory and meteorological office, and the botanical gardens are under the supervision of the royal academy of sciences. Minor collections deserving mention are the museums of the geological survey and the Caroline Medical Institute, and the archives in the record office (*Riksarkivet*).

Recreations.—Among places of entertainment, the royal theatre is managed by a company receiving a state subsidy. The Dramatic Theatre (*Dramatiska Teatern*), in Kungsträdgårdsgatan, the Swedish (*Svenska*) theatre in Blasieholms-Gatan, and the Vasa theatre in Vasa-Gatan may also be mentioned. The Djurgård is

the principal place for variety entertainments in summer. Several of the leading sporting clubs have their headquarters in Stockholm. An annual regatta is held early in August by the Royal Swedish Yacht Club (*Svenska Segelsällskapet*). A harbour much frequented by yachts is Sandhamn in the outer *skärgård*. The Stockholm General Skating Club (*Almänna Skridskoklubb*) is the leading institution for the most favoured winter sport. A characteristic spectacle in winter is the tobogganing in the Humlegård on holidays. The principal athletic ground is the Idrottspark (Sports Park), on the north side of Östermalm, with tennis courts and a cycling track, which may be changed into a skating-rink in winter. There is a similar park at Djursholm.

Commerce.—The industries of Stockholm are miscellaneous. The value of the output of these is nearly thrice those of Malmö or Gothenburg, the next most important manufacturing towns, and the industries of Stockholm exceed those of every *län* (administrative division) except Malmöhus. The iron and steel industries are very important, including engineering in every branch, and shipbuilding. Factories for articles of human consumption (*e.g.* breweries and tobacco works) are numerous; and cork, wood, silk and leather works may also be mentioned. Fine ware is produced by the Rörstrand and Gustafsberg porcelain works. In addition there are various government works, as the mint and printing works. Stockholm is the first port in Sweden for import trade, but as regards exports ranks about level with Malmö and is exceeded by Gothenburg. The imports average nearly 30% of those of the whole country, but the exports only 9%, Stockholm having proportionately little share in the vast timber export trade. Vessels of 23 ft. draught can go up to the city (Skeppsbro and Blasieholm quays), and there is an outpost at Värtan on the Lilla Värtan channel to the north-east.

Government.—Stockholm is the centre of government and the usual residence of the king; in summer he generally occupies one of the neighbouring country palaces. The city is the seat of the high court of justice (*Högsta Domstolen*) and of the court of appeal for the northern and midland districts (*Svea Hofrätt*). It is one of the two Swedish naval stations (Karlskrona being the principal one), and the headquarters of the fourth and fifth army divisions. As regards local government, Stockholm is a *län* (administrative district) in itself, distinct from the rural *län* of the same name, under a high governor (*öfverståthållare*) and deputy, with departments for secretarial work, taxation and police. The city is in the diocese of Upsala, but has a separate consistory, composed of the rectors of the city parishes, the president of which is the rector of St Nicholas (*Storkyrka*).

Population.—The population of Stockholm in 1900 was 300,624. In 1751 it was 61,040; in 1850, 93,070; and in 1880, 176,875.

History.—Before the rise of Stockholm, Björkö, Sigtuna and Upsala were places of great importance. Björkö ("the isle of birches"), by foreign authors called Birka, was a kind of capital where the king lived occasionally at least; history speaks of its relations with Dorestad in the Netherlands, and the extensive refuse heaps of the old city, as well as the numerous sepulchral monuments, show that the population must have been large. But though situated at a central point on Lake Mälaren, it was destroyed, apparently before the beginning of the 11th century (exactly when or by whom is uncertain); and it never recovered. Sigtuna, lying on the shore of a far-reaching northern arm of Lake Mälaren, also a royal residence and the seat of the first mint in Sweden, where English workmen were employed by King Olaf at the beginning of the 11th century, was destroyed in the 12th century. Stockholm was founded by Birger Jarl, it is said, in or about 1255, at a time when pirate fleets were less common than they had been, and the government was anxious to establish commercial relations with the towns which were now beginning to flourish on the southern coast of the Baltic. The city was originally founded as a fortress on the island of Stadholm. The castle was erected at the north-eastern corner, and the city was surrounded with walls having fortified towers on the north and south. It came to be called Stockholm ("the isle of the log," Latin *Holmia*, German *Holm*); the true explanation of the name is not known. During the middle ages the city developed steadily, and grew to command all the foreign commerce of the midlands and north, but it was not until modern times that Stockholm became the capital of Sweden. The medieval kings visited year by year different parts of the kingdom.

See P. R. Ferlin, *Stockholms Stad* (Stockholm, 1854-1858); C. Lundin and A. Strindberg, *Gamla Stockholm* (Stockholm, 1882); C. Lundin *Nya Stockholm* (Stockholm, 1890); G. Nordensvan, *Mälardrottningen* ["the queen of Mälaren"] (Stockholm, 1896); E. W.

Dahlgren, *Stockholm, Sveriges hufvudstad skildrad* (Stockholm, 1897, issued by the municipal council on the occasion of the Stockholm Exhibition, 1897).

STOCKING (a diminutive of "stock," post, stump, properly that which is stuck or fixed), a close-fitting covering for the foot and lower part of the leg, formerly made of cloth but now of wool, silk or cotton thread knitted by hand or woven on a frame (see **HOSIERY**). "Stock" being the stump, *i.e.* the part left when the body is cut off, the word was applied to the whole covering of the lower limbs, which was formerly in one piece, the "upper-stocks" and "nether-stocks" forming the two pieces into which it was subsequently divided, when the upper part became the trunk hose and later knee-breeches, the lower the "stockings." A parallel is found in French; the hose are *chausses*, the upper part *haut de chausses*, the stockings *bas de chausses*, or simply *bas*. The German *Strumpf*, stocking, means also a stump, pointing to the original use of the word. Half-stockings, reaching to the lower part of the calf of the leg, and worn by men since the use of the long trousers has superseded knee-breeches, and also by children, are usually styled "socks." This word is an adaptation of Latin *soccus*, a slipper or light shoe. It was the shoe worn by the actors in Roman comedy—and so was used symbolically of comedy, as "buskin," the high boot or *cothurnus*, was of tragedy.

STOCKMAR, CHRISTIAN FRIEDRICH, BARON VON (1787–1863), Anglo-Belgian statesman, who came of a Swedish family, was born at Coburg on the 22nd of August 1787. He was educated as a physician, and in that capacity became attached in 1816 to Prince Leopold of Saxe-Coburg-Gotha on his marriage to Princess Charlotte of England. When she died next year he remained Leopold's private secretary, controller of the household and political agent, until the prince became in 1831 king of the Belgians. He was thus brought into contact with the leading statesmen of Europe, and his disinterestedness and profound acquaintance with English and European social and political questions impressed themselves on all who were associated with him. In 1831 he retired to his home at Coburg, in order not to excite Belgian jealousies by residing at his master's court in the capacity of confidential adviser, but he continued to be Leopold's right-hand man. In 1837 Leopold sent him to England as adviser to the young Queen Victoria, and in the next year he accompanied Prince Albert (afterwards Prince Consort) on his tour in Italy, partly as tutor but also with the direct object of satisfying King Leopold and the queen as to the fitness of the prince for the position already marked out for him in England. He won the complete confidence of the prince as well as of the queen, and on their marriage in 1840 he became their trusted though unofficial counsellor, dividing his time more or less between England and the Continent. In 1848 he was the ambassador of Coburg to the German parliament. He had at heart the unity of Germany under Prussia and close relations between Germany and England, and for these he steadfastly worked; but his political activity was a good deal resented in English circles, which were jealous of Prince Albert's—and generally of German—influence. He died at Coburg on the 9th of July 1863.

See the articles on **VICTORIA, QUEEN**; and **ALBERT, PRINCE CONSORT**. Selections from Stockmar's papers were published by his son Ernest in 1872, and a biography by Justi appeared at Brussels in 1873; see also *The Letters of Queen Victoria* (1907).

STOCKPORT, a municipal, county and parliamentary borough of England, mainly in Cheshire, but partly in Lancashire, 6 m. S.E. of Manchester. Pop. (1901), 92,832. It occupies a hilly site at the junction of the rivers Tame and Mersey; the larger part of the town lying on the south (left) bank, while the suburb of Heaton Norris is on the Lancashire bank. Several bridges cross the stream, and a lofty railway viaduct bestrides the valley. Stockport is served by the London & North Western, Midland, Great Central, Cheshire lines, and Sheffield & Midland railways, and has tramway connexion with Manchester. It is a town of varied industries, but the most important are the cotton and hat manufactures. The church of St Mary was built mainly *c.* 1817, but the chancel belonged to a former church, and retains a Decorated east window and other good details. The town hall was designed by Sir Brumwell Thomas,

and opened in 1908, and St George's church (1897). On the acquisition of the market rights by the town from Lord Vernon in 1847 the corporation secured the site of Vernon Park, in which stands a museum presented in 1858 by James Kershaw and John Benjamin Smith. The grammar school was founded in 1487 by Sir Edmund Shaa or Shaw, lord mayor of London. The Stockport Sunday school, founded in 1784, is one of the largest in England. Stockport was enfranchised in 1832, and returns two members. Its most distinguished representative was Richard Cobden (1841–1847), who is commemorated by a statue in St Peter's Square. The town was incorporated in 1835, and is under a mayor, 16 aldermen and 48 councillors. The county borough was created in 1888. Area, 5492 acres.

During the Roman occupation of Britain there was a small military station on the site of Stockport, acting as an outpost to the Roman camp at Manchester. The convergence of Roman roads at this point would make the place a particularly convenient centre. The etymology of the name may be Saxon, but there is no evidence of a Saxon settlement, and the place is not mentioned in Domesday. A castle was in existence in the 12th century, but is not mentioned after 1327. Stockport (Stokeporte, Stopport, Stopford) was made a free borough by a charter of Robert de Turgeposse about the year 1220. It was then granted that the burgesses might elect from among themselves a chief officer, who was first called a mayor in 1296. The right of the burgesses to his election was, however, lost, and the mayor was always nominated by the lord of the manor. This arrangement lasted until 1565, when the burgesses put in a claim to their right of election, and it was decided that out of four burgesses nominated by the lord of the manor the jury of the court leet should select the mayor. Thus Stockport was not a true municipal borough until formally incorporated under the Municipal Corporations Act of 1835. The manufacture of hemp began in Stockport in the 16th century, and that of silk-covered buttons in the 17th. In 1732 a silk mill was erected, but the silk trade was superseded by the cotton trade early in the 19th century. The hat trade developed at least as early as the end of the 18th century.

See Henry Heginbotham, *Stockport Ancient and Modern* (1882); J. P. Earwaker, *East Cheshire* (1877); John Watson, *Memoirs of the Earls of Warren and Surrey* (1782).

STOCKS, a wooden structure formerly in use both on the continent of Europe and in Great Britain as a method of punishment for petty offences. The culprit sat on a wooden bench with his ankles, and sometimes his wrists or even neck, thrust through holes in movable boards, generally for at least several hours. That stocks were used by the Anglo-Saxons is proved by their often figuring in drawings of the time (see Harleian MSS. No. 65). The second Statute of Labourers (1350) ordered the punishment for unruly artisans. It further enjoined that stocks (*ceppes*) should be made in every town between the passing of the act and the following Pentecost. The act appears to have been ill observed, for in 1376 the Commons prayed Edward III. that stocks should be set up in every village. Though never expressly abolished, the punishment of the stocks began to die out in England during the early part of the 19th century, though there is a recorded case of its use so late as 1865 at Rugby. In many of the villages in the country may still be seen well-preserved examples of stocks, in some cases with whipping posts attached. In the United States stocks were of frequent use in the 18th century, more particularly in the New England States; while in the Southern States they were employed for punishing slaves.

STOCKS and SHARES. A "share," in the financial sense, is simply the right to participate in the profits of a particular joint-stock undertaking. In the United Kingdom, in the case of a company constituted under the Companies Acts 1862–1907 as a company limited by shares, the memorandum of association is required to state—among other matters—the amount of capital

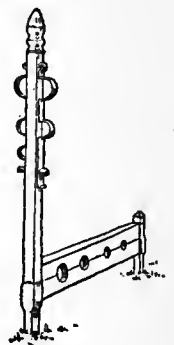

with which the company proposes to be registered and the amount of the shares into which such capital is divided. Company statistics show a tendency of late years on the part of companies to register with a smaller nominal capital than they did. The tendency too has been to lower the denomination of the shares. £100 shares, for instance, are now very rare. £1 shares and £5 shares are the most common. They obviously appeal better to the small investor. A typical capital clause runs thus: "The capital of the company shall be £100,000 divided into 100,000 shares of £1 each with such rights as regards dividends and other privileges as are defined by the company's articles of association for the time being," or "The capital of the company is £150,000 divided into 50,000 preference shares of £1 and 100,000 ordinary shares of £1 each. Such preference shares shall confer a right to a fixed cumulative preferential dividend at the rate of 10% per annum." The form of capital clause varies of course, but the more approved practice now is to leave the rights of preferential shareholders to be defined by the articles, and for this reason: that if such rights are fixed by the memorandum of association without qualification they cannot be subsequently varied. Articles, on the contrary, are always alterable, and as the preference shareholder takes his shares subject to this known liability to alteration no wrong is done him. If the powers of alteration were abused so as to amount to a fraud by the ordinary shareholders on the minority of preference shareholders the court would probably interfere by injunction. The preferential or other special privileges of any particular class of shareholders are now further safeguarded by s. 39 of the Companies Act 1907. The right of a preference shareholder is commonly confined to a preferential dividend and this dividend is *prima facie* cumulative, that is to say if the profits of the particular year are insufficient to pay it the deficiency must be made good out of the profits of subsequent years: but it is very common to give preference shareholders priority also as regards capital in the winding-up. Founders' shares originated with private companies, being a convenient means of securing to the partners in the vendor firm, on conversion, the control of the business as well as the lion's share of the profits. Thence they passed to ordinary trading companies, that is, companies which appeal to the public for their capital. Founders' shares in this connexion commonly entitle the holders to one-half or one-third of the company's profits after payment of a fixed dividend of, say, 7 to 10% to the ordinary shareholders. Founders' shares are mostly subscribed for by the vendors or promoters, though sometimes used by way of bonus to attract subscribers for the ordinary or deferred shares. They are now becoming rare.

Share Warrants to Bearer.—The Companies Act (1862) made no provision for the creation of shares to bearer. All shares under the act are registered and the title on the register is evidenced by a share certificate. The act of 1867 introduced shares to bearer under the title of "share warrants to bearer." A share warrant entitles the bearer to the shares or stock specified in it and such shares or stock are transferable by delivery of the warrant. The warrant is always treated as a negotiable instrument.

"Stock" in the case of companies constituted under the Companies Acts 1862-1907 is created by converting paid-up shares into stock. This may be done under s. 12 of the Companies Act 1862 by resolution. Under the same section a company may increase its capital by the issue of new shares or consolidate it into shares of larger amount; and by s. 21 of the Companies Act 1867 a company may subdivide its shares. The Companies Act 1907 (s. 39) gives a company a further power by special resolution, confirmed by an order of the court, to reorganize its capital, whether by the consolidation of shares of different classes or by the division of its shares into shares of different classes—but no preference or special privilege attached to any class of shares is to be interfered with except by a resolution passed by a majority of shareholders of that class representing three-fourths of the capital of that class. A limited company cannot reduce its capital without the sanction of the court.

Public Companies.—The provisions as to shares and stock under the Companies Clauses Acts 1845, 1863, 1869, are, with a few exceptions, analogous to those under the Companies Acts.

The capital of the company is to be divided into shares of a certain number and amount. A share register is to be kept and certificates are to be issued to shareholders; and power is given to convert paid-up shares into a general capital stock to be divided among the shareholders according to their respective interests therein. Such stock has been called a "set of shares put together in a bundle." Preference shares may be created, but there is this difference between preference shares under the Companies Clauses Act and under the Companies Acts, that under the Companies Clauses Acts preference shares are entitled to dividends only out of the profits of each year; under the Companies Acts the dividends as above stated are *prima facie* cumulative. Shares and stock may under the Companies Clauses Act be issued at a discount; under the Companies Acts they cannot. Under the Companies Clauses Acts if the old shares of the company are at a premium any new shares are to be offered first to the old shareholders. This is not found in the Companies Acts, but a similar provision is commonly inserted in the articles of companies formed under the acts. (E. MA.)

STOCKTON, FRANCIS RICHARD (1834-1902), American novelist, was born in Philadelphia, Pennsylvania, on the 5th of April 1834. He had a high school education; became a skilled wood engraver; wrote for the Philadelphia *Morning Post*, the New York *Hearth and Home*, *Scribner's Monthly* and *St Nicholas*, of which he became assistant editor in 1873; and about 1880 he gave up editorial work for independent authorship. Thereafter he lived in Nutley, New Jersey, in Convent, New Jersey, and after 1899 in the Shenandoah Valley, near Charles Town, West Virginia. He died in Washington, D.C. on the 20th of April 1902. His fanciful stories for children made him very popular; among them are *The Ting-a-Ling Stories* (1870), *Roundabout Rambles in Lands of Fact and Fancy* (1872), *What Might Have Been Expected* (1874), *Tales Out of School* (1875), *A Jolly Fellowship* (1880), *The Floating Prince and Other Fairy Tales* (1881), *The Story of Viteau* (1884), *Personally Conducted* (1889), and *Captain Chap* (1897). His amusing and original *Rudder Grange* (1879), a series of sketches rather than a novel, established his reputation with older readers and is his best long work. His peculiar talent was for the short story; and the best examples are the title stories of the volumes *The Lady or the Tiger?* (1884), one of the most popular of American stories, *The Christmas Wreck* (1886), *The Bee Man of Orn* (1887), (also in the latter volume "A Tale of Negative Gravity" and "The Remarkable Wreck of the Thomas Hyke"), and the novelette *The Casting Away of Mrs Lecks and Mrs Aleshine* (1886), with its sequel *The Dusantes* (1888).

Among his other works of fiction are *The Late Mrs Null* (1886), *The Hundredth Man* (1887), *Amos Kilbright: his Adscititious Experiences, with Other Stories* (1888), *The Great War Syndicate* (1889), *The Merry Chanter* (1890), *Ardis Claverden* (1890), *The Rudder Grangers Abroad, and Other Stories* (1891), *The House of Martha* (1891), *The Squirrel Inn* (1891), *The Watchmaker's Wife and Other Stories* (1893), *Pomona's Travels* (1894), *The Adventures of Captain Horn* (1895), with its sequel, *Mrs Cliff's Yacht* (1896), *The Great Stone of Sardis* (1898), *Kate Bonnet* (1902), and *The Captain's Toll-Gate* (with a memoir by Mrs Stockton, and a bibliography, 1903).

STOCKTON, a city and the county seat of San Joaquin county in central California, U.S.A., at the head of the Stockton channel of the San Joaquin river, about 48 m. S.E. of Sacramento. Pop. (1900), 17,506, of whom 4057 were foreign-born; (1910 census) 23,253. It is served by the Atchison, Topeka & Santa Fé, the Western Pacific and the Southern Pacific railways, and has also a considerable river trade with San Francisco. It is at the head of regular navigation on the river; at high water boats occasionally go to Hills Ferry, 150 m. beyond Stockton. The channel has been much improved by the Federal government since 1877. Stockton has a perfectly level site, broad streets and a regular plan. In the city are a good public library, the San Joaquin county law library, St Agnes academy, St Mary's college, a children's home (1896; under the Ladies' Aid Society), St Joseph's home (1899) for the aged, and St Joseph's hospital (1899), both under the Sisters of St Dominic, the Pacific hospital, a county hospital and a state hospital for the insane (1851). Situated in the great valley of the San Joaquin, in the midst of a

rich agricultural region, it is one of the largest grain, vegetable and fruit markets of the West. It manufactures flour, lumber, agricultural machinery and implements, &c. Its factory product in 1905 was valued at \$8,029,490, or 45.3% more than in 1900. Stockton rose into prominence in the early mining days. A settlement named Tuleberg, later called New Albany, stood on the city site in 1847; its future was precarious when the discovery of gold insured its prosperity. In the spring of 1849 a town was laid out and the present name adopted in honour of Commander Robert Field Stockton (1795-1866), who with Colonel John C. Fremont and General Stephen W. Kearny had gained possession of California for the United States during the war with Mexico. In 1850 Stockton became the county-seat and was chartered as a city.

STOCKTON-ON-TEES, a market town, municipal and parliamentary borough, and port of Durham, England, on the N. bank of the Tees, $\frac{5}{2}$ m. above its mouth, and on the North Eastern railway, 236 m. N. by W. from London. Pop. (1901), 51,478. The parliamentary borough extends across the river into Yorkshire, to include the municipal borough of Thornaby-on-Tees. At Norton, 1 m. north, the church of St Mary, formerly collegiate, shows fine Norman work. The chief buildings are a town hall, with clock-tower and spire, borough-hall, exchange and public library. The quays are accessible to vessels drawing 20 ft. at high water spring tides. There are extensive steel works, blasting furnaces, iron and brass foundries and rolling-mills; and iron shipbuilding is an important industry. There are also sailcloth works, potteries, breweries and brick and tile works. Exports (iron manufactures, coal and agricultural produce) were valued at £435,439 in 1900; imports (timber, iron, grain, &c.) at £280,371; trade being chiefly with Holland and the Baltic ports, and coastal. The parliamentary borough returns one member. The municipal borough is under a mayor, 10 aldermen and 30 councillors, and has an area of 2935 acres.

It would seem that Stockton (Stokton) grew up round the castle of the bishops of Durham, to whom the town belonged even before their purchase of the earldom of Sadberge. In 1183 the Boldon Book records that the whole town rendered one milch cow and the ferry twenty pence to the bishop. The castle was probably built between 1183 and 1214. King John visited Bishop Philip of Poitou (d. 1208) there and is said to have granted the place a charter similar to that of Hartlepool in 1214. Of this, however, no traces remain, the rights of the borough, which must have come into existence during the 13th century, being purely prescriptive. Stockton was divided into two parts: the "town," governed by the bailiff of the bishop and afterwards by the vicar and vestrymen, and the borough, under a mayor and aldermen. The bishop's bailiff was also the keeper of the castle, though in the 17th century the office belonged to the borough-bailiff. The borough is first mentioned in 1283, when the king took tollage from it during the vacancy of the see. It occurs again in a record of 1328, and in 1344 the mayor and bailiffs entered into an agreement with the mayor and bailiffs of Newcastle for the regulation of trade between the two places. Bishop Hatfield's survey (1377-1382) gives a list of tenants within the borough: 22 burgages and 15 half-burgages are mentioned, the rent of which varies from twenty-two pence to a penny half-penny. In 1644 the parliamentary troops besieged and captured the castle, which was dismantled in 1652. In 1666 the population was only 544, for Stockton was an isolated place with little trade. It became a parliamentary borough, returning one member, in 1867. In 1310 the bishop gave the town a market and a fair during the octave of the Translation of St Thomas the Martyr, reserving to himself the tolls; Bishop Morton revived the market, which had lapsed at the beginning of the 17th century. Camden speaks of Stockton as a neat, well-built corporation town and especially commends the ale brewed there and sent to various parts of the country. The importance of Stockton as a port dates from the end of the 18th century, when there was a considerable trade in lead, dairy produce and timber.

STODDARD, RICHARD HENRY (1825-1903), American author, was born in Hingham, Massachusetts, on the 2nd of

July 1825. He spent most of his boyhood in New York City, where he became a blacksmith and later an iron moulder, but in 1849 he gave up his trade and began to write for a living. He contributed to the *Union Magazine*, the *Knickerbocker Magazine*, *Putnam's Monthly Magazine* and the *New York Evening Post*. In 1853 Nathaniel Hawthorne helped him to secure the appointment of inspector of customs of the Port of New York. He was confidential clerk to George B. McClellan in the New York dock department in 1870-1872, and city librarian of New York in 1874-1875; literary reviewer for the *New York World* (1860-1870); one of the editors of *Vanity Fair*; editor of the *Aldine* (1869-1874), and literary editor of the *Mail and Express* (1880-1903). He died in New York on the 12th of May 1903. Among the numerous books that he edited are *The Loves and Heroines of the Poets* (1861); *Melodies and Madrigals, Mostly from the old English Poets* (1865); *The Late English Poets* (1865), selections; *Griswold's Poets and Poetry of America* (1872), and *Female Poets of America* (1874); *The Bric-a-Brac Series*, in 10 vols. (1874-1876); *English Verse*, in 5 vols. edited with W. J. Linton (1883); and four editions of Poe's works, with a memoir (1872-1894). His original poetry includes *Footprints* (1849), privately printed and afterwards suppressed; *Poems* (1852); the juveniles, *Adventures in Fairyland* (1853); *Town and Country* (1857), and *The Story of Little Red Riding Hood* (1864); *Songs of Summer* (1857); *The King's Bell* (1862), one of his most popular narrative poems; *Abraham Lincoln: A Horatian Ode* (1865); *The Book of the East* (1867); *Poems* (1880), a collective edition; and *The Lion's Cub, with Other Verse* (1890). He also wrote *Life, Travels and Books of Alexander von Humboldt* (1860); *Under the Evening Lamp* (1892), essays dealing mainly with the modern English poets; and *Recollections Personal and Literary* (1903), edited by Ripley Hitchcock. More important than his critical was his poetical work, which at its best is sincere, original and marked by delicate fancy, and felicity of form; and his songs have given him a high and permanent place among American lyric poets.

His wife ELIZABETH DREW (BARSTOW) STODDARD (1823-1902), poet and novelist, was born in Mattapoisett, Massachusetts, on the 6th of May 1823. She studied at Wheaton Seminary, Norton, Mass. After her marriage in 1852 she assisted her husband in his literary work, and contributed stories, poems and essays to the periodicals. She wrote three novels—*The Morgesons* (1862), *Two Men* (1865) and *Temple House* (1867), and a volume of poems (1895). A new edition of her novels was issued in 1901. She died in New York on the 1st of August 1902.

STOFFLET, JEAN NICOLAS (1751-1796), Vendéan general, was born at Lunéville, the son of a miller. Long a private soldier in a Swiss regiment in France, and afterwards game-keeper to the comte de Colbert-Maulevrier, he joined the Vendéans when they rose against the Revolution to defend their religious and royalist principles. During the war in La Vendée he served first under Gigot d'Elbée, fought at Fontenay, Cholet and Saumur, and distinguished himself at the battles of Beaupréau, Laval and Antrain. He was appointed major-general of the royalist army, and in 1794 succeeded La Rochejaquelein as commander-in-chief. But his quarrels with another Vendéan leader, F. A. Charette, and the reverses sustained by the Vendéan arms, led him to give in his submission and to accept the terms of the treaty of La Jaunaie (May 2, 1795). He, however, soon violated this treaty, and at the instigation of royalist agents took arms in December 1795 on behalf of the count of Provence (the future Louis XVIII.), from whom he had received the rank of *maréchal-de-camp*. This last attempt of Stofflet's failed completely. He was taken prisoner by the republicans, condemned to death by a military commission, and shot at Angers on the 23rd of February 1796.

See General d'Andigné, *Mémoires*, edited by E. Biré (1900-1901); C. Loyer, "Cholet sous la domination de Stofflet," in *L'Anjou historique*, vol. iii. (1902-1903).

STOICHIOMETRY (Gr. *στοιχεία*, fundamental parts, or elements, *μέτρον*, measure), in chemistry, a term introduced by

Benjamin Richter to denote the determination of the relative amounts in which acids and bases neutralize one another; but this definition may be extended to include the determination of the masses participating in any chemical reaction. The work of Richter and others who explored this field is treated under ELEMENT; here we discuss a particular branch of the subject, viz. the determination of equivalent and atomic weights of elements, and the molecular weights of elements and compounds. Reference to CHEMISTRY, ATOM and ELEMENT will explain the principles involved. Every element has an "equivalent weight" which is usually defined as the amount of the element which combines with or replaces unit weight of hydrogen; the "atomic weight" may be regarded as the smallest weight of an element which can be present in a chemical compound, and the "molecular weight" is the weight of the least part of an element or compound which can exist alone. The atomic weight is therefore some multiple of the equivalent weight, and the determining factor is termed the valency (*q.v.*) of the element. We have mentioned hydrogen as our standard element, which was originally chosen as being the lightest known substance; but Berzelius, whose stoichiometric researches are classical, having pointed out that few elements formed stable compounds with hydrogen, and even these presented difficulties to exact analysis, proposed to take oxygen as the standard. This suggestion has been adopted by the International Committee of Atomic Weights, who take the atomic weight of oxygen as 16.000, hydrogen being 1.0087.¹

Deferring the discussion of gaseous elements and compounds we will consider the *modus operandi* of determining, first, the equivalent weight of an element which forms solid compounds, and, secondly, its atomic weight. Suppose we can cause our element in known quantity to combine with oxygen to form a definite compound, which can be accurately weighed, or, conversely, decompose a known weight of the oxide into its constituents, of which the element can be weighed, then the equivalent weight of the element may be exactly determined. For if x grams of the element yield y grains of the oxide, and if W be the equivalent of the element, we have x grams of the element equivalent to $y-x$ grams of oxygen, and hence the equivalent weight W , which corresponds to 8 grams of oxygen, is given by the proportion $y-x : x :: 8 : W$, *i.e.* $W = 8x/(y-x)$. For example, Lavoisier found that 45 parts of red oxide of mercury on heating yielded $41\frac{1}{2}$ parts of mercury; hence $41\frac{1}{2}$ parts of mercury is equivalent to $45 - 41\frac{1}{2} = 3\frac{1}{2}$ parts of oxygen, and the equivalent of mercury in this oxide is therefore $8 \times 41\frac{1}{2} \div 3\frac{1}{2} = 95$. The question now arises: is this value the true equivalent, *i.e.* half the amount of mercury which combines with one atom of oxygen (for one atom of oxygen is equivalent to two atoms of hydrogen)? Before considering this matter, however, we will show how it is possible to obtain the equivalent of elements whose oxides are not suitable for exact analysis. No better example can be found than Stas's classical determination of the atomic weight of silver and of other elements.² It will be seen that the routine necessary to the chemical determination of equivalents consists in employing only such substances as can be obtained perfectly pure and stable (under the experimental conditions), and that the reactions chosen must be such as to yield a series of values by which any particular value can be checked or corrected.

Stas's experiments can be classified in five series. The object of the first series was to obtain the ratio Ag:O by means of the ratios KCl:O and Ag:KCl. The ratio KCl:O was determined by decomposing a known weight of potassium chlorate (*a*) by direct heating, (*b*) by heating with hydrochloric acid and weighing the residual chloride. The reaction may be written for our purpose in the form: $\text{KClO}_3 = \text{KCl} + 3\text{O}$; in case *a* the oxygen is liberated as such; in case *b* it oxidizes the hydrochloric acid to water and chlorine oxides. The equation shows that one KCl is equivalent

to 3O, and hence if x grams of chlorate yields y grams of chloride, then the ratio KCl:O = $y/\frac{3}{8}(x-y)$. Taking O as 16 and the experimental value of x and y , Stas obtained KCl:O = 74.9502. To find the ratio of Ag:KCl, a known weight of silver was dissolved in nitric acid and the amount of potassium chloride necessary for its exact precipitation was determined. The reaction may be written as $\text{AgNO}_3 + \text{KCl} = \text{AgCl} + \text{KNO}_3$, which shows that one Ag is equivalent to one KCl. The value found was Ag:KCl = 1.447110. The ratio Ag:O is found by combining these values, for Ag:O = KCl:O \times Ag:KCl = $74.9502 \times 1.447110 = 107.9401$.

In the second series the ratios AgCl:O and AgCl:Ag were obtained, the first by decomposing the chlorate by heating, and the second by synthesizing the chloride by burning a known weight of the metal in chlorine gas and weighing the resulting chloride, and also by dissolving the metal in nitric acid and precipitating it with hydrochloric acid and ammonium chloride. These two sets yield the ratio Ag:O, and also the ratio Cl:O, which, combined with the ratio KCl:O obtained in the first series, gave the atomic weight of potassium. The third and fourth series resembled the second, only the bromate and bromide, and iodate and iodide were worked with. The experiments gave additional values for Ag:O and also the atomic weights of bromine and iodine.

The fifth series was concerned with the ratios Ag_2SO_4 :Ag; Ag_2S :Ag and Ag_2S :O. The first was obtained by reducing silver sulphate to the metal by hydrogen at high temperatures; the second by the direct combination of silver and sulphur, and also by the interaction of silver and sulphuretted hydrogen; these ratios on combination gave the third ratio Ag_2S :O. These experiments besides giving values for Ag:O, yielded also the atomic weight of sulphur. There is no need to proceed any further with Stas's work, but it is sufficient to say that the general routine which he employed has been adopted in all chemical determinations of equivalent weights.

The derivation of the atomic from the equivalent weight may be effected in several ways. The simplest are perhaps by means of Dulong and Petit's law of atomic heats (and by Neumann's extension of this law), and by Mitscherlich's doctrine of isomorphism. Dulong and Petit's law may be stated in the form that the product of the specific heat and atomic weight is approximately 6.4, or that an approximate value of the atomic weight is 6.4 divided by the specific heat. This application may be illustrated in the case of mercury. We have seen above that the red oxide yields a value of about 95 for the equivalent; but a green oxide is known which contains twice as much metal for each part of oxygen, and therefore in this compound the equivalent is about 190. The specific heat of mercury, however, is 0.033, and this number divided into 6.4 gives an approximate atomic weight of 194. More accurate analyses show that mercury has an equivalent of 100 in the red oxide and 200 in the green; Dulong and Petit's law shows us that the atomic weight is 200, and that the element is divalent in the red oxide and monovalent in the green. For exceptions to this law see CHEMISTRY: § *Physical*.

The application of isomorphism follows from the fact that chemically similar substances crystallize in practically identical forms, and, more important, form mixed crystals. If two salts yield mixed crystals it may be assumed that they are similarly constituted, and if the formula of one be known, that of the other may be written down. For example gallium sulphate forms a salt with potassium sulphate which yields mixed crystals with potash alum; we therefore infer that gallium is trivalent like aluminium, and therefore its atomic weight is deduced by multiplying the equivalent weight (determined by converting the sulphate into oxide) by three. General chemical resemblances yield valuable information in fixing the atomic weight after the equivalent weight has been exactly determined.

Gases.—The generalization due to Avogadro—that equal volumes of gases under the same conditions of temperature and pressure contain equal numbers of molecules—may be stated in the form that the densities of gases are proportional to their molecular weights. It therefore follows that a comparison of the density of any gas with that of hydrogen gives the ratio of the molecular weights of the two gases, and if the molecular contents of the gases be known then the atomic weight is determinable. Gas reactions are available in many cases for solving the question whether a molecule is monatomic, diatomic, &c. Thus from the combination of equal volumes of hydrogen and chlorine to form twice the volume of hydrochloric acid, it may

¹ We may here state that the equivalent weight of oxygen on this basis is 8.000, *i.e.* one half of its atomic weight. This matter is considered below.

² The formulae used in the following paragraph were established before Stas began his work; and as oxygen is taken as 16, the results are atomic and not equivalent weights.

be deduced that the molecule of hydrogen and of chlorine contains two atoms (see ATOM); and similar considerations show that oxygen, nitrogen, fluorine, &c., are also diatomic. Physical methods may also be employed. For instance, in monatomic gases the ratio of the specific heat at constant pressure to the specific heat at constant volume is 1.66; in diatomic gases 1.42; with other values for more complex molecules (see MOLECULE). This ratio may be determined directly by finding the velocity of sound in the gas (Kundt) or by other methods, or indirectly by finding the specific heats separately and then taking the ratio. It is found that the gases just mentioned are diatomic, whereas argon, helium, neon and the related gases, and also mercury and some other metals when in the gaseous condition, are monatomic. A knowledge of the atomicity of a gas combined with its density (compared with oxygen and hydrogen) would therefore give its atomic weight if Avogadro's law were rigorously true. But this is not so, except under extremely low pressures, and it is necessary to correct the observed densities. The correction involves a detailed study of the behaviour of the gas over a large range of pressure (presuming the densities are already corrected to 0°), and may be conveniently written in the form $a = \frac{1}{pv} \frac{d(pv)}{dp}$. Thus if D be the observed

relative densities of a gas to hydrogen at 0° and under normal atmospheric pressure, a_x and a_H the coefficients of the gas and hydrogen, then the true density, or ratio of molecular weights, is $D \times (1 + a_x)/(1 + a_H)$.

Lord Rayleigh and D. Berthelot have corrected several molecular weights in this fashion. The importance is well shown in the modification of Morley's observed density of oxygen, viz. 15.90, which, with Rayleigh's values of $a_0 = -0.00094$ and $a_H = +0.00053$, gives the corrected density as 15.88. And this value is the atomic weight, for both hydrogen and oxygen molecules contain two atoms. Compound gases can also be experimented with. For example Gray (*Journ. Chem. Soc.*, 1905, 87, p. 1601) found that it was easier to prepare perfectly pure nitric oxide than to obtain pure nitrogen, and he therefore determined the density of this gas from which the atomic weight of 14.012, or, corrected for deviations from Avogadro's law, 14.006, was deduced.

The principle indicated here is applicable to the determination of the molecular weight of any vaporizable substance by the so-called method of vapour-density (see DENSITY).

Solutes.—The theory of solution permits the investigation of the molecular weights of substances which dissolve in water or some other solvent. It is shown in SOLUTION that a solute lowers the freezing point and raises the boiling point of the solvent in a regular manner as long as dilute solutions are dealt with. It has been shown that if one gram molecule of a solute be dissolved in 100 grams of solvent then the boiling point is raised by $0.02 T^2/w$. (say D) degrees, where T is the absolute boiling point and w the latent heat of vaporization of the solvent; this constant is known as the molecular rise of the boiling point, and varies from solvent to solvent. If we dissolve say m grams of a substance of molecular weight M in 100 grams of the solvent and observe the elevation in the boiling point, then M is given by $M = mD/d$. Similar considerations apply to the freezing points of solutions. In this case $D = 0.02 T^2/w$, where T is the absolute freezing point of the pure solvent and w the latent heat of solidification. To apply these principles it is only necessary therefore to determine the freezing (or boiling) point of the solvent (of which a known weight is taken), add a known weight of the solute, allow it to dissolve and then notice the fall (or rise) in the freezing (or boiling point), from which values, if the molecular depression (or elevation) be known, the molecular weight of the dissolved substance is readily calculated.

The following are the molecular depressions and elevations (with the freezing and boiling points in brackets) of the commoner solvents.

Molecular depressions: aniline (6°), 58.7; benzene (5.4°),

50.0; acetic acid (17.0°), 39.0; nitrobenzene (5.3°), 70.0; phenol (40°), 72; water (0°), 18.5.

Molecular elevations: acetic acid (118.1°), 25.3; acetone (56°), 17.1; alcohol (78°), 11.7; ether (35°), 21.7; benzene (79°), 26.7; chloroform (61°), 35.9; pyridine (115°), 29.5; water (100°), 5.1.

The apparatus used in cryoscopic measurements is usually that devised by Beckmann (*Zeit. phys. Chem.* ii. 307). The working part consists of a tube 2–3 cms. in diameter, bearing a side tube near the top; the tube is fitted with a cork through which pass a differential thermometer of a range of about 6° and graduated in 50ths or 100ths, and also a stout platinum wire to serve as a stirrer. The lower part of the tube is enclosed in a wider tube to serve as an air-jacket, and the whole is immersed in a large beaker. The thermometer is adjusted so that the freezing point of the pure solvent comes near the top of the scale. A weighed quantity of the solvent is placed in the inner tube, and the beaker is filled with a freezing mixture at a temperature a few degrees below the freezing point of the solvent. The thermometer is inserted and both solvent and freezing mixture are stirred. When the temperature is about 0.3° below the correct freezing point the tube is removed from the beaker and the stirring continued. There ensues a further fall in the thermometer reading until ice separates, whereupon the temperature rises to the correct freezing point. The ice is then melted and the operation repeated so as to obtain a mean value. A known weight of the substance is introduced through the side tube, and the freezing point determined as with the pure solvent. The difference of the readings gives the depression; and from this value, knowing the weight of the solute and solvent, and also the molecular depression, the molecular weight can be calculated from the formula given above.

In the boiling point apparatus of Beckmann the solvent is contained in a tube fitted with side tubes to which spiral condensers can be attached; the neck of the tube carries a stopper through which passes a delicate differential thermometer, whilst the bottom is perforated by a platinum wire and contains glass beads, garnets or platinum foil to ensure regular boiling. The tube is surrounded by a jacket mounted on an asbestos box, so that the heating is regular. In conducting a determination the thermometer is adjusted so that the boiling point of the pure solvent is near the bottom of the scale. A known weight of the solvent is placed in the tube, the thermometer is inserted (so that the liquid completely covers the bulb), and the condensers put into position. The liquid is now cautiously heated, and when the thermometer becomes stationary the boiling point is reached. The temperature having been read, the apparatus is allowed to cool slightly, and the observation repeated. A known weight of the substance is now introduced, and the solution so obtained treated in the same fashion as the original solvent.

A different procedure wherein the boiling tube is heated, not directly, but by a stream of the vapour of the pure solvent, was proposed by Sakurai (*Journ. Chem. Soc.*, 1892, 61, p. 994). Sakurai's apparatus has been considerably modified, and the form now principally used is essentially due to Landsberger (*Ber.*, 1898, 31, p. 461). The boiling vessel is simply a flask fitted with a delivery tube, which is connected with the measuring tube. This consists of a graduated tube fitted with a stopper through which passes a thermometer and an inlet tube reaching nearly to the bottom. The measuring tube is surrounded by an outer tube which has an exit to a condenser at the side or bottom, communication being made between the measuring tube and jacket by a small hole near the top of the former. In outline the operation consists in placing some solvent in the measuring tube and passing in vapour until the condensed liquid falls at the rate of one drop per second or two seconds. The temperature is then read off. A known weight of the substance is introduced and the boiling point determined as before; but immediately the temperature is read the tube must be disconnected, so that no more vapour passes over and so alters the concentration of the solution. Two methods are in use for determining the quantity of the solvent. Landsberger weighed the tube; Walker and Lumsden (*Journ. Chem. Soc.*, 1898, 73, p. 502) graduated the tube and thus measured the volume of the solvent; in W. E. S. Turner's apparatus (*Journ. Chem. Soc.*, 1910, 97, p. 1184) both the weight and volume can be determined. Whilst the calculations in both the Beckmann and Sakurai-Landsberger methods are essentially the same the "molecular elevations" differ according as one deals with 100 grams or 100 ccs. of solvent. In all these methods it is necessary to carefully choose the solvent in order to avoid dissociation or association. For example, most salts are dissociated in aqueous solution; and acids are bi-molecular in benzene but normal in acetic acid.

Other methods are available for dissolved substances such as measurements of the osmotic pressure, lowering of the vapour pressure and diminution of solubility, but these are little used. Mention may also be made of Ramsay and Shield's method of finding the molecular weights of liquids from surface tension measurements. (See CHEMISTRY: § Physical.)

STOICS, a school of philosophers founded at the close of the 4th century B.C. by Zeno of Citium, and so called from the Stoa or painted corridor (*στοὰ ποικίλη*) on the north side of the market-place at Athens, which, after its restoration by Cimon, the celebrated painter Polygnotus had adorned with frescoes representing scenes from the Trojan War. But, though it arose on Hellenic soil, from lectures delivered in a public place at Athens, the school is scarcely to be considered a product of purely Greek intellect, but rather as the firstfruits of that interaction between West and East which followed the conquests of Alexander. Hardly a single Stoic of eminence was a citizen of any city in the heart of Greece, unless we make Aristo of Chios, Cleanthes of Assus and Panaetius of Rhodes exceptions. Such lands as Cyprus, Cilicia and Syria, such cities as Citium, Soli, Heraclea in Pontus, Sidon, Carthage, Seleucia on the Tigris, Apamea by the Orontes, furnished the school with its scholars and presidents; Tarsus, Rhodes and Alexandria became famous as its university towns. As the first founder was of Phoenician descent, so he drew most of his adherents from the countries which were the seat of Hellenistic (as distinct from Hellenic) civilization; nor did Stoicism achieve its crowning triumph until it was brought to Rome, where the grave earnestness of the national character could appreciate its doctrine, and where for two centuries or more it was the creed, if not the philosophy, of all the best of the Romans. Properly therefore it stands in marked antithesis to that fairest growth of old Hellas, the Academy, which saw the Stoa rise and fall—the one the typical school of Greece and Greek intellect, the other of the Hellenized East, and, under the early Roman Empire, of the whole civilized world. The transcendent genius of its author, the vitality and romantic fortunes of his doctrine, claim our warmest sympathies for Platonism. But it should not be forgotten that for more than four centuries the tide ran all the other way. It was Stoicism, not Platonism, that filled men's imaginations and exerted the wider and more active influence upon the ancient world at some of the busiest and most important times in all history. And this was chiefly because before all things it was a practical philosophy, a rallying-point for strong and noble spirits contending against odds. Nevertheless, in some departments of theory, too, and notably in ethics and jurisprudence, Stoicism has dominated the thought of after ages to a degree not easy to exaggerate.

The history of the Stoic school may conveniently be divided in the usual threefold manner: the old Stoa, the middle or transition period (Diogenes of Seleucia, Boethus of Sidon, Panaetius, Posidonius), and the later Stoicism of Roman times. By the old Stoa is meant the period (c. 304–205 B.C.) down to the death of Chrysippus, the second founder; then was laid the foundation of theory, to which hardly anything of importance was afterwards added. Confined almost to Athens, the school made its way slowly among many rivals. Aristo of Chios and Herillus of Carthage, Zeno's heterodox pupils, Persaeus, his favourite disciple and housemate, the poet Aratus, and Sphaerus, the adviser of the Spartan king Cleomenes, are noteworthy minor names; but the chief interest centres about Zeno, Cleanthes, Chrysippus, who in succession built up the wondrous system. What originality it had—at first sight it would seem not much—belongs to these thinkers; but the loss of all their works except the hymn of Cleanthes, and the inconsistencies in such scraps of information as can be gleaned from unintelligent witnesses, for the most part of many centuries later, have rendered it a peculiarly difficult task to distinguish with certainty the work of each of the three. The common standpoint, the relation to contemporary or earlier systems, with all that goes to make up the character and spirit of Stoicism, can, fortunately, be more certainly established, and may with reason be attributed to the founder.

Zeno's residence at Athens fell at a time when the great movement which Socrates originated had spent itself in the second generation of his spiritual descendants. **Zeno.** Neither Theophrastus at the Lyceum, nor Xenocrates and Polemo at the Academy, nor Stilpo, who was drawing

crowds to hear him at Megara, could be said to have inherited much of the great reformer's intellectual vigour, to say nothing of his moral earnestness. Zeno visited all the schools in turn, but seems to have attached himself definitely to the Cynics; as a Cynic he composed at least one of his more important works, "the much admired *Republic*," which we know to have been later on a stumbling-block to the school. In the Cynic school he found the practical spirit which he divined to be the great need of that stirring troublous age. For a while his motto must have been "back to Socrates," or at least "back to Antisthenes." The Stoics always counted themselves amongst the Socratic schools, and canonized Antisthenes and Diogenes; while reverence for Socrates was the tie which united to them such an accomplished writer upon lighter ethical topics as the versatile Persaeus, who, at the capital of Antigonus Gonatas, with hardly anything of the professional philosopher about him, reminds us of Xenophon, or even Prodicus. Zeno commenced, then, as a Cynic; and in the developed system we can point to a kernel of Cynic doctrine to which various philosophemes of other thinkers (more especially Heraclitus and Aristotle, but also Diogenes of Apollonia, the Pythagoreans, and the medical school of Hippocrates in a lesser degree) were added. Thus, quite apart from the general similarity of their ethical doctrine, the Cynics were materialists; they were also nominalists, and combated the Platonic ideas; in their theory of knowledge they made use of "reason" (*λόγος*), which was also one of their leading ethical conceptions. In all these particulars Zeno followed them, and the last is the more important, because, Chrysippus having adopted a new criterion of truth—a clear and distinct perception of sense—it is only from casual notices we learn that the elder Stoics had approximated to Cynicism in making right reason the standard. At the same time, it is certain that the main outlines of the characteristic physical doctrine, which is after all the foundation of their ethics and logic, were the work of Zeno. The Logos, which had been an ethical or psychological principle to the Cynics, received at his hands an extension throughout the natural world, in which Heraclitean influence is unmistakable. Reading the Ephesian doctrine with the eyes of a Cynic, and the Cynic ethics in the light of Heracliteanism, he came to formulate his distinctive theory of the universe far in advance of either. In taking this immense stride and identifying the Cynic "reason," which is a law for man, with the "reason" which is the law of the universe, Zeno has been compared with Plato, who similarly extended the Socratic "general notion" from the region of morals—of justice, temperance, virtue—to embrace all objects of all thought, the verity of all things that are.

If the recognition of physics and logic as two studies co-ordinate with ethics is sufficient to differentiate the mature Zeno from the Cynic author of the *Republic*, no less than from his own heterodox disciple Aristo, the **Cleanthes.** elaboration on all sides of Stoic natural philosophy belongs to Cleanthes, who certainly was not the merely docile and receptive intelligence he is sometimes represented as being. He carried on and completed the assimilation of Heraclitean doctrine; but his own contributions were more distinctive and original than those of any other Stoic. Zeno's seeming dualism of God (or force) and formless matter he was able to transform into the lofty pantheism which breathes in every line of the famous hymn to Zeus. Heraclitus had indeed declared all to be in flux, but we ask in vain what is the cause for the unceasing process of his ever-living fire. It was left for Cleanthes to discover this motive cause in a conception familiar to Zeno, as to the Cynics before him, but restricted to the region of ethics—the conception of tension or effort. The soul of the sage, thought the Cynics, should be strained and braced for judgment and action; his first need is firmness (*εὐρωμία*) and Socratic strength. But the mind is a corporeal thing. Then followed the flash of genius: this varying tension of the one substance everywhere present, a purely physical fact, accounts for the diverse destinies of all innumerable particular things; it is the veritable cause of the flux and process of the universe.

Herein lies the key to the entire system of the Stoics, as Cleanthes's epoch-making discovery continually received fresh applications to physics, ethics and epistemology. Other of his innovations, the outcome of his crude materialism, found less favour with his successor, who declined to follow him in identifying the primary substance with fire, or in tracing all vitality to its ultimate source in the sun, the "ruling power" of the world—a curious anticipation of scientific truth. Yet under this poetical Heraclitean mystic the school was far from flourishing. The eminent teachers of the time are said to have been Aristo, Zeno's heterodox pupil, and Arcesilas, who in Plato's name brought Megarian subtleties and Pyrrhonian agnosticism to bear upon the intruding doctrine; and after a vigorous upgrowth it seemed not unlikely to die out. From all danger of such a fate it was rescued by its third great teacher, Chrysippus; "but for Chrysippus there had been no Porch."

Zeno had caught the practical spirit of his age—the desire for a popular philosophy to meet individual needs. But there was another tendency in post-Aristotelian thought **Chrysippus.**—to lean upon authority and substitute learning for independent research—which grew stronger just in proportion as the fresh interest in the problems of the universe and the zeal for discovery declined—a shadow, we may call it, of the coming Scholasticism thrown a thousand years in advance. The representative of this tendency, Chrysippus, addressed himself to the congenial task of assimilating, developing, systematizing the doctrines bequeathed to him, and, above all, securing them in their stereotyped and final form, not simply from the assaults of the past, but, as after a long and successful career of controversy and polemical authorship he fondly hoped, from all possible attack in the future. To his personal characteristics can be traced the hair-splitting and formal pedantry which ever afterwards marked the activity of the school, the dry repellent technical procedure of the Dialecticians *par excellence*, as they were called. He created their formal logic and contributed much that was of value to their psychology and epistemology; but in the main his work was to new-label and new-arrange in every department, and to lavish most care and attention on the least important parts—the logical terminology and the refutation of fallacies, or, as his opponents declared, the excogitation of fallacies which even he could not refute. In his *Republic* Zeno had gone so far as to declare the routine education of the day (*e.g.* mathematics, grammar, &c.) to be of no use. Such Cynic crudity Chrysippus rightly judged to be out of keeping with the requirements of a great dogmatic school, and he laboured on all sides after thoroughness, erudition and scientific completeness. In short, Chrysippus made the Stoic system what it was, and as he left it we proceed to describe it.

And first we will inquire, What is philosophy? No idle gratification of curiosity, as Aristotle fabled of his life intellectual (which would be but a disguise for refined pleasure), no theory divorced from practice, no **Conception of Philosophy.** pursuit of science for its own sake, but knowledge so far forth as it can be realized in virtuous action, the learning of virtue by exercise and effort and training. So absolutely is the "rare and priceless wisdom" for which we strive identical with virtue itself that the three main divisions of philosophy current at the time and accepted by Zeno—logic, physics and ethics—are defined as the most generic or comprehensive *virtues*. How otherwise could they claim our attention? Accordingly Aristo, holding to Cynicism when Zeno himself had got beyond it, rejected two of these parts of philosophy as useless and out of reach—a divergence which excluded him from the school, but strictly consistent with his view that ethics alone is scientific knowledge. Of the three divisions logic is the least important; ethics is the outcome of the whole, and historically the all-important vital element; but the foundations of the whole system are best discerned in the science of nature, which deals pre-eminently with the macrocosm and the microcosm, the universe and man, including natural theology

and an anthropology or psychology, the latter forming the direct introduction to ethics.

The Stoic system is in brief: (a) materialism, (b) dynamic materialism, lastly (c) monism or pantheism. (a) The first of these characters is described by anticipation in Plato's *Sophist* (246 C seq.), where, arguing with those **Physics.** "who drag everything down to the corporeal" (σώματα), the Eleatic stranger would fain prove to them the existence of something incorporeal, as follows. "They admit the existence of an animate body. Is soul then something existent (οὐσία)? Yes. And the qualities of soul, as justice and wisdom—are they visible and tangible? No. Do they then exist? They are in a dilemma." Now, however effective against Plato's contemporary Cynics or Atomists, the reasoning is thrown away upon the Stoics, who take boldly the one horn of this dilemma. That qualities of bodies (and therefore of the corporeal soul) exist they do not deny; but they assert most uncompromisingly that they are one and all (wisdom, justice, &c.) corporeal. And they strengthen their position by taking Plato's own definition (247 D), namely "being is that which has the power to act or be acted upon," and turning it against him. For this is only true of Body; action, **Materialism.** except by contact, is inconceivable; and they reduce every form of causation to the efficient cause, which implies the communication of motion from one body to another. Again and again, therefore, only Body exists. The most real realities to Plato and Aristotle had been thought and the objects of thought, νοῦς and νοητά, whether abstracted from sensibles or inherent in "matter," as the incognizable basis of all concrete existence. But this was too great an effort to last long. Such spiritualistic theories were nowhere really maintained after Aristotle and outside the circle of his immediate followers. The reaction came and left nothing of it all; for five centuries the dominant tone of the older and the newer schools alike was frankly materialistic. "If," says Aristotle, "there is no other substance but the organic substances of nature, physics will be the highest of the sciences," a conclusion which passed for axiomatic until the rise of Neoplatonism. The analogues therefore of metaphysical problems must be sought in physics; particularly that problem of the causes of things for which the Platonic idea and the Peripatetic "constitutive form" had been, each in its turn, received solutions. (b) **Tension.** But the doctrine that all existence is confined within the limits of the sensible universe—that there is no being save corporeal being or body—does not suffice to characterize the Stoic system; it is no less a doctrine of the Epicureans. It is the idea of tension or tonicity as the essential attribute of body, in contradistinction to passive inert matter, which is distinctively Stoic. The Epicureans leave unexplained the primary constitution and first movements of their atoms or elemental solids; chance or declination may account for them. Now, to the Stoics nothing passes unexplained; there is a reason (λόγος) for everything in nature. Everything which exists is at once capable of acting and being acted upon. In everything that exists, therefore, even the smallest particle, there are these two principles. By virtue of the passive principle the thing is susceptible of motion and modification; it is matter which determines substance (οὐσία). The active principle makes the matter a given determinate thing, characterizing and qualifying it, whence it is termed quality (ποιότης). For all that is or happens there is an immediate cause or antecedent; and as "cause" means "cause of motion," and only body can act upon body, it follows that this antecedent cause is itself as truly corporeal as the matter upon which it acts. Thus we are led to regard the active principle "force" as everywhere co-extensive with "matter," as pervading and permeating it, and together with it occupying and filling space. This is that famous doctrine of universal permeation (κράσις δι' ὅλου), by which the axiom that two bodies cannot occupy the same space is practically denied. Thus that harmony of separate doctrines which contributes to the impressive simplicity of the Stoic physics is only attained at the cost of offending healthy common

sense, for Body itself is robbed of a characteristic attribute. A thing is no longer, as Plato once thought, hot or hard or bright by partaking in abstract heat or hardness or brightness, but by containing within its own substance the material of these qualities, conceived as air-currents in various degrees of tension. We hear, too, of corporeal days and years, corporeal virtues, and actions (like walking) which are bodies (*σώματα*). Obviously, again, the Stoic quality corresponds to Aristotle's essential form; in both systems the active principle, "the cause of all that matter becomes," is that which accounts for the existence of a given concrete thing (*λόγος τῆς οὐσίας*). Only here, instead of assuming something immaterial (and therefore unverifiable), we fall back upon a current of air or gas (*πνεῦμα*); the essential reason of the thing is itself material, standing to it in the relation of a gaseous to a solid body. Here, too, the reason of things—that which accounts for them—is no longer some external end to which they are tending; it is something acting within them, "a spirit deeply interfused," germinating and developing as from a seed in the heart of each separate thing that exists (*λόγος σπερματικός*). By its prompting the thing grows, develops and decays, while this "germinal reason," the element of quality in the thing, remains constant through all its changes. (c) What then, we ask, is the relation between

Matter and Force. the active and the passive principles? Is there, or is there not, an essential distinction between substance or matter and pervading force or cause or quality? Here the Stoa shows signs of a development of doctrine. Zeno began, perhaps, by adopting the formulas of the Peripatetics, though no doubt with a conscious difference, postulating that form was always attached to matter, no less than matter, as known to us, is everywhere shaped or informed. Whether he ever overcame the dualism, which the sources, such as they are, unanimously ascribe to him is not clearly ascertained. It seems probable that he did not. But we can answer authoritatively that to Cleanthes and Chrysippus, if not to Zeno, there was no real difference between matter and its cause, which is always a corporeal current, and

Monism. therefore matter, although the finest and subtlest matter. In fact they have reached the final result of unveiled hylozoism, from which the distinction of the active and passive principles is discerned to be a merely formal concession to Aristotle, a legacy from his dualistic doctrine. His technical term Form (*εἶδος*) they never use, but always Reason or God. This was not the first time that approaches had been made to such a doctrine, and Diogenes of Apollonia in particular was led to oppose Anaxagoras, who distinguished Nous or Thought from every other agent within the cosmos which is its work by postulating as his first principle something which should be at once physical substratum and thinking being. But until dualism had been thought out, as in the Peripatetic school, it was impossible that monism (or at any rate materialistic monism) should be definitely and consciously maintained. One thing is certain: the Stoics provided no loophole of escape by entrenching upon the "purely material" nature of matter; they laid down with rigid accuracy its two chief properties—extension in three dimensions, and resistance, both being traced back to force. There were, it is true, certain inconsistent conceptions, creations of thought to which nothing real and external corresponded, namely, time, space, void, and the idea expressed in language (*λεκτόν*). But this inconsistency was covered by another: though each of these might be said to be something, they could not be said to exist.

The distinction of force and matter is then something transitory and relative. Its history will serve as a sketch of the cosmogony of the Stoics, for they too, like earlier philosophers, have their "fairy tales of science." Before there was heaven or earth, there was primitive substance or Pneuma, the everlasting presupposition of particular things. This is the totality of all existence; out of it the whole visible universe proceeds, hereafter to be again resolved into it. Not the less is it the creative force, or deity, which develops and shapes this universal order or cosmos. To the question, What is God? Stoicism rejoins, What is God not? In this original state of Pneuma God and the world are absolutely identical. But even then tension, the essential

attribute of matter, is at work. Though the force working everywhere is one, there are diversities of its operation, corresponding to various degrees of tension. In this primitive Pneuma there must reside the utmost tension and heat; for it is a fact of observation that most bodies expand when heated, whence we infer that there is a pressure in heat, an expansive and dispersive tendency. The Pneuma cannot long withstand this intense pressure. Motion backwards and forwards once set up goes to cool the glowing mass of fiery vapour and to weaken the tension. Hereupon follows the first differentiation of primitive substance—the separation of force from matter, the emanation of the world from God. The germinal world-making powers (*σπερματικοὶ λόγοι*), which, in virtue of its tension, slumbered in Pneuma, now proceed upon their creative task. The primitive substance, be it remembered, is not Heraclitus's fire (though Cleanthes also called it flame of fire, *φλόξ*) any more than it is the air or "breath" of Anaximenes or Diogenes of Apollonia. Chrysippus determined it, following Zeno, to be fiery breath or ether, a spiritualized sublimed intermediate element. The cycle of its transformations and successive condensations constitutes the life of the universe, the mode of existence proper to finite and particular being. For the universe and all its parts are only different embodiments and stages in that metamorphosis of primitive being which Heraclitus had called a progress up and down (*ὁδὸς ἄνω κάτω*). Out of it is separated, first, elemental fire, the fire which we know, which burns and destroys; and this, again, condenses into air or aerial vapour; a further step in the downward path derives water and earth from the solidification of air. At every stage the degree of tension requisite for existence is slackened, and the resulting element approaches more and more to "inert" matter. But, just as one element does not wholly pass over into another (e.g. only a part of air is transmuted into water or earth), so the Pneuma itself does not wholly pass over into the elements. The residue that remains in original purity with its tension yet undiminished is the ether in the highest sphere of the visible heavens, encircling the world of which it is lord and head. From the elements the one substance is transformed into the multitude of individual things in the orderly universe, which again is itself a living thing or being, and the Pneuma pervading it, and conditioning life and growth everywhere, is its soul. But this process of differentiation is not eternal; it continues only until the times of the restoration of all things. For the world which has grown up will in turn decay. The tension which has been relaxed will again be tightened; there will be a gradual resolution of things into elements, and of elements into the primary substance, to be consummated in a general conflagration when once more the world will be absorbed in God. Then in due order a new cycle of development begins, reproducing the last in every minutest detail, and so on for ever.

The doctrine of Pneuma, vital breath or "spirit," arose in the medical schools. The simplest reflection among savages and half-civilized men connects vitality with the air inhaled in **Pneuma** respiration; the disciples of Hippocrates, without much modifying this primitive belief, explained the maintenance of vital warmth to be the function of the breath within the organism. In the time of Alexander the Great Praxagoras discovered the distinction between the arteries and the veins. Now in the corpse the former are empty; hence, in the light of these preconceptions they were declared to be vessels for conveying Pneuma to the different parts of the body. A generation afterwards Erasistratus made this the basis of a new theory of diseases and their treatment. Vital spirit, inhaled from the outside air, rushes through the arteries till it reaches the various centres, especially the brain and the heart, and there causes thought and organic movement. But long before this the peculiar character of air had been recognized as something intermediate to the corporeal and the incorporeal: when Diogenes of Apollonia revived the old Ionian hylozoism in opposition to the dualism of Anaxagoras, he made this, the typical example of matter in the gaseous state, his one element. In Stoicism, for the moment, the two conceptions are united, soon, however, to diverge—the medical conception to receive its final development under Galen, while the philosophical conception, passing over to Philo and others, was shaped and modified at Alexandria under the influence of Judaism, whence it played a great part in the developments of Jewish and Christian theology.

The influence upon Stoicism of Heraclitus has been differently conceived. Siebeck would reduce it within very small dimensions, but this is not borne out by the concise history found at **Contrast to Heraclitus.** Heracleum (*Index herc.*, ed. Comparetti, col. 4 seq.). They substituted primitive Pneuma for his primitive fire, but so far as they are hylozoists at all they stand upon the same ground with him. Moreover, the commentaries of Cleanthes, Aristo and Sphaerus on Heraclitean writings (Diog. Laër. vii. 174, ix. 5, 15) point to common study of these writings under Zeno. Others again (e.g. Lassalle) represent the Stoics as merely diluting and distorting Heracliteanism. But this is altogether wrong, and the proofs offered, when rightly sifted, are often seen to rest upon the distortion of Heraclitean doctrine in the reports of later writers, to assimilate it to the better known but essentially distinct innovations of the Stoics. In Heraclitus the constant flux is a metaphysical notion replaced by the interchange of material

elements which Chrysippus stated as a simple proposition of physics. Heraclitus offers no analogy to the doctrine of four (not three) elements as different grades of tension; to the conception of fire and air as the "form," in Aristotelian terminology, of particulars; nor to the function of organizing fire which works by methodic plan to produce and preserve the world (πῦρ τεχνικὸν ὁδῶ βαδίζον ἐπὶ γένεσιν κόσμου). Nor, again, is there any analogy to the peculiar Stoic doctrine of universal intermingling (κράσις δι' ὅλου). The two active elements interpenetrate the two lower or more relaxed, winding through all parts of matter and so pervading the greater masses that there is no mechanical mixture, nor yet a chemical combination, since both "force" and "matter" retain their relative characters as before. Even the distinction between "force" and "matter"—so alien to the spirit of Heraclitus—is seen to be a necessary consequence. Once assume that every character and property of a particular thing is determined solely by the tension in it of a current of Pneuma, and (since that which causes currents in the thing cannot be absolutely the same with the thing itself) Pneuma, though present in all things, must be asserted to vary indefinitely in quantity and intensity. So condensed and coarsened is the indwelling air-current of inorganic bodies that no trace of elasticity or life remains; it cannot even afford them the power of motion; all it can do is to hold them together (συνεκτικὴ δύναμις), and, in technical language, Pneuma is present in stone or metal as a retaining principle (ἔξις=hold), explaining the attributes of continuity and numerical identity (συνεχῆ καὶ ἡνωμένα) which even these natural substances possess. In plants again and all the vegetable kingdom it is manifest as something far purer and possessing greater tension, called a "nature," or principle of growth (φύσις). Further, a distinction was drawn between irrational animals, or the brute creation, and the rational, *i.e.* gods and men, leaving room for a divergence, or rather development, of Stoic opinion. The older authorities conceded a vital principle, but denied a soul, to the brutes: animals, they say, are ζῷα but not ἔμψυχα. Later on much evidence goes to show that (by a divergence from the orthodox standard perhaps due to Platonic influence) it was a Stoic tenet to concede a soul, though not a rational soul, throughout the animal kingdom. To this higher manifestation of Pneuma can be traced back the "esprits animaux" of Descartes and Leibnitz, which continue to play so great a part even in Locke. The universal presence of Pneuma was confirmed by observation. A certain warmth, akin to the vital heat of organic being, seems to be found in inorganic nature: vapours from the earth, hot springs, sparks from the flint, were claimed as the last remnant of Pneuma not yet utterly slackened and cold. They appealed also to the velocity and dilatation of aeriform bodies, to whirlwinds and inflated balloons. The Logos is quick and powerful, and sharper than any two-edged sword, piercing even to the dividing asunder of the joints and marrow. Tension itself Cleanthes defined as a fiery stroke (πληγὴ πυρός); in his hymn to Zeus lightning is the symbol of divine activity. Take the fundamental properties of body—extension and resistance. The former results from distance; but distances, or dimensions, are straight lines, *i.e.* lines of greatest tension (εἰς ἄκρον τεταμένη). Tension produces dilatation, or increase in distance. Resistance, again, is explained by cohesion, which implies binding force. Again, the primary substance has rectilinear motion in two directions, backwards and forwards, at once a condensation, which produces cohesion and substance, and a dilatation, the cause of extension and qualities. How near this comes to the scientific truth of attraction and repulsion need hardly be noted. From the astronomers the Stoics borrowed their picture of the universe—a *plenum* in the form of a series of layers or concentric rings, first the elements, then the planetary and stellar spheres, massed round the earth as centre—a picture which dominated the imagination of men from the days of Eudoxus down to those of Dante or even Copernicus. As to the physical constitution of bodies, they were content to reproduce the Peripatetic doctrine with slight modifications in detail, of hardly any importance when compared with the change of spirit in the doctrine taught. But they rarely prosecuted researches in physics or astronomy, and the newly created sciences of biology and comparative anatomy received no adequate recognition from them.

If, however, in the science of nature the Stoics can lay claim to no striking originality, the case is different when we come to the science of man. In the rational creatures—

Psychology. man and the gods—Pneuma is manifested in a high degree of purity and intensity as an emanation from the world-soul, itself an emanation from the primary substance of purest ether—a spark of the celestial fire, or, more accurately, fiery breath, which is a mean between fire and air, characterized by vital warmth more than by dryness. The physical basis of Stoic psychology deserves the closest attention. On the one hand, soul is corporeal, else it would have no real existence, would be incapable of extension in three dimensions (and therefore of equable diffusion all over the body), incapable of holding the body together, as the Stoics contended

that it does, herein presenting a sharp contrast to the Epicurean tenet that it is the body which confines and shelters the light vagrant atoms of soul. On the other hand, this corporeal thing is veritably and identically reason, mind, and ruling principle (λόγος, νοῦς, ἡγεμονικόν); in virtue of its divine origin Cleanthes can say to Zeus, "We too are thy offspring," and a Seneca can calmly insist that, if man and God are not on perfect equality, the superiority rests rather on our side. What God is for the world that the soul is for man. The Cosmos must be conceived as a single whole, its variety being referred to varying stages of condensation in Pneuma. So, too, the human soul must possess absolute simplicity, its varying functions being conditioned by the degrees or species of its tension. It follows that of "parts" of the soul, as previous thinkers imagined, there can be no question; all that can consistently be maintained is that from the centre of the body—the heart—seven distinct air-currents are discharged to various organs, which are so many modes of the one soul's activity.¹ The ethical consequences of this position will be seen at a later stage. With this psychology is intimately connected the Stoic theory **Theory of Knowledge.** From the unity of soul it follows that all psychical processes—sensation, assent, impulse—proceed from reason, the ruling part; that is to say, there is no strife or division: the one rational soul alone has sensations, assents to judgments, is impelled towards objects of desire just as much as it thinks or reasons. Not that all these powers at once reach full maturity. The soul at first is void of content; in the embryo it has not developed beyond the nutritive principle of a plant (φύσις): at birth the "ruling part" is a blank tablet, although ready prepared to receive writing. This excludes all possibility of innate ideas or any faculty akin to intuitive reason. The source of all our knowledge is experience and discursive thought, which manipulates the materials of sense. Our ideas are copied from stored-up sensations. No other theory was possible upon the foundation of the Stoic physics.

Note the parallel between the macrocosm and the microcosm. The soul of the world fills and penetrates it: in like manner the human soul pervades and breathes through all the body, informing and guiding it, stamping the man with his essential character of rational. There is in both alike a ruling part, though this is situate in the human heart at the centre—not in the brain, as the analogy of the celestial ether would suggest. Finally, the same cause, a relaxation of tension, accounts for sleep, decay and death of man and for the dissolution of the world; after death the disembodied soul can only maintain its separate existence, even for a limited time, by mounting to that region of the universe which is akin to its nature. It was a moot point whether all souls so survive, as Cleanthes thought, or the souls of the wise and good alone, which was the opinion of Chrysippus; in any case, sooner or later individual souls are merged in the soul of the universe, from which they proceeded. The relation of the soul of the universe to God is quite clear: it is an inherent property, a mode of His activity, an effluence or emanation from the fiery ether which surrounds the universe, penetrating and permeating it. A Stoic might consistently maintain that World-Soul, Providence, Destiny and Germinal Reason are not mere synonyms, for they express different aspects of God, different relations of God to things. We find ourselves on the verge of a system of abstractions, or "attributes turned into entities," as barren as any exogitated in medieval times. In a certain sense, Scholasticism began with Chrysippus. To postulate different substances as underlying the different forces of nature would have been to surrender the fundamental thought of the system. What really is—the Pneuma—neither increases nor diminishes; but its modes of working, its different currents, can be conveniently distinguished and enumerated as evidence of so many distinct attributes.

One inevitable consequence of materialism is that subject and object can no longer be regarded as one in the act of perception, as Plato and Aristotle tended to assume, however imperfectly the assumption was carried out. The presumption of some merely external connexion, as between any other two corporeal things, is alone admissible and some form of the

¹ These derivative powers include the five senses, speech and the reproductive faculty, and they bear to the soul the relation of qualities to a substance. The ingenious essay of Mr R. D. Archer Hind on the Platonic psychology (*Journ. of Phil.* x. 120) aims at establishing a parallel unification on the spiritualistic side; cf. *Rep.* x. 612 A.

representative hypothesis is most easily called in to account for perception. The Stoics explained it as a transmission of the perceived quality of the object, by means of the sense organ, into the percipient's mind, the quality transmitted appearing as a disturbance or impression upon the corporeal surface of that "thinking thing," the soul. Sight is taken as the typical sense. A conical pencil of rays diverges from the pupil of the eye, so that its base covers the object seen. In sensation a presentation is conveyed, by an air-current, from the sense organ, here the eye, to the mind, *i.e.* the soul's "ruling part" in the breast; the presentation, besides attesting its own existence, gives further information of its object—visible colour or size, or whatever be the quality in the thing seen. That Zeno and Cleanthes crudely compared this presentation to the impression which a seal bears upon wax, with protuberances and indentations, while Chrysippus more prudently determined it vaguely as an occult modification or "mode" of mind, is an interesting but not intrinsically important detail. But the mind is no mere passive recipient of impressions from without, in the view of the Stoics. Their analysis of sensation supposes it to react, by a variation in tension, against the current from the sense-organ; and this is the mind's assent or dissent, which is inseparable from the sense presentation. The contents of experience are not all alike true or valid: hallucination is possible; here the Stoics join issue with Epicurus. It is necessary, therefore, that assent should not be given indiscriminately; we must determine a criterion of truth, a special formal test whereby reason may recognize the merely plausible and hold fast the true. In an earlier age such an inquiry would have seemed superfluous. To Plato and Aristotle the nature and operation of thought and reason constitute a sufficient criterion. Since their day not only had the opposition between sense and reason broken down, but the reasoned scepticism of Pyrrho and Arcesilaus had made the impossibility of attaining truth the primary condition of well-being. Yet the standard which ultimately found acceptance in the Stoic school was not put forward, in that form, by its founder. Zeno, we have reason to believe, adopted the Cynic Logos for his guidance to truth as well as to morality. As a disciple of the Cynics he must have started with a theory of knowledge somewhat like that developed in the third part of Plato's *Theaetetus* (201 C seq.)—that simple ideas are given by sense, whereas "opinion," which is a complex of simple ideas, only becomes knowledge when joined with Logos. We may further suppose that the more obvious of Plato's objections had led to the correction of "reason" into "right reason." However that may be, it is certain from Aristotle (*Nic. Eth.* vi. 13, 1144b, 17) that virtue was defined as a "habit" in accordance with right reason, and from Diog. Laër. vii. 54 that the earlier Stoics made right reason the standard of truth. The law which regulates our action is thus the ultimate criterion of what we know—practical knowledge being understood to be of paramount importance. But this criterion was open to the persistent attacks of Epicureans and Academics, who made clear (1) that reason is dependent upon, if not derived from, sense, and (2) that the utterances of reason lack consistency. Chrysippus, therefore, conceded something to his opponents when he substituted for the Logos the new standards of sensation (*αἰσθησις*) and general conception (*πρόληψις* = anticipation, *i.e.* the generic type formed in the mind unconsciously and spontaneously). At the same time he was more clearly defining and safeguarding his predecessors' position. For reason is consistent in the general conceptions wherein all men agree, because in all alike they are of spontaneous growth. Nor was the term sensation sufficiently definite. The same Chrysippus fixed upon a certain characteristic of true presentations, which he denoted by the much disputed term "apprehensive" (*καταληπτικὴ φαντασία*).

Criterion of Truth.

Provided the sense organ and the mind be healthy, provided an external object be really seen or heard, the presentation, in virtue of its clearness and distinctness, has the power to extort the assent which it always lies in our power to give or to withhold.

Formerly this technical phrase was explained to mean "the perception which irresistibly compels the subject to assent to it as true." But this, though apparently supported by Sextus Empiricus (*Adv. Math.* vii. 257), is quite erroneous; for the presentation is called *καταληπτόν*, as well as *καταληπτικὴ φαντασία*, so that beyond all doubt it is something which the percipient subject grasps, and not that which grasps or "lays hold of" the percipient. Nor, again, is it wholly satisfactory to explain *καταληπτικὴ* as virtually passive, "apprehensible," like its opposite *ἀκατάληπτος*; for we find *ἀντιληπτικὴ τῶν ὑποκειμένων* used as an alternative phrase (*ibid.* vii. 248). It would seem that the perception intended to constitute the standard of truth is one which, by producing a mental counterpart of a really existent external thing, enables the percipient, in the very act of sense, to "lay hold of" or apprehend an object in virtue of the presentation or sense impression of it excited in his own mind. The reality of the external object is a necessary condition, to exclude hallucinations of the senses; the exact correspondence between the external object and the internal percept is also necessary, but naturally hard to secure, for how can we compare the two? The external object is known only in perception. However, the younger Stoics endeavoured to meet the assaults of their persistent critic Carneades by suggesting various modes of testing a single

presentation, to see whether it were consistent with others, especially such as occurred in groups, &c.; indeed, some went so far as to add to the definition "coming from a real object and exactly corresponding with it" the clause "provided it encounter no obstacle."

The same criterion was available for knowledge derived more directly from the intellect. Like all materialists, the Stoics can only distinguish the sensible from the intelligible as thinking when the external object is present (*αἰσθάνεσθαι*) *Degrees of Knowledge*, and thinking when it is absent (*ἐννοεῖν*). The product of the latter kind includes memory (though this is, upon a strict analysis, something intermediate), and conceptions or general notions, under which were confusedly classed the products of the imaginative faculty. The work of the mind is seen first in "assent"; if to a true presentation the result is "simple apprehension" (*κατάληψις*; this stands in close relation to the *καταληπτικὴ φαντασία*, of which it is the necessary complement); if to a false or unapprehensive presentation, the result is "opinion" (*δόξα*), always deprecated as akin to error and ignorance, unworthy of a wise man. These processes are conceivable only as "modes" of mind, changes in the soul's substance, and the same is true of the higher conceptions, the products of generalization. But the Stoics were not slow to exalt the part of reason, which seizes upon the generic qualities, the essential nature of things. Where sense and reason conflict, it is the latter that must decide. One isolated "apprehension," however firm its grasp, does not constitute knowledge or science (*ἐπιστήμη*); it must be of the firmest, such as reason cannot shake, and, further, it must be worked into a system of such apprehensions which can only be by the mind's exercising the "habit" (*ἔξις*) of attaining truth by continuous tension. Here the work of reason is assimilated to the force which binds together the parts of an inorganic body and resists their separation. There is nothing more in the order of the universe than extended mobile bodies and forces in tension in these bodies. So, too, in the order of knowledge there is nothing but sense and the force of reason maintaining its tension and connecting sensations and ideas in their proper sequence. Zeno compared sensation to the outstretched hand, flat and open; bending the fingers was assent; the clenched fist was "simple apprehension," the mental grasp of an object; knowledge was the clenched fist tightly held in the other hand. The illustration is valuable for the light it throws on the essential unity of diverse intellectual operations as well as for enforcing once more the Stoic doctrine that different grades of knowledge are different grades of tension. Good and evil, virtues and vices, remarks Plutarch, are all capable of being "perceived"; sense, this common basis of all mental activity, is a sort of touch by which the ethereal Pneuma which is the soul's substance recognizes and measures tension.

With this exposition we have already invaded the province of logic. To this the Stoics assigned a miscellany of studies—rhetoric, dialectic, including grammar, in addition to formal *Logic*. Logic—to all of which their industry made contributions. Some of their innovations in grammatical terminology have lasted until now: we still speak of oblique cases, genitive, dative, accusative, of verbs active (*ὀρθά*), passive (*ἑπτα*), neuter (*ὀβδέτερα*), by the names they gave. Their corrections and fancied improvements of the Aristotelian logic are mostly useless and pedantic. Judgment (*δέξιμα*) they defined as a complete idea capable of expression in language (*λεκτὸν ἀποτελές*), and to distinguish it from other enunciations, as a wish or a command, they added "which is either true or false." From simple judgments they proceeded to compound judgments, and declared the hypothetical syllogism to be the normal type of reason, of which the categorical syllogism is an abbreviation. Perhaps it is worth while to quote their treatment of the categories. Aristotle made ten, all co-ordinate, to serve as "heads of predication" under which to collect distinct scraps of information respecting a subject, probably a man. For this the Stoics substituted four *summa genera*, all subordinate, so that each in turn is more precisely determined by the next. They are something, or Being, determined as (1) substance or subject matter, (2) essential quality, *i.e.* substance qualified, (3) mode or chance attribute, *i.e.* qualified substance in a certain condition (*πως ἔχον*), and, lastly, (4) relation or relative mode (in full *ὑποκειμένον ποῦν πρὸς τί πως ἔχον*). The zeal with which the school prosecuted logical inquiries had one practical result—they could use to perfection the unrivalled weapon of analysis. Its chief employment was to lay things bare and sever them from their surroundings, in order that they might be contemplated in their simplicity, with rigid exactness, as objects of thought, apart from the illusion and exaggeration that attends them when presented to sense and imagination. The very perfection and precision of this method constantly tempted the later Stoics to abuse it for the systematic depreciation of the objects analysed.

The ethical theory of the Stoics stands in the closest connexion with their physics, psychology and cosmology. A critical account of it will be found in the article *ETHICS*. It may be briefly summarized here. Socrates had rightly said that Virtue is Knowledge, but he had not definitely shown in what this knowledge consists, nor had his immediate successors, the Cynics, made any serious attempt to solve the difficulty. The Stoics not only drew up an elaborate scheme of duties, but also crystallized their theory in a general law, namely that true goodness

lies in the knowledge of nature and is obtained by the exercise of Reason. The most elementary part of nature is pure ether, which is possessed of divine reason. This Reason even non-rational man unconsciously manifests in his mechanical or instinctive actions which tend to the preservation of himself. The truly wise man will therefore live as much as possible in conformity with nature, (*i.e.* nature uncorrupted by the errors of society), and, though as an individual and part of the whole not master of his fate, will yet have self-control even in the midst of misfortune and pain. All evil passion is due to erroneous judgment and morbid conditions of mind which may be divided into chronic ailments (*νοσήματα*) and infirmities (*ἀρρωστήματα*), *i.e.* into permanent or temporary disorders. In contrast to the Cyrenaics and the Epicureans, the Stoics denied that pleasure is actually or ought to be the object of human activity. The non-rational man aims at self-preservation, and the wise man will imitate him deliberately, and when he fails he will suffer with equanimity. To him the so-called "goods" (*e.g.* health, wealth, &c.) are "indifferent" (*ἀδιάφορα*); since he must live, he will exercise his reasoning faculty upon them, and will regard some as "preferred" (*προηγμένα*) and others as to be "rejected" (*ἀποπροηγμένα*), but he will not regard either class as possessed of an intrinsic value. The end of action is, therefore, a harmonious consistent life "according to nature" and (*cf.* Heraclitus) an ordered unity of action. Virtue is its own good; the highest exercise of reason is its own perfection. It follows (1) that pleasure, being quite outside the pale is not the object but merely an *ἐπιγέννημα* (accompaniment) of virtuous action, and (2) that there is, within the circle of virtue, no degree. An action is simply virtuous or not; it cannot be more or less virtuous. The result of this theory of ethics is of great value as emphasizing the importance of a systematic view of conduct, but it fails to resolve satisfactorily the great Socratic paradox that evil is the result of ignorance. For even though they attempt to substantiate the idea of responsibility by maintaining that ignorance is voluntary, they cannot find any answer to the question whether some men may not be without the capacity to choose learning (but see ETHICS: *History*, § Stoics).

In their view of man's social relations the Stoics are greatly in advance of preceding schools. We saw that virtue is a law which governs the universe: that which Reason and God ordain must be accepted as binding upon the particle of reason which is in each one of us. Human law comes into existence when men recognize this obligation; justice is therefore natural and not something merely conventional. The opposite tendencies, to allow to the individual responsibility and freedom, and to demand of him obedience to law, are both features of the system; but in virtue even of the freedom which belongs to him *qua* rational, he must recognize the society of rational beings of which he is a member, and subordinate his own ends to the ends and needs of this society. Those who own one law are citizens of one state, the city of Zeus, in which men and gods have their dwelling. In that city all is ordained by reason working intelligently, and the members exist for the sake of one another; there is an intimate connexion (*συμπάθεια*) between them which makes all the wise and virtuous friends, even if personally unknown, and leads them to contribute to one another's good. Their intercourse should find expression in justice, in friendship, in family and political life. But practically the Stoic philosopher always had some good excuse for withdrawing from the narrow political life of the city in which he found himself. The circumstances of the time, such as the decay of Greek city-life, the foundation of large territorial states under absolute Greek rulers which followed upon Alexander's conquests, and afterwards the rise of the world-empire of Rome, aided to develop the leading idea of Zeno's *Republic*. There he had anticipated a state without family life, without law courts or coins, without schools or temples, in which all differences of nationality would be merged in the common brotherhood of man. This cosmopolitan citizenship remained all through a distinctive Stoic dogma; when first announced it must have had a powerful influence upon the minds of men, diverting them from the distractions of almost parochial politics to a boundless vista. There was, then, no longer any difference between Greek and barbarian, between male and female, bond and free. All are members of one body as partaking in reason, all are equally men. Not that this led to any movement for the abolition of slavery. For the Stoics attached but slight importance to external circumstances, since only the wise man is really free, and all the

unwise are slaves. Yet, while they accepted slavery as a permanent institution, philosophers as wide apart as Chrysippus and Seneca sought to mitigate its evils in practice, and urged upon masters humanity in the treatment of their slaves.

The religious problem had peculiar interest for the school which discerned God everywhere as the ruler and upholder, and at the same time the law, of the world that **Religion.** He had evolved from Himself. The physical ground-work lends a religious sanction to all moral duties, and Cleanthes's noble hymn is evidence how far a system of natural religion could go in providing satisfaction for the cravings of the religious temper:—

"Most glorious of immortals, O Zeus of many names, almighty and everlasting, sovereign of nature, directing all in accordance with law, thee it is fitting that all mortals should address. . . . Thee all this universe, as it rolls circling round the earth, obeys wheresoever thou dost guide, and gladly owns thy sway. Such a minister thou holdest in thy invincible hands—the two-edged, fiery, ever-living thunderbolt, under whose stroke all nature shudders. No work upon earth is wrought apart from thee, lord, nor through the divine ethereal sphere, nor upon the sea; save only whatsoever deeds wicked men do in their own foolishness. Nay, thou knowest how to make even the rough smooth, and to bring order out of disorder; and things not friendly are friendly in thy sight. For so hast thou fitted all things together, the good with the evil, that there might be one eternal law over all. . . . Deliver men from fell ignorance. Banish it, father, from their soul, and grant them to obtain wisdom, whereon relying thou rulest all things with justice."

To the orthodox theology of Greece and Rome the system stood in a twofold relation, as criticism and rationalism. That the popular religion contained gross errors hardly needed to be pointed out. The forms of worship were known to be trivial or mischievous, the myths unworthy or immoral. But Zeno declared images, shrines, temples, sacrifices, prayers and worship to be of no avail. A really acceptable prayer, he taught, can only have reference to a virtuous and devout mind; God is best worshipped in the shrine of the heart by the desire to know and obey Him. At the same time the Stoics felt at liberty to defend and uphold the truth in polytheism. Not only is the primitive substance God, the one supreme being, but divinity must be ascribed to His manifestations—to the heavenly bodies, which are conceived, like Plato's created gods, as the highest of rational beings, to the forces of nature, even to deified men; and thus the world was peopled with divine agencies. Moreover, the myths were rationalized and allegorized, which was not in either case an original procedure. The search for a deeper hidden meaning beside the literal one had been begun by Democritus, Empedocles, the Sophists and the Cynics. It remained for Zeno to carry this to a much greater extent and to seek out or invent "natural principles" (*λόγοι φυσικοί*) and moral ideas in all the legends and in the poetry of Homer and Hesiod. In this sense he was the pattern if not the "father" of all such as allegorize and reconcile. Etymology was pressed into the service, and the wildest conjectures as to the meaning of names did duty as a basis for mythological explanations. The two favourite Stoic heroes were Hercules and Ulysses, and nearly every scene in their adventures was made to disclose some moral significance. Lastly, the practice of divination and the consultation of oracles afforded a means of communication **Divination.** between God and man—a concession to popular beliefs which may be explained when we reflect that to the faithful divination was something as essential as confession and spiritual direction to a devout Catholic now, or the study and interpretation of Scripture texts to a Protestant. Chrysippus did his best to reconcile the superstition with his own rational doctrine of strict causation. Omens and portents, he explained, are the natural symptoms of certain occurrences. There must be countless indications of the course of Providence, for the most part unobserved, the meaning of only a few having become known to men. His opponents argued, "if all events are foreordained, divination is superfluous"; he replied that both divination and our behaviour under the warnings which

it affords are included in the chain of causation. Even here, however, the bent of the system is apparent. They were at pains to insist upon purity of heart and life as an indispensable condition for success in prophesying and to enlist piety in the service of morality.

When Chrysippus died (Ol. 143 = 208-204 B.C.) the structure of Stoic doctrine was complete. With the Middle Stoa we enter upon a period at first of comparative inaction, afterwards of internal reform. Chrysippus's immediate successors were Zeno of Tarsus, Diogenes of Seleucia (often called the Babylonian) and Antipater of Tarsus, men of no originality, though not without ability; the two last-named, however, had all their energies taxed to sustain the conflict with Carneades (*q.v.*). This was the most formidable assault the school ever encountered; that it survived was due more to the foresight and elaborate precautions of Chrysippus than to any efforts of that "pen-doughty" pamphleteer, Antipater (*καλαμοβόας*), who shrank from opposing himself in person to the eloquence of Carneades. The subsequent history testified to the importance of this controversy. The special objects of attack were the Stoic theory of knowledge, their theology and their ethics. The physical basis of the system remained unchanged but neglected; all creative force or even original research in the departments of physics and metaphysics vanished. Yet problems of interest bearing upon psychology and natural theology continued to be discussed. Thus the cycles of the world's existence, and the universal conflagration which terminates each of them, excited some doubt. Diogenes of Seleucia is said to have wavered in his belief at last; Boethus, one of his pupils, flatly denied it. He regarded the Deity as the guide and upholder of the world, watching over it from the outside, not as the immanent soul within it, for according to him the world was as soulless as a plant. We have here a compromise between Zeno's and Aristotle's doctrines. But in the end the universal conflagration was handed down without question as an article of belief. It is clear that the activity of these teachers was chiefly directed to ethics: they elaborated fresh definitions of the chief good, designed either to make yet clearer the sense of the formulas of Chrysippus or else to meet the more urgent objections of the New Academy. Carneades had emphasized one striking apparent inconsistency: it had been laid down that to choose what is natural is man's highest good, and yet the things chosen, the "first objects according to nature," had no place amongst goods. Antipater may have met this by distinguishing "the attainment" of primary natural ends from the activity directed to their attainment (Plut. *De Comm. Not.* 27, 14, p. 1072 F); but, earlier still, Diogenes had put forward his gloss, viz. "The end is to calculate rightly in the selection and rejection of things according to nature." Archedemus, a contemporary of Diogenes, put this in plainer terms still: "The end is to live in the performance of all fitting actions" (*πάντα τὰ καθήκοντα ἐπιτελοῦντας ζῆν*). Now it is highly improbable that the earlier Stoics would have sanctioned such interpretations of their dogmas. The mere performance of relative or imperfect duties, they would have said, is something neither good nor evil; the essential constituents of human good is ignored. And similar criticism is actually passed by Posidonius: "This is not the end, but only its necessary concomitant; such a mode of expression may be useful for the refutation of objections put forward by the Sophists" (Carneades and the New Academy?), "but it contains nothing of morality or well-being" (Galen, *De Plac. Hipp. et Plat.* p. 470 K). There is every ground, then, for concluding that we have here one concession extorted by the assaults of Carneades. For a similar compromise there is express testimony: "good repute" (*εὐδοξία*) had been regarded as a thing wholly indifferent in the school down to and including Diogenes. Antipater was forced to assign to it "positive value," and to give it a place amongst "things preferred" (Cic. *De fin.* iii. 57). These modifications were retained by Antipater's successors. Hence come the increased importance and fuller treatment which from this time forward fall to the lot of the "external duties"

(*καθήκοντα*). The rigour and consistency of the older system became sensibly modified.

To this result another important factor contributed. In all that the older Stoics taught there breathes that enthusiasm for righteousness in which has been traced the earnestness of the Semitic spirit; but nothing *The Sage* presents more forcibly the pitch of their moral idealism than the doctrine of the Wise Man. All mankind fall into two classes—the wise or virtuous, the unwise or wicked—the distinction being absolute. He who possesses virtue possesses it whole and entire; he who lacks it lacks it altogether. To be but a hand's-breadth below the surface of the sea ensures drowning as infallibly as to be five hundred fathoms deep. Now the wise man is drawn as perfect. All he does is right, all his opinions are true; he alone is free, rich, beautiful, skilled to govern, capable of giving or receiving a benefit. And his happiness, since length of time cannot increase it, falls in nothing short of that of Zeus. In contrast with all this, we have a picture of universal depravity. Now, who could claim to have attained to the sage's wisdom? Doubtless, at the first founding of the school Zeno himself and Zeno's pupils were inspired with this hope; they emulated the Cynics Antisthenes and Diogenes, who never shrank out of modesty from the name and its responsibilities. But the development of the system led them gradually and reluctantly to renounce this hope as they came to realize the arduous conditions involved. Zeno indeed could hardly have been denied the title conferred upon Epicurus. Cleanthes, the "second Hercules," held it possible for man to attain to virtue. From anecdotes recorded of the tricks played upon Aristo and Sphaerus (Diog. Laër. vii. 162, 117) it may be inferred that the former deemed himself infallible in his opinions, *i.e.* set up for a sage; Persaeus himself, who had exposed the pretensions of Aristo, is twitted with having failed to conform with the perfect generalship which was one trait of the wise man when he allowed the citadel of Corinth to be taken by Aratus (Athen. iv. 102 D). The trait of infallibility especially proved hard to establish when successive heads of the school seriously differed in their doctrine. The prospect became daily more distant, and at length faded away. Chrysippus declined to call himself or any of his contemporaries a sage. One or two such manifestations there may have been—Socrates and Diogenes?—but the wise man was rare; he thought, than the phoenix. If his successors allowed one or two more exceptions, to Diogenes of Seleucia at any rate the sage was an unrealized ideal, as we learn from Plutarch (*De comm. not.* 33, 1076 B), who does not fail to seize upon this extreme view. Posidonius left even Socrates, Diogenes and Antisthenes in the state of progress towards virtue. Although there was in the end a reaction from this *Modifications in Practice* extreme, yet it is impossible to mistake the bearing of all this upon a practical system of morals. So long as dialectic subtleties and exciting polemics afforded food for the intellect, the gulf between theory and practice might be ignored. But once let this system be presented to men in earnest about right living, and eager to profit by what they are taught, and an ethical reform is inevitable. Conduct for us will be separated from conduct for the sage. We shall be told not always to imitate him. There will be a new law, dwelling specially upon the "external duties" required of all men, wise or unwise; and even the sufficiency of virtue for our happiness may be questioned. The introducer and expositor of such a twofold morality was a remarkable man. Born at Rhodes c. 185 B.C., a citizen of the most flourishing of Greek states and almost the only one which yet retained vigour and freedom, Panaetius lived for years in the house of Scipio Africanus the younger at Rome, accompanied him on embassies and campaigns, and was perhaps the first Greek who in a private capacity had any insight into the working of the Roman state or the character of its citizens. Later in life, as head of the Stoic school at Athens, he achieved a reputation second only to that of Chrysippus. He is the earliest Stoic author from whom we have, even indirectly, any considerable piece of work, as books i. and ii. of the *De officiis* are a *rechauffé*, in Cicero's

fashion, of Panaetius "Upon External Duty" (περὶ τοῦ καθήκοντος).

The introduction of Stoicism at Rome was the most momentous of the many changes that it saw. After the first sharp collision with the jealousy of the national authorities it found a ready acceptance, and made rapid progress amongst the noblest families. It has been well said

Stoicism in Rome.

that the old heroes of the republic were unconscious Stoics, fitted by their narrowness, their stern simplicity and devotion to duty for the almost Semitic earnestness of the new doctrine. In Greece its insensibility to art and the cultivation of life was a fatal defect; not so with the shrewd men of the world, desirous of qualifying as advocates or jurists. It supplied them with an incentive to scientific research in archaeology and grammar; it penetrated jurisprudence until the belief in the ultimate identity of the *jus gentium* with the law of nature modified the praetor's edicts for centuries. Even to the prosaic religion of old Rome, with its narrow original conception and multitude of burdensome rites, it became in some sort a support. Scaevola, following Panaetius, explained that the prudence of statesmen had established this public institution in the service of order midway between the errors of popular superstition and the barren truths of enlightened philosophy. Soon the influence of the pupils reacted upon the doctrines taught. Of speculative interest the ordinary Roman had as little as may be; for abstract discussion and controversy he cared nothing. Indifferent to the scientific basis or logical development of doctrines, he selected from various writers and from different schools what he found most serviceable. All had to be simplified and disengaged from technical subtleties. To attract his Roman pupils Panaetius

Panaetius. would naturally choose simple topics susceptible of rhetorical treatment or of application to individual details. He was the representative, not merely of Stoicism, but of Greece and Greek literature, and would feel pride in introducing its greatest masterpieces: amongst all that he studied, he valued most the writings of Plato. He admired the classic style, the exquisite purity of language, the flights of imagination, but he admired above all the philosophy. He marks a reaction of the genuine Hellenic spirit against the narrow austerity of the first Stoics. Zeno and Chrysippus had introduced a repellent technical terminology; their writings lacked every grace of style. With Panaetius the Stoa became eloquent: he did his best to improve upon the uncouth words in vogue, even at some slight cost of accuracy, e.g. to discard προηγμένον for εὐχρηστον, or else designate it "so-called good," or even simply "good," if the context allowed.

The part Panaetius took in philological and historical studies is characteristic of the man. We know much of the results of these studies; of his philosophy technically we know very little. He wrote only upon ethics, where historical knowledge would be of use. Crates of Mallus, one of his teachers, aimed at fulfilling the high functions of a "critic" according to his own definition—that the critic must acquaint himself with all rational knowledge. Panaetius was competent to pass judgment upon the critical "divination" of an Aristarchus (who was perhaps himself also a Stoic), and took an interest in the restoration of Old Attic forms to the text of Plato. Just then there had been a movement towards a wider and more liberal education, by which even contemporary Epicureans were affected. Diogenes the Babylonian had written a treatise on language and one entitled *The Laws*. Along with grammar, which had been a prominent branch of study under Chrysippus, philosophy, history, geography, chronology and kindred subjects came to be recognized as fields of activity no less than philology proper. It has been recently established that Polybius the historian was a Stoic, and it is clear that he was greatly influenced by the form of the system which he learned to know, in the society of Scipio and his friends, from Panaetius.¹ Nor is it improbable that works of the latter served Cicero as the originals of his *De republica* and *De legibus*.² Thus the gulf between Stoicism and the later Cynics, who were persistently hostile to culture, could not fail to be widened.

¹ Hirzel, *Untersuch.* ii. 841 seq. Polybius's rejection of divination is decisive. See, e.g. his explanation upon natural causes of Scipio the Elder's capture of New Carthage, "by the aid of Neptune," x. 11 (cf. x. 2). P. Voigt holds that in vi. 5, 1, τισιν ἑτέροις τῶν φιλοσόφων is an allusion to Panaetius.

² This at least, is maintained by Schmekel.

A wave of eclecticism passed over all the Greek schools in the 1st century B.C. Platonism and scepticism had left undoubted traces upon the doctrine of such a reformer as Panaetius. He had doubts about a general conflagration; possibly (he thought) Aristotle was right in affirming the eternity of the present order of the world. He doubted the entire system of divination. On these points his disciples Posidonius and Hecato seem to have reverted to orthodoxy. But in ethics his innovations were more suggestive and fertile. He separated wisdom as a theoretic virtue from the other three which he called practical. Hecato slightly modified this: showing that precepts (θεωρήματα) are needed for justice and temperance also, he made them scientific virtues, reserving for his second class the unscientific virtue (ἀθεώρητος ἀρετή) of courage, together with health, strength and such-like "excellencies." Further, Panaetius had maintained that pleasure is not altogether a thing indifferent: there is a natural as well as an unnatural pleasure. But, if so, it would follow that, since pleasure is an emotion, apathy or eradication of all emotions cannot be unconditionally required. The gloss he put upon the definition of the end was "a life in accordance with the promptings given us by nature"; the terms are all used by older Stoics, but the individual nature (ἡμῶν) seems to be emphasized. From Posidonius, the last representative of a comprehensive study of nature

Posidonius. and a subtle erudition, it is not surprising that we get the following definition: the end is to live in contemplation of the reality and order of the universe, promoting it to the best of our power, and never led astray by the irrational part of the soul. The heterodox phrase with which this definition ends points to innovations in psychology which were undoubtedly real and important, suggested by the difficulty of maintaining the essential unity of the soul. Panaetius had referred two faculties (those of speech and of reproduction) to animal impulse and to the vegetative "nature" (φύσις) respectively. Yet the older Stoics held that this φύσις was changed to a true soul (ψυχή) at birth. Posidonius, unable to explain the emotions as "judgments" or the effects of judgments, postulated, like Plato, an irrational principle (including a concupiscent and a spirited element) to account for them, although he subordinated all these as faculties to the one substance of the soul lodged in the heart. This was a serious departure from the principles of the system, facilitating a return of later Stoicism to the dualism of God and the world, reason and the irrational part in man, which Chrysippus had striven to surmount.³

Yet in the general approximation and fusion of opposing views which had set in, the Stoics fared far better than rival schools. Their system became best known and most widely used by individual eclectics. All the assaults of the sceptical Academy had failed, and within fifty years of the death of Carneades his degenerate successors, unable to hold their ground on the question of the criterion, had capitulated to the enemy. Antiochus of Ascalon, the professed restorer of the Old Academy, taught a medley of Stoic and Peripatetic dogmas, which he boldly asserted Zeno had first borrowed from his school. The wide diffusion of Stoic phraseology and Stoic modes of thought may be seen on all hands—in the language of the New Testament writers, in the compendious "histories of philosophy" industriously circulated by a host of writers about this time (cf. H. Diels, *Doxographi graeci*).

The writings of the later Stoics have come down to us, if not entire, in great part, so that Seneca, Cornutus, Persius, Lucan, Epictetus, Marcus Aurelius are known at first hand. They do not profess to give a scientific exposition of doctrine, and may therefore be dismissed somewhat briefly (see EPICETUS and MARCUS AURELIUS). We learn much more about the Stoic system from the scanty fragments of the first founders,⁴ or even from the epitomes of Diogenes Laërtius and Stobaeus, than from these writers. They testify to the restriction of philosophy to the practical side, and to the increasing tendency, ever since Panaetius, towards a relaxation of the rigorous ethical doctrine and its approximation to the form of religious conviction. This finds most marked expression in the doctrines of submission to Providence and universal philanthropy. Only in this way could they hold their ground, however insecurely, in face of the religious reaction of the 1st century. In passing to Rome, Stoicism quitted the school for actual life. The fall of the republic was a gain, for it

³ Works of Posidonius and Hecato have served as the basis of extant Latin treatises. Cicero, *De divinatione*, perhaps *De natura deorum*, i. ii., comes in part from Posidonius; Cicero, *De finibus*, iii., and Seneca, *De beneficiis*, i.-iv., from Hecato, who is also the source of Stobaeus, *Ecl. eth.* ii. 110. Cf. H. H. Fowler, *Panaetii et Hecatonis fragmenta* (Bonn, 1885).

⁴ Cf. C. Wachsmuth, *Commentationes II. de Zenone Citiensi et Cleanthe Assio* (Göttingen, 1874). Baguet's *Chrysippus* (Louvain, 1822) is unfortunately very incomplete.

released so much intellectual activity from civic duties. The life and death of Cato fired the imagination of a degenerate age in which he stood out both as a Roman and a Stoic. To a long line of illustrious successors, men like Thræsea Paetus and Helvidius Priscus, Cato bequeathed his resolute opposition to the dominant power of the times; unsympathetic, impracticable, but fearless in demeanour, they were a standing reproach to the corruption and tyranny of their age. But when at first, under Augustus, the empire restored order, philosophy became bolder and addressed every class in society, public lectures and spiritual direction being the two forms in which it mainly showed activity. Books of direction were written by Sextius in Greek (as afterwards by Seneca in Latin), almost the only Roman who had the ambition to found a sect, though in ethics he mainly followed Stoicism. His contemporary Papius Fabianus was the popular lecturer of that day, producing a powerful effect by his denunciations of the manners of the time. Under Tiberius, Sotion and Attalus were attended by crowds of hearers. In Seneca's time there was a professor, with few hearers it is true, even in a provincial town like Naples. At the same time the antiquarian study of Stoic writings went on apace, especially those of the earliest teachers—Zeno and Aristo and Cleanthes.

Seneca is the most prominent leader in the direction which Roman Stoicism now took. His penetrating intellect had mastered the subtleties of the system of Chrysippus, but they seldom appear in his works, at least without apology. Incidentally we meet there with the doctrines of Pneuma and of tension, of the corporeal nature of the virtues and the affections, and much more to the same effect. But his attention is claimed for physics chiefly as a means of elevating the mind, and as making known the wisdom of Providence and the moral government of the world. To reconcile the ways of God to man had been the ambition of Chrysippus, as we know from Plutarch's criticisms. He argued plausibly that natural evil was a thing indifferent—that even moral evil was required in the divine economy as a foil to set off good. The really difficult problem why the prosperity of the wicked and the calamity of the just were permitted under the divine government he met in various ways: sometimes he alleged the forgetfulness of higher powers; sometimes he fell back upon the necessity of these contrasts and grotesque passages in the comedy of human life. Seneca gives the true Stoic answer in his treatise *On Providence*: the wise man cannot really meet with misfortune; all outward calamity is a divine instrument of training, designed to exercise his powers and teach the world the indifference of external conditions. In the soul Seneca recognizes an effluence of the divine spirit, a god in the human frame; in virtue of this he maintains the essential dignity and internal freedom of man in every human being. Yet, in striking contrast to this orthodox tenet is his vivid conception of the weakness and misery of men, the hopelessness of the struggle with evil, whether in society or in the individual. Thus he describes the body (which, after Epicurus, he calls the flesh) as a mere husk or fetter or prison of the soul; with its departure begins the soul's true life. Sometimes, too, he writes as if he accepted an irrational as well as a rational part of the soul. In ethics, if there is no novelty of doctrine, there is a surprising change in the mode of its application. The ideal sage has receded; philosophy comes as a physician, not to the whole but to the sick. We learn that there are various classes of patients in "progress" (*προκοπή*), i.e. on their way to virtue, making painful efforts towards it. The first stage is the eradication of vicious habits: evil tendencies are to be corrected, and a guard kept on the corrupt propensities of the reason. Suppose this achieved, we have yet to struggle with single attacks of the passions: irascibility may be cured, but we may succumb to a fit of rage. To achieve this second stage the impulses must be trained in such a way that the fitness of things indifferent may be the guide of conduct. Even then it remains to give the will that property of rigid infallibility without which we are always liable to err, and this must be effected by the training of the judgment. Other peculiarities of the later Stoic ethics are due to the condition

of the times. In a time of moral corruption and oppressive rule, as the early empire repeatedly became to the privileged classes of Roman society, a general feeling of insecurity led the student of philosophy to seek in it a refuge against the vicissitudes of fortune which he daily beheld. The less any one man could do to interfere in the government, or even to safeguard his own life and property, the more heavily the common fate pressed upon all, levelling the ordinary distinctions of class and character. Driven inwards upon themselves, they employed their energy in severe self-examination, or they cultivated resignation to the will of the universe, and towards their fellow men forbearance and forgiveness and humility, the virtues of the philanthropic disposition. With Seneca this resignation took the form of a constant meditation upon death. Timid by nature, aware of his impending doom, and at times justly dissatisfied with himself, he tries all means of reconciling himself to the idea of suicide. The act had always been accounted allowable in the school, if circumstances should call for it: indeed, the first three teachers had found such circumstances in the infirmity of old age. But their attitude towards the "way out" (*ἐξαιγωγή*) of incurable discomforts is quite unlike the anxious sentimentalism with which Seneca dwells upon death.

From Seneca we turn, not without satisfaction, to men of sterner mould, such as Musonius Rufus, who certainly deserves a place beside his more illustrious disciple, Epictetus. As a teacher he commanded universal respect, and wherever we catch a glimpse of his activity he appears to advantage. His philosophy, however, is yet more concentrated upon practice than Seneca's, and in ethics he is almost at the position of Aristo. Epictetus testifies to the powerful hold he acquired upon his pupils, each of whom felt that Musonius spoke to his heart. The practical conclusion of his philosophy is that he must cheerfully accept the inevitable.

In the life and teaching of Epictetus this thought bore abundant fruit. The beautiful character which rose superior to weakness, poverty and slave's estate is also presented to us in the *Discourses* of his disciple Arrian as a model of religious resignation, of forbearance and love towards our brethren, that is, towards all men, since God is our common father. With him even the "physical basis" of ethics takes the form of a religious dogma—the providence of God and the perfection of the world. We learn that he regards the *δαίμων* or "guardian angel" as the divine part in each man; sometimes it is more nearly conscience, at other times reason. His ethics, too, have a religious character. He begins with human weakness and man's need of God: whoso would become good must first be convinced that he is evil. Submission is enforced by an argument which almost amounts to a retraction of the difference between things natural and things contrary to nature, as understood by Zeno. Would you be cut off from the universe? he asks. Go to, grow healthy and rich. But if not, if you are a part of it, then become resigned to your lot. Towards this goal of approximation to Cynicism the later Stoics had all along been tending. Withdrawal from the active duty of the world must lead to passive endurance, and, ere long, complete indifference. Musonius had recommended marriage and condemned unsparingly the exposure of infants. Epictetus, however, would have the sage hold aloof from domestic cares, another Cynic trait. So, too, in his great maxim "bear and forbear," the last is a command to refrain from the external advantages which nature offers.

Epictetus is marked out amongst Stoics by his renunciation of the world. He is followed by a Stoic emperor, M. Aurelius Antoninus, who, though in the world, was not of it. The *Meditations* give no systematic exposition of belief, but there are many indications of the religious spirit we have already observed, together with an almost Platonic psychology. Following Epictetus, he speaks of man as a corpse bearing about a soul; at another time he has a threefold division—(1) body, (2) soul, the seat of impulse (*πνευματίον*), and (3) *νοῦς* or intelligence, the proper *ego*. In all he writes there is a vein of sadness: the flux of all things, the vanity of

life, are thoughts which perpetually recur, along with resignation to the will of God and forbearance towards others, and the religious longing to be rid of the burden and to depart to God. These peculiarities in M. Antoninus may perhaps be explained in harmony with the older Stoic teaching; but, when taken in connexion with the rise of Neoplatonism and the revival of superstition, they are certainly significant. None of the ancient systems fell so rapidly as the Stoa. It had just touched the highest point of practical morality, and in a generation after M. Antoninus there is hardly a professor to be named. Its most valuable lessons to the world were preserved in Christianity; but the grand simplicity of its monism slumbered for fifteen centuries before it was revived by Spinoza.

LITERATURE.—The best modern authority is Zeller, *Phil. d. Griech.* iii. pt. i. (3rd ed., 1880)—Eng. trans. *Stoics*, by Reichel (1879), and *Eclectics*, by S. F. Alleyne (1883). Further may be cited F. Ravaisson, *Essai sur le stoïcisme* (Paris, 1856); M. Heinze, *Die Lehre vom Logos* (Oldenburg, 1872); H. Siebeck, *Untersuchungen zur Phil. d. Griechen* (Halle, 1873), and *Gesch. d. Psychologie*, i. 2 (Gotha, 1884); R. Hürzel, "Die Entwicklung der stoisch. Phil.," in *Untersuchungen zu Ciceros Schriften*, ii. 1-566 (Leipzig, 1882); Ogereau, *Essai sur le système des Stoiciens* (Paris, 1885); L. Stein, *Die Psychologie der Stoa*, i. p. ii. (Berlin, 1886-1888); A. C. Pearson, *The Fragments of Zeno and Cleanthes* (London 1891); A. Schmekel, *Die Philosophie der mittleren Stoa* (Berlin, 1892); A. Bonhöffer, *Epictet und die Stoa* (Stuttgart, 1890); *Die Ethik des Stoikers Epictet* (Stuttgart, 1894); A. Dyroff, *Die Ethik der alten Stoa* (Berlin, 1897). Indispensable to the student are H. Diels, *Doxographi graeci* (Berlin, 1879); J. von Arnim, *Stoicorum veterum fragmenta*, i-iii. (Leipzig, 1903-1905). (R. D. H.)

STOKE NEWINGTON, a north-eastern metropolitan borough of London, England, bounded E. by Hackney and W. by Islington, and extending N. to the boundary of the county of London. Pop. (1901), 51,247. It is mainly occupied by small villas. On its western boundary, adjoining Green Lanes, lies Clissold Park (54 acres) and outside the north-western boundary is Finsbury Park (115 acres). In Church Street is the ancient parish church of St Mary, largely restored, but still bearing the stamp of antiquity; opposite to it stands a new church in Decorated style by Sir Gilbert Scott. In the north of the borough are the main waterworks and reservoirs of the New River Company, though the waterway continues to a head in Finsbury. Stoke Newington is partly in the north division of the parliamentary borough of Hackney, but the district of South Hornsey, included in the municipal borough, is in the Hornsey division of Middlesex. The borough council consists of a mayor, 5 aldermen and 30 councillors. Area, 863.5 acres.

STOKE-ON-TRENT, a market town and municipal and parliamentary borough of Staffordshire, England, on the upper Trent, in the heart of the Potteries district. Pop. (1901), 30,458. This was the population of the separate borough of Stoke-upon-Trent (area, 1882 acres) which existed until 1910. In 1908 arrangements were made whereby Stoke-upon-Trent, Burslem, Fenton, Hanley, Longton and Tunstall should be amalgamated as one borough, under the name of Stoke-on-Trent, from the 31st of March 1910. The new corporation consists of a mayor, 26 aldermen and 78 councillors. Stoke is on the North Staffordshire railway, 146 m. north-west from London by the London & North-Western railway; and on the Grand Trunk (Trent and Mersey) Canal. The principal public buildings in the old town of Stoke are the town hall, with assembly rooms, law library and art gallery, the market hall, the Minton memorial building, containing a school of art and science; the free library and museum, and the North Staffordshire infirmary, founded in 1815 at Etruria, and removed to its present site in 1868. The head offices of the North Staffordshire Railway Company are here. Four large firms manufacturing every variety of art china and earthenware alone employ over 5000 hands. Coal-mining and iron and machine manufactures are also carried on. A statue commemorates Josiah Wedgwood, born at Burslem in 1730; but other famous names in the pottery trade are more intimately connected with Stoke. Thus Josiah Spode the second was born here in 1754, and had a great house at Penkhull, on the western outskirts of Stoke. He

entered into partnership with the Copelands, who continued his business. Herbert Minton (1793-1858) was the founder of another of the large works. The parliamentary borough returns one member.

In the Domesday Survey of 1086 half the church of Stoke and lands in Stoca are said to have belonged to Robert of Stafford. Part of Stoke (Stoche or Stoca) at this time belonged to the Crown, since the royal estate of Penculla (now Penkhull) was included within its bounds. Frequent references to the parish church of Stoke are found during the 14th and 15th centuries. Contemporary writers from 1787 onwards describe Stoke as a market town, but the official evidence states that the market rights were not acquired until 1845. Since then the market days have been Saturday and Monday. Stoke-upon-Trent became the railway centre and head of the parliamentary borough of Stoke-upon-Trent, comprising the whole of the Staffordshire Potteries, which was created by the Reform Bill of 1832. In 1874 it was incorporated as a municipality. From 1833 to 1885 Stoke returned two members to parliament. From the early 17th century, if not earlier, porcelain and earthenware manufactories existed at Stoke-upon-Trent, but they remained unnoticed until in 1686 Dr Plot wrote his survey of Staffordshire. In the middle of the 18th century there was a great industrial development in the Pottery district.

See John Ward, *The Borough of Stoke-upon-Trent* (London, 1843).

STOKE POGES, a village in the south of Buckinghamshire, England, 3 m. N. of Slough, famous for its connexion with the poet Thomas Gray. The church of St Giles has portions of Norman, Early English, and later dates, and contains a fine Decorated canopied tomb and brasses of members of the family of Moleyns. A passage or cloister leading towards the ancient manor-house contains some good original stained-glass windows. Gray is buried beside his mother in the churchyard, and there is a monument to his memory in the adjacent Stoke Park. The churchyard is generally considered to be the original of the poet's *Elegy in a Country Churchyard*; and the manor-house finds mention in his *Long Story*. West End Cottage, where he often stayed, remains in altered form as Stoke Court. Burnham Beeches (*q.v.*), now preserved to public use, and a favourite resort of the poet, are 3 m. distant to the north-west.

STOKES, SIR GEORGE GABRIEL, BART. (1819-1903), British mathematician and physicist, was the youngest son of the Rev. Gabriel Stokes, rector of Skreen, Co. Sligo, where he was born on the 13th of August 1819. After attending schools in Dublin and Bristol, he matriculated in 1837 at Pembroke College, Cambridge, where, four years later, on graduating as senior wrangler and first Smith's prizeman, he was elected to a fellowship. This he had to vacate by the statutes of that society when he married in 1857, but twelve years later, under new statutes, he was re-elected, and retained his place on the foundation until 1902, when, on the day before he entered on his eighty-fourth year, he was elected to the mastership. But he did not long enjoy this position, for he died at Cambridge on the 1st of February in the following year. In 1849 he was appointed to the Lucasian professorship of mathematics in the university, and on the 1st of June 1899 the jubilee of his appointment was celebrated at Cambridge in a brilliant ceremonial, which was attended by numerous delegates from European and American universities. On that occasion a commemorative gold medal was presented to him by the chancellor of the university, and marble busts of him by Hamo Thornycroft were formally offered to Pembroke College and to the university by Lord Kelvin. Sir George Stokes, who was created a baronet in 1889, further served his university by representing it in parliament from 1887 to 1892. During a portion of this period (1885-1890) he was president of the Royal Society, of which he had been one of the secretaries since 1854, and thus, being at the same time Lucasian professor, he united in himself three offices which had only once before been held by one man, Sir Isaac Newton, who, however, did not hold all three simultaneously.

Stokes was the oldest of the trio of natural philosophers,

Clerk Maxwell and Lord Kelvin being the other two, who especially contributed to the fame of the Cambridge school of mathematical physics in the middle of the 19th century. His original work began about 1840, and from that date onwards the great extent of his output was only less remarkable than the brilliance of its quality. The Royal Society's catalogue of scientific papers gives the titles of over a hundred memoirs by him published down to 1883. Some of these are only brief notes, others are short controversial or corrective statements, but many are really long and elaborate treatises. In matter his work is distinguished by a certain definiteness and finality, and even of problems, which when he attacked them were scarcely thought amenable to mathematical analysis, he has in many cases given solutions which once and for all settle the main principles. This result must be ascribed to his extraordinary combination of mathematical power with experimental skill, for with him, from the time when about 1840 he fitted up some simple physical apparatus in his rooms in Pembroke College, mathematics and experiment ever went hand in hand, aiding and checking each other. In scope his work covered a wide range of physical inquiry, but, as Alfred Cornu remarked in his Rede lecture of 1899, the greater part of it was concerned with waves and the transformations imposed on them during their passage through various media. His first published papers, which appeared in 1842 and 1843, were on the steady motion of incompressible fluids and some cases of fluid motion; these were followed in 1845 by one on the friction of fluids in motion and the equilibrium and motion of elastic solids, and in 1850 by another on the effects of the internal friction of fluids on the motion of pendulums. To the theory of sound he made several contributions, including a discussion of the effect of wind on the intensity of sound and an explanation of how the intensity is influenced by the nature of the gas in which the sound is produced. These inquiries together put the science of hydrodynamics on a new footing, and provided a key not only to the explanation of many natural phenomena, such as the suspension of clouds in air, and the subsidence of ripples and waves in water, but also to the solution of practical problems, such as the flow of water in rivers and channels, and the skin resistance of ships. But perhaps his best-known researches are those which deal with the undulatory theory of light. His optical work began at an early period in his scientific career. His first papers on the aberration of light appeared in 1845 and 1846, and were followed in 1848 by one on the theory of certain bands seen in the spectrum. In 1849 he published a long paper on the dynamical theory of diffraction, in which he showed that the plane of polarization must be perpendicular to the direction of vibration. Two years later he discussed the colours of thick plates; and in 1852, in his famous paper on the change of refrangibility of light, he described the phenomenon of fluorescence, as exhibited by flint spar and uranium glass, materials which he viewed as having the power to convert invisible ultra-violet rays into rays of lower periods which are visible. A mechanical model, illustrating the dynamical principle of Stokes's explanation was shown in 1883, during a lecture at the Royal Institution, by Lord Kelvin, who said he had heard an account of it from Stokes many years before, and had repeatedly but vainly begged him to publish it. In the same year, 1852, there appeared the paper on the composition and resolution of streams of polarized light from different sources, and in 1853 an investigation of the metallic reflection exhibited by certain non-metallic substances. About 1860 he was engaged in an inquiry on the intensity of light reflected from, or transmitted through, a pile of plates; and in 1862 he prepared for the British Association a valuable report on double refraction, which marks a period in the history of the subject in England. A paper on the long spectrum of the electric light bears the same date, and was followed by an inquiry into the absorption spectrum of blood. The discrimination of organic bodies by their optical properties was treated in 1864; and later, in conjunction with the Rev. W. Vernon Harcourt, he investigated the relation between the chemical constitution and the optical properties of various glasses, with reference to the conditions of trans-

parency and the improvement of achromatic telescopes. A still later paper connected with the construction of optical instruments discussed the theoretical limits to the aperture of microscopical objectives. In other departments of physics may be mentioned his paper on the conduction of heat in crystals (1851) and his inquiries in connexion with the radiometer; his explanation of the light border frequently noticed in photographs just outside the outline of a dark body seen against the sky (1883); and, still later, his theory of the Röntgen rays, which he suggested might be transverse waves travelling as innumerable solitary waves, not in regular trains. Two long papers published in 1849—one on attractions and Clairaut's theorem, and the other on the variation of gravity at the surface of the earth—also demand notice, as do his mathematical memoirs on the critical values of the sums of periodic series (1847) and on the numerical calculation of a class of definite integrals and infinite series (1850) and his discussion of a differential equation relating to the breaking of railway bridges (1849).

But large as is the tale of Stokes's published work, it by no means represents the whole of his services in the advancement of science. Many of his discoveries were not published, or at least were only touched upon in the course of his oral lectures. An excellent instance is afforded by his work in the theory of spectrum analysis. In his presidential address to the British Association in 1871, Lord Kelvin (Sir William Thomson, as he was then) stated his belief that the application of the prismatic analysis of light to solar and stellar chemistry had never been suggested directly or indirectly by any other savant when Stokes taught it to him in Cambridge some time prior to the summer of 1852, and he set forth the conclusions, theoretical and practical, which he learnt from Stokes at that time, and which he afterwards gave regularly in his public lectures at Glasgow. These statements, containing as they do the physical basis on which spectrum analysis rests, and the mode in which it is applicable to the identification of substances existing in the sun and stars, make it appear that Stokes anticipated Kirchhoff by at least seven or eight years. Stokes, however, in a letter published some years after the delivery of this address, stated that he had failed to take one essential step in the argument (not perceiving that emission of light of definite refrangibility not merely permitted, but necessitated, absorption of light of the same refrangibility), and modestly disclaimed "any part of Kirchhoff's admirable discovery," adding that he felt some of his friends had been over-zealous in his cause. It must be said, however, that English men of science have not accepted this disclaimer in all its fullness, and still attribute to Stokes the credit of having first enunciated the fundamental principles of spectrum analysis. In another way, too, Stokes did much for the progress of mathematical physics. Soon after he was elected to the Lucasian chair he announced that he regarded it as part of his professional duties to help any member of the university in difficulties he might encounter in his mathematical studies, and the assistance rendered was so real that pupils were glad to consult him, even after they had become colleagues, on mathematical and physical problems in which they found themselves at a loss. Then during the thirty years he acted as secretary of the Royal Society he exercised an enormous if inconspicuous influence on the advancement of mathematical and physical science, not only directly by his own investigations, but indirectly by suggesting problems for inquiry and inciting men to attack them, and by his readiness to give encouragement and help.

Several of the honours enjoyed by Sir George Stokes have already been enumerated. In addition, it may be mentioned that from the Royal Society, of which he became a fellow in 1851, he received the Rumford medal in 1852 in recognition of his inquiries into the refrangibility of light, and later, in 1893, the Copley medal. In 1869 he presided over the Exeter meeting of the British Association. From 1883 to 1885 he was Burnett lecturer at Aberdeen, his lectures on *Light*, which were published in 1884-1887, dealing with its nature, its use as a means of investigation, and its beneficial effects. In 1891, as Gifford lecturer, he published a volume on *Natural Theology*. His

academical distinctions included honorary degrees from many universities, together with membership of the Prussian Order Pour le Mérite.

Sir George Stokes's mathematical and physical papers were published in a collected form in five volumes; the first three (Cambridge, 1880, 1883, and 1901) under his own editorship, and the two last (Cambridge, 1904 and 1905) under that of Sir Joseph Larmor, who also selected and arranged the *Memoir and Scientific Correspondence* of Stokes published at Cambridge in 1907.

STOKES, WHITLEY (1830–1909), British lawyer and Celtic scholar, was a son of William Stokes (1804–1878), and a grandson of Whitley Stokes (1763–1845), each of whom was regius professor of physic in the university of Dublin. In his day, William Stokes, who was the author of several books on medical subjects, was one of the foremost physicians in Europe. Educated at Trinity College, Dublin, young Stokes became an English barrister in 1855, and in 1862 he went to India, where he filled several official positions. In 1877 he was appointed legal member of the viceroy's council, and he drafted the codes of civil and criminal procedure and did much other valuable work of the same nature. In 1879 he was president of the commission on Indian law. He returned to England in 1882. In 1887 he was made a C.S.I., and two years later a C.I.E.; he obtained honorary degrees from many universities, and was a fellow of the British Academy. He died in London on the 13th of April 1909. Whitley Stokes is perhaps most famous as a Celtic scholar, and in this field he worked both in India and in England. He studied Irish, Breton and Cornish texts, and among his numerous works may be mentioned editions of *Three Irish Glossaries* (1862); *Three Middle-Irish Homilies* (1877); and *Old Irish Glosses at Würzburg and Carlsruhe* (1887). He was one of the editors of the *Irische Texte* published at Leipzig (1880–1900); and he edited and translated *Lives of Saints from the Book of Lismore* (1890). With Professor A. Bezzenger he wrote *Urkeltscher Sprachschatz* (1894). His principal legal work was *The Anglo-Indian Codes* (1887).

STOKESLEY, JOHN (c. 1475–1539), English prelate, was born at Colly Weston in Northamptonshire, and became a fellow of Magdalen College, serving also as a lecturer. In 1498 he was made principal of Magdalen Hall, and in 1505 vice-president of Magdalen College. Soon after 1509 he was appointed a member of the royal council and chaplain to Henry VIII. In 1520 he was at the Field of the Cloth of Gold; in 1529 and 1530 he went to France and Italy as ambassador to Francis I. and to gain opinions from foreign universities in favour of the king's divorce from Catherine of Aragon. In 1530 he became bishop of London. In 1533 he christened the princess Elizabeth, and his later years were troubled by disputes with Archbishop Cranmer. Stokesley opposed all changes in the doctrines of the Church and was very active in persecuting heretics. He was a man of learning, writing in favour of Henry's divorce, and with Cuthbert Tunstall, bishop of Durham, a treatise against Cardinal Pole. He died on the 8th of September, 1539.

STOLBERG, FRIEDRICH LEOPOLD, GRAF ZU (1750–1819), German poet, the younger son of Count Christian Stolberg, was born at Bramstedt in Holstein on the 7th of November 1750. He studied in Göttingen and was a prominent member of the famous *Hain* or *Dichterbund*. After leaving the university he made a journey to Switzerland with his brother Christian, in company with Goethe. In 1777 he was appointed envoy of the prince bishop of Lübeck at the court of Copenhagen, but often stayed at Eutin, where he was the intimate associate of his college friend and member of the *Dichterbund*, Johann Heinrich Voss. In 1782 he married Agnes von Witzleben, whom he celebrated in his poems. After her early death in 1788, he became Danish envoy at the court of Berlin, and contracted a second marriage with the countess Sophie von Redern in 1789. In 1791 he was appointed president of the Lübeck episcopal court at Eutin; he resigned this office in 1800, and retiring to Münster in Westphalia, there joined, with his whole family, the eldest daughter only excepted, the Roman Catholic Church. For this step he was severely attacked by his former friend Voss (*Wie ward Fritz Stolberg ein Unfreier?* 1819). After living for a while

(from 1812) in the neighbourhood of Bielefeld, he removed to his estate of Sondermühlen near Osnabrück, where he died on the 5th of December 1819. He wrote many odes, ballads, satires and dramas—among the last the tragedy *Timoleon* (1784), translations of the *Iliad* (1778), of Plato (1796–1797), Aeschylus (1802), and Ossian (1806); he published in 1815 a *Leben Alfreds des Grossen*, and a voluminous *Geschichte der Religion Jesu Christi* (17 vols., 1806–1818).

Stolberg's brother, **CHRISTIAN, GRAF ZU STOLBERG** (1748–1821), was also a poet. Born at Hamburg on the 15th of October 1748, he became a magistrate at Tremsbüttel in Holstein in 1777, and died on the 18th of January 1821. Of the two brothers Friedrich was undoubtedly the more talented, but Christian, though not a poet of high originality, excelled in the utterance of gentle sentiment. They published together a volume of poems, *Gedichte* (edited by H. C. Boie, 1779); *Schauspiele mit Chören* (1787), their object in the latter work being to revive a love for the Greek drama; and a collection of patriotic poems *Vaterländische Gedichte* (1815). Christian von Stolberg was the sole author of *Gedichte aus dem Griechischen* (1782), a translation of the works of Sophocles (1787), and of a poem in seven ballads, *Die weisse Frau* (1814), which last attained considerable popularity.

The Collected Works of Christian and Friedrich Leopold zu Stolberg were published in twenty volumes in 1820–1825; 2nd ed. 1827. Friedrich's correspondence with F. H. Jacobi will be found in Jacobi's *Briefwechsel* (1825–1827); that with Voss has been edited by O. Hellinghaus (1891). Selections from the poetry of the two brothers will be found in A. Sauer's *Der Göttinger Dichterbund*, iii. (Kürschner's *Deutsche Nationalliteratur*, vol. 50, 1896). See also T. Menge, *Der Graf F. L. Stolberg und seine Zeitgenossen* (2 vols., 1862); J. H. Hennes, *Aus F. L. von Stolbergs Jugendjahren* (1876); the same, *Stolberg in den zwei letzten Jahrzehnten seines Lebens* (1875); J. Janssen, *F. L. Graf zu Stolberg* (2 vols., 1877), 2nd ed. 1882; W. Keiper, *F. L. Stolbergs Jugendpoesie* (1893).

STOLBERG, a town of Germany, in the Prussian Rhine Province, situated on the Vichtbach, 7 m. E. of Aix-la-Chapelle, on the main line of railway to Cologne. Pop. (1905), 14,963. It contains two Protestant and two Roman Catholic churches, a castle occupying the site of one said to have been used by Charlemagne as a hunting seat. It is the centre of a very active and varied industry, exporting its produce to all parts of the world. The leading branch is metal-working, which is here carried on in important zinc, brass, and iron foundries, smelting-works of various kinds, puddling and rolling works, and manufacturing of needles, pins and other metal goods. The ore is mostly found in the mines around the town, but some is imported from a considerable distance. In or near the town there are also large chemical works, glass-works, a mirror-factory and various minor establishments. Extensive coal-mines in the neighbourhood provide the enormous supply of fuel demanded by the various industries. The industrial prosperity of the town was founded in the middle of the 17th century by French religious refugees, who introduced the art of brass-founding.

STOLE (Lat. *stola* and *orarium*, Fr. *étole*, It. *stola*, Sp. *estola*, Ger. *Stola*), a liturgical vestment of the Catholic Church, peculiar to the higher orders, *i.e.* deacons, priests and bishops. It is a strip of stuff, usually silk, some 2½ yards long by 4 inches broad; in the middle and at the ends, which are commonly broadened out, it is ornamented with a cross. Its colour varies with the liturgical colour of the day, or of the function at which it is worn.

There is very little evidence as to the form and character of the stole before the Carolingian age; but from the 9th century onwards representations of the stole show that it varied in no essential particular from that of the present day. In the 11th, 12th and 13th centuries it was remarkably long and narrow. From the 9th to the 13th

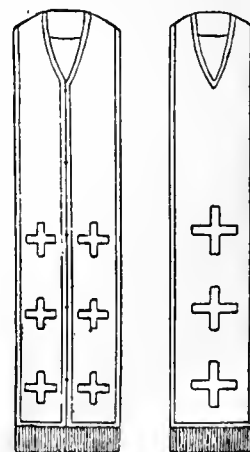

century it was mostly provided with a separate piece by way of finish to the ends, and this in the 12th and 13th centuries was as a rule trapeze-shaped. In the late middle ages the stole was usually of uniform breadth; but from the 16th century onwards the ends again began to be widened, until in the 18th century we have the hideous form with large shovel-shaped ends. Fringes, tassels, little bells and the like were used as decorations of the ends of stoles at least as early as the 9th century; but crosses in the middle and at the ends were rarely added during the middle ages. The usual material of medieval stoles was silk, and the better ones were embroidered with silk, gold thread, pearls, &c.

The stole is worn immediately over the alb; by deacons, scarf-wise over the left shoulder, across the breast and back to the right side; by priests and bishops, dependent from the neck, the two ends falling over the breast. In the case of bishops, however, the stole always hangs straight down; while priests wear it crossed over the breast when vested in the alb. Essentially, the actual method of wearing the stole conforms to the original practice. During the middle ages there were, however, deviations of custom: e.g. priests, even according to the Roman use, did not wear the stole crossed over the alb, though this had been prescribed for Spain so early as 675 by the 4th canon of the council of Braga. In southern Italy, probably under Greek influence, and in Milan (where the custom still survives) the diaconal stole was put on over the dalmatic. Similarly in Spain and Gaul, anterior to the Carolingian age, the stole was worn by deacons over the *alba* or outer tunic.

According to the Roman use the stole is now only worn at mass, in administering the sacraments and *sacramentalia*, when touching the Host, &c., but not e.g. at solemn offices or in processions. In the middle ages, however, it was the custom to wear it at nearly all liturgical functions. In the 9th and 10th century it was even made obligatory, by the decrees of the synods of Mainz (813) and Tribur (895), on priests throughout the Frank Empire to wear it at all times, especially when travelling. Elsewhere it was the custom to wear it always, at least for a year after ordination.

The custom of giving the stole to priests and deacons at their ordination is of great antiquity. So far as Spain is concerned there is evidence for it in the decrees of the 4th council of Toledo (633), and for Rome that of the 8th century *Ordo* of Mabillon. The present practice—according to which the bishop lays the stole over the left shoulder of the deacon, and crosses it over the breast of the priest—is already found in the pontificals of the 10th century.

There is no evidence to show when the stole was first used in the Western Church. In Gaul and Spain we already find it in the 6th century; our first evidence for its use in Rome is of the 8th century, which is however, of course, no proof that it was not in use earlier. The mosaic in the apse of S. Vitale at Ravenna, which has been taken to prove the existence of the stole in the first half of the 6th century, has no value as evidence, as the lower part of the figure of Bishop Ecclesius (see VESTMENTS, fig. 2) was renewed in the 12th century. It is noteworthy that at Rome, until the 10th century, the stole was worn by the lower orders of the clergy also.

In the Eastern Church the stole (Gr. *ὠράριον*, the diaconal stole, *ἐπιτραχήλιον*, the priestly stole; Slav. *orar* and *epitrachil*; Arm. *urar*; Syr. *uroro*; Nest. *urara*; Copt. *orarion* and *patrashil*) makes its appearance very early. The stole of the deacons is mentioned so early as the 4th and 5th centuries, the first instance being in the 22nd canon of the council of Laodicea, where it is mentioned specifically as the insignia of a deacon. Of a priestly stole we hear for the first time in the *Theoria mystica* (8th century). In the Maronite, Syrian, and Nestorian Churches subdeacons also wear the stole, and among the Maronites the lectors as well. There is very little evidence as to the character of the stole in the ancient Church of the East. The stole of priests and bishops, decorated with crosses, was worn originally in all rites as in the West, i.e. hanging in two loose bands over the breast; at the present day, according to the Greek rite, the two bands are

firmly sewn together, while in the Armenian, Syrian and Coptic rites they have even been amalgamated into a single broad strip with an opening at the top for the head. Its ancient form has been retained only by the Nestorians, who wear it crossed over the breast. The diaconal stole was and continues to be worn usually hanging over the left shoulder, the ends falling straight down before and behind. Only the Copts and Armenians wear it scarf-wise. Originally the diaconal stole would seem to have been a narrow strip of folded linen, and it appears in the pictures of the 9th century as a narrow band ornamented with crosses. Later, it was often the habit to embroider on Greek diaconal stoles the words ΑΓΙΟΣ ΑΓΙΟΣ ΑΓΙΟΣ.

The question of the origin of the stole admits of no conclusive answer. It is certainly not derived from the antique *stola*, called *tunica*, as was formerly always held, nor yet from the prayer blanket (*tallith*) of the Jews. More careful investigation, moreover, throws very considerable doubt on the possibility of the derivation of the priest's stole from the ancient neck-cloth (*orarium*) and of the diaconal stole from a napkin used in the liturgy. A more reasonable theory seems to be that which suggests that, in the East, the stole was originally introduced as that which it was when it first appears in the 22nd canon of Laodicea, viz. a special liturgical mark of distinction for deacons, which in course of time was extended to all the higher orders. In all probability it was introduced straight from the East into Spain and Gaul. Rome also probably imported it from the same quarter, but weakened its significance by making it a cloth sanctified by being laid on the *Confessio* of St Peter, the bestowal of which at ordination was intended to express the fact that elevation to clerical office in the Roman Church was a grace bestowed *de benedictione S. Petri* and that the ordinands were undertaking with their consecration the duty of serving St Peter, i.e. the Roman Church.

Wherever the Reformation was introduced the stole was done away with, even when chasuble, alb and cope were retained; the reason being that it was the ensign of the major orders, which in the Catholic sense were rejected by the Reformers.¹ (J. BRA.)

STOLEN GOODS. In English law, various points of importance arise in connexion with chattels which have been the subject of larceny and have not been returned to the possession of their owner. The owner of the goods stolen has an action against the thief for the goods or their value. How far he is entitled to pursue his civil right to the exclusion of criminal prosecution does not seem very clear upon the authorities. In *Midland Insurance Co. v. Smith* (1881, L.R. 6 Q.B.D., 568), Mr Justice Watkin Williams said: "It has been said that the true principle of the common law is that there is neither a merger of the civil right, nor is it a strict condition precedent to such right that there shall have been a prosecution of the felon, but that there is a duty imposed upon the injured person not to resort to the prosecution of his private suit to the neglect and exclusion of the vindication of the public law; in my opinion this view is the correct one." Dealing with stolen goods by persons other than the thief may affect the rights of such persons either criminally or civilly. Two varieties of crime arise from such dealings. (1) Receiving stolen goods knowing them to have been stolen, a misdemeanour at common law, is by the Larceny Act a felony punishable by penal servitude for fourteen years where the theft amounts to felony, a misdemeanour punishable by penal servitude for seven years where the theft is a

¹The stole was not one of the vestments prescribed by the rubrics of the first Prayer-book of Edward VI. (see VESTMENTS). It was replaced in the Church of England from the Reformation onwards by the scarf, a broad band of black silk, formerly part of the outdoor dress of the dignified clergy and without liturgical significance. This vestment has some resemblance to the stole, in that it is worn round the neck and hanging straight down in front over each shoulder. This resemblance led, during the 19th century, to a confusion of the two vestments. The scarf was narrowed into the black stole, sometimes ornamented with crosses embroidered in the centre behind and at the ends, and this was gradually replaced by coloured stoles, varying according to the church's seasons. The stole, either black or coloured, is now almost universally worn by the Anglican clergy, even where the other "eucharistic vestments" have not been adopted. It may be noted that, whatever may be the case with the other reformed churches, it is unsafe to argue from the disuse of the stole in the Church of England that this was intended to symbolize the rejection of the major orders "in the Catholic sense," unless this sense be taken to imply a necessary connexion with the doctrine of transubstantiation and the sacrifice of the mass. (W. A. P.)

misdeamour, as in obtaining goods by false pretences. Recent possession of stolen property may, according to circumstances, support the presumption that the prisoner is a thief or that he is a receiver. The Prevention of Crime Act, 1871, made important changes in the law of evidence in charges of receiving. It allows, under proper safeguards, evidence to be given in the course of the trial of the finding of other stolen property in the possession of the accused, and of a previous conviction for any offence involving fraud and dishonesty. (2) Compounding theft, or *thesibote* (*redemptio furti*), that is, taking back stolen goods or receiving compensation on condition of not prosecuting, is a misdemeanour at common law. It need not necessarily be committed by the owner of the goods. Under the Larceny Act it is a felony punishable by seven years' penal servitude to take money or reward corruptly for helping to recover stolen goods without using all due diligence to bring the offender to trial. By the same act, to advertise or print or publish any advertisement offering a reward for the return of stolen goods, and using any words purporting that no questions will be asked, &c., renders the offender liable to a penalty of £50. This penalty must, by the Larceny (Advertisements) Act 1870, be sued for within six months, and the assent of the attorney-general is necessary. Various acts provide for the liabilities of pawnbrokers, publicans, marine-store dealers, and others into whose possession stolen goods come. Search for stolen goods can only be undertaken by a police officer under the protection of a search warrant. The law as to stolen goods, as far as it affects the civil rights and liabilities of the owner and third parties, is shortly as follows. As a general rule a purchaser takes goods subject to any infirmities of title. The property in money, bank-notes, and negotiable instruments passes by delivery, and a person taking any of these *bona fide* and for value is entitled to retain it as against a former owner from whom it may have been stolen. In the case of other goods, a *bona fide* purchaser of stolen goods in market overt (see SALE OF GOODS) obtains a good title (except as against the Crown), provided that the thief has not been convicted. After conviction of the thief the property reverts in the owner, and the court before which the thief was convicted may order restitution, except in the cases specially mentioned in the Larceny Act, *i.e.* the *bona fide* discharge or transfer of a security for value without notice and the fraudulent dealing by a trustee, banker, &c., with goods and documents of title to goods entrusted to him. After conviction of the thief the goods must be recovered from the person in whose hands they are at the time of the conviction, for any sales and resales, if the first sale was in market overt, are good until conviction of the thief. The protection given by market overt is unknown in Scotland. If the goods were obtained by false pretences and not by larceny, the question then is whether the property in the goods has passed or not, and the answer to this question depends upon the nature of the false pretences employed. If the vendee obtains possession of goods with the intention by the vendor to transfer both the property and the possession, the property vests in the vendee until the vendor has done some act to disaffirm the transaction. But if there was never any such intention—if, for instance, the vendor delivers the goods to A.B. under the belief that he is C.D.—the property does not vest in the transferee, and the owner may recover the goods even from a *bona fide* purchaser.

In the United States the law as to stolen goods is regulated by statute in the various states, but the broad principles are practically in accordance with English law. The doctrine of market overt is not, however, acknowledged by any state. The purchaser from a thief gets no title as against the owner. One who buys goods from a factor who procured them by larceny is not protected by the Factors Act in New York (*Soltau v. Gerdau*, 119 N.Y. 380). To the same effect (*Gentry v. Singleton* (1904), 128 Fed. R. 679) is a purchase of cattle from a thief. The U.S. Supreme Court held, in an action of detinue to recover five negro slaves, that the English rule as to sale in market overt did not apply in the United States (*Ventress v. Smith*, 10 Peters 175). In Pennsylvania there is no market overt and a purchaser of personal property cannot get a good title from one without

title by paying for it (1907, *Heisley v. Economy Tool Co.* 33, Pa. Super. Ct. 218). So in Maine (*Combs v. Gorden*, 59 Me. 111). In Massachusetts a sale of butter in the open market by one who had feloniously acquired possession of it did not transfer the property (*Dame v. Baldwin*, 8 Mass. 518). So held also in New York where horses stolen from there were sold in Canada, though a purchaser there is entitled to be reimbursed before delivering to the owner (*Edgerly v. Bush*, 81 N.Y. 199).

See also FALSE PRETENCES; LARCENY.

STOLICZKA, FERDINAND (1838–1874), Austrian palaeontologist, was born at Hochwald, in Moravia, in May 1838. He was educated at Prague and at the university of Vienna where he graduated Ph.D. He was encouraged to work at geology and palaeontology by Professor E. Suess and Dr M. Hoernes; and as early as 1859 he communicated to the Vienna Academy a description of some freshwater mollusca from the Cretaceous rocks of the north-eastern Alps. In 1861 he joined the Austrian Geological Survey, and in the following year he was appointed palaeontologist to the Geological Survey of India. In Calcutta the description of the Cretaceous fossils of Southern India was placed in his hands, and the publication of this great work which formed part of the *Palaentologia indica*, was commenced with the assistance of H. F. Blanford in 1863 and completed in 1873. During the last ten years of his life he published geological memoirs on the western Himalayas and Tibet, and numerous papers on all branches of Indian zoology, from mammals to insects and corals. In 1873 he was selected as naturalist and geologist to accompany a mission despatched by the Indian government to Yarkund and Kashgar under Mr (afterwards Sir Douglas) Forsyth. His health, which had been severely affected by his previous field work in India, proved unequal to the strain, and he died on the 19th of June 1874, at Shayok, in Ladak, while "returning loaded with the spoils and notes of nearly a year's research in one of the least-known parts of Central Asia."

Memoir (with bibliography) by V. Ball, appended to *Scientific Results of the second Yarkand Mission*, 1886; Obituary by W. T. Blanford, *Nature*, July 9, 1874.

STOLP, or **STOLPE**, a town of Germany, in the Prussian province of Pomerania, on the Stolpe, 10 m. from the Baltic Sea and 64 m. W. of Danzig on the railway to Stargard, and with branches to Stolpmünde and Neustettin. Pop. (1905), 31,154. The large church of St Mary, with a lofty tower, dating from the 14th century, the Renaissance castle of the 16th century, now used as a prison, and one of the ancient town-gates restored in 1872 are memorials of the time when Stolpe was a prosperous member of the Hanseatic League. It has also the church of St John, built in the 13th century, a new town hall, and a statue of Bismarck. The manufacture of machinery, amber articles, tobacco and cigars, and bricks, with some iron-founding, linen-weaving, and salmon-fishing in the Stolpe, are the chief industrial occupations of the inhabitants, who also carry on trade in grain, cattle, spirits, timber, fish and geese. Stolpmünde, a fishing-village and summer resort, at the mouth of the river, is the port of Stolpe.

Stolpe, mentioned in the 11th century, received town rights in 1273. From the 14th to the 16th century it was a member of the Hanseatic League. Until 1637, when it passed to Brandenburg, the town was generally in the possession of the dukes of Pomerania.

STOMACH (Gr. *στόμαχος* from *στόμα*, a mouth), the bag-like digestive organ which in man is situated in the upper left part of the abdomen. See, for anatomical details, ALIMENTARY CANAL. For the diseases of the stomach in general see DIGESTIVE ORGANS; and for special forms GASTRITIS, GASTRIC ULCER, DYSPEPSIA, &c.; also ABDOMEN (*Abdominal Surgery*).

Cancer of the Stomach is a common disease. It occurs for the most part in persons at or after middle life, and in both sexes equally. Its favourite situation is the outlet (pyloric cancer), where a hard, fibrous growth forms a contracting ring of the scirrhus variety. But when cancer attacks the inlet of the stomach, the tumour is of the scaly epitheliomatous variety. It often begins in the tissues of the end of the gullet, spreading downwards to the stomach. Chronic gastric ulcer is not unfrequently the starting point of cancer.

The symptoms of cancer of the stomach are apt to be indefinite (for many weeks or months). There may be long-standing complaints of "indigestion," which is sometimes made better, sometimes worse, by taking food. Then comes a feeling of discomfort which can be often localized, the individual pointing with his finger to a spot somewhere behind the end of the breastbone. Difficulty and pain in swallowing may be complained of when the cancer is beginning to block the inlet, but if it is situated at the pylorus the discomfort comes on an hour or two after a meal—at the time that the partially digested food is trying to make its way into the small intestine. Much of the food remains in the stomach and, undergoing fermentation, causes the evolution of gas which distends the stomach and gives rise to unavoidable belching. Later on vomiting occurs. The vomiting may take place every two or three days, enormous quantities of undigested food mixed with frothy, yeast-like mucous being thrown up. And whilst the stomach is slowly filling up again after one of these uncontrollable emptyings, sudden and violent movements of the individual may cause the fluid to give rise to audible "splashings." But even at this stage the disease may be unrecognizable, though the symptoms are extremely suggestive. But later the vomited matter is blackened by blood which has escaped into the stomach from the ulcerated growth. The patient then rapidly loses flesh and strength, and a hard lump may be felt in the upper part of the abdomen.

A characteristic feature of cancer is the carrying of the epithelial cells (which are the essential element of the growth) to the nearest lymphatic glands, and in cancer of the stomach the secondary implication of the glands may cause the formation of large masses between the stomach and the liver, which may press upon the large veins and give rise to dropsy. Secondary deposits are apt to form also in the liver and they may cause the appearance of a bulging below the ribs on the right side.

Another characteristic of cancer is that it spreads far and wide, drawing other tissues to itself by contracting fibrous bands. These are sometimes erroneously spoken of as the "roots" of cancer, and in the case of cancer of the stomach they may fix it to the pancreas, the liver, the bowels or the spine. The invasion of the lymphatic glands and the spreading of the growth into neighbouring organs, render the successful operative treatment of gastric cancer hazardous and disappointing. By the time that a tumour has made itself recognisable the probability is that it is too late for the attempt to be made for its removal. But in many cases the patient prefers that the abdomen should be opened for exploration for a possible operation than that he should hopelessly give himself over to the disease. And sometimes the surgeon is enabled by operation to give great relief, though the removal of the growth itself is impracticable.

When the growth is at the cardiac end of the stomach, blocking the gullet and causing slow starvation, the abdomen may advantageously be opened, and, the stomach having been fixed to the surface-wound, a permanent opening may be arranged for the introduction of an adequate amount of food. This operation is called *gastrostomy* and may be the means of giving many weeks of comfort to the unhappy patient—provided that its performance is not too long postponed. In the case of pyloric obstruction a permanent opening may be established between the stomach and a neighbouring piece of intestine, so that the food may find its way along the alimentary canal greatly to the relief of the symptoms of gastric dilatation. This is called "short-circuiting."

In some early cases of pyloric cancer resection of the disease may be performed, the upper end of the intestine being afterwards joined to the middle of the stomach by a kind of short-circuiting operation. In certain rare cases the whole of the stomach has been removed, the bowel being brought up and spliced to the end of the gullet.

In the case of gastric dilatation from pyloric obstruction great relief may be afforded by washing out the viscus by means of a long rubber tube, a funnel, and a jug of hot water, as originally suggested by Adolf Küssmaul.

Pyloroplasty.—Simple fibrous narrowing of the gateway of the stomach or of the intestine is dealt with by dividing it longitudinally and then suturing the edges of the wound transversely. This ingenious operation widens the track at the expense of an unimportant fraction of its length. In cases of great dilatation of the stomach with no obstruction to the outlet the slack of the walls may be gathered up by pleating and so permanently secured by suturing. Loreta's operation for dilatation of the outlet of the stomach is now rarely performed. (E. O. *)

STONE, CHARLES POMEROY (1824–1887), American soldier, was born in Greenfield, Massachusetts, on the 30th of September 1824. He graduated at West Point in 1845, and in the Mexican War earned two brevets for distinguished conduct. In 1856 he resigned from the army; and in 1857–1861 he led a scientific expedition in the state of Sonora, Mexico. He re-entered the service in 1861, and became a brigadier-general, United States Volunteers, but the defeat of a detachment at Ball's Bluff (Oct. 21, 1861) was attributed to him, and he was imprisoned

for six months, being then released without any charge being brought against him. After serving for short periods in the latter stages of the war, he resigned his commission (Sept. 1864). He was engineer and superintendent of a mining company in Virginia from 1865 to 1870, when he entered the military service of the khedive of Egypt, whose chief of staff and general aide-de-camp he became, with the rank of lieutenant-general and the title of "Firik Pasha." He returned to the United States in 1883, and resumed his engineering work. He died in New York City on the 24th of January 1887.

STONE, EDWARD JAMES (1831–1897), British astronomer, was born in London on the 28th of February 1831. Educated at the City of London School, he obtained a studentship at King's College, London, and in 1856 a scholarship at Queen's College, Cambridge, graduated as fifth wrangler in 1859, and was immediately elected fellow of his college. The following year he succeeded the Rev. R. Main as chief assistant at the Royal Observatory, Greenwich, and at once undertook the fundamental task of improving astronomical constants. The most important of these, the sun's mean parallax, was at that time subject to considerable uncertainty. From a discussion of the observations of Mars made in 1860 and 1862 at Greenwich and Williams-town (near Melbourne), Stone deduced for it a value of $8.932''$ (*Mon. Not. R.A.S.* xxiii. 183), and in a further investigation in which he included the observations made in 1862, at the Cape of Good Hope, he obtained $8.945''$ (*Mem. of R.A.S.*, vol. xxxiii.). Confirmatory results were afforded by his discussion of the observations of the transit of Venus in 1769 which yielded the figure $8.91''$ (*Mon. Not. R.A.S.* xxviii. 255). In 1865 he contributed a memoir to the Royal Astronomical Society on the constant of lunar parallax. He also determined the mass of the moon, and from a discussion of the Greenwich transit circle observations between 1851 and 1865 he found for the constant of nutation the value $9.134''$. These services were recognized by the award of the Royal Astronomical Society's gold medal in 1869, and on the resignation of Sir Thomas Maclear in 1870 he was appointed Her Majesty's astronomer at the Cape. His first task on taking up this post was the reduction and publication of a large mass of observations left by his predecessor, from a selected portion of which (those made 1856–1860) he compiled a catalogue of 1159 stars. His principal work was, however, a catalogue of 12,441 stars to the 7th magnitude between the South Pole and 25° S. declination, which was practically finished by the end of 1878 and published in 1881. Shortly after the death of Main on the 9th of May 1878, Stone was appointed to succeed him as Radcliffe Observer at Oxford, and he left the Cape on the 27th of May 1879. At Oxford he extended the Cape observations of stars to the 7th magnitude from 25° S. declination to the equator, and collected the results in the *Radcliffe Catalogue* for 1890, which contains the places of 6424 stars. Stone observed the transit of Venus of 1874 at the Cape, and organized the government expeditions for the corresponding event in 1882. He was elected president of the Royal Astronomical Society (1882–1884), and he was the first to recognize the importance of the old observations accumulated at the Radcliffe Observatory by Hornsby, Robertson and Rigaud (*Mon. Not. R.A.S.*, vol. lv.). He successfully observed the total solar eclipse of the 8th of August 1896 at Novaya Zemlya, and purposed a voyage to India for the eclipse of 1898, but died suddenly at the Radcliffe Observatory on the 9th of May 1897. The number of his astronomical publications exceeds 150, but his reputation depends mainly on his earlier work at Greenwich and his two great star catalogues—the *Cape Catalogue* for 1880 and the *Radcliffe Catalogue* for 1890.

See *Proc. Roy. Society*, lxii. 10; *Month. Not. Roy. Ast. Soc.* lviii. 143; *The Times*, 10th of May 1897; *Observatory*, xx. 234; *Astr. Nach.* No. 3426; *Roy. Soc. Cat. Scient. Papers.* (A. M. C.)

STONE, FRANK (1800–1850), British painter, was born in Manchester, and was entirely self-taught. He was elected an associate of the Society of Painters in Water Colours in 1833 and member in 1843; and an associate of the Royal Academy in 1851. The works he first exhibited at the Academy were portraits, but

from 1840 onwards he contributed figure pictures, scenes from Shakespeare, scripture and sentimental subjects, many of which were engraved.

STONE, GEORGE (1708–1764), archbishop of Armagh, was the son of Andrew Stone, a London banker, and was educated at Westminster School and Christ Church, Oxford. Having taken holy orders his advancement in the Church was very rapid, mainly through the influence of his brother Andrew. Andrew Stone (1703–1773), who was five years older than George, became private secretary to the duke of Newcastle about 1729, and was for many years on the most intimate and confidential terms both with the duke and with his brother Henry Pelham. In 1734 he was appointed under-secretary of state, and he soon gained a position of great personal influence with George II. by whom he was made tutor to Prince George, afterwards George III. On the accession of the latter to the throne, Andrew Stone was appointed treasurer to Queen Charlotte, and attaching himself to Lord Bute he became an influential member of the party known as “the king’s friends,” whose meetings were frequently held at his house. He was, therefore, well able to promote the preferment of his brother George, who went to Ireland as chaplain to the duke of Dorset when that nobleman became lord-lieutenant in 1731. In 1733 George Stone was made dean of Ferns, and in the following year he exchanged this deanery for that of Derry; in 1740 he became bishop of Ferns, in 1743 bishop of Kildare, in 1745 bishop of Derry, and in 1747 archbishop of Armagh. During the two years that he occupied the see of Kildare he was also dean of Christchurch, Dublin.

From the moment that he became primate of Ireland, Stone proved himself more a politician than an ecclesiastic. “He was said to have been selfish, worldly-minded, ambitious and ostentatious; and he was accused, though very probably falsely, of gross private vice.”¹ His aim was to secure political power, a desire which brought him into conflict with Boyle, the Speaker of the Irish House of Commons, who had organized a formidable opposition to the government. The duke of Dorset’s reappointment to the lord-lieutenancy in 1751, with his son Lord George Sackville as secretary of state for Ireland, strengthened the primate’s position and enabled him to triumph over the popular party on the constitutional question as to the right of the Irish House of Commons to dispose of surplus Irish revenue, which the government maintained was the property of the Crown. But when Dorset was replaced by the duke of Devonshire in 1755, Boyle was raised to the peerage as earl of Shannon and received a pension, and other members of the opposition also obtained pensions or places; and the archbishop, finding himself excluded from power, went into opposition to the government in alliance with John Ponsonby. These two, afterwards joined by the primate’s old rival Lord Shannon, and usually supported by the earl of Kildare, regained control of affairs in 1758, during the viceroyalty of the duke of Bedford. In the same year Stone wrote a remarkable letter, preserved in the *Bedford Correspondence* (ii. 357), in which he speaks very despondingly of the material condition of Ireland and the distress of the people. The archbishop was one of the “undertakers” who controlled the Irish House of Commons, and although he did not regain the almost dictatorial power he had exercised at an earlier period, which had suggested a comparison between him and Cardinal Wolsey, he continued to enjoy a prominent share in the administration of Ireland until his death, which occurred in London on the 19th of December 1764.

Although this “much-abused prelate,” as Lecky calls him, was a firm supporter of the English government in Ireland, he was far from being a man of tyrannical or intolerant disposition. It was due to his influence that in the anti-tithe disturbances in Ulster in 1763 the government acted with conspicuous moderation, and that the movement was suppressed with very little bloodshed; he constantly favoured a policy of conciliation towards the Roman Catholics, whose loyalty he defended at

different periods of his career both in his speeches in the Irish House of Lords and in his correspondence with ministers in London. Archbishop Stone, who never married, was a man of remarkably handsome appearance, and his manners were “eminently seductive and insinuating.” Richard Cumberland, who was struck by the “Polish magnificence” of the primate, speaks in the highest terms of his courage, tact, and qualities as a popular leader. Horace Walpole, who gives an unfavourable picture of his private character, acknowledges that Stone possessed “abilities seldom to be matched”; and he had the distinction of being mentioned by David Hume as one of the only two men of mark who had perceived merit in that author’s *History of England* on its first appearance. He was himself the author of several volumes of sermons which were published during his lifetime.

See Richard Mant, *History of the Church of Ireland*, vol. ii. (London, 1840); J. A. Froude, *The English in Ireland in the Eighteenth Century* (3 vols., London, 1872–1874); W. E. H. Lecky, *History of Ireland in the Eighteenth Century* (5 vols., London, 1892); J. R. O’Flanagan, *Lives of the Lord Chancellors and Keepers of the Great Seal of Ireland* (2 vols., London, 1870); Richard Cumberland, *Memoirs* (London, 1806); F. Hardy, *Memoirs of the earl of Charlemont* (2 vols., 2nd ed., London, 1812); Horace Walpole, *Memoirs of the Reign of George II.* (3 vols., London, 1846); *Bedford Correspondence* (3 vols., London, 1842–1846); *Correspondence of Chatham* (4 vols., London, 1838–1840). (R. J. M.)

STONE, LUCY [BLACKWELL] (1818–1893), American reformer, anti-slavery and woman’s-rights leader, was born in West Brookfield, Massachusetts, on the 13th of August 1818. Her father refused her the college education that she so eagerly desired, but she earned enough to carry her through Oberlin College, where she graduated in 1847. She immediately went on the lecture platform as an advocate of abolition and of woman’s rights, and her remarkable voice and commanding eloquence often held in check the most disorderly audiences. In 1855 she married Dr Henry B. Blackwell (1824–1909), a prominent abolitionist and advocate of woman’s rights, who agreed that she should keep her maiden name; after 1870 he assisted his wife in the management of the *Woman’s Journal* of Boston, of which she became editor in 1872. She allowed her New Jersey property to be sold for taxes, and then published a pamphlet on “taxation without representation.” She campaigned for woman’s suffrage amendments in Kansas (1867), Vermont (1870), Michigan (1874), Colorado (1877) and Nebraska (1892). She died in Dorchester, Mass., on the 18th of October 1893. Her daughter, ALICE STONE BLACKWELL (b. 1857), carried on, with her father, the *Woman’s Journal* after 1893, and in 1885–1905 edited the *Woman’s Column*.

Her husband’s sisters, ELIZABETH BLACKWELL (1821–1910) and EMILY BLACKWELL (1826–1910), were prominent physicians. The former graduated at the Geneva Medical College, Geneva, New York, in 1849, receiving the first physician’s degree granted to a woman in the United States, and studied in Philadelphia, in Paris and in London, where she began to practise in 1869. She died at Hastings on the 1st of June 1910. Emily Blackwell graduated at the Medical Department of Western Reserve University in 1854; in 1853, with her sister, she founded the New York Infirmary for Women and Children; and she was for many years dean of the Woman’s Medical College of the New York Infirmary which she and her sister established in 1865.

STONE, MARCUS (1840–), English painter, son of Frank Stone, A.R.A., was trained by his father and began to exhibit at the Academy before he was eighteen; and a few years later he illustrated with much success books by Charles Dickens, Anthony Trollope, and other writers, friends of his family. He was elected an associate of the Royal Academy in 1877, and academician in 1887. In his earlier pictures he dealt much with historical incidents, but in his later work he occupied himself chiefly with a particular type of dainty sentiment, treated with much charm, refinement and executive skill. One of his canvases is in the National Gallery of British Art. Most of his works have been engraved, and medals have been awarded to him at exhibitions in all parts of the world.

See *The Life and Work of Marcus Stone, R.A.*, by A. L. Baldry (*Art Journal* office, 1896).

¹ W. E. H. Lecky, *Hist. of Ireland in the Eighteenth Century* (1892), i. 462.

STONE, NICHOLAS (1586–1647), English sculptor and architect, was the son of a quarryman of Woodbury, near Exeter, and as a boy was apprenticed to Isaac James, a London mason. About 1603 he went to Holland and worked under the sculptor Hendrik de Keyser (1567–1621) and his son Pieter, and married his master's daughter. Stone is said to have made the portico to the Westerkerk at Amsterdam. Returning to London about 1613 with Bernard Janssens (*fl.* 1610–1630), a fellow pupil,¹ he settled in Southwark and obtained a large practice; in 1619 he was appointed master-mason to James I., and in 1626 to Charles I.; and he died in London on the 24th of August 1647. Stone, whose work is associated with Inigo Jones's introduction of Renaissance architecture into England, ranks as the great sculptor of his time and the rejuvenator of the art in England. He is best known by his monuments, notably those to Sir Francis Vere, the earl of Middlesex, and Francis Holles in Westminster Abbey; Sir Dudley Digges at Chilham church, Kent; Henry Howard, earl of Northampton, in Dover Castle (removed to Greenwich); Sir Thomas Sutton, at the Charterhouse (with Janssens); Sir Robert Drury at Hawstead church, Suffolk; Sir William Stonhouse at Radley church, Berkshire; Sir Thomas Bodley at Merton College, Oxford; Sir William Pope, in Wroxton church, near Banbury; Sir Nicholas Bacon, in Redgrave church, Suffolk (with Janssens); Dr John Donne (winding-sheet), at St Paul's Cathedral; and Sir Julius Caesar, in St Helen's, Bishopsgate.

He had three sons: John (d. 1667), a sculptor; Henry (d. 1653)—commonly known as “Old Stone”—a painter, whose copies of Van Dyck were famous, and whose portraits of Charles I. and others are in the National Portrait Gallery; and Nicholas (d. 1647), a sculptor, who worked under Bernini at Rome and left a sketch-book, which, with a note-book of his father's (giving a list of his works between 1614 and 1641), is in the Soane Museum.

See an article by A. E. Bullock in the *Architectural Review*, 1907, and the same author's illustrated monograph *Some Sculptural Works of Nicholas Stone* (Batsford, London, 1908).

STONE, a market town in the western parliamentary division of Staffordshire, England, on the river Trent, 7 m. N. of Stafford by the North Staffordshire railway. Pop. of urban district (1901), 5680. Part of the walls and crypt remain of an abbey which dates from the foundation of a college of canons in 670. The church of St Michael dates from 1750, the abbey church having collapsed in the previous year. Alleyne's grammar school is a foundation of 1558. The chief industry is shoemaking, but malting, brewing and tanning are also carried on. At Bury Bank, on the hills to the north, an earthwork is traditionally considered to be the site of the capital of the Kingdom of Mercia; there are other works in the neighbourhood at Saxon Low.

STONE (O. Eng. *stán*; the word is common to Teutonic languages, cf. Ger. *Stein*, Du. *steen*, Dan. and Swed. *sten*; the root is also seen in Gr. *στῆλα*, pebble), a detached piece or fragment of rock. The word is thus applied to the small fragments scattered in the ground or on roads, to the water-worn pebbles of the sea shore or river beds, and to the hewn, dressed or shaped rock used as a building material, with which this article deals. A qualifying word generally accompanies “stone” when the term is applied to pieces of rock cut to a particular size and shape and used for a specific purpose, e.g. “mill-stone,” “hearth-stone,” “grave-stone,” &c. The term “precious stone” is used of those minerals which, from their beauty of colour, &c., their rarity, and sometimes their hardness, are valued for their suitability for ornaments (see GEMS). The word is also often applied to many objects resembling a stone or pebble, such as the hard kernel of certain fruits, as of the cherry, plum, peach, &c., or the *calculi* or con-

¹ Also called Janssen (*Dict. Nat. Biog.*), Jansen and Janson. Possibly he was the brother of the Gerard (Geraert) Jansen or Johnson, of Southwark, who in 1616 executed the bust of Shakespeare in Stratford church; but it is uncertain whether the latter was identical with, or the son of, the Dutch tomb-maker Gerard Jansen described in Sir W. Dugdale's *Diary* as having, in 1593, lived for twenty-six years in England and as the father of five sons.

cretions sometimes formed in the gall or urinary bladder or the kidneys (see BLADDER DISEASES and KIDNEY DISEASES). The “stone” has been a common measure of weight in north-western Europe. In Germany the “Stein” was of 20 to 22 lb. In the British system of weights the “legal” stone, or “horseman's” weight is of 14 lb avoirdupois; in weighing wool it was also of 14 lb, but is now usually 16 lb. The “customary” stone for fish or butcher's meat is of 8 lb.

Building-stone.—In selecting a stone for building purposes many important points have to be considered. The stone must be strong enough to bear the load placed upon it, it must be durable and weather well in the atmosphere of the district, and its colour and appearance need to be studied. It must further be ascertained whether a sufficient supply is available, and the price also must be taken into account; some difficulty is often experienced in obtaining a suitable stone at a moderate cost, and considerations of expense frequently have more to do with the choice of a stone than the architect would wish. Where there is risk of fire, as is often the case in business and factory premises, it is necessary to select a stone able to stand the effect of a great heat without damage. Great experience of the strength of stones and of their behaviour in different situations is desirable; but even when this knowledge is given and the greatest care is combined with it, some point may be overlooked. For example, the stone facing of the Houses of Parliament at Westminster was chosen on the recommendation of a committee composed of men of eminent scientific and technical skill; yet it has not weathered well because it is not constituted to resist the destroying effects of the London atmosphere.

The prime factor in the choice of a building stone should be the climate to which the material has to be exposed. Stone that in the pure country air has proved extremely durable may quickly decay in an impure city atmosphere, or when subjected to the strong salt winds from the sea. Extremes of temperature, too, are, generally speaking, prejudicial to the life of stone, the alternations of heat and cold setting up movements in the substances of the stone, which, though slight, will in many cases hasten its disintegration. There are few materials which more quickly decay and fail than stone placed under unsuitable conditions. An analysis, made by E. G. Clayton, of a sample of incrustation found on the Portland stone masonry of St Paul's Cathedral, London, gave the following result:—

	Weight per cent.
Water (lost at 100°)	2·06
Water (lost at 150°)	22·48
Carbon (soot)	1·10
Calcium sulphate	59·38
Calcium phosphate	2·22
Calcium silicate	1·63
Magnesium silicate	0·67
Iron silicate	2·40
Sand and uncombined silica	8·06
	100·00

The deposit when reduced to a fine grey powder and placed under the microscope did not appear to contain any organic matter. Mr Clayton says that this test points to the fact that the principal constituent of limestones, namely calcium carbonate, has been changed into calcium sulphate by the action of sulphurous and sulphuric acids ever present in the smoky London air. Impurities of this nature lodge on the face of the stone and are diluted and driven into the pores by subsequent rain. Having by their chemical action destroyed a portion of the substance of the material, they cause a slight crust to form on the surface which is in turn washed off. Carbonates of lime and magnesia, the chief constituents of ordinary marbles and limestones, are very susceptible to the solvent action of these acids. Pure water has little or no chemical action upon most building stones, but a danger arises to a porous stone even when situated in pure air. Water will soak into some stones in considerable quantities, and in frosty weather this fact constitutes a serious menace to the rock; for water when passing from the liquid to the solid state exerts if checked an enormous pressure, and the face, and sometimes the bulk, of the stone is frequently damaged in this way. One of the best precautions that can be taken by an architect is a personal visit to the quarry, to examine the stone in its natural situation. This, of course, will give little clue to its behaviour in an impure atmosphere, and therefore, if the particular stone has been previously used in the same district, the buildings in which it has been employed should also be inspected. A hard and lasting stone will show the marks of the tooling, and the arrises of the blocks will be sharp and good, even after many years' exposure.

The colour has a considerable bearing upon the selection of a stone, but this, although a very important matter, must give way before the question of durability. In large towns and

Colour. manufacturing districts this is most emphatically the case, for within a few years of erection the exterior of a building in such districts is disguised under a coating of soot and grime.

Should the stone contain iron, especially in the form of "pyrites," there is a great likelihood of its being stained more or less badly by iron "rust." If the metal is distributed evenly in small particles throughout the mass the rusting may do no more harm than merely deepen the tone of the stone, but if present in large pieces the stain may be so serious as to spoil the appearance entirely.

When the durability of stone has not been tried over some considerable period in a building actually erected, the most careful

Testing. physical and chemical tests should be made. If the stone passes the following tests satisfactorily it may safely be assumed to be of good quality and likely to prove durable: (1) Resistance to crushing; (2) acid test; (3) absorption test; (4) microscopical examination.

The resistance to crushing varies to an enormous extent with the different kinds of stone, from a little over 60 tons per square foot, which is the limit for a weak limestone, up to a load of over 1300 tons necessary to crush the hardest granites. In general practice the load placed upon stone should not exceed one-tenth of the crushing weight as found by testing typical specimens. A six-inch cube is a convenient size often adopted for the blocks to which the crushing test is to be applied.

The effect produced by soaking pieces of stone for some days in a 1% solution of sulphuric and hydrochloric acids will decide roughly whether it will be durable in a city atmosphere. The vessel containing the test should be agitated twice a day; the action of the acid is to dissolve any portions of the stone that would be decomposed by the action of smoke and acid fumes.

A block of the stone under consideration should be dried thoroughly in a warm kiln or oven and carefully weighed before it has time to absorb moisture from the air. It must then be placed to soak in clean water for twenty-four hours and after removal again weighed. The difference between the weights registered will give the weight of water absorbed, and this should not be more than 10% of the weight of the dry block. There are, however, exceptions to this test, some very porous stones being capable of taking up a large quantity of water and at the same time proving durable in use. But such material is liable to allow damp to penetrate through it to the interior of the building in which it is employed.

The microscope is the best means of determining the structure of a stone, and of recognizing the presence of matter likely to affect its usefulness adversely. Should iron pyrites be discovered in any quantity the stone should be rejected, as this impurity easily decomposes on exposure, and badly stains and sometimes splits the stone.

The hardest, least absorbent, and most compact and uniform stones are of ancient geological formation, and with time and increase of superimposed pressure have become dense and very hard. The softer stones are of later formation, and are usually lighter in weight and more porous. A good stone should ring clearly when struck with steel, and a fresh fracture should on examination be bright, clean and sharp in texture and free from loose grains. A dull earthy appearance indicates an inferior stone.

A simple test for determining whether a stone contains much earthy matter is this: Some small chippings from the stone are placed in a vessel with sufficient water to cover the pieces, and are left undisturbed for about three-quarters of an hour. The water is then gently agitated. With stone of a highly crystalline nature, having its particles well cemented together, the water will remain clear, but stone containing earth and clay will cause the water to become thick and cloudy in appearance.

The action of the air of certain districts has been shown to be prejudicial to the durability of many stones. A striking instance

Preservative lives. of this peculiarity is afforded by Cleopatra's Needle on the Thames Embankment. This is an Egyptian

monument of carved granite which undoubtedly stood for some thousands of years with little deterioration on the spot from which it was removed. But since its erection in London it has been found necessary to coat it periodically with a preservative solution in order to check the rapid decay set up by the impurities of the London atmosphere. Similarly the Egyptian obelisk in Central Park, New York, U.S.A., has for the same reason been coated with a preparation of paraffin containing creosote dissolved in turpentine. The surface of the stone was heated by means of lamps and charcoal stoves, and the compound applied hot.

The most usual method adopted for preserving stonework is to paint the exposed surfaces with ordinary oil colour. This fills the pores of the stone and forms a coat which, though weather-proof, completely hides the natural beauty of the stone. The painting must be redone every four or five years. *Boiled linseed oil* is sometimes used on stonework, one or more coats being well brushed in after cleaning it. Its use deepens the colour of the stone, and unless very carefully done the work is apt to appear patchy. A large number of processes consist of coating the stonework with a

solution of soluble silica. In *Kuhlmann's process* a solution of silicate of potash or soda is brushed into the stone and, aided by the carbonic acid in the air, acts upon some of the constituents of the stone and forms a hard surface which is not liable to decay. In *Ransome's process*, a solution of silicate of soda is applied until the surface of the stone has become saturated. This is allowed to dry and a solution of chloride of calcium is then applied in a similar manner. The two solutions act together and by decomposition produce an insoluble silicate of lime which fills the pores of the stone and binds its particles together, thereby checking decay. *Baryta water* will, when applied to limestone that has decayed owing to the action of sulphurous fumes, penetrate into and solidify the crumbling portions, with the result that the stone is reconstituted and becomes hard and quite solid. Professor A. H. Church employed this method in arresting the decay of the frescoes in the Houses of Parliament and the stonework of the chapter house at Westminster was also treated by him in the same manner. *Fluate* is the name given to a siliceous preservative specially recommended for use upon the limestones from the Bath district. It may also be applied to other limestones, and to bricks, tiles, terra-cotta, &c. It does not materially change the appearance of the stone but enters the pores and prevents decay. Stonework that is much decayed may be restored by Tabard's Metallic Stone, which is a natural stone of trachyte origin reduced to powder. The stone is restored to its original condition by mixing the powder with an acid which softens and reunites the molecules without decomposition. The invention is of French origin and has been used for much important work on the continent of Europe and in England.

The natural bed of a stone is that surface on which it was originally deposited. But volcanic and other disturbances may have occurred since that time and completely altered its "lie"; and therefore it frequently happens that a horizontal **Natural Bed.** line does not coincide with the natural bed of stone as it rests in the quarry. Care must be taken, however, before using the stone in a building, to find the proper bed and to set all stones with their laminae quite level. Exceptions to this rule occur in the projecting stones of cornices and string courses, especially those with undercut members which would be likely to drop off were the natural bed level; in these cases the stones should be placed on edge with the laminae vertical, except of course at the angles of the building where the stone must be specially selected and laid on its natural bed. Limestones and sandstones which are granular in structure and are found with wide planes of cleavage, giving deep beds which can be quarried in large blocks having no tendency to split in any particular direction, are known as freestone.

Stone fresh from the quarry is found to contain a quantity of moisture called "quarry sap," on account of which all stones (even granite) are comparatively soft when first quarried. **Seasoning.** This water gradually evaporates, and after some months' exposure stones that were quite soft and weak when quarried acquire hardness and strength. For these reasons it is desirable from an economical point of view to "work" the stone to its desired shape and mould and carve it when soft and easily workable. By adopting this method a considerable saving in carriage will be effected, and the durability of the stone is enhanced, for the quarry sap on drying out leaves a hard outer crust or protective skin which would be removed if the working of the stone were left until it had become seasoned. It is an interesting fact that Sir Christopher Wren directed that the stones used in the erection of St Paul's Cathedral should be seasoned for three years on the sea beach.

Building-stones are divided into several groups; limestones and sandstones are classified as aqueous or stratified rock, **Varieties.** granite being the principal igneous or unstratified stone.

Limestones consist chiefly of calcium carbonate with small proportions of other substances. They are often classified under four heads: *Compact* limestones consist of carbonate of lime, either pure or in combination with clay and sand. *Granular* or *oolitic* limestones consist of grains of carbonate of lime cemented together by the same substance or mixed with sand and clay. The grains are egg-shaped (hence the name "oolite") and vary in size from tiny particles to grains as large as peas. *Shelly* limestones consist almost entirely of small shells, cemented together by carbonate of lime. *Magnesian* limestones are composed of carbonates of lime and magnesia in varying proportions, and usually also contain small quantities of silica, iron and alumina. Stones having less than 15% of magnesia are not classed under this head. *Dolomites* are limestones containing equal proportions of carbonate of lime and carbonate of magnesia. Many of the finest building-stones are limestones. In England typical examples are the Bath stones, Portland stone and Kentish ragstone, and in America those from the states of New York, Indiana (Bedford quarry, light brown stone), Illinois (Grafton and Chester quarries) and Kentucky (Bowling Green stone, light grey, similar to Portland). Notable French limestones are obtained from the quarries at Peuren (cream), Château-Gaillard (white), Abrots, Normandoux (white), and Villars (light brown). The hardest and closest grained of these are capable of taking a fine polish. Limestones should be used with care as they are uncertain in their behaviour and usually more difficult to work than sandstones, and as a general rule they do not stand the

action of fire well. On being treated with a dilute acid, limestones will effervesce and by this test they can easily be identified. Limestones weigh between 130 lb and 166 lb per cubic foot. They vary in colour, but most of them are cream or yellowish brown. *Marble* is a limestone which has been changed by the action of heat and pressure into a crystalline form. Many beautiful varieties are found which are suitable for interior decoration, such as for columns, wall lining, paving, &c., and in dry sunny climates they may be employed with great effect in external situations. They will take a high polish and the fine grained varieties are well adapted for intricate carving. The principal supplies of marble are drawn from Italy, Belgium and France, but the marbles from Ireland and those from Devonshire and Derbyshire possess a remarkable range of colour and variety of markings. America has few notable coloured marbles; most of the stones quarried are white or black. The states of Vermont (West Rutland and Sutherland Falls quarries), Tennessee and Georgia produce large quantities of marble. *Marezzo* and *scagliola* are imitations of marbles, and their manufacture and use are described in PLASTERWORK.

Sandstones are composed of grains of sand held together by a cementing substance to form a compact rock. The cementing medium may be silica, alumina, carbonate of lime or an oxide of iron. Those stones that have a siliceous cement are the most durable. Sandstones vary more in colour than limestones, the colour being largely due to the presence of iron. Cream, brown, grey, pink, red, light and dark blue, and drab are common colours. Typical British sandstones are Corsehill (red) from Dumfriesshire, the Yorkshire sandstones (brown), Pennant stone and Forest of Dean (blue and grey) from Gloucestershire. In America sandstones are quarried in many states, principally Connecticut (brown stone), New York (Potsdam red stone), Ohio (Amherst Berea and other quarries, light brown or grey stone) and Massachusetts (Longmeadow brown stone). The texture of sandstones varies from a fine, almost microscopical, grain to one composed of large particles of sand. It will generally be found that the heaviest, densest, least porous and most lasting stones are those with a fine grain.

Granites are igneous rocks formed by volcanic action and are of all geological ages. Granite is composed of quartz, felspar and mica intimately compacted in varying proportions to form a hard granular stone. Quartz is the principal constituent and imparts to the rock the qualities of durability and strength. Stones containing a large proportion of quartz are hard and difficult to work. Felspar of an earthy nature is opaque in appearance and is liable to decay; it should be clear and almost transparent. The characteristic colour of the granite is generally due to this substance, but the stone is often affected by the nature of the mica it contains, whether it be light or dark in tint. Granite is the hardest, strongest and most durable of building-stones, and is difficult and costly to work. When polished, many varieties present a beautiful and lasting surface. By reason of its strength and toughness this stone is often used for foundations, bases, columns, kerbs and paving and in all positions where great strength is required. The granites from the Peterhead and Aberdeen districts of Scotland and from Cornwall and Devonshire in England are much used. In the United States good granites are quarried in Connecticut, Massachusetts and Minnesota. Canada, especially the eastern provinces, supplies many excellent varieties of granites. Much granite is also exported from Norway and Sweden. *Syenitic granite* contains hornblende in addition to quartz, felspar and mica. True *syenite* consists of quartz, felspar and hornblende, the latter taking the place of mica. It obtains its name from a stone found at Syene in Egypt, but it has since been discovered that this stone is not a "syenite" as it actually contains more mica than hornblende. These rocks are very hard and are used more for paving and road-metalling than for building purposes.

Slates.—The slate used for roofing and other purposes in building is a fine-grained and compact rock composed of sandy clay which has been more or less metamorphosed by the action of heat and tremendous pressure. Such rocks were originally deposited in the form of sediment by the sea or river, afterwards becoming compacted by the continual heaping up of superincumbent material. Owing no doubt to some sliding motion having at some time taken place, slaty rocks are capable of being split into thin sheets which are trimmed to the various marketable sizes. A good slate is hard, tough and non-absorbent, will give out a metallic ring if struck, and when trimmed it will not splinter nor will the edges become ragged. Slates range in colour from purple to grey and green. The best-known British slates are those of the Welsh and Westmorland quarries. In America good slate is found in the states of New York, Pennsylvania and Maine. (See also ROOFS.)

There are several kinds of artificial stone on the market, consisting of fine cement concrete placed to set in wooden or iron moulds.

Artificial Stone.

Although from an artistic point of view its use is not desirable, it is prepared with such care that its cheapness, strength and uniform character have led to its wide employment. One of the best-known varieties is *Victoria stone* which is composed of finely crushed Mount Sorrel (Leicestershire) granite and Portland cement, carefully mixed by machinery in the proportions of three to one, and filled into moulds of the required

shape. When the blocks are set hard the moulds are loosened and the blocks placed in a solution of silicate of soda for about two weeks for the purpose of indurating and hardening them. Many manufacturers turn out a material that is practically non-porous and is able effectually to resist the corroding influence of sea air or the impure atmosphere of large towns.

See Rivington's *Notes on Building Construction*, vol. iii.; F. E. Kidder, *Building Construction and Superintendence*, vol. i.; P. Merrill, *Stones for Building and Decoration* (American); H. Blagrove, *Marble Decoration*; W. R. Johnson, *Report on Building Stone for Extension of United States Capitol*; *Report of Committee upon the Decay of Stone at the Palace at Westminster*. (J. Bt.)

STONE AGE, the term employed by anthropologists to describe the earliest stage of human civilization when man had gained no knowledge of metals, and his weapons and utensils were formed of stone, horn or bone. The term has no chronological value, as the Stone Age was earlier in some parts of the world than in others, and even to-day races exist who are still in their Stone Age. This first period of human culture has been subdivided by Lord Avebury into *Palaeolithic* and *Neolithic*, words which have been generally accepted as expressing the two stages of the rough, unpolished and the finely finished and polished stone implements. (See ARCHAEOLOGY.)

STONE-FLY, the name given to medium-sized, neuropterous insects of the family Perlidae with long flexible antennae, wide thoracic sternae and with the wings resembling, as regards size, shape and the fan-like folding of the posterior pair, those typical of the Orthoptera except that the anterior pair is membranous and not coriaceous. The immature forms, which are aquatic, carnivorous and active, are very like the adults except in the absence of wings and in their method of respiration, which is either cutaneous or effected by means of variously placed integumental tufts richly supplied with tracheae. By some authors the Perlidae are regarded as a special order, Plecoptera; by others as a sub-order of an order Platyptera, which contains the Termitidae and some other insects as well.

STONEHAM, a township of Middlesex county, Massachusetts, U.S.A. Pop. (1890), 6155; (1900), 6197; (1910, U.S. census), 7090. Area, 6.6 sq. m. In the township is Spot Pond, a large lake with islets, so named in 1632 by Governor John Winthrop and others who then first discovered it; it is a storage basin for the Metropolitan Water District, and supplies Medford, Melrose and Stoneham. A large part (730 acres) of the Middlesex Fells Reservation of the Metropolitan Park System is in Stoneham. The village of Stoneham, with the only post office in the township, is about 9 m. north by east of Boston, and is served by the Boston & Maine railway and by inter-urban electric lines; it has a public library. Steam power was first used in the manufacture of shoes in Stoneham by John Hill & Co., who introduced many labour-saving devices, notably the heeling machine (1862). Stoneham, long a part of Charlestown and first settled about 1668, was incorporated as a township in 1725, but its boundaries have been frequently changed since then.

STONEHAVEN (locally *Stanehive*), a police burgh, seaport and county town of Kincardineshire, Scotland, 15 m. S.S.W. of Aberdeen by rail. Pop. (1901), 4577. It consists of two quarters, the old town picturesquely situated on the south bank of the Carron and the new on the land between this stream and the Cowie, the two being connected by the bridge which carries the main road from the south to Aberdeen. The principal buildings are the market-house and town hall, and the industries include distilling, brewing, tanning, the making of net, rope and twine and woollen manufactures. The harbour, a natural basin, is protected on the south-east by cliffs and has a quay. The trade is mostly in coal and lime and the exports are chiefly agricultural. The town is an important centre of the fishing industry, and has become a favourite watering-place. On the decay of Kincardine, the original capital, Stonehaven became the county town in 1600, and suffered heavily during the covenanting troubles, Montrose setting it on fire in 1645. The Slug Road to Banchory-Ternan, or Upper Banchory (pop. 1475), 15 m. distant, a favourite residential resort of Aberdeen citizens, begins at Stonehaven. It pursues mainly a north-western direction, at one point being carried over the shoulder of Cairn mon-earn (1245 ft.).

STONEHENGE (Sax. *Stanhengist*, hanging stones), a circular group of huge standing stones (see **STONE MONUMENTS**), situated on Salisbury Plain, Wiltshire, England, about 7 m. N. of Salisbury. Until comparatively recent times the surrounding district was in a state of nature with merely a thin coating of turf interspersed with tufts of heath and dwarf thistles, but bare of trees and shrubs and altogether devoid of the works of man, with the exception of a series of prehistoric barrows of the Bronze Age which, singly and in groups, studded the landscape. It is safe to say that no prehistoric monument in Great Britain has given rise to more speculation as to its origin, date and purpose; and although the few hoary stones still extant are but a small portion of the original structure they are still sufficiently imposing to excite the wonder of the passing traveller, and mysterious enough to puzzle the antiquary.

Stonehenge was first mentioned by Nennius in the 9th century, who asserts that it was erected in commemoration of the 400 nobles who were treacherously slain near the spot by Hengist in 472. A similar account of its origin is given in the triads of the Welsh bards, where its erection is attributed to Aurelius Ambrosius, the successor of Vortigern. This was regarded as a miraculous feat brought about by the incantations of the magician Merlin, who caused a great stone circle in Ireland (said to have been previously carried thither out of Africa by giants) to be transported to Salisbury Plain, where, at Merlin's "word of power," all the stones moved into their proper places. On the other hand, the Welsh bard Aneurin states that Stonehenge existed before the time of Aurelius, whose title of Ambrosius may, as suggested by Davies, have been derived from Stonehenge. Geoffrey of Monmouth, in recording the death of Constantine, which took place about the middle of the 6th century (*Historia britonum*), states that he was buried "close by Uther Pendragon, within the structure of stones which was set up with wonderful art not far from Salisbury, and called in the English tongue, Stonehenge." Inigo Jones, in his work on Stonehenge, published in 1655, endeavours to prove that it was a "Roman temple, inscribed to Coelus, the senior of the heathen gods, and built after the Tuscan order." This theory was attacked by Dr Charleton (1725), one of the physicians of Charles II., who maintained that it was erected by the Danes, and consequently after the departure of the Romans from Britain. The next controversialist who appeared on the scene was the famous Dr Stukely (1740) who propounded the theory that Stonehenge, the stone circle at Avebury (Abury), &c., were temples for serpent worship, "Dracontia" as he called them, the serpent worshippers being the Druids. Subsequent writers dropped the ophite portion of this theory, but still continued to regard Stonehenge as a temple or observatory of the Druids. Lord Avebury regards it as a temple of the Bronze Age (1500-1000 B.C.), though apparently it was not all erected at one time, the inner circle of small unwrought, blue stones being probably older than the rest (*Prehistoric Times*). On the other hand James Fergusson (1872) contended that it was a sepulchral monument of the Saxon period.

The original number and position of the stones have suffered in the course of time from wind and weather, in days when archaeological interest was not alive to the importance of preserving so ancient a monument. That, however, these natural causes of its dilapidation were assisted by the sacrilegious hand of man there is no lack of documentary evidence. Thus Inigo Jones laments the disappearance of stones that were standing when he measured it; and both Stukely and Aubrey deplore the loss of fallen stones that were removed to make bridges, mill-dams and the like. On the evening of the 31st of December 1900, one of the outer trilithons (22 on plan), with its lintel, was blown down in the course of a severe storm, this being the first collapse since the 3rd of January 1797, when one of the fine trilithons (57, 58) of the horseshoe fell. This catastrophe attracted renewed attention to the state of Stonehenge, and much discussion took place as to the taking of precautions against further decay.

The annexed plan, which is that of Professor Flinders Petrie,

shows the state of Stonehenge at the moment preceding the fall of the trilithon on the 31st of December 1900. Within a circular earthwork, 300 ft. in diameter and approached from the north-east by a road or avenue which can still be traced by banks of earth, is an outer circle of trilithons (100 ft. in diameter) formed by great monoliths (sarsens), originally thirty in number, with large

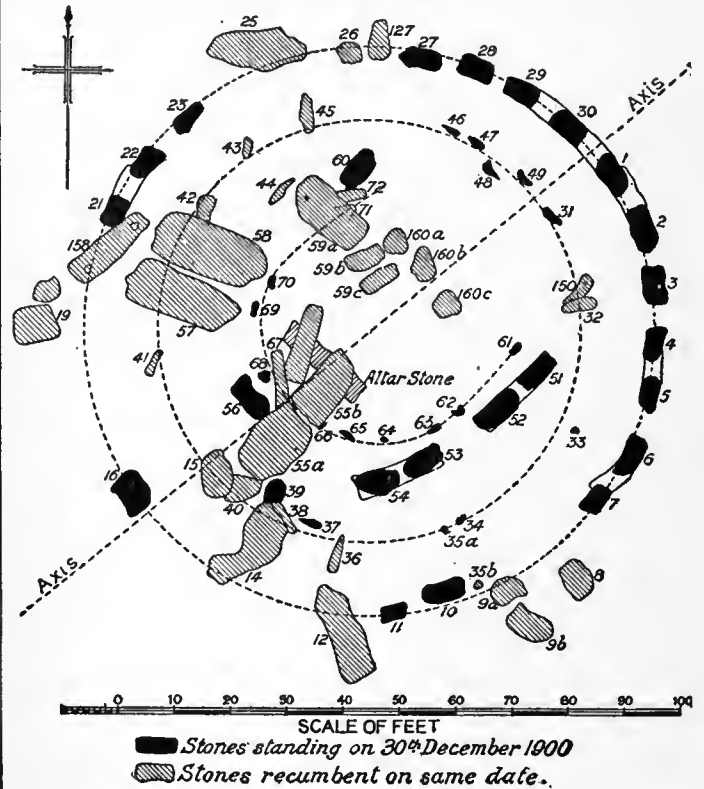

lintel stones. About 9 ft. within this circle and concentric with it is another, formed of smaller "blue stones," originally forty in number, but only a few of which now remain *in situ*; within that was a horseshoe of five huge trilithons formed by ten monoliths with their imposts (all sarsens); and within the horseshoe was an inner horseshoe of "blue stones," originally nineteen in number. The open part of the horseshoe exactly faces the sunrise at the summer solstice. Beyond the outer circle (not shown on plan) a great monolith—the sun stone, or so-called "Friar's Heel"—standing on the axis of the horseshoe, marks the point where a spectator, centrally placed within the horseshoe, would see the sun rise on the horizon at the solstice. On the circumference of the earthen circle or surrounding rampart (not shown on plan), which is here intentionally broken, a great recumbent stone—the slaughter stone—lies along the axis: and across the axis, near the central curve of the inner horseshoe, lies a fine recumbent stone—the altar stone—15 ft. long.

Only half the outer circle (sarsens) now remained upright, three on the west, thirteen on the east; and this indicated the effect of the prevalent west wind. The fall of trilithon 22 and its lintel opened a larger path to the wind, and added to the danger of further destruction. Moreover, the narrow passages between the eastern monoliths had become worn by use into hollows which threatened their foundations. The acquisition of Salisbury Plain by the war office for military purposes seemed likely, again, to add to the risk of harm from thoughtless visitors. For all reasons an attempt to preserve Stonehenge was desirable; and the owner, Sir Edmund Antrobus¹ was willing, on certain conditions, as to limitations of access, to co-operate with the Society of Antiquaries, Wiltshire Archaeological Society and Society for the Preservation of Ancient Monuments in taking such steps as might be necessary to prevent more stones from falling, and even (if possible) to set up some which had fallen.

¹ The ownership of Stonehenge having been questioned, Sir E. Antrobus's legal title to it was confirmed by a lawsuit in 1905.

The societies advised that trilithon 6, 7, with lintel—which had slewed round—and trilithon 56, which was leaning at a dangerous angle, should be examined with a view to replacement with as little excavation as possible; that the monolith and lintel 22 be replaced, and its companion sarsen (21) secured; and that trilithon 57, 58, should be re-erected in its place, which was exactly known. Steps were taken to place the matter in the hands of engineering experts. On the 19th of September 1901 trilithon 56 was successfully raised to a perpendicular position. It then presented an imposing appearance, standing 21 ft. above ground: its total length was found to be 29 ft. 6 in., and its weight about 30 tons. The excavations were carried to a depth of 8 ft. 3 in. below the datum line, and many objects were found, including chippings and lumps of the stones, stone tools, bones, and (in the upper strata) coins and fragments of pottery. Nearly 100 stone implements were excavated—axes, hammer axes, stone hammers and mauls—which, according to Dr Gowland, who superintended the work, had been used not only for breaking the rude blocks into regular forms, but also for working down their faces to a level or curved surface. No light was thrown, however, on the transport of the blocks.

Notwithstanding the many attempts, both by excavations and speculative writings, to elucidate the history of this unique monument, the archaeological data available are insufficient to decide definitely between the conflicting opinions held with regard to the date of its construction and the purpose for which it was originally intended. The finding of chips of "sarsens" and "blue stones" together "down to the bed of the rock" would seem to disprove the theory that the inner circle and inner horseshoe were built earlier than the rest of the monument. Dr Gowland at a meeting of the Society of Antiquaries (Dec. 19, 1901), read a paper on his recent excavations on the site of Stonehenge, in which he came to the conclusion that the structure was a temple dedicated to the worship of the sun, and he assigns its erection to the end of the Neolithic period (2000 to 1800 B.C.), on the ground that no bronze implements or relics were found during his explorations. It does not follow, however, from the fact that only stone tools were found at the bottom of the trenches that the monument was constructed when metal tools were unknown, because none of the Stonehenge tools have the characteristic forms of Neolithic implements, so that they might have been specially improvised for the purpose of roughly hewing these huge stones, for which, indeed, they were really better adapted, and more easily procured, than the early and very costly metal tools of the Bronze Age. On the other hand, the recorded discovery of iron armour, Roman and British pottery and coins, together with the bones and horns of deer and other animals, is of little evidential value without a precise record of the circumstances in which they were found. Only one object, viz. an incense burner, seems to the present writer to have any chronological value, as it is an undoubted sepulchral relic of the Bronze Age.

That the sun on midsummer day rises nearly, but not quite, in line with the "avenue" and over the Friar's Heel, has long been advanced as the chief argument in support of the theory that Stonehenge was a temple for sun-worship. On the supposition that this stone was raised to mark exactly the line of sunrise on midsummer's day when the structure was erected, it would naturally follow, owing to well-known astronomical causes, that in the course of time the direction of this line would slowly undergo a change, and that, at any subsequent date since, the amount of deviation would be commensurate with the lapse of time, thus supplying chronological data to astronomers for determining the age of the building. The solution of this problem has recently been attempted by Sir Norman Lockyer (*Stonehenge and other British Stone Monuments*), who calculates that on midsummer day, 1680 B.C., the sun would rise exactly over the Friar's Heel, and in a direct line with the axis of the temple and "avenue." The above date he therefore considers to be the date of the erection of this great national monument, within a margin of possible error, on either side, of 200 years.

Looking at Stonehenge from the architectural standpoint,

there can be no hesitancy in regarding it as an advanced representative of the ordinary stone circles, some two hundred of which, great and small, are known within the British Isles. It is, however, differentiated from them all by having hewn stones, capstones, tenons and sockets. That its analogues were chiefly used as sepulchres has been fully established, and this is presumptive evidence that the sepulchral element was, at least, one of the objects for which Stonehenge was constructed: and it was probably for this reason that it was erected on Salisbury Plain, where there already existed an extensive necropolis of the Bronze Age. Nor would this by any means militate against its use as a temple for consecrating the dead, or for sun-worship, or any other religious purpose.

AUTHORITIES.—Among numerous writings on Stonehenge may be mentioned *Stonehenge and Abury*, by Dr William Stukely (1740; reprinted in 1840); Davies, *Celtic Researches* (1804), and *Mythology of the Druids* (1809); Hoare, *Ancient Wiltshire* (1812), vol. i.; Browne, *An Illustration of Stonehenge and Abury* (1823); Fergusson, *Rude Stone Monuments* (1872); Long, *Stonehenge and its Barrows* (1876); Gidley, *Stonehenge viewed in the Light of Ancient History and Modern Observation* (1877); W. M. Flinders Petrie, *Stonehenge: Plans, Descriptions and Theories* (1880); E. T. Stevens, *Jottings on Stonehenge* (1882); Edgar Barclay, *Stonehenge and its Earth Works* (1895); Lockyer, *Stonehenge and other British Stone Monuments, Astronomically Considered* (1906). See also *The Times* (April 9, 1901). For a complete bibliography of Stonehenge see *The Wiltshire Archaeological and Natural History Magazine* (Dec. 1901), by W. Jerome Harrison. (R. Mu.)

STONEMAN, GEORGE (1822–1894), American soldier, was born at Busti, in Chautauqua county, New York, on the 8th of August 1822. He graduated at West Point in 1846, served as second lieutenant with the Mormon battalion in California during the Mexican War, and became a captain in 1855. In February 1861, while in command of Fort Brown, Texas, he disregarded the orders of his superior officer, Major-General D. E. Twiggs, to surrender to the Confederate forces, and escaped with the garrison. He served on McClellan's staff during the West Virginia campaign, and was commissioned brigadier-general of volunteers and appointed chief of cavalry of the Army of the Potomac in August 1861, in which capacity he took part in the Peninsula campaign and the Seven Days' Battle. He commanded the III. corps in the Fredericksburg campaign; and was promoted, in November 1862, to be major-general of volunteers. During the Chancellorsville campaign he made an unsuccessful cavalry raid toward Richmond. In the early months of 1864 he commanded the XXIII. corps, and then, as commander of the cavalry of the department of the Ohio, took part in the Atlanta campaign. While attempting to seize the Confederate prison at Andersonville (July 31, 1864), he was captured at Clinton, Georgia. After his release in October he commanded cavalry in East Tennessee, making successful raids into Virginia and North Carolina, and on the 12th of April 1865 defeated a Confederate force near Salisbury, North Carolina, and captured a large number of prisoners. Afterward he held commands in Tennessee and Virginia until 1868. He was mustered out of the volunteer service in September 1866, but served in the regular army as colonel and brevet-major-general till 1871. He then removed to California, was elected governor by the Democrats, and served from 1883 to 1887. In February 1891 he was made a colonel on the retired list, U.S. Army, and on the 5th of September 1894 died at Buffalo, New York.

STONE MONUMENTS, PRIMITIVE.—The raising of commemorative monuments of such enduring material as stone is a practice that may be traced in all countries to the remotest times. The highly sculptured statues, obelisks and other monumental erections of modern civilization are but the lineal representatives of the unhewn monoliths, dolmens, cromlechs, &c., of prehistoric times. Judging from the large number of the latter that have still survived the destructive agencies (notably those of man himself) to which they have been exposed during so many ages, it would seem that the motives which led to their erection had as great a hold on humanity in its earlier stages of development as at the present time. In giving some



Photo, F. Frith & Co.

STONEHENGE: FROM THE EAST.

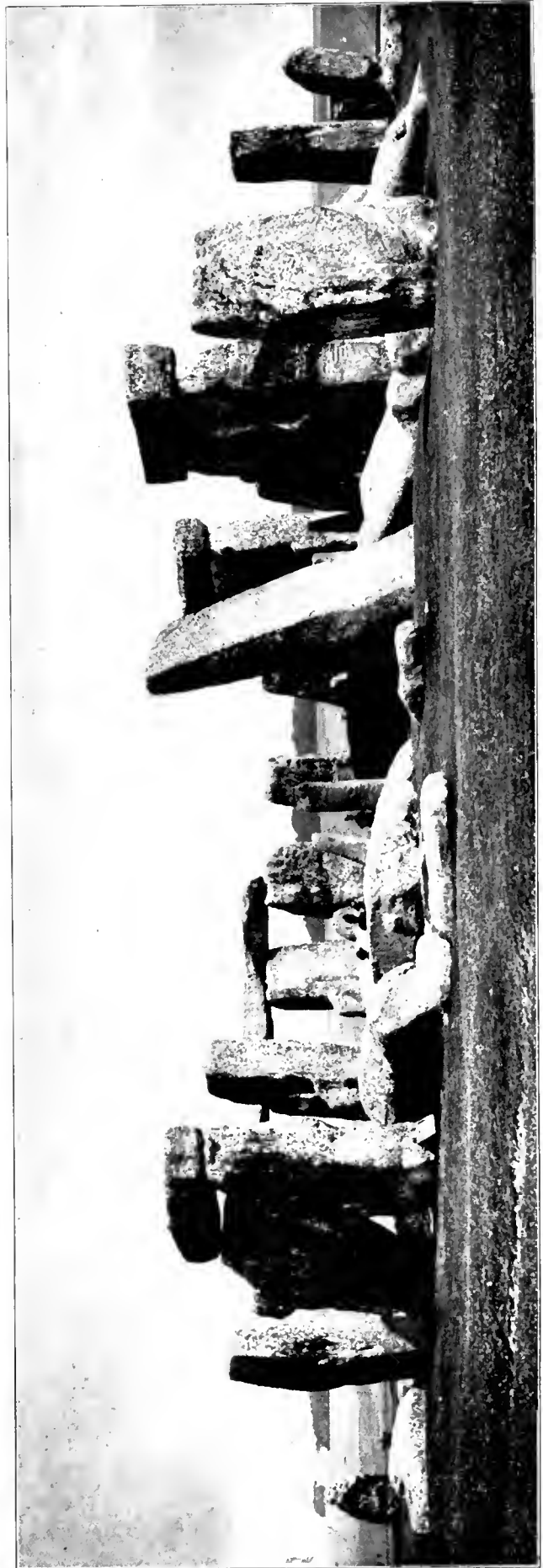

Photo, F. Frith & Co.

STONEHENGE: FROM THE WEST.



idea of the characteristics of these rude and primitive monuments in Britain and elsewhere it will be convenient to classify them as follows: (1) Isolated pillars, or monoliths (*μόνος*, solitary, and *λίθος*, stone) of unhewn stones raised on end, are called *menhirs* (Cornish, *maenhir*, and Welsh *maen*, a stone, and *hir*, long). (2) When these monoliths are arranged in lines they become *alignments* (*ad*, to, and Fr. *ligne*, a line), as at Ménez, Carnac (see Plate, fig. 5). (3) But if their linear arrangement be such as to form an enclosure (enceinte), whether circular, oval or irregular, the group is designated by the name of *cromlech* (Gaelic, *crom*, crooked, and *leac*, Welsh *llech*, a flagstone), as at Carrowmore, Ireland (see Plate, fig. 4). (4) When the monoliths, instead of standing apart as in the previous structures, are placed close to each other and enclose an area sufficiently small and narrow to be roofed over by one or more capstones so as to form a rude chamber, the monument is called a *dolmen* (Breton, *dolmen*, from *dol*, a table, and *men*, Welsh *maen*, a stone). For illustrations of the dolmens at Keriaval and Kit's Coty House (see Plate, figs. 1 and 2). This megalithic chamber is sometimes wholly embedded in a mound of earth or stones so as to present to outward appearance the form of a tumulus or cairn. As, however, there are many tumuli and cairns which do not contain megalithic chambers, it is only partially that these prehistoric remains come under the category of primitive stone monuments. In the rare instances of a dolmen being constructed of two single standing stones supporting a third, like the lintel of a door, as may be seen at Stonehenge (*q.v.*), the monument is called a *trilithon* (*τρι = τρεῖς*, three, and *λίθος*, stone).

Menhirs.—Rude monoliths set on end appear to have been erected in all ages for a variety of commemorative purposes, such as on the accession of kings and chiefs, or to mark the site of a battle, a grave, or a boundary line, &c. Throughout the British Isles such standing stones are widely interspersed, especially in the less cultivated districts. In Scotland, when stones were used ceremonially in the act of crowning a king, they were called *tanist* stones, the most celebrated of which was the *Lia Fail*, formerly at Scone (now at Westminster Abbey), on which the kings of Scotland used to be crowned. We read also of *hare* or *hoer* stones, *cambus* or *camus* stones (*cam*, crooked), *cat* (*cath*, battle) stones, *witch stanes*, *Druid stanes*, &c. The *Hawk stane*, or *Saxum Falconis*, at St Madoes, Perthshire, was erected in memory of the defeat of the Danes at Luncarty, and a monolith now standing on the field of Flodden is said to mark the place where King James fell. When menhirs were grouped together their number was often significant, *e.g.* twelve (Joshua iv. 5) or seven (Herod. iii. 8). Some standing stones are found to have been artificially perforated, and with these superstition has associated some curious ceremonies. As examples of this class may be mentioned the famous Stone of Odin near the circle of Stennis, the *Clach-Charra*, or Stone of Vengeance, at Onich near Balachulish, Argyllshire, and *Men-en-tol* (the holed-stone) in Cornwall. Two rude monoliths in Scotland bear inscriptions—the famous *Newton Stone* in the district of Garioch, and the *Cat Stane* near Edinburgh. Others have cup-and-ring markings, spirals or concentric circles. In Ireland, Wales and Scotland they are occasionally found with Ogam inscriptions and in the north-east of Scotland (Pictland) with some remarkable and hitherto unexplained symbolical figures, which were continued on the hewn and elaborately sculptured stones of early Christian times so largely found in that locality. In England monoliths are often associated with the *cromlechs* or stone circles, as the *King's Stone* at Stanton Drew, *Long Meg* at Little Salkeld, the *Ring Stone* at Avebury, &c. One of the finest British monoliths stands in the churchyard of Rudston, Yorkshire.

Menhirs are found in all countries which abound in megalithic structures. In France over 1600 isolated examples have been recorded, of which about the half, and by far the most remarkable, are within the five departments which constitute Brittany. Over the rest of France they are generally small, and not to be compared in size to those of Brittany. At

Locmariaquer, Morbihan, is the largest menhir in the world. It was in the form of a smooth-sided obelisk, but now lies on the ground broken into four fragments, the aggregate length of which amounts to 20.50 metres (about 67 ft.). It was made of granite foreign to the neighbourhood, and its weight, according to the most recent calculations, amounted to 347,531 kilogrammes, or 342 tons (*L'Homme*, 1885, p. 193). The next largest menhir is at Plésidy (Côtes-du-Nord), measuring about 37 ft. in height. Then follows a list of sixty-seven gradually diminishing to 16 ft. in height of which the first ten (all above 26 ft.) are in Brittany. As regards form these menhirs vary greatly. Some are cylindrical, as the well-known *Pierre de champ-Dolent* at Dol (height 30 ft.), and that of Cadiou in Finistère (28 ft.); while that of Penmarch (26 ft.) takes the shape of a partially expanded fan. A menhir of quartz at Médréac (Ille-et-Vilaine) stands 16½ ft. high in the form of a rectangular pillar *indubitablement taillé*. On the introduction of Christianity into France its adherents appear to have made use of these menhirs at an early period; many of them at present support a cross, and some a Madonna. While the scattered positions of some monoliths suggest that they were sometimes used as landmarks, or perhaps as places of rendezvous for hunters, the singular grouping of others shows that these were only secondary or subsidiary functions. So far as the Ogam inscriptions, found on some of the standing stones in Scotland, Ireland and Wales, have thrown light on the subject they appear to have been the headstones of graves. It is not uncommon to find a monolith overtopping a tumulus, thus simulating the *bauta* (grave or battle) stones of Scandinavia. Menhirs of all sizes are also met with in Algeria, Morocco, India, Central Asia, &c.

Alignments.—The most celebrated monuments of this class are to be seen in the vicinity of Carnac in Brittany. They are situated in groups at Ménez (see Plate, fig. 5), Kermario, Kerlescant, Erdeven and Ste Barbe—all within a few miles of each other, and in the centre of a district containing the most remarkable megalithic remains in the world. The first three groups are supposed by some archaeologists to be merely portions of one original and continuous series of alignments, which extended nearly 2 m. in length in a uniform direction from south-west to north-east. Commencing at the village of Ménez the menhirs extend in eleven rows. At first they stand from 10 to 13 ft. above ground, but as we advance they become gradually smaller till they attain only 3 or 4 ft. in height, and then cease altogether. After a vacant space of about 350 yards we come to the Kermario group, which contains only ten lines, but the menhirs are nearly of the same magnitude as those at the beginning of the former group. After a still greater interval the menhirs again appear at the village of Kerlescant, but this time in thirteen rows. In 1881 M. Felix Gaillard, Plouharnel, made a plan of the alignments at Erdeven, from which it appears that, out of a total of 1120 menhirs which originally constituted the group, 290 are still standing, 740 fallen, and 90 removed. The menhirs here may be traced for nearly a mile, but their linear arrangement is not so distinct, nor are the stones so large as those at Carnac. About 50 alignments are known in France. At Penmarch there is one containing over 200 stones arranged in four rows. Others, however, are formed of only a single row of stones, as at Kerdouadec, Leuré and Camaret. The first is 480 metres in length, and terminates at its southern extremity in a kind of *croix gammée*. At Leuré three short lines meet at right angles. The third is situated on the rising ground between the town of Camaret and the point of Toulinguet. It consists of a base line, some 600 yards long, with 41 stones (others had apparently been removed), and two rectangular lines as short offsets. Close to it were a dolmen and a prostrate menhir. All these monoliths consist of a coarse quartz and are of small dimensions, only one, at Leuré, reaching a height of 9 ft. Alignments are also found in the regions flanking the Pyrenees, but here they are generally in single file—mostly straight, but sometimes reptiliform. One at Peyrelade (Billière) runs in a straight line from north to south for nearly

300 yds. and contains 93 stones, some of which are of great size. At St Columb, in Cornwall, there is one called the Nine Maidens, which consists of eight quartz stones extending in a perfectly straight line for 262 ft. In Britain, however, the alignments are more frequently arranged in a double file, or in avenues leading to, or from, other megalithic monuments, such as still exist, or formerly existed, in connexion with the cromlechs or circles at Avebury, Stonehenge, Dartmoor, Shap, Callernish, &c. The stone circle at Callernish, in the island of Lewis, shows an unusually elaborate design with two parallel rows of upright stones running northwards and a single line across, thus presenting a cruciform appearance. A very tall menhir (17 ft. long) occupies the centre of the circle (42 ft. in diameter). The peat which in the course of ages had accumulated to a depth of 5 ft. was removed in 1858, and hence the characteristic features of this remarkable monument are well seen in the Plate, fig. 3. The only example in England comparable to the great alignments of Carnac is in the vale of the White Horse, in Berkshire. Here the stones, numbering about 800, are grouped in three divisions, and extend over an irregular parallelogram measuring from 500 to 600 yds. in length and from 250 to 300 yds. in breadth. Sir Henry Dryden describes several groups of alignments in Caithness, as at Garrywhin, Camster, Yarhouse, and the "Many Stones" at Clyth (Fergusson, *Rude Stone Monuments*, p. 529). Alignments in single and multiple rows have also been observed in Shetland, India, Algeria, &c.

Cromlechs.—In Britain the use of the word cromlech is virtually synonymous with that of dolmen. In France, however, and on the Continent generally, it is exclusively applied to that class of monument for which in this country only the descriptive name of "stone circles," or "circles of standing stones," is used. This application of the term in various countries to different classes of monuments has given rise to some confusion. The earliest known use of the word occurs in Bishop Morgan's translation of the Bible into Welsh (1588), where "the clefts of the rocks" is rendered by *cromlechydd y creigiau*. Its earliest occurrence in the special sense in which it has continued to be used by British antiquaries is in a description of some ancient remains by the Rev. John Griffith of Llanddyfnan (1650), in which he says—"There is a crooked little cell of stone not far from Alaw, where according to tradition Bronwen Leir was buried; such little houses, which are common in this country, are called by the apposite name *cromlechaw*." In this article the word cromlech retains its continental meaning and is exclusively used to indicate enclosures (enceintes) formed of rude monoliths placed at intervals of a few yards; and as such enclosures generally assume a circular, or oval, shape they are not infrequently described as stone circles. Rectangular enclosures are, however, not unknown, examples of which may be seen at Curcunno (Morbihan), near the well known dolmen of that name, and at Saint Just (Ille-et-Vilaine). The former measures 37 by 27 yds., and is now composed of 22 menhirs, all of which are standing (some fallen ones having been restored by the government), while about a dozen appear to be wanting. A "donkey-shoe-shaped" enclosure has been described by Sir Henry Dryden in the parish of Latheron, Caithness, measuring 226 ft. long, 110 ft. wide in the middle, and 85 ft. wide at the two extremities. Stone circles are frequently arranged concentrically, as may be seen in the circles at Kenmore, near Aberfeldy, Perthshire, as well as in many other Scottish, Irish and Scandinavian examples. More rarely one large circle surrounds inner groups without having a common centre, as at Avebury where the outer circle (1200 ft. in diameter) surrounded two others each of which contained an inner concentric circle. The stone circle of Ballynoe, Co. Down, Ireland, consists of inner and outer (eccentric) circles; the former measures about 57 ft. in diameter with 22 stones, and the latter 105 ft. in diameter with 45 stones. At Boscawen, in Cornwall, there is a group of circles confusedly attached and partially overlapping. Also, on the small island of Er-Lanic (near the famous tumulus of Gavrinis), there is a double

cromlech (now partially submerged), the circles of which intersect each other. Cromlechs may also be connected by alignments or avenues, as already explained; and they are often associated with other megalithic monuments. Thus, at the end of the great Carnac alignments are the remains of a large circle which can be readily traced, notwithstanding that some houses are constructed within its area. In the British Isles and in the north of Europe they frequently surround dolmens (as at Carrowmore, Ireland—Plate, fig. 4), tumuli and cairns. A few examples of a dolmen being surrounded by one or more circles have been recorded by M. Cartailhac from the department of Aveyron, in France. Outside the stone circle there is also frequently to be found a circular ditch as at Avebury, Stonehenge, Arbor Low, Ring of Brogar, &c. The most remarkable megalithic monument of this class now extant is Stonehenge, which differs, however, from its congeners in having the stones of its outer circle partially hewn and attached by transverse lintels. The largest cromlech in France was situated at the village of Kergonan, on the Ile-aux-Moines (Morbihan), about the half of it being now destroyed by the encroachment of the houses. The remaining semi-circumference contains 36 menhirs, from 6 to 10 ft. high, and its diameter is about 328 ft. This cromlech, like so many English "circles," was not circular but slightly elliptical. Only a few of the British cromlechs exceed these dimensions, among which may be mentioned Avebury (1260 by 1170 ft.), Stonehenge (outer circle 300 ft., inner 106 ft.), Stanton Drew (360 ft.), Brogar (345 ft.), Long Meg and her Daughters (330 ft.). One near Dumfries with 11 stones and 291 ft. in diameter, called the Twelve Apostles, also closely approaches what Fergusson calls the 100-metre size; but, generally speaking, the Scotch and Irish examples are of smaller proportions, rarely exceeding 100 ft. in diameter. That most of the smaller circles have been used as sepulchres has been repeatedly proved by actual excavations which showed that interments had taken place within their areas. It is difficult, however, to believe that this could have been the main object of the larger ones. At Mayborough, near Penrith, there is a circular mound entirely composed of an immense aggregation of small stones in the form of a gigantic ring and enclosing a flat area, about 300 ft. in diameter. This space is entered by a wide aperture in the ring, and near the centre there is a fine monolith, one of several known to have formerly stood there. Of the same type is the Giant's Ring, near Belfast; but the ring in this instance is made of earth and it is considerably larger in diameter (580 ft.), while the central object is a fine dolmen. It is more probable that such enclosures were used, like many of our modern churches, for the double purpose of burying the dead and addressing the living.

Dolmens.—In its simplest form a dolmen consists of three, four, or five stone supports, covered by one selected megalith called a capstone, or table. A well-known example of this kind in England is Kit's Coty House (see Plate), situated between Rochester and Maidstone, which is formed of three large supports with a capstone measuring 11 by 8 ft. From this simple form there is an endless variety of structures till we reach the so-called Giant Graves and *Grottes des Fées*, which consist of numerous supports and several capstones. The dolmen of Bagneux, situated in the corner of a plantation on the outskirts of the town of Saumur, measures 18 metres in length, 6.50 in breadth and 3 in height. It is constructed of huge flagstones, 4 on each side, and 4 capstones—the largest capstone measuring 7.50 metres in length, 7 in breadth and 1 in thickness. Another near Essé (Ille-et-Vilaine) called *La Roche aux Fées*, is constructed of 30 supports and 8 capstones, including the vestibule. Dolmens of this kind are extremely rare in the British Isles, the only one comparable to them in form being Calliagh Birra's House near Monasterboice, Ireland, which consists of 4 capstones supported by 4 or 5 thin stones on edge to form each side, and one stone closing one end. Owing to its small size (12 ft. long by 4 wide) this monument is disappointing in appearance. These free standing megalithic chambers, generally known as *allées couvertes*, as well as many other examples of the



Photo, Neurdein.
FIG. 1.—DOLMEN OF KERIAVAL, CARNAC, FRANCE.



Photo, F. Frith & Co.
FIG. 2.—KIT'S COTY HOUSE, AYLESFORD.



Photo, Valentine & Co.
FIG. 3.—DRUIDICAL STONES AT CALLANISH, STORNOWAY.



Photo, R. Welch.
FIG. 4.—LEABA-NA-BFIAN, THE "KISSING STONE" CROMLECH, CARROWMORE, SLIGO.



Photo, Neurdein.
FIG. 5.—THE ALIGNMENT OF MÉNEC, CARNAC, FRANCE.



simple dolmen, show no evidence of having been covered over with a mound. When there was a mound, it necessitated in the larger ones an entrance passage which, like the chamber, was constructed of a series of side stones and capstones. Some archaeologists maintain that all dolmens were formerly covered with a cairn or tumulus—a theory which undoubtedly derives some support from the condition of many examples still extant, especially in France, where they may be seen, as it were, in all stages of degradation from a partial to a complete state of denudation. Were the soil and stones which compose the tumulus of New Grange, Ireland, removed, leaving only the large stones which form its entrance passage and central chambers, there would be exposed to view a very imposing megalithic structure, not unlike the group of monoliths at Callernish in the Lewis (see Plate, fig. 3). The *allées couvertes* of France, Germany and the Channel Islands had their entrance at the end; but, on the other hand, those of the Drente, in Holland (Hunebedden), had both ends closed and the entrance was on the side facing the sun. The covered dolmens are extremely variable in shape—circular, oval, quadrangular and irregular being forms commonly met with; and as to size they range from that of an ordinary barrow up to that of New Grange, which rises in the form of a truncated cone to a height of 70 ft. with a diameter of 315 ft. at the base and 120 ft. at the top. Around its base was a circle of some thirty rude monoliths, placed about 10 yds. apart, and forming a circumference of 1000 ft.—only a few of these menhirs are now *in situ*. The entrance passage to the interior of this huge tumulus measures about 63 ft. long, 4 ft. 9 in. high, and 3 ft. 6 in. wide, and discloses some large blocks of stone; and its cruciform chamber measures 26 ft. long, 21 ft. broad and 19½ ft. high in the middle. The entrance gallery may be attached to the end of the chamber, as in the Grotte de Gavrinis, or to the side, as in the Giant's Grave at Oem near Roskilde. In other instances there is no distinct chamber, but a long passage gradually widening from the entrance; and this may be bent at an angle, as in the dolmen du Rocher (Morbihan). Again, there may be several chambers communicating with one entrance passage; or, two or three chambers, having separate entrances, may be imbedded in the same tumulus. A curious specimen of the former may be seen in a ruined tumulus near St Helier, Jersey; and an excellent example of the latter is the partially destroyed tumulus of Rondosec, near Plouharnel railway station, which contains three separate dolmens. That such variations are not due to altered customs, in consequence of wideness of geographical range, is shown by de Mortillet, who gives plans of no less than 16 differently shaped dolmens (*Musée préhistorique*, pl. 58), all within a confined district in Morbihan.

Ruined dolmens are abundantly met with in the provinces of Hanover, Oldenburg and Mecklenburg. At Riestedt, near Uelzen in Hanover, there is, on the summit of a tumulus, a very singular dolmen which measures about 40 ft. long and 6 ft. wide. Another at Naschendorf, near Weimar, consists of a mound surrounded by a large circle of stones and a covered chamber on its summit. Remains of a megalithic structure at Rudenbeck, in Mecklenburg, though now very imperfect, show that originally it had been constructed like an *allée couverte*. It had four supports on each side, two at one end (the other end being open and forming the entrance), and two large capstones. The length in its completed state was about 20 ft., breadth 7½ ft., and height from the floor to the under surface of the roof 3 ft. According to Bonstetten, no less than 200 of these megalithic monuments are distributed over the three provinces Lüneburg, Osnabrück and Stade; and the most gigantic examples in Germany are in the duchy of Oldenburg. In Holland, with one or two exceptions, they are confined to the province of Drente, where between 50 and 60 still exist, under the name of Hunebedden (Huns' beds). The Borger Hunebed, the largest of the group, is 70 ft. long and 14 ft. wide. In its original condition it contained 45 stones, ten of which were capstones. All the Drente monuments are now denuded, but a few show evidences which suggest that they had formerly been surrounded

by a mound containing an entrance passage. Only one dolmen has been recorded in Belgium; but in France their number amounts to 3000–4000. They are irregularly distributed over 78 departments, no less than 618 being in Brittany. In the centre of the country they are also numerous, some 435 having been recorded in Aveyron; but here they are of much smaller dimensions than in Brittany. From the Pyrenees these rude stone monuments are sparsely traced along the north coast of Spain and through Portugal to Andalusia, where they occur in considerable numbers, but of their precise numbers and distribution we have no trustworthy accounts. According to Cartailhac (*Âges préhistoriques de l'Espagne et du Portugal*, p. 152) 118 were recorded up to 1879 under the name of *antas*. Many of them are in the form of free standing dolmens and *allées couvertes*. The most remarkable monument of this kind in Spain, and certainly one of the finest in Europe, is that near the village of Antequera, some distance north of Malaga. The chamber, slightly oval in shape, measures 24 metres long, 6.15 metres broad, and from 2.70 metres to 3 metres high. The entire structure comprises 31 monoliths—ten on each side, one at the end and five on the roof. Moreover, the roof is strengthened by three pillars placed along the middle line at the widest part of the chamber. The huge stones are made of the Jurassic limestone of the district and, like those of Stonehenge, appear to have been partly dressed. The entire structure was originally, and still is partially covered by earth, which formed a mound about 100 ft. in diameter. In Africa dolmens are found in large groups in Morocco, Algeria and Tunis. General Faidherbe writes of having examined five or six thousand at the cemeteries of Bou Merzoug, l'Oued Berda, Tébessa, Gastal, &c. (*Congrès international d'anth. et d'arch. préhist.*, 1872, p. 408). In the Channel Islands every kind of megalithic monument is met with. At Mont Cochon, near St Helier, there was lately discovered in a mound of blown sand an *allée couverte* and, close to it, a stone circle surrounding a small dolmen. In the British Isles dolmens are common in many localities, particularly in the west of England, Anglesey, the Isle of Man, Ireland and Scotland. In the last named country they are not, however, the most numerous and striking remains among its rude stone monuments—the stone circles and cisted cairns having largely superseded them.

No dolmens exist in eastern Europe beyond Saxony. They reappear, however, in the Crimea and Circassia, whence they have been traced through Central Asia to India where they are widely distributed. Similar structures have also been recognized by travellers in Palestine, Arabia, Persia, Australia, Madagascar, Peru, &c. The irregular manner in which these megalithic monuments are distributed along the western parts of Europe bordering on the seashore has led to the theory that they were erected by a special people, but as to the when, whence and whither of this megalithic race we have no knowledge whatever. Although the European dolmens, however widely apart they may be situated, have a strong family likeness, yet they present some striking differences in certain localities. In Scandinavia they are confined to Danish lands and a few provinces in the south of Sweden. In the former country the exposed dolmens are often placed on artificial mounds and surrounded by cromlechs which are either circular (*runddysser*), or oval (*langdysser*). In Sweden the *sépulture à galerie* is very rarely entirely covered up as in the Giant graves of Denmark.

In the absence of historical records and scientific investigations it was formerly the custom to regard all these different varieties of primitive stone monuments as of Celtic origin. By some they were supposed to have been constructed by the Druids, the so-called priests of the Celts; and hence they have been described, especially since the time of Aubrey and Stukely, under the name of Celtic or Druidical monuments. But from more recent researches there can be no doubt that the primary object of this class of remains was sepulchral, and that the megalithic chambers with entrance passages were used as family vaults. Against the theory that any of them were ever used as altars, there is *prima facie* evidence in the care taken to have

the smoothest and flattest surface of the stones composing the chambers always turned inwards. Moreover, cup marks and other primitive markings, when found on capstones, are almost invariably on their underside, as at the dolmens of Keriaval, Kercado and Dol ar Marchant. Also, all the six stones forming the three-sided chamber of the great tumulus of Gavrinis (Morbihan) and most of those in the sides of its long entrance passage (44 ft.), are elaborately sculptured with primitive incised patterns, perfectly analogous to those on the walls of the chamber of New Grange (Ireland). From its position in the centre of a large circular enclosure, as uniformly even as a garden lawn, no dolmen could be more suggestive as a place of sacrifice than that within the Giant's Ring near Belfast; yet nothing could be more inappropriate for such a purpose than its capstone, which, in fact, is nothing more than a large granite boulder presenting on its upper side an unusually rounded surface.

No chronological sequence has been detected in the construction and evolution of these primitive stone monuments; nor can their existence and special forms in different countries be said to indicate contemporaneity. The dolmens of Africa are often found to contain objects peculiar to the Iron Age, and it is said that in some parts of India the people are still in the habit of erecting menhirs, cromlechs, dolmens and other megalithic monuments. Scandinavian archaeologists assign their dolmens exclusively to the Stone Age. It would appear that, subsequent to the great chambered cairns of the Stone Age, a period of degradation in this kind of architecture occurred in Britain when the Bronze Age barrows replaced the dolmens, and these again gave way to simple burial in the earth. In Scandinavia the megalithic chamber seems to have been discarded in the Iron Age for burials, either by cremation or inhumation under huge tumuli, as may be seen in the three great mounds of Thor, Odin and Freya at Gamla Upsala, and the ship-barrow at Gokstad on the Sandefjord, the scene of the discovery of the Viking ship now exhibited in the museum at Christiania.

Just on the borderland between the works of nature and art comes the so-called Rocking-Stone (*Logan*, or *Loggan*, stone, French, *pierre branlante*), which usually is nothing more than an erratic, ice-transported boulder, poised so nicely over a rocky bed that gentle pressure with the hand may cause it to rock or oscillate. Such stones appear to be sparsely distributed over the whole area occupied by the primitive stone monuments, and, being very large, they were pre-eminently calculated to awaken astonishment in the minds of the worshippers of the mysterious works of nature. Hence the important position assigned to them in the Druidical worship invented by Stukely and other antiquaries of the 18th century. Some rocking-stones are evidently artificial, having had the rock cut underneath them, leaving in each a pivot-like prominence on which the block rests; but, on the other hand, natural causes can produce similar results, the stone itself acting like an umbrella to protect the central portion of the bed while weathering outside is going on all around. The same process is often well illustrated on moraine-bearing glaciers where a huge stone may be seen resting on a pillar of ice several feet in height. That man sometimes imitated such striking natural phenomena is quite probable, and to this extent rocking-stones come within the category of primitive stone monuments.

BIBLIOGRAPHY.—Fergusson, *Rude Stone Monuments*; W. C. Borlase, *The Dolmens of Ireland*, &c.; de Mortillet, *Le Préhistorique*, &c.; Bonstetten, *Essai sur les dolmens*; P. Bezier, *Inventaire des monuments mégalithiques du département d'Ile-et-Vilaine*; *Congrès international d'anth. et d'arch. préhistoriques* (13 vols., 1860-1906); *Matériaux pour l'histoire primitive et naturelle de l'homme* (22 vols., 1865-1888), continued as *L'Anthropologie* since 1890; *Inventaire des monuments mégalithiques de France*; *Proceedings of the various Archaeological Societies of Europe.* (R. Mu.)

STONE RIVER, BATTLE OF, a battle of the American Civil War, called the battle of Murfreesboro by the Confederates, fought on the 31st of December 1862 and the 2nd of January 1863. After his appointment in October to command the Army

of the Cumberland, General W. S. Rosecrans with Chattanooga as his objective moved from Nashville upon General Braxton Bragg, who left the winter quarters he had established at Murfreesboro and met the Union army on Stone river immediately north of Murfreesboro, on the last day of December. The plan of attack on each side was to crush the enemy's right. Bragg's left, commanded by Lieut.-General W. J. Hardee, overlapped and bore back the Union right under Major-General A. McD. McCook, and Major-General T. L. Crittenden commanding the Union left was hurriedly called back from his attack on the Confederate right to support McCook. The Union right was crumpled up on the centre, where Major-General G. H. Thomas's corps checked the Confederate attack. There was practically no fighting on the 1st of January, but on the 2nd the Confederates renewed the attack, Major-General J. C. Breckinridge with Bragg's right attempting in vain to displace Crittenden's division on high ground above the river. On the night of the 3rd Bragg withdrew and the Union army occupied Murfreesboro. Tactically a drawn battle, Stone River was strategically a Union victory. The losses on both sides were heavy: of 37,712 Confederates present for duty, 1294 were killed, 7945 were wounded, and about 2500 were missing; and of 44,800 Union soldiers present for duty, 1677 were killed, 7543 were wounded and 3686 were missing.

STONINGTON, a township of New London county, Connecticut, U.S.A., in the S.E. corner of the state, on Long Island Sound. Pop. of the township (1900), 8540 (of whom 1968 were foreign-born), (1910), 9154, including that of the borough of Stonington, 2083. Stonington is served by the New York, New Haven & Hartford railway, which has repair shops here, by an electric line connecting with New London, Conn., and Westerly, Rhode Island, and, in summer, by steamer to Watch Hill and Block Island. Its harbour is excellent, and it is a port of entry, but its foreign trade is unimportant. The township covers an area of about 45 sq. m., and includes, besides the borough of Stonington, the villages of Mystic, Old Mystic and Pawcatuck (which is closely allied with Westerly, Rhode Island). Among the manufactures of the township are foundry and machine-shop products, printing presses, silk machinery, fertilizers, spools, thread and cotton, and woollen, silk and velvet goods. Ship building and fishing are among the industries. After its settlement in 1649 and the years immediately succeeding by English planters from Rehoboth in Plymouth Colony (to whom a monument was erected in 1889 in Wequetequock Burying Ground), the territory now included in Stonington township was first a part of New London township, and then (1658), in accordance with a boundary decision of the United Colonies of New England, a part (under the name of Southertown) of Suffolk county, Massachusetts, finally reverting to Connecticut in accordance with the new boundaries fixed by the Connecticut royal charter in 1662. In 1664 it gained representation in the General Court of Connecticut; in 1665 the name was changed to Mystic, and in 1666 to Stonington. In the 18th century the village (now the borough) of Stonington (settled in 1752) developed a brisk trade with Boston, Plymouth and the West Indies. Whaling and sealing were for many years important industries and a whaling captain of Stonington, Nathaniel B. Palmer, early in the 19th century, discovered Palmer Land in the Antarctic. The village was the seat of military stores during the War of Independence, and was bombarded by a British frigate in August 1775. In August 1814 another British attack, by a squadron under Commander Thomas M. Hardy, was successfully resisted. The borough of Stonington, the first in the state, was incorporated in 1801.

See R. A. Wheeler, *History of the Town of Stonington* (New London, 1900).

STONY POINT, a township in Rockland county, New York, U.S.A., on the west bank of the Hudson river, containing a village of the same name which is 35 m. N. of New York City and 12 m. S. of West Point. Pop. of the township (1890) 4614; (1900), 4161; (1905), 3862; (1910), 3651. Area, about 30 sq. m. The village is served by the West Shore and the New York,

Ontario, and Western railways. Other villages in the township are Grassy Point, where, as in Stony Point, brick-making is the principal industry; Tomkins Cove, where there are stone crushing works; and Jones Point, which has a trade in gravel, building sand and crushed stone. The surface of the township is rough—Dunderberg (1090 ft.) and Bear Mountain (1350 ft.) are the principal eminences, and there is good farming land only at the margin of the river. The township was named from a rocky promontory which juts into the river in the north-east part of the township and rises precipitously on all sides to a height of about 140 ft. above the river. A small part of the promontory is under the jurisdiction of the United States Government which has erected a lighthouse here, and the remaining portion was bought by the state in 1897 for a state battlefield reservation, and has been laid out as a public park. At the entrance to the park is a Memorial Arch (1909), designed by H. K. Bush-Brown and presented to the state by the Daughters of the American Revolution. On Iona Island in the north part of the township is a United States naval magazine. The promontory guards the lower passage to the Highlands of the Hudson, and during the War of Independence, when the King's Ferry between it and Verplanck's Point on the opposite bank was part of an important line of communication between the New England and the Middle States, it was of considerable strategic importance. The Americans occupied it in November 1776, and about two years later erected a blockhouse upon it. The garrison, however, was very small, and on the 31st of May 1779, it was taken by the British, who immediately erected much stronger fortifications. On the night of the 15th/16th of July it was recovered by General Anthony Wayne, in command of about 1350 picked American troops, the garrison (under Lieut.-Colonel Henry Johnson) losing 63 in killed, 70 in wounded, and 543 in captured. The American loss was only 15 killed and 83 wounded. The Americans, however, had no thought from the first of holding the place and evacuated it on the 18th of July. The British immediately reoccupied it, and erected stronger fortifications, but late in October they, too, abandoned it. In the "old Treason House" in the township General Benedict Arnold and Major John André met before daylight on the 22nd of September 1780, to settle upon plans for the surrender of West Point by Arnold to the British.

See H. P. Johnston, *The Storming of Stony Point* (New York, 1900); H. B. Dawson, *The Assault on Stony Point* (Morrisania, N. Y., 1863); E. H. Hall and F. W. Halsey, *Stony Point Battle-Field* (New York, 1902); and D. Cole and E. Gay, *History of Rockland County* (ibid. 1884).

STOOL, a low seat without back or arms. The stool is an ancient piece of furniture which came into use when the need began to be felt for a seat more easily portable than heavy settles and benches—the chair was an appanage of rank and dignity to which no ordinary person dreamed of aspiring. Since it could also be used as a small table, it quickly became common. In the First Book of *The Task* William Cowper gives a sketch of the evolution of the stool which, for all its vapidness, is reasonably exact:—

"Joint stools were then created, on three legs
Upborn they stood. Three legs upholding firm
A massy slab, in fashion square or round.

* * * * *

At length a generation more refined
Improved the simple plan; made three legs four,
Gave them a twisted form vermicular,
And o'er the seat, with pteous wadding stuff'd,
Induc'd a splendid cover, green and blue,
Yellow and red, of tap'stry richly wrought,
And woven close, or needle-work sublime."

"Joint" or "joyned-stool" simply meant that the parts were joined or framed together with mortise and tenon. The wooden four-legged, square or oblong variety is often called a "coffin-stool." It may be perfectly true that it was used for supporting coffins, but that was merely one—and a very occasional one—of many uses, and the name is an entire misnomer. The round three-legged stool was a primitive

construction, destitute of ornament and rudely, as well as heavily, made. By the middle of the 16th century stools had acquired four legs, braced together by stretchers, and the frame was often well carved. As the Renaissance impulse waned, forms relapsed into cumbrous and unadorned, and, so far as the oak stool of the yeoman and the farmer was concerned, little ornamentation was attempted after the middle of the 17th century. These seats continued to be made until about the end of that period—until, indeed, the increasing cheapness of the chair and the growth of habits of comfort caused it to fall into disuse. Towards the end of the Stuart period the upholstered stool reached England from France. It was not entirely unknown at an earlier date, but what had been an occasional luxury then became a common plenishing of the houses of the rich. The legs and stretchers took the "twisted form vermicular" of which the poet speaks—so far as their underframing was concerned these stools were, to all intents and purposes, chairs. Thenceforward, indeed, they followed very closely the fashions in seats with backs, acquiring the cabriole leg, the claw and ball or pad feet, the carved knees and other characteristics of chairs. The footstool is probably more ancient than the stool itself. The ducking-stool was a contrivance whereby scolding or drunken women could be ducked in a pond without danger. The stool of repentance was reserved, chiefly in Scotland, for the public penance of persons who had offended against morality. The "cutty-stool," which Jenny Geddes threw—or, according to Dr Hill Burton, did not throw—at the beginning of the riotous protests against Laud's Liturgy in St Giles's Church, Edinburgh, in 1637, was of the fald-stool variety. "Cutty" simply means short. A fald-stool was originally a folding stool used chiefly for ecclesiastical purposes. Eventually, while retaining the old name, it became rigid, and the designation has now been extended to a litany-desk. The camp-stool is immediately derived from the original form of the fald-stool. In France under the *ancien régime*, the stool, or *tabouret*, acquired a social and courtly significance of the first importance. The wives of princes, dukes, and a few of the highest dignitaries of the realm alone had the right to occupy a *tabouret* in the presence of the king, and ladies who became widows used every expedient of intrigue to retain a privilege which they regarded as the summit of earthly felicity. The *prise du tabouret*, when a lady first took possession of her seat, was an occasion of considerable ceremony.

STOOL-BALL, a game formerly very popular in England, and commonly considered as the ancestor of cricket. Joseph Strutt, writing in 1801, says of it: "I have been informed that a pastime called stool-ball is practised to this day in the northern parts of England, which consists simply in setting a stool upon the ground, and one of the players takes his place before it, while his antagonist, standing at a distance, tosses a ball with the intention of striking the stool, and this it is the business of the former to prevent by beating it away with the hand, reckoning one to the game for every stroke of the ball; if, on the contrary, it should be missed by the hand and touch the stool, the players change places; the conqueror at this game is he who strikes the ball most times before it touches the stool. I believe the same also happens if the person who threw the ball can catch and retain it when driven back, before it touches the ground." Some variety of the game, with modifications due to the development of cricket, has probably been played even since these days.

STOPPANI, ANTONIO (1824-1891), Italian geologist and palaeontologist, was born at Lecco on the 24th of August 1824. He became professor of geology in the Royal Technical Institute of Milan, and was distinguished for his researches on the Triassic and Liassic formations of northern Italy. Among his works were *Paléontologie Lombarde* (1858-1881); *Les pétrifications d'Ésino* (1858-1860); *Géologie et paléontologie des conches à Avicula Contorta en Lombardie* (1860-1865); *Corso di geologia*, (3 vols., 1871-1873); and *L'Era Neozoica* (1881). In this last work the author discussed the glaciation of the Italian Alps and the history of Italy during the Pleistocene age. He died at Milan on the 1st of January, 1891.

STORACE, STEPHEN (1763–1796), English musical composer, was born in London in 1763. His father, Stefano Storace, an Italian contrabassist, taught him the violin so well that at ten years old he played successfully the most difficult music of the day. After completing his education at the Conservatorio di Sant' Onofrio, at Naples, he produced his first opera, *Gli Sposi malcontenti*, at Vienna, in 1785. Here he made the acquaintance of Mozart, in whose *Nozze di Figaro* his sister, Anna Selina Storace, first sang the part of Susanna. Here also he produced a second opera, *Gli Equivoci*, founded on Shakespeare's *Comedy of Errors*, and a "Singspiel" entitled *Der Doctor und der Apotheker*. But his greatest triumphs were achieved in England, whither he returned in 1787. After creating a favourable impression by bringing out his "Singspiel" at Drury Lane, under the title of *The Doctor and the Apothecary*, Storace attained his first great success in 1789, in *The Haunted Tower*, an opera which ran for fifty nights in succession. *No Song, No Supper* was equally successful in 1790; and *The Siege of Belgrade* scarcely less so in 1791. The music of *The Pirates*, produced in 1792, was partly adapted from *Gli Equivoci*, and is remarkable as affording one of the earliest instances of the introduction of a grand *finale* into an English opera. These works were followed by some less successful productions; but *The Cherokee* (1794) and *The Three and the Deuce* (1795) were very favourably received, and the music to Colman's play, *The Iron Chest*, first performed on the 12th of March 1796, created even a greater sensation than *The Haunted Tower*. This was Storace's last work. He caught cold at the rehearsal, and died on the 19th of March 1796.

The character of Storace's music is pre-eminently English; but his early intercourse with Mozart gave him an immense advantage over his contemporaries in his management of the orchestra, while for the excellence of his writing for the voice he was no doubt indebted to the vocalization of his sister Anna. This lady was born in London in 1766, completed her education at Venice under Sacchini, sang for Mozart at Vienna, and first appeared at the King's Theatre in London in 1787. After contributing greatly to the success of *The Haunted Tower* and her brother's later operas, she crowned a long and brilliant career by winning great laurels at the Handel Commemoration at Westminster Abbey in 1791, retired from public life in 1808, and died on the 24th of August 1817. During her stay in Vienna she married John Abraham Fisher, a celebrated violinist; but he used her so cruelly that she refused to bear his name, and in her will—bequeathing property to the amount of £50,000—styled herself "spinster."

STORE (from O. Fr. *estor* or *estoire*, Late Lat. *staurum* or *instaurum*, stock, provisions, supply, from the late use of *instaurare*, to provide, properly to construct, renew, restore), a stock or supply of provisions, goods or other necessities kept for future daily or recurrent use or for a specific purpose; thus the term applies equally to the domestic supply of provisions, &c., and to the accumulated stock of arms, ammunition, clothing, food, &c., kept for the general use of a navy or army. A common secondary meaning is that of the place where a supply or stock is kept, a storhouse, and thus the term is used particularly in the country districts of America for the general shop where goods of all kinds are sold by retail. In English the term "store" has come into use for large general shops with many departments selling all kinds of goods.

STOREY (equivalents are Fr. *étage*, Ital. *piano*, Ger. *Stock*), the term in architecture given to the floor of a building, and employed generally when referring to a number of floors one above the other; thus a building may be of two, three or more storeys high. It used to be applied to a series of apartments on one floor, which are now generally known as a flat. "Storey" or "story" is from O. Fr. *estorée*, building, *estorer*, to build, equip, furnish, store, from Lat. *staurare*, only seen in compound *instaurare*, to repair, restore, ultimately from root *sta*, to stand. "Story," a tale or narrative, is a shortened form of "history."

STORK (A. S. *storc*, Ger. *Storch*), the *Ciconia alba* of ornithology, a well-known bird, which, however, though often visiting

Britain, has never been a native or even inhabitant of that country. It is a summer visitor to most parts of the European continent—the chief exceptions being France (where the native race has been destroyed), Italy and Russia—breeding from southern Sweden to Spain and Greece, and being especially common in Poland.¹ It reappears again in Asia Minor, the Caucasus, Persia and Turkestan, but farther to the eastward it is replaced by an allied species, *C. boyciana*, which reaches Japan. Though occasionally using trees (as was most likely its original habit) for the purpose, the stork most generally places its nest on buildings,² a fact familiar to travellers in Denmark, Holland and Germany, and it is nearly everywhere a cherished guest, popular belief ascribing good luck to the house to which it attaches itself.³ Its food, consisting mainly of frogs and insects, is gathered in the neighbouring pastures, across which it may be seen stalking with an air of quiet dignity; but in the season of love it indulges in gestures which can only be called grotesque—leaping from the ground with extended wings in a kind of dance, and, absolutely voiceless as it is, making a loud noise by the clattering of its mandibles. At other times it may be seen gravely resting on one leg on an elevated place, thence to sweep aloft and circle with a slow and majestic flight. Apart from its considerable size—and a stork stands more than three feet in height—its contrasted plumage of pure white and deep black, with its bright red bill and legs, makes it a conspicuous and beautiful object, especially when seen against the fresh green grass of a luxuriant meadow. In winter the storks of Europe retire to Africa—some of them, it would seem, reaching Cape Colony—while those of Asia visit India. A second species, with much the same range, but with none of its relative's domestic disposition, is the black stork, *C. nigra*, of which the upper parts are black, brilliantly glossed with purple, copper and green, while it is white beneath—the bill and legs, with a patch of bare skin round the eyes, being red. The bird breeds in lofty trees, generally those growing in a large forest. Two other dark-coloured, but somewhat abnormal, species are the purely African *C. abdimii* and the *C. episcopus*, which has a wider range, being found not only in Africa but in India, Java and Sumatra. The New World has only one true stork, *Dissura maguari*, which inhabits South America, and resembles not a little the *C. boyciana* above mentioned, differing therefrom in its greenish-white bill and black tail. Both these species are very like *C. alba*, but are larger and have a bare patch of red skin round the eyes.

The storks form the family Ciconiidae, and together with the ibises (Ibididae) are now ranked as a sub-order of Ciconiiform birds (see BIRD). There is no doubt that they include the jabiru (*q.v.*) and its allies, as well as the curious genus *Anastomus* (known in India as the "open-bill," because its lower mandible is hollowed out so as only to meet the maxilla at the base and the tip), of which there are an African and an Asiatic species. In all the storks the eggs are white and pitted with granular depressions. (A. N.)

STORM, THEODOR WOLDSEN (1817–1888), German poet and novelist, was born at Husum, in Schleswig, on the 14th of September 1817. Having studied jurisprudence at Kiel and Berlin, where he formed a close friendship with the brothers Theodor and Tycho Mommsen, he settled in his native town as advocate; but, owing to his German sympathies, lost his post in 1853. Entering the Prussian service as assessor at Potsdam, he was appointed district judge at Heiligenstadt. After the

¹ In that country its numbers are said to have greatly diminished since about 1858, when a disastrous spring storm overtook the homeward-bound birds. The like is to be said of Holland since about 1860.

² To consult its convenience a stage of some kind, often a cart-wheel, is in many places set up and generally occupied by successive generations of tenants.

³ Its common Dutch name is *Ooijevaar*, which can be traced through many forms (Koolmann, *Wörterb. d. ostfries. Sprache*, i. 8, *sub voce* "Adebar") to the old word *Odeboru* ("the bringer of good"). In countries where the stork is abundant it enters largely into popular tales, songs and proverbs, and from the days of Aesop has been a favourite in fable.

Danish War of 1864 Storm returned to Husum, and after filling various judicial appointments in the district, retired on a pension and died at Hademarschen on the 4th of July 1888. Storm is hardly less remarkable as a lyric poet than as a novelist. As the former, he made his *début*, with the two Mommsens, with *Liederbuch dreier Freunde* (1843); but his *Gedichte* (1852; 12th edition, 1900) first obtained for him general recognition. As a novelist he gained his first great success with *Immensee* (1852; 51st edition, 1901); and this was followed by numerous other short stories. He was never weary of painting the scenes of rustic simplicity and the quiet joys of the simple life. He is at his best when dealing retrospectively with episodes and incidents from his own earlier life. Later he passed to psychological problems with *Aquis submersus* (1877) and *Zur Chronik von Grieshuus* (1884), and made a deep impression with his fantastic *Schimmelreiter* (1888).

Storm's *Gesammelte Schriften* appeared in 19 vols. between 1868 and 1889; new edition in 8 vols. (1898). His correspondence with E. Mörike was published in 1891, with G. Keller in 1904. See E. Schmidt, *Charakteristiken*, i. (1886); also P. Schütze, *Theodor Storm, sein Leben und seine Dichtung* (1887); F. Wehl, *Theodor Storm, ein Bild seines Lebens und Schaffens* (1888); A. Biese, *Th. Storm und der moderne Realismus* (1888); and P. Remer, *Theodor Storm als norddeutscher Dichter* (1897).

STORM (in O. Eng. *storm*, and so in Du. and Low Ger.; in O. H. Ger. and mod. Ger. *Sturm*; the root is probably that seen in "stir," to rouse, move, disturb, cf. Ger. *stören*), a disturbance of the atmosphere, accompanied by high winds or by heavy falls of rain, hail or snow, together with thunder and lightning. The word is not a part of scientific terminology, such terms as "area of low pressure" and "cyclone" being used. In the Beaufort scale (*q.v.*) the wind-force of a storm is estimated at 10-11 and the limit of velocity at from 56 to 75 m. per hour. (See METEOROLOGY, and for magnetic storms MAGNETISM, TERRESTRIAL.)

STORNOWAY (Norse, *Stjarna vagr*, "Stjarna's Bay"), the chief and largest town in the western islands and also the principal town of the county of Ross and Cromarty. Pop. (1901), 3852. It is situated on the east coast of Lewis, at the head of a capacious harbour with ample quays and wharves, accessible at all tides and available for steamers of 3000 tons burden. The harbour is protected by two headlands, on the more southerly of which—Arnish Point—stands a lighthouse. From the end of this point there juts out a line of rocks on the extremity of which a beacon, 32 ft. high, has been erected, which is illuminated by means of a light thrown on to a prism in the lantern from the light in the lighthouse. Stornoway was made a burgh of barony by James VI., and is also a police burgh. It is the centre of the Outer Hebrides fishery district, and during the herring season the population is trebled. Among the public buildings are Lewis Hospital, Mossend Hospital, the Court House, the Drill Hall, the Masonic Hall, a commodious structure in which the public library is housed, and the fish mart. Stornoway Castle, overlooking the town from a height on the west side, is a handsome castellated mansion in the Tudor style, built as the residence of Sir James Matheson.

STORRS, RICHARD SALTER (1821-1900), American Congregational clergyman, was born in Braintree, Massachusetts, on the 21st of August 1821. He bore the same name as his grandfather (1763-1819), pastor at Long Meadow, Massachusetts, from 1785 to 1819, and his father (1787-1873), pastor at Braintree, Massachusetts, from 1811 to 1873 (except the years 1831-1836), both prominent Congregational ministers, who were descendants of Richard Mather. He graduated at Amherst in 1839, studied law in Boston under Rufus Choate, graduated at Andover theological seminary in 1845, and was pastor of the Harvard Congregational church of Brookline, Massachusetts, in 1845-1846, and of the Church of the Pilgrims in Brooklyn, New York, from 1846 until shortly before his death in Brooklyn on the 5th of June 1900. He was a conservative in theology, and an historical writer of considerable ability. From 1848 to 1861 he was associate editor of the *New York Independent*, which he had helped to establish; from 1887 to 1897 he was president of

the American board of commissioners for foreign missions, and he was prominent in the Long Island Historical Society. His great-grandfather, John Storrs (1735-1799), a chaplain in the Continental Army, had been pastor of the Southold Church in 1763-1776 and in 1782-1787. Dr Storrs's more important published works were: *John Wycliffe and the First English Bible* (1880), *The Recognition of the Supernatural in Letters and in Life* (1881), *Bernard of Clairvaux* (1892), and *Foundation Truths of American Missions* (1897).

See Charles Storrs, *The Storrs Family* (New York, 1886).

STORY, JOHN (c. 1510-1571), English martyr, was educated at Oxford, where he became lecturer on civil law in 1535, being made later principal of Broadgates Hall, afterwards Pembroke College. He appears to have disavowed his Roman Catholic opinions just after the accession of Edward VI., but having been chosen a member of parliament in 1547 he gained notoriety by his opposition to the act of uniformity in 1548. For crying out "Woe unto thee, O land, when thy king is a child," he was imprisoned by the House of Commons, but he was soon released and went into exile. Returning to England in 1553, he resigned his position at Oxford, which was now that of regius professor of civil law, and was made chancellor of the dioceses of London and of Oxford and dean of arches. Queen Mary being now on the throne, Story was one of her most active agents in prosecuting heretics, and was one of her proctors at the trial of Cranmer at Oxford in 1555. Under Elizabeth he was again returned to parliament, but in 1560 he underwent a short imprisonment for boasting about his work in the former reign. In 1563 he was again arrested, but managed to escape to Flanders, where he became a pensioner of Philip II. of Spain. The duke of Alva authorized him to exclude certain classes of books from the Netherlands and, in 1570, while engaged in this work, he was decoyed on to a ship at Antwerp and conveyed to Yarmouth. In spite of his claim that he was a Spanish subject, he was tried for high treason, and executed at Tyburn on the 1st of June 1571. In 1886 Story was beatified by papal decree.

STORY, JOSEPH (1779-1845), American jurist, was born at Marblehead, Massachusetts, on the 18th of September 1779. He graduated at Harvard in 1798, was admitted to the bar at Salem, Mass., in 1801, and soon attained eminence in his profession. He was a member of the Democratic party, and served in the Massachusetts House of Representatives in 1805-1808, and in 1810-1812 for two terms as speaker, and was a representative in Congress from December 1808 to March 1809. In November 1811, at the age of thirty-two, he became, by President Madison's appointment, an associate justice of the United States Supreme Court. This position he retained until his death. Here he found his true sphere of work. The traditions of the American people, their strong prejudice for the local supremacy of the states and against a centralized government, had yielded reluctantly to the establishment of the Federal legislative and executive in 1789. The Federal judiciary had been organized at the same time, but had never grasped the full measure of its powers. Soon after Story's appointment the Supreme Court began to bring out into plain view the powers which the constitution had given it over state courts and state legislation. The leading place in this work belongs to Chief Justice John Marshall, but Story has a very large share in that remarkable series of decisions and opinions, from 1812 until 1832, by which the work was accomplished. In addition to this he built up the department of admiralty law in the United States courts; he devoted much attention to equity jurisprudence, and rendered invaluable services to the department of patent law. In 1819 he attracted much attention by his vigorous charges to grand juries, denouncing the slave trade, and in 1820 he was a prominent member of the Massachusetts Convention called to revise the state constitution. In 1829 he became the first Dane Professor of Law at Harvard University, and continued until his death to hold this position, meeting with remarkable success as a teacher and winning the affection of his students, whom he imbued with much of his own enthusiasm. He died at

Cambridge, Mass., on the 10th of September 1845. His industry was unremitting, and, besides attending to his duties as an associate justice and a professor of law, he wrote many reviews and magazine articles, delivered various orations on public occasions, and published a large number of works on legal subjects, which won high praise on both sides of the Atlantic.

Among his publications are: *Commentaries on the Law of Bailments* (1832); *Commentaries on the Constitution of the United States* (3 vols., 1833), a work of profound learning which is still the standard treatise on the subject; *Commentaries on the Conflict of Laws* (1834), by many regarded as his ablest work; *Commentaries on Equity Jurisprudence* (2 vols., 1835-1836); *Equity Pleadings* (1838); *Law of Agency* (1839); *Law of Partnership* (1841); *Law of Bills of Exchange* (1843); and *Law of Promissory Notes* (1845). He also edited several standard legal works. His Supreme Court decisions may be found in Cranch's, Wheaton's and Peters's *Reports*, his Circuit Courts decisions in Mason's, Sumner's and Story's *Reports*. His *Miscellaneous Writings*, first published in 1835, appeared in an enlarged edition (2 vols. in 1851).

See *The Life and Letters of Joseph Story* (2 vols., Boston and London, 1851), by his son, W. W. Story.

STORY, ROBERT HERBERT (1835-1907), Scottish divine, principal of Glasgow University, was born on the 28th of January 1835 at Rosneath, Dumbartonshire. He was educated at the universities of Edinburgh, St Andrews and Heidelberg. In 1859 he was assistant minister at St Andrew's Church, Montreal, and in February 1860 was inducted as minister of Rosneath in succession to his father. In 1887 he removed to Glasgow as professor of church history; he had also been appointed in 1886 to a chaplaincy to Queen Victoria. In 1898 he became principal of the university in succession to John Caird. He was moderator of the General Assembly in 1894, and its principal clerk from that year till his death on the 13th of January 1907. Story was a staunch supporter of his Church, and had little sympathy for schemes of reunion with the other Presbyterian communities. He vigorously opposed the action of Bishop Welldon, then metropolitan of Calcutta, in excluding Scottish chaplains and troops from the use of garrison churches in India because these had received episcopal consecration. He was characterized by an absolutely fearless honesty, which sometimes gave offence, but at the basis of his nature there was a warm, tender and sympathetic heart, incapable of meanness or intrigue. In addition to lives of his father (1862), Professor Robert Lee (1870) and William Carstares (1876), he published a devotional book *Christ the Consoler*; a volume of sermons, *Creed and Conduct* (1878); *The Apostolic Ministry in the Scottish Church* (Baird Lecture, 1897), and several pamphlets on church questions.

See *Principal Story, a Memoir by his Daughters* (1909).

STORY, WILLIAM WETMORE (1819-1895), American sculptor and poet, son of the jurist, Joseph Story, was born at Salem, Massachusetts, on the 12th of February 1819. He graduated at Harvard College in 1838 and at the Harvard Law School in 1840, continued his law studies under his father, was admitted to the Massachusetts bar, and prepared two legal treatises of value—*Treatise on the Law of Contracts not under Seal* (2 vols., 1844) and *Treatise on the Law of Sales of Personal Property* (1847). Abandoning the law, he devoted himself to sculpture, and after 1850 lived in Rome, whither he had first gone in 1848, and where he was intimate with the Brownings and with Landor. He died at Vallombroso, Italy, on the 7th of October 1895. He was a man of rare social cultivation and charm of manner, and his studio in Rome was a centre for the gathering of distinguished English and American literary, musical and artistic people. During the American Civil War his letters to the *Daily News* in December 1861 (afterwards published as a pamphlet, "The American Question," *i.e.* of neutrality), and his articles in *Blackwood's*, had considerable influence on English opinion. One of his earliest works in sculpture was a statue of his father, now in the memorial chapel of Mount Auburn Cemetery, Cambridge, Mass.; others are "Cleopatra" (of which there is an enthusiastic description in Hawthorne's *Marble Faun*) and "Semiramis" in the Metropolitan Museum of Art, New York; the "Libyan Sibyl," "Saul," "Sardanapalus," "Judith,"

"Delilah," "Jerusalem Desolate," "Alcestis," "Medea," "Electra," "Nemesis," "Sappho" and other ideal figures; and portraits of George Peabody, erected in 1869 in London (a replica in bronze being in Baltimore, Maryland); President Quincy of Harvard, at Cambridge, Mass.; Colonel Prescott, at Bunker Hill; Edward Everett, Public Gardens, Boston, Mass.; Chief Justice Marshall, on the west terrace of the Capitol, and Professor Henry for the Smithsonian Institution, Washington; and Francis Scott Key, San Francisco. Among his writings, in addition to the legal treatises mentioned above, are *Life and Letters of Joseph Story* (1851), *Roba di Roma* (1862), *Proportions of the Human Figure* (1866), *Fiammetta* (1885), a novel, *Conversations in a Studio* (1890), *Excursions in Art and Letters* (1891), and several volumes of poems of considerable merit. His poems were collected in two volumes in 1885. Among the longer are "A Roman Lawyer in Jerusalem" (a rehabilitation of Judas Iscariot), "A Jewish Rabbi in Rome," "The Tragedy of Nero" and "Ginevra di Siena." The last named, with "Cleopatra," was included in his *Graffiti d'Italia*, a collection published in 1868.

His son, **JULIAN STORY** (1857-), the portrait painter, was a pupil of Frank Duveneck, and of Boulanger and Lefebvre in Paris, and became a member of the Society of American Artists, 1892, a chevalier of the Legion of Honour, Paris, 1901, and an associate of the National Academy of Design. He married in 1891 Emma Eames (b. 1867), the operatic prima donna, who secured a divorce in 1907.

See also Henry James, *William Wetmore Story and his Friends* (2 vols., London, 1903).

STOSS, VEIT (1438 or 1440-1533), German sculptor and wood carver, was born in Nuremberg. In 1477 he went to Cracow, where he was actively engaged until 1499. It was here that he carved the high altar for the Marienkirche, between 1477 and 1484. On the death of King Kasimir IV. in 1492 Stoss carved his tomb in red marble for the cathedral in Cracow. To the same date is ascribed the marble tombstone of the archbishop Zbigniew Ollsnicki in the cathedral at Gnesen; and soon after this he executed the Stanislaus altar for the Marienkirche at Cracow. In 1496 he returned to Nuremberg, where he did a great deal of work in completing altars. His main works are: a relief with the Coronation of the Blessed Virgin in the Germanic museum at Nuremberg, a statue of the Blessed Virgin in the Frauenkirche, the Annunciation in the Lorenzkirche and the circular rosary in the Germanic museum.

STOTHARD, CHARLES ALFRED (1786-1821), antiquarian draughtsman, son of Thomas Stothard (*q.v.*), was born in London on the 5th of July 1786. After studying in the schools of the Royal Academy, he began, in 1810, his first historical piece, the Death of Richard II. in Pomfret Castle. He published in 1811 the first part of his valuable work, *The Monumental Effigies of Great Britain*. He was appointed historical draughtsman to the Society of Antiquaries, and was deputed by that body to visit Bayeux to make drawings of the tapestry. He was made a fellow of the society in 1819, and subsequently engaged in numerous journeys with the view of illustrating the works of D. Lysons. While engaged in tracing a portrait from one of the windows of the church of Beer Ferrers, Devonshire, he fell and was killed on the spot (May 27, 1821). His widow (afterwards Mrs Bray), with her brother, completed his *Monumental Effigies*, left unfinished at his death.

A biography, by his widow, was published in 1823.

STOTHARD, THOMAS (1755-1834), English subject painter, was born in London on the 17th of August 1755, the son of a well-to-do innkeeper in Long Acre. Being a delicate child, he was sent at the age of five to a relative in Yorkshire, and attended school at Acomb, and afterwards at Tadcaster and at Ilford in Essex. Showing a turn for drawing he was apprenticed to a draughtsman of patterns for brocaded silks in Spitalfields, and during his leisure hours he attempted illustrations to the works of his favourite poets. Some of these drawings were praised by Harrison, the editor of the *Novelist's Magazine*, and, Stothard's master having died, he resolved to devote himself to art.

In 1778 he became a student of the Royal Academy, of which he was elected associate in 1792 and full academician in 1794. In 1812 he was appointed librarian, having served as assistant for two years. He died in London on the 27th of April 1834.

Among his earliest book illustrations are plates engraved for *Ossian* and for *Bell's Poets*; and in 1780 he became a regular contributor to the *Novelist's Magazine*, for which he executed one hundred and forty-eight designs, including his eleven admirable illustrations to *Peregrine Pickle* and his graceful subjects from *Clarissa* and *Sir Charles Grandison*. He contentedly designed plates for pocket-books, tickets for concerts, illustrations to almanacs, portraits of popular players—and into even the slightest and most trivial sketches he infused a grace and distinction which render them of value to the collectors of the present time. Among his more important series are the two sets of illustrations to *Robinson Crusoe*, one for the *New Magazine* and one for Stockdale's edition, and the plates to *The Pilgrim's Progress* (1788), to Harding's edition of Goldsmith's *Vicar of Wakefield* (1792), to *The Rape of the Lock* (1798), to the works of Gessner (1802), to Cowper's *Poems* (1825), and to *The Decameron*; while his figure-subjects in the superb editions of Roger's *Italy* (1830) and *Poems* (1834) prove that even in latest age his fancy was still unexhausted, and his hand hardly at all enfeebled. He is at his best in subjects of a domestic or a gracefully ideal sort; the heroic and the tragic were beyond his powers. The designs by Stothard were estimated by R. N. Wornum to number five thousand, and of these about three thousand have been engraved. His oil pictures are usually small in size, and rather sketchy in handling. Their colouring is often rich and glowing, being founded upon the practice of Rubens, of whom Stothard was a great admirer. The "Vintage," perhaps his most important oil painting, is in the National Gallery. He was a contributor to Boydell's Shakespeare Gallery, but his best-known painting is the "Procession of the Canterbury Pilgrims," also in the National Gallery, the engraving from which, begun by Luigi and continued by Niccolo Schiavonetti and finished by James Heath, attained an immense popularity. The commission for this picture was given to Stothard by R. H. Cromek, and was the cause of a quarrel with his friend William Blake. It was followed by a companion work, the "Flich of Bacon," which was drawn in sepia for the engraver but was never carried out in colour.

In addition to his easel pictures, Stothard adorned the grand staircase of Burghley House, near Stamford, with subjects of War, Intemperance, and the Descent of Orpheus in Heli (1799-1803); the mansion of Hafod, North Wales, with a series of scenes from Froissart and Monstrelet (1810); the cupola of the upper hall of the Advocates' Library, Edinburgh (now occupied by the Signet Library), with Apollo and the Muses, and figures of poets, orators, &c. (1822); and he prepared designs for a frieze and other decorations for Buckingham Palace, which were not executed, owing to the death of George IV. He also designed the magnificent shield presented to the duke of Wellington by the merchants of London, and executed with his own hand a series of eight etchings from the various subjects which adorned it. In the British Museum is a collection, in four volumes, of engravings of Stothard's works, made by Robert Balmanno.

An interesting but most indiscriminately eulogistic biography of Stothard, by his daughter-in-law, Mrs Bray, was published in 1851. A. C. Coxhead's *Thomas Stothard, R.A., an Illustrated Monograph* (1906), contains a short biographical chapter, and an accurately dated summary of the various books and periodicals illustrated by Stothard; see also Austin Dobson, *Eighteenth Century Vignettes*, 1st series (1892).

STOUGHTON, JOHN (1807-1897), English Nonconformist divine, was born at Norwich on the 18th of November 1807. His father was an Episcopalian, his mother a member of the Society of Friends. Stoughton was educated at Norwich Grammar School, and, after an interval of legal study, at Highbury Congregational College. In 1833 he became minister at Windsor, in 1843 at Kensington; in 1856 he was elected chair-

man of the Congregational Union. From 1872 to 1884 he was professor of historical theology in New College, Hampstead. He died at Ealing on the 24th of October 1897. Stoughton was no controversialist, but did a good deal of sound historical work which was published in *Church and State 1660-1663* (London, 1862); *Ecclesiastical History of England 1640-1660* (4 vols., London, 1867-1870); *Religion in England under Queen Anne and the Georges* (2 vols., 1878); *Religion in England from 1800 to 1880* (2 vols., 1884). He contributed an account of Nonconformist modes of celebrating the Lord's Supper to the ritual commission of 1870, arranged a conference on co-operation between Anglicans and dissenters (presided over by Archbishop Tait) in 1876, was one of Dean Stanley's lecturers in Westminster Abbey and a pall-bearer at his funeral. He was elected to the Athenaeum Club in 1874 on the nomination of Matthew Arnold.

Besides the books already mentioned he wrote a number of more popular works, among which *Homes and Haunts of Luther* (1875), *The Italian Reformers* (1881), and *The Spanish Reformers* (1883) are conspicuous. His *Recollections of a Long Life* (1894) furnish interesting autobiographical material.

STOUR, the name of several English rivers. (1) The East-Anglian Stour rises in the slight chalk hills in the south-east of Cambridgeshire and follows a course ranging from east to south-east to the North Sea at Harwich, passing Clare, Sudbury, Nayland and Manningtree. It falls about 380 ft. in a course of 60 m., and drains an area of 407 sq. m. Over nearly its entire course it forms the boundary between Suffolk and Essex. From Manningtree downward its course is estuarine, and it is joined immediately above Harwich by the estuary of the Orwell. It is navigable up to Sudbury but does not bear much traffic. (2) The Kentish Stour or Great Stour rises on the southern face of the North Downs, the branch called the East Stour having its source not far inland from Hythe, but flowing at first away from the sea, while the main or western branch rises near Lenham. They unite at Ashford. Passing Canterbury, the Stour divides into two branches, the larger reaching the English Channel in Pegwel Bay, while the smaller runs north to the North Sea at Reculver. The larger branch is joined in the levels by the Little Stour from the south. The Stour is navigable to Fordwich near Canterbury, but is little used above Sandwich. Its length is about 40 m., its fall from Ashford 150 ft., and its drainage area 370 sq. m. The name of Stour belongs also to (3) a considerable but unnavigable tributary of the Hampshire Avon, rising in Wiltshire, and touching Somersetshire and Dorsetshire before it joins the main river in Hampshire close to its mouth; (4) a left bank tributary of the Severn, which it joins at Stourport, its course being followed by the Worcestershire and Staffordshire canal; and (5) a small tributary of the upper Avon, rising in the north of Oxfordshire in the hills west of Banbury, and joining the main river a little below Stratford-on-Avon.

STOURBRIDGE, a market town in the Droitwich parliamentary division of Worcestershire, England, 144 m. N.W. by W. of London and 10 W. of Birmingham by the Great Western railway. Pop. of urban district (1901), 16,302. A branch canal connects with the Worcestershire and Staffordshire system. The town stands on an eminence on the left bank of the Stour. Among public buildings are a town-hall (1887) and town offices, and a school of science and art. There is an endowed grammar school founded by Edward VI., and a bluecoat or hospital school. Dr Johnson received part of his education in this town (1726-1727). The principal manufactures are in iron, leather and skins; there are glue works and fire-brick works. Coal and fire-clay are raised. The manufacture of glass was established in 1556 by emigrants from Hungary, the place where they erected their factory being still known as Hungary Hill. Annual fairs are held. The town was originally called Bedcote, a name retained by the manor. The urban district includes the townships of Upper Swinford and Wollaston.

STOURPORT, a market town in the Bewdley parliamentary division of Worcestershire, England, 14½ m. N. by W. of Worcester by the Great Western railway. Pop. of urban district

(1901), 4529. It lies on the left bank of the Severn, at the junction of the Stour and the Staffordshire and Worcestershire canal. The town grew up after the opening of the canal in 1768. Ironworks, carpet-weaving and tanneries occupy many hands. At Redstone, the site of a former important ferry over the Severn, is a curious hermitage, excavated out of the red sandstone bank.

STOVE, an apparatus for heating a room, building, greenhouse or hothouse, or for cooking. It is essentially closed or partially closed, as distinct from the open grate or fireplace, and consists of a receiver in which the fuel is burned, of cast or sheet-iron, tiles cemented together and backed or even of solid masonry. Stoves may be classified according to the fuel burned (see HEATING). The word was originally of wider meaning and was used of a heated room, house or chamber, thus the O. Eng. *stofa* glosses *balneum*, and mod. Ger. *Stube* and Dan. *stue* mean merely a room, O. H. Ger. *Stubā*, *Stupa* being used of a heated bathroom; early Du. *stove* also was used in this wider sense, the later form *stooft* is used as in modern English, and this may be the immediate source of the present meaning, the early word having been lost. Romanic languages borrowed it, e.g. Ital. *stufa*, Fr. *étuve*, O. Fr. *estuve*, whence was adapted Eng. "stew," properly a bath or hothouse, used chiefly in plural "stews," a brothel, and "to stew," originally to bathe, then to boil slowly, and as a noun, a mess of stewed meat. "Stew," a fish-pond, is a Low German word *stouwe*, dam, weir, fish-pond, from *stouwen*, to dam up, cf. Ger. *stauen*, Eng. *stow*.

STOW, JOHN (c. 1525–1605), English historian and antiquary, was the son of Thomas Stow, a tailor, and was born about 1525 in London, in the parish of St Michael, Cornhill. His parents were poor, for his father's whole rent for his house and garden was only 6s. 6d. a year, and Stow himself in his youth fetched every morning the milk for the family from a farm belonging to the nunnery of the Minories. He learned the trade of his father, but possibly did not practise it much after he grew up. In 1549 he "kept house" near the well within Aldgate, but afterwards he removed to Lime Street ward, where he resided till his death. About 1560 he entered upon the work with which his name is associated. He made the acquaintance of the leading antiquaries of his time, including William Camden, and in 1561 he published his first work, *The woorkes of Geffrey Chaucer, newly printed with divers additions whiche were never in printe before*. This was followed in 1565 by his *Summarie of Englyshe Chronicles*, which was frequently reprinted, with slight variations, during his lifetime. Of the first edition a copy was said to have been at one time in the Grenville library. In the British Museum there are copies of the editions of 1567, 1573, 1590, 1598 and 1604. Stow having in his dedication to the edition of 1567 referred to the rival publication of Richard Grafton (c. 1500–c. 1572) in contemptuous terms, the dispute between them became extremely embittered. Stow's antiquarian tastes brought him under ecclesiastical suspicion as a person "with many dangerous and superstitious books in his possession," and in 1568 his house was searched. An inventory was taken of certain books he possessed "in defence of papistry," but he was apparently able to satisfy his interrogators of the soundness of his Protestantism. A second attempt to incriminate him in 1570 was also without result. In 1580 Stow published his *Annales, or a Generale Chronicle of England from Brute until the present yeare of Christ 1580*; it was reprinted in 1592, 1601 and 1605, the last being continued to the 26th of March 1605, or within ten days of his death; editions "amended" by Edmund Howes appeared in 1615 and 1631.

The work by which Stow is best known is his *Survey of London*, published in 1598, not only interesting from the quaint simplicity of its style and its amusing descriptions and anecdotes, but of unique value from its minute account of the buildings, social condition and customs of London in the time of Elizabeth. A second edition appeared in his lifetime in 1603, a third with additions by Anthony Munday in 1618, a fourth by Munday and Dyson in 1633, a fifth with interpolated amendments by John Strype in 1720, and a sixth by the same editor in 1754. The edition of 1598 was reprinted, edited by W. J. Thoms, in 1842,

in 1846, and with illustrations in 1876. Through the patronage of Archbishop Parker, Stow was enabled to print the *Flores historiarum* of Matthew of Westminster in 1567, the *Chronicle* of Matthew Paris in 1571, and the *Historia brevis* of Thomas Walsingham in 1574. At the request of Parker he had himself compiled a "farre larger volume," *An history of this island*, but circumstances were unfavourable to its publication and the manuscript is now lost. Additions to the previously published works of Chaucer were twice made through Stow's "own painful labours" in the edition of 1561, referred to above, and also in 1597. A number of Stow's manuscripts are in the Harleian collection in the British Museum. Some are in the Lambeth library (No. 306); and from the volume which includes them were published by the Camden Society, edited by James Gairdner, *Three Fifteenth-Century Chronicles, with Historical Memoranda* by John Stowe the Antiquary, and *Contemporary Notes of Occurrences written by him* (1880). Stow's literary labours did not prove very remunerative, but he accepted poverty in a cheerful spirit. Ben Jonson relates that once when walking with him Stow jocularly asked two mendicant cripples "what they would have to take him to their order." In March 1604 James I. authorized him and his deputies to collect "amongst our loving subjects their voluntary contributions and kind gratuities," and himself began "the largesse for the example of others." If the royal appeal was successful Stow did not live long to enjoy the increased comfort resulting from it, as he died on the 6th of April 1605. He was buried in the London church of St Andrew Undershaft, where the monument erected by his widow, exhibiting a terra-cotta figure of him, still remains.

Stow's *Survey of London* has been edited with notes by C. L. Kingsford (Oxford, 1908).

STOWE, HARRIET ELIZABETH [BEECHER] (1811–1896), American writer and philanthropist, seventh child of Lyman and Roxana (Foote) Beecher, was born at Litchfield, Connecticut, U.S.A., on the 14th of June 1811. Her father (the Congregational minister of the town) and her mother were both descended from members of the company that, under John Davenport, founded New Haven in 1638; and the community in which she spent her childhood was one of the most intellectual in New England. At her mother's death in 1815 she came most directly under the influence of her eldest sister Catherine, eleven years her senior, a woman of keen intellect, who a few years later set up a school in Hartford to which Harriet went, first as a pupil, afterwards as teacher. In 1832 her father, who had for six years been the pastor of a church in Boston, accepted the presidency of the newly founded Lane Theological Seminary at Cincinnati. Catherine Beecher, who was eager to establish what should be in effect a pioneer college for women, accompanied him; and with her went Harriet as an assistant, taking an active part in the literary and school life, contributing stories and sketches to local journals and compiling a school geography. She was married on the 6th of January 1836 to one of the professors in the seminary, Calvin Ellis Stowe. In the midst of privation and anxiety, due largely to her husband's precarious health, she wrote continually, and in 1843 published *The Mayflower*, a collection of tales and sketches. Mrs Stowe passed eighteen years in Cincinnati under conditions which constantly thrust the problem of human slavery upon her attention. A river only separated Ohio from a slave-holding community. Slaves were continually escaping from their masters, and were harboured, on their way to Canada, by the circle in which Mrs Stowe lived. In the practical questions which arose, and in the great debate which was political, economical and moral, she took a very active part. When, therefore, in 1850, Mr Stowe was elected to a professorship in Bowdoin College, Brunswick, Maine, and removed his family thither, Mrs Stowe was prepared for the great work which came to her, bit by bit, as a religious message which she must deliver. In the quiet of a country town, far removed from actual contact with painful scenes, but on the edge of the whirlwind raised by the Fugitive Slave Bill, memory and imagination had full scope, and she wrote for serial publication in *The National Era*, an anti-slavery paper of Washington, D.C.,

the story of "Uncle Tom's Cabin; or, Life among the Lowly." The publication in book form (March 20, 1852) was a factor which must be reckoned in summing up the moving causes of the war for the Union. The book sprang into unexampled popularity, and was translated into at least twenty-three tongues. Mrs Stowe used the reputation thus won in promoting a moral and religious enmity to slavery. She reinforced her story with *A Key to Uncle Tom's Cabin*, in which she accumulated a large number of documents and testimonies against the great evil; and in 1853 she made a journey to Europe, devoting herself especially to creating an *entente cordiale* between Englishwomen and Americans on the question of the day. In 1856 she published *Dred; a Tale of the Dismal Swamp*, in which she threw the weight of her argument on the deterioration of a society resting on a slave basis. The establishment of *The Atlantic Monthly* in 1857 gave her a constant vehicle for her writings, as did also *The Independent* of New York, and later *The Christian Union*, of each of which papers successively her brother, Henry Ward Beecher, was one of the editors. From this time forth she led the life of a woman of letters, writing novels, of which *The Minister's Wooing* (1859) is best known, and many studies of social life in the form both of fiction and essay. She published also a small volume of religious poems, and towards the end of her career gave some public readings from her writings. In 1852 Professor Stowe accepted a professorship in the Theological Seminary at Andover, Massachusetts, and the family made its home there till 1863, when he retired wholly from professional life and removed to Hartford. After the close of the war for the Union Mrs Stowe bought an estate in Florida, chiefly in hope of restoring the health of her son, Captain Frederick Beecher Stowe, who had been wounded in the war, and in this southern home she spent many winters. After the death of her husband in 1886 she passed the rest of her life in the seclusion of her Hartford home, where she died on the 1st of July 1896. She is buried by the side of her husband at Andover.

See *Life of Harriet Beecher Stowe*, compiled from her letters and journals by her son, Charles Edward Stowe (Boston, 1890). *Life and Letters of Harriet Beecher Stowe*, edited by Annie Fields (Boston, 1898).

STOWELL, WILLIAM SCOTT, BARON (1745–1836), English judge and jurist, was born at Heworth, a village about 4 m. from Newcastle, on the 17th of October 1745, the son of a "coalfitter" (or tradesman engaged in the transport of coal). His younger brother John became the famous Lord Chancellor Eldon. Scott was educated at the Newcastle grammar school and Corpus Christi College, Oxford, where he gained a Durham scholarship in 1761. In 1764 he graduated and became first a probationary fellow and then—as successor to William (afterwards the well-known Sir William) Jones—a tutor of University college. As Camden reader of ancient history (1774) he rivalled the reputation of Blackstone. Although he had joined the Middle Temple in 1762, it was not till 1776 that Scott devoted himself to a systematic study of law. In 1779 he graduated as doctor of civil law, and, after the customary "year of silence," commenced practice in the ecclesiastical courts. His professional success was rapid. In 1783 he became registrar of the court of faculties, and in 1788 judge of the consistory court and advocate-general, in that year too receiving the honour of knighthood; and in 1798 he was made judge of the high court of admiralty. Sir William Scott twice contested the representation of Oxford University—in 1780 without success, but successfully in 1801. He also sat for Downton in 1790. Upon the coronation of George IV. (1821) he was raised to the peerage as Baron Stowell. After a life of distinguished judicial service Lord Stowell retired from the bench—from the consistory court in August 1821, and from the high court of admiralty in December 1827. His mental faculties became gradually feebler in his old age, and he died on the 28th of January 1836. Lord Stowell was twice married—in 1781 to Anna Maria, eldest daughter and heiress of John Bagnall of Early Court, Berks., by whom he had four children, one of these, a daughter, survived him; and in 1813 to the dowager marchioness of Sligo.

Lord Stowell's judgments are models alike of literary execution and of judicial reasoning. His style is chaste yet not inornate, nervous without abruptness, and perfectly adjusted in every instance to the subject with which he deals. His decisions in the cases of *Dalrymple v. Dalrymple* (Dr Dodson's Report) and *Evans v. Evans* (1 Hagg. 35)—from their combined force and grace, from the steadiness with which every collateral issue is set aside, from their subtle insight into human motives and from the light which they cast on marriage law—deserve and will repay attentive perusal. Lord Stowell composed with great care, and some of the MSS. which he revised for Haggard and Phillimore's Reports were full of interlineations. Stowell's mind was judicial rather than forensic—reasoning, not as for a dialectic victory nor so as to convince the parties on whose suit he was deciding, but only with sufficient clearness, fulness and force to justify the decision at which he had arrived.

The chief doctrines of international law with the assertion and illustration of which the name of Lord Stowell is identified are these: the perfect equality and entire independence of all states ("*Le Louis*," 2 Dod. 243)—a logical deduction from the Austinian philosophy and still one of the fundamental principles of English jurisprudence; that the elementary rules of international law bind even semi-barbarous states (the "*Hurtige Hane*," 2 Rob. 325); that blockade to be binding must be effectual (the "*Betsey*," 1 Rob. 93); and that contraband of war is to be determined by "probable destination" (the "*Jonge Margaretha*," 1 Rob. 189). In the famous Swedish convoy case (the "*Maria*," 1 Rob. 350; see, too, the "*Recovery*," 6 C. Rob. 348–9) Lord Stowell asserted that "a prize court is a court not merely of the country in which it sits but of the law of nations." "The seat of judicial authority," he added, in words which have become classic, "is indeed locally here, in the belligerent country, but the law itself has no locality." His dictum concerning the right of a belligerent to sink a neutral ship, when unable to take her before a prize court, was much quoted in 1904 in reference to the sinking of the "Knight Commander" by the Russians in the Far East.

The judgments of Lord Stowell were, almost without exception, confirmed on appeal, and they are to this day the international law of England, and have become presumptive though not conclusive evidence of the international law of America. "I have taken care," wrote Justice Story, "that they shall form the basis of the maritime law of the United States, and I have no hesitation in saying that they ought to do so in that of every civilized country in the world."

See Townsend, *Lives of Twelve Eminent Judges*, vol. ii.; *Quarterly Review*, vol. lxxv.; W. E. Surtees, *Sketch of Lords Stowell and Eldon*; Creasy, *First Platform of International Law*; *Reports of Prize Cases from 1745 to 1859*, ed. E. S. Roscoe (2 vols. 1905; contains all the more important of Lord Stowell's judgments).

STOWMARKET, a market town in the Stowmarket parliamentary division of Suffolk, England; 12 m. N.N.W. of Ipswich by the Great Eastern railway, on the river Gipping. Pop. of urban district (1901), 4,162. The church of St Peter and St Mary is Decorated and Early English, with a lofty tower and wooden spire. The ancient vicarage has associations with Milton through his tutor, Dr Young. The town has an extensive chemical manufactory, iron foundry, and factories for the manufacture of gun cotton, agricultural implements and compressed leather. There is also considerable trade in corn, malt, coal, slate and timber.

STRABANE, a market town and the principal town of Co. Tyrone, Ireland. Pop. (1901), 5,033. It stands at the junction of the rivers Mourne and Finn, which thenceforward form the Foyle. It is 161½ m. N.W. by N. from Dublin by the Great Northern railway, and has also a station on the Donegal railway, the two companies using separate lines to Londonderry. Lifford, across the river, practically a suburb of Strabane, is the county town of Co. Donegal. A short canal connects the town with the point at which the Foyle becomes navigable. The trade in corn is considerable. Linen and shirt making, and iron and brass founding, are prosecuted. A castle of the time of James I. has left no remains. The town is governed by an urban district council. It returned two members to the Irish parliament until the Union in 1800.

STRABO (born c. 63 B.C.), Greek geographer and historian, was born at Amasia in Pontus, a city which had been much Hellenized, and was the royal residence of the kings of Pontus. We know nothing of his father's family, but several of his mother's relatives held important posts under Mithradates V. and VI. Some were of Hellenic, others of Asiatic origin, but Strabo himself was by language and education thoroughly Greek. The date of his birth cannot be exactly determined, but from various

indications in his work it seems to have been about 63 B.C. He studied at Nysa under the grammarian Aristodemus, under Tyrannio the grammarian at Rome, under the philosopher Xenarchus either at Rome or at Alexandria, and he had studied Aristotle along with Boethus (possibly at Rome under Tyrannio, who had access to the Aristotelian writings in Sulla's library). He states that he saw P. Servilius Isauricus, who died at Rome in advanced years in 44 B.C., from which it has been inferred that he visited Rome early in life. He also tells us that he was at Gyaros (one of the Cyclades) when Augustus was at Corinth on his return to Rome from the East in 29 B.C., and that he accompanied the prefect of Egypt, Aelius Gallus, on his expedition to Upper Egypt, which seems to have taken place in 25-24 B.C. These are the only dates in his life which can be accurately fixed. The latest event mentioned in his work is the death of Juba, king of Mauretania, which took place in A.D. 21.

Although he had seen a comparatively small portion of the regions which he describes, he had travelled much. As he states himself: "Westward I have journeyed to the parts of Etruria opposite Sardinia; towards the south from the Euxine to the borders of Ethiopia; and perhaps not one of those who have written geographies has visited more places than I have between those limits." He tells us that he had seen Egypt as far south as Syene and Philae, Comana in Cappadocia, Ephesus, Mylasa, Nysa and Hierapolis in Phrygia, Gyaros and Populonia. Of Greece proper he saw but little; it is by no means certain that he even visited Athens, and though he describes Corinth as an eyewitness, it is clear that he was never at Delphi, and was not aware that the ruins of Mycenae still existed. He had seen Cyrene from the sea, probably on his voyage from Puteoli to Alexandria, where he remained a long time, probably amassing materials, and studying astronomy and mathematics. For nowhere could he have had a better means of consulting the works of historians, geographers and astronomers, such as Eratosthenes, Posidonius, Hipparchus and Apollodorus. We cannot tell where his *Geography* was written, but it was at least finally revised between A.D. 17 and 23, since we have historical allusions which can be dated to that time. Probably Strabo was then in Rome; the fact that his work passed unnoticed by Roman writers such as the elder Pliny does not prove the contrary.

Works.—His earliest writing was an historical work now lost, which he himself describes as his *Historical Memoirs*. He tells us (xi. 9, 3) that the sixth book of the *Memoirs* was identical with the second of the *Continuation of Polybius*; probably, therefore, books i.-iv. formed an introduction to the main work. This accounts for the fact that he speaks (ii. 70) of having treated of the exploits of Alexander in his *Memoirs*, a topic which could not have found a place in a work which began where that of Polybius ended (146 B.C.). According to Suidas, the continuation of Polybius was in forty-three books. Plutarch, who calls him "the Philosopher," quotes Strabo's *Memoirs* (*Luc.* 28), and cites him as an historian (*Sulla*, 26). Josephus, who constantly calls him "the Cappadocian," often quotes from him, but does not mention the title of the work.

The *Geography* is the most important work on that science which antiquity has left us. It was, as far as we know, the first attempt to collect all the geographical knowledge at the time attainable, and to compose a general treatise on geography. It is not merely a new edition of Eratosthenes. In general outline it follows necessarily the work of the last-named geographer, who had first laid down a scientific basis for geography. Strabo made considerable alterations, but not always for the better. The three books of the older work formed a strictly technical geographical treatise. Its small size prevented it from containing any such general description of separate countries as Strabo rightly conceived to fall within the scope of the geographer. "Strabo indeed appears to be the first who conceived a complete geographical treatise as comprising the four divisions of mathematical, physical, political and historical geography, and he endeavoured, however imperfectly, to keep all these objects in view." The incidental historical notices, which are often of great value and interest, are all his own. These digressions at times interrupt the symmetry of his plan; but Strabo had all the Greek love of legendary lore, and he discusses the journeys of Heracles as earnestly as if they were events within recent history. He regarded Homer as the source of all wisdom and knowledge—

indeed, his description of Greece is largely drawn from Apollodorus's commentary on the Homeric "Catalogue of Ships"—and treated Herodotus with undeserved contempt, classing him with Ctesias and other "marvel-mongers." Yet in some respects Herodotus had better information (e.g. in regard to the Caspian) than Strabo himself. Again, Strabo may be censured for discarding the statements of Pytheas respecting the west and north of Europe, accepted as they had been by Eratosthenes. But in this he relied on Polybius, whom he might justly consider as having from his position at Rome far better means of gaining accurate information. It must be admitted that the statements of Pytheas did not accord with the theory of Strabo just in those very points where he was at variance with Eratosthenes. He showed likewise an unwarranted scepticism in reference to the island of Cerne on the west coast of Africa, which without doubt the Carthaginians had long used as an emporium.

Strabo chiefly employed Greek authorities (the Alexandrian geographers Polybius, Posidonius and Theophanes of Mytilene, the companion of Pompey) and made comparatively little use of Roman authorities. Although he refers to Caesar's *Commentaries* once by name, and evidently made use of them in other passages, he but imperfectly availed himself of that work. He designed his geography as a sequel to his historical writings, and it had as it were grown out of his historical materials, which were chiefly Greek. Moreover Strabo probably amassed his material in the library of Alexandria, so that Greek authorities would naturally furnish the great bulk of his collections. Doubtless, however, he returned to Rome after a long sojourn in Alexandria, a fact which explains the defectiveness of his information about the countries to the east of his native land, and renders it possible for him to have made use of the "chorography" of Agrippa, a map of the Roman Empire and adjacent countries set up by order of Augustus in the Porticus Vipsaniae.

He designed the work for the statesman rather than for the student. He therefore endeavours to give a general sketch of the character, physical peculiarities and natural productions of each country, and consequently gives us much valuable information respecting ethnology, trade and metallurgy. It was almost necessary that he should select what he thought most important for description, and at times omit what we deem of more importance. With respect to physical geography, his work is a great advance on all preceding ones. Judged by modern standards, his description of the direction of rivers and mountain-chains seems defective, but allowance must be made for difficulties in procuring information, and for want of accurate instruments. In respect of mathematical geography, his lack of scientific training was no great hindrance. He had before him the results of Eratosthenes, Hipparchus and Posidonius. The chief conclusions of astronomers concerning the spherical figure and dimensions of the earth, its relation to the heavenly bodies, and the great circles of the globe—the equator, the ecliptic and the tropics—were considered as well established. He accepted also the division into five zones; he quotes approvingly the assertion of Hipparchus that it was impossible to make real advances in geography without astronomical observations for determining latitudes and longitudes.

The work consists of seventeen books, of which the seventh is imperfect. The first two are introductory, the next eight deal with Europe (two being devoted to Spain and Gaul, two to Italy and Sicily, one to the north and east of Europe, and three to Greek lands). The eleventh book treats of the main divisions of Asia and the more easterly districts, the next three of Asia Minor. Book xv. deals with India and Persia, book xvi. with Assyria, Babylonia, Syria and Arabia, and the closing book with Egypt and Africa.

Editions.—The Aldine (Venice, 1516) was unfortunately based on a very corrupt MS. The first substantial improvements in the text were due to Casaubon (Geneva, 1587; Paris, 1620), whose text remained the basis of subsequent editions till that of Coraës (Paris, 1815-1819), who removed many corruptions. The MSS. were first scientifically collated by Kramer (Berlin, 1844-1852), who demonstrated that Par. 1397 was the best authority for the first nine books (it contains no more) and Vat. 1329 for the remainder. Of later editions the most important are those of C. Müller (Paris, 1853) and Meineke (Leipzig, 1866-1877). H. F. Tozer's volume of selections (Oxford, 1893) is useful. Napoleon I., an admirer of Strabo, caused a French translation of the *Geography* to be made by Coraës, Letronne and others (Paris 1805-1819); Grosskurd's German translation (Berlin, 1831-1834), with notes, is a monumental work. The fragments of the *Historical Memoirs* have been edited by P. Otto (*Leipziger Studien XI*, 1891); see also Müller's *Fragmenta historicorum graecorum*, iii. 490 sqq. Bunbury's *History of Ancient Geography*, vol. ii. chs. 21, 22; and F. Dubois's *Examen de la géographie de Strabon* (Paris, 1891) should also be consulted. (H. S. J.)

STRACHAN, JOHN (1778-1867), first bishop of Toronto, son of John Strachan and Elizabeth Finlayson his wife, was born at Aberdeen, Scotland, on the 12th of April 1778. His father died in 1792 from an accident in the granite quarries of which he was an overseer. Thus from an early age young Strachan had to depend upon his own resources and even to assist his mother,

whom he loyally aided till her death in 1812. He managed, by undertaking private teaching and with the aid of a bursary, to go to the university of Aberdeen, where he took his M.A. degree. He attended some of the divinity classes at the university, where also he formed a lasting friendship with two of his fellow students, well known afterwards as Professor Duncan and Dr Chalmers. In 1799 he emigrated to Canada, having been recommended to the Hon. Richard Cartwright, of Kingston, Upper Canada, as suitable for tutorial work. Strachan went to Canada a Presbyterian. His associations there, however, were almost exclusively with Episcopalians, including Mr Cartwright and the Rev. Dr. Stuart, for a time the only clergyman in the district. Moreover, special provision had been made in the Constitutional Act of 1791 for the liberal endowment of the Protestant religion, then identified in the official mind with the Church of England, through what were afterwards known as the Clergy Reserves, being one-seventh of the lands of the new townships opened for settlement. Having decided to enter the Episcopal Church, Strachan was ordained on the 22nd of May 1803, and was immediately afterwards appointed to the parish of Cornwall. Thither he removed his school, which soon became the most noted educational institution in the country. There many future leaders of public and professional life in Canada came under the influence of Strachan's vigorous personality. In 1807 he married the youthful widow of Andrew McGill, a wealthy merchant of Montreal, and brother of the founder of McGill University. In 1811 he received the honorary degree of D.D. from his alma mater, Aberdeen University. During the same year Dr Stuart of Kingston died and was succeeded by his son George O'Kill Stuart, incumbent at York, the capital of the province. Through the influence of Lieut.-Governor Gore, supplemented by that of Sir Isaac Brock, Strachan was prevailed upon in 1812 to transfer himself to York, where he was soon deeply involved in civil and ecclesiastical politics.

During the War of 1812 he was of special service to the executive government and the citizens of the town when the American troops captured York and burned the public buildings. He was chiefly instrumental also in founding the Loyal and Patriotic Society of Upper Canada, which raised funds for the relief of the wounded and the assistance of the widows and orphans of the slain. On the urgent recommendation of Lieut.-Governor Gore he was appointed to the executive council of Upper Canada in 1815. A man of great force of character and much ability, of keen ambitions and unusual shrewdness, though not remarkable for breadth of mind, he attained to great influence in the executive government and was soon the leading spirit in that dominant group known in Upper Canadian history as the Family Compact. In 1820 he was appointed by Sir Peregrine Maitland a member of the legislative council in order that the governor might have a confidential medium through whom to make communication to the council. At the instance of the lieutenant-governor he went to England in 1824, to discuss various colonial questions with the earl of Bathurst, then colonial secretary. Strachan had no difficulty in convincing Lord Bathurst of the justice of his claims on all essential matters, the most important of which was the exclusive right of the Church of England in Canada to the Clergy Reserves. Though in favour of selling a portion of these lands to provide a fund for the existing needs of the Church, he secured the defeat of the proposal then before the government to dispose of the Clergy Reserves to the Canada Company. He took much interest in the educational affairs of the province, and in 1807 was instrumental in having provision made for the establishment of the first grammar schools. In 1824 he secured the passing of an act providing assistance for the public schools of each district. During his second visit to England in 1826-1827 he obtained a royal charter for the university of King's College, with provision for its endowment out of the crown lands. It was, however, to be entirely under the control of the Church of England. In 1827 Strachan became archdeacon of York.

The break-up of the Liverpool ministry in 1827 interrupted the successful development of Strachan's plans for placing virtually

the whole of the government endowments for religion and education under the control of the Episcopal Church. The storm of protest of the other religious denominations caused the colonial office to undertake an investigation of the whole question, the result of which was presented in the report of 1828. After a long silence in the face of severe and persistent criticism, Strachan made a general reply in a very able speech in the legislative council in March 1828. When the storm had subsided the Clergy Reserves and university questions remained dormant until 1836, when the attempt to apply the Reserves to the endowment of rectories renewed the trouble and contributed largely to the crisis of 1837. Adverse criticism and a suggestion from the colonial office that he should cease from active participation in political affairs led to his resignation from the executive council, but he declined to give up his seat in the legislative council.

On the death of Bishop Stewart of Quebec the Canadian see was divided, and Strachan was made bishop of Toronto in August 1839. He energetically opposed the act of 1840, which sought to settle the Clergy Reserves question by dividing the proceeds among the different religious denominations, the larger share still remaining with the Church of England.

The university of King's College was finally established, with certain modifications of its charter, in 1843, Bishop Strachan being the first president. The renewed agitation finally resulted in the elimination of all religious tests by the act of 1849, which also changed the name to that of the university of Toronto. Strachan at once took steps to found another university which should be completely under the control of the Episcopal Church, hence the establishment of Trinity University, which was opened in 1852. Bishop Strachan also raised once more the question of the disposal of the Clergy Reserves. After several strong appeals and counter-appeals to the British government, the Canadian parliament was allowed to deal as it pleased with the question, with the result that the Reserves were completely secularized in 1854, provision being made for the life-interest of the beneficiaries at the time. Bishop Strachan devoted the latter years of his long life entirely to his episcopal duties, and by introducing the diocesan synod he furnished the Episcopal Church in Canada with a more democratic organ of government. He died in November 1867.

STRACHEY, SIR JOHN (1823-1907), British Indian civilian, fifth son of Edward Strachey, was born in London on the 5th of June 1823. After passing through Haileybury, Strachey entered the Bengal civil service in 1842, and served in the North-Western Provinces, occupying many important positions. In 1861 Lord Canning appointed him president of a commission to investigate the great cholera epidemic of that year. In 1862 he became judicial commissioner in the Central Provinces. In 1864, after the report of the royal commission on the sanitary condition of the army, a permanent sanitary commission was established in India, with Strachey as president. In 1866 he became chief commissioner of Oudh, having been chosen by Lord Lawrence to remedy as far as possible the injustice done after the Mutiny by the confiscation of the rights of tenants and small proprietors of land, maintaining at the same time the privileges of the Talukdars of great landlords. As member of the legislative council he introduced several bills for that purpose, which, with the full approval of the Talukdars, passed into law. In 1868 he became member of the governor-general's council, and on the assassination of Lord Mayo in 1872 he acted temporarily as viceroy. In 1874 he was appointed lieutenant-governor of the North-Western Provinces. In 1876, by request of Lord Lytton and the secretary of state, he consented to relinquish that office, and returned to the governor-general's council as financial minister, which post he retained until 1880. During this time, while Lord Lytton was viceroy, important reforms were carried out. The measures for decentralizing financial administration, initiated under Lord Mayo, were practically completed. The salt duties were reduced, and the system under which they were levied was altered, and that opprobrium of our administration, the inland customs line, was abolished. The removal of all

import duties, including those on English cotton goods, and the establishment of complete free trade, was declared to be the fixed policy of the government, and this was in great measure carried into effect before 1880, when Strachey left India. The defective system on which the military accounts were kept occasioned a very erroneous estimate of the cost of the Afghan War of 1878-80. For this error Strachey was technically responsible, and it was made the occasion of a violent party attack which resulted in his resignation. The fact that almost the entire cost of the war was paid for out of revenue is a conclusive proof of the state of financial prosperity to which India attained as the result of his administration. From 1885 to 1895 Strachey was a member of the council of the secretary of state for India. He was joint author with Sir Richard Strachey of *The Finances and Public Works of India* (1882), besides writing *India* (3rd ed., 1903), and *Hastings and the Rohilla War* (1892). He died on the 19th of December 1907.

STRACHEY, SIR RICHARD (1817-1908), British soldier and Indian administrator, third son of Edward Strachey, was born on the 24th of July 1817, at Sutton Court, Somersetshire. From Addiscombe he passed into the Bengal Engineers in 1836, and was employed for some years on irrigation works in the North-Western Provinces. He served in the Sutlej campaign of 1845-46, and was at the battles of Aliwal and Sobraon, was mentioned in despatches, and received a brevet-majority. From 1858 to 1865 he was chiefly employed in the public works department, either as acting or permanent secretary to the government of India, and from 1867 to 1871 he filled the post of director-general of irrigation, then specially created. During this period the entire administration of public works was reorganized to adapt it to the increasing magnitude of the interests with which this department has had to deal since its establishment by Lord Dalhousie in 1854. For this reorganization, under which the accounts were placed on a proper footing and the forest administration greatly developed, Strachey was chiefly responsible. His work in connexion with Indian finance was important. In 1867 he prepared a scheme in considerable detail for decentralizing the financial administration of India, which formed the basis of the policy afterwards carried into effect by his brother Sir John Strachey under Lord Mayo and Lord Lytton. He left India in 1871, but in 1877 he was sent there to confer with the government on the purchase of the East Indian railway, and was then selected as president of the commission of inquiry into Indian famines. In 1878 he was appointed to act for six months as financial member of the governor-general's council, when he made proposals for meeting the difficulties arising from the depreciation of the rupee, then just beginning to be serious. These proposals did not meet with the support of the secretary of state. From that time he continued to take an active part in the efforts made to bring the currencies of India and England into harmony, until in 1892 he was appointed a member of Lord Herschell's committee, which arrived at conclusions in accordance with the views put forward by him in 1878. He attended in 1892 the International Monetary Conference at Brussels as delegate for British India. Strachey was a member of the council of the secretary of state for India from 1875 to 1889, when he resigned his seat in order to accept the post of chairman of the East Indian Railway Company. Strachey's scientific labours in connexion with the geology, botany and physical geography of the Himalaya were considerable. He devoted much time to meteorological research, was largely instrumental in the formation of the Indian meteorological department, and became chairman of the meteorological council of the Royal Society in 1883. From 1888 to 1890 he was president of the Royal Geographical Society. In 1897 he was awarded one of the royal medals of the Royal Society, of which he became a fellow in 1854; and in the same year he was created G.C.S.I. He died on the 12th of February 1908. His widow, Lady Strachey, whom he married in 1880, became well-known as an authoress and a supporter of women's suffrage.

STRACHWITZ, MORITZ KARL WILHELM ANTON, GRAF VON (1822-1847), German poet, was born on the 13th of March

1822 at Peterwitz near Frankenstein in Silesia. After studying in Breslau and Berlin he settled on his estate in Moravia, where he devoted himself to literary pursuits. When travelling in Italy in 1847 he was taken ill at Venice, and died on the 11th of December at Vienna. Although he had thus only reached his twenty-fifth year, he revealed a lyric genius of remarkable force and originality. His first collection of poems, *Lieder eines Erwachenden*, appeared in 1842 and went through several editions. *Neue Gedichte* were published after his death in 1848. These poems are characteristic of the transition through which the German lyric was passing between 1840 and 1848; the old Romantic strain is still dominant, especially in his ballads, which are unquestionably his finest productions; but, side by side with it, there is to be seen the influence of Platen, to whose warmest admirers Strachwitz belonged, as well as echoes of the restless political spirit of those eventful years. His political lyric was, however, tempered by an aristocratic restraint which was absent from the writings of men like Herwegh and Freiligrath. Strachwitz's early death was a great loss to German letters; for he was by far the most promising of the younger lyric poets of his time.

Strachwitz's collected *Gedichte* appeared first in 1850 (8th ed., 1891); a convenient reprint will be found in Reclam's *Universalbibliothek*. See A. K. T. Tielo, *Die Dichtung des Grafen Moritz von Strachwitz* (1902).

STRADELLA, ALESSANDRO (?1645-1682), Italian composer, was one of the most accomplished musicians of the 17th century. The hitherto generally accepted story of his life was first circumstantially narrated in Bonnet-Bourdelot's *Histoire de la musique et de ses effets* (Paris, 1715). According to this account, Stradella not only produced some successful operas at Venice, but also attained so great a reputation by the beauty of his voice that a Venetian nobleman engaged him to instruct his mistress, Ortensia, in singing. Stradella, the narrative goes on to say, shamefully betrayed his trust, and eloped with Ortensia to Rome, whither the outraged Venetian sent two paid *bravi* to put him to death. On their arrival in Rome the assassins learned that Stradella had just completed a new oratorio, over the performance of which he was to preside on the following day at S. Giovanni in Laterano. Taking advantage of this circumstance, they determined to kill him as he left the church; but the beauty of the music affected them so deeply that their hearts failed them at the critical moment, and, confessing their treachery, they entreated the composer to ensure his safety by quitting Rome immediately. Thereupon Stradella fled with Ortensia to Turin, where, notwithstanding the favour shown to him by the regent of Savoy, he was attacked one night by another band of assassins, who, headed by Ortensia's father, left him on the ramparts for dead. Through the connivance of the French ambassador the ruffians succeeded in making their escape; and in the meantime Stradella, recovering from his wounds, married Ortensia, by consent of the regent, and removed with her to Genoa. Here he believed himself safe; but a year later he and Ortensia were murdered in their house by a third party of assassins in the pay of the implacable Venetian.

Recent research has shown that Stradella was the son of a Cavaliere Marc'antonio Stradella of Piacenza, who in 1642-1643 was vice-marchese and governor of Vignola for Prince Boncompagni, who did not wish to live in the dominions from which he took the title of marchese di Vignola. He was deprived of his office in 1643 for having surrendered the castle to the papal troops, although it might have sustained a siege of several days and the help of the duke of Modena was expected. An elder brother of Alessandro, Francesco by name, became a member of the Augustinian order, and seems to have enjoyed the protection of the house of Este. Alessandro is supposed to have been born about 1645 or earlier, probably at Vignola, or Monfestino, a town on the road from Modena to Pistoja, to which his father retired after his dismissal; but no records of his birth have come to light in either of these places. The first certain date in his life is 1672, in which year he composed a prologue for the performance of Cesti's opera *La Dori* at Rome; and we may conclude that he spent a considerable time at Rome about this period, since his

cantatas and other compositions contain frequent allusions to Rome and noble Roman families. There is, however, no proof that he ever performed the oratorio *S. Giovanni Battista* in the Lateran. Documents in the archives at Turin relate that in 1677 he arrived there with the mistress of Alvise Contarini, with whom he had eloped from Venice. Contarini demanded that both should be given up to him, or failing that, that Stradella should not be allowed to exercise his profession until the lady had been either placed in a convent or made his legitimate wife. Stradella was protected by the regent of Savoy, the duchess Giovanni Battista de Nemours, and the Contarini family, indignant at his audacity, sent two hired assassins to Turin, by whom Stradella was wounded but not murdered. We hear of Stradella last at Genoa. An opera by him, *La Forza dell' amor paterno*, was given there in 1678, and his last composition, *Il Barcheggio* (i.e. a "Water-Music"), was performed on the 16th of June 1681 in honour of the marriage of Carlo Spinola and Paola Brignole, which was solemnized on the 6th of July of the same year. Documents in the archives at Modena inform us that in February 1682 Stradella was murdered at Genoa by three brothers of the name of Lomellini, whose sister he had seduced.

It is extremely improbable that Stradella had any great reputation as a singer, since the great Italian singers of the 17th century were almost exclusively *castrati*; but he may well have been a teacher of singing, and he appears to have instructed his lady pupils in Genoa on the harpsichord. He is principally important as a composer of operas and chamber-cantatas, although compared with his contemporaries his output was small. In spite of his dissolute life his command of the technique of composition was remarkable, and his gift of melodic invention almost equal to that of A. Scarlatti, who in his early years was much influenced by Stradella. His best operas are *Il Floridoro*, also known as *Il Moro per amore*, and *Il Trespolo tutore*, a comic opera in three acts which worthily carried on the best traditions of Florentine and Roman comic opera in the 17th century. His church music, on which his reputation has generally been based, is of less importance, though the well-known oratorio *S. Giovanni Battista* displays the same skill in construction and orchestration (so far as the limited means at his disposal permitted) as the operas. A serenata for voices and two orchestras, *Qual prodigo ch'io miri*, was used by Handel as the basis of several numbers in *Israel in Egypt*, and was printed by Chrysander (Leipzig, 1888); the MS., however, formerly in the possession of Victor Schoelcher, from which Chrysander made his copy, has entirely disappeared. The well-known aria *Pietà, signore*, also sung to the words *Se i miei sospiri*, cannot possibly be a work of Stradella, and there is every reason to suppose that it was composed by Fétis, Niedermeyer or Rossini.

The finest collection of Stradella's works extant is that at the Biblioteca Estense at Modena, which contains 148 MSS., including four operas, six oratorios and several other compositions of a semi-dramatic character. A collection of *cantate a voce sola* was bequeathed by the Contarini family to the library of St Mark at Venice; and some MSS. are also preserved at Naples and in Paris. Eight madrigals, three duets, and a sonata for two violins and bass will be found among the Additional MSS. at the British Museum, five pieces among the Harleian MSS., and eight cantatas and a motet among those in the library at Christ Church, Oxford. The Fitzwilliam Museum at Cambridge possesses a large number of his chamber-cantatas and duets.

See also Heinz Hess, *Die Opern Alessandro Stradellas* (Leipzig, 1905), which includes the most complete catalogue yet made of Stradella's extant works; Catalani, *Delle Opere di A. Stradella insistenti nell' archivio musicale della r. biblioteca palatina di Modena* (Modena, 1865); and Sedley Taylor, *The Indebtedness of Handel to other Composers* (Cambridge, 1906).

STRADIVARI, ANTONIO (1644-1737), Italian violin-maker, is associated throughout his life with Cremona, where he brought the craft of violin-making to its highest pitch of perfection. The obscure details of his life have been thoroughly worked out in the monograph on him by W. H. Hill, A. F. Hill and Alfred Hill (1902). He was still a pupil of Nicolas Amati in 1666, when he had already begun to insert his own label on violins of his making, which at first follow the smaller Amati model, solidly constructed, with a thick yellow varnish. It was not

till 1684 that he began to produce a larger model, using a deeper coloured varnish, and beautifying the instruments in various details, his "long" patterns (from 1690) representing a complete innovation in its proportions; while from 1700, after for a few years returning to an earlier style, he again broadened and otherwise improved his model. He also made some beautiful violoncellos and violas. The most famous instruments by him are:—*Violins*: the "Hellier" (1679), the "Sellière" (before 1680), the "Tuscan" (1690), the "Betts" (1704), the "Ernst" (1709), "La Pucelle" (1709), the "Viotti" (1709), the "Vieuxtemps" (1710), the "Parke" (1711), the "Boissier" (1713), the "Dolphin" (1714), the "Gillot" (1715), the "Alard," the finest of all (1715), the "Cessot" (1716), the "Messiah" (1716), the "Sasserno" (1717), the "Maurin" (1718), the "Lauterbach" (1719), the "Blunt" (1721), the "Sarasate" (1724), the "Rode" (1722), the "Deurbroucq" (1727), the "Kiesewetter" (1731), the "Habeneck" (1736), the "Muntz" (1736). *Violas*: the "Tuscan" (1690), two of 1696 formerly belonging to the king of Spain, the "Archinto" (1696), the "Macdonald" (1701), and the "Paganini" (1731). *Violoncellos*: the "Archinto" (1689), the "Tuscan" (1690), the "Aylesford" (1696), the "Cristiani" (1700), the "Servais" (1701), the "Gore-Booth" (1710), the "Duport" (1711), the "Adam" (1713), the "Batta" (1714), the "Piatti," the finest of all (1720), the "Bandiot" (1725), the "Gallay" (1725). Antonio Stradivari's sons Francesco (1671-1743) and Omobono (1679-1742) were also violin-makers, who assisted their father, together with Carlo Bergonzi, who appears to have succeeded to the possession of Antonio's stock-in-trade. The Stradivari method of violin-making created a standard for subsequent times; but what is regarded as Antonio's special advantage, now irrecoverable, was his varnish, soft in texture, shading from orange to red, the composition of which has been much debated. (See also VIOLIN.)

STRAFFORD, EARLS OF. The first earl of Strafford was Charles I.'s friend and adviser, Thomas Wentworth (see below). When he was attainted and executed in May 1641 his honours were forfeited, but later in the year his only son, William (1626-1695), was created earl of Strafford, his father's attainder being reversed by act of parliament in 1662. William died without issue on the 16th of October 1695, when all his titles, except the barony of Raby, became extinct. His estates passed to a kinsman, Thomas Watson, afterwards Watson-Wentworth (d. 1723), a son of Anne (1629-1695), daughter of the 1st earl, and her husband Edward Watson, 2nd Baron Rockingham. In 1746 Watson-Wentworth's son, Thomas Watson-Wentworth (c. 1690-1750), was created marquess of Rockingham, and when his son Charles, the 2nd marquess, died in 1782, the estates passed to his maternal nephew, William Fitzwilliam, 2nd Earl Fitzwilliam (1748-1833). His descendant, the present Earl Fitzwilliam, is the owner of Wentworth Woodhouse, near Rotherham, and the representative of the Wentworth family.

The barony of Raby passed to the 2nd earl's cousin, Thomas Wentworth (1672-1739), son and heir of Sir William Wentworth of Northgate Head, Wakefield. In early life he saw much service as a soldier in the Low Countries, and was occasionally employed on diplomatic errands. From 1711 to 1714 he was British ambassador at the Hague, and in 1711 he was created earl of Strafford. The earl was one of the British representatives at the congress of Utrecht, and in 1715 he was impeached for his share in concluding this treaty, but the charges against him were not pressed to a conclusion. He died on the 15th of November 1739. The earldom became extinct when Frederick Thomas, the 5th earl, died in August 1799. William, the 4th earl (1722-1791), had a sister Anne, who married William Connolly; and one of their daughters, Anne, married George Byng (d. 1789) of Wrotham Park, Middlesex. Their son, Sir John Byng (1772-1860), a distinguished soldier, was created earl of Strafford and Viscount Enfield in 1847. Having entered the army in 1793, Byng served in Flanders and commanded a brigade during the Peninsular War. He was present at Waterloo and became a field marshal in 1855. The earldom of Strafford is still held by his descendants.

STRAFFORD, THOMAS WENTWORTH, EARL OF (1593-1641), English statesman, son of Sir William Wentworth, of Wentworth Woodhouse, near Rotherham, a member of an ancient family long established there, and of Anne, daughter of Sir Robert Atkins of Stowell, Gloucestershire, was born on the 13th of April 1593, in London. He was educated at St John's College, Cambridge, was admitted a student of the Inner Temple in 1607, and in 1611 was knighted and married Margaret, daughter of Francis Clifford, 4th earl of Cumberland. In 1614 he represented Yorkshire in the Addled Parliament, but, so far as is now known, it was not till the parliament of 1621, in which he sat for the same constituency, that he took part in the debates. His position towards the popular party was peculiar. He did not sympathize with their zeal for war with Spain, but James's denial of the rights and privileges of parliament seems to have caused him to join in the vindication of the claims of the House of which he was a member, and he was a warm supporter of the protestation which drew down a sentence of dissolution upon the third parliament of James.

In 1622 Wentworth's wife died, and in February 1625 he married Arabella Holles, daughter of the earl of Clare. He was returned for Pontefract to the parliament of 1624, but appears to have taken no part in the proceedings. He had no sympathy with the popular outcry against Spain nor for wars undertaken for religious considerations to the neglect of the practical interests of the country. He desired also to avoid foreign complications and "do first the business of the commonwealth." To the advances of Buckingham he replied coldly that "he was ready to serve him as an honest man and a gentleman." In the first parliament of Charles I., June 1625, he again represented Yorkshire, and at once marked his hostility to the proposed war with Spain by supporting a motion for an adjournment before the house proceeded to business. He took part in the opposition to the demand made under the influence of Buckingham for war subsidies, and was consequently, after the dissolution in November, made sheriff of Yorkshire, in order to exclude him from the parliament which met in 1626. Yet he had never taken up an attitude of antagonism to the king. His position was very different from that of the regular opposition. He was anxious to serve the Crown, but he disapproved of the king's policy. In January 1626 he had asked for the presidency of the council of the North, and had visited and been favourably received by Buckingham. But after the dissolution of the parliament he was dismissed from the justiceship of the peace and the office of *custos rotulorum* of Yorkshire, to which he had been appointed in 1615, as the result probably of his resolution not to support the court in its design to force the country to contribute money without a parliamentary grant. At all events he refused in 1627 to contribute to the forced loan, and was imprisoned in consequence.

Wentworth's position in the parliament of 1628 was a striking one. He joined the popular leaders in resistance to arbitrary taxation and imprisonment, but he tried to obtain his end with the least possible infringement of the prerogative of the Crown, to which he looked as a reserve force in times of crisis. With the approbation of the House he led the movement for a bill which would have secured the liberties of the subject as completely as the Petition of Right afterwards did, but in a manner less offensive to the king. The proposal was wrecked between the uncompromising demands of the parliamentary party who would give nothing to the prerogative and Charles's refusal to make the necessary concessions, and the leadership was thus snatched from Wentworth's hands by Eliot and Coke. Later in the session he fell into conflict with Eliot, as, though he supported the Petition of Right in substance, he was anxious to come to a compromise with the Lords, so as to leave room to the king to act unchecked in special emergencies.

On the 22nd of July 1628, not long after the prorogation, Wentworth was created Baron Wentworth, and received a promise of the presidentship of the Council of the North at the next vacancy. This implied no change of principle whatever. He was now at variance with the parliamentary party on two great subjects of policy, disapproving both of the intention of

parliament to seize the powers of the executive and also its inclination towards puritanism. When once the breach was made it naturally grew wider, partly from the engrossing energy which each party put into its work, and partly from the personal animosities which of necessity arose. Such and no other was the nature of Wentworth's so-called "apostacy."

As yet Wentworth took no part in the general government of the country. In December he became Viscount Wentworth and president of the Council of the North. In the speech delivered at York on his taking office he announced his intention, almost in the words of Bacon, of doing his utmost to bind up the prerogative of the Crown and the liberties of the subject in indistinguishable union. "Whoever," he said, "ravels forth into questions the right of a king and of a people shall never be able to wrap them up again into the comeliness and order he found them." His government here was characterized by the same feature which afterwards marked his administration in Ireland and which it was the gravest charge in his impeachment that he intended to introduce into the whole English administration, namely the attempt to centralizè all power with the executive at the expense of the individual in defiance of those constitutional liberties which ran counter to and impeded this policy.

The session of 1629 ended in a breach between the king and the parliament which made the task of a moderator hopeless. Wentworth had to choose between helping a Puritan House of Commons to dominate the king and helping the king to dominate a Puritan House of Commons. He instinctively chose the latter course, and he threw himself into the work of repression with characteristic energy, as if the establishment of the royal power was the one thing needful. Yet even when he was most resolute in crushing resistance he held that he and not his antagonists were maintaining the old constitution, which they had attempted to alter by claiming supremacy for parliament.

In November 1629 Wentworth became a privy councillor. In October 1631 he lost his second wife, and in October 1632 he married Elizabeth, daughter of Sir Godfrey Rhodes. In January 1632 he had been named lord-deputy of Ireland, and arrived in Dublin in July 1633.

Here he had to deal with a people who had not arrived at national cohesion, and amongst whom English colonists had been from time to time introduced, some of them, like the early Norman settlers, being Roman Catholics, whilst the later importations stood aloof and preserved their Protestantism. In his government here he showed the most remarkable abilities as a ruler. "The lord deputy of Ireland," wrote Sir Thomas Roe to the queen of Bohemia, "doth great wonders and governs like a king, and hath taught that kingdom to show us an example of envy, by having parliaments and knowing wisely how to use them." He reformed the administration, getting rid summarily of the inefficient English officials. He succeeded in so manipulating the parliaments that he obtained the necessary grants, and secured their co-operation in various useful legislative enactments. He set on foot a new victualling trade with Spain, established or promoted the linen manufacture, and encouraged the development of the resources of the country in many directions. The customs rose from a little over £25,000 in 1633-1634 to £57,000 in 1637-1638. He raised an army. He swept the pirates from the seas. He reformed and instilled life into the Church and rescued church property. His strong and even administration broke down the tyranny of the great men over the poor. Such was the government of "Thorough," as Strafford expresses it. Yet these good measures were all carried out by arbitrary methods which diminished their usefulness and their stability. Their aim moreover was not the prosperity of the Irish community but the benefit to the English exchequer, and Strafford suppressed the trade in cloth "lest it should be a means to prejudice that staple commodity of England." ¹ Extraordinary acts of despotism took place, as in the case of Esmond, Lord Chancellor Loftus and Lord Mountnorris, the last of whom Strafford caused to be sentenced to death

¹ Strafford's Report of 1636. *Cat. of State Papers; Irish, 1633-1647*, p. 134.

in order to obtain the resignation of his office, and then pardoned. Promises of legislation such as the concessions known as the "graces" were not kept. In particular Strafford set at naught Charles's promise that no colonists should be forced into Connaught, and in 1635 he proceeded to that province, where, raking up an obsolete title—the grant in the 14th century of Connaught to Lionel, duke of Clarence, whose heir Charles was—he insisted upon the grand juries in all the counties finding verdicts for the king. One only, that of Galway, resisted, and the confiscation of Galway was effected by the court of exchequer, while he fined the sheriff £1000 for summoning such a jury, and cited the jurymen to the castle chamber to answer for their offence. In Ulster the arbitrary confiscation of the property of the city companies aroused dangerous animosity against the government. Towards the native Irish Wentworth's bearing was benevolent but thoroughly unsympathetic. Having no notion of developing their qualities by a process of natural growth, his only hope for them lay in converting them into Englishmen as soon as possible. They must be made English in their habits, in their laws and in their religion. "I see plainly," he once wrote, "that, so long as this kingdom continues popish, they are not a people for the Crown of England to be confident of." High-handed as Wentworth was by nature, his rule in Ireland made him more high-handed than ever. As yet he had never been consulted on English affairs, and it was only in February 1637 that Charles asked his opinion on a proposed interference in the affairs of the Continent. In reply, he assured Charles that it would be unwise to undertake even naval operations till he had secured absolute power at home. He wished that Hampden and his followers "were well whipped into their right senses." The opinion of the judges had given the king the right to levy ship-money, but, unless his majesty had "the like power declared to raise a land army, the Crown" seemed "to stand upon one leg at home, to be considerable but by halves to foreign princes abroad." When the Scottish Puritans rebelled he advocated the most decided measures of repression, in February 1639 sending the king £2000 as his contribution to the expenses of the coming war, at the same time deprecating an invasion of Scotland before the English army was trained, and advising certain concessions in religion.

Wentworth arrived in England in September 1639, after Charles's failure in the first Bishops' War, and from that moment he became Charles's principal adviser. Ignorant of the extent to which opposition had developed in England during his absence, he recommended the calling of a parliament to support a renewal of the war, hoping that by the offer of a loan from the privy councillors, to which he himself contributed £20,000, he would place Charles above the necessity of submitting to the new parliament if it should prove restive. In January 1640 he was created earl of Strafford, and in March he went to Ireland to hold a parliament, where the Catholic vote secured a grant of subsidies to be used against the Presbyterian Scots. An Irish army was to be levied to assist in the coming war. When in April Strafford returned to England he found the Commons holding back from a grant of supply, and tried to enlist the peers on the side of the king. On the other hand he induced Charles to be content with a smaller grant than he had originally asked for. The Commons, however, insisted on peace with the Scots. Charles, on the advice, or perhaps by the treachery of Vane, returned to his larger demand of twelve subsidies; and on the 9th of May, at the privy council, Strafford, though reluctantly, voted for a dissolution. The same morning the Committee of Eight of the privy council met again. Vane and others were for a mere defence against invasion. Strafford's advice was the contrary. "Go on vigorously or let them alone . . . go on with a vigorous war as you first designed, loose and absolved from all rules of government, being reduced to extreme necessity, everything is to be done that power might admit. . . . You have an army in Ireland you may employ here to reduce this kingdom . . ." He tried to force the citizens of London to lend money. He supported a project for debasing

the coinage and for seizing bullion in the Tower, the property of foreign merchants. He also advocated the purchase of a loan from Spain by the offer of a future alliance. He was ultimately appointed to command the English army, and was made a knight of the Garter, but he was seized with illness, and the rout of Newburn made the position hopeless. "Pity me," he wrote to his friend Sir George Radcliffe, "for never came any man to so lost a business . . . In one word here alone to fight with all these evils, without any one to help." In the great council of peers, which assembled on the 24th of September at York, the struggle was given up, and Charles announced that he had issued writs for another parliament.

The Long Parliament assembled on the 3rd of November 1640, and Charles immediately summoned Strafford to London, promising that he "should not suffer in his person, honour or fortune." He arrived on the 9th and on the 10th proposed to the king to forestall his impeachment, now being prepared by the parliament, by accusing the leaders of the popular party of treasonable communications with the Scots. The plan however having been betrayed, Pym immediately took up the impeachment to the Lords on the 11th. Strafford came to the house to confront his accusers, but was ordered to withdraw and committed into custody. On the 25th of November the preliminary charge was brought up, whereupon he was sent to the Tower, and, on the 31st of January 1641, the accusations in detail were presented. These were, in sum, that Strafford had endeavoured to subvert the fundamental laws of the kingdom, and that the attempt was high treason. Much stress was laid on Strafford's reported words, already cited—"You have an army in Ireland you may employ here to reduce this kingdom," England, it being contended, and not Scotland being here meant. It is clear nevertheless that however tyrannical and mischievous Strafford's conduct may have been, his offense was not one which could by any straining of language be included in the limits of high treason; while the copy of a copy of rough notes of Strafford's speech in the committee of the council, the genuineness of which was asserted only by the defendant's accusers or personal enemies and not supported by other councillors who had also been present on the occasion, could not be evidence which would convict in a court of law. In addition, the words had to be arbitrarily interpreted as referring to the subjection of England and not of Scotland, and were also spoken on a privileged occasion. Advantage was freely taken by Strafford of the weak points in the attack, and the lords, his judges, were considerably influenced in his favour. But behind the legal aspect of the case lay the great constitutional question of the responsibility to the nation of the leader of its administration, a principle which was now to be revived after many centuries of neglect, and, in the circumstances which then prevailed, could only be enforced by the destruction of the offender. The Commons therefore, feeling their victim slipping from their grasp, dropped the impeachment, and brought in and passed a bill of attainder, though owing to the opposition of the Lords, and Pym's own preference for the more judicial method, the procedure of an impeachment was practically adhered to. Strafford might still have been saved but for the king's ill-advised conduct. A scheme to gain over the leaders of the parliament, and a scheme to seize the Tower and to liberate Strafford by force, were entertained concurrently and were mutually destructive; and the revelation of the army plot on the 5th of May caused the Lords to pass the attainder. Nothing now remained but the king's signature. Charles had, after the passing of the attainder by the Commons, for the second time assured Strafford "upon the word of a king, you shall not suffer in life, honour or fortune." Strafford now wrote releasing the king from his engagements and declaring his willingness to die in order to reconcile Charles to his subjects. "I do most humbly beseech you, for the preventing of such massacres as may happen by your refusal, to pass the bill; by this means to remove . . . the unfortunate thing forth of the way towards that blessed agreement, which God, I trust, shall for ever establish between you and your subjects."

Finally Charles yielded, giving his fatal assent on the 10th of May. Strafford met his fate on the 12th of May on Tower Hill, receiving Laud's blessing, who was then also imprisoned in the Tower, on his way to execution.

Thus passed into history "the great person," as Clarendon well calls him, without doubt one of the most striking figures in the annals of England. Strafford's patriotism and ideas were fully as noble as those of his antagonists. Like Pym, a student of Bacon's wisdom, he believed in the progress of England along the lines of natural development, but that development, in opposition to Pym, he was convinced could only proceed with the increase of the power of the executive, not of the parliament, with a government controlled by the king and not by the people. He was equally an upholder of the union of interests and affection between the sovereign and his subjects, but believed this could only exist when the king's will, and not that of the parliament, was paramount. The development of the constitution, in his opinion, either in the direction of a democracy or an aristocracy, was equally fatal and could only lead to anarchy, to the waste of national resources and to degeneration. With a strong and untrammelled executive directed by a single will, wise reforms could be carried out, the weak defended against the strong, the resources of the country developed to their full extent, the hesitations, delays and contradictions caused by barren discussions avoided, and the national forces concentrated on objects worth the aim. For one brief moment it was given to Strafford to carry out his ideals, and the final failure of his Irish administration, and especially its inability to endure in spite of its undoubted successes, has afforded an object-lesson in one-man government for all time. If such was the event in Ireland, where political ideas were still rude and elementary, still less could success be expected from the attempt to introduce the centralization and absolute power of the executive into England, where principles of government had been highly developed both in theory and practice, and a contrary tendency had long been established towards the increase of the rights of the individual and the power of parliament.

While arousing in the course of his career the most bitter enmities—and no man's death was ever received with more public rejoicing—Strafford was capable of inspiring strong friendships in private life. Sir Thomas Roe speaks of him as "Severe abroad and in business, and sweet in private conversation; retired in his friendships but very firm; a terrible judge and a strong enemy." His appearance is described by Sir Philip Warwick: "In his person he was of a tall stature, but stooped much in the neck. His countenance was cloudy whilst he moved or sat thinking, but when he spake, either seriously or facetiously, he had a lightsome and a very pleasant air; and indeed whatever he then did he performed very gracefully." He himself jested on his own "bent and ill-favoured brow," Lord Exeter replying that had he been "cursed with a meek brow and an arch of white hair upon it," he would never "have governed Ireland nor Yorkshire."

Strafford was married three times: (1) in 1611 to Lady Margaret Clifford, daughter of Francis, 4th earl of Cumberland; (2) in 1625 to Lady Arabella Holles, daughter of John, 1st earl of Clare; (3) in 1632 to Elizabeth, daughter of Sir Godfrey Rhodes. He left three daughters and one son, William, 2nd earl of Strafford.

See the article on Strafford in the *Dict. Nat. Biog.* by S. R. Gardiner; Strafford's *Letters*, ed. by W. Knowler (1739); R. Browning's

Life of Strafford, with introduction by C. H. Firth (1892); *Papers relating to Thos. Wentworth*, ed. by C. H. Firth for the Camden Society (1890), *Camden Miscellany*, vol. ix.; *Private Letters from the Earl of Strafford to his third Wife* (Philobiblon Soc. Biog. & Hist. Misc. 1854, vol. i.); Lives by H. D. Traill (1889) in "English Men of Action Series," and by Elizabeth Cooper (1886); *Cat. of State Papers, Domestic and Irish*, esp. 1633-1647 *Introduction*; *Hist. MSS. Comm. MSS. of Earl Cowper*; *Strafford's Correspondence*, of which the volumes published by Knowler represent probably only a small selection, remains still in MS. in the collection of Earl Fitzwilliam at Wentworth Woodhouse. (P. C. Y.)

STRAIN (through O. Fr. *straindre*, *estraindre*, mod. *étraindre*, from Lat. *stringere*, to draw tight, related to stress, stretch, string, &c.), to draw out, extend, stretch, especially with the idea of great effort or beyond measure or limit; hence, from the idea of pressure or constriction, to separate coarser matter or light solids from a liquid by pressure through a "strainer," which may be either a sieve or a colander (Lat. *colare*, to strain), a metal vessel with perforations in the bottom. Another type is the filter (*q.v.*). Straining can also be effected by means of cloths, and the name strainer is used of a coarse open cloth usually of flax; a coarser cloth of a more open texture is technically known as "screw."

For "strains" and "stresses" in physics see MECHANICS; ELASTICITY and STRENGTH of MATERIALS.

STRAITS SETTLEMENTS, the collective name given to the crown colony formed by the British possessions on or adjacent to the mainland of the Malay Peninsula, as opposed to the Federated Malay States, the British protectorates in the same region. The Straits Settlements consist of the island of Singapore with about a score of islets of insignificant size lying in its immediate vicinity, of the town and territory of Malacca, the islands and territory of the Dindings, the island of Penang, sometimes officially called Prince of Wales Island, and Province Wellesley.

The colony of the Straits Settlements is administered by the governor with the aid of an executive council, composed wholly of official members, and there is a legislative council, composed partly of official and partly of nominated members, of which the former have a narrow permanent majority. The governor of the Straits Settlements is also high commissioner for the Federated Malay States of the peninsula, for British North Borneo, Brunei and Sarawak in Borneo, and since the administration of the colony of Labuan, which for a period was vested in the British North Borneo Company, has been resumed by the British government he is also governor of Labuan. The Cocos Keeling Islands (which were settled and are still owned by a Scottish family named Ross) and Christmas Island were formerly attached to Ceylon, but in 1886 the care of these islands was transferred to the government of the Straits Settlements. Penang and Malacca are administered, under the governor, by resident councillors. British residents control the native states of Pērak, Selāngor, Nēgri Sembilan and Pahang, but since the 1st of July 1896, when the federation of these states was effected, a resident-general, responsible to the high commissioner, has been placed in supreme charge of all the protectorates in the peninsula. The work of administration, both in the colony and in the Federated Malay States, is carried on by means of a civil service whose members are recruited by competitive examination held annually in London.

Population.—The following are the area and population, with details of race distribution, of the colony of the Straits Settlements, the figures being those of the census of 1901:—

	Area in Square Miles.	Population in 1891.	Population in 1901.						
			Total.	Euro-peans.	Eura-sians.	Chinese.	Malays.	Indians.	Other Nationalities.
Singapore	206	184,554	228,555	3824	4120	164,041	36,080	17,823	2667
Penang, Province Wellesley and Dindings. }	381	235,618	248,207	1160	1945	98,424	106,000	38,051	2627
Malacca	659	92,170	95,487	74	1598	19,468	72,978	1,276	93
Total	1246	512,342	572,249	5058	7663	281,933	215,058	57,150	5387

The population, which was 306,775 in 1871 and 423,384 in 1881, had in 1901 reached a total of 572,249. As in former years, the increase is solely due to immigration, more especially of Chinese, though a considerable number of Tamils and other natives of India annually settle in the Straits Settlements. The total number of births registered in the colony during the year 1900 was 14,814, and the ratio per 1000 of the population during 1896, 1897 and 1898 respectively was 22.18, 20.82 and 21.57; while the number of registered deaths for the years 1896-1900 gave a ratio per 1000 of 42.21, 36.90, 30.43, 31.66 and 36.25 respectively, the number of deaths registered during 1900 being 23,385. The cause to which the excess of deaths over births is to be attributed is to be found in the fact that the Chinese and Indian population, which numbers 339,083, or over 59% of the whole, is composed of 261,412 males and only 77,671 females, and a comparatively small number of the latter are married women and mothers of families. The male Europeans also outnumber the females by about two to one; and among the Malays and Eurasians, who alone have a fair proportion of both sexes, the infant mortality is always excessive, this being due to early marriages and other well-known causes. The number of immigrants landing in the various settlements during 1906 was: Singapore 176,587 Chinese; Penang 56,333 Chinese and 52,041 natives of India; and Malacca 598 Chinese. The total number of immigrants for 1906 was therefore 285,560, as against 39,136 emigrants, mostly Chinese returning to China. In 1867, the date of the transfer of the colony from the East India Company to the Crown, the total population was estimated at 283,384.

Finance.—The revenue of the colony in 1868 only amounted to \$1,301,843. That for 1906 was \$9,512,132, exclusive of \$106,180 received on account of land sales. Of this sum \$6,650,558 was derived from import duties on opium, wines and spirits, and licences to deal in these articles, \$377,972 from land revenue, \$592,962 from postal and telegraphic revenue, and \$276,019 from port and harbour dues. The expenditure, which in 1868 amounted to \$1,197,177, had risen in 1906 to \$8,747,819. The total cost of the administrative establishments amounted to \$4,450,791, of which \$2,586,195 was on account of personal emoluments and \$1,864,596 was on account of other charges. The military expenditure (the colony pays on this account 20% of its gross revenue to the Imperial government by way of military contribution) amounted in 1906 to \$1,762,438. A sum of \$578,025 was expended on upkeep and maintenance of existing public works, and \$1,209,291 on new roads, streets, bridges and buildings.

The Dindings and Province Wellesley.—The various settlements of which the colony of the Straits Settlements is composed, and the protectorates named in this article, are all dealt with separately, except the Dindings and Province Wellesley. The former, which consists of some islands near the mouth of the Pērak River and a small piece of territory on the adjoining mainland, belonged originally to Pērak, and was ceded to the British government under the treaty of Pangkor in 1874. Hopes were entertained that its excellent natural harbour would prove to be valuable, but these have been doomed to disappointment, and the islands, which are sparsely inhabited and altogether unimportant both politically and financially, are now administered by the government of Pērak.

Province Wellesley, which is situated on the mainland opposite to the island of Penang, was ceded to Great Britain by the sultan of Kedah in 1798. It marches with Pērak on the south, but on the north and east with Kedah. The boundary with Kedah was rectified by treaty with Siam in 1867. It is administered by a district officer, with some assistants, who is responsible to the resident councillor of Penang. The country consists, for the most part, of fertile plain, thickly populated by Malays, and occupied in some parts by sugar-planters and others engaged in similar agricultural industries and employing Chinese and Tamil labour. About a tenth of the whole area is covered by low hills with thick jungle. Large quantities of rice are grown by the Malay inhabitants, and between October and February there is excellent snipe-shooting to be had in the paddy-fields. A railway from Bātu Kāwan, opposite to Penang, runs through Province Wellesley into Pērak, and thence via Selāngor and the Negri Sembilan to Malacca. There is also an extension via Mūar, which is under the rule of the sultan of Johor, and through the last-named state to Johor Bharu, opposite the island of Singapore.

See *Straits Settlements Blue Book, 1906* (Singapore, 1907); *Straits Directory, 1908* (Singapore, 1908); *Journal of the Straits branch of the Royal Asiatic Society* (Singapore); Sir Frederick Weld and Sir William Maxwell, severally, on the Straits Settlements in the *Journal of the Royal Colonial Institute* (London, 1884 and 1892);

Henry Norman, *The Far East* (London, 1894); Alleyne Ireland, *The Far Eastern Tropics* (London, 1904); Sir Frank Swettenham, *British Malaya* (London, 1906); *The Life of Sir Stamford Raffles* (London, 1856, 1898). (H. C.L.)

STRALSUND, a seaport of Germany, in the Prussian province of Pomerania, on the west side of the Strelasund, an arm of the Baltic, $1\frac{1}{2}$ m. wide, which separates the island of Rügen from the mainland, 135 m. by rail N. from Berlin and 45 m. N.W. of Rostock. Pop. (1905), 31,813, of whom more than a fourth reside in the Knieper, Tribseeser, Franken and other suburbs on the mainland. A steam railway ferry connects it with the island railway on Rügen, and so with Sassnitz, whence a regular steamboat mail service affords communication with Trelleborg in Sweden. The situation of the town proper, on a small triangular islet only connected with the mainland by three moles and bridges at the angles, has always rendered its fortification comparatively easy, and down to 1873 it was a fortress of the first rank. Since that year the ramparts have been levelled and their site occupied by public promenades and gardens. The defences of the place are now solely confined to the island of Dänholm, known down to the 13th century as Strehla or Strehlo, lying in the Sound. The quaint architecture of the houses, many of which present their curious and handsome gables to the street, gives Stralsund an interesting and old-fashioned appearance. The four Gothic churches of St Nicholas,¹ St Mary, with a lofty steeple, St James and The Holy Ghost, and the fine medieval town hall, dating in its oldest part from 1306 and restored in 1882, are among the more striking buildings. The last houses the provincial antiquarian museum and the municipal library of 70,000 volumes. There is a fine monument commemorating the war of 1870-71, one (1859) to the local patriot Ferdinand von Schill, and another (1900) to the poet and patriot E. M. Arndt. Among the educational establishments of the place must be mentioned the classical school (Gymnasium), founded in 1560, and a school of navigation. The manufactures of Stralsund are more miscellaneous than extensive; they include machinery, playing cards, sugar, soap, cigars, gloves, furniture, paper, oil and beer. The trade is chiefly confined to the shipping of grain, fish, coal, malt and timber, with some cattle and wool, and to the import of coal and tar, but of late years it has declined, despite excellent wharf accommodation and a considerable depth of water (12-15 ft.). Stralsund entertains passenger-boat communications with Barth, Stettin, Rostock and Lübeck as well as with various small ports on the isle of Rügen.

Stralsund was founded in 1234, and, though several times destroyed, steadily prospered. It was one of the five Wendish towns whose alliance extorted from King Eric of Norway a favourable commercial treaty in 1284-1285; and in the 14th century it was second only to Lübeck in the Hanseatic League. Although under the sway of the dukes of Pomerania, the city was able to maintain a marked degree of independence, which is still apparent in its municipal privileges. Its early Protestant sympathies placed it on the side of Sweden during the Thirty Years' War, and in 1628 it successfully resisted a siege of eleven weeks by Wallenstein, who had sworn to take it "though it were chained to heaven." He was forced to retire with the loss of 12,000 men, and a yearly festival in the town still celebrates the occasion. After the peace of Westphalia Stralsund was ceded with the rest of Western Pomerania to Sweden; and for more than a century and a half it was exposed to attack and capture as the *tête-de-pont* of the Swedes in continental Europe. It was taken by France in 1807, and in 1815 it passed to Prussia. In 1809 it was the scene of the death of Ferdinand von Schill, in his gallant though ineffectual attempt to rouse his countrymen against the French invaders.

See Mohnike and Zober, *Stralsundische Chroniken* (Stralsund, 1833-1834); Israel, *Die Stadt Stralsund* (Leipzig, 1893); Baier, *Stralsundische Geschichten* (Stralsund, 1902); and T. Reishaus, *Wallenstein und die Belagerung Stralsunds* (Stralsund, 1887).

¹A remarkable series of 14th-century frescoes, in perfect condition, were disclosed in 1909 by the removal of the whitewash which had for centuries covered the interior of this fine church.

STRAMONIUM, in medicine, a drug obtained from the leaves and seeds of the *Datura stramonium*. Both contain an alkaloid known as daturine. From the seeds is made *extractum stramonii*. The *linctura stramonii* is made from the leaves. The physiological action of stramonium resembles that of belladonna, except that stramonium relaxes to a greater extent the unstriated muscle of the bronchial tubes; for this reason it is used in asthma to relieve the bronchial spasm. Cigarettes made of stramonium leaves may be smoked or the tincture may be taken internally. Frequently the leaves powdered together with equal quantities of the powdered leaves of the *Cannabis Indica* and lobelia mixed with potassium nitrate are burned in an open dish. The preparation gives off dense fumes which afford great relief to the asthmatic paroxysm. Numerous patent "cures" for asthma contain these ingredients in varying proportions. Daturine is used as *daturinae sulphas*. In acute mania it acts like hyoscyamine in producing sleep. In large doses stramonium is a narcotic poison producing the well-marked stages of exaltation of function, diminution of functional activity, and later loss of function, sinking into coma and paralysis.

STRANG, WILLIAM (1859—), English painter and engraver, was born at Dumbarton, N.B., on the 13th of February 1859, the son of Peter Strang, builder. He was educated at the Dumbarton Academy, and worked for fifteen months in the counting-house of a firm of shipbuilders. He went to London in 1875 when he was sixteen, and studied his art under Alphonse Legros at the Slade School for six years. Strang became assistant master in the etching class, and himself followed this art with great success. He was one of the original members of the Royal Society of Painter-Etchers, and exhibited at their first exhibition in 1881. Some of his early plates were published in the *Portfolio* and other art magazines. He worked in many manners, etching, dry point, mezzotint, sand-ground mezzotint, and burin engraving, and invented a draw-burin of his own. Lithography and wood-cutting were also used by him to reproduce his abundant imaginings. He cut a large wood-engraving of a man ploughing, that has been published by the Art for Schools Association. A privately produced catalogue of his engraved work contains more than three hundred items. Amongst his earlier works "Tinkers," "St Jerome," "A Woman washing her Feet," an "Old Book-stall with a man lighting his pipe from a flare," and "The head of a Peasant Woman," on a sand-ground mezzotint, may be remembered. Later plates such as "Hunger," "The Bachelor's End" and "The Salvation Army" cannot be forgotten. Some of his best etchings have been in series; one of the earliest, illustrating William Nicholson's ballad of "Aken Drum," is remarkable for delicate and clear workmanship in the shadow tones, showing great skill and power over his materials, and for strong drawing. Another good series was the "Pilgrim's Progress," revealing austere sympathy with Bunyan's teaching. Coleridge's "Ancient Mariner" and Strang's own "Allegory of Death" and the "Plowman's Wife," have served him with suitable imaginative subjects. Some of Rudyard Kipling's stories have been illustrated by him, too, and Strang's portrait of Kipling has been one of his most successful portrait plates. Other good etched portraits are of Mr Ernest Sichel, fine as a Vandyck, and of Mr J. B. Clark, with whom Strang collaborated in illustrating *Baron Munchausen* and *Sinbad the Sailor* and *Ali Baba*, published in 1895 and 1896. Thomas Hardy, Henry Newbolt and many other distinguished men also sat to him. Proofs from these plates have been much valued; in fact, Strang's portrait etchings have inaugurated a new form of reproductive portraiture. A portrait which is a work of art and can be reproduced a number of times without losing any of its art qualities is one ideal way of recording appearances, as such prints can be treasured by many owners. Strang produced a number of good paintings, portraits, nude figures in landscapes, and groups of peasant families, which have been exhibited in the Royal Academy, the International Society, and several German exhibitions. He painted a decorative series

of scenes from the story of Adam and Eve for the library of Mr Hodson of Wolverhampton; they were exhibited at the Whitechapel exhibition in 1910. Some of his drawings from the nude model in silver point and red and black chalk are very beautiful as well as powerful and true. He also painted a number of landscapes, mostly of a small size. In later years he developed a style of drawing in red and black chalk, with the whites and high lights rubbed out, on paper stained with water colour. This method gives qualities of delicate modelling and refined form and gradations akin to the drawings of Holbein. He drew portraits in this manner of many members of the Order of Merit for the royal library at Windsor Castle. In 1902 Strang retired from the Royal Society of Painter-Etchers, as a protest against the inclusion in its exhibitions of etched or engraved reproductions of pictures. His work was subsequently seen principally in the exhibitions of the Society of Twelve, of the International Society, to which body he was elected in 1905, and of the Royal Academy. Strang was elected an associate engraver of the Royal Academy when that degree was wisely revived in 1906. (C. H.*)

STRANGE, SIR ROBERT (1721-1792), Scottish line engraver, descended from the Scottish family of Strange, or Strang, of Balcasky, Fife, was born in the mainland of Orkney, on the 14th of July 1721. In his youth he spent some time in an attorney's office; but, having manifested a taste for drawing, he was apprenticed, in 1735, to Richard Cooper, an engraver in Edinburgh. After leaving Cooper in 1741 he started on his own account as an engraver, and had attained a fair position when, in 1745, he joined the Jacobite army as a member of the corps of life-guards. He engraved a half-length of the Young Pretender, and also etched plates for a bank-note designed for the payment of the troops. He was present at the battle of Culloden, and after the defeat remained in hiding in the Highlands, but ultimately returned to Edinburgh, where, in 1747, he married Isabella, only daughter of William Lumisden, son of a bishop of Edinburgh. In the following year he proceeded to Rouen, and there studied drawing under J. B. Descamps, carrying off the first prize in the Academy of Design. In 1749 he removed to Paris, and placed himself under the celebrated Le Bas. It was from this master that he learned the use of the dry point, an instrument which he greatly improved and employed with excellent effect in his own engravings. In 1750 Strange returned to England. Presently he settled in London along with his wife and daughter, and superintended the illustrations of Dr William Hunter's great work on the *Gravid Uterus*, published in 1774. The plates were engraved from red chalk drawings by Van Rymdsdyk, now preserved in the Hunterian Museum, Glasgow, and two of them were executed with great skill by Strange's own hand. By his plates of the "Magdalen" and "Cleopatra," engraved after Guido in 1753, he at once established his professional reputation. He was invited in 1759 to engrave the portraits of the prince of Wales and Lord Bute, by Allen Ramsay, but declined, on the ground of the insufficient remuneration offered and of the pressure of more congenial work after the productions of the Italian masters. His refusal was attributed to his Jacobite proclivities, and it led to an acrimonious correspondence with Ramsay, and to the loss, for the time, of royal patronage. In 1760 Strange started on a long-meditated tour in Italy. He studied in Florence, Naples, Parma, Bologna, and Rome, executing innumerable drawings, of which many—the "Day" of Correggio, the "Danae" and the "Venus and Adonis" of Titian, the "St Cecilia" of Raphael, and the Barberini "Magdalen" of Guido, &c.—were afterwards reproduced by his burin. On the Continent he was received with great distinction, and he was elected a member of the academies of Rome, Florence, Parma and Paris. He left Italy in 1764, and, having engraved in the French capital the "Justice" and the "Meekness" of Raphael, from the Vatican, he carried them with him to London in the following year. The rest of his life was spent mainly in these two cities, in the diligent prosecution of his art. In 1766 he was elected a member of the Incorporated Society of Artists, and in 1775, piqued by

the exclusion of engravers from the Royal Academy, he published an attack on that body, entitled *An Enquiry into the Rise and Progress of the Royal Academy of Arts at London*, and prefaced by a long letter to Lord Bute. In 1787 he engraved West's "Apotheosis of the Princes Octavius and Alfred," and was rewarded with the honour of knighthood. He died in London on the 5th of July 1792.

After his death a splendid edition of reserved proofs of his engravings was issued; and a catalogue of his works, by Charles Blanc, was published in 1848 by Rudolph Weigel of Leipzig, forming part of *Le Graveur en taille douce*.

See *Memoirs of Sir Robert Strange, Knt., and his Brother-in-law Andrew Lumisden*, by James Dennistoun of Dennistoun (1855).

STRANGFORD, VISCOUNT, an Irish title held by the family of Smythe, from 1625, when it was conferred upon Sir Thomas Smythe (d. 1635) of Ostenhanger and Ashford, Kent, until 1869, when it became extinct. From Sir Thomas the title passed down to his descendant, Percy Clinton Sydney Smythe (1780-1855), who succeeded his father, Lionel, as 6th viscount in 1801. Entering the diplomatic service in 1802, Smythe represented his country at Lisbon, in Brazil, at Stockholm, Constantinople and St Petersburg, and in 1825 he was created a peer of the United Kingdom as Baron Peshurst. He had literary tastes, and in 1803 published *Poems from the Portuguese of Camoëns, with Remarks and Notes*, Byron at this time describing him as "Hibernian Strangford"; he died on the 29th of May 1855.

His eldest son George Augustus Frederick Percy Sydney Smythe (1818-1857), who now became the 7th viscount, was associated with Disraeli and Lord John Manners in the conduct of the "Young England" party. He entered parliament in 1841, and was under-secretary for foreign affairs in 1845-1846, losing his seat at Canterbury in 1852. In 1852 he fought a duel at Weybridge with Colonel Frederick Romilly (1810-1887), the last encounter of this kind in England. Like his father, Smythe had literary tastes, and he is thought to be the original of Disraeli's *Coningsby*. In 1844 he wrote *Historic Fancies*, a collection of poems and essays, and his novel *Angelo Pisani* was published posthumously, with a memoir of the author in 1875. As a journalist he wrote in the *Morning Chronicle*. He died on the 23rd of November 1857, and was succeeded by his brother Percy Ellen Frederick William Sydney Smythe (1826-1869) as 8th viscount.

Born at St Petersburg on the 26th of November 1826, during all his earlier years Percy Smythe was nearly blind, in consequence, it was believed, of his mother having suffered very great hardships on a journey up the Baltic in wintry weather shortly before his birth. His health through life was very delicate, but did not prevent his showing quite early most remarkable powers of mind. His education was begun at Harrow, whence he went to Merton College, Oxford. From the very first he gave proofs of extraordinary ability as a linguist, and was nominated by the vice-chancellor of Oxford in 1845 a student-attaché at Constantinople. A very interesting account of his colleagues, more especially of Mr Almerick Wood, who was a man of phenomenal capacity, was written by him later in life, and is to be found in the two volumes of his collected essays published by his widow. While at Constantinople, where he served under Lord Stratford de Redcliffe, Percy Smythe gained a mastery not only of Turkish and its dialects, but of almost every form of modern Greek, from the language of the *litterati* of Athens to the least Hellenized Romaic. Before he went to the East he had a large knowledge both of Persian and Arabic, but until his duties led him to study the past, present and future of the sultan's empire he had given no attention to the tongues which he well described as those of the international rabble in and around the Balkan peninsula. He made, while in the East, a careful study of these, and was the first Englishman to see that the Bulgarians were much more likely than the Servians to come to the front as the Ottoman power declined. He avowed himself a Liberal in English politics, and those with whom he chiefly lived were Liberals; but he was not an anti-Turk, as so many Liberals afterwards became. On

succeeding to the peerage in 1857 he did not abandon the East, but lived on at Constantinople for several years, immersed in Oriental studies. At length, however, he returned to England and began to write a great deal, sometimes in the *Saturday Review*, sometimes in the *Quarterly*, and much in the *Pall Mall Gazette*. A rather severe review in the first of these organs of the *Egyptian Sepulchres and Syrian Shrines* of Emily Anne Beaufort (d. 1887) led to a result not very usual—the marriage of the reviewer and of the authoress. One of the most interesting papers Lord Strangford ever wrote was the last chapter in his wife's book on the *Eastern Shores of the Adriatic*. That chapter was entitled "Chaos," and was the first of his writings which made him widely known amongst students of foreign politics. From that time forward everything that he wrote was watched with intense interest, and even when it was anonymous there was not the slightest difficulty in recognizing his style, for it was unlike any other. He died in London on the 9th of January 1869, when his titles became extinct. A *Selection from the Writings of Viscount Strangford on Political, Geographical and Social Subjects* was edited by his widow and published in 1869. His *Original Letters and Papers upon Philology and Kindred Subjects* were also edited by Lady Strangford (1878).

See E. B. de Fonblanque, *Lives of the Lords Strangford through Ten Generations* (1877).

STRANRAER, a royal and police burgh and seaport of Wigtownshire, Scotland. Pop. (1901), 6036. It is situated at the head of Loch Ryan, an arm of the North Channel (Irish Sea), 59 m. S.S.W. of Ayr by the Glasgow & South-Western railway, with a station in the town and at the harbour. It lies 39 m. E. by N. of Larne in Co. Antrim, Ireland, with which there is daily communication by mail steamer. Stranraer, originally called St John's Chapel, became a burgh of barony in 1596, and a royal burgh in 1617. In the centre of the town are the ruins of the castle of the 15th century, occupied for a time by John Graham of Claverhouse, Viscount Dundee, when he held the office of sheriff of Galloway (1682). The principal buildings within the parish are the old town hall, now used as a volunteer drill hall and armoury; the county buildings, containing the town hall and court house; the academy; reformatory and the Wigtownshire combination poor-house. Dairy utensils and implements are made; there are several nurseries; brewing and milling are carried on, but the bulk of the trade is in farm and dairy produce. Pier and harbour accommodation has been extended and the shipping is brisk. The oyster beds, for which Loch Ryan was once noted, are not cultivated, but the fisheries (white fish and herrings) are still of some consequence. Three miles east of Stranraer is Lochinch, the residence of the earl of Stair, a modern structure in the Scots Baronial style. It stands in grounds 4000 acres in extent, which include the White and Black Lochs and the ruins of Castle Kennedy, finely situated on the isthmus between the lakes. This castle was erected in the reign of James VI. for the earls of Cassilis, and passed into the hands of the Stair family in the 17th century. It was struck by lightning in 1716 and burned down and never rebuilt. The estate is famous for its plantations and Dutch gardens, the pinetum containing the most representative collection of araucarias, deodars and other conifers in Europe. A mile south are the green mounds marking the site of the abbey of Sausseat, founded for Premonstratensian monks by Fergus, "king" of Galloway, early in the 12th century. It stood on the banks of a small loch and was known as the Monastery of the Green Lake from the mass of confervae with which the water was continually covered. Four miles west by north of Stranraer is situated Lochnaw Castle, the ancient seat of the Agnews, who were hereditary sheriffs of Galloway till 1747, when hereditary jurisdictions were abolished. The five-storied embattled tower in the centre dates from 1426, and the modern mansions from 1820. On the coast, 7½ m. south-west of Stranraer by rail, lies Portpatrick, formerly called Port Montgomerie. Owing to its proximity to Ireland (21½ m. to Donaghadee), it was for more than 200 years a starting-point

of the mail service between Great Britain and Ireland. In consequence, however, of the frequent violence of the south-westerly gales and other causes, the communication ceased in the middle of the 19th century, and the artificial harbour designed by John Rennie has gradually fallen into decay. The town is in repute as a holiday resort for its healthy climate and beautiful situation.

STRASSBURG, or STRASBURG (French *Strasbourg*), a town of Germany, the capital of the imperial province of Alsace-Lorraine and a fortress of the first rank, is situated in a fertile plain at the junction of the Ill and the Breusch, 2 m. W. of the Rhine, 88 m. by rail N. from Basel, 370 m. S.W. from Berlin, 30 m. E. of the French frontier. Pop. (1890), 123,500; (1900), 150,268; (1905), 167,342. Since 1871 it has been the seat of government for the German territory of Alsace-Lorraine, and it is also the see of a Roman Catholic bishop and the headquarters of the XV. Corps of the German army. It is surrounded by outlying fortifications and strategic works and contains a garrison of 16,000 men of all arms.

The town proper is divided by the arms of the Ill into three parts, of which the central is the largest and most important. Most of the streets in the heart of the city are narrow and irregular, and the quaint aspect of a free medieval town has to a considerable extent been maintained. The quarters which suffered most in the bombardment of 1870 have, however, been rebuilt in more modern fashion, and the recent widening of the circle of fortifications, with the destruction of the old walls, has given the city opportunity of expansion in all directions; thus, with the exception of Berlin and Leipzig, there is perhaps no town in Germany which can show so many handsome new public buildings as Strassburg. Of its older edifices by far the most interesting and prominent is the cathedral, or Münster, which in its present form represents the activity of four centuries. Part of the crypt dates from 1015; the apse shows the transition from the Romanesque to the Gothic style; and the nave, finished in 1275, is a fine specimen of pure Gothic. Of the elaborate west façade, with its screen of double tracery and its numerous sculptures, the original design was finished by Erwin von Steinbach (d. 1318). The upper part of the façade and the towers were afterwards completed in accordance with a different plan, and the spire on the north tower was added in 1435. This tower is 465 ft. high, being thus one of the highest buildings in Europe, and it commands a fine view. The cathedral has some fine stained glass, a sculptured pulpit and the famous astronomical clock in the south transept; this contains some fragments of the clock built by the mathematician, Conrad Dasypodius, in 1574. The Protestant church of St Thomas, a Gothic building of the 13th and 14th centuries, contains a fine monument of Marshal Saxe, considered the *chef d'œuvre* of the sculptor, Jean Baptiste Pigalle. Other notable churches are the Protestant Temple Neuf, or Neue Kirche, rebuilt since 1870, and the Roman Catholic church of the Sacred Heart, erected in 1889-1893.

The old episcopal palace, built in 1731-1741, was used for university purposes from 1872 to 1895; it is now the municipal museum of art. Other notable buildings are the Frauenhaus, with some interesting sculptures, and the Hôtel du Commerce, the finest Renaissance building in the town. The imperial palace, designed by H. Eggert in the Florentine Renaissance style, was built in 1889-1893; it is crowned by a cupola 115 ft. high and is richly ornamented. The provincial and university library, with over 800,000 volumes, and the hall of the provincial Diet (*Landesausschuss*), built in 1888-1892, both in the Italian Renaissance style, occupy the opposite side of the Kaiserplatz, and behind the latter is the large new post office. Between the university and the library is the Evangelical garrison church (1892-1897), built of reddish sandstone in the early Gothic style. The principal squares of the town are the Kaiserplatz, the Broglieplatz, the Schlossplatz and the Kleberplatz. Still to be mentioned are the Grosse Metzger, containing the Hohenlohe museum, the theatre, the town hall, and the so-called Aubette, with the conservatorium of music. A new synagogue was

completed in 1898, and the viceregal palace was entirely rebuilt in 1872-1874. The town has new law courts, a Roman Catholic garrison church, an iron bridge across the Rhine to Kehl and statues of General Kleber and of the printer Gutenberg.

The university of Strassburg, founded in 1567 and suppressed during the French Revolution as a stronghold of German sentiment, was reopened in 1872; it now occupies a site in the new town and is housed in a handsome building erected for it in 1877-1894. This is adorned with statues and frescoes by modern German artists, and has near it the chemical, physical, botanical, geological, seismological and zoological institutes, also the observatory, all designed by Eggert and built between 1877 and 1888. On the south of the old town are the various schools, laboratories and hospitals of the medical faculty, all built since 1877. The university, which has six faculties, is attended by about 1400 students and has 130 professors. Other educational establishments are the Protestant gymnasium, founded in 1538, various seminaries for teachers and theological students and numerous schools.

The chief industries of Strassburg are tanning, brewing, printing and the manufacture of steel goods, musical instruments, paper, soap, furniture, gloves and tobacco. To these must be added the fattening of geese for Strassburg's celebrated *pâtés de foie gras*, which forms a useful source of income to the poorer classes. There is also a brisk trade in agricultural produce, hams, sausages, coal, wine, leather goods and hops. The development of this trade is favoured by the canals which connect the Rhine with the Rhone and the Marne, and by a new port of 250 acres in extent with quays and wharves on the Rhine, which has been constructed since 1891.

Strassburg has always been a place of great strategical importance, and as such has been strongly fortified. The pentagonal citadel constructed by Vauban in 1682-1684 was destroyed during the siege of 1870. The modern German system of fortification consists of a girdle of fourteen detached forts, at a distance of from three to five miles from the centre of the town. Kehl, the *tête-de-pont* of Strassburg, and several villages are included within this enceinte, and three of the outworks lie on the right bank of the Rhine, in the territory of Baden. In case of need the garrison can lay a great part of the environs under water.

The site of Strassburg was originally occupied as a Celtic settlement, which was captured by the Romans, who replaced it by the fortified station of *Argentoratum*, afterwards the headquarters of the eighth legion. In the year 357 the emperor Julian saved the frontier of the Rhine by a decisive victory gained here over the Alamanni, but about fifty years later the whole of the district now called Alsace fell into the hands of that people. Towards the end of the 5th century the town passed to the Franks, who gave it its present name. The famous "Strassburg oaths" between Charles the Bold and Louis the German were taken here in 842, and in 923, through the homage paid by the duke of Lorraine to the German king Henry I., began the connexion of the town with the German kingdom which was to last for over seven centuries. The early history of Strassburg consists mainly of struggles between the bishop and the citizens, the latter as they grew in wealth and power feeling that the fetters of ecclesiastical rule were inconsistent with their full development. This conflict was finally decided in favour of the citizens by the battle of Oberhausbergen in 1262, and the position of a free imperial city which had been conferred upon Strassburg by the German king, Philip of Swabia, was not again disputed. This casting off of the episcopal yoke was followed in 1332 by an internal revolution, which admitted the guilds to a share in the government of the city and impressed upon it the democratic character which it bore down to the French Revolution. Strassburg soon became one of the most flourishing of the imperial towns, and the names of natives or residents like Sebastian Brant, Johann Tauler and Geiler von Kaisersberg show that its eminence was intellectual as well as material.

In 1349 two thousand Jews were burned at Strassburg on a charge of causing a pestilence by poisoning the wells. In 1381

the city joined the Städtebund, or league of Swabian towns, and about a century later it rendered efficient aid to the Swiss confederates at Granson and Nancy. The reformed doctrines were readily accepted in Strassburg about 1523, its foremost champion here being Martin Bucer, and the city was skilfully piloted through the ensuing period of religious dissensions by Jacob Sturm von Sturmeck, who secured for it very favourable terms at the end of the war of the league of Schmalkalden. In the Thirty Years' War Strassburg escaped without molestation by observing a prudent neutrality. In 1681, during a time of peace, it was suddenly seized by Louis XIV., and this unjustifiable action received formal recognition at the peace of Ryswick in 1697. The immediate effect of this change was a partial reaction in favour of Roman Catholicism, but the city remained essentially German until the French Revolution, when it was deprived of its privileges as a free town and sank to the level of a French provincial capital. In the war of 1870-71 Strassburg, with its garrison of 17,000 men, surrendered to the Germans on the 28th of September 1871 after a siege of seven weeks. The city and the cathedral suffered considerably from the bombardment, but all traces of the havoc have now disappeared. Before the war more than half of the inhabitants spoke German, and this proportion has increased greatly of recent years, owing to the large influx of pure German elements into the city and the almost complete reconciliation of the older inhabitants to the rule of Germany.

The bishopric of Strassburg existed in the days of the Merovingian kings, being probably founded in the 4th century, and embraced a large territory on both banks of the Rhine, which was afterwards diminished by the creation of the bishoprics of Spire and Basel. The bishopric was in the archdiocese of Mainz and the bishop was a prince of the empire. The episcopal lands were annexed by France in 1789 and the subsequent Roman Catholic bishops of Strassburg discharged spiritual duties only.

For the history of the bishopric see Grandidier, *Histoire de l'église et des évêques-princes de Strasbourg* (Strassburg, 1775-1778); Glöckler, *Geschichte des Bistums Strassburg* (Strassburg, 1879-1880); and J. Fritz, *Das Territorium des Bistums Strassburg* (Strassburg, 1885).

For the city see the *Strassburger Chroniken*, edited by Hegal (Leipzig, 1870-1871); the *Urkunden und Akten der Stadt Strassburg* (Strassburg, 1879 seq.); G. Schmoller, *Strassburgs Blüte im 13. Jahrhundert* (Strassburg, 1875); Schrickler, *Zur Geschichte der Universität Strassburg* (Strassburg, 1872); J. Kindler, *Das goldene Buch von Strassburg* (Vienna, 1885-1886); H. Ludwig, *Deutsche Kaiser und Könige in Strassburg* (Strassburg, 1889); A. Seyboth, *Strassburg historique* (Strassburg, 1894); and C. Stahling, *Histoire contemporaine de Strasbourg* (Nice, 1884 seq.).

STRATA-FLORIDA (*Ystradflur*), the ruins of a celebrated Cistercian abbey of Cardiganshire, Wales, situated amidst wild and beautiful scenery near the source of the river Teifi. The abbey is 2 m. distant from the village of Pontrhydfendigaid (bridge of the blessed ford) on the Teifi, and about 4 m. from the station of Strata-Florida on the so-called Manchester and Milford branch line of the Great Western railway. The existing remains are not extensive, but the dimensions of the church, 213 ft. long by 61 ft. broad, are easily traceable, and excavations made at different times during recent years have brought to light encaustic tiles and other objects of interest. The most prominent feature of the ruined abbey is the elaborate western portal of the church, which is regarded as a unique specimen of the transitional Norman-English architecture of the 12th century. A fine silver seal of the abbey is preserved in the British Museum.

Founded and generously endowed in 1164 by Rhys ap Griffith, prince of South Wales, the Cistercian abbey of St Mary at Strata-Florida (which was probably a revival of an older monastic house on or near the same site) continued for over a century to be reckoned one of the wealthiest and most influential of the Welsh religious houses. It was much favoured by Welsh bards, nobles and princes, several of whom were buried in the adjoining cemetery; and in its library were deposited many official documents and records of the native princes. In 1138 Llewelyn ap Iorwerth, "the Great," summoned all his vassals to this

spot to do homage to his heir, afterwards Prince David II. The abbey suffered severely during the Edwardian wars, and in or about 1294 a large portion of its buildings was destroyed by fire, though whether as the result of accident or design remains unknown; in any case Edward I. gave a donation of £75 towards the restoration of the fabric. During Owen Glendower's rebellion in Henry IV.'s reign, the abbey was held for some months by Harry of Monmouth (Henry V.) with a body of troopers. With the extinction of Welsh independence the abbey lost much of its wealth and influence, and at the dissolution of the monasteries its gross revenue was returned at only £122, 6s. 8d. a year, one Richard Talley being its last abbot. The fabric of the abbey and its surrounding lands came into the possession of the Stedman family, whose 17th-century mansion, built out of materials from the monastic buildings, has long been used as a farmhouse. By marriage the abbey and the estate of the Stedmans passed into the possession of the family of Powell of Nanteos.

STRATEGUS (*στρατηγός*), strictly the Greek word for a general, or officer in command of an army, but frequently the name of a state officer with much wider functions. Such an officer is found in many Greek states, the best known being the Athenian strategus, originally a military official, whose functions gradually developed until, in the latter half of the 5th century B.C., he became the most important magistrate in the state. According to Aristotle's *Constitution of Athens* iv., the office existed in the time of Draco and the qualification was property to the value of 100 minae (*i.e.* ten times as high as that for the archonship); but it is certain that until the end of the 6th century the archon (*q.v.*) was the most important state official. If, as is probable, the chapter in the *Constitution* is a forgery (see DRACO), we may conclude that the Strategia (board of ten generals) was a result of the tribal system of Cleisthenes, and that the college is to be ascribed to the year 501 B.C. Some maintain that Cleisthenes himself created it, but the evidence (*Ath. Pol.* xxii.) is against this. At all events, as late as the battle of Marathon the head of the army was the Polemarch (see ARCHON). It follows that the strategus was, until 487 B.C., subordinate to the Polemarch. The tribal unit was represented in the army by the *taxis*, and each *taxis* was led by a strategus. After the Persian Wars the command of the *taxis* passed to officers called taxiarchs, who acted as colonels under the strategi. If Herodotus may be trusted, the command of the army, at the time of the battle of Marathon, passed to the strategi in turn from day to day. No trace of this system, however, is to be found in the subsequent history. It was the customary practice in the 5th century to appoint a certain number of the generals, usually three or five, for a particular field of operations, and to assign the chief command to one of them. Exceptions to this rule are found in the well-known instances of the Sicilian expedition (when the three commanders, Nicias, Alcibiades and Lamachus were given co-ordinate powers), and of the battle of Arginusae, when the command was divided among the whole board. In crises such as the Samian revolt, the outbreak of the Peloponnesian War or that which led to the recall of Alcibiades, we find the whole board subordinated to a single member (*e.g.* Pericles or Alcibiades). Originally each strategus was elected by and out of the tribe he commanded (*Ath. Pol.* lxi.), and it may probably be inferred from Plutarch (*Cimon*, viii.) that this system prevailed as late as the archonship of Apsephion (469 B.C.). In the 4th century, however, the strategi were elected out of all the citizen body irrespective of tribes; the change must have occurred between 470 and 440 B.C., because in the latter year, and again in 433, one of Pericles' colleagues was Diotimus, a member of his own tribe (*cf.* Alcibiades and Adeimantus in 408 B.C.). But from Xenophon (*Memorab.* iii. 4) we learn that one strategus was still elected by each tribe, *i.e.* each strategus represented a tribe, though he might not be a member of it. Though the strategi were the nominal heads of the army, it is important to notice that they had no power to choose their taxiarchs, who, like the strategi, were elected by the tribes they were to command. It was only

as low as the *lochagi* (commanders of *λόχοι*, companies) that the Ecclesia allowed them to select. From the *Constitution* (lxi. 3), however, it appears that in the 4th century, at any rate, the *lochagi* were appointed by the taxiarchs, not the strategi. By a gradual process in the course of the 5th century, the regimental command was transferred to the taxiarchs, the strategi thus becoming general officers in command, while they at the same time acquired important political functions (see below). On the other hand the strategi commanded by both land and sea, and thus held the power divided at Sparta between the kings and the nauarchus (admiral).

In the course of the 5th century the powers of the strategia were increased by important political functions, especially in foreign affairs; hence the office, unlike that of the archon (*q.v.*), remained on in its original elective character and was held by the most important men (*e.g.* Pericles, Nicias, Alcibiades). Owing to the fact that the Boulē was the chief administrative body, it was necessary to bring the strategi into close connexion with it; it was, therefore, provided that they, though not members, should be allowed to attend its meetings and to bring motions before it. As the Boulē of one year rarely contained members of the previous Boulē, the strategi acquired great power from the fact that they were frequently re-elected for many years together, and so had greater experience and continuity of policy. Secondly, in the Ecclesia, the strategus had the advantage over the ordinary citizen that his business took precedence (the meetings always discussed first the question of national defence) and that he could in cases of emergency convene a special meeting (cf. Thuc. ii. 59 and iv. 118).

Many historians in dealing with the strategia have been misled by modern analogies. The strategia was, for example, by no means analogous to the British cabinet, which (1) has collective responsibility and (2) is executive in the sense that its members are heads of state departments. The strategi had no such characteristics; their influence over the Ecclesia in voting was merely that of a private citizen; there was no collective responsibility, no unanimous policy. Nor was the strategia a foreign office, though it clearly performed a ministerial act in attaching its signature to treaties. In general it had no powers of originating negotiation, but merely carried out the psephism of the Ecclesia. It was their relation to the empire which gave the strategi their authority. It was they who took the oath on behalf of Athens when an alliance was concluded, and their advice would have special weight in settling the terms of the treaty and the amount of tribute to be paid. They were not, indeed, compelled to submit a budget, nor did an adverse vote by the Ecclesia involve their resignation. On the authority of Plutarch it has been asserted that there was always a president of the strategic college, and this may well have been the case during the Persian Wars (Themistocles, 480; Aristides, 478). The three alleged occasions in the later years of the 5th century when a single strategus was in absolute authority (see above) were all critical occasions and in no way represent the normal condition of affairs. It is abundantly clear that Pericles owed his long ascendancy to his personal force, not to the constitutional authority of his office. Though at first the strategi acted as a single body, in the 4th century and later special duties were assigned to particular members of the board. Thus we hear of strategi *ἐπὶ τοὺς ὀπλίτας*, *ἐπὶ τὴν χώραν*, *ἐπὶ τὴν ἀκτὴν*, *ἐπὶ τὰς συμμορίας*, and inscriptions of the 3rd century refer to others. Under the Roman domination the strategus *ἐπὶ τὰ ὄπλα* was the chief state officer. The law of the emperor Hadrian regarding the export of oil to Athens speaks of him as managing the corn supply and presiding over the education of the Ephebi. In general, their duty was still mainly the foreign policy, offensive and defensive, of Athens; they nominated trierarchs, and, if any nominee refused to serve, brought him before the Heliaea to defend his case. They had powers of life and death over the army in the field—even a trierarch might be put in irons by a strategus. They presided over certain religious festivals and processions, and appear to have been responsible for the protection of the corn supply.

AUTHORITIES:—A. H. J. Greenidge *Handbook of Greek Constitutional History* (London, 1896), especially on the question of the presidency, p. 253; Gilbert, *Greek Constitutional antiquities* (Eng. trans., 1895); Hauvette-Besnault, *Les Stratèges athéniens* (Paris, 1885); Beloch, *D. att. Politik seit Perikles*, pp. 276, 277; Paulus, *Progr. v. Maulbronn* (1883, 34 seq.); Aristotle's *Constitution of Athens passim*, but especially iv., xxii., lxi.; the general histories of Greece—Busolt, Meyer, Bury, Grote (ed. 1907). (J. M. M.)

¹ All works written prior to 1891 must be read in the light of the *Constitution of Athens*.

STRATEGY, a term literally meaning "the art of the leader or general" (Gr. *στρατηγός*). In the strict sense the word "strategy" was originally introduced into European military literature about the opening of the 18th century, when the practice of warfare had settled down into an established routine, and the need of some term arose which should express that peculiar quality of a general's mind which rendered victory the almost certain consequence of his appearance in the field. As at that period only some small departure from established precedent—a trick or stratagem—could turn the scale between armies of about equal power, the idea of a ruse became connected with the word, and the essential quality in the general's personality which alone rendered ruses practicable, or guaranteed success in their execution, passed out of men's minds, until the gradual disappearance of these methods in the Napoleonic period focused attention again on its essential meaning, *i.e.* the art of the leader. Then the term "strategy" became limited as a technical term to the "practice of the art of war by an executive agent of a supreme government," or in Moltke's words, "the practical adaptation of the means placed at a general's disposal to the attainment of the object in view." This definition fixes the responsibility of a commander-in-chief to the government he serves. He cannot be held answerable for the "means," not even for the training of the "means" for a particular operation, unless he be appointed to his task in adequate time. He is charged with their employment within the limits of the theatre of operations assigned to him. If he considers the means placed at his disposal inadequate he need not accept the position offered him, but he steps beyond his province as a strategist if he attempts to dictate to the government what, in the widest sense, the means supplied to him should be.

Since, however, the "means," *i.e.* the conditions of the problems presented by war, are subject to infinite variation (climate, topography, equipment, arms and men, all being liable to collective or independent change) it is clear that their employment can never be reduced to a "science" but must retain to the full the characteristics of an "art." This distinction is essential, and must be borne in mind, for no soldier can expect to become a Napoleon merely by the study of that great strategist's campaigns. But if he lack practice and experience, and above all genius, the man who neglects such teachings as the contemplation of the works of his predecessors can supply does so at his own peril; and when, as in the case of the soldier, the whole destiny of an empire may depend on his action, he must be bold indeed who would neglect all possible precautions. The cases for study, however, rest on yet broader foundations, for, though theory deduced from history can never, from the nature of things, formulate positive prescriptions, it can at any rate enable the student to throw off the chains of convention and prepare his mind to balance the conflicting claims of the many factors which at every moment clamour for special recognition.

To understand the subject thoroughly it is necessary to follow in some detail the successive stages of human evolution. From the earliest times the defeat of the fighting men of a race has been the most certain road to the acquisition of its wealth, or the trade conditions on which that wealth was based.

To defeat an enemy it was first necessary to march to meet him, and during that march the invaders must either live on the country or carry their own food. If the defender drove off the cattle and burnt the crops, the latter alternative was forced upon them. Thus, since the supplies which could be carried were of necessity small, the defenders had only to create or utilize some passive obstacle for defence which the invaders could not traverse or destroy in the limit of time (fixed by the provisions they carried) at their disposal, to compel the latter to retire to their own country. Every sedentary nation, therefore, had a fixed striking radius which could only be extended by the exercise of ingenuity in the improvement of means of transport, *i.e.* carts and roads. The existence of roads, however, limited the march of an invader to certain directions, and hence it became possible for the defender to concentrate his efforts for their

defence on certain points, in fact, to create fortresses, greater or less in proportion to his fear of the enemy and his intelligent appreciation of the degree of sacrifice it was worth while to make to obtain security. A barbarian horde could be stopped by any barrier which could not be set on fire or escalated without ladders or appliances. Ruses, such as the wooden horse of Troy, then became the fashion, and these had to be met by the cultivation of a higher order of intelligence, which naturally thrived best in a crowded community, where each felt his dependence on his neighbour. Thus, for ages, the fort or fortress limited barbarian encroachments, and made possible the growth of civilization in the plains. Ultimately, when the civilized communities grew into contact with one another, developed antagonistic interests, and fell out with one another, intelligence was brought to bear on both sides, and the assailant met fortification with siege-craft. Then the whole cycle worked itself out again. To carry out a siege, men in numbers had to be concentrated and fed whilst concentrated. The stores for attack were also heavy and difficult to convey, hence roads developed increased importance, and troops had to be abstracted from the fighting force to protect them. Thus again a limit of striking radius was fixed for the invader, and in proportion as the dimensions of the invaded country exceeded this radius, and its people made the requisite sacrifices to maintain their fortifications in order, the continued existence and growth of the smaller country was assured. Broadly, this equilibrium of forces remained for generations; the smallest states were eaten up, the larger ones continued to exist side by side with far more powerful enemies, but only on condition of their readiness to make the requisite sacrifice of their personal liberty and the property of their constituent units.

Then came the introduction of gunpowder and of siege artillery, and a fresh readaptation of conditions, which culminated in the Netherlands during the 17th century and forms the starting-point of all modern practice.

Essentially the change consisted in this, viz. that in spite of the superiority of the cannon-ball to the battering-ram, yet to attack a wall effectively many guns had to be employed, and while the duration of the siege was enormously shortened, a far greater strain was thrown on the line of supply, for not only did guns weigh as much as their predecessors but they could expend their own weight of ammunition in a day. Hence the importance of good roads became enhanced and correspondingly the incentive to attack the fortresses which guarded them. In comparison to the money devoted to modern armies, the sums sunk on passive defences during the 16th and 17th centuries were colossal, but they could not keep pace with the progress of the attack, and once more fresh readjustment of means to end became necessary. The obvious course was to carry the war into the enemy's country from the outset, but since this transferred the burden of the siege upon the aggressor, the latter was compelled to develop the standing mercenary army, as feudal levies could not keep the field long enough to reduce a fortress. Mercenary armies, however, were difficult to keep together. They had to be tactfully commanded to ensure contentment, and allowed to maintain social order amongst themselves, and the prospect of loot while on active service had to be held out to them. The sack of a city became thus the absolute and undeniable right of the soldiers. If in this or any other way their employer broke his contract, individuals promptly deserted to the other side. But this right of sack led to a recrudescence of the spirit of resistance in the fortresses (War of Dutch Independence and Thirty Years' War), and hence to a reaction in favour of greater humanity in warfare. But this was only obtained by the concession of a higher scale of pay and comfort to the men, which again threw an increased strain upon the communications, and also upon the treasure chest of their employer.

The growth of the mercenary system, and the facility with which such men could and did change their allegiance, led very rapidly to almost complete uniformity in the composition, training and tactical methods of all armies. Every one knew in advance the degree of effort his adversary proposed to put

forward in the next campaign, and made corresponding preparations to meet him. Practically the king desiring to make war submitted his idea to the best-known generals of his day and asked them to tender for its execution. The king, on his side, generally agreed to find the bulk of the labour—his standing army, reinforced by auxiliaries to any desired extent—and as in the case of a modern government contract, the lowest tender was almost invariably accepted, with a pious exhortation to the successful competitor to spare his employer's troops to the best of his ability. Thus the opposing generals took the field, each equally fettered by the conditions of his tender. But two such armies, alike in almost every respect, were far too closely matched to be able easily to gain a decision in the open field. Once they were committed to a battle it was impossible to separate them until sheer physical exhaustion put a stop to the slaughter, and these highly trained men were difficult and expensive to replace. Naturally, then, the generals sought to destroy the existing equilibrium by other means. Primarily they took to strong entrenchments, but the building of these being a matter of time, the communications grew in importance and attempts against them became more serious. One side or the other, consequently, to cover its communications, so extended its front that at length lines stretched right across whole frontiers till their flanks rested on the sea, or on some great fortress or neutral territory. The two armies would then face one another for months, each exhausting every device to induce the other to concentrate on one part of his front whilst an attempt was made by a rapid move to carry a relatively unguarded point elsewhere, e.g. Marlborough's surprise of the *Ne plus ultra* lines (see SPANISH SUCCESSION). During such periods of immobility the works grew to the solidity of permanent fortifications, with wide and deep ditches, and with every obstacle known to engineers, whilst to render them defensible by the minimum number of muskets, they were laid out so as to cross their fire over and over again opposite every weak point in their tracing. No amount of battering could alter their general trace, and so they remained defensible as long as their garrisons could be trusted to line the parapets at all. This state of things must have continued until progress in artillery had evolved a weapon with sufficient accuracy and shell power to drive the defenders from their parapets and keep them away till the last moment preceding assault, had not fresh factors evolved themselves from causes at work under totally different topographical limitations and conditions.

First amongst these comes the accession to the throne of Prussia of a king who was commander-in-chief of his own army, and as such responsible to no one for the use he chose to make of it. This would really remove him at once from the category of strategists in the restricted sense in which the term is now employed, but since no convenient word exists to define the action of a ruler playing the double part of soldier and governor, it is convenient both in his case and in that of Napoleon to use the expression to cover the wider sphere. The permanence of the association between king and army enabled Frederick the Great to train his men specifically for the work he intended them to perform. Realizing to the full the value of the foundation laid by his father in developing to its utmost the fire power of the infantry, he devoted special attention to imparting to them a skill and rapidity in manœuvre which ensured that in the open field his generals would always be able to place the muskets at their disposal in the best positions relatively to the enemy; and his cavalry were trained to such a pitch of mobility and precision in drill that they could be relied on to arrive at the appointed time and place to reap the fruits which the infantry fire had sown. To these startling innovations the Austrians had no new ideas to oppose. The old school, the survival of the fittest in the special theatre of its growth, i.e. the Netherlands and the Rhine, could not deal with the complete change in topographic surroundings—the far wider area of operations, the comparative scarcity of fortresses and the general practicability of the country for the movement of troops—not trains—off the roads. Frederick, relying absolutely on the intrinsic superiority of his army, knew that if he could catch his enemy in the open victory

was a foregone conclusion. If the enemy, in accordance with precedent, fortified a position, a threat to his communications would force him to come out on pain of being surrounded (Pirna 1756, Prague 1757). He followed this principle (see SEVEN YEARS' WAR) until the accession, first of France and the South German states, and afterwards of Russia, to the list of his enemies compelled him to give one enemy time to prepare a position whilst he was engaged against another. Before deliberately prepared positions his men were shot down in thousands, as they would have been in the Netherlands, and at length he was compelled, for want of an adequate artillery, to adopt the same procedure as his adversary. Thus the war ultimately came to an end by a process of mutual exhaustion. But it had brought out conspicuously the value of highly disciplined soldiery, and a fresh fetter was prepared for those on whom, after Frederick's death, the responsibility of command was to fall, and practically all Europe went back to the warfare by contract of the previous generation.

Meanwhile in France events were at work preparing the instrument Napoleon was destined to wield. Contrary to the prevailing opinion amongst modern historians, it is the fact that at no time in history was the art of war, and of all things appertaining to it, more closely studied than during the last years of the old royal army of France. Gribeauval paved the way for the creation of the artillery destined to win for Napoleon his greatest victories, and authors and generals such as the prince de Ligne (*q.v.*), the duc de Broglie, Guibert (*q.v.*), Bosroger, du Teil and many others, pointed out clearly the line reform must take if the existing deadlock between attack and defence was to be removed; but none could suggest the first practical steps to apply, because the existing conditions were too closely interwoven and consolidated. In fact reform was impossible until the dissolution of society itself gave its ultimate particles freedom to combine in more suitable formations. Broadly, however, all were agreed that the protracted and indecisive operations of former wars were economically disastrous. A crushing and decisive victory was the aim for which all should strive; as a first step towards this object decentralization of command was essential, for freedom of manoeuvre, the only answer to Frederician methods, was impossible without it. This led to the idea of the permanently organized division of all arms; and events had reached this point when the deluge of the French Revolution overwhelmed them, and in face of a coalition of all Europe it became necessary to build up a new army from the very foundations. The steps by which it was sought to provide the men are dealt with in the article CONSCRIPTION; it is only necessary to point out here that it was not till 1799 that the laws became sufficiently defined to ensure a regular annual increment of recruits, and it was this regularity of supply, and not the fact that compulsion was needed to enforce it, which rendered expedient the complete revolution in warfare which Napoleon was destined to effect.

Until this reform was complete the revolutionary commanders were compelled to make war as best they could under pressure of the law of self-preservation, with the consequence that the whole army became habituated to the fact that orders in the field had to be obeyed at any sacrifice of life and comfort, and that neither hunger nor want of shoes, even of muskets, could be accepted as an excuse for hesitation to advance and to fight. Threatened on all sides, France was at first compelled to guard every avenue of approach by small separate forces taking their instructions only from a central authority in Paris, and thus the "division," a mobile force of all arms, which the earlier reformers had demanded, came spontaneously into existence to meet the requirements of the moment, and, thrown on its own resources, developed the brain and nervous system, *i.e.* the staff, necessary to co-ordinate the action of its limbs.

The next step in evolution came from the obvious advantage which must arise if these units, though starting from different bases, operated towards the attainment of a common purpose. The realization of this ideal, the starting-point of modern strategy, was the creation of Carnot, whose ideas, though far in

advance both of contemporary opinion and of the technical means of execution then available (especially in the matter of imperfect means of telegraphy), formed a necessary step in the preparation of the machinery Napoleon was to inherit.

These, therefore, were the materials placed at his disposal when he began to practise the art of the leader: (1) a practically inexhaustible supply of men (the *law* in fact was not passed till two years later, but the *idea* was sufficiently evident); (2) divisional units and commanders, trained to unhesitating obedience to field orders, and accustomed to solve the problems presented to them in their own way, without guidance from superior authority; (3) the idea of co-operation between separate columns for a common purpose; and (4) a tradition that the word "impossible" did not exist for French soldiers.

The equipment of the allies started from very different foundations. To them the individual soldier was a valuable possession, representing an investment of capital generally estimated at £200 cash (as great a strain on the exchequer then as £2,000 would be to-day); and not only was he exposed to the risk of death in action, but he might die of disease or exhaustion on the march, and could always desert if he felt discontented. Moreover, the last campaigns of the Seven Years' War seemed altogether to justify methods of evasion and "strong positions." Frederick the Great, beginning with the most audacious offensive, had ended by copying the caution of his antagonists, and each side had learnt to gauge the fighting value of a single battalion so accurately that to move a force, recognized by both as adequate for its purpose, into a threatening position, sufficed of itself to induce the adversary to accept the situation thus created. Since the value of a fortified position depended largely on the ground, the cult of topography became a mania, and (as Clausewitz puts it) the world lost itself in debating whether "the battalion defended the mountain or the mountain defended the battalion." The care for the comfort of the private soldier was pushed to such a degree that commanders would not report their units fit for action until complete to the last gaiter button and provided in advance with the regulation scale of rations for a fixed number of days. Over-centralization continued; though the expressions "divisions" and "corps" were already known, the idea these words now convey had not yet even come into existence. Though a certain number of units might be assigned to a subordinate commander, they still received all orders, except on the battlefield, from the central authority, and were, moreover, considered interchangeable. There was no personal bond between them and their general. To what lengths this system was pushed, and the consequences which flowed from it, may best be gauged from the fact that in 1805 Mack, when writing his defence for his failure at Ulm (see NAPOLEONIC CAMPAIGNS), thought it quite natural to explain the delay in his movements on the day of Elchingen by the fact that when news of the French attack was received he was busy writing out the orders for the following day, which occupied fourteen pages of foolscap and "did not contain one superfluous word." Further, the idea prevailed in middle Europe that war was a matter concerning the contending governments in which the ordinary citizen had no interest whatever. It was true that the result of a war might transfer his allegiance from one crown to another, but this was scarcely more to the people than a change of landlords. Consequently they took little if any interest in the progress of a war, and on the whole were most inclined to help the army which most respected their private property and was willing to pay highest for its accommodation while billeted in their towns and villages. Since the goodwill of inhabitants is always valuable, commanders vied with one another in their efforts to purchase it, and respect for private property and rights reached an unprecedented level. Thus, during the whole of the campaign of the Netherlands in 1793 the Austrians paid hire to the owners of the fields in which they camped; and when on one occasion payment for lodgings hired for the wounded was in arrear, the wretched men were flung out on the streets. Yet another, and in a way more remarkable, illustration of this tendency occurred at the capture

of Mainz by the French (1794). A strong armed party of Austrians, endeavouring to escape across the Rhine to Kastel, were refused the use of the ferry boats until the regular payment was made, and actually laid down their arms to the enemy rather than break the law and seize the boats.

The cumulative influence of all these forces of retardation is easily followed. To avoid the cost of innumerable petty cash transactions with the inhabitants the troops were compelled to have recourse to the magazine system, which in turn tied them absolutely to the main roads; and the roads being numerous the army had to be broken up into small detachments to guard them. Thus the so-called "cordon" system grew out of its surroundings in a perfectly natural way, and was not due to the imbecility of the generals who employed it, but to the restraints placed upon them by custom and public feeling. Nothing more fortunate for the French could be imagined. Destitute of all the paraphernalia hitherto considered necessary, and compelled to fight at any cost in order to live, they found in these accumulated magazines and moving convoys the best possible bait to attract their starving men; relieved of all impedimenta, they could move freely through forests and marshes generally considered impracticable; and since from the magnitude of front covered, and the relatively small number of troops available, the allies could not oppose an unbroken front to their raids, they could swarm around the flanks of the positions and thus compel their evacuation. This struggle to safeguard or turn the flanks of positions led, as before in Marlborough's time and in our own day in Manchuria and South Africa, to a competition in extension, and at Napoleon's advent it was common to find armies of 20,000 to 30,000 men fighting desultory actions over a front of 20 to 30 m. This over-extension gave him his first opportunity, when the fire and energy he threw into his work, and the reckless disregard of human life he immediately displayed, stamped him at once as a born leader of men, and laid the foundation of that confidence in his guidance on the part of his troops which to the last proved his truest talisman of victory.

For the details of Napoleon's evolution the reader is referred to the articles FRENCH REVOLUTIONARY WARS and NAPOLEONIC CAMPAIGNS, and here it will suffice to point out the leading characteristics of those campaigns. Having swept the Austrians out of Sardinia, he turned against them in eastern Lombardy, and by a series of outflanking attacks threw them back into the Alps, defeating all their attempts to break out again by what is now known as a "series of operations on interior lines." All these were successful, not because of the form the operations took, but because the enormous increment of mobility he managed to impart to his men deprived his adversary of all accepted data by which to time his own combinations. It cannot with justice be said that the French won because they fought harder; but the rapid sequence of success confirmed both leader and men in a conviction of their combined superiority which led Napoleon in 1800 to the very brink of disaster. In 1796 throughout he was acting fairly in accordance with the teaching he had imbibed from his studies; in 1800 he appears as if seeking to determine how many of the established rules he could afford to neglect. We find him advancing to meet his adversary on a widely extended front without even exploring the country to learn where or in what strength that adversary stood. In 1805 this mistake is not repeated; a cavalry screen covers his advance, and his orders are based on the intelligence it transmits. But this precaution also proves insufficient. Cavalry can only see, they cannot hold; and only a combination of circumstances which he could not by any possibility have foreseen prevents his enemy from evading the blow at the last moment. What the position of the French would have been had Mack carried out his intention of leaving Ulm and destroying all his accumulation of supplies can only be imagined. But contemporary evidence proves beyond doubt that Napoleon had already tried the endurance of his men to the utmost.

In 1806 the mistake of sole reliance on a cavalry screen is no longer repeated. The cavalry now is backed by a strong advanced guard, one quarter of the whole army, following

behind it at short distance; and the whole command is now disposed in such a manner that no matter in what direction the enemy may appear it can concentrate in forty-eight hours to meet him. It is another form of the idea, prominent in British campaigns in the Sudan, of the advance in squares through the desert against a mobile enemy, the difference being that Napoleon's great "bataillon carrée" has the advantage of mobility over its adversary. Concentration within forty-eight hours, however, would in itself be worse than useless unless the enemy stood fast to receive the intended shock; and it was the special object of the strong advanced guards or flank detachments to secure that he should do so. This could only be attained by a resolute offensive; no mere feeling the enemy's position would suffice to compel him to stand, and might even frighten him into retreat. Hence the task devolving upon the troops thus selected was essentially distinct from that usually connected with the idea of an advanced or flank guard, and involved the conception of purchasing with their lives and by the vigour of their action the time necessary for the rest of the army to deliver a decisive blow.

This is the true meaning of Napoleon's maxim: *On ne manœuvre qu'autour d'un point fixe*, a phrase which has been much misunderstood. The troops first engaged fix the enemy by the vigour of their attack, and thus constitute a pivot about which the remainder can manœuvre.

Hitherto, however, the French armies had been operating in a country in which roughly one square mile of area would feed one thousand men for two days. Their freedom from convoys and other impedimenta enabled them to sweep out an area sufficient for their needs from day to day. But events now led them into a region in which this relation between the day's march and their subsistence no longer obtained. The emperor in fact had formed no conception of the roadlessness and poverty of Poland and East Prussia. His men, no longer able to pick up their day's food by a day's march, rapidly fell off in condition and discipline (for short commons with the French always entailed marauding). As men and horses lost in condition the day's march dwindled further, with the result that heavier demands were made on the supply columns; and these being improvised and entrusted to an untrained personnel, the sufferings of the troops became unendurable, while the mobility of the French army sank below that of the enemy. Under these conditions the system of the advanced guard could no longer be trusted to work. Moreover the Russians, though deficient in the dash necessary to win victories in attack, have always taken longer to defeat than any other continental troops, and in the short winter days of the first half of the Polish campaign the emperor had no longer time to beat them into dissolution. The Russians would fight all day and retreat at night. As they fell back along their communications their feeding was easy. The exhausted French could never overtake them, and the emperor was at length compelled to adopt an expectant attitude. Not before Friedland (June 14, 1807), when the days were long and the country dry and everywhere passable, did his calculations of time and space prove realized and the system justified by the results.

When in 1812 he again attempted to apply it at Vilna and Smolensk the Russians successfully repeated their tactics of evasion on every occasion, until, when they had fallen back to Borodino, their enemy had so far diminished that a battle in a selected position promised reasonable chances of success.

Meanwhile a fresh development in the tactics of the three arms added a new weapon to Napoleon's armoury, rendering the application of his system or any variant of it markedly more certain and efficacious. Whilst the infantry which fought under Napoleon's eagles had been steadily deteriorating, owing to the exorbitant demands his ceaseless marching campaigns had made upon them, the quality of his enemies had been as steadily improving. The growth of the sentiment of nationality had rendered it possible to throw aside the rigidity and impediments of the old conditions. There was no longer any fear that men would desert if called on to bivouac or if rations failed to

come up to the accepted standard, and the essential points of the French infantry tactics having been assimilated they developed a relatively higher standard of endurance as measured by time. Means had to be discovered to ensure their destruction before nightfall gave them the opportunity of withdrawal; and the evolution of the artillery arm (see ARTILLERY) at last gave Napoleon the weapon he required to realize the ideal implanted in his mind by his teacher du Teil, viz. *concentration of the destructive elements on the decisive point*, which was derived originally from the analogy between the attack on a fortress and the conduct of a battle. A battle is but an abbreviated siege, or a siege a prolonged battle. In the former the object is to purchase time at the cost of men's lives, in the latter to economize men by expenditure of time; but in both the final step is the same, viz. the creation of a breach of continuity in the enemy's defence through which the assaulting columns can penetrate to the heart of his position. Thanks to the increased mobility in the field artillery and skill in handling it (the result of years of experience), it was now possible, once the aim of the enemy's infantry had been unsteadied, to bring up masses of guns to case-shot range and to breach the living rampart of the defence; and through the gap thus created, infantry or cavalry, or both combined, poured to overwhelm the last reserves beyond. This step completed Napoleon's means of destroying that "independent will power" of his adversary which is after all the greatest variable in the whole problem of war. His advanced guard engaged and fixed his enemy's attention, inducing him prematurely to use up his reserves, and when the battle was "ripe," to use his own expression, the great blow was delivered with overwhelming suddenness by the balance of fresh troops which he had in hand. But the whole of his action depended essentially on an exact appreciation of the endurance of his own troops first engaged, at the cost of whom the reserves were saved up. It was the possession of this method which rendered Napoleon supreme upon the battlefield and fully justified the reluctance which his enemies showed to hazard its issue; but in the end it also proved the cause of his downfall, for in his fruitless efforts to bring the allies to action in 1813 he so completely wore out his troops that it became physically impossible for them to meet his demands.

The campaign of 1813 deserves attentive study, for in it Napoleon was both at his best and worst, acting as strategist pure and simple, applying the means at hand to the attainment of the object in view almost without a second thought for the diplomatic relations which so often hampered his military action, notably in 1814. In the famous "defensive campaign" of the latter year, which is usually held up as a model for imitation, he can hardly be said to have acted as a strategist at all, his movements being primarily directed to the destruction of the personal relations existing between the three allied monarchs, not to the annihilation of their respective armies, a task for which from the first he knew his resources to be entirely inadequate. The Waterloo campaign (*q.v.*) again reveals the application of this system in its most finished form. That it failed ultimately was due primarily to atmospheric influences beyond the emperor's control, and in the second place to the introduction of a new tactical method by the British army for which his previous experience had in no way prepared him.

That after the event Napoleon should have sought to justify himself is further proof of the essential duality of his nature, which only rose to intuitive genius in war under the pressure of visible and tangible realities. Relaxed from excitement, he was the creature of his surroundings, controlled by contemporary thought like everyone else; and it is to failure to recognize this duality in his mind that all subsequent confusion in strategical thought owes its origin. It was clear that the career of such a genius could not pass unnoticed by military critics, hence, even while it was still in the making, every student of the military art felt compelled to pass judgment upon its incidents merely to show that he was abreast of the times. More or less, each one tried to show that Napoleon's victories were due to the observance of the critic's own hobbies. These men, brought up on the old

military classics, and unaware of the ceaseless current of social changes which was seething around them, instinctively distorted facts to fit in with their preconceived theories. This is always inevitable with regard to contemporary criticism, since distance of time is always needed to bring facts down to their true perspective. It is quite clear from his innumerable reported conversations, and it is quite natural when one considers Napoleon's age, that in the back of his mind he stood rather in awe of these older and often far more deeply-read men. In any case it was quite obvious to him that his military reputation would stand or fall by their collective judgment. Hence, as soon as he had leisure, he set himself to explain his exploits in terms which they could understand. That he would be criticized for his frequent departure from established practice (for instance, in neglecting his communications, and again and again accepting or forcing on a battle in situations in which defeat must have spelt utter ruin) he was well aware. Hence to stifle such criticism in advance he went out of his way to accentuate the care he had devoted to his communications, as in the Marengo campaign, at Ulm, at Austerlitz, and again and again in the campaigns of Wagram and of Dresden. But the truth really is that as long as he adhered to his "bataillon carrée" formation, and the country in which he was operating was fertile enough to support his men, his communications mattered little to him. His certainty of victory, if only the enemy could be induced to stand, was so great that he could fight his way through to where his reinforcements were prepared for him, in whatever direction suited him best. Whilst he admitted, as all must do, the sound common sense at the bottom of all rules deduced from centuries of experience, he never raised them to the dignity of inviolable principles, as he did the principle of the fixed point as a pivot for manœuvres, the case-shot attack, and the employment of the *avant-garde générale*. It seems indeed as if these fundamental principles appeared to his mind so self-evident that he assumed them as common knowledge in every intelligent mind, and hence never took the trouble to explain them to his marshals, though he did condescend to allude to them when writing to his brother Jerome and to Eugène de Beauharnais, with the limitations of whose minds he was quite familiar. Marmont, Rogiat, Soult and St Cyr were men for whose intellect he had the highest esteem, and all wrote at length on the subject of his campaigns, yet not an expression in their works, not a manœuvre in their independent commands, can be held to betray a knowledge of what was really the secret of the emperor's successes. For instance, by the year 1812 Marmont may fairly be assumed to have learnt all he ever could learn from Napoleon's example; yet at Salamanca we find him manœuvring quite like one of Frederick's generals. Napoleon would have attacked Wellington with a strong advanced-guard, one-fourth of his command at the least, and whilst the latter was busied in warding off his assailant's successive blows the emperor would have swung the remainder round upon his enemies' flank, and, with a three-to-one superiority at the decisive point, have driven him off the road back to Salamanca. This idea never even entered Marmont's head. Watching Wellington with a screen of vedettes only, he set his whole army in motion to march round his flank, like Frederick at Leuthen. An Austrian army in the old days would usually stand to be surrounded, but Wellington, instead, set his whole force in motion, *i.e.* manœuvred. Again in 1813 (just after frequent conversations with the emperor, in one of which the latter stated his opinion that war was a "science" like any other, and that some day he would write a book out of which any one could learn it), Marmont, in command of the VI. corps, found himself opposed to the Silesian army under Blücher, and immediately took up a defensive position, which he occupied by two lines of brigades deployed in line and écheloned from left to right. No one who had entered into the spirit of the emperor's method could have adopted such a formation. Instances of a similar nature might be multiplied, and their multiplicity need surprise no one who has studied the psychology of action taken under circumstances of intense excitement or imminent danger. Most of us know rules for

conduct in all kinds of emergencies, but how often afterwards could anyone describe with accuracy the mental process by which his action in such crises was dictated? Probably never. Intuitively the mind recognizes the right course and fixes upon it, and with the cessation of the emergency finds it impossible to recall the order in which the facts presented themselves to his consciousness. In war these emergencies are constantly arising, so that by degrees the recollection of them becomes blurred, and the chief actor's presentation of them is often the least trustworthy testimony we possess. The act speaks for itself. But where hundreds of thousands of acts are crowded into the short compass of a campaign, a true view of their whole can only be obtained when all have become accessible and time emancipates criticism from partiality. But nations cannot afford to wait until lapse of time renders it safe to publish all diplomatic and other secrets; and many were ready to attempt the solution of the problems of Napoleon's career.

The most prominent were Jomini (*q. v.*), speaking for the French army, and Clausewitz (*q. v.*), for the Prussian. The former, a native of Switzerland, had attracted the attention of Napoleon by the insight his criticisms revealed, and had been attached by him to the staff, where he served under Ney almost continuously from 1806 to 1813. In the latter year there is no doubt that he

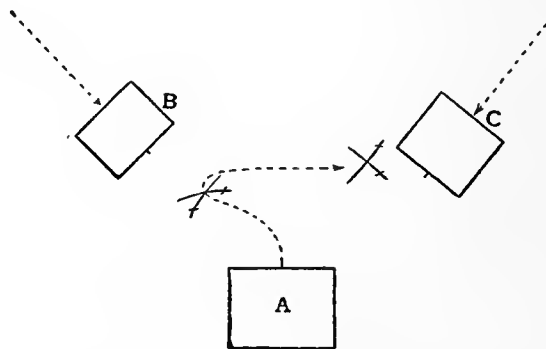
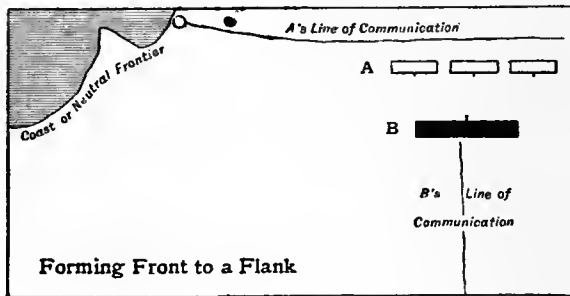

did valuable service in the operations culminating with the battle of Bautzen; but, receiving no adequate recognition for them, he deserted to the allies, and was attached by the emperor Alexander, where again he rendered conspicuous service, notably at Leipzig; but his desertion caused him to be viewed with such marked disfavour by all honourable men that he speedily sank into social oblivion, although he remained in the Russian service until his death in 1869. Nevertheless, though he had deserted his cause, he still retained unbounded admiration for the genius of his great master, whose reputation certainly does not suffer at his hands, except for the excess of adulation and bombast with which his historical writings are disfigured. But his social isolation cut him off from authentic eyewitness sources, and he was by nature an inventor of systems. The secret of Napoleon's success he found in the system of "interior lines"—a phrase he invented to designate a method which was almost as old as war itself; and from this system he deduced its opposite, "exterior lines," and a whole sequence of others, which in the end all resolve themselves into the same idea. A diagram will make the matter clearer than many words. If an army A stands in a

central position relatively to two other armies B, C, converging upon it, then, if it moves against each in succession and beats them both, it is said to act on "interior lines"; whilst B and C act on "exterior lines." What it is said to do when at the first shock B beats it out of existence the books fail to inform us. From this theorem are deduced in succession the advantages and disadvantages of salient and re-entering angles, &c., with which, as a rule, military historians so freely befog their pages.

Since the object of all strategy is to bring the greatest possible force to bear against the decisive point, it is obvious to ask why armies should not always be concentrated, and why they should ever divide. The answer is that a given district and a single road will only subsist a certain number of men, a number which in practice is found to be about 60,000 with their requisite guns and train. Hence an army, say of 120,000 men, not only cannot subsist on a single line or road, but when divided into two equal parts, and separated only by a short day's march, is really more ready for instant action than an army of 90,000 on one road. Separation, therefore, when large numbers are in question, is a necessity of existence, not a matter of free choice; but when it is thus forced upon a commander he regulates the rate of his march so that his separate columns cannot be attacked singly before the heads of both are within supporting distance of one another; the jaws of the crackers then close on the nut, and unless the nut proves harder than the crackers the nut is crushed. But this calculation reposes on an accurate knowledge of the marching powers of the adversary, and it was in this that Napoleon's enemies failed. Accustomed only to their own deliberate methods, they were quite unable to imagine Napoleon's lightning-like rapidity. Marching twenty-five miles in a day, his whole army would hurl itself on one of the columns whilst the other was still too far off to come to its aid, or if they had already approached so close that mutual co-operation was imminent, he would send a detachment against one to purchase time by the sacrifice of its men's lives, and would then strike at the other with the bulk of his forces united. How the detachment executed its task depended chiefly on the nature of the ground. It might fight a series of rear-guard actions if a succession of readily defensible sections favoured such action, or it might conceal its weakness and impose caution and respect on its opponent by the vigour of its attacks; for that there could be no rule, and circumstances alone could decide. In this form Napoleon won most of his earlier successes, but a little reflection will show that the method depended essentially upon his superior mobility and the willingness of his enemy to fight or the reverse. In time this dawned upon his opponents also, and when in 1813 around Dresden he tried to put this plan into force the allied column immediately threatened retreat before him, whilst the other continued its advance, thus compelling him to return to succour his retreating detachment, which, of course, could not struggle on indefinitely against a marked superiority of numbers. He himself confessed during the September days in Dresden that this *jeu de va-et-vient*, as he described it, had completely broken down his army. If, on the other hand, the commander of the central army underestimates his opponent's marching powers its doom is sealed, for both his flanks are turned in advance and he comes under a concentrated fire to which it can only oppose a divergent one. This difference is more marked now than formerly; and stated in its extreme form, for rifle fire only, it really means that every bullet fired from the circumference stands a tenfold better chance of hitting something vulnerable than those directed from the centre towards the circumference. The only salvation for an army thus threatened is to move by a lateral march outside the jaws of the crackers, and fall on one limb only, when, if it is tactically formidable, it stands a good chance of overwhelming the force immediately opposed to it before the others can arrive. For instance, at Königgrätz, if the Austrian main army, pivoting on the fixed point made by their 2nd and 4th corps engaged with Prince Frederick Charles's army, had swung round the remaining six corps upon that of the crown prince by a short march of from six to eight miles, the Elbe army would have struck a blow in the air, and the situation

would have been rescued in spite of the slowness and indecision of previous movements. An army standing on interior lines, therefore, occupies a position of advantage or the reverse according to the skill of its leader and its own inherent fighting capacity, and this whether its position arises from operations during the actual course of hostilities, or from circumstances already pre-existent in peace time, as for instance, the configuration of frontiers. The phrase, therefore, "the use of interior lines," though convenient to those who are thoroughly agreed as to its limitations, of itself explains nothing, and is a pitfall for the inexperienced.

A, however, in moving as suggested against his enemy's outer flank, exposes at the same time his own communications with any place lying directly behind his point of departure. If his army suffers only from slowness, but is really superior in fighting power, this risk may be lightly taken—victory settles all things. In proportion, however, as the result of collision is

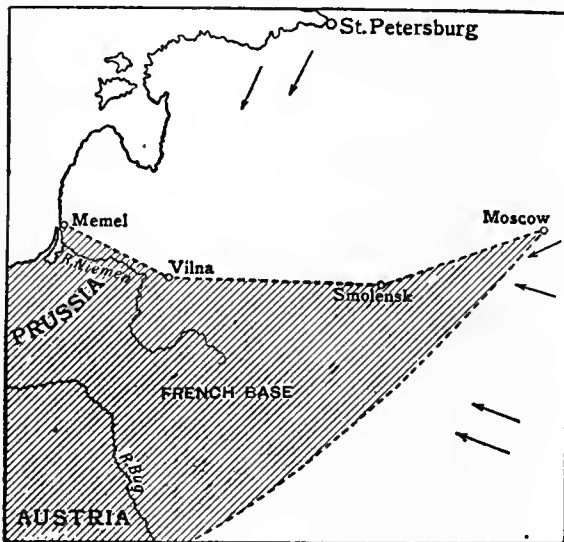

doubtful, alternative lines of retreat or supply will be advantageous. Hence a broad, if possible a concave or re-entering, base or starting-line is of great importance, and, since as an invader penetrates into his enemy's country his base becomes salient, whilst that of the defender becomes re-entrant, we have here a compensating arrangement which, under given conditions of country, equipment and the like, fixes the striking radius of an aggressor precisely as was the case in former times. The case of the French invasion of Russia in 1812 is an illustration. The Russian base at any moment may be considered as formed by lines traced just outside the striking radius of small bands of French marauders; the French base as including all the territory in their occupation, for within that area they were free to fortify or protect any accumulations of stores and supplies they chose to make. By the time the French reached Moscow the Russians could afford to attack them from any direction, for, whatever happened, retreat into their own undevastated country was always open. The South African war affords a modern example of the same thing.

These ideas are, after all, elementary, and readily grasped even by the average intellect, though many volumes have been devoted to proving them, and yet they are all that Jomini and his followers have to offer us—a fact that both explains and justifies the contempt with which military study was so long regarded by practical soldiers in England.

Clausewitz, however, approached his subject from a higher standpoint. Gifted with a mind of exceptional power, which he had trained to the utmost in the school of German philosophy, and having seen war from the beaten side, he knew well that something more than phrase-making was needed to force a great nation to the final abnegation of its independent will. He stood throughout in the closest connexion with the directing

wills which guided the German nation to achieve the final downfall of Napoleon; and he knew that these men were neither bunglers nor fools, but men whose experience well entitled them to the authority they exercised. Hence he reasoned that the catastrophes they had shared in common needed deeper analysis than they had as yet received. First of all he sought a satisfactory definition of what war really meant, and he found the closest analogy to it in the "unrestricted competition of the business world." Had he written in modern times he would doubtless have cast it in the Darwinian mould, viz. "war is the struggle for existence transferred to the national plane," and this is a far more important contribution to sociology and the welfare of humanity, and will certainly exercise much greater influence on the evolution of the nations (on which, after all, the fate of the individual depends) than all the works of Darwin and Herbert Spencer combined. This transference of the question to the national plane is in fact their very antithesis, for whereas the survival of the fittest threatens the stability of society on the principle of the Kilkenny cats, the survival of the race necessitates its coherence. Next, Clausewitz analysed his subject into its constituent factors. In this process he investigates all the theories of bases and geometrical relations, only to discard them as quite inadequate solutions of war's many phenomena; and finally, as between equally armed opponents, he shows that essentially success in war depends on the moral factors only. First is "courage" in all its forms, from its lowest manifestation in the excitement of a charge, to its highest in the fearless acceptance of supreme responsibility in face of the most imminent personal danger. Next comes "duty," again in its widest sense, from the uncomplaining endurance of the humblest musketeer in the ranks, to the readiness of the whole nation to submit to the sacrifice of, and the restraint on, personal liberty that readiness for war entails. This "readiness," moreover, he shows to be cardinal (for nations with land frontiers), for indubitably, under the conditions then prevailing, the surest guarantee of victory in the field was the concentration of every man, horse and gun in the shortest time on the decisive point. Thus only could the advantages of greater wealth, larger population and so forth be neutralized; and the growth of modern means of communication, railways, telegraphs, &c., have only confirmed his position. It has been the gradual appreciation of portions of Clausewitz's teaching, enforced by the drastic lessons of 1866 and 1870, which has turned all Europe into an armed camp, and this fact must, for generations, stultify all ideas of European disarmament. For since everything depends on instantaneous readiness for action, it is absurd to expect that any nation will voluntarily consent to throw away the advantages these sacrifices have obtained by agreeing to delay at the very moment when its existence is most gravely threatened. An unready nation has obviously everything to gain from delay.

All this portion of Clausewitz's work is fundamental, and no changes in armament or other conditions can ever affect it; it applies as much to land as to sea power, and essentially was the doctrine of Nelson and St Vincent. Indeed, at sea Nelson was in advance of Napoleon, for he quite understood the advantage to be gained in paralysing the independent will-power of his opponent by a vigorous attack, and was willing to stake his existence upon this principle, notwithstanding the infinitely more uncertain elements of wind and weather which conditioned his movements. But the rest of Clausewitz's teaching is too deeply coloured by his personal experiences, and he stood in too close a relation to the events of his time to be able to focus the details of the whole subject. Although he was the first to seize the meaning of Napoleon's case-shot attack (the description occurs for the first time in his *Campaign of 1815*), he did not realise how this might be applied to the destruction of what he himself formulated as the most serious of all the many indeterminate factors with which a commander is called upon to deal, viz. "the independent will-power of his opponent." He saw clearly enough that time and space were the underlying conditions of all strategical calculation, and that time could be

bought at the cost of men's lives; but he did not take the next step forward and show how these calculations must inevitably be upset if the enemy possessed the power of destroying men faster than experience led one to expect. He formulates from his experience that a force of the magnitude of a division, say 10,000 men, can hold an overpowering enemy at bay for about six hours, and an army corps can hardly be destroyed in less than a day; on these data he bases his estimates of the marching area which an army may safely cover. But what if a new and unexpected method of applying "the means at hand to the attainment of the object in view" suddenly wipes out the division in two hours, or the army corps in six? In that case, surely, the independent will-power of the adversary would receive a most unwelcome check. Nor did he ever clearly formulate as a principle the importance of mobility. Every one of course has in a general way understood the advantages of "getting there first," and all of us have for years been familiar with the importance which Napoleon attached to rapid marching. But the tendency has always been to consider the rate of marching in itself as an invariable factor, and to calculate every operation or disposition from the time a column normally takes to deploy into position from a road or defile. But no systematic attempt to determine the advantages which might on occasion be obtained by sacrificing comfort and convenience to the acceleration of a march has ever been undertaken. Yet Napoleon saw and appreciated the point, and it must remain a riddle for all time how such a mind as Clausewitz's, which again and again had seen at first hand the consequences which followed from Napoleon's *marche de manœuvre*—guns and trains upon the roads, infantry and cavalry moving in mass across country—could have failed to place on record the enormous advantages which might follow its adoption. The book as it stood, however, became the bible of the Prussian army, and its comprehension is an indispensable preliminary to all useful study of contemporary practice in war. Moltke's mind, and that of his whole generation, was formed upon it. To its strength the Germans owed all their successes, and to its weaknesses certain grave errors that were almost disasters.

Meanwhile the progress of invention suddenly destroyed the governing condition of all previous experience. The Napoleonic strategy, as we have shown, depended primarily on the certainty of decision conferred on him by his "case-shot attack"; but the introduction of the long-range infantry rifle (muzzle-loader) rendered it practically impossible to bring the masses of artillery to the close ranges required by the Napoleonic method. In the 1859 campaign (see ITALIAN WARS) between France and Austria both sides were handled with such a general absence of intelligence, and the marksmanship of the Austrians in particular was so very inferior, that neither side derived advantage from the change. But when, in 1861-65 (see AMERICAN CIVIL WAR), the theatre of interest was transferred across the Atlantic, the other causes united to give it immense importance. America in the sixties was almost as roadless as East Prussia and Silesia in Frederick the Great's time, and its forests, rivers and marshes were far more impenetrable. Both the Southern and Northern armies, moreover, were entirely new to their work, and consequently their operations became exceedingly slow. As far as the generals and staff had studied war at all they had been brought up to the Napoleonic tradition as handed down by Jomini and his school; and failing as a body to appreciate the intimate interdependence of the three arms, they believed that a resolute crowding on of masses (whether in line or column does not signify) upon the decisive point must suffice to overrun all opposition. But the slowness of operations gave time for entrenchments, and consequently scope for the powers of the new rifle. Whereas against the old musket one rush sufficed to cover the danger zone, the rifle widened this zone about threefold, so that human lungs and limbs could no longer accomplish the distance without pauses, during which pauses, since guns could no longer assist effectively, the attacking infantry had to protect itself by its own fire, standing in the open within point-blank range of the rifles of the cool, skilful

and well-covered defenders. Thus when similar experiences had established uniformity of practice in the two contending forces the result was a deadlock, which was ended only by enormous numerical superiority and the "policy of attrition." The lesson, however, passed unnoticed in Europe except in so far as popular attention was caught by the deadliness of the rifle fire, which was attributed, not as it should have been to the peculiar conditions under which it was employed, but to the nature of the weapon itself; and from this conclusion it was a short step to the inference that the breech-loader, firing five rounds to one of the muzzle-loader, must prove a terrible instrument of destruction. Actually this inference has hampered strategic progress ever since.

The campaigns of 1866 in Bohemia, and of 1870 in France, furnish positive proof that Clausewitz had not appreciated the Napoleonic teaching to its full extent, for though the conditions again and again were ideal for its application, no trace of his fundamental principle is distinguishable in Moltke's orders. In the former it would seem from the maps that the Austrians actually possessed the form, though they had forgotten the spirit, as the detached group in Bohemia (see SEVEN WEEKS' WAR) might well be considered as an *avant-garde générale*, and on the three days preceding Königgrätz, the distribution of the Austrian main army was such that the application of Napoleon's method must have followed had the idea been present. That Moltke himself never contemplated its employment is sufficiently evident from his unfulfilled plan of the 2nd of July, noon, wherein the whole Prussian army was to march across the front of the Austrians in position, precisely as Frederick had done with disastrous results at Kolin a century before.

No campaign, however, demonstrates in more striking manner the fatal consequences of ignoring Napoleon's saying, *On ne manœuvre qu'autour d'une pointe fixe* than 1870. Here was an army enormously superior in numbers and organization, disposing of an admirable cavalry and far superior artillery, repeatedly on the edge of disaster, not because of the superior cunning of their adversary, but simply because the mind of a reasonable man proved quite incapable of conceiving the blunders that his adversary perpetrated. Moltke always placed himself in his enemy's position and decided on what would be the rational course for him to pursue. He gave him the recognized three courses, but it happened that it was always the fourth (the unexpected, because from Moltke's standpoint so hopelessly irrational) that he took. The situations of the 8th, 11th and 16th of August are all instances in point. On the last of these dates (see FRANCO-GERMAN WAR) the French commander-in-chief by merely standing still through irresolution found himself in a situation promising certain victory. It is true that he took no advantage of it, and nothing can detract from the magnificent resolution of von Alvensleben, commander of the III. Corps, and the gallantry with which his troops and his comrades supported him. But, equally, nothing can alter the fact that in spite of all Bazaine's mistakes the dawn of the 17th of August found the German headquarters with only the débris of two corps on the ground face to face with the whole French army, of which only one-third had been seriously engaged.

Sedan nearly ended in the same way. The Germans had, with their cavalry, fixed to a man the precise position of their enemy, but no troops were told off to hold them, and all throughout the afternoon of the 31st and morning of the 1st the French army was free to issue from the bridge-head of Torcy on a broad front in *masse de manœuvre* and separate the wings of the Prussian army. Judging by the way they actually fought in the hopeless position in which they elected to remain, their prospects of success in the suggested manœuvre were not small. After the war it was easy and natural to place the blame for the situations in the early days on the shoulders of the German cavalry, but closer study of the facts has shown that in spite of all their shortcomings this arm did not deserve it, for they actually found the enemy and reported his positions, while nothing could be urged against them in respect to Sedan, for by that time they had established a relative superiority over their enemy which

was absolutely crushing. The truth is that the Prussian staff had not realized that cavalry reports alone, even if they arrive in time (which in fact very few ever did), do not afford a sufficient foundation on which to base a manœuvre. If cavalry, three days' march in advance, report the presence of an enemy at a given spot, the fact affords no certain indication of where they may be even on the following day. It is not enough to find an enemy, he must also be fixed and held so that he cannot move; and the three arms, cavalry, artillery and infantry, form the most efficient combination for economically securing this end.

Twenty years at least elapsed before fresh light came; and then it came from France, not from Germany. No one can accuse the Germans of a tendency to sleep on their laurels; on the contrary, no army in history ever set itself to work with greater zeal and industry to profit by the lessons of its campaigns. But it is not in the ranks of the successful that the defects of the military machine are most surely revealed. Moreover, they were dazzled by the very brilliance of their victories, and gratitude to their leaders made them blind to those leaders' faults. The French started their reforms without these disadvantages. The younger officers, who had seen how splendidly the old imperial army had fought, and the spirit with which it had endured the misery brought upon it by the ineptitude of its leaders, felt no desire to shield the reputation of the latter, while the bitterness of the cup they were compelled to drink filled them with the determination and energy necessary to ensure regeneration. They had been beaten by the palpable neglect of their own Napoleonic traditions, and this fact added additional sting to their sufferings. Accordingly a number of the most zealous amongst them banded themselves together to ensure that the reason for their shame should no longer be forgotten. Presently these men assumed, by sheer weight of merit and industry, the practical control of the military history section of the general staff, and here they trained one another for the posts of instructors at the staff college (École de Guerre), whence ultimately the supply of future commanders would be drawn. As a first step in their progress they ransacked the archives of the War Office and subjected the whole correspondence of Napoleon to a critical investigation, exceeding in thoroughness anything it had as yet undergone. This correspondence is incomplete without comparison with the actual reports on which the letters were based and the executive orders issued, which hitherto had never seen the light. From the juxtaposition of the two a connected system was by degrees evolved. As has been indicated above, Napoleon never really appreciated the enormous intellectual gulf which separated him from his marshals. He habitually treated them as enjoying his own clearness of vision in their work, and it is only in his letters to Jerome and Eugène (with whose limitations he was only too well acquainted, but whom he employed because their interests were identical with his own) that he explains things in a form which even a child might understand. From these indications the whole web of the modern doctrine of the École de Guerre was gradually woven, substantially in the form in which we have given it above. With this work the names of Maillard, Langlois, Bonnal, Foch, Colin, Camon, Desbrière and others deserve to be forever associated, for they averted intellectual despair in the nation and rendered it possible for the best minds in the country to continue their labours for its regeneration. Without some such basis hope would have been impossible in face of the ever-growing forces of their watchful antagonist. As matters stand, as long as France can keep her ports open to commerce she cannot be overwhelmed by invasion, for it is a question of time and space; and with her existing network of railway communications, which favour her the more the farther the invaders penetrate, the application of this system promises quite astounding possibilities.

All systems, however, must sooner or later be discovered by the adversary, and require, moreover, adaptation to their surroundings, which may vary from the roadlessness of Poland in 1807 or the United States in 1862 to the highly developed

networks of communications of all kinds existing nowadays in western Europe; and in each, if the war lasts long enough, a deadlock must eventually come until some readaptation of existing means is discovered which suffices to disturb this equilibrium. Wars, however, nowadays are so short that this condition of deadlock can rarely arise. The side which starts with a pronounced superiority, whether due to more perfect organization, better tactics or the systematic training to some secret such as has been indicated above, will generally gain the lead from the outset and will keep it until its forces no longer suffice for the amount of work to be done. Then we get back to hard fighting pure and simple, in which the iron resolution of the commander ultimately decides the issue of events. But this resolution is not, as is generally supposed, a fixed quantity belonging in equal magnitude to the leader at all times and places, but, is perhaps the most variable quantity of all. A human being can only put out a certain quantity of nervous energy or will-power in a given time, and of two men of equal character that one will succumb first upon whom the necessity for rapid decision is most frequently enforced. This holds good of every man throughout the whole army from highest to lowest. In this case the "art of the leader" will undoubtedly consist in adopting as his course of action that one which can be consistently followed without change of mind. Obviously his best course will be to seize the initiative and keep it up to the final act on the battlefield itself. The commander who is caught in the act of concentration or accepting battle of his own free choice cannot tell from one moment to the other at what point the attack may come or whether indeed it is coming at all, and the strain of expectancy is harder to bear than that of continuous action, and spreads also to every rank in his army. It has been held that as a consequence of the increase of range and rapidity of fire of modern weapons the defence has gained so enormously, in power that a commander can accept the risks of a defensive battle with a light heart. This, however, ignores the fact that improved arms will be found in the hands of the assailant also, and every increment of range and rapidity of fire renders it easier to combine the action of many weapons on a single point. Formerly, when bullets barely travelled, with extreme elevation, 1000 yards, and the total artillery train of an army could be numbered in tens, not in hundreds as nowadays, tactical surprise was well-nigh impossible. Troops could always, either by selection of site or clearance around them, ensure that no formidable force could assemble unnoticed within range of their position, while the round shot and the common shell of those days had little power of clearing or levelling solid parapets. Nowadays such selection of site, to say nothing of clearance, is impossible and inconceivable, and once the enemy's mounted men have been compelled to clear the field there is scarcely a limit to the fire power which may be brought into position unnoticed, and thence directed on any chosen point of the enemy's lines. One has but to take the map of Waterloo and its surroundings and consider how it would have facilitated Napoleon's purpose had it been possible for him to prepare the way for his infantry attack by a rain of modern shrapnel and H.E. shells directed from a balloon observatory and coming from every unseen point within a radius of say even 5000 yards. But Napoleon had to wait for several hours till the ground was dry enough to bring up even seventy-two guns to within effective case-shot range. Nowadays he could have switched on his whole two hundred at any moment after daybreak, and his balloon would have told him of the true position of his enemy's reserves. A balloon on the side of the allies could have told them no more than what they already knew, viz. that the whole French army was in front of them; and it is far easier to control and direct fire by observation on the relatively fixed targets which the defence necessarily presents than to do so upon the rapidly moving ones afforded by an assailant. Even where concealment can be practised to the utmost by the defender, and no balloons are available, the power still remains in the hands of the assailant of making any limited area he may choose absolutely untenable; it is only a question of turning on guns enough for the purpose.

But the less time the defender has been allowed in which to improve his position, the more rapidly will a given number of guns achieve the required result; and though we must admit the many difficulties of execution which prevent complete realization of the ideal in practice, yet it is clear that the more closely one can approximate to this ideal, the less the demands which will be made upon the infantry when its turn comes to go forward. This matter is of such importance to the whole subject that we will put it forward in another form. Let us assume that the shells on bursting create only smoke and disturb the dust, delivering no man-killing fragments at all. Still it is clear that, say, 1200 shells a minute bursting over a front of some 600 yards would shroud that front so completely with smoke and dust that its occupants would be quite unable to direct their aim upon the approaching assailants, and under cover of this smoke and dust cloud the latter would be free to carry out what dispositions they might please with the minimum of loss. When finally the shell fire had to be stopped and the smoke lifted, the two infantries would be in presence of one another under conditions which have always been held to offer the maximum guarantee possible to the assailant, viz. an assured numerical superiority disposed in relatively the best positions for the use of their weapons, *i.e.* their fire converging on the point of attack.

From the consequent assault only entrenchments and physically insuperable obstacles (a deep ditch for example) or wire entanglements which require machinery to tear away, can save the defenders. But such obstacles require time for their creation, hence the supreme importance of the utmost possible mobility. Now though in practice every great commander has utilized to the utmost such mobility as he might find in his troops (and by its use he has often, in countries well supplied with roads, succeeded in rendering the erection of entrenchments practically impossible, or in forcing an entrenched enemy to come out and fight in an unprepared position), yet no scientific attempt has hitherto been made to study the whole question of mobility, notwithstanding the fact that the Boer War of 1900-02 proved its importance up to the very hilt. The Boers were wanting in every quality which renders an enemy really formidable except mobility, but because of that supreme qualification and the fact that the enormous area of their country and their exact knowledge of its topography gave them every facility to employ it to the utmost, about nine times their numbers were required to subdue them; and the method ultimately adopted, though freely criticized, was in fact the only one feasible under the circumstances to bring them to a final surrender.

Actually, all systems, the Napoleonic as well as the others, can be defeated finally by an excess of mobility, the exact proportion depending on the topographical nature of the country fought over, the roads available and its extent. So great is its influence that it overrides all changes in armament or in tactics, as was shown in Manchuria in 1904-05, where in spite of both armies, or perhaps better *because* both armies were trained on western European lines, the actual form which the war assumed was that of Marlborough's times. It is sufficient to imagine the Japanese supplied with sufficient pioneer battalions, of the type employed on the Indian frontier, and a first-rate transport corps (which would have doubled their average rate of daily progress), to see how completely the situation would have been altered. They could have reached Mukden in half the time actually required, and would then have possessed a numerical superiority sufficient to ensure for them a second Metz or even a Sedan. It is in this direction that all great progress is to be looked for, but it involves experiment and organization beyond the capacity of any single student. We may, however, indicate the general outline such a development would require. Primarily time is chiefly lost in the hesitation of leaders and in the preparation and circulation of orders. A clear apprehension of the powers which modern weapons confer on the attack will lead to the elimination of the first, and a higher intellectual training of the whole army will materially reduce the second, for the limit to the brevity of orders is fixed by the trained intelligence of the recipients. Napoleon's marshals could move effectively in

response to an order of a couple of sentences; Mack's generals needed fourteen sheets of foolscap.

Next comes the rapidity of movement of the troops themselves when on the road. They cannot march for longer hours than already at times they are called upon to do; but by a better distribution of the weights carried between the men and their transport, they might well cover much more ground in the same time. Here again determination to take the offensive, and to keep it, largely governs the situation. An army determined to attack needs no entrenching gear, certainly not on its men. Its fire is its best protection, and when as in recent campaigns in Bulgaria and the Far East the need for entrenchments has arisen, that has only occurred because the whole weapon of attack, viz. that combination of the three arms which we call an army, was not properly balanced in its parts at those particular moments so as to enable it to maintain its forward impulse. Either, as in Bulgaria, the staff was not up to its duties, or, as in the case of the Japanese, the artillery arm was too slow, or was locally outclassed by the artillery power of its adversary. But in all countries, roadless ones in particular, the progress of the front is conditioned by the efficiency of the transport services in rear, and only because this branch of the army has never received all the attention it deserves has it been necessary to overload the men and horses at the front in the preposterous manner which custom has everywhere sanctioned, which for the most part has been inherited from the time of Marlborough. Over and over again in the past two centuries men have shown that literally only muskets and ammunition are required to win battles, and that a great victory won by rapid marching is by far the most economical use that can be made of human powers. But again and again the pendulum has swung back, and the soldier, in order to be prepared for emergencies which only defeat can bring about, has been burdened down by a weight which has brought him on the field too late and too weary to win it, but in ample time to incur all the penalties of disaster.

In the future in western Europe that army whose transport service, based on motor vehicles and a good road maintenance corps of real working men, will relieve the soldier and his horse (where he has one) of every ounce of superfluous weight, including even in that expression greatcoats and all rounds of ammunition in excess of 120 apiece, and whose men are uniformly trained to the Bersaglieri march (7 m. in one hour or 15 m. in three consecutive hours), will possess a superiority over its adversary which he will require twofold odds to counteract. The suggestion that the ammunition supply should be limited may create surprise, but it is a logical consequence, and precisely one of those points on which the strategist of the future will require a firm conviction. The fundamental fact on which all tactical practice is based is this, that a relatively small loss suddenly inflicted exercises a far greater demoralizing effect upon its recipient than a much heavier punishment extended over a longer period. First-rate troops have often broken back in disorder under a sudden hail of bullets which has swept away not more than 2 to 3% of their strength, whilst exactly similar battalions in the same action have held out all day and remained an efficient fighting body after even 30% had fallen. But, armament being equal, this sudden loss can only be inflicted by placing the troops on the field in the best position possible, relatively to their enemy to derive the full benefit of their fire-power; and mobility is the chief factor in attaining this end. The point is most clearly seen in the case of the action of a well-mounted force against a slow-moving convoy; the convoy forms a target which men can hardly miss; the assailants are a number of dots it is scarcely possible to hit. Two thousand rounds per man of the escort would scarcely suffice to obtain the same results as twenty rounds a man on the side of the assailants. This is a clear illustration of the principle involved, which should always be kept in mind.

Lastly the student should master the elementary principles of railway transportation. The progress since railways were last used in warfare in western Europe has been so enormous that the data supplied therefrom are entirely antiquated, and

there is no indication that any general staff in Europe is alive to the possibilities they present in defence. As already pointed out, the assailant cannot count on their aid once he has penetrated within the enemy's country, and the farther he advances the worse matters become for him. It is enough to consider an invading force based on the east coast of Yorkshire with its head about Leeds; the technical excellence of English railways is so great that 120,000 men with all their share of guns and necessary equipment could be easily transferred say from Glasgow and Edinburgh round to Sheffield in twenty-four hours for a flank attack. Even double that number, from the south of England to the north of Yorkshire, could be moved in the same time. It is not suggested that such movements might be in themselves desirable, but only that in face of such mobility of masses, no calculation of the enemy's movements would be possible.

In conclusion, the man who would fit himself for the highest commands in war, or even for the criticism of those who exercise them, must never for one moment forget that the momentary spirit of the mass he directs is the fundamental condition of the success of every movement. Just as there is no movement so simple that its success may not be jeopardized by ill-will and despondency in execution, there is hardly any limit to what willing men can achieve, and it has been this power of evoking in their commands the spirit of blind trust and confidence that places men like Cromwell, Marlborough, Frederick and Napoleon almost beyond reproach. By the side of this power the technical knowledge and ingenuity displayed in their several undertakings appear quite trivial; probably the same ideas have occurred to thousands of quite mediocre men, but were never put into execution, because they could not count on the whole-souled devotion of their men to execute them. This power is born in a man, not acquired, but even those who possess it in embryo can increase and develop it enormously by a systematic study of the laws which govern the action of humanity in the mass.

From the above we arrive at the following definitions for the terms most generally employed by writers on military history and strategy.

Base.—The point, or line joining a series of points, from whence military operations originate. Ultimately military operations have their inception in an area, *i.e.* a whole country from which organization draws men, arms, food and material of all descriptions, forwarding them through a network of communications—roads, railways, canals, rivers, &c., and delivering them at points as near to the proposed enemy as circumstances render expedient. As an army never has too many men, and normal civil transport is cheaper in every way than military, the tendency is always to maintain the collection of men and materials under civil administration as long as possible. Thus as an army moves forward, settling the district behind it as it advances, the civil administration follows after it, only ceasing to exercise its functions when these can be no longer carried out without military protection. Generally there is a zone in which civil transport and supply exist side by side with military precautions greater or less, but for all practical purposes each column, whatever its strength, has its "base" at that point where the existing magazines are filled by civilian contractors in the ordinary course of trade, and with no extra charge for war risks.

Line of Communication.—The line of communication is the great main road, trunk railway, canal or river, or any combination of these means, for the transport of stores leading from the base to the army at the front. Along these arteries of communication depots are established, military authority commands, and every arrangement is made that foresight can suggest to meet the abnormal demands that a condition of war naturally gives rise to. Napoleon always used the words *route de l'armée*, which conveyed perhaps a clearer idea of the conditions the road or other means of communication had to comply with than the current term. In proportion to the numbers which have to be supplied by this line of communication its importance naturally increases. Thus whereas in 1870 the Germans on the Loire had a choice of magnificent main roads, even of canals and railroads, and if one were temporarily interrupted could switch off the current of supply to another without great inconvenience, the Russians in 1904 were tied to a single railway, any interruption of which must have paralysed altogether their vast army which ultimately numbered 400,000 mouths to be fed. It is clear, therefore, that the importance attaching to the protection of the line of communications must vary in accordance with the nature of the country in which war is carried on, the state of its communications of all sorts, the facility for establishing new ones, and the number of men depending for subsistence on any single road, railway, river or canal.

Line of Operations is a term applied to an imaginary line drawn from the centre of gravity of the army at the front to the country from which it originates. Whereas lines of communication, being dependent on the topographical conformation of the district may be highly circuitous; the line of operations is merely a general direction more convenient to keep in mind than the more complex idea embodied in the former word. Since practically all supply flows to an army along its line or lines of communication, and without them it can only exist for a limited period, practically all situations that can arise in war can be referred to their possible consequences in endangering more or less either one's own communications or those of the enemy. An army is thus said to "form front to a flank" when its communications run parallel to the direction it assumes when facing the enemy (see diagram). It is clear that in case of a defeat at or near *A* the communications are most gravely endangered, hence no commander voluntarily assumes such a position unless he is absolutely confident in the power of his troops to beat the enemy and by so doing places his antagonist in even a worse position in case of defeat. This he can only do by placing himself more or less astride his adversaries' communications, when the latter if beaten is ruined beyond retrieval. Thus in the Marengo campaign, in 1800, Napoleon, in placing himself astride the Austrian communications, was himself compelled to form front to a flank, but this was only possible because the geographical relation of the French and Italian frontiers enabled him from the outset of the campaign to aim a blow in the rear of his opponents' actual front. Under modern conditions such situations in war between two great land powers can hardly arise. The preliminary concentration of armies is arranged in peace in such a manner that both armies will always start with their communications perpendicularly behind them. Hence though the advantage which can be gained by defeating an army when forming front to a flank is equally great, it cannot be attained except by accepting a corresponding risk, and the same holds good if one army places itself astride the communications of another, *e.g.* the Germans at Gravelotte. But when a land army has to deal with a great sea power controlling the vast mercantile navies of the present day, the latter being free to land wherever he pleases can compel his adversary to form front to a flank almost as he pleases. This was the advantage Wellington derived from sea power in the campaign of Vittoria (see PENINSULAR WAR), and there are many theatres of war in which the operation might be repeated nowadays, for though armies have grown tenfold in numbers the means of carrying them with certainty and speed have increased in a yet greater ratio. As between land powers the question may be complicated when the frontier is formed by some great natural obstacle, a great river or range of mountains. There can be an almost infinite range of gradation between the imaginary line marked across a plain by boundary pillars, and the hard and fast distinction drawn between sea and land. The advantage, however, always lies on the side of the nation that possesses behind such barrier the better means of lateral communications. Those on land can never be so good as the sea, but in proportion as they approach that ideal their possessor can transfer masses of men in complete security and comparative secrecy, to whichever portion of the frontier may suit his purpose best.

Exterior Lines.—When armies operate from several bases by lines converging on an army centrally situated as regards them, they are said to operate on exterior lines, and conversely the army operating from a centre against armies converging upon it is said to be acting on "interior lines." The question of the relative superiority of the one form or the other has been discussed above. It is only necessary to point out here that the question again is one of mobility in its widest sense, *i.e.* the mobility resulting from better communications both of intelligence, orders and the actual material forces by which war is made. Owing to the configuration of frontiers, it may be absolutely necessary to attack on exterior lines, but once the convergence these imply has been attained, and a victory won, the advantage of the form, which is derived from the superiority of communications at the disposal of the nation acting from the broader base, passes over to the defender, who destroying all railways, &c. in his retreat, compels the assailant to advance by route marching only, whereas as he, the defender, falls back within his own territory, he preserves unimpeded control over his own railways, and can thus transfer troops from one flank of the assailant to another, as the case may require.

Obstacles.—All obstacles, whether formed by rivers, marshes, forests or mountains, are of value in strategy only in so far as they delay the rapidity of communications by limiting the number of the available means of transport, whether roads or railways, and whatever angle they may form with the line of operations of the contending forces the advantage they offer falls entirely to the side that commands the exits of the defiles by which they are traversed on the farther side. When neither side commands such exits from the outset, the advantage falls to the side which can accumulate first at the desired point of passage a sufficient fire superiority to cover his subsequent necessary operations; in the case of a river, the building of one or several bridges; in the case of a mountain range, the deployment of his advance-guard. In the former case there is no particular reason why the facilities of communication should be greater on one bank than the other. In the latter the

side which has to traverse the mountains (marsh or forest) will always be at a disadvantage for the actual attack, but at an advantage in regard to the secrecy with which he can fall upon the point of his own choice, and the more secure his telegraph lines, the greater will this advantage be. (F. N. M.)

STRATFORD, JOHN DE (d. 1348), archbishop of Canterbury, was born at Stratford-on-Avon and educated at Merton College, Oxford, afterwards entering the service of Edward II. He served as archdeacon of Lincoln, canon of York and dean of the court of arches before 1323, when he became bishop of Winchester, an appointment which was made during his visit to Pope John XXII. at Avignon and which was very much disliked by Edward II. In 1327 the bishop joined Queen Isabella's partisans; he drew up the six articles against Edward II., and was one of those who visited the captive king at Kenilworth to urge him to abdicate in favour of his son. Under Edward III. he became a member of the royal council, but his high political importance dates from the autumn of 1330, the time when Roger Mortimer lost his power. In November of this year Stratford became chancellor, and for the next ten years he was actively engaged in public business, being the king's most prominent adviser and being politically, says Stubbs, the "head of the Lancastrian or constitutional party." In 1333 he was appointed archbishop of Canterbury and he resigned the chancellorship in the following year; however, he held this office again from 1335 to 1337 and for about two months in 1340. In November 1340 Edward III., humiliated, impecunious and angry, returned suddenly to England from Flanders and vented his wrath upon the archbishop's brother, the chancellor, Robert de Stratford. Fearing arrest John de Stratford fled to Canterbury, and entered upon a violent war of words with the king, and by his firm conduct led to the establishment of the principle that peers were only to be tried in full parliament before their own order (*en pleyn parlement et devant les piers*). But good relations were soon restored between the two, and the archbishop acted as president of the council during Edward's absence from England in 1345 and 1346, although he never regained his former position of influence. His concluding years were mainly spent in the discharge of his spiritual duties, and he died at Mayfield in Sussex on the 23rd of August 1348.

John's brother, Robert de Stratford, was also one of Edward III.'s principal ministers. He served for a time as deputy to his brother, and in 1337 became chancellor and bishop of Chichester; he lost the former office in 1340 and died on the 9th of April 1362.

Ralph de Stratford, bishop of London from 1340 until his death at Stepney on the 7th of April 1354, was a member of the same family. All three prelates were benefactors to Stratford-on-Avon.

STRATFORD, a city and port of entry of Ontario, Canada, and capital of Perth county, situated 83 m. W.S.W. of Toronto by the Grand Trunk railway, on the Avon river. Pop. (1901), 9959. The repair and engineering shops of the railway, flour-, saw- and woollen-mills, engine and agricultural implement works are the principal industries. A large export trade in cheese and other dairy and farm produce is carried on.

STRATFORD DE REDCLIFFE, STRATFORD CANNING, VISCOUNT (1786-1880), British diplomatist, was born in Clement's Lane in the city of London, on the 4th of November 1786. His father, Stratford Canning, uncle of George Canning (*q.v.*), had been disinherited for his marriage with Mehetabel Patrick. He settled in London as a merchant. On his death, six months after the birth of his son, his widow took a house at Wanstead near Epping Forest. Stratford Canning was educated first at a dame's school at Wanstead, then at Hackney, and after 1794 at Eton. In 1805 he was elected a scholar of King's College, Cambridge, but he only kept two terms, and in 1807 was appointed précis writer to the foreign office by his cousin George Canning. He received his degree in 1812, residence having been dispensed with on the ground that he was absent on the king's service. In 1807 he went as secretary to Mr Merry on a diplomatic mission to Copenhagen. In 1808 he was appointed first secretary to Mr (afterwards Sir Robert) Adair, who was sent as ambassador to Constantinople. When Mr Adair was transferred to Vienna in 1810, Canning remained at Constantinople as *chargé d'affaires*. The British government was then in the very crisis of its struggle

with Napoleon, and it left Canning entirely to his own discretion. His principal task was to persuade the Turkish government not to show undue favour to the French privateers which swarmed in the Levant. In May 1812 he was able to play the part of "honest broker" in arranging the peace of Bucharest between Turkey and Russia, which left a powerful Russian army free to take part in repelling Napoleon's invasion. Canning was able to hasten the decision of the Turks, by making judicious use of Napoleon's plan for the partition of their empire. A copy of it had been left in his hands by Mr Adair to be used at the proper moment. In July he left Constantinople with the sincere desire never to return, for he was tired of the corrupt and stiff-necked Turkish officials. His ambition was to lead an active career at home. But his success in arranging the treaty of Bucharest had marked him out for diplomatic employment. His absence from home in early youth and the independent position he had held much before the usual age, had in fact disqualified him for the career of a parliamentary party man. By the friendly intervention of Castlereagh, his cousin's old opponent, he received a pension, or rather a retaining fee, of £1200 a year, on the "usual conditions"—which were that he should bind himself to accept the next diplomatic post offered, and should not attempt to enter parliament. Canning spent his leisure in travelling about England, and he wrote some poetry which gained him the praise of Byron, whom he had known in boyhood, and had met in Constantinople. In 1814 he was appointed minister plenipotentiary to Switzerland. In this capacity he had a share in reorganizing the confederacy after the fall of the Napoleonic settlement, and he attended the congress at Vienna. He was an eye-witness of the dramatic change produced at Vienna by Napoleon's return from Elba. Canning retained his post in Switzerland till 1818. In 1816 he married Miss Harriet Raikes, daughter of a governor of the Bank of England. Her death in child-birth in 1818, had a strong influence in inducing him to resign his post, of which he was thoroughly tired. The British minister to Switzerland had merely formal duties to perform in normal times, and the place was wearisome to a man of Canning's capacity and desire for work. In 1819 he was appointed minister at Washington, a station of great difficulty owing to the ill-feeling created by the war of 1812 and the many delicate questions outstanding between the British and the American governments. Canning, whose naturally quick temper had been developed by early independence, came into occasional collision with John Quincy Adams, the American secretary of state, who was, on his own showing, by no means of a patient disposition. Yet the American statesman recognized that the "arrogance" of the British minister was combined with absolute candour and that he was above all petty diplomatic trickery. They parted with mutual respect. Canning returned to England in 1823 on leave and did not go back to Washington. The general treaty he had arranged with Mr Adams was rejected by the United States Senate.

In 1824 Canning was selected as ambassador to Turkey, and proceeded to Constantinople after a preliminary visit to Vienna and St Petersburg. In the Russian capital he was engaged in discussing the arrangement of the Alaska boundary, and partly in sounding the Russian government as to the course to be taken with the Greek revolt against Turkey. He left for Constantinople in October 1825, accompanied by his second wife, the daughter of Mr Alexander of Somerhill near Tonbridge. At Constantinople he was engaged with the ambassadors of France and Russia in an enterprise which he afterwards recognized as having been hopeless from the beginning—namely in endeavouring to induce Sultan Mahmud II. to make concessions to the Greeks, without applying to him the pressure of armed force. After the battle of Navarino (*q.v.*) on the 20th of October 1827, the ambassadors were compelled to retire to Corfu. Here Canning learned that his conduct so far had been approved, but as he desired to know what view was taken of the final rupture with the Porte he came home. He was sent out again on the 8th of July 1828. Canning did not agree on all points with his superior, Lord Aberdeen, and in 1829 he, for the time being, turned from diplomatic to

parliamentary life. He sat for Old Sarum, for Stockbridge (rotten boroughs) and for Southampton, but did not make much mark in parliament. He was twice absent on diplomatic missions. At the end of 1831 he went to Constantinople to attend the conferences on the delimitation of the Greek frontier, arriving immediately after the receipt of the news of Mehemet Ali's invasion of Syria (see MEHEMET ALI). Sultan Mahmud now proposed to Canning an alliance between Great Britain and Turkey, and Canning strongly urged this upon Palmerston, pointing out the advisability of helping the sultan against Mehemet Ali in order to forestall Russia, and of at the same time placating Mehemet Ali by guaranteeing him certain advantages. This advice, which largely anticipated the settlement of 1841, was not followed; but Canning himself was in high favour with the sultan, from whom he received the unique distinction of the sovereign's portrait set in diamonds. In 1833 he was selected as ambassador to Russia, but the tsar Nicholas I. refused to receive him. The story that the tsar was influenced by merely personal animosity seems to be unfounded. Nicholas was no doubt sufficiently informed as to the peremptory character of Sir Stratford Canning (he had been made G.C.B. in 1828) to see his unfitness to represent Great Britain at a really independent court.

After Canning had declined the treasurership of the Household and the governor-generalship of Canada, he was again named ambassador at Constantinople. He reached his post in January 1842 and retained it till his resignation in February 1858. His tenure of office in these years was made remarkable—first by his constant efforts to induce the Turkish government to accept reform and to conduct itself with humanity and decency; then by the Crimean War (*q.v.*). Canning had no original liking for the Turks. He was the first to express an ardent hope that they would be expelled from Europe with "bag and baggage"—a phrase made popular in after times by Gladstone. But he had persuaded himself that under the new sultan Abd-ul-Mejid they might be reformed, and he was willing to play the part of guiding providence. He certainly impressed himself on the Turks, and on all other witnesses, as a strong personality. In particular he struck the imagination of Kinglake, the author of the *Invasion of the Crimea*. In that book he appears as a kind of magician who is always mentioned as the "great Elchi" and who influences the fate of nations by mystic spells cast on pallid sultans. Great Elchi is the Turkish title for an ambassador, and Elchi for a minister plenipotentiary. The use made of the exotic title in Kinglake's book is only one of the Corinthian ornaments of his style. In sober fact Canning's exertions on behalf of reform in Turkey affected little below the surface. His share in the Crimean War cannot be told here. On the fall of Palmerston's ministry in February 1858 he resigned, and though he paid a complimentary farewell visit to Constantinople, he had no further share in public life than the occasional speeches he delivered from his place in the House of Lords. He had been raised to the peerage in 1852. During his later years he wrote several essays collected under the title of *The Eastern Question* (London, 1881). In 1873 he published his treatise, *Why I am a Christian*, and in 1876 his play, *Alfred the Great at Athelney*. The only son of his second marriage died before him. His wife and two daughters survived him. Lord Stratford died on the 14th of August 1880, and was buried at Frant in Sussex. A monument to him was erected in Westminster Abbey in 1884.

See *Life of Lord Stratford de Redcliffe*, by S. Lane Poole (London, 1888).

STRATFORD-ON-AVON, a market town and municipal borough in the Stratford-on-Avon parliamentary division of Warwickshire, England; on a branch line of the Great Western railway and on the East & West Junction railway, in connexion with which it is served from London by the Great Central (92½ m.) and the London & North-Western railways. Pop. (1901), 8310. The town lies mainly on the right (west) bank of the Avon. The neighbourhood, comprised in the rich valley of the Avon, is beautiful though of no considerable elevation. The river

flows in exquisite wooded reaches, navigable only for small boats. The Stratford-on-Avon canal communicates with the Warwick and Birmingham canal. The river is crossed at Stratford by a stone bridge of 14 arches, built by Sir Hugh Clopton in the reign of Henry VII. The church of the Holy Trinity occupies the site of a Saxon monastery, which existed before 691, when the bishop of Worcester received it in exchange from Ethelred, king of Mercia. It is beautifully placed near the river, and is a fine cruciform structure, partly Early English and partly Perpendicular, with a central tower and lofty octagonal spire. It was greatly improved in the reign of Edward III. by John de Stratford, who rebuilt the south aisle. He also in 1332 founded a chantry for priests, and in 1351 Ralph de Stratford built for John's chantry priests "a house of square stone," which came to be known as the college, and in connexion with which the church became collegiate. The present beautiful choir was built by Dean Balshall (1465-1491), and in the reign of Henry VII. the north and south transepts were erected. A window commemorates the Shakespearian scholar J. O. Halliwell-Phillipps. The foundation of the chapel of the gild of the Holy Cross was laid by Robert de Stratford. The gild, to which both sexes were admitted, was in existence early in the 13th century, and it was incorporated by a charter from Edward III. in 1322. It was dissolved in 1547. The guildhall is a picturesque half-timbered building. A beautiful house of the 16th century belonged to one Thomas Rogers, whose daughter was mother of John Harvard, the founder of Harvard College, U.S.A. Among public buildings are the town hall, originally dated 1633, rebuilt 1767, and altered 1863; market house, corn exchange and three hospitals. There are recreation grounds. Brewing is carried on, but the trade is principally agricultural. Area, 4013 acres.

Shakespearian Connexion.—To no town has the memory of one famous son brought wider notoriety than that which the memory of William Shakespeare has brought to Stratford; yet this notoriety sprang into strong growth only towards the end of the 18th century. The task of preserving for modern eyes the buildings which Shakespeare himself saw was not entered upon until much of the visible connexion with his times had been destroyed. Yet the town is under no great industrial or other modernizing influence, and therefore stands in the position of an ancient shrine, drawing a pilgrimage of modern origin. The plan of Shakespeare's Stratford at least is preserved, for the road crossing Clopton's bridge is an ancient highway, and forks in the midst of the town into three great branches, about which the village grew up. The high cross no longer stands at the marketplace where these roads converged. But the open space where is now a memorial fountain was the Rother market, and Rother Street preserves its name. The word signifies horned cattle, and is found in Shakespeare's own writing, in the restored line "It is the pasture lards the rother's sides" (*Timon of Athens*), where "brother's" was originally the accredited reading. In Henley Street, close by, is the house in which the poet was born, greatly altered in external appearance, being actually two half-timbered cottages connected. A small apartment is by immemorial tradition shown as his birth-room, bearing on its white-washed walls and its windows innumerable signatures of visitors, among which such names as Walter Scott, Dickens and Thackeray may be deciphered. Part of the building, used by the poet's father as a wool-shop, is fitted as a museum. Shakespeare may have attended the grammar school attached to the old guildhall in Church Street. This was a foundation in connexion with the gild of the Holy Cross, but was refounded after the dissolution by King Edward VI. in 1553, and bears his name. The site of Shakespeare's house, New Place, bought by him in 1597, was acquired by public subscription, chiefly through the exertions of J. O. Halliwell-Phillipps, and was handed over to the trustees of the birthplace in 1876. The house was built by Sir Hugh Clopton. Shakespeare acquired a considerable property adjacent to it, retired here after his active life in London, and here died. Sir John Clopton destroyed the house in 1702 (as it had reverted to his family), and the mansion he built was in turn destroyed by Sir Francis Gastrell in 1759. The site, which is

traceable, is surrounded by gardens. Shakespeare is buried in the chancel of Holy Trinity church, his wife lying next to him. The slab over the poet's grave bears the lines beginning

" Good friend, for Jesus' sake forbear
To dig the dust enclosed here ";

while the effigy on the mural monument above may well be an authentic representation, though somewhat altered and damaged by time and restoration (see SHAKESPEARE: *Portraits*).

Apart from the interest attaching to the pleasant country town and its pastoral environment, through their influence traceable in Shakespeare's writings, there are further connexions with himself and his family to be found. The house adjacent to New Place known as Nash's house was that of Thomas Nash, who married Shakespeare's granddaughter Elizabeth Hall; it is used as a museum. At Shottery, 1 m. west of Stratford, is the picturesque thatched cottage in which Shakespeare's wife, Anne Hathaway, was born. It was purchased for the nation in 1892. The maiden name of the poet's mother was Mary Arden, and this name, that of an ancient county family, survives in the district north-west of Stratford, the Forest of Arden, though the true forest character is long lost. At Snitterfield to the north, where the low wooded hills begin to rise from the valley, lived Shakespeare's grandfather and uncle.

The principal modern monument to the poet's memory in Stratford is the Shakespeare Memorial, a semi-Gothic building of brick, stone and timber, erected in 1877 to contain a theatre, picture gallery and library. A performance of one of the plays is given annually. The memorial stands by the river above the church, and above again lie the Bancroft or Bankcroft gardens where, in 1769, a celebration in honour of the poet was organized by David Garrick. Evidence of the intense interest taken by American visitors in Stratford is seen in the memorial fountain and clock-tower presented in 1887, and in a window in the church illustrating scenes from the Incarnation and containing figures from English and American history.

History.—Stratford-on-Avon (*Stradforde, Trafford, Strafford-on-Avon*) is a place of great antiquity. A Roman road may have run past the site; coins, &c., have been found, and the district at any rate was inhabited in Roman times. The manor was granted by King Offa to the bishopric of Worcester; and it was under the protection of the bishops of Worcester, who were granting them privileges as early as the reign of Richard I., that the inhabitants of the town assumed burghal rights at an early date. The Gild of the Holy Cross, founded in the 13th century for the support of poor priests and others, exercised great authority over the town for many years. Its dissolution was the cause of the incorporation charter of Edward VI. in 1553, by which the town was incorporated under the title of the bailiff and burgesses, who were to bear the name of aldermen. Another charter, confirming former liberties but altering the constitution of the corporation, was granted in 1611. By the charters of 1664 and 1674 the corporation was given the title of mayor, aldermen and burgesses. The governing body now consists of a mayor, 6 aldermen and 18 councillors. A market, formerly held on Thursdays by a grant of 1309, is now held on Fridays. The various trades of weaving, saddlery, glove-making, collar-making, candle-making and soap-making were carried on during the 16th, 17th and 18th centuries, but have lost their importance.

STRATHAVEN (locally pronounced *Strævn*), a manufacturing and market town of Lanarkshire, Scotland. Pop. (1901), 4076. It lies on the Avon, 16 m. S.S.E. of Glasgow by road, and is the terminus of the Caledonian Railway Company's branch line from Hamilton. It has manufactures of silk, cotton and hosiery and is a market for cheese and grain. The picturesque ruins of Avondale Castle are situated on Powmilion Burn, a stream that runs through Strathaven to join the Avon, a mile below the town. Remains of a Roman road are traceable for several miles immediately to the south of the Avon. Stonehouse (pop. 2961), a mining and weaving town about 4 m. north-west, is claimed as the birthplace of the Scottish martyr, Patrick Hamilton (1504-1528). Six miles south-west of Strathaven, on the

moor of Drumclog, the Covenanters defeated John Graham of Claverhouse, Viscount Dundee, on the 1st of June 1679. A granite obelisk commemorates the battle, but the religious meetings that used to take place on the anniversary are no longer held.

STRATHCLYDE, the name given in the 9th and 10th centuries to the British (Welsh) kingdom, which from the 7th century onwards was probably confined to the basin of the Clyde, together with the adjacent coast districts, Ayrshire, &c., on the west of Scotland. Its capital was Dumbarton (fortress of the Britons), then known as Alclyde. On the south this kingdom bordered on the territories of the Niduari Picts of Galloway, including the modern counties of Wigtown and Kirkcudbright, a region which from the middle of the 7th century seems to have been in the possession of the Northumbrians. Strathclyde is also sometimes called Cumbria, or Cumberland, and the survival of the latter name on the English side of the border preserves the memory of a period when the territories of the northern Welsh were of much greater extent, though it is perhaps not certain that the race possessed political unity at that time. Of the origin of the kingdom of the North Britons we have no information, but there seems little reason to doubt that they were the dominant people in southern Scotland before the Roman invasion.

After the withdrawal of the Romans in the 5th century the northern Britons seem to have shown greater determination in maintaining their independence than any of the southern kingdoms and, according to Welsh tradition, Cunedda, the ancestor of the kings of Gwynedd, had himself come from the north. In the *Historia brittonum* we read of several princes of the northern Britons. The chief of these appear to have been Urien, who is said to have fought against the Northumbrian king Theodoric, and Rhydderch Hen who is mentioned also in Adamnan's Life of S. Columba. Rhydderch Hen appears to have secured the supremacy amongst these Welsh princes after the great battle of Ardderyd fought about the year 573, to which frequent reference is made in early Welsh poetry. His death seems to have taken place in 603. A late authority states that he was succeeded by his son Constantine, but the subsequent kings were descended from another branch of the same family.

Such notices as we have of the history of Strathclyde in the 7th and 8th centuries are preserved only in the chronicles of the surrounding nations and even these supply us with little more than an incomplete record of wars with the neighbouring Scots, Picts and Northumbrians. It is probable that the Britons were allied with the Scots when Aidan, the king of the latter, invaded Northumbria in A.D. 597. In 642, however, we find the two Celtic peoples at war with one another, for in that year the Britons under their king Owen defeated and slew the Scottish king Domnall Breac. In the same year they came into conflict with the Northumbrian king Oswio. In 649 there appears to have been a battle between the Britons and the Picts, but about this time the former must have become subject to the Northumbrian kingdom. They recovered their independence, however, after the defeat of Ecgrith by the Picts in 685. In 711 and again in 717 we hear of further wars between the Britons and the Scots of Dalriada, the former being defeated in both years. Towards the middle of the 8th century Strathclyde was again threatened by an alliance between the Northumbrians and Picts, and in 750 the Northumbrian king Eadberht wrested from them a considerable part of their territories in the west including Kyle in Ayrshire. In 756 the North Britons are said to have been forced into submission and from this time onwards we hear very little of their history, though occasional references to the deaths of their kings show that the kingdom still continued to exist.

In 870 Dumbarton was attacked and destroyed after four months' siege by the Scandinavian king Ivarr, and for some time after this the country was exposed to ravages by the Norsemen. It is believed that the native dynasty came to an end early in the 10th century and that the subsequent kings belonged to a branch of the Scottish royal family. At the end of the reign of Edward the Elder (925) the Britons of Strathclyde submitted to that king together with all the other princes of the north.

In the reign of his successor Æthelstan, however, they joined with the Scots and Norwegians in attempts to overthrow the English supremacy, attempts which were ended by their defeat at the battle of Brunanburh in 937. In 945-46 Strathclyde was ravaged by King Edmund and given over to the Scottish king Malcolm I. The fall of the kingdom was only temporary, for we hear of a defeat of the Scottish king Cuilean by the Britons in 971. In the 11th century Strathclyde appears to have been finally incorporated in the Scottish kingdom, and the last time we hear of one of its kings is at the battle of Carham in 1018 when the British king Owen fought in alliance with Malcolm II.

The following is a list of kings whose names are mentioned in the chronicles:—

Rhydderch Hen	d. 603
Constantine son of Rhydderch (?)	—
Iudruis (?)	d. 633
Owain (Eugein)	d. 642
Gwraid (Gureit)	d. 658
Dyfnwal (Domhnall), son of Owain	d. 694
Beli, son of Elphin	d. 722
Tewdwr (Teudubr), son of Beli	d. 750
Dyfnwal (Dannagual), son of Tewdwr	d. 760
Cynan, son of Ruadrach	d. 816
Artgha	d. 872
Run, son of Artgha	d. before 878 (?)
Dyfnwal (Donevaldus)	d. 908
Dyfnwal (Donevaldus), son of Éde (Aedh) Owain	d. 934
Dyfnwal (Domhnall), son of Eoghain (on pilgrimage)	d. 975
Malcolm, son of Dyfnwal	d. 997
Owain (Eugenius)	1018

See *Chronicles of the Picts and Scots*, edited by W. F. Skene (Edinburgh, 1867); W. F. Skene, *Celtic Scotland* (Edinburgh, 1876); and Sir John Rhys, *Celtic Britain* (London, 1904).

(F. G. M. B.)

STRATHCONA AND MOUNT ROYAL, DONALD ALEXANDER SMITH, BARON (1820—), Canadian statesman and financier, was born at Forres, Scotland, on the 6th of August 1820, the second son of Alexander Smith (d. 1850), a Highland merchant. His mother, Barbara Stewart, of Abernethy, was the sister of John Stewart (d. 1847), a famous fur trader in the Canadian North-West, who gave his name to Stewart Lake and Stewart river. Through him Donald Smith was appointed in 1838 a junior clerk in the Hudson's Bay Company, which at that time controlled the greater part of what is now the Dominion of Canada. Smith was sent to Labrador, and stationed at Hamilton Inlet. For thirteen years he roughed it there, mastering the work of the fur trade, introducing various improvements into the conditions of life, being the first to prove that potatoes and other vegetables could be grown with success on that bleak coast, and varying his business routine with much reading and letter-writing. Then he was for ten years on Hudson Bay, rising in the company's service to be a chief trader and then a chief factor. In 1868 he was appointed to the post of resident governor, with headquarters at Montreal. In the next year Louis Riel's (*q.v.*) rebellion broke out on the Red river, caused chiefly by the transfer of territorial rights from the company to the Dominion of Canada, and in December Smith was sent by the Canadian government with wide powers as special commissioner to endeavour to check the rebellion, and to report "on the best mode of quieting and removing such discontent and dissatisfaction." On arriving at Fort Garry (now Winnipeg) he advised the government that it would be necessary to send troops; in the meanwhile he kept cool in face of a very ugly situation, and it was largely owing to his tact and diplomacy that the lives of the numerous prisoners were saved, that Riel's position was gradually undermined and that the relief expedition under Colonel (afterwards Lord) Wolseley had no fighting to do. Apart from the rebellion, there was difficulty with the company's traders. The company's control over the North-West was to be surrendered to Canada for £300,000, certain grants of lands and certain trading privileges, and the traders on the spot feared that in the distribution of the money their rights might not be guarded, but Smith succeeded in persuading them to trust him to secure their share, and asserted their claims so effectually that £107,000 was paid to them. During these complications in the North-West he occupied for a time the position of acting governor: in December 1870, on the

first election to the legislative assembly of the new province of Manitoba, he was returned for Winnipeg; and in March 1871, after a very bitter contest, he was elected as one of the four Manitoba representatives to the Dominion House of Commons, as member for Selkirk. The reorganization of the Hudson's Bay Company in 1871—involving the loss of its administrative functions and its restriction to questions of trade only—made it necessary to appoint a chief commissioner for the North-West, and in 1871 Smith received the appointment when in London, after his championship of the claims of the local traders. At Ottawa he at once became the spokesman of the new territories, though for a time subject to the suspicion of those who thought that the company had done too little to assist the Canadian government against Riel, and he was frequently attacked in parliament and out of it on various charges. In 1872 he became one of the original members of the first North-West council under the act providing for the government of the territories by the lieutenant-governor of Manitoba and a council of eleven.

It was at this time that the construction of the Canadian Pacific railway became a practical question. The terms of the entrance of British Columbia into the Dominion in 1871 included a stipulation for the immediate beginning of a railway from the Pacific towards the Rocky Mountains, and from a point to be selected east of the Rockies towards the Pacific; this line, connecting the Pacific seaboard with eastern Canada, was to be completed within ten years from the date of union. After a controversy on the merits of private or government construction, in 1872 a charter was given by Sir John Macdonald's government to a company, with Sir Hugh Allan at its head, for the construction of the line, with a subsidy in land grants and money, but in 1873 disclosures of corrupt practices in relation to this charter (the so-called Pacific Scandal) led to the fall of the government, and the company was soon afterwards dissolved. In the great debate which ended in the resignation of the government, one of the chief causes of its downfall was a moderate but powerful speech by Smith, which led to a temporary estrangement between him and Macdonald. The Liberal government which came into power early in 1874 reverted, though timidly, to the policy of government ownership.

Meanwhile Donald Smith, together with his cousin Mr George Stephen (afterwards Lord Mountstephen), and other Canadian and American financiers, had bought out the Dutch bondholders of the insolvent St Paul & Pacific railway, an American line, which by 1873 had been completed from St Paul to Breckenridge, but which lacked funds to proceed farther. After long negotiations the new owners persuaded the government of Manitoba to build a line from Winnipeg to Pembina on the American frontier. This done, in 1879 the partners formed the St Paul, Minneapolis & Manitoba Railway Company, and by continuing the line from Breckenridge to Pembina united Manitoba with the south and west.

In 1878 the Liberal party was defeated, and Sir John Macdonald returned to office with the support of Smith, who had been driven to rejoin the Conservatives by the over-cautious railway policy of the Liberals. In 1880 the new government made a contract for building the railway with a syndicate of which Stephen was the chief director, and in which Smith, from the first largely interested, came more and more to the front. Both were prominent directors of the Bank of Montreal, and employed its resources in the work without hesitation. Smith also embarked in the work the whole of his private fortune, and it was his dogged perseverance which more than anything else enabled the company to bring its work to a successful conclusion. The contract allowed ten years for the completion of the line, but such energy was shown that on the 7th of November 1885, at Craigellachie in the Rocky Mountains, Donald Smith drove home the last spike of the first Canadian transcontinental railway. In 1882 he left parliament, but returned to it in 1887, and represented Montreal West till 1896, when he was appointed to succeed Sir Charles Tupper in London as high commissioner for Canada. In that year he was made G.C.M.G.; in 1897 he was raised to the peerage and in 1909 made G.C.V.O. In 1889 he became governor of the Hudson's Bay

Company. On the 21st of March 1896 he was appointed government commissioner to Manitoba and the Territories to endeavour to lessen the bitterness in the discussion as to Roman Catholic rights in the public schools, and the compromise of 1897 followed the lines which he suggested (see CANADA).

In January 1900, during the war in South Africa, he raised, equipped and presented to the British government a regiment of irregular cavalry 600 strong. Strathcona's Horse, as it was called, was recruited in the Canadian West, and did good service during the war. Though this was perhaps the most striking of the many services which his great wealth enabled him to do for Canada and the British Empire, he left no side of Canadian life untouched. With his cousin, Lord Mountstephen, he founded and endowed the Royal Victoria Hospital in Montreal, and both in Canada and in Scotland gave largely and wisely to university work. He was the backbone of the emigration policy which from 1896 on did much to increase the population and the prosperity of Canada. He helped in the improvement of the waterways of the Canadian West, and in placing steamers on them, and gave much assistance to the proposed All Red Route of British-owned steamers, encircling the world. From the first he was a member of the Pacific Cable Board, controlling the cable laid in 1902 by the combined governments of Great Britain, Canada and Australia. No man did more to tighten the ties which bind Canada to the British Empire.

The *Life* by Beckles Willson contains some useful information. The *Histories of the Hudson's Bay Company* by Beckles Willson, Rev. George Bryce and Miss Agnes C. Laut tell his early struggles. *Sir Wilfrid Laurier* (2 vols.), by J. S. Willison, describes the financial dealings between the Canadian government and the Canadian Pacific railway. His parliamentary speeches are in the *Canadian Hansard*. (W. L. G.)

STRATHNAIRN, HUGH HENRY ROSE, 1ST BARON (1801-1885), British field-marshal, third son of the Right Hon. Sir George Henry Rose of Sandhills, Christchurch, Hampshire (minister plenipotentiary at the Prussian court), was born at Berlin on the 6th of April 1801. He was educated at Berlin, and received military instruction at the cadet school. He entered the 93rd Sutherland Highlanders as an ensign on the 8th of June 1820, but was transferred to the 19th Foot, then quartered in Ireland, and took part in preserving order during the "Ribbon" outrages. He was promoted rapidly, to a lieutenantancy in 1821, a captaincy in 1824, and an unattached majority at the end of 1826. He was brought into the 92nd Highlanders as a regimental major in 1829, and the following year was appointed equerry to H.R.H. the duke of Cambridge. The 92nd Highlanders were in Ireland, and Rose again found himself employed in maintaining law and order. He rendered important services in suppressing disaffected meetings, but his conduct was so courteous to the ringleaders that he incurred no personal hostility. In 1833 he accompanied his regiment to Gibraltar, and three years later to Malta, where he exerted himself with so much zeal during a serious outbreak of cholera in attending to the sick soldiers that his conduct elicited an official approval from the governor and commander-in-chief. In 1839 he was promoted, by purchase, to an unattached lieutenant-colonelcy. In the following year Rose was selected, with other officers and detachments of Royal Artillery and Royal Engineers, for special service in Syria under the orders of the foreign office. They were to co-operate on shore, under Brigadier-General Michell, R.A.—in conjunction with the Turkish troops—with the British fleet on the coast, for the expulsion of Mehemet Ali's Egyptian army from Syria. Sir Stratford Canning sent Rose from Constantinople on a diplomatic mission to Ibrahim Pasha, commanding the Egyptian army in Syria, and after its execution he was attached, as deputy adjutant-general, to the staff of Omar Pasha, who landed at Jaffa with a large Turkish force from the British fleet. Rose distinguished himself in several engagements, and was twice wounded at El Mesden in January 1841. He was mentioned in despatches, and received from the sultan the order of Nishan Ifthar in diamonds, the war medal and a sabre of honour. The king of Prussia sent him the order of St John, and expressed his pleasure that "an early acquaintance" had so gallantly dis-

tinguished himself. Shortly after he succeeded to the command of the British detachment in Syria with the local rank of colonel, and in April 1841 he was appointed British consul-general for Syria. For seven years, amidst political complications and intrigues, Rose, by his energy and force of character, did much to arrest the horrors of civil war, to prevent the feuds between the Maronites and Druses coming to a head, and to administer justice impartially. On one occasion in 1841, when he found the Maronites and Druses drawn up in two lines and firing at each other, he rode between them at imminent risk to his life, and by the sheer force of a stronger will stopped the conflict. In the first year of his appointment his action saved the lives of several hundred Christians at Deir el Khama, in the Lebanon, and his services were warmly recognized by Lord Aberdeen in the House of Lords, and he was made C.B. In 1845, by his promptness and energy, at great personal risk, he rescued 600 Christians belonging to the American mission at Abaye, in the Lebanon, from the hands of the Druses, and brought them to Beirut. In 1848, during the outbreak of cholera at Beirut, he was most devoted in his attention to the sick and dying.

At the end of this year he left Syria on leave of absence, and did not return, as Lord Palmerston appointed him secretary of embassy at Constantinople in January 1851. In the following year he was chargé d'affaires in the absence of Sir Stratford Canning during the crisis of the question of the "holy places," and he so strengthened the hands of the Porte by his determined action that the Russian attempt to force a secret treaty upon Turkey was foiled. During the war with Russia in 1854-56 Rose was the British commissioner at the headquarters of the French army, with the local rank of brigadier-general. At Varna he succeeded in quenching a fire which threatened the French small-armed ammunition stores, and received the thanks of Marshal St Arnaud, who recommended him for the Legion of Honour. He was present at the battle of the Alma, and was wounded on the following day. At Inkerman he reconnoitred the ground between the British and French armies with great *sang-froid* under a withering fire from the Russian pickets, and his horse was shot under him. He distinguished himself on several other occasions in maintaining verbal communication between the allied forces, and by his tact and judgment contributed to the good feeling that existed between the two armies. His services were brought to notice by the commanders-in-chief of both armies, and he received the medal with three clasps and the thanks of parliament, was promoted to be major-general, and was made K.C.B. and commander of the Legion of Honour. On the outbreak of the Indian Mutiny in 1857 Rose was given command of the Poona division. He arrived in September, and shortly after took command of the Central India force. In January 1858 he marched from Mhow, captured Rathgarh after a short siege, and defeated the raja of Banpur near Barodia in the same month. He then relieved Saugor, captured Garhakota and the fort of Barodia, and early in March defeated the rebels in the Madanpur Pass and captured Madanpur and Chanderi. He arrived before Jhansi on the 20th of March, and during its investment defeated a relieving force under Tantia Topi at the Betwa on the 1st of April. Most of Rose's force was locked up in the investment, and to Tantia Topi's army of 20,000 he could only oppose 1500 men; yet with this small force he routed the enemy with a loss of 1500 men and all their stores. Jhansi was stormed and the greater part of the city taken on the 3rd, and the rest the following day, and the fort occupied on the 5th. Kunch was captured, after severe fighting in a temperature of 110° in the shade, on the 7th of May. Rose himself was only able to hold out by medical treatment, and many casualties occurred from the great heat. Under the same conditions the march was made on Kalpi. The rebels came out in multitudes on the 22nd of May to attack his small force, exhausted by hard marching and weakened by sickness, but after a severe fight under a burning sun, and in a suffocating hot wind, were utterly routed and Kalpi occupied the following day. Having completed his programme, Rose obtained sick leave, and Sir Robert Napier (*q.v.*) was appointed to succeed him, when news came of the defection of Sindhia's troops and the

occupation of Gwalior by Tantia Topi. Rose at once resumed command and moved on Gwalior by forced marches, and on the 16th of June won the battle of Morar. Leaving Napier there, he attacked Gwalior on the 19th, when the city was captured. The fortress was stormed and won the following day, and Napier gained a signal victory over the flying enemy at Jaora-Alipur on the 22nd. Rose then made over the command to Napier and returned to Poona. It was to Rose's military genius that the suppression of the Indian Mutiny was largely due; but owing to official jealousy his outstanding merit was not fully recognized at the time. For his services he received the medal with clasp, the thanks of both houses of parliament, the regimental colonelcy of the 45th Foot, and was created G.C.B. By a legal quibble the Central India force, after protracted litigation, was not allowed its share of prize-money, a loss to Rose of £30,000. Rose was promoted lieutenant-general for his "eminent services" in February 1860, and the next month was appointed commander-in-chief of the Bombay army, and on the departure of Lord Clyde from India in the following June he succeeded him as commander-in-chief in India. During his tenure of the command-in-chief Rose improved the discipline of the army, while his powerful assistance enabled the changes consequent upon the amalgamation of the East India Company's army with the Queen's army to be carried out without friction. He was created K.C.S.I. in 1861 and G.C.S.I. on the enlargement of the order. On his return home he was made an honorary D.C.L. of Oxford University.

Rose held the Irish command from 1865 until 1870, was raised to the peerage in 1866 as Baron Strathnairn of Strathnairn and Jhansi, transferred to the colonelcy of the 92nd Foot, and appointed president of the army transport committee. By a good organization and disposition of the troops under his command in 1866 and 1867 he enabled the Irish government to deal successfully with the Fenian conspiracy. He was promoted general in 1867. On relinquishing the Irish command he was made an honorary LL.D. of Trinity College, Dublin. For the rest of his days he lived generally in London. He was gazetted to the colonelcy of the Royal Horse Guards in 1869, and promoted to be field marshal in June 1877. He died in Paris on the 16th of October 1885, and was buried with military honours in the graveyard of the Priory Church, Christchurch, Hampshire. An equestrian bronze statue, by E. Onslow Ford, R.A., was erected to his memory at Knightsbridge, London. He was never married.

See Sir Owen Tudor Burne, *Clyde and Strathnairn, "Rulers of India Series"* (1891). (R. H. V.)

STRATHPEFFER, a village and spa of the county of Ross and Cromarty, Scotland, 5 m. W. of Dingwall by a branch of the Highland railway. Pop. (1901), 354. It lies in a valley of varying elevation (200 to 400 ft. above the sea), but is sheltered on the west and north and has a comparatively dry and warm climate. There are several sulphurous springs—one saline, another strongly impregnated with sulphuretted hydrogen—in great repute for gout, rheumatism, skin diseases and affections of the liver and kidneys. The well of effervescent chalybeate water is largely resorted to for anaemia and as a tonic. A peat bath, similar to those at Franzensbad in Bohemia, has also been established. The season runs from May to October, and during the past few years Strathpeffer has become a very popular resort. The pump-room (1829) and pavilion (1881) are situated in the middle of the village. Castle Leod (pron. *Loud*), a seat of the countess of Cromartie, upon whose property Strathpeffer is built, lies a mile to the north and is an example of the Scots Baronial style dating from 1660. The village was the scene of the fight between the Mackenzies and Macdonalds in 1478, and later between the Mackenzies and the Munros. The Mackenzies prevailed in both encounters. The ascent of Ben Wyvis (3429 ft.) is commonly made from Strathpeffer.

STRAUBING, a town of Germany, in the kingdom of Bavaria, pleasantly situated in a fertile plain, on the right bank of the Danube, here crossed by two bridges, 25 m. S.E. of Regensburg,

on the railway to Passau. Pop. (1905), 20,856, nearly all of whom are Roman Catholics. Its oldest and most characteristic building is the tall square tower with its five pointed turrets, dating from 1208. It has eight Roman Catholic churches, among them being the church of St James, a handsome Late Gothic edifice, with some paintings ascribed to Wohlgemuth; the old Carmelite church containing a monument to Duke Albert II. of Bavaria; and that of St Peter with the tomb of Agnes Bernauer. It has also a Gothic town-hall, a castle, now used as barracks, and two fine squares. The numerous educational establishments include a gymnasium, an episcopal seminary for boys and a normal school. The industries of Straubing are tanning and brewing, the manufacture of bricks and cement, and trade in grain and cattle. Straubing is a town of remote origin, believed to be identical with the Roman station of *Sorbiodurum*. In definite history, however, it is known only as a Bavarian town, and from 1353 to 1425 it was the seat of the ducal line of Bavaria-Straubing. Its chief historical interest attaches to its connexion with the unfortunate Agnes Bernauer (*q.v.*), who lived at the chateau here with her husband Duke Albert III.

See Wimmer, *Sammelblätter zur Geschichte der Stadt Straubing* (Straubing, 1882-1884), and Ortner, *Straubing in seiner Vergangenheit und Gegenwart* (Straubing, 1902).

STRAUS, LUDWIG (1835-1899), Austrian violinist, was born at Pressburg on the 28th of March 1835. He studied at the Vienna Conservatorium from 1843 to 1848, as a pupil of Böhm; made his first appearance in 1850, and five years afterwards made a tour in Italy; in 1857 he became acquainted with his lifelong friend, the 'cellist Piatti, and toured with him in Germany and Sweden. From 1860 to 1864 he was concert-meister at Frankfort, and during these years he visited England frequently, in the year 1864 taking up his residence there. He was for many years leader of Hallé's orchestra in Manchester, and a familiar figure at the Popular Concerts in London. He was first violin in the Queen's Band. He retired, owing to ill health, in 1893, and from that time till his death, on the 23rd of October 1899, lived at Cambridge. His playing, whether of violin or viola, had very great qualities; he was perfect in ensemble, and his power of self-effacement was of a piece with his gentle disposition and with the pure love of art which distinguished him through life. A more lovable nature never existed, and his quiet influence on the art of his time was very great.

STRAUSS, DAVID FRIEDRICH (1808-1874), German theologian and man of letters, was born at Ludwigsburg, near Stuttgart, on the 27th of January 1808. In his thirteenth year he was sent to the evangelical seminary at Blaubeuren, near Ulm, to be prepared for the study of theology. Amongst the principal masters in the school were Professors Kern and F. C. Baur, who infused into their pupils above all a deep love of the ancient classics. In 1825 Strauss passed from school to the university of Tübingen. The professors of philosophy there failed to interest him, but he was strongly attracted by the writings of Schleiermacher, which awoke his keen dialectical faculty and delivered him from the vagueness and exaggerations of romantic and somnambulistic mysticism. In 1830 he became assistant to a country clergyman, and nine months later accepted the post of professor in the high school at Maulbronn, having to teach Latin, history and Hebrew. In October 1831 he resigned his office in order to study under Schleiermacher and Hegel in Berlin. Hegel died just as he arrived, and, though he regularly attended Schleiermacher's lectures, it was only those on the life of Jesus which exercised a very powerful influence upon him. It was amongst the followers of Hegel that he found kindred spirits. Under the leading of Hegel's distinction, between *Vorstellung* and *Begriff*, he had already conceived the idea of his two principal theological works—the *Leben Jesu* and the *Christliche Dogmatik*. In 1832 he returned to Tübingen and became repetent in the university, lecturing on logic, history of philosophy, Plato, and history of ethics, with great success. But in the autumn of 1833 he resigned this position in order to devote all his time to the completion of his projected

Leben Jesu (1835). The work produced an immense sensation and created a new epoch in the treatment of the rise of Christianity. In 1837 Strauss replied to his critics (*Streitschriften zur Verteidigung meiner Schrift über das Leben Jesu*). In the third edition of the work (1839), and in *Zwei friedliche Blätter*, he made important concessions to his critics, which he withdrew, however, in the fourth edition (1840; translated into English by George Eliot, with Latin preface by Strauss, 1846). In 1840 and the following year he published his *Christliche Glaubenslehre* (2 vols.), the principle of which is that the history of Christian doctrines is their disintegration. Between the publication of this work and that of the *Friedliche Blätter* he had been elected to a chair of theology in the university of Zürich. But the appointment provoked such a storm of popular ill will in the canton that the authorities considered it wise to pension him before he entered upon his duties, although this concession came too late to save the government. With his *Glaubenslehre* he took leave of theology for upwards of twenty years. In August 1841 he married Agnes Schebest, a cultivated and beautiful opera singer of high repute, but not adapted to be the wife of a scholar and literary man like Strauss. Five years afterwards, when two children had been born, a separation by arrangement was made. Strauss resumed his literary activity by the publication of *Der Romantiker auf dem Thron der Cäsaren*, in which he drew a satirical parallel between Julian the Apostate and Frederick William IV. of Prussia (1847). In 1848 he was nominated as member of the Frankfort parliament, but was defeated. He was elected for the Württemberg chamber, but his action was so conservative that his constituents requested him to resign his seat. He forgot his political disappointments in the production of a series of biographical works, which secured for him a permanent place in German literature (*Schubarts Leben*, 2 vols., 1849; *Christian Märklin*, 1851; *Nikodemus Frischlin*, 1855; *Ulrich von Hutten*, 3 vols., 1858–1860, 6th ed. 1895; *H. S. Reimarus*, 1862). With this last-named work he returned to theology, and two years afterwards (1864) published his *Leben Jesu für das deutsche Volk* (13th ed., 1904). It failed to produce an effect comparable with that of the first *Life*, but the replies to it were many, and Strauss answered them in his pamphlet *Die Halben und die Ganzen* (1865), directed specially against Schenkel and Hengstenberg. His *Christus des Glaubens und der Jesus der Geschichte* (1865) is a severe criticism of Schleiermacher's lectures on the life of Jesus, which were then first published. From 1865 to 1872 Strauss resided in Darmstadt, and in 1870 published his lectures on *Voltaire* (9th ed., 1907). His last work, *Der alte und der neue Glaube* (1872; 16th ed., 1904; English translation by M. Blind, 1873), produced almost as great a sensation as his *Life of Jesus*, and not least amongst Strauss's own friends, who wondered at his one-sided view of Christianity and his professed abandonment of spiritual philosophy for the materialism of modern science. To the fourth edition of the book he added a *Nachwort als Vorwort* (1873). The same year symptoms of a fatal malady appeared, and death followed on the 8th of February 1874.

Strauss's mind was almost exclusively analytical and critical, without depth of religious feeling or philosophical penetration, or historical sympathy; his work was accordingly rarely constructive. His *Life of Jesus* was directed against not only the traditional orthodox view of the Gospel narratives, but likewise the rationalistic treatment of them, whether after the manner of Reimarus or that of Paulus. The mythical theory that the Christ of the Gospels, excepting the most meagre outline of personal history, was the unintentional creation of the early Christian Messianic expectation he applied with merciless rigour to the narratives. But his operations were based upon fatal defects, positive and negative. He held a narrow theory as to the miraculous, a still narrower as to the relation of the divine to the human, and he had no true idea of the nature of historical tradition, while, as F. C. Baur complained, his critique of the Gospel history had not been preceded by the essential preliminary critique of the Gospels themselves.

AUTHORITIES.—Strauss's works were published in a collected edition in 12 vols., by E. Zeller (1876–1878), without his *Christliche Dogmatik*. His *Ausgewählte Briefe* appeared in 1895. On his life and works, see E. Zeller, *David Friedrich Strauss in seinem Leben und seinen Schriften* (1874); A. Hausrath, *D. F. Strauss und die*

Theologie seiner Zeit (2 vols., 1876–1878); F. J. Vischer, *Kritische Gänge* (1844), vol. i., and by the same writer, *Altes und Neues* (1882), vol. iii.; R. Gottschall, *Literarische Charakterköpfe* (1896), vol. iv.; S. Eck, *D. F. Strauss* (1899); K. Harraeus, *D. F. Strauss, sein Leben und seine Schriften* (1901); and T. Ziegler, *D. F. Strauss* (2 vols., 1908–1909).

STRAUSS, JOHANN (1804–1849), Austrian orchestral conductor and composer of dance-music, was born at Vienna on the 14th of March 1804. In 1819 he obtained his first engagement as a violinist in a small band then playing at the Sperl, in the Leopoldstadt, and after acting as deputy-conductor in another orchestra, he organized in 1825 a little band of fourteen performers on his own account. It was during the carnival of 1826 that Strauss inaugurated a long line of triumphs by introducing his band to the public of Vienna at the Schwan, in the Rossau suburb, where his famous *Täuberl-Walzer* (op. 1) at once established his reputation as the best composer of dance-music then living. Upon the strength of this success he was invited back to the Sperl, where he accepted an engagement, with an increased orchestra, for six years. Soon after this he was appointed kapellmeister to the 1st Bürger regiment, and entrusted with the duty of providing the music for the court balls; while the number of his private engagements was so great that he found it necessary to enlarge his band from time to time until it consisted of more than two hundred performers. In 1833 he began a long and extended series of tours throughout northern Europe, eventually visiting England in 1838. In Paris he associated himself with Musard, whose quadrilles became not much less popular than his own waltzes; but his greatest successes were achieved in London, where he arrived in time for the coronation of Queen Victoria, and played at seventy-two public concerts, besides innumerable balls and other private entertainments. The fatigue of these long journeys seriously injured Strauss's health; but he soon resumed his duties at the Sperl; and on the 5th of May 1840 he removed with his band to the Imperial "Volksgarten," which thenceforth became the scene of his most memorable successes, his conducting being marked by a quiet power which ensured the perfection of every minutest *nuance*. In 1844 Strauss began another extensive series of tours. In 1849 he revisited London, and, after his farewell concert, was escorted down the Thames by a squadron of boats, in one of which a band played tunes in his honour. This was his last public triumph. On his return to Vienna he was attacked with scarlet fever, of which he died on the 25th of September 1849.

Strauss was survived by three sons—Johann (1825–1899), Joseph (1827–1870) and Eduard (b. 1835), all of whom distinguished themselves as composers of dance-music, and assisted in recruiting the ranks and perpetuating the traditions of the still famous band.

STRAUSS, RICHARD (1864–), German composer, was born at Munich on the 11th of June 1864, the son of Franz Strauss, an eminent hornist. To some extent a prodigy, Strauss was something of a pianist at four, a composer at six, and at ten he was already seriously studying music under F. W. Meyer, the Munich Hofkapellmeister. Soon the result of this study began to make itself apparent. Singers sang Strauss's songs; the Walter Quartet played his *Quartet in A* (op. 2); Hermann Levi performed his *D minor Symphony*—a work that does not figure in the composer's list; and Bülow took the composer under his wing and introduced his early *Serenade* for wind instruments to the Meiningen public. For obvious reasons Strauss had not yet found himself. He had passed through the gymnasium and the university, and his music studies had been thorough. But all this had made of the youth merely an excellent technical musician, who in his *Eight Songs* (op. 10) and in his *Pianoforte Quartet* (op. 13) showed how strongly he was influenced by predecessors, Liszt in the one case, Mendelssohn in the other. Bülow's efforts to kindle in Strauss something of the fire of his own enthusiasm for Brahms's work ultimately proved fruitless. But to Bülow, and even more to Aléxander Ritter, Strauss owed the awakening in his own mind of the interest in the modern development of music that eventually in its ripeness placed Strauss at the very top of the composers' tree of his time. In

1885 Strauss succeeded Bülow as conductor of the Meiningen orchestra, but the appointment was held only for a few months, since in April of this year Strauss resigned his post in order to travel in Italy, and on his return in the early autumn he became 3rd conductor of the Munich Opera under Hermann Levi. Four years later he was installed in Weimar as Hofkapellmeister, but once again he held his post only for a brief period, for in 1894, the year of his marriage to Pauline de Ahna, the eminent singer, he was promoted to be 1st conductor at Munich. Between these various appointments and that of Hofkapellmeister in Berlin (1899) Strauss travelled considerably in the near East and over Europe, now in search of health, anon in propagandism. His first professional visit to London was in 1897, and laid the foundation of a local English cult that culminated six years later in a Strauss festival. From that time Strauss's path lay in pleasant places. He frequently returned to London, notably to conduct a performance of *Elektra*, in Beecham's season at Covent Garden in the spring of 1910, and a part of a concert at Queen's Hall, when he achieved a genuine triumph by his conducting of Mozart's music.

Of the early period of Strauss the composer there is little of importance to be said. His early works were neither better nor worse than those of scores of talented students of an advanced skill in matters of technique. Indeed it has often been said, with some show of authority, that the ultimate development of Strauss is seen to any appreciable extent first in the symphonic poem *Macbeth* (op. 23). Here, in spite of the earlier *Don Juan* (op. 20), Strauss is himself, thematically and orchestrally, for the first time, for *Aus Italien* (op. 16) is a comparatively poor and quite unrepresentative effusion apart altogether from the *faux pas* contained in it by the mistaking of a popular song composed in St John's Wood, London, for a Neapolitan folk-song. A year only divides *Macbeth* (1887) from *Don Juan* (1888)—"Tondramen ohne Worte," as they have been called. But there is an age between them and *Tod und Verklärung* (1889)—the bridge from one part to the other and the opening of the second section of which are amongst Strauss's most glorious inspirations. Between the last-named work and *Till Eulenspiegels lustigen Streiche* (1894), Strauss's first opera, *Guntram* finds place (first performance, Weimar, 1894), the latter a work that in spite of much *rêclame* for the composer failed to maintain a position upon the stage. In *Till Eulenspiegel* is to be found a sense of fun that is worthy of note (as of emulation), and it is perhaps worth recording that no more noteworthy example of the Rondo form exists in modern music, while its approximate successor, *Don Quixote* (1897), is an absolutely outstanding example of the Variation form. Further, Strauss reached in *Don Quixote* his zenith as a musical realist. In between there occurred the Nietzschean poem *Also sprach Zarathustra* (1895), which stirred up more temporary strife than any of its predecessors, if not so much perhaps as was engineered later on by the production of *Ein Heldenleben* (1898), or by the comparatively ingenuous *Symphonia domestica* (1904). For various reasons these compositions roused the somewhat sleepy academics of musical Europe from their lethargy. They revived, with the usual negative results, the ancient fight as to the legitimacy or otherwise of programme music. But though performances were comparatively rare in England up to the middle of 1910, those that had occurred proved undoubtedly attractive, while their rareness might quite reasonably be attributed to the very large fees demanded for their performance.

Up to 1910 Strauss had composed four operas. Of these, *Guntram* was on frankly Wagnerian lines. *Feuersnot*, on the other hand, a satirical, purely Munich work—a page out of the Munich annals, as it were, so closely is it identified with the Bavarian capital in its musical and personal reference, though produced at Dresden in 1901, remained sufficiently alive to have merited performance at His Majesty's theatre, London, again under Thomas Beecham's direction in July 1910. The same enthusiastic musician had previously produced *Elektra* with immense yet equal success in London (Covent Garden)

in the early spring of 1910. Perhaps none of these operas enjoyed the *rêclame* of *Salome* (Dresden 1905), which in England was originally barred by the censor of plays, but was performed several times at Covent Garden under Thomas Beecham in the autumn of 1910.

As a composer of songs Strauss enjoys the widest popularity in the conventional sense of the word. Many an example could be given from the hundred and more of his "Lieder" of Strauss's lawful right to be considered a lineal descendant of the royal line of German song writers. Some are transcendently beautiful. But this very fact has been thought to militate against his supreme greatness as a composer in the widest sense. The question, indeed, though in itself ridiculous, has been asked: which is the true Richard Strauss, the composer of the cacophonous *Ein Heldenleben* or of the exquisite *Morgen* or *Traum durch die Dämmerung*? But by 1910 he had at any rate won his place in the musical Walhalla. Whether the composer's name will survive by means of his many exquisite "Lieder," by means of his satire and grim humour, by means of his realism or his original classicism, remains to be seen. That his position is assured among the immortals is clear if only on account of his absolute independence of thought and of expression, of his prodigious breadth of artistic view and of his capacity to say his say in the musical language of his own day. His heartiest detractors admit that Strauss has enlarged the means of musical expression even if they cavil at his somewhat realistic utterance on occasion. To put it no higher, he must rank as a 20th-century Berlioz with a vastly wider musical knowledge and equipment. (R. H. L.)

STRAW and STRAW MANUFACTURES. Straw (from *strew*, as being used for *strewing*), is the general term applied to the stalky residue of grain-plants (especially wheat, rye, oats, barley). It forms the raw material of some important industries. It serves for the thatching of roofs, for a paper-making material, for ornamenting small surfaces as a "straw-mosaic," for plaiting into door and table mats, mattresses, &c., and for weaving and plaiting into light baskets, artificial flowers, &c. These applications, however, are insignificant in comparison with the place occupied by straw as a raw material for the straw bonnets and hats worn by both sexes. Of the various materials which go to the fabrication of plaited head-gear the most important is wheaten straw. It is only in certain areas that straw suitable for making plaits is produced. The straw must have a certain length of "pipe" between the knots, must possess a clear delicate golden colour and must not be brittle. The most valuable straw for plaits is grown in Tuscany, and from it the well-known Tuscan plaits and Leghorn hats are made. The straw of Tuscany, specially grown for plaiting, is distinguished into three qualities—*Pontederas Semone* being the finest, *Mazzuolo* the second quality, from which the bulk of the plaits are made, while from the third quality, *Santa Fioro*, only "Tuscan pedals" and braids are plaited. The wheat-seed for these straws is sown very thickly on comparatively elevated and arid land, and it sends up long attenuated stalks. When the grain in the ear is about half developed the straw is pulled up by the roots, dried in the sun, and subsequently spread out for several successive days to be bleached under the influence of alternate sunlight and night-dews. The pipe of the upper joint alone is selected for plaiting, the remainder of the straw being used for other purposes. These pipes are made up in small bundles, bleached in sulphur fumes in a closed chest, assorted into sizes, and so prepared for the plaiters. Straw-plaiting is a domestic industry among the women and young children of Tuscany and some parts of Emilia. Tuscan plaits and hats vary enormously in quality and value; the plait of a hat of good quality may represent the work of four or five days, while hats of the highest quality may each occupy six to nine months in making. The finest work is excessively trying to the eyes of the plaiters, who can at most give to it two or three hours' labour daily.

The districts around Luton in Bedfordshire and the neighbouring counties have, since the beginning of the 17th century, been the British home of the straw-plait industry. The straw

of certain varieties of wheat cultivated in that region is, in favourable seasons, possessed of a fine bright colour and due tenacity and strength. The straw is cut as in ordinary harvesting, but is allowed to dry in the sun before binding. Subsequently straws are selected from the sheaves, and of these the pipes of the two upper joints are taken for plaiting. The pipes are assorted into sizes by passing them through graduated openings in a grided wire frame, and those of good colour are bleached by the fumes of sulphur. Spotted and discoloured straws are dyed either in pipe or in plait. The plaiters work up the material in a damp state, either into whole straw or split straw plaits. Split straws are prepared with the aid of a small instrument having a projecting point which enters the straw pipe, and from which radiate the number of knife-edged cutters into which the straw is to be split. The plaiting of straw in the counties of Bucks., Beds., Berks. and Herts. formerly gave employment to many thousands of women and young children; but now vast quantities of plaits are imported at a very cheap rate from Italy, China and Japan. The result is that, while the Luton trade in the manufacture of straw and fancy hats of every description has largely extended, the number of English plaiters, all told, was not more than a few hundreds in 1907, as compared with 30,000 in 1871. The plaits are sewed partly by hand and in a special sewing-machine, and the hats or bonnets are finished by stiffening with gelatin size and blocking into shape with the aid of heat and powerful pressure, according to the dictates of fashion.

In the United States straw-plait work is principally centred in the state of Massachusetts.

Many substances besides straw are worked into plaits and braids for bonnets. Among these may be noticed thin strips of willow and cane and the fronds of numerous palms. "Brazilian" hats made from the fronds of the palmetto palms, *Sabal palmetto* and *S. mexicana*, are now largely made at St Albans. The famous Panama hats, fine qualities of which were at one time worth £20 to £30 each, are made from the leaves of the screw pine, *Carludovica palmata*. They are now manufactured at Dresden, Strassburg and Nancy, and can be purchased at 30s. or £2.

STRAWBERRY (*Fragaria*).—Apart from its interest as a dessert fruit, the strawberry has claims to attention by reason of the peculiarities of its structure and the excellent illustrations it offers of the inherent power of variation possessed by the plant and of the success of the gardener in availing himself of this tendency. The genus *Fragaria* consists of about eight species, native of the north temperate regions of both hemispheres, as well as of mountain districts in warmer climes; one species is found in Chile. The tufted character of the plant, and its habit of sending out long slender branches (runners) which produce a new bud at the extremity, are well known. The leaves have usually three leaflets palmately arranged, but the number of leaflets may be increased to five or reduced to one. While the flower has the typical Rosaceous structure, the so-called fruit is very peculiar, but it may be understood by the contrast it presents with the "hip" of the rose. In the last-named plant the top of the flower-stalk expands as it grows into a vase-shaped cavity, the "hip," within which are concealed the true fruits or seed-vessels. In the rose the extremity of the floral axis is concave and bears the carpels in its interior. In the strawberry the floral axis, instead of becoming concave, swells out into a fleshy, dome-shaped or flattened mass in which the carpels or true fruits, commonly called pips or seeds, are more or less embedded but never wholly concealed. A ripe strawberry in fact may be aptly compared to the "fruit" of a rose turned inside out.

The common wild strawberry of Great Britain (fig. 1), which indeed is found throughout Europe and great part of temperate Asia and North America, is *Fragaria vesca*, and this was the first species brought under cultivation in the early part of the 17th century. Later on other species were introduced, such as *F. elatior*, a European species, the parent stock of the hautbois strawberries, and especially *F. virginiana* from the United States and *F. chiloensis* from Chile. From these species, crossed and recrossed in various manners, have sprung the vast number

of different varieties now enumerated in catalogues, whose characteristics are so inextricably blended that the attempt to trace their exact parentage or to follow out their lineage has become impossible. The varieties at present cultivated vary in the most remarkable degree in size, colour, flavour, shape, degree of fertility, season of ripening, liability to disease and constitution of plant. Some, as previously stated, vary in foliage, others produce no runners, and some vary materially in the relative development of their sexual organs, for, while in most cases the flowers are in appearance hermaphrodite, at least in structure, there is a very general tendency towards a separation of the sexes, so that the flowers are males or females only



FIG. 1.—Wild Strawberry (*Fragaria vesca*), $\frac{2}{3}$ nat. size. In flower and fruit, and bearing a runner.

as to function, even although they may be perfect in construction. This tendency to dioecism is a common characteristic among Rosaceae, and sometimes proves a source of disappointment to the cultivator, who finds his plants barren where he had hoped to gather a crop. This happens in the United States more frequently than in Britain, but when recognized can readily be obviated by planting male varieties in the vicinity of the barren kinds. Darwin, in alluding to the vast amount of variability in the so-called "fruit"—a change effected by the art of the horticulturist in less than three centuries—contrasts with this variability the fixity and permanence of character presented by the true fruits, or pips, which are distributed over the surface of the swollen axis. The will and art of the gardener have been directed to the improvement of the one organ, while he has devoted no attention to the other, which consequently remains in the same condition as in the wild plant. Too much stress is not, however, to be laid on this point, for it must be remembered that the foliage, which is not specially an object of the gardener's "selection," nevertheless varies considerably.

The larger-fruited sorts are obtained by crossing from *F. chiloensis* and *F. virginiana*, and the smaller alpiners from *F. vesca*. The alpine varieties should be raised from seeds; while the other sorts are continued true to their kinds by runners. If new varieties are desired, these are obtained by judicious crossing and seeding.

The seeds of the alpiners should be saved from the finest fruit ripened early in the summer. They may at once be sown, either in a sheltered border outdoors or in pots, or better in March under glass, when they will produce fruits in June of the same year. The soil should be rich and light, and the seeds very slightly covered by sifting over them some leaf-mould or old decomposed cow dung. When the plants appear and have made five or six leaves, they are

transplanted to where they are to remain for bearing. The seeds sown in pots may be helped on by gentle heat, and when the plants are large enough they are pricked out in fine rich soil, and in June transferred to the open ground for bearing; they will produce a partial crop in the autumn, and a full one in the following season. The same treatment may be applied to the choicer seedlings of the larger-fruited sorts from which new varieties are expected. Amongst the best alpine strawberries, to which the name of "perpetual" has now been given, are those known as St Joseph and St Anthony of Padua.

The runners of established sorts should be allowed to root in the soil adjoining the plants, which should, therefore, be kept light and fine, or layered into small pots as for forcing. As soon as a few leaves are produced on each the secondary runners should be stopped. When the plants have become well-rooted they should at once be planted out. They do best in a rather strong loam, and should be kept tolerably moist. The scarlet section prefers a rich sandy loam. The ground should be trenched 2 or 3 ft. deep, and supplied with plenty of manure, a good proportion of which should lie just below the roots, 10 or 12 in. from the surface. The plants may be put in on an average about 2 ft. apart.

A mulching of strawy manure put between the rows in spring serves to keep the ground moist and the fruit clean, as well as to afford nourishment to the plants. Unless required, the runners are cut off early, in order to promote the swelling of the fruit. The plants are watered during dry weather after the fruit is set, and occasionally till it begins to colour. As soon as the fruit season is over, the runners are again removed, and the ground hoed and raked. The plantation should be renewed every second or third year, or less frequently if kept free of runners, if the old leaves are cut away after the fruit has been gathered, and if a good top-dressing of rotten dung or leaf-mould is applied. A top-dressing of loam is beneficial if applied before the plants begin to grow in spring, but after that period they should not be disturbed during the summer either at root or at top. If the plants produce a large number of flower-scapes, each should, if fine large fruit is desired, have them reduced to about four of the strongest. The lowest blossoms on the scape will be found to produce the largest, earliest and best fruits. The fruit should not be gathered till it is quite ripe, and then, if possible, it should be quite dry, but not heated by the sun. Those intended for preserving are best taken without the stalk and the calyx.

Forcing.—The runners propagated for forcing are layered into 3-in. pots, filled with rich soil, and held firm by a piece of raffia, a peg or stone. If kept duly watered they will soon form independent plants. The earlier they are secured the better. When firmly rooted they are removed and transferred into well-drained 6-in. pots, of strong well-enriched loam, the soil being rammed firmly into the pots, which are to be set in an open airy place. In severe frosts they should be covered with dry litter or bracken, but do not necessarily require to be placed under glass. They are moved into the forcing houses as required. The main points to be kept in view in forcing strawberries are, first, to have strong stocky plants, the leaves of which have grown sturdily from being well exposed to light, and secondly, to grow them on slowly till fruit is set. When they are first introduced into heat, the temperature should not exceed 45° or 50° by fire heat, and air must be freely admitted; should the leaves appear to grow up thin and delicate, less fire heat and more air must be given, but an average temperature of 55° by day may be allowed and continued while the plants are in flower. When the fruit is set the heat may be gradually increased, till at the ripening period it stands at 65°, and occasionally at 75° by sun heat. While the fruit is swelling the plants should never be allowed to get dry, but when it begins to colour no more water should be given than is absolutely requisite to keep the leaves from flagging. The plants should be removed from the house as soon as the crop is gathered. The forced plants properly hardened make first-rate outdoor plantations, and if put out early in summer, in good ground, will often produce a useful autumnal crop.

Diseases.—The most troublesome fungoid attacks to which the strawberry is subject are mildew and leaf-spot. The former, like all mildews, attacks the leaves and spreads to the fruit, these being covered with the white mycelium. The fungus is identical with that causing mildew in hops (*Sphaerotheca humuli*), and its development is greatly furthered by exposure of its host to cold draughts or low night temperatures. Spraying the foliage with potassium sulphide ($\frac{1}{2}$ oz. to 1 gallon of water) should hold it in check, but the plants should not be sprayed when the fruit is developing. The "leaf-spot" is caused by the fungus *Sphaerella fragariae*. The first symptom of this attack is the appearance of small, circular, white spots on the leaves, having a broad, definite, dark reddish margin.

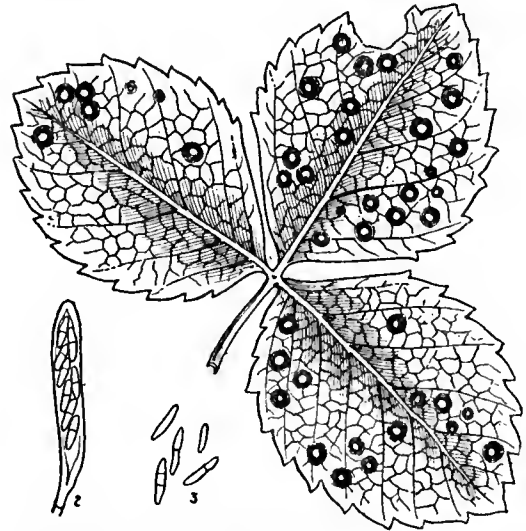

(From George Massee's *Textbook of Plant Diseases*, by permission of Duckworth & Co.)

FIG. 3.—*Sphaerella fragariae*.

- 1, Strawberry leaf showing diseased spots.
- 2, Ascus with eight spores from a perithecium. ($\times 300$.)
- 3, Spores or conidia of the *Ramularia* stage. ($\times 300$.)

On these spots a whitish mould (formerly considered to be a distinct species under the name *Ramularia tulasnei*) develops, and this is followed later by the perfect form of the fungus, the fruits of which appear to the naked eye as small black spots seated on the white dead spot on the leaf. Potassium sulphide may be used as for the mildew, or, perhaps better, Bordeaux mixture. It has been recommended to cut off the leaves after fruiting and burn the beds over so as to destroy the fungus in the leaves.

The grubs of the cockchafer (*Melolontha vulgaris*) and the rose-chaffer (*Cetonia aurata*) frequently feed upon the roots of the strawberry and do considerable damage, while the larvae of the garden swift moth (*Heplialus*) behave in a similar way. The imago of *Cetonia aurata* also frequently damages the flowers of the strawberry by devouring their centres, and is often troublesome in this way in forcing-houses particularly. The carnivorous ground beetles, particularly *Pterostichus nigra* and *Harpalus rufimanus*, when the fruit is ripe attack it at night, returning to the soil in the daytime. They are to be caught by placing jars containing some attractive matter, such as meat and water, at intervals about the beds with their mouths sunk level with the surface of the soil. Millepedes also are often found in the ripe fruit, but occur mostly where the soil is very rich in organic matter and poor in lime.

STREATHAM, a large residential district in the south of London, England, within the municipal borough of Wandsworth. The name appears to indicate its position on an ancient "street" or highway. According to Domesday, Streatham included several manors, two of which, Tooting and Balham (to follow the modern nomenclature), belonged to the abbot of St Mary de Bec in Normandy. One of several public grounds in the neighbourhood of Streatham is called Tooting Bec Common. The parish church of St Leonard, Streatham, contains among its memorials that of Henry Thrale (d. 1781), with an inscription by Samuel Johnson, who was a constant visitor at Thrale's house, Streatham Park, which is no longer standing.

STREATOR, a city of La Salle county, Illinois, U.S.A., on the Vermilion river, in the N. part of the state, about 95 m. S.W. of Chicago. Pop. (1890), 11,414; (1900), 14,079, of whom 3740 were foreign-born; (1910 census) 14,253; land area,

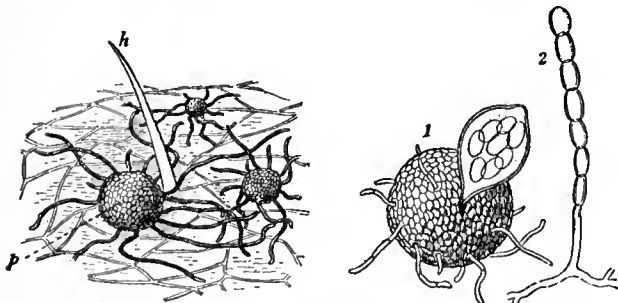

FIG. 2.—*Sphaerotheca humuli*, Hop and Strawberry Mildew.

Small portion of surface of hop leaf showing the fructification or perithecia (*p*) of the fungus attached to the surface; *h*, a hair of the leaf surface. ($\times 200$.) 1, A single perithecium bursting; 2, a chain of spores or conidia. (1 and 2 $\times 400$.)

2.97 sq. m. It is served by the Atchison, Topeka & Santa Fé, the Chicago, Burlington & Quincy, the Chicago & Alton, the Chicago, Indiana & Southern and the Wabash railways. Streator has a public library and a Chautauqua auditorium. It is in the Vermilion coal region, and clay for brick and tile is abundant in its vicinity. The city's manufactures include glass, brick, tile, foundry and machine-shop products, &c. In 1905 the factory product was valued at \$1,838,894, being 51.4% greater than in 1900. Streator was laid out in 1868, was incorporated as a village in 1870 and was chartered as a city in 1882.

STREET, GEORGE EDMUND (1824-1881), English architect, was born at Woodford in Essex on the 20th of June 1824. He was the third son of Thomas Street, solicitor, by his second wife, Mary Anne Millington. George went to school at Mitcham in about 1830, and later to the Camberwell collegiate school, which he left in 1839. For a few months he was in his father's business in Philpot Lane, but on his father's death he went to live with his mother and sister at Exeter. There his thoughts first turned to architecture, and in 1841 his mother obtained a place for him as pupil in the office of Mr Owen Carter at Winchester. Afterwards he worked for five years as an "improver" with Sir George Gilbert Scott in London. At an early age Street became deeply interested in the principles of Gothic architecture, and devoted an unsparing amount of time and labour to studying and sketching the finest examples of medieval buildings in England and on the Continent. His first commission was for the designing of Biscoray Church, Cornwall. In 1849 he took an office of his own. He was a draughtsman of a very high order; his sketches are masterpieces of spirit and brilliant touch. In 1855 he published a very careful and well-illustrated work on *The Brick and Marble Architecture of Northern Italy*, and in 1865 a book on *The Gothic Architecture of Spain*, with very beautiful drawings by his own hand. Street's personal taste led him in most cases to select for his design the 13th-century Gothic of England or France, his knowledge of which was very great, especially in the skilful use of rich mouldings. By far the majority of the buildings erected by him were for ecclesiastical uses, the chief being the convent of East Grinstead, the theological college at Cuddesden and a very large number of churches, such as St Philip and St James's at Oxford, St John's at Torquay, All Saints' at Clifton, St Saviour's at Eastbourne, St Margaret's at Liverpool and St Mary Magdalene, Paddington. His largest works were the nave of Bristol Cathedral, the choir of the cathedral of Christ Church in Dublin, and, above all, the new courts of justice in London. The competition for this was prolonged and much diversity of opinion was expressed. Thus, the judges wanted Street to make the exterior arrangements and Barry the interior, while a special committee of lawyers recommended the designs of Alfred Waterhouse. In June 1868, however, Street was appointed sole architect; but the building was not complete at the time of his death in December 1881. Street was elected an associate of the Royal Academy in 1866, and R.A. in 1871; at the time of his death he was professor of architecture to the Royal Academy, where he had delivered a very interesting course of lectures on the development of medieval architecture. He was also president of the Royal Institute of British Architects. He was a member of the Royal Academy of Vienna, and in 1878, in reward for drawings sent to the Paris Exhibition, he was made a knight of the Legion of Honour. Street was twice married, first on the 17th of June 1852 to Mariquita, second daughter of Robert Proctor, who died in 1874, and secondly on the 11th of January 1876 to Jessie, second daughter of William Holland, who died in the same year. The architect's own death, on the 18th of December 1881, was hastened by overwork and professional worries connected with the erection of the law courts. He was buried on the 29th of December in the nave of Westminster Abbey.

STRELITZ (*Strjeltzi*), a body of Russian household troops originally raised by the tsar Ivan the Terrible in the middle of the 16th century. They numbered 40,000 to 50,000 infantry, and formed the greater part of the Russian armies in the wars

of the 16th and 17th centuries. They were a fierce and ill-disciplined force, individually brave and cruel in war, and almost ungovernable in peace. Their mutinies were frequent and dangerous, and at last, in 1682, an unusually serious outbreak led Peter the Great to compass the abolition of the force. The Strelitz were gradually drawn to the western frontier of Russia, and in 1698 they rose in mutiny for the last time. Crushed in battle by Peter's general, Patrick Gordon, they ceased to exist as a military force, and about 2000 of them who fell into the hands of the tsar were barbarously tortured and put to death.

STRENGTH OF MATERIALS, that part of the theory of engineering which deals with the nature and effects of stresses in the parts of engineering structures. Its principal object is to determine the proper size and form of pieces which have to bear given loads, or, conversely, to determine the loads which can be safely applied to pieces whose dimensions and arrangement are already given. It also treats of the relation between the applied loads and the changes of form which they cause. The subject comprises experimental investigation of the properties of materials as to strength and elasticity, and mathematical discussion of the stresses in ties, struts, beams, shafts and other elements of structures and machines.

Stress is the mutual action between two bodies, or between two parts of a body, whereby each of the two exerts a force upon the other. Thus, when a stone lies on the ground there is at the surface of contact a stress, one aspect of which is the force directed downwards with which the stone pushes the ground, and the other aspect is the equal force directed upwards with which the ground pushes the stone. A body is said to be in a state of stress when there is a stress between the two parts which lie on opposite sides of an imaginary surface of section. A pillar or block supporting a weight is in a state of stress because at any cross section the part above the section pushes down against the part below, and the part below pushes up against the part above. A stretched rope is in a state of stress, because at any cross section the part on each side is pulling the part on the other side with a force in the direction of the rope's length. A plate of metal that is being cut in a shearing machine is in a state of stress, because at the place where it is about to give way the portion of metal on either side of the plane of shear is tending to drag the portion on the other side with a force in that plane.

Normal and Tangential Stress.—In a solid body which is in a state of stress the direction of stress at an imaginary surface of division may be normal, oblique or tangential to the surface. When oblique it is conveniently treated as consisting of a normal and a tangential component. Normal stress may be either push (compressive stress) or pull (tensile stress). Stress which is tangential to the surface is called shearing stress. Oblique stress may be regarded as so much push or pull along with so much shearing stress. The amount of stress per unit of surface is called the intensity of stress. Stress is said to be uniformly distributed over a surface when each fraction of the area of surface bears a corresponding fraction of the whole stress. If a stress P is uniformly distributed over a plane surface of area S , the intensity is P/S . If the stress is not uniformly distributed, the intensity at any point is $\delta P/\delta S$, where δP is the amount of stress on an indefinitely small area δS at the point considered. For practical purposes intensity of stress is usually expressed in tons weight per square inch, pounds weight per square inch, or kilogrammes weight per square millimetre or per square centimetre.

Simple Longitudinal Stress.—The simplest possible state of stress is that of a short pillar or block compressed by opposite forces applied at its ends, or that of a stretched rope or other tie. In these cases the stress is wholly in one direction, that of the length. These states may be distinguished as simple longitudinal push and simple longitudinal pull. In them there is no stress on planes parallel to the direction of the applied forces.

Compound Stress.—A more complex state of stress occurs if the block is compressed or extended by forces applied to a pair of opposite sides, as well as by forces applied to its ends—that is to say, if two simple longitudinal stresses in different directions act together. A still more complex state occurs if a third stress be applied to the remaining pair of sides. It may be shown (see ELASTICITY) that any state of stress which can possibly exist at any point of a body may be produced by the joint action of three simple pull or push stresses in three suitably chosen directions at right angles to each

other. These three are called principal stresses, and their directions are called the axes of principal stress. These axes have the important property that the intensity of stress along one of them is greater, and along another it is less, than in any other direction. These are called respectively the axes of greatest and least principal stress.

Resolution of Stress.—Returning now to the case of a single simple longitudinal stress, let AB (fig. 1) be a portion of a tie or a strut which is being pulled or pushed in the direction of the axis AB with a total stress P. On any plane CD taken at right angles to the axis we have a normal pull or push of intensity $p = P/S$, S being the area of the normal cross-section. On a plane EF whose normal is inclined to the axis at an angle θ we have a stress still in the direction of the axis, and therefore oblique to the plane EF, of intensity P/S' , where S' is the area of the surface EF, or $S/\cos \theta$. The whole stress P on EF may be resolved into two components, one normal to EF, and the other a shearing stress tangential to EF. The normal component (P_n , fig. 2) is $P \cos \theta$; the tangential component (P_t) is $P \sin \theta$. Hence the intensity of normal pull or push on EF, or p_n , is $p \cos^2 \theta$, and the intensity of shearing stress EF, or p_t , is $p \sin \theta \cos \theta$. This expression makes p_t a maximum when $\theta = 45^\circ$: surfaces inclined at 45° to the axis are called surfaces of maximum shearing stress; the intensity of shearing stress on them is $\frac{1}{2}p$.

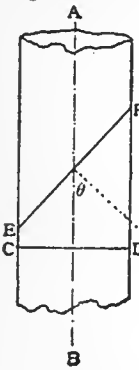

FIG. 1.

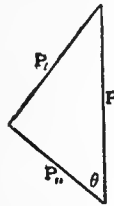

FIG. 2.

Combination of Two Simple Pull or Push Stresses at Right Angles to One Another.—Suppose next that there are two principal stresses: in other words that in addition to the simple pull or push stress of fig. 1 there is a second pull or push stress acting at right angles to it as in fig. 3. Call these P_x and P_y respectively.

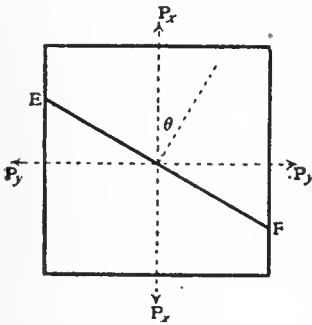

FIG. 3.

On any inclined surface EF there will be an intensity of stress whose normal component p_n and tangential component p_t are found by summing up the effects due to P_x and P_y separately. Let p_x and p_y be the intensities of stress produced by P_x and P_y respectively on planes perpendicular to their own directions. Then

$$p_n = (P_x \cos^2 \theta + p_y \sin^2 \theta),$$

$$p_t = (p_x - p_y) \sin \theta \cos \theta,$$

θ being the angle which the normal to the surface makes with the direction of P_x .

The tangential stress p_t becomes a maximum when θ is 45° , and its value then is

$$\text{Max. } p_t = \frac{1}{2} (p_x - p_y).$$

If in addition there is a third principal stress P_z , it will not produce any tangential component on planes perpendicular to the plane of the figure. Hence the above expression for the maximum tangential stress will still apply, and it is easy to extend this result so as to reach the important general proposition that in any condition of stress whatever the maximum intensity of shearing stress is equal to one-half the difference between the greatest and least principal stresses and occurs on surfaces inclined at 45° to them.

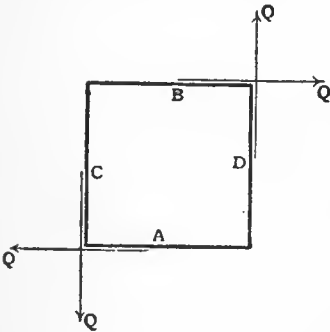

FIG. 4.

Let an elementary cubical part of any solid body (fig. 4) have tangential stresses QQ applied to one pair of opposite faces, A and B, and equal tangential stresses applied to a second pair of faces C and D,

State of Simple Shear.—A special case of great importance occurs when there are two principal stresses only, equal in magnitude and opposite in sign; in other words, when one is a simple push and the other a simple pull. Then on surfaces inclined at 45° to the axes of pull and push there is nothing but tangential stress, for $p_n = 0$; and this intensity of tangential stress is numerically equal to p_x or to p_y . This condition of stress is called a state of simple shear.

The state of simple shear may also be arrived at in another way.

as in the figure. The effect is to set up a state of simple shear. On all planes parallel to A and B there is nothing but tangential stress, and the same is true of all planes parallel to C and D. The intensity of the stress on both systems of planes is equal throughout to the intensity of the stress which was applied to the face of the block.

To see the connexion between these two ways of specifying a state of simple shear consider the equilibrium of the parts into which the block may be divided by ideal diagonal planes of section. To balance the forces QQ (fig. 5), there must be normal pull on the diagonal plane, the amount of which is $P = Q\sqrt{2}$. But the area of the surface over which P acts is greater than that of the surface over which Q acts in the proportion which P bears to Q, and hence the intensity of P is the same as the intensity of Q.

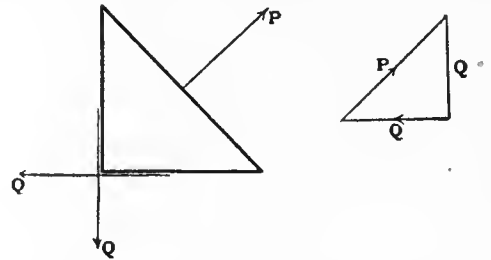

FIG. 5.

Again, taking the other diagonal plane (fig. 6), the same argument applies except that here the normal force P required for equilibrium is a push instead of a pull. Thus the state of stress represented in fig. 4 admits of analysis into two equal principal stresses, one of push and one of pull, acting in directions at right angles to one another and inclined at 45° to the planes of shear stress.

Equality of Shearing Stress in Two Directions.—No tangential stress can exist in one direction without an equal intensity of tangential stress existing in another direction at right angles to the first. To prove this it is sufficient to consider the equilibrium of the elementary cube of fig. 4. The tangential forces acting on two sides A and B produce a couple which tends to rotate the cube. No arrangement of normal stresses on any of the three pairs of sides of the cube can balance this couple; that can be done only by equal tangential forces on C and D.

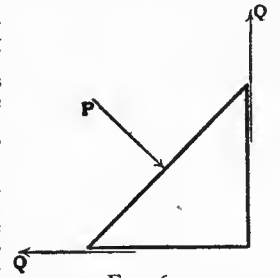

FIG. 6.

Fluid Stress.—Another important case occurs when there are three principal stresses all of the same sign and of equal intensity p . The tangential components on any planes cancel each other: the stress on every plane is wholly normal and its intensity is p . This is the only state of stress that can exist in a fluid at rest because a fluid exerts no statical resistance to shear. For this reason the state is often spoken of as a fluid stress.

Strain is the change of shape produced by stress. If the stress is a simple longitudinal pull, the strain consists of lengthening in the direction of the pull, accompanied by contraction in both directions at right angles to the pull. If the stress is a simple push, the strain consists of shortening in the direction of the push and expansion in both directions at right angles to that; the stress and the strain are then exactly the reverse of what they are in the case of simple pull. If the stress is one of simple shearing, the strain consists of a distortion such as would be produced by the sliding of layers in the direction of the shearing stresses.

A material is elastic with regard to any applied stress if the strain disappears when the stress is removed. Strain which persists after the stress that produced it is removed is called permanent set. For brevity, it is convenient to speak of strain which disappears when the stress is removed as elastic strain.

Limits of Elasticity.—Actual materials are generally very perfectly elastic with regard to small stresses, and very imperfectly elastic with regard to great stresses. If the applied stress is less than a certain limit, the strain is in general small in amount, and disappears wholly, or almost wholly, when the stress is removed. If the applied stress exceeds this limit, the strain is, in general, much greater than before, and most of it is found, when the stress is removed, to consist of permanent set. The

Figs. 3, 4, 5, 6, 15, 16, 17, 18, 19, 20, 23, 24 and 25 are from Ewing's *Strength of Materials*, by permission of the Cambridge University Press.

limits of stress within which strain is wholly or almost wholly elastic are called limits of elasticity.

For any particular mode of stress the limit of elasticity is much more sharply defined in some materials than in others. When well defined it may readily be recognized in the testing of a sample from the fact that after the stress exceeds the limit of elasticity the strain begins to increase in a much more rapid ratio to the stress than before. This characteristic goes along with the one already mentioned, that up to the limit the strain is wholly or almost wholly elastic.

Hooke's Law.—Within the limits of elasticity the strain produced by a stress of any one kind is proportional to the stress producing it. This is Hooke's law, enunciated by him in 1676.

In applying Hooke's law to the case of simple longitudinal stress—such as the case of a bar stretched by simple longitudinal pull—we may measure the state of strain by the change of length per unit of original length which the bar undergoes when stressed. Let the original length be l , and let the whole change of length be δl when a stress is applied whose intensity p is within the elastic limit. Then the strain is measured by $\delta l/l$, and this by Hooke's law is proportional to p . This may be written

$$\delta l/l = p/E,$$

where E is a constant for the particular material considered. The same value of E applies to push and to pull, these modes of stress being essentially continuous, and differing only in sign.

Young's Modulus.—This constant E is called the modulus of longitudinal extensibility, or Young's modulus. Its value, which is expressed in the same units as are used to express intensity of stress, may be measured directly by exposing a sample of the material to longitudinal pull and noting the extension, or indirectly by measuring the flexure of a loaded beam of the material, or by experiments on the frequency of vibrations. It is frequently spoken of by engineers simply as the modulus of elasticity, but this name is too general, as there are other moduli applicable to other modes of stress. Since $E = p/l/\delta l$, the modulus may be defined as the ratio of the intensity of stress p to the longitudinal strain $\delta l/l$.

Modulus of Rigidity.—In the case of simple shearing stress, the strain may be measured by the angle by which each of the four originally right angles in the square prism of fig. 3 is altered by the distortion of the prism. Let this angle be ϕ in radians; then by Hooke's law $p/\phi = C$, where p is the intensity of shearing stress and C is a constant which measures the rigidity of the material. C is called the modulus of rigidity, and is usually determined by experiments on torsion.

Modulus of Cubic Compressibility.—When three simple stresses of equal intensity p and of the same sign (all pulls or all pushes) are applied in three directions, the material (provided it be isotropic, that is to say, provided its properties are the same in all directions) suffers change of volume only, without distortion of form. If the volume is V and the change of volume δV , the ratio of the stress p to the strain $\delta V/V$ is called the modulus of cubic compressibility, and will be denoted by K .

Of these three moduli the one of most importance in engineering applications is Young's modulus E . When a simple longitudinal pull or push of intensity p is applied to a piece, the longitudinal strain of extension or compression is p/E . This is accompanied by a lateral contraction or expansion, in each transverse direction, whose amount may be written $p/\sigma E$, where σ is the ratio of longitudinal to lateral strain. It is shown in the article ELASTICITY, that for an isotropic material

$$E = \frac{9CK}{3K+C} \text{ and } \sigma = \frac{2(3K+C)}{3K-2C}.$$

Plastic Strain.—Beyond the limits of elasticity the relation of strain to stress becomes very indefinite. Materials then exhibit, to a greater or less degree, the property of plasticity. The strain is much affected by the length of time during which the stress has been in operation, and reaches its maximum, for any assigned stress, only after a long (perhaps an indefinitely long) time. Finally, when the stress is sufficiently increased, the ratio of the increment of strain to the increment of stress becomes indefinitely great if time is given for the stress to take effect. In other words, the substance then assumes what may be called a completely plastic state; it flows under the applied stress like a viscous liquid.

Ultimate Strength.—The ultimate strength of a material with regard to any stated mode of stress is the stress required to produce rupture. In reckoning ultimate strength, however, engineers take, not the actual intensity of stress at which rupture occurs, but the value which this intensity would have reached had rupture ensued without previous alteration of shape. Thus, if a bar whose original cross-section is 2 sq. in. breaks under a uniformly distributed pull of 60 tons, the ultimate tensile strength of the material is reckoned to be 30 tons per square inch, although the actual intensity of stress which produced rupture may have been much greater than this, owing to the contraction of the section previous to fracture. The convenience

of this usage will be obvious from an example. Suppose that a piece of material of the same quality be used in a structure under conditions which cause it to bear a simple pull of 6 tons per square inch; we conclude at once that the actual load is one-fifth of that which would cause rupture, irrespective of the extent to which the material might contract in section if overstrained. The stresses which occur in engineering practice are, or ought to be, in all cases within the limits of elasticity, and within these limits the change of cross-section caused by longitudinal pull or push is so small that it may be neglected in reckoning the intensity of stress.

Ultimate tensile strength and ultimate shearing strength are well defined, since these modes of stress (simple pull and simple shearing stress) lead to distinct fracture if the stress is sufficiently increased. Under compression some materials yield so continuously that their ultimate strength to resist compression can scarcely be specified; others show so distinct a fracture by crushing that their compressive strength may be determined with some precision.

Some of the materials used in engineering, notably timber and wrought iron, are so far from being isotropic that their strength is widely different for stresses in different directions. In the case of wrought iron the process of rolling develops a fibrous structure on account of the presence of streaks of slag which become interspersed with the metal in puddling; and the tensile strength of a rolled plate is found to be considerably greater in the direction of rolling than across the plate. Steel plates, being rolled from a nearly homogeneous ingot, have nearly the same strength in both directions, provided the process of rolling is completed at a temperature high enough to allow recrystallization to take place in cooling. Cold-rolled or cold-drawn metal is not isotropic because the crystals of which it is made up have been elongated in one direction by the process: but isotropy may be restored by heating the piece sufficiently to allow the crystals to re-form.

Permissible Working Stress.—In applying a knowledge of the strength of materials to determine the proper sizes of parts in an engineering structure we have to estimate a permissible working stress. This is based partly on special tests and partly on experience of the behaviour of the material when used in similar structures. The working stress is rarely so much as one-third of the ultimate strength; it is more commonly one-fourth or one-fifth and in some cases, especially where the loads to be borne are liable to reversal or to much change, it may be prudent to make the working stress even less than this.

Factor of Safety.—The ratio of the ultimate strength to the working stress is called the factor of safety. The factor should in general be such as to bring the working stress within the limit of elasticity and even to leave within that limit a margin which will be ample enough to cover such contingencies as imperfection in the theory on which the calculation of the working stress is founded, lack of uniformity in the material itself, uncertainty in the estimation of loads, imperfections of workmanship which may cause the actual dimensions to fall short of those that have been specified, alterations arising from wear, rust and so forth. An important distinction has to be drawn in this connexion between steady or "dead" loads and loads which are subject to variation and especially to reversal. With the former the working stress may reach or pass the elastic limit without destroying the structure; but in a piece subject to reversals a stress of the same magnitude would lead inevitably to rupture, and hence a larger margin should be left to ensure that in the latter case the elastic limit shall not even be approached.

It is in fact the elastic limit rather than the ultimate strength of the material on which the question mainly depends of how high the working stress may safely be allowed to rise in any particular conditions as to mode of loading, and accordingly it becomes a matter of much practical importance to determine by tests the amount of stress which can be borne without permanent strain. From an engineering point of view the structural merit of a material, especially when variable loads and possible shocks have to be sustained, depends not only on the strength but also on the extent to which the material will bear deformation without rupture. This characteristic is shown in tests made to determine tensile strength by the amount of ultimate elongation, and also by the contraction of the cross-section which occurs through the flow of the metal before rupture. It is often, tested in other ways, such as by bending and unbending bars in a circle of specified radius, or by examining the effect of repeated blows. Tests by impact are generally

made by causing a weight to fall through a regulated distance on a piece of the material supported as a beam.

Tests of Strength.—Ordinary tests of strength are made by submitting the piece to direct pull, direct compression, bending or torsion. Testing machines are frequently arranged so that they may apply any of these four modes of stress; tests by direct tension are the most common, and next to them come tests by bending. When the samples to be tested for tensile strength are mere wires, the stress may be applied directly by weights; for pieces of larger section some mechanical multiplication of force becomes necessary. Owing to the plasticity of the materials to be tested, the applied loads must be able to follow considerable change of form in the test-piece: thus in testing the tensile strength of wrought iron or steel provision must be made for taking up the large extension of length which occurs before fracture. In most modern forms of large testing machines the loads are applied by means of hydraulic pressure acting on a piston or plunger to which one end of the specimen is secured, and the stress is measured by connecting

lever. The lower holder is jointed to a cross-head C, which is connected by two vertical screws to a lower cross-head B, upon which the hydraulic plunger shown in section in fig. 7 exerts its thrust. G is a counterpoise which pushes up the plunger when the water is allowed to escape. Hydraulic pressure may be applied to the plunger by pumps or by an accumulator. In the present instance it is applied by means of an auxiliary plunger Q, which is pressed by screw gearing into an auxiliary cylinder. Q is driven by a belt on the pulley D. This puts stress on the specimen, and the weight W is then run out along the lever so that the lever is just kept floating between the stops E, E. Before the test-piece is put in the distance between the holders is regulated by means of the screws connecting the upper and lower cross-heads C and B, these screws being turned by a handle applied at F. The knife edges are made long enough to prevent the load on them from ever exceeding 5 tons to the linear inch. To adapt a machine of this class for tests in compression, a small platform is suspended like a stirrup by four rods from the weigh-beam, and hangs below the cross-head, which is pulled

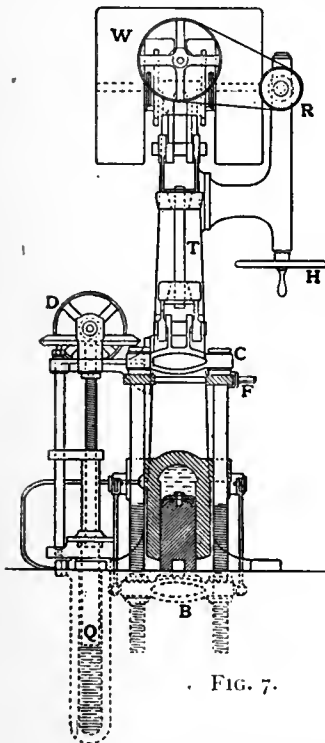

FIG. 7.

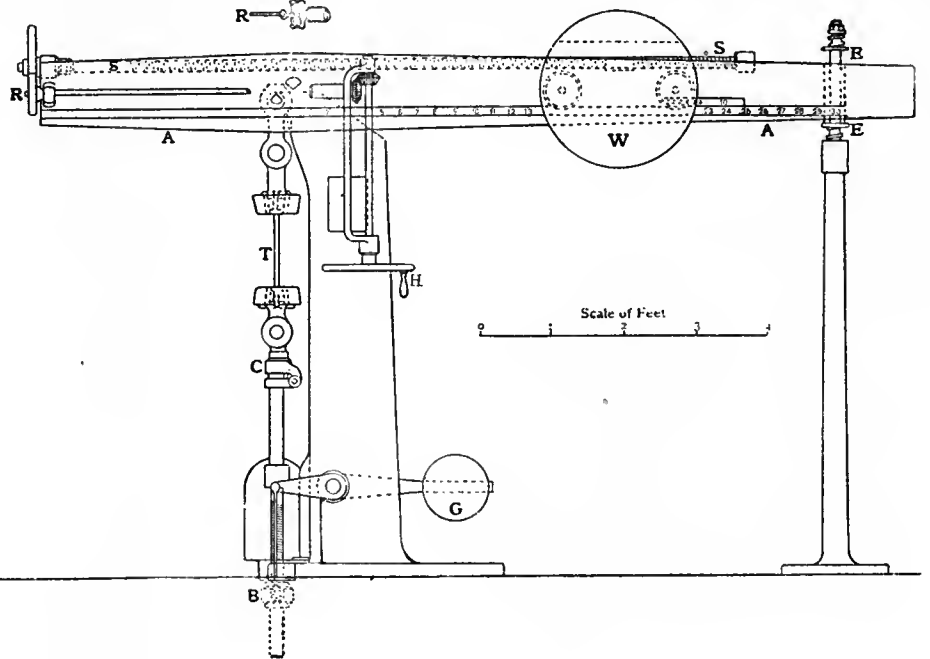

FIG. 8.

the other end to a lever or system of levers provided with adjustable weights. In small machines, and also in some large ones, the stress is applied by screw gearing instead of by hydraulic pressure. Springs are sometimes used instead of weights to measure the stress, and another plan is to make one end of the specimen act on a diaphragm forming part of a hydrostatic pressure gauge.

Single-lever Testing Machine.—Figs. 7 and 8 show an excellent form of single-lever testing machine designed by J. H. Wicksteed (*Proc. Inst. Mech. Eng.*, August 1882) in which the stress is applied by a hydraulic plunger and is measured by a lever or steelyard and a movable weight. The illustration shows a 30-ton machine, but machines of similar design are in common use which exert a force of 100 tons or more. AA is the lever, on which there is a graduated scale. The stress on the test-piece T is measured by a weight W of 1 ton (with an attached vernier scale), which is moved along the lever by a screw-shaft S; this screw-shaft is driven by a belt from a parallel shaft R, which takes its motion, through bevel-wheels and a Hooke's joint in the axis of the fulcrum, from the hand-wheel H. (The Hooke's joint in the shaft R is shown in a separate sketch above the lever in fig. 8.) The holder for the upper end of the sample hangs from a knife-edge 3 in. from the fulcrum of the

down when the hydraulic cylinder is put in action. The arrangement is that of two stirrups linked with one another, so that when the two pull against each other a block of material placed between them becomes compressed. For tests in bending one of the stirrups, namely, the platform which hangs from the weigh-beam, is made some 4 or 5 ft. long, and carries two knife-edge supports at its ends on which the ends of the piece that is to be bent rest, while the cross-head presses down upon the middle of the piece. In both cases the force which is exerted is measured by means of the weigh-beam and travelling weight, just as in the tension tests. To apply the force continuously, without shock, and either quickly or slowly at will, a very convenient plan is to use an hydraulic intensifier, consisting of a large hydraulic piston operating a much smaller one. By gradually admitting water to the large piston from any convenient source under moderate pressure, such as the town water mains, a progressively increased pressure is produced in the fluid on which the small piston acts, and this fluid is admitted to the straining cylinder of the machine. One of the advantages of the vertical type of machine, with its single horizontal lever, is the facility with which the correctness of its readings may be verified. The two things to be tested are (1) the distance between the knife-edges, one of which forms the fulcrum of the

weigh-beam and from the other of which the shackle holding the upper end of the specimen is hung, and (2) the weight of the travelling poise. The weight of the poise is readily ascertained by using a supplementary known weight to apply a known moment to the beam, and measuring how far the poise has to be moved to restore equilibrium. The distance between the knife-edges is then found by hanging a known heavy weight from the shackle, and again observing how far the poise has to be moved. Another example of the single-lever type is the Werder testing machine, much used on the continent of Europe. In it the specimen is horizontal; one end is fixed, the other is attached to the short vertical arm of a bell-crank lever, whose fulcrum is pushed out horizontally by an hydraulic ram.¹

Multiple-lever Testing Machines.—In many other testing machines a system of two, three or more levers is employed to reduce the force between the specimen and the measuring weight. In most cases the fulcrums are fixed, and the stress is applied to one end of the specimen by hydraulic power or by screw gearing, which takes up the stretch, as in the single-lever machines already described. David Kirkaldy, who was one of the earliest as well as one of the most assiduous workers in this field, applied in his 1,000,000 lb machine a horizontal hydraulic press directly to one end of the horizontal test-piece. The other end of the piece was connected to the short vertical arm of a bell-crank lever; the long arm of this lever was horizontal, and was connected to a second lever to which weights were applied.

Machines have been employed in which one end of the specimen is held in a fixed support; an hydraulic press acts on the other end, and the stress is calculated from the pressure of fluid in the press, this being observed by a pressure-gauge. Machines of this class are open to the obvious objection that the friction of the hydraulic plunger causes a large and very uncertain difference between the force exerted by the fluid on the plunger and the force exerted by the plunger on the specimen. It appears, however, that in the ordinary conditions of packing the friction is very nearly proportional to the fluid pressure, and its effect may therefore be allowed for with some exactness. The method is not to be recommended for work requiring precision, unless the plunger be kept in constant rotation on its own axis during the test, in which case the effects of friction are almost entirely eliminated.

Diaphragm Testing Machines.—In another class of testing machines the stress (applied as before to one end of the piece, by gearing or by hydraulic pressure) is measured by connecting the other end to a flexible diaphragm, on which a liquid acts whose pressure is determined by a gauge. Fig. 9 shows

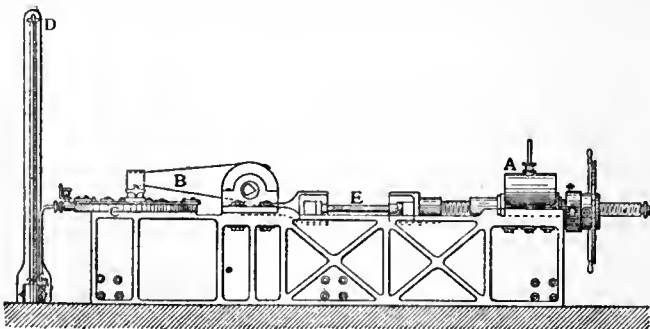

FIG. 9.

Thomasset's testing machine, in which one end of the specimen is pulled by an hydraulic press A. The other end acts through a bell-crank lever B on a horizontal diaphragm C, consisting of a metallic plate and a flexible ring of india-rubber. The pressure on the diaphragm causes a column of mercury to rise in the gauge-tube D. The same principle is applied in the remarkable testing machine of Watertown arsenal, built in 1879 by the U.S. government to the designs of A. H. Emery. This is a horizontal machine, taking specimens of any length up

¹ Maschine zum Prüfen d. Festigkeit d. Materialien, &c. (Munich, 1882).

to 30 ft., and exerting a pull of 360 tons or a push of 480 tons by an hydraulic press at one end. The stress is taken at the other end by a group of four large vertical diaphragm presses, which communicate by small tubes with four similar small diaphragm presses in the scale case. The pressure of these acts on a system of levers which terminates in the scale beam. The joints and bearings of all the levers are made frictionless by using flexible steel connecting-plates instead of knife-edges. The total multiplication at the end of the scale beam is 420,000.²

Stress-strain Diagrams.—The results of tests are very commonly exhibited by means of stress-strain diagrams, or diagrams showing the relation of strain to stress. A few typical diagrams for wrought iron and steel in tension are given in fig. 10, the data for which are taken from tests of long rods by Kirkaldy.³ Up to the elastic limit these diagrams show sensibly the same rate of extension for all the materials to which they refer. Soon after the limit of elasticity is passed, a point, which has been called by Sir A. B. W. Kennedy the yield-point, is reached,

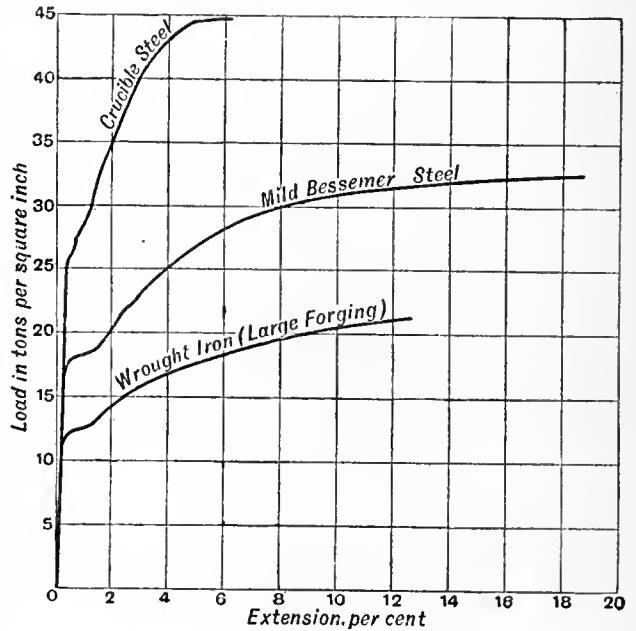

FIG. 10.

which is marked by a very sudden extension of the specimen. After this the extension becomes less rapid; then it continues at a fairly regular and gradually increasing rate; near the point of rupture the metal again begins to draw out rapidly. When this stage is reached rupture will occur through the flow of the metal, even if the load be somewhat decreased. The diagram may in this way be made to come back towards the line of no load, by withdrawing a part of the load as the end of the test is approached.

Fig. 11 is a stress-strain diagram for cast iron in extension and compression, taken from Eaton Hodgkinson's experiments.⁴ The extension was measured on a rod 50 ft. long; the compression was also measured on a long rod, which

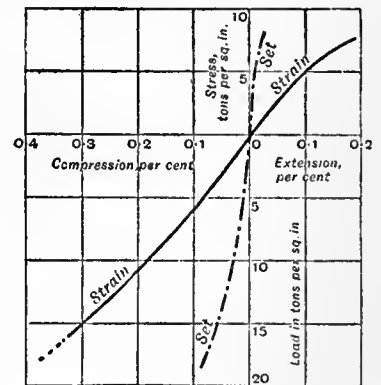

FIG. 11.

² See Report of the U.S. Board appointed to test Iron, Steel and other Metals (2 vols., 1881). For full details of the Emery machine, see Report of the U.S. Chief of Ordnance (1883), app. 24.

³ Experiments on the Mechanical Properties of Steel by a Committee of Civil Engineers (London, 1868 and 1870).

⁴ Report of the Commissioners on the Application of Iron to Railway Structures (1849).

was prevented from buckling by being supported in a trough with partitions. The full line gives the strain produced by loading; it is continuous through the origin, showing that Young's modulus is the same for pull and push. (Similar experiments on wrought iron and steel in extension and compression have given the same result.) The broken line shows the set produced by each load. Hodgkinson found that some set could be detected after even the smallest loads had been applied. This is probably due to the existence of initial internal stress in the metal, produced by unequally rapid cooling in different portions of the cast bar. A second loading of the same piece showed a much closer approach to perfect elasticity. The elastic limit is, at the best, ill defined; but by the time the ultimate load is reached the set has become a more considerable part of the whole strain. The pull curves in the diagram extend to the point of rupture; the compression curves are drawn only up to a stage at which the bar buckled (between the partitions) so much as to affect the results.

Autographic Recorders.—Testing machines are sometimes fitted with autographic appliances for drawing strain diagrams. When the load is measured by a weight travelling on a steelyard, the diagram may be drawn by connecting the weight with a drum by means of a wire or cord, so that the drum is made to revolve through angles proportional to the travel of the weight. At the same time another wire, fastened to a clip near one end of the specimen, and passing over a pulley near the other end, draws a pencil through distances proportional to the strain, and so traces a diagram of stress and strain on a sheet of paper stretched round the drum.¹ In Wicksteed's autographic recorder the stress is determined by reference, not to the load on the lever, but to the pressure in the hydraulic cylinder by which stress is applied. The main cylinder is in communication with a small auxiliary hydraulic cylinder, the plunger of which is kept rotating to avoid friction at its packing. This plunger abuts against a spring, so that the distance through which it is pushed out varies with the pressure in the main cylinder. A drum covered with paper moves with the plunger under a fixed pencil, and is also caused to rotate by a wire from the specimen through distances proportional to the strain. The scale of loads is calibrated by occasional reference to the weighted lever.² In Kennedy's apparatus autographic diagrams are drawn by applying the stress to the test-piece through an elastic master-bar of larger section. The master-bar is never strained beyond its elastic limit, and within that limit its extension furnishes an accurate measure of the stress; this gives motion to a pencil, which writes on a paper moved by the extension of the test-piece.³ In R. H. Thurston's pendulum machine for torsion tests, a cam attached to the pendulum moves a pencil through distances proportional to the stress, while a paper drum attached to the other end of the test-piece turns under the pencil through distances proportional to the angle of twist.⁴

Strain beyond the Elastic Limit: Influence of Time.—In testing a plastic material such as wrought-iron or mild steel it is found that the behaviour of the metal depends very materially on the time rate at which stress is applied. When once the elastic limit is passed the full strain corresponding to a given load is reached only after a perceptible time, sometimes even a long

¹ For descriptions of these and other types of autographic recorder, see a paper by Professor W. C. Unwin, "On the Employment of Autographic Records in Testing Materials," *Journ. Soc. Arts* (Feb., 1886); also Sir A. B. W. Kennedy's paper, "On the Use and Equipment of Engineering Laboratories," *Proc. Inst. Civ. Eng.* (1886), which contains much valuable information on the whole subject of testing and testing machines. On the general subject of tests see also Adolf Martens's *Handbook of Testing Materials*, trans. by G. C. Henning.

² *Proc. Inst. Mech. Eng.* (1886). An interesting feature of this apparatus is a device for preventing error in the diagram through motion of the test-piece as a whole.

³ *Proc. Inst. Mech. Eng.* (1886); also *Proc. Inst. Civ. Eng.* vol. lxxxviii. pl. 1 (1886).

⁴ Thurston's *Materials of Engineering*, pt. ii. For accounts of work done with this machine, see *Trans. Amer. Soc. Civ. Eng.* (from 1876); also, *Report of the American Board*, cited above.

time. If the load be increased to a value exceeding the elastic limit, and then kept constant, the metal will be seen to draw out (if the stress be one of pull), at first rapidly and then more slowly. When the applied load is considerably less than the ultimate strength of the piece (as tested in the ordinary way by steady increment of load) it appears that this process of slow extension comes at last to an end. On the other hand, when the applied load is nearly equal to the ultimate strength, the flow of the metal continues until rupture occurs. Then, as in the former case, extension goes on at first quickly, then slowly, but finally, instead of approaching an asymptotic limit, it quickens again as the piece approaches rupture. The same phenomena are observed in the bending of timber and other materials when in the form of beams. If, instead of being subjected to a constant load, a test-piece is set in a constant condition of strain, it is found that the stress required to maintain this constant strain gradually decreases.

The gradual flow which goes on under constant stress—approaching a limit if the stress is moderate in amount, and continuing without limit if the stress is sufficiently great—will still go on at a diminished rate if the amount of stress be reduced. Thus, in the testing of soft iron or mild steel by a machine in which the stress is applied by hydraulic power, a stage is reached soon after the limit of elasticity is passed at which the metal begins to flow with great rapidity. The pumps often do not

keep pace with this, and the result is that, if the lever is to be kept floating, the weight on it must be run back. Under this reduced stress the flow continues, more slowly than before, until presently the pumps recover their lost ground and the increase of stress is resumed. Again, near the point of rupture, the flow again becomes specially rapid; the weight on the lever has again to be run back, and the specimen finally breaks under a diminished load. These

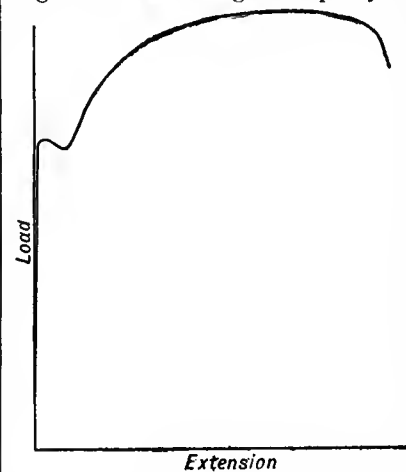

FIG. 12.

features are well shown by fig. 12, which is copied from the autographic diagram of a test of mild steel.

Hardening Effect of Permanent Set.—But it is not only through what we may call the viscosity of materials that the time rate of loading affects their behaviour under test. In iron and steel, and probably in some other metals, time has another effect of a very remarkable kind. Let the test be carried to any point *a* (fig. 13) past the original limit of elasticity. Let the load then be removed; during the first stages of this removal the material continues to stretch slightly, as has been explained above. Let the load then be at once replaced and loading continued. It will then be found that there is a new yield-point *b* at or near the value of the load formerly reached. The full line *bc* in fig. 13 shows the subsequent behaviour of the piece. But now let the experiment be repeated on another sample, with this difference, that an interval of time, of a few hours or more, is allowed to elapse after the load is removed and before it is replaced. It will then be found that a process of hardening has been going on during this interval of rest; for when the loading is continued the new yield-point appears, not at *b* as formerly, but at a higher load *d*. Other evidence that a change has taken place is afforded by the fact that the ultimate extension is reduced and the ultimate strength is increased (*e*, fig. 13).

A similar and even more marked hardening occurs when a load (exceeding the original elastic limit), instead of being removed and replaced, is kept on for a sufficient length of time without change. When loading is resumed a new yield-point

is found only after a considerable addition has been made to the load. The result is, as in the former case, to give greater ultimate strength and less ultimate elongation. Fig. 14 exhibits two experiments of this kind, made with annealed iron wire. A

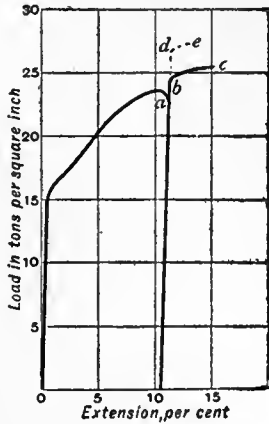

FIG. 13.

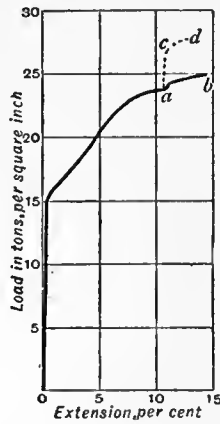

FIG. 14.

load of $23\frac{1}{2}$ tons per square inch was reached in both cases; *ab* shows the result of continuing to load after an interval of five minutes, and *acd* after an interval of $45\frac{1}{2}$ hours, the stress of $23\frac{1}{2}$ tons being maintained during the interval in both cases.¹

It may be concluded that, when a piece of metal has in any way been overstrained by stress exceeding its limits of elasticity, it is hardened, and (in some cases at least) its physical properties go on slowly changing for days or even months. Instances of the hardening effect of permanent set occur when plates or bars are rolled cold, hammered cold, or bent cold, or when wire is drawn. When a hole is punched in a plate the material contiguous to the hole is severely distorted by shear, and is so much hardened in consequence that when a strip containing the punched hole is broken by tensile stress the hardened portion, being unable to extend so much as the rest, receives an undue proportion of the stress, and the strip breaks with a smaller load than it would have borne had the stress been uniformly distributed. This bad effect of punching is especially noticeable in thick plates of mild steel. It disappears when a narrow ring of material surrounding the hole is removed by means of a rimer, so that the material that is left is homogeneous. Another remarkable instance of the same kind of action is seen when a mild-steel plate which is to be tested by bending has a piece cut from its edge by a shearing machine. The result of the shear is that the metal close to the edge is hardened, and, when the plate is bent, this part, being unable to stretch like the rest, starts a crack or tear which quickly spreads across the plate on account of the fact that in the metal at the end of the crack there is an enormously high local intensity of stress. By the simple expedient of planing off the hardened edge before bending the plate homogeneity is restored, and the plate will then bend without damage.

Annealing.—The hardening effect of overstrain is removed by the process of annealing, that is, by heating to redness and cooling slowly. In the ordinary process of rolling plates or bars of iron or mild steel the metal leaves the rolls at so high a temperature that it is virtually annealed, or pretty nearly so. The case is different with plates and bars that are rolled cold: they, like wire supplied in the hard-drawn state (that is, without being annealed after it leaves the draw-plate), exhibit the higher strength and greatly reduced plasticity which result from permanent set.

Extensometers.—Much attention has been paid to the design of extensometers, or apparatus for observing the small deformation which a test-piece in tension or compression undergoes before its limit of elasticity is reached. Such observations afford the most direct means of measuring the modulus of longitudinal elasticity of the material, and they serve also to determine the limits within which the material is elastic. In such a material

¹ J. A. Ewing, *Proc. Roy. Soc.* (June, 1880).

as wrought iron the elastic extension is only about $\frac{1}{2000}$ of the length for each ton per square inch of load, and the whole amount up to the elastic limit is perhaps $\frac{1}{1000}$ of the length; with a length of 8 in., which is usual in tensile tests, it is desirable to read the extension to, say, $\frac{1}{10000}$ in. if the modulus of elasticity is to be found with fair accuracy, or if the limits of proportionality between strain to stress are under examination. Measurements taken between marks on one side of the bar only are liable to be affected by bending of the piece, and it is essential either to make independent measurements on both sides or to measure the displacement between two pieces which are attached to the bar in such a manner as to share equally the strain on both sides.

In experiments carried out by Bauschinger, independent measurements of the strains on both sides of the bar were made by using mirror micrometers of the type illustrated diagrammatically in fig. 15. Two clips *a* and *b* clasp the test-piece at the place between

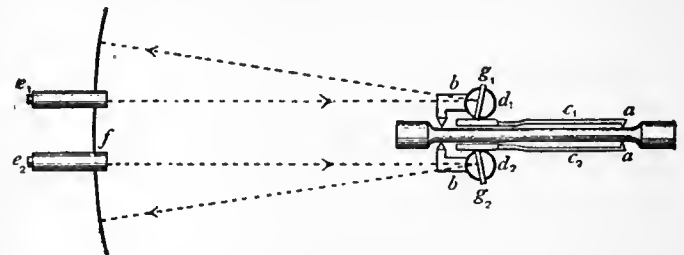

FIG. 15.

which the extension is to be measured. The clip *b* carries two small rollers *d*₁ *d*₂ which are free to rotate on centres fixed in the clip. These rollers press on two plane strips *c*₁ *c*₂ attached to the other clip. When the specimen is stretched the rollers consequently turn through angles proportional to the strain, and the amount of turning is read by means of small mirrors *g*₁ and *g*₂, fixed to the rollers, which reflect the divisions of a fixed scale *f* into the reading telescopes *e*₁ *e*₂. In Martens's extensometer each of the rollers is replaced by a rhombic piece of steel with sharp edges, one of which bears against the test-piece, while the other rests in a groove formed in the spring projecting parallel to the test-piece from the distant clip. Much

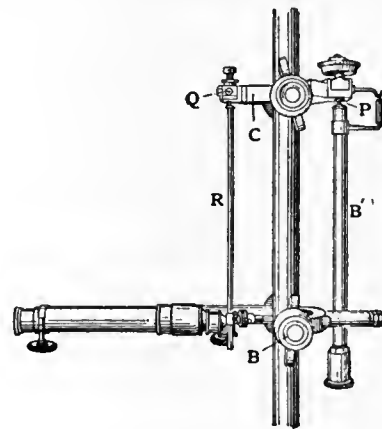

FIG. 16.

excellent work has been done by extensometers of this class, but in point of convenience of manipulation it is of great advantage to have the apparatus self-contained. J. A. Ewing has introduced a microscope extensometer of the self-contained type which is shown in fig. 16; its action will be seen by reference to the diagram fig. 17.

Two clips *B* and *C* are secured on the bar, each by means of a pair of opposed set-screws. Between the two is a rod *B'* which is hinged to *B* and has a blunt pointed upper end which makes a ball-and-socket joint with *C* at *P*. Another bar *R* hangs from *C*, and carries a mark which is read by a microscope attached to *B*. Hence, when the specimen stretches, the length of *B'* being fixed, the bar *R* is pulled up relatively to the microscope, and the amount of the movement is measured by a micrometer scale in the eyepiece. A screw at *P* serves to bring the mark on *R* into

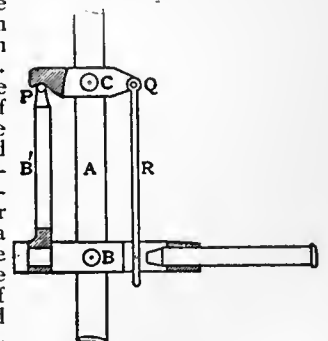

FIG. 17.

the field of view, and also to calibrate the readings of the micrometer scale. The scale allows readings to be taken to $\frac{1}{50000}$ in., by estimating tenths of the actual divisions. The arms CP and CQ are equal, and hence the movement of Q represents twice the extension of the bar under test. In another form of the instrument adapted to measure the elastic compression of short blocks the arm CQ is four times the length of CP, and consequently there is a mechanical magnification of five besides the magnification afforded by the microscope.

When the behaviour of specimens of iron, steel, or other materials possessing plasticity, is watched by means of a sensitive extensometer during the progress of a tensile test, it is in general observed that a very close proportionality between the load and the extension holds during the first stages of the loading, and that during these stages there is little or no "creeping" or supplementary extension when any particular load is left in action for a long time. The strain is a linear function of the stress, almost exactly, and disappears when the stress is removed. In other words, the material obeys Hooke's law. This is the stage of approximately perfect elasticity, and the elastic limit is the point rather vaguely defined by observations of the strain, at which a tendency to creep is first seen, or a want of proportionality between strain and stress. "Creeping" is usually the first indication that it has been reached. As the load is further augmented, there is in general a clearly marked yield-point, at which a sudden large extension ensues. In metals which have been annealed or in any way brought into a condition which is independent of the effects of earlier applications of stress, this elastic stage is well marked, and the limit of elasticity is as a rule sharply defined. But if the metal has been previously overstrained, without having had its elasticity restored by annealing or other appropriate treatment, a very different

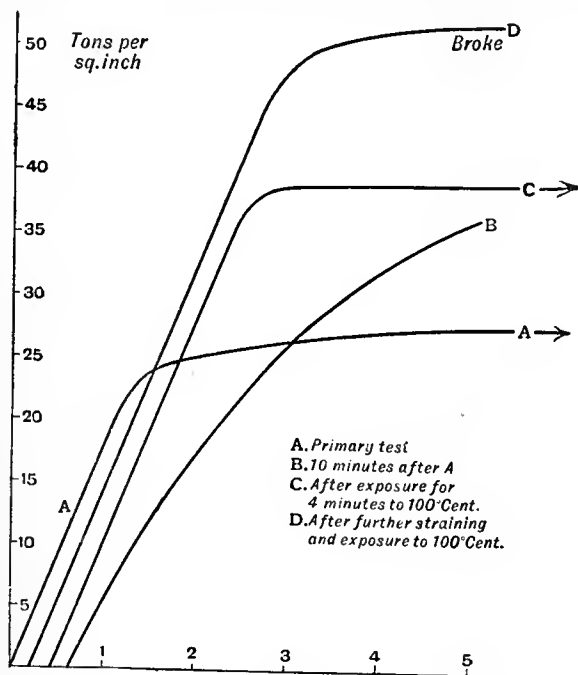

FIG. 18.

behaviour is exhibited. The yield-point may be raised, as, for instance, in wire which has been hardened by stretching, but the elasticity is much impaired, and it is only within very narrow limits, if at all, that proportionality between stress and strain is found. Subsequent prolonged rest gradually restores the elasticity, and after a sufficient number of weeks or months the metal is found to be elastic up to a point which may be much higher than the original elastic limit.¹ It has been shown by

¹ See experiments by Johann Bauschinger, *Mitt. aus dem mech.-tech. Lab. in München* (1886), and by the writer, *Proc. Roy. Soc.*, vol. xlvi. (1895). A summary of Bauschinger's conclusions will be found in Martens's book, cited above, and in Unwin's *Testing of Materials*.

J. Muir² that the rate at which this recovery of elasticity occurs depends on the temperature at which the piece is kept, and that complete recovery may be produced in iron or steel by exposure of the overstrained specimen for a few minutes to the temperature of boiling water. Figs. 18 and 19 illustrate interesting points in Muir's experiments. In these figures the geometrical device is adopted of shearing back the curves which show extension in relation to load by reducing each of the observed extensions by an amount proportional to the load, namely, by one unit of extension for each 4 tons per square inch of load. The effect is to contract the width of the diagrams, and to make any want of straightness in the curves more evident than it would otherwise be. To escape confusion, curves showing successive operations are drawn from separate origins. In the experiment of figs. 18 and 19 the material under test was a medium steel, containing about 0.4% of carbon, which when tested in the usual way showed a breaking strength of 39 tons per square inch with a well-marked elastic limit at about 22 tons. In fig. 18 the line A relates to a test of this material in its primitive condition; the loading was raised to 35 tons so as to produce a condition of severe overstrain. The load was then removed, and in a few minutes it was reapplied. The line B exhibits the effect of this application. Its curved form shows plainly that all approach to perfect elasticity has disappeared, as a consequence of the overstraining. There is now no elastic limit, no range of stress within which Hooke's law applies. With the lapse of time the curve gradually recovers its straightness, and the material, if kept at ordinary atmospheric temperature, would show almost complete recovery in a month or two. But in this instance the recovery was hastened by immersing the piece for four minutes in boiling water, and line C shows that this treatment restored practically perfect elasticity up to a limit as high as the load by which the previous overstraining had been effected. The loading in C was continued past a new yield-point; this made the elasticity again disappear, but it was restored in the same way as before, namely, by a few minutes' exposure to 100° C., and the line D shows the final test, in which the elastic limit has been raised in this manner to 45 tons. Other tests have shown that a temperature of even 50° C. has a considerable influence in hastening the recovery of elasticity after overstrain.

In the non-elastic condition which follows immediately on overstrain the metal shows much hysteresis in the relation of

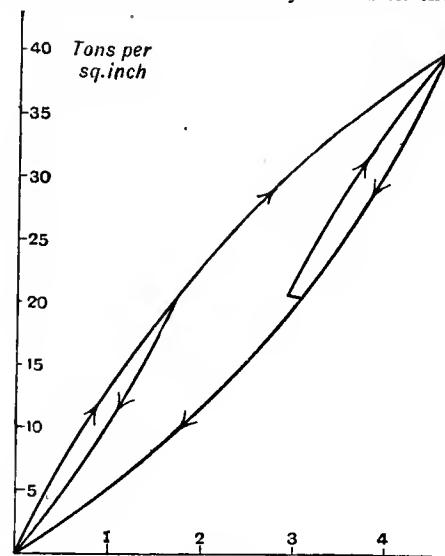

FIG. 19.

strain to stress during any cyclic repetition of a process of loading. This is illustrated in fig. 19, where the arrows indicate the sequence of the operations.

When a piece of iron or steel which has been overstrained in tension is submitted to compression, it shows, as might

² Muir, "On the Recovery of Iron from Overstrain," *Phil. Trans. A*, vol. 193 (1900).

be expected, no approach to conformity with Hooke's law until recovery has been brought about either by prolonged rest at ordinary temperature or by exposure for a short time to some higher temperature. After recovery has taken place the elastic limit in compression is found to have been lowered; that is to say, it occurs at a lower load than in a normal piece of the same metal. But it appears from Muir's experiments that the amount of this lowering is not at all equal to the amount by which the elastic limit has been raised in tension. In other words, the general effect of hardening by overstrain, followed by recovery of elasticity, is to widen the range within which a practically complete proportionality between strain and stress holds good.

Contraction of Section at Rupture.—The extension which occurs when a bar of uniform section is pulled is at first general, and is distributed with some approach to uniformity over the length of the bar. Before the bar breaks, however, a large additional amount of local extension occurs at and near the place of rupture. The material flows in that neighbourhood much more than in other parts of the bar, and the section is much more contracted there than elsewhere. The contraction of area at fracture is frequently stated as one of the results of a test, and is a useful



FIG. 20.

index to the quality of materials. If a flaw is present sufficient to determine the section at which rupture shall occur the contraction of area will in general be distinctly diminished as compared with the contraction in a specimen free from flaws, although little reduction may be noted in the total extension of the piece. Local extension and contraction of area are almost absent in cast iron and hard steel; on the other hand, they are specially prominent in wrought iron, mild steel and other metals that combine plasticity with high tensile strength. An example is shown in fig. 20, which is copied from a photograph of a broken test-piece of Whitworth mild fluid-compressed steel. The piece was of uniform diameter before the test.

Experiments with long rods show that the general extension which occurs in parts of the bar not near the break is somewhat irregular;¹ it exhibits here and there incipient local stretching, which has stopped without leading to rupture. This is, of course, due in the first instance to want of homogeneity. It may be supposed that when local stretching begins at any point in the earlier stages of the test it is checked by the hardening effect of the strain, until, finally, under greater load, a stage is reached in which the extension at one place goes on so fast that the hardening effect cannot keep pace with the increase in intensity of stress which results from diminution of area; the local extension is then unstable, and rupture ensues. Even at this stage a pause in the loading, and an interval of relief from stress, may harden the locally stretched part enough to make rupture occur somewhere else when the loading is continued.

Influence of Local Stretching on Total Elongation.—Local stretching causes the percentage of elongation which a test-piece exhibits before rupture (an important quantity in engineers' specifications) to vary greatly with the length and section of the piece tested. It is very usual to specify the length which is to exhibit an assigned percentage of elongation. This, however, is not enough; the percentage obviously depends on the relation of the transverse dimensions to the length. A fine wire 8 in. long will stretch little more in proportion to its length than a very long wire of the same quality. An 8-in. bar, say 1 in. in diameter, will show something like twice as much the percentage of elongation as a very long rod. The experiments of Barba² show that, in material of uniform quality, the percentage of

¹ See Kirkaldy's *Experiments on Fagersta Steel* (London, 1873).
² *Mém. de la soc. des ing. civ.* (1880); see also a paper by W. Hackney, "On the Adoption of Standard Forms of Test-Pieces," *Proc. Inst. Civ. Eng.* (1884).

extension is constant for test-pieces of similar form, that is to say, for pieces of various size in which the transverse dimensions are varied in the same proportion as the length. It is to be regretted that in ordinary testing it is not practicable to reduce the pieces to a standard form with one proportion of transverse dimensions to length, since tests in which the relation of length to cross-section differ give results which are incapable of direct comparison with one another.

Influence on Strength.—The form chosen for test-pieces in tension tests affects not only the extension but also the ultimate strength. In the first place, if there is a sudden or rapid change in the area of cross-section at any part of the length under tension (as at AB, fig. 21), the stress will not be uniformly distributed there. The intensity will be greatest at the edges A and B, and the piece will, in consequence, pass its elastic limit at a less value of the total load than would be the case if the change from the larger to the smaller section were gradual. In a non-ductile material rupture will for the same reason take place at AB, with a less total load than would otherwise be borne. On the other hand, with a sufficiently ductile material, although the section AB is the first to be permanently deformed, rupture will preferably take place at some section not near AB, because at and near AB the contraction of sectional area which precedes rupture is partly prevented by the presence of the projecting portions C and D. Hence, too, with a ductile material samples such as those of fig. 22, in

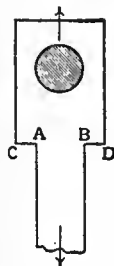

FIG. 21.

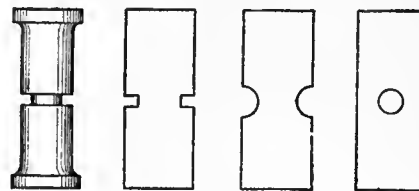

FIG. 22.

which the part of smallest section between the shoulders or enlarged ends of the piece is short, will break with a greater load than could be borne by long uniform rods of the same section. In good wrought iron and mild steel the flow of metal preceding rupture and causing local contraction of section extends over a length six or eight times the width of the piece; and, if the length throughout which the section is uniform be materially less than this, the process of flow will be rendered more difficult and the breaking load of the sample will be raised.³

These considerations have, of course, a wider application than to the mere interpretation of special tests. An important practical case is that of riveted joints, in which the metal left between the rivet holes is subjected to tensile stress. It is found to bear, per square inch, a greater pull than would be borne by a strip of the same plate if the strip were tested in the usual way with uniform section throughout a length great enough to allow complete freedom of local flow.⁴

Fracture by Tension.—In tension tests rupture may occur by direct separation over a surface which is nearly plane and normal to the line of stress. This is not uncommon in hard steel and other comparatively non-ductile materials. But in ductile materials under tension the piece generally gives way by shearing on an inclined surface. Very often the effect is a more or less perfect ring-shaped crater on one side of the break and a truncated cone on the other.

³ The greater strength of nicked or grooved specimens seems to have been first remarked by Kirkaldy (*Experiments on Wrought Iron and Steel*, p. 74, also *Experiments on Fagersta Steel*, p. 27). See also a paper by E. Richards, on tests of mild steel, *Journ. Iron and Steel Inst.* (1882).

⁴ See Kennedy's "Reports on Rivetted Joints," *Proc. Inst. Mech. Eng.* (1881-1885). In the case of mild-steel plates a drilled strip may have as much as 12% more tensile strength per square inch than an undrilled strip. With punched holes, on the other hand, the remaining metal is much weakened, for the reason referred to in the text.

Fracture by Compression.—In compression tests of a plastic material, such as mild steel, a process of flow may go on without limit; the piece (which must of course be short, to avoid buckling) shortens and bulges out in the form of a cask. This is illustrated by fig. 23 (from one of Sir W. Fairbairn's experiments), which shows the compression of a round block of steel (the original height and diameter of which are shown by the dotted lines) by a load equal to 100 tons per sq. in. of

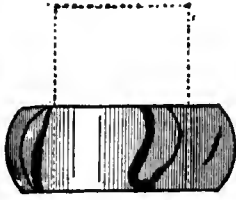

FIG. 23.

original sectional area. The surface over which the stress is distributed becomes enlarged, and the total load must be increased in a corresponding degree to maintain the process of flow.¹ The bulging often produces longitudinal cracks, as in the figure, especially when the material is fibrous as well as plastic (as in the case of wrought iron). A brittle material, such as cast iron, brick or stone, yields by shearing on inclined planes as in figs. 24 and 25, which are taken from

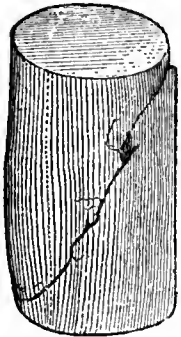

FIG. 24.

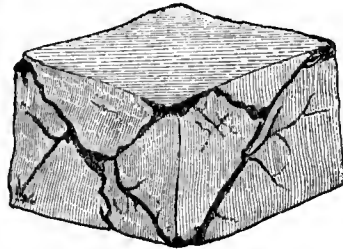

FIG. 25.

Hodgkinson's experiments on cast iron.² The simplest fracture of this kind is exemplified by fig. 24, where a single surface (approximately a plane) of shear divides the compressed block into two wedges. With cast iron the slope of the plane is such that this simplest mode of fracture can take place only if the height of the block is not less than about $\frac{2}{3}$ the width of the base. When the height is less the action is more complex. Shearing must then take place over more than one plane, as in fig. 25, so that cones or wedges are formed by which the surrounding portions of the block are split off. The stress required to crush the block is consequently greater than if the height were sufficient for shearing in a single plane.

Plane of Shear.—The inclination of the surfaces of shear, when fracture takes place by shearing under a simple stress of pull or push, is a matter of much interest, throwing some light on the question of how the resistance which a material exerts to stress of one kind is affected by the presence of stress of another kind—a question scarcely touched by direct experiment. At the shorn surface there is, in the case of tension tests, a normal pull as well as a shearing stress, and in the case of compression tests a normal push as well as shearing stress. If this normal component were absent the material (assuming it to be isotropic) would shear in the surface of greatest shearing stress, which, as has already been shown, is a surface inclined at 45° to the axis. In fact, however, it does not shear on this surface. Hodgkinson's experiments on the compression of cast iron give surfaces of shear whose normal is inclined at about 55° to the axis of stress, and Kirkaldy's, on the tension of steel, show that when rupture of a rod under tension takes place by shear the normal to the surface is inclined at about 25° to the axis. These results show that normal pull diminishes resistance to shearing and normal push increases resistance to shearing. In the case of cast iron under compression, the material prefers to shear on a section

¹ For examples, see Fairbairn's experiments on steel, *Brit. Assoc. Rep.* (1867).

² *Report of the Royal Commissioners on the Application of Iron to Railway Structures* (1849); see also *Brit. Assoc. Rep.* (1837).

where the intensity of shearing stress is only 0.94 of its value on the surface of maximum shearing stress (inclined at 45°), but where the normal push is reduced to 0.66 of the value which it has on the surface of maximum shearing stress.

Lüders's Lines.—It is interesting to refer in this connexion to the phenomenon observed in 1859 by W. Lüders³ of Magdeburg and afterwards studied more fully by L. Hartmann.⁴ When a bar of plastic metal such as mild steel, preferably flat and with a polished surface, is extended a little beyond its elastic limit, markings appear on the surface in the form of narrow bands running transversely across it. These bands are regions within which a shearing deformation has taken place, resulting from the tension, as has been explained with reference to fig. 1, and they are distinguished from the remainder of the bar because in the early stages of plastic strain the yielding is local. For the reason that has just been explained in speaking of surfaces of rupture, Lüders's lines in a rod strained by direct pull are found to be inclined, not at 45° , but at an angle more nearly normal to the axis of pull (making about 65° with it). Their inclination shows that the metal prefers to elongate by shearing on a section where p , the shearing stress is not at its maximum, because p_n the normal component—which is a pull—is greater there, and this can only mean that the presence of a normal component of the nature of a pull at any section reduces the resistance to yielding under the shearing stress which acts at that section, while similarly the presence of a normal component of the nature of a push increases the resistance to shear.

Yielding under Compound Stress.—A question of much theoretical interest and also of some practical importance is, what determines the yielding of a piece when it is subjected not to a simple pull or push alone but to a stress combined of two or of three principal stresses? According to one view, which in the absence of experimental data appears to have been taken by W. J. M. Rankine, the material yields when the greatest principal stress reaches a certain limit, irrespective of the existence of the other principal stresses. According to another view (Barré de Saint-Venant), it yields when the maximum strain reaches a certain limit, and as the strain depends in part on each of the three principal stresses this gives a different criterion. Neither the maximum stress theory nor the maximum strain theory can be regarded as satisfactory, and probably a much sounder view is that the material yields when the greatest shearing stress reaches a certain limit. Even this, however, requires some qualification in the light of what has just been said about the inclination of surfaces of shear and Lüders's lines, for it is clear from these experimental indications that resistance to shear is affected by the presence of normal stress on the plane of shear, and consequently a theory which takes account of shearing stress only as the criterion of yielding cannot be completely correct. According to the greatest shearing stress theory the yielding under compound stress depends directly on the difference between the greatest and least principal stress. In such cases of compound stress as have to be dealt with in engineering design this furnishes a criterion which though imperfect is certainly to be preferred to the criterion furnished by calculating the greatest principal stress.

Experiments on Compound Stress.—In experiments carried out by J. J. Guest (*Phil. Mag.*, 1900, vol. 50) the action of combined stresses in causing yielding was investigated by subjecting thin tubes to (1) tension alone, (2) tension and torque, (3) tension and internal (fluid) pressure, and (4) torque and internal pressure, while measurements were made of the axial strain and the twist so as to detect the first failure of elasticity. The general result of the experiments, so far as they went, was to support the view that yielding depends primarily on the greatest shearing stress, that is to say, on the difference between the greatest and least principal stresses.

Fatigue of Metals.—A matter of great practical as well as scientific interest is the destructive action which materials

³ *Dingler's Polytech. Journ.* (1860), 155, p. 18.

⁴ *Bulletin de la société d'encouragement* (1896 and 1897).

may suffer through repeated changes in their state of stress. It appears that in some if not in all materials a limited amount of stress-variation may be repeated time after time without appreciable deterioration in the strength of the piece; in the balance-spring of a watch, for instance, tension and compression succeed each other some 150 millions of times in a year, and the spring works for years without apparent injury. In such cases the stresses lie well within the elastic limits. On the other hand, the toughest bar breaks after a small number of bendings to and fro, when these pass the elastic limits, although the stress may have a value greatly short of the normal ultimate strength. A laborious research by A. Wöhler,¹ extending over twelve years, gave much important information regarding the effects on iron and steel of very numerous repeated alternations of stress from positive to negative, or between a higher and a lower value without change of sign. By means of ingeniously-contrived machines he submitted test-pieces to direct pull, alternated with complete or partial relaxation from pull, to repeated bending in one direction and also in opposite directions, and to repeated twisting towards one side and towards opposite sides. The results show that a stress greatly less than the ultimate strength (as tested in the usual way by a single application of load continued to rupture) is sufficient to break a piece if it be often enough removed and restored, or even alternated with a less stress of the same kind. In that case, however, the variation of stress being less, the number of repetitions required to produce rupture is greater. In general, the number of repetitions required to produce rupture is increased by reducing the range through which the stress is varied, or by lowering the upper limit of that range. If the greatest stress be chosen small enough, it may be reduced, removed, or even reversed many million times without destroying the piece. Wöhler's results are best shown by quoting a few figures selected from his experiments. The stresses are stated in centners per square zoll;² in the case of bars subjected to bending they refer to the top and bottom sides, which are the most stressed parts of the bar.

I. Iron bar in direct tension:—

Stress. Max. Min.	Number of Applications causing Rupture.	Stress. Max. Min.	Number of Applications causing Rupture.
480 0	800	320 0	10,141,645
440 0	106,001	440 200	2,373,424
400 0	340,853	440 240	Not broken with 4 millions.
360 0	480,852		

II. Iron bar bent by transverse load:—

Stress. Max. Min.	Number of Bendings causing Rupture.	Stress. Max. Min.	Number of Bendings causing Rupture.
550 0	169,750	400 0	1,320,000
500 0	420,000	350 0	4,035,400
450 0	481,950	300 0	Not broken with 48 millions.

III. Steel bar bent by transverse load:—

Stress. Max. Min.	Number of Bendings causing Rupture.	Stress. Max. Min.	Number of Bendings causing Rupture.
900 0	72,450	900 400	225,300
900 200	81,200	900 500	764,900—mean of two trials.
900 300	156,200	900 600	Not broken with 33½ millions.

IV. Iron bar bent by supporting at one end, the other end being loaded; alternations of stress from pull to push caused by rotating the bar:—

Stress. From + to -	Number of Rotations causing Rupture.	Stress. From + to -	Number of Rotations causing Rupture.
320	56,430	220	3,632,588
300	90,000	200	4,017,992
280	183,145	180	19,186,791
260	479,490	160	Not broken with 132½ millions.
240	909,810		

From these and other experiments Wöhler concluded that the wrought iron to which the tests refer could probably bear an indefinite number of stress changes between the limits stated (in round numbers) in the following table (the ultimate tensile strength was about 19½ tons per sq. in.):—

Stress in Tons per Sq. In.	
From pull to push	+7 to -7
From pull to no stress	13 to 0
From pull to less pull	19 to 10½

¹ Die Festigkeits-Versuche mit Eisen und Stahl (Berlin, 1870), or Zeitschr. für Bauwesen (1860-1870); see also Engineering (1871), vol. xi. For early experiments by Fairbairn on the same subject, see Phil. Trans. (1864).

² According to Bauschinger the centner per square zoll in which Wöhler gives his results is equivalent to 6.837 kilos per sq. cm., or 0.0434 ton per sq. in.

Hence it appears that the actual strength of this material varies in a ratio which may be roughly given as 3 : 2 : 1 in the three cases of (a) steady pull, (b) pull alternating with no stress, very many times repeated, and (c) pull alternating with push, very many times repeated. For steel Wöhler obtained results of a generally similar kind. His experiments were repeated by L. Spangenberg, who extended the inquiry to brass, gun-metal and phosphor-bronze.³ A considerable amount of light has been thrown on the nature of fatigue in metals by microscopic investigations, which will be referred to presently.

Resilience.—A useful application of diagrams showing the relation of strain to stress is to determine the amount of work done in straining a piece in any assigned way. The term "resilience" is conveniently used to specify the amount of work done when the strain just reaches the corresponding elastic limit. Thus a rod in simple tension or simple compression has a resilience per unit of volume = $f^2/2E$, where f is the greatest elastic pull or push. A blow whose energy exceeds the resilience (reckoned for the kind of stress to which the blow gives rise) must in the most favourable case produce a permanent set; in less favourable cases local permanent set will be produced although the energy of the blow is less than the resilience, in consequence of the strain being unequally distributed. In a plastic material a strain exceeding the limit of elasticity absorbs a relatively large amount of energy, and generally increases the resilience for subsequent strains. Fracture under successive blows, as in the testing of rails by placing them as beams on two supports, and allowing a weight to fall in the middle from a given height, results from the accumulated set which is brought about by the energy of each blow exceeding the resilience.

Internal Stress.—Professor James Thomson⁴ pointed out that the effect of any externally applied load depends, to a very material extent, on whether there is or is not initial internal stress, or, in other words, whether the loaded piece is initially in what Professor Karl Pearson has called a state of ease. Internal stress existing without the application of force from without the piece must satisfy the condition that its resultant vanishes over any complete cross-section. It may exist in consequence of set caused by previously applied forces (a case of which instances are given below), or in consequence of previous temperature changes, as in cast iron, which is thrown into a state of internal stress by unequally rapid cooling of the mass. Thus in (say) a spherical casting an outside shell solidifies first, and has become partially contracted by cooling by the time the inside has become solid. The inside then contracts, and its contraction is resisted by the shell, which is thereby compressed in a tangential direction, while the metal in the interior is pulled in the direction of the radius. Allusion has already been made to the fact, pointed out by J. Thomson, that the defect of elasticity under small loads which Hodgkinson discovered in cast iron is probably due to initial stress. In plastic metal a nearly complete state of ease is brought about by annealing; even annealed pieces, however, sometimes show, in the first loading, small defects of elasticity, which are probably due to initial stress, as they disappear when the load is reapplied.

Microscopic Examination.—Of all recent aids to a knowledge of the structure of metals, of their behaviour under stress, and of the nature of plastic strain, perhaps the most important is microscopic examination. The microscopic study of metals was initiated by H. C. Sorby as early as 1864 (see Brit. Assoc. Rep.

³ Ueber das Verhalten der Metalle bei wiederholten Anstrengungen (Berlin, 1875). For interesting notices of the fatigue of metals in railway axles, bridge ties, &c., and results of experiments showing reduced plasticity in fatigued metal, see Sir B. Baker's address to the Mechanical Section of the British Association (1885). In many of the cases where the fatigue of metals occurs in engineering practice the phenomenon is complicated by the occurrence of blows or shocks whose energy is absorbed in producing strains often exceeding the elastic limits, sometimes of a very local character in consequence of the inertia of the strained pieces. Such shocks may cause an accumulation of set which finally leads to rupture in a way that is not to be confused with ordinary fatigue of strength. The effects of the accumulation may be removed by annealing.

⁴ Camb. and Dub. Math. Journ. (Nov. 1848).

for that year). After a period of neglect, it has been pursued with much energy by a large number of observers, and has yielded results which are of fundamental importance in relation to the strength of materials. For the purpose of microscopic examination it is usually necessary to bring a small piece of the metal to a state of high surface polish, the final stage of which is performed by rubbing on a surface of wash-leather charged with a thin paste of rouge and water (see also METALLOGRAPHY). The specimen is then lightly etched in dilute acid or treated with a staining medium, such as liquorice or cocoa, to make the structure visible. When the surface is examined under a lens of suitable power it is seen to be made up of irregular areas with well-defined boundaries. The areas into which the surface is divided differ in apparent texture, and when illuminated obliquely it is found that some of them shine out brightly while others are dark; by changing the direction of the incident light other areas become bright and those previously bright become dark. These areas are the sections of crystalline grains which constitute the mass of the metal. Each grain is a crystal, the elementary portions of which are all oriented one way, but the orientation changes as we pass from grain to grain. The irregular boundaries are the chance surfaces in which one grain meets another during the progress of its crystalline growth. Etching a polished surface develops a multitude of facets which have the same orientation over any one grain, and therefore give it a uniform texture and a uniform brightness in reflecting light of any particular incidence. The size of the grains depends very much upon the previous thermal treatment to which the metal has been subjected. Sudden cooling from a high temperature tends to make the grains small, slow cooling tends to keep them large; and protracted exposure to moderately high temperature has been observed in some cases to favour the growth of very large grains.

When the metal is strained in any manner beyond its limit of elasticity the grains are found to have altered their shape, becoming lengthened in the direction in which stretch has occurred. Subsequent exposure to a temperature which is high enough to remove the mechanical hardness produced by overstraining is found to bring about a reconstruction of the grains; the original pattern is not reproduced, but the reformed grains show no direction of predominating length. Researches by J. A. Ewing and W. Rosenhain ("The Crystalline Structure of Metals," *Phil. Trans.*, 1900) showed that metals retain their crystalline character even when so severely strained as to exhibit qualities of plasticity which are at first sight inconsistent with the idea of crystalline structure. The manner in which a metal yields when the strain exceeds the elastic limit is by slips which occur in the cleavage or "gliding" planes of the individual crystals. These slips are seen under the microscope as sharply defined lines which appear on the polished surface of each grain as soon as the yield-point in any process of straining has been

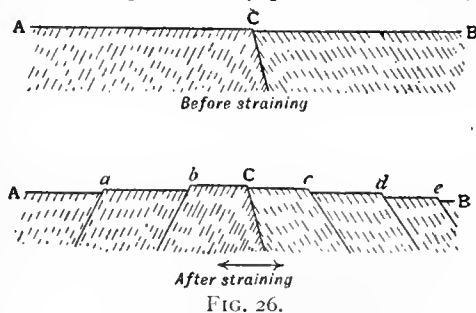

reached. Seen under normal illumination the lines are dark; seen under oblique illumination they may be made to appear as bright lines on a dark ground. The appearance of each line shows that it is a narrow step produced by the slipping of one part of the crystalline grain over another part. The diagram fig. 26 represents a section between two contiguous surface grains, having cleavage or gliding planes as indicated by the dotted lines, AB being a part of the polished surface. When straining beyond

the elastic limit takes place, as by a pull in the direction of the arrows, yielding occurs by finite amounts of slip at a limited number of places, as at *a, b, c, d, e*. This exposes short steps, which are portions of cleavage surfaces, and which, when viewed under normally incident light, appear black because they return no light to the microscope. They consequently appear as dark lines or narrow bands extending over the polished surface in directions which depend on the intersection of that surface with the planes of slip. Many such lines appear as the process of straining goes on; they are spaced at more or less regular intervals, and in general three systems of them may be observed intersecting one another. With three independent systems of slips it is clear that the grain may take any shape in the process of straining; in many cases four systems of slips are seen. In this way severe deformations occur without affecting the crystalline character of the structure, although the shape of each crystal undergoes much change. A bar of iron which has been rolled cold from a large to a small section shows, when it is polished and etched, a structure in which each grain has all the characteristics of a crystal, although the grains have been distorted into forms very different from those which are found in bars which are rolled at a red heat or are annealed after rolling. It appears that the process of straining has occurred through movements which preserve the parallelism of all the portions of each individual grain so long as continuity of the parts of the grain is preserved. In many metals, however, a further effect of severe strain is to develop twin crystals, and this implies a rotation of one group of elements through a definite angle with respect to the other elements of the same grain. Excessively severe straining, as, for instance, the squeezing of a block of lead into a thin flat plate, is found to produce a crystalline structure in which the grains have a greatly reduced size; the slips have in that case gone so far as to cause divisions and interpenetrations of the crystals.

Growth of Crystals.—Microscopic examination further shows that after severe straining the structure of a metal is far from stable, a fact which connects itself with what is observed in respect to mechanical quality. In some metals at least, and notably in lead, severe straining is followed, even at atmospheric temperatures, by a protracted crystalline growth which results in the formation of crystals which are relatively very large. A piece of ordinary sheet lead shows the effects of this growth well; it will be found, when etched, to consist in general of crystals enormously larger than any that could have survived the process of manufacture by rolling. A similar growth may readily be traced from day to day or week to week in a piece of lead which is kept under observation after being severely strained. The process of growth is greatly accelerated by raising the temperature. That some process more or less analogous to this goes on in iron and steel during the change which occurs when elastic recovery takes place after overstraining may be conjectured, though there is as yet no direct evidence on the point. The growth of large crystals which is seen to occur in lead at very moderate temperatures has perhaps a more direct relation to the changes which occur in iron or steel at temperatures high enough to produce annealing. The structure of steel as exhibited by the microscope has received much attention, notably at the hands of F. Osmond and J. O. Arnold. Microscopic examination of the low or medium carbon steel used for structural purposes shows it to consist of grains of iron (ferrite), interspersed with grains which have in general a laminated structure and are composed of alternate bands of two constituents, namely, iron and carbide of iron (Fe_3C). To these laminated grains the name of pearlite has been given. In steel such as is used for rails, containing about 0.4 or 0.5% of carbon, the grains of pearlite occupy about as large a volume of the specimen as the grains of unlaminate ferrite; but when the proportion of carbon is increased to about 0.9% the whole is a mass of pearlite having an exceedingly intimate mixture of the two constituents. This appears to be a eutectic alloy, and the same intimately blended structure is characteristic of eutectic alloys generally. Important variations in the visible structure result from quenching, annealing, and

other varieties of thermal treatment, as well as from the presence of other constituents in the steel, but to discuss these would be beyond the scope of the present article.

In experiments by Ewing and J. C. W. Humfrey ("The Fracture of Metals under repeated Alternations of Stress," *Phil. Trans.*, 1903) the microscope was employed to examine the process by which metals break through "fatigue" when subjected to repeated reversals of stress. The test-pieces were short rods overhanging from a revolving mandrel and loaded at the end so as to produce a bending moment. A part near the support, where the stresses due to bending were greatest, was polished beforehand for observation in the microscope. After a certain number of reversals the surface was examined, and the examination was repeated at intervals as the process continued. The material was Swedish iron following Hooke's law (in tension) up to 13 tons per sq. in. and having a well-marked yield-point at 14.1 tons per sq. in. It was found that the material suffered no damage from repeated reversals of a stress of 5 tons per sq. in., but that when the greatest stress was raised to 7 tons per sq. in. incipient signs of fatigue began to be apparent after many reversals, though the piece was still intact after the number of reversals had reached three millions. With a stress of 9 tons per sq. in., or more, repeated reversals brought about fracture. The first sign of fatigue as detected in the microscope was that slip lines began to appear on one or more of the crystals in the region of greatest stress: as the process went on these became more distinct and tended to broaden, and at length some of them developed into cracks which were identified as such because they did not disappear when the surface was repolished. Once a crack had formed it quickly spread, and finally the piece broke with a sharp fracture, showing practically no plastic change of form before rupture.

It may be concluded that under repeated alternations of stress fatigue, leading to fracture, is liable to occur if, and only if, the stress is such as to produce slips in some of the crystals: in other words if, and only if, the limit of elasticity is *locally* exceeded; but the limit for particular crystals may be considerably lower than what is usually taken as the limit for the metal as a whole. The resistance to slip in any one crystal depends on three things: (1) the inherent strength of its own substance, (2) the amount of support it receives from its neighbours, and (3) the orientation of the crystal with respect to the surfaces of maximum shearing stress. It may be inferred that even in the most homogeneous metal some crystals have a liability to develop slips more readily than others, and that it is with them we are concerned in dealing with the safe limits of alternating stress. The same considerations have a bearing on certain effects of heat treatment. It is well known that in steel which has been overheated (by unnecessarily prolonged exposure to a high temperature) a somewhat gross crystalline structure is developed, showing large ferrite areas not broken up by intermixture with pearlite. The resistance to slip in the large ferrite crystals is comparatively small, and hence the overheated metal has a low elastic limit and shows but little power of resisting alternating stress. By suitable heat treatment, on the other hand, it is possible to bring the metal into a state in which the crystals are small and the ferrite and pearlite are so intimately blended that there is much mutual support: the elastic limit is high and the metal is well adapted to endure stresses which would otherwise cause fatigue.

It may be asked, How is the crystal constituted to admit of elastic and plastic strain? How can slip take place without destroying the adhesion between the faces until that is destroyed by many back and forth rubbings at the surface of slip? J. A. Ewing has endeavoured to picture a molecular constitution in which the molecules are assumed to possess polar quality along three axes, and to be free to turn except in so far as they are constrained by the mutual forces between the pole of each molecule and those of its neighbours. This theory, which was developed by its author in his presidential address to the engineering section of the British Association in 1906, accords

well with many of the obscure phenomena of elastic and plastic strain, with what is known of fatigue, and with the loss of elasticity after overstrain and its subsequent recovery.

Influence of Foreign Matter.—It is a well-known characteristic of metals that small quantities of foreign matter may produce an altogether disproportionately large influence on their mechanical and other properties. The effect of small quantities of carbon in iron, of nickel in iron, of aluminium in copper, are important practical instances where a highly beneficial effect, in respect of strength and ductility, is produced. The wide and varied range of qualities possessed in steel from pure iron at one end to tool steel at the other is due to quantities of carbon which lie, for the most part, under 1%. The addition of about 3 or 4% of nickel to mild steel has given an important new structural material possessing increased strength and a high elastic limit, and retaining ample capacity for plastic strain. The presence of manganese in small quantities is known to be an essential condition of strength in mild steel. The addition of from 1½ to 3% of chromium enables steel to acquire, under suitable heat treatment, the excessive hardness desirable in armour plate and armour-piercing shell. Small quantities of vanadium added to steel improve it sufficiently to be advantageous in certain applications where saving of weight is important, notably in steel for motor carriage engines, notwithstanding the extra cost.

Data as to Strength of Steel.—A few figures may be quoted as to the strength and plasticity of steel, some of which are taken from the reports of the Engineering Standards Committee (1906-1907) specifying tests to which the material should conform.

Ordinary plates and bars of mild steel for structural purposes (bridges, ships, &c.), containing as a rule not more than 2% of carbon, have a tensile strength of 28 to 32 tons per sq. in., and an 8-in. specimen with a cross-section of from ¾ to 1½ sq. in. should stretch at least 20%. They should stand being bent cold through 180° on a radius 1½ times the thickness of the specimen, the test-piece for bending being not less than 1½ in. wide. Rivet bars, of somewhat softer steel, have a tensile strength of 26 to 30 tons, with 25% of elongation on 8 in. Steel rails, containing 0.4 or 0.5% of carbon, have a tensile strength of 38 to 48 tons and stretch 15% on a 2-in. length, the area of section of the test-piece being ¼ sq. in. Steel for axles has a tensile strength of 35 to 40 tons and stretches 25 to 30% on the 2-in. length. The elastic limit should be at least 50% of the breaking load. Steel for tires may in some cases have a tensile strength as high as 60 tons with about 8 to 10% extension in 2 in. Steel castings commonly range in tensile strength from 26 to 35 tons, with about 15% extension in 2 in. The strength of steel wire is considerably higher than that of bar or plates: 70 to 100 tons per sq. in. is not unusual, and in steel pianoforte wire it may be as high as 150 tons per sq. in.

Steel for guns, containing generally 0.3 to 0.4% of carbon, has a tensile strength of 33 to 44 tons per sq. in., with at least 17% extension in 2 in., the test-piece having the usual cross-section of ¼ sq. in. Nickel steel for guns, containing 0.4% of carbon and 4% nickel, has a strength of 45 to 55 tons and an extension of at least 16% in 2 in. Much the same figures apply to nickel-chrome steel for the same purpose, with 1% of chromium, 4% of nickel and 0.3% of carbon. Flat specimens of gun steel ¾ in. wide and 0.375 in. thick stand bending cold through 180° on a radius of 1½ in. All these tests of gun steel are made after forging and after the normal heat treatment, which consists first of oil-hardening by plunging the steel at a temperature not lower than 1500° F. into a bath of oil, and then tempering, by reheating to a temperature generally about 900° to 1000° F. This heat treatment brings the metal into a condition in which the granular structure is minute and the constituents are very thoroughly intermixed, with the result of giving a high elastic limit. Tests made on gun steel containing about 0.35% of carbon show that the yield-point occurred at 18 tons per sq. in. before the heat treatment, and at 25 tons after it, the extension remaining practically unchanged at 30% in 2 in. In nickel steel the yield-point is initially higher, but in it too the heat treatment effects a considerable improvement in this respect without reducing the extension.

It is remarkable that though the strength of wrought iron and steel may range from 20 tons per sq. in., or even less, up to 150 tons, the moduli which measure its elastic quality are nearly the same in all grades. Young's modulus *E* ranges from about 12,500 to 14,000 tons per sq. in., and the modulus of rigidity *C* from 5000 to 5700 tons per sq. in.

Graphic Representation of Distributed Stress.—Space admits of no more than a short and elementary account of some of the more simple straining actions that occur in machines and engineering structures.

The stress which acts on any plane surface AB (fig. 27), such as an imaginary cross-section of a strained piece, may be represented by a figure formed by setting up ordinates Aa, Bb, &c., from points on the surface, the length of these being made proportional to the intensity of stress at each point. This gives an ideal solid, which may be called the stress figure, whose height shows the distribution of stress over the surface which forms its base. A line drawn from g, the centre of gravity of the stress figure, parallel to the ordinates Aa, &c., determines the point c, which is called the centre of stress, and is the point through which the resultant of the distributed stress acts.

In the case of a uniformly distributed stress, ab is a plane surface parallel to AB, and c is the centre of gravity of the surface AB. When a bar is subjected to simple pull applied axially—that is to say, so that the resultant stress passes through the centre of gravity of every cross-section—the stress may be taken as (sensibly) uniformly distributed over any section not near a place where the form of the cross-section changes, provided the bar is homogeneous in respect of elastic quality and is initially in a state of ease and the stress is within the limits of elasticity.

Uniformly Varying Stress.—Uniformly varying stress is illustrated by fig. 28. It occurs (in each case for stresses within the elastic limit) in a bent beam, in a tie subjected to non-axial pull, and in a long strut or column where buckling makes the stress become non-axial. In uniformly varying stress the intensity p at any point P is proportional to the distance of P from a line MN, called the neutral axis, which lies in the plane of the stressed surface and at right angles to the direction AB, which is assumed to be that in which the intensity of stress varies most rapidly. There is no variation of stress along lines parallel to MN. If MN passes through C, the centre of gravity of the surface, as in fig. 29, it may easily be shown that the total pull stress on one side of the neutral axis is equal to the total push stress on the other side, whatever be the form of the surface AB. The resultant of the whole stress on AB is in that case a couple, whose moment may be found as follows. Let dS be an indefinitely small part of the surface at a distance x from the neutral axis through C, and let p be the intensity of stress on dS . The moment of the stress on dS is $xpdS$. But $p = p_1x/x_1 = p_2x/x_2$ (see fig. 29). The whole moment of the stress on AB is $\int xpdS = (p_1x_1)\int x^2dS = p_1I/x_1$ or p_2I/x_2 , where I is the moment of inertia of the surface AB about the neutral axis through C.

A stress such as that shown in fig. 28 or fig. 30 may be regarded as a uniformly distributed stress of intensity p_0 (which is the intensity at the centre of gravity of the surface C) and a stress of the kind shown in fig. 29. The resultant is p_0S , where S is the whole area of the surface, and it acts at a distance CD from C such that the moment $p_0S \cdot CD = (p_2 - p_0)I/x_1 = (p_1 + p_0)I/x_2$. Hence $p_2 = p_0(1 + x_2S \cdot CD/I)$, and $p_1 = p_0(1 - x_1S \cdot CD/I)$.

Simple bending occurs when a beam is in equilibrium under equal and opposite couples in the plane of the beam. Thus if a beam (fig. 31), supported at its ends, be loaded at two points so that $W_1l_1 = W_2l_2$, the portion of the beam lying between W_1 and W_2 is subjected

to a simple bending stress. On any section AB the only stress consists of pull and push, and has for its resultant a couple whose moment $M = W_1l_1 = W_2l_2$. This is called the *bending moment* at the section. If the stress be within the elastic limits it will be distributed as in fig. 32, with the neutral axis at the centre of gravity of the section. The greatest intensities of push and of pull, at the top and bottom edge respectively, are $p_1 = My_1/I$ and $p_2 = My_2/I$, and the intensity at any point at a distance y above or below C is $p = My/I$.

Bending beyond Elastic Limits.—Let the bending moment now be increased; non-elastic strain will begin as soon as either p_1 or p_2 exceeds the corresponding limit of elasticity, and the distribution of stress will be changed in consequence of the fact that the outer layers of the beam are taking set while the inner layers are still following Hooke's law. As a simple instance we may consider the case of a material strictly elastic up to a certain stress, and then so plastic that a relatively very large amount of strain is produced without further change of stress, a case not very far from being realized by soft wrought iron and mild steel. The diagram of stress will now take the form sketched in fig. 33. If the elastic limit is (say) less for compression than for tension, the diagram will be as in fig. 34, with the neutral axis shifted towards the tension side. When the beam is relieved from external load it will be left in a state of internal stress, represented, for the case of fig. 33, by the dotted lines in that figure.

In consequence of the action which has been illustrated by these figures, the moment required to break the beam cannot be calculated by taking for f the value of the ultimate tensile or compressive strength of the material in the formula $M = fl/y$, because the distribution of stress which is assumed to exist in finding this relation ceases as soon as overstraining begins.

Strain produced by Bending.—The strain produced by bending stress in a bar or beam is, as regards any imaginary filament taken along the length of the piece, sensibly the same as if that filament were directly pulled or compressed by itself. The resulting deformation of the piece consists, in the first place and chiefly, of curvature in the direction of the length, due to the longitudinal extension and compression of the filaments, and, in the second place, of transverse flexure, due to the lateral compression and extension which go along with the longitudinal extension and compression. Let l_1 (fig. 35) be a short portion of the length of a beam strained by a bending moment M (within the limits of elasticity). The beam, which we assume to be originally straight, bends in the direction of its length to a curve of radius R , such that $R/l = y_1/\delta l$, δl being the change of l by extension or compression at a distance y_1 from the neutral axis. But $\delta l = lp_1/E$, and $p_1 = My_1/I$. Hence $R = EI/M$. The transverse flexure is not, in general, of practical importance. The centre of curvature for it is on the opposite side from the centre for longitudinal flexure, and the radius is $R\sigma$, where σ is the ratio of longitudinal extension to lateral contraction under simple pull.

Ordinary Bending of Beams.—Bending combined with shearing is the mode of stress to which beams are ordinarily subject, the loads, or externally applied forces, being applied at right angles to the direction of the length. Let HK (fig. 36) be any cross-section of a beam in equilibrium. The portion B of the beam, which lies on one side of HK, is in equilibrium under the joint action of the external

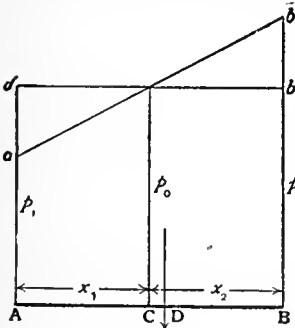

FIG. 30.

acts at a distance CD from C such that the moment $p_0S \cdot CD = (p_2 - p_0)I/x_1 = (p_1 + p_0)I/x_2$. Hence $p_2 = p_0(1 + x_2S \cdot CD/I)$, and $p_1 = p_0(1 - x_1S \cdot CD/I)$.

Simple bending occurs when a beam is in equilibrium under equal and opposite couples in the plane of the beam. Thus if a beam (fig.

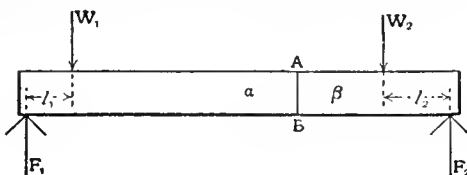

FIG. 31.

31), supported at its ends, be loaded at two points so that $W_1l_1 = W_2l_2$, the portion of the beam lying between W_1 and W_2 is subjected

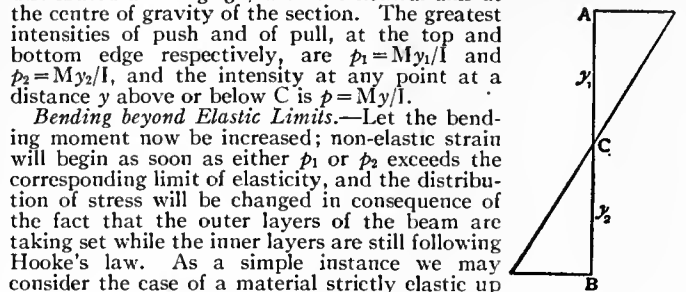

FIG. 32.

to a simple bending stress. On any section AB the only stress consists of pull and push, and has for its resultant a couple whose moment $M = W_1l_1 = W_2l_2$. This is called the *bending moment* at the section. If the stress be within the elastic limits it will be distributed as in fig. 32, with the neutral axis at the centre of gravity of the section. The greatest intensities of push and of pull, at the top and bottom edge respectively, are $p_1 = My_1/I$ and $p_2 = My_2/I$, and the intensity at any point at a distance y above or below C is $p = My/I$.

Bending beyond Elastic Limits.—Let the bending moment now be increased; non-elastic strain will begin as soon as either p_1 or p_2 exceeds the corresponding limit of elasticity, and the distribution of stress will be changed in consequence of the fact that the outer layers of the beam are taking set while the inner layers are still following Hooke's law. As a simple instance we may consider the case of a material strictly elastic up to a certain stress, and then so plastic that a relatively very large amount of strain is produced without further change of stress, a case not very far from being realized by soft wrought iron and mild steel. The diagram of stress will now take the form sketched in fig. 33. If the elastic limit is (say) less for compression than for tension, the diagram will be as in fig. 34, with the neutral axis shifted towards the tension side. When the beam is relieved from external load it will be left in a state of internal stress, represented, for the case of fig. 33, by the dotted lines in that figure.

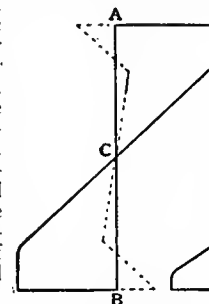

FIG. 33.

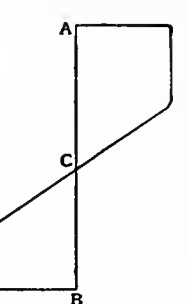

FIG. 34.

In consequence of the action which has been illustrated by these figures, the moment required to break the beam cannot be calculated by taking for f the value of the ultimate tensile or compressive strength of the material in the formula $M = fl/y$, because the distribution of stress which is assumed to exist in finding this relation ceases as soon as overstraining begins.

Strain produced by Bending.—The strain produced by bending stress in a bar or beam is, as regards any imaginary filament taken along the length of the piece, sensibly the same as if that filament were directly pulled or compressed by itself. The resulting deformation of the piece consists, in the first place and chiefly, of curvature in the direction of the length, due to the longitudinal extension and compression of the filaments, and, in the second place, of transverse flexure, due to the lateral compression and extension which go along with the longitudinal extension and compression. Let l_1 (fig. 35) be a short portion of the length of a beam strained by a bending moment M (within the limits of elasticity). The beam, which we assume to be originally straight, bends in the direction of its length to a curve of radius R , such that $R/l = y_1/\delta l$, δl being the change of l by extension or compression at a distance y_1 from the neutral axis. But $\delta l = lp_1/E$, and $p_1 = My_1/I$. Hence $R = EI/M$. The transverse flexure is not, in general, of practical importance. The centre of curvature for it is on the opposite side from the centre for longitudinal flexure, and the radius is $R\sigma$, where σ is the ratio of longitudinal extension to lateral contraction under simple pull.

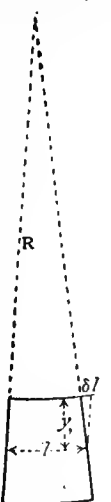

FIG. 35.

Ordinary Bending of Beams.—Bending combined with shearing is the mode of stress to which beams are ordinarily subject, the loads, or externally applied forces, being applied at right angles to the direction of the length. Let HK (fig. 36) be any cross-section of a beam in equilibrium. The portion B of the beam, which lies on one side of HK, is in equilibrium under the joint action of the external

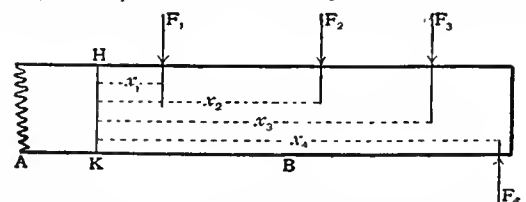

FIG. 36.

forces F_1, F_2, F_3 , &c., and the forces which the other portion A exerts on B in consequence of the state of stress at HK. The forces

$F_1, F_2, F_3, \&c.$, may be referred to HK by introducing couples whose moments are $F_1x_1, F_2x_2, F_3x_3, \&c.$ Hence the stress at HK must equilibrate, first, a couple whose moment is ΣFx , and, second, a force whose value is ΣF , which tends to shear B from A. In these summations regard must of course be had to the sign of each force; in the diagram the sign of F_4 is opposite to the sign of F_1, F_2 and F_3 . Thus the stress at HK may be regarded as that due to a bending moment M equal to the sum of the moments about the section of the externally applied forces on one side of the section (ΣFx), and a shearing force equal to the sum of the forces about one side of the section (ΣF). It is a matter of convenience only whether the forces on B or on A be taken in reckoning the bending moment and the shearing force. The bending moment causes a uniformly varying normal stress on HK of the kind already discussed; the shearing force causes a shearing stress in the plane of the section, the distribution of which will be investigated later. This shearing stress in the plane of the section is necessarily accompanied by an equal intensity of shearing stress in horizontal planes parallel to the length of the beam.

The stress due to the bending moment, consisting of longitudinal push in filaments above the neutral axis and longitudinal pull in filaments below the neutral axis, is the thing chiefly to be considered in practical problems relating to the strength of beams. The general formula $p_1 = My_1/I$ becomes, for a beam of rectangular section of breadth b and depth h , $p_1 = 6M/bh^2 = 6M/Sh$, S being the area of section. For a beam of circular section it becomes $p_1 = 32M/\pi h^3 = 8M/Sh$. The material of a beam is disposed to the greatest advantage as regards resistance to bending when the form is that of a pair of flanges or booms at top and bottom, held apart by a thin but stiff web or by cross-bracing, as in I beams and braced trusses. In such cases sensibly the whole bending moment is taken by the flanges; the intensity of stress over the section of each flange is very nearly uniform, and the areas of section of the tension and compression flanges (S_1 and S_2 respectively) should be proportioned to the value of the ultimate strengths in tension and compression f_t and f_c , so that $S_1f_t = S_2f_c$. Thus for cast-iron beams Hodgkinson recommended that the tension flange should have six times the sectional area of the compression flange. The intensity of longitudinal stress on the two flanges of an I beam is approximately M/S_1h and M/S_2h , h being the depth from centre to centre of the flanges.

Diagrams of Bending Moment and Shearing Force.—In the examination of loaded beams it is convenient to represent graphically the bending moment and the shearing force at various sections by setting up ordinates to represent the values of these quantities, and so drawing curves of bending moment and shearing force.

The area enclosed by the curve of shearing force, up to any ordinate, is equal to the bending moment at the same section. For let x be increased to $x + \delta x$, the bending moment changes to $\Sigma F(x + \delta x)$, or $\delta M = \delta x \Sigma F$. Hence the shearing force at any section is equal to the rate of change of the bending moment there per unit of the length, and the bending moment is the integral of the shearing force with respect to the length. In the case of a continuous distribution of load, it should be observed that, when x is increased to $x + \delta x$, the moment changes by an additional amount which depends on $(\delta x)^2$ and may therefore be neglected.

Distribution of Shearing Stress.—To examine the distribution of shearing stress over any vertical section of a beam, we may consider

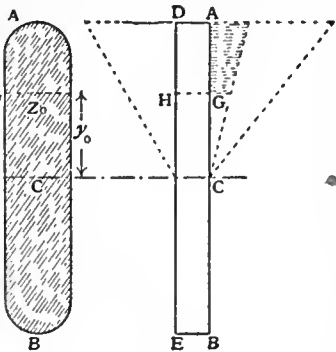

FIG. 37.

two closely adjacent sections AB and DE (fig. 37), on which the bending moments are M and $M + \delta M$ respectively. The resultant horizontal force due to the bending stresses on a piece ADHG enclosed between the adjacent sections, and bounded by the horizontal plane GH at a distance y_0 from the neutral axis, is shown by the shaded figure. This must be equilibrated by the horizontal shearing stress on GH, which is the only other horizontal force acting on the piece. At any height y the intensity of resultant horizontal stress due to the difference of

the bending moments is $y\delta M/I$, and the whole horizontal force on GH is $\frac{\delta M}{I} \int_{y_0}^{y_1} y_1 y_2 dy$, z being the breadth. If q be the intensity of horizontal shearing stress on the section GH, whose breadth is z_0 , we have

$$qz_0\delta x = \frac{\delta M}{I} \int_{y_0}^{y_1} y_1 y_2 dy.$$

But $\delta M/\delta x$ is the whole shearing force Q on the section of the beam. Hence

$$q = \frac{Q}{z_0 I} \int_{y_0}^{y_1} y_1 y_2 dy;$$

and this is also the intensity of vertical shearing stress at the distance

y_0 from the neutral axis. This expression may conveniently be written $q = QAy/z_0 I$, where A is the area of the surface AG and y the distance of its centre of gravity from the neutral axis. The intensity q is a maximum at the neutral axis and diminishes to zero at the top and bottom of the beam. In a beam of rectangular section the value of the shearing stress at the neutral axis is $q \text{ max.} = \frac{3}{2} Q/bh$. In other words, the maximum intensity of shearing stress on any section is $\frac{3}{2}$ of the mean intensity. Similarly, in a beam of circular section the maximum is $\frac{4}{3}$ of the mean. This result is of some importance in application to the pins of pin-joints, which may be treated as very short beams liable to give way by shearing.

In the case of an I beam with wide flanges and a thin web, the above expression shows that in any vertical section q is nearly constant in the web and insignificantly small in the flanges. Practically all the shearing stress is borne by the web, and its intensity is very nearly equal to Q divided by the area of section of the web.

Principal Stresses in a Beam.—The foregoing analysis of the stresses in a beam, which resolves them into longitudinal pull and push, due to bending moment, along with shear in longitudinal and transverse planes, is generally sufficient in the treatment of practical cases. If, however, it is desired to find the direction and magnitude of the principal stresses at any point we may proceed thus:—

Let AC (fig. 38) be an indefinitely small portion of the horizontal section of a beam, on which there is only shearing stress, and let AB be an indefinitely small portion of the vertical section at the same place, on which there is shearing and normal stress. Let q be the intensity of the shearing stress, which is the same on AB and AC, and let p be the intensity of normal stress on AB: it is required to find a third plane BC, such that the stress on it is wholly normal, and to find r , the intensity of that stress. Let θ be the angle (to be determined) which BC makes with AB. Then the equilibrium of the triangular wedge ABC requires that

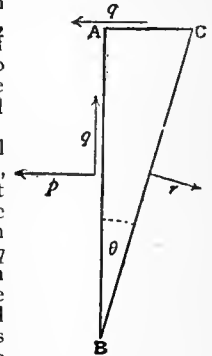

FIG. 38.

$$rBC \cos \theta = p \cdot AB + q \cdot AC, \text{ and } rBC \sin \theta = q \cdot AB;$$

or

$$(r - p) \cos \theta = q \sin \theta, \text{ and } r \sin \theta = q \cos \theta.$$

Hence,

$$q^2 = r(r - p),$$

$$\tan 2\theta = 2q/p,$$

$$r = \frac{1}{2}p \pm \sqrt{q^2 + \frac{1}{4}p^2}.$$

The positive value of r is the greater principal stress, and is of the same sign as p . The negative value is the lesser principal stress which occurs on a plane at right angles to the former. The equation for θ gives two values corresponding to the two planes of principal stress. The greatest intensity of shearing stress occurs on the pair of planes inclined at 45° to the planes of principal stress, and its value is $\sqrt{q^2 + \frac{1}{4}p^2}$.

Deflexion of Beams.—The deflexion of beams is due partly to the distortion caused by shearing, but chiefly to the simple bending which occurs at each vertical section. As regards the second, which in most cases is the only important cause of deflexion, we have seen that the radius of curvature R at any section, due to a bending moment M , is EI/M , which may also be written Ey_1/p_1 . Thus beams of uniform strength and depth (and, as a particular case, beams of uniform section subjected to a uniform bending moment) bend into a circular arc. In other cases the form of the bent beam, and the resulting slope and deflexion, may be determined by integrating the curvature throughout the span, or by a graphic process, which consists in drawing a curve to represent the beam with its curvature greatly exaggerated, after the radius of curvature has been determined for a sufficient number of sections. In all practical cases the curvature is so small that the arc and chord are of sensibly the same length. Calling i the angle of slope, and u the dip or deflexion from the chord, the equation to the curve into which an originally straight beam bends may be written

$$\frac{du}{dx} = i; \quad \frac{d^2u}{dx^2} = \frac{di}{dx} = \frac{EI}{M}$$

Integrating this for a beam of uniform section, of span L , supported at its ends and loaded with a weight W at the centre, we have, for the greatest slope and greatest deflexion, respectively, $i_1 = WL^2/16EI$, $u_1 = WL^3/48EI$. If the load W is uniformly distributed over L , $i_1 = WL^2/24EI$ and $u_1 = 5WL^3/384EI$.

The additional slope which shearing stress produces in any originally horizontal layer is q/C , where q is, as before, the intensity of shearing stress and C is the modulus of rigidity. In a round or rectangular bar the additional deflexion due to shearing is scarcely appreciable. In an I beam, with a web only thick enough to resist shear, it may be a somewhat considerable proportion of the whole.

Torsion of Solid and Hollow Shafts.—Torsion occurs in a bar to which equal and opposite couples are applied, the axis of the bar being the axis of the couples, and gives rise to shearing stress in planes perpendicular to the axis. Let AB (fig. 39) be a uniform circular shaft held fast at the end A, and twisted by a couple applied in the plane BB. Assuming the strain to be within the limits of

elasticity, a radius CD turns round to CD', and a line AD drawn at any distance r from the axis, and originally straight, changes into the helix AD'. Let θ be the angle which this helix makes with lines parallel to the axis, or in other words the angle of shear at the distance

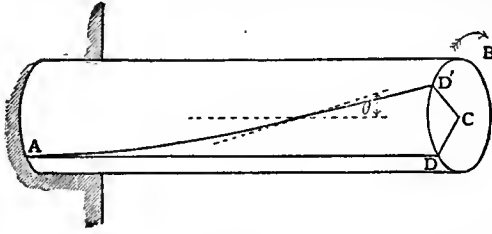

FIG. 39.

r from the axis, and let i be the angle of twist DCD'. Taking two sections at a distance dx from one another, we have the arc $\theta dx = r di$. Hence q , the intensity of shearing stress in a plane of cross-section, varies as r , since $q = C\theta = Cr di/dx$. The resultant moment of the whole shearing stress on each plane of cross-section is equal to the twisting moment M . Thus

$$\int 2\pi r^2 q dr = M.$$

Calling r_1 the outside radius (where the shearing stress is greatest) and q_1 its intensity there, we have $q = r q_1 / r_1$, and hence, for a solid shaft, $q_1 = 2M / \pi r_1^3$. For a hollow shaft with a central hole of radius r_2 the same reasoning applies: the limits of integration are now r_1 and r_2 , and

$$q_1 = \frac{2M r_1}{\pi (r_1^4 - r_2^4)}.$$

The lines of principal stress are obviously helices inclined at 45° to the axis.

If the shaft has any other form of section than a solid or symmetrical hollow circle, an originally straight radial line becomes warped when the shaft is twisted, and the shearing stress is no longer proportional to the distance from the axis. The twisting of shafts of square, triangular and other sections has been investigated by Saint-Venant. In a square shaft (side = h) the stress is greatest at the middle of each side, and its intensity there is $q_1 = M / 0.281 h^3$.

For round sections the angle of twist per unit of length is $i = \frac{q_1}{C r_1} = \frac{2M}{\pi C r_1^4}$ in solid and $\frac{2M}{\pi C (r_1^4 - r_2^4)}$ in hollow shafts.

In what has been said above it is assumed that the stress is within the limit of elasticity. When the twisting couple is increased so that this limit is passed, plastic yielding begins in the outermost layer, and a larger proportion of the whole stress falls to be borne by layers nearer the centre. The case is similar to that of a beam bent beyond the elastic limit, described above. If we suppose the process of twisting to be continued, and that after passing the limit of elasticity the material is capable of much distortion without further increase of shearing stress, the distribution of stress on any cross section will finally have an approximately uniform value q' , and the moment of torsion will be

$$\int_{r_2}^{r_1} 2\pi r^2 q' dr = \frac{2}{3} \pi q' (r_1^3 - r_2^3).$$

In the case of a solid shaft this gives for M a value greater than it has when the stress in the outermost layer only reaches the intensity q' , in the ratio of 4 to 3. It is obvious from this consideration that the ultimate strength of a shaft to resist torsion is no more deducible from a knowledge of the ultimate shearing strength of the material than the ultimate strength of a beam to resist bending is deducible from a knowledge of the tensile and crushing strength. It should be noticed also that as regards ultimate strength a solid shaft has an important advantage over a hollow shaft of the same elastic strength, or a hollow shaft so proportioned that the greatest working intensity of stress is the same as in the solid shaft.

Twisting Combined with Bending.—This important practical case is realized in a crank-shaft (fig. 40). Let a force P be applied at the crank-pin A at right angles to the plane of the crank.

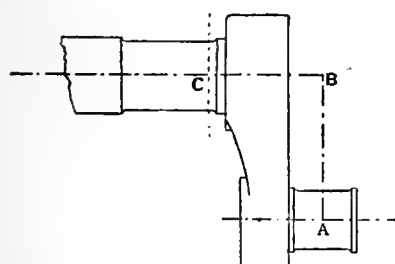

FIG. 40.

At any section of the shaft C (between the crank and the bearing) there is a twisting moment $M_1 = P \cdot AB$ and a bending moment $M_2 = P \cdot BC$. There is also a direct shearing force P , but this does not require to be taken into account in calculating the stress at points at the top or bottom of the circumference (where the intensity is greatest), since the direct shearing stress is distributed so that its intensity is zero at these points. The stress there is consequently made up of longitudinal normal stress (due to

bending), $p_1 = 4M_2 / \pi r_1^3$, and shearing stress (due to torsion), $q_1 = 2M_1 / \pi r_1^3$. Combining these, as in § 64, we find for the principal stresses $r = 2 \sqrt{M_2^2 + M_1^2} / \pi r_1^3$, or $r = 2P(BC \pm AC) / \pi r_1^3$. The greatest shearing stress is $2P \cdot AC / \pi r_1^3$, and the axes of principal stress are inclined so that $\tan 2\theta = M_1 / M_2 = AB / BC$. The axis of greater principal stress bisects the angle ACB.

Long Columns and Struts: Compression and Bending.—A long strut or pillar, compressed by forces P applied at the ends in the direction of the axis, becomes unstable as regards flexure when P exceeds a certain value. Under no circumstances can this value of P be exceeded in loading a strut. But it may happen that the intensity of stress produced by smaller loads exceeds the safe compressive strength of the material, in which case a lower limit of load must be chosen. If the applied load is not strictly axial, if the strut is not initially straight, if it is subject to any deflexion by transverse forces, or if the modulus of elasticity is not uniform over each cross-section—then loads smaller than the limit which causes instability will produce a certain deflexion which increases with increase of load, and will give rise to a uniformly varying stress of the kind illustrated in figs. 28 and 30. We shall first consider the ideal case in which the forces at the ends are strictly axial, the strut perfectly straight and free from transverse loads and perfectly symmetrical as to elasticity. Two conditions have to be distinguished—that in which the ends are held by pins or sockets which leave them free to rock, and that in which the ends are held fixed. Suppose in the first place that the ends are free to rock. The value of the load which causes instability will be found by considering what force P applied to each end would suffice to hold an originally straight strut in a bent state, supposing it to have received a small amount of elastic curvature in any way. It is shown by Euler that the force required to maintain the strut in its curved state is $P = \pi^2 EI / L^2$, and is independent of the deflexion. This means that with this particular value of P (which for brevity we shall write P_1) the strut will be in neutral equilibrium when bent; with a value of P less than P_1 it will be stable; with a greater value it will be unstable. Hence a load exceeding P_1 will certainly cause rupture. The value $\pi^2 EI / L^2$ applies to struts with ends free to rock. If the ends are fixed the effective length for bending is reduced by one half, so that P_1 then is $4\pi^2 EI / L^2$. When one end is fixed and the other is free to rock P_1 has an intermediate value, probably about $9\pi^2 EI / 4L^2$.

The above theory assigns P_1 as a limit to the strength of a strut on account of flexural instability; but a stress less than P_1 may cause direct crushing. Let S be the area of section, and f_c the strength of the material to resist crushing. Thus a strut which conforms to the ideal conditions specified above will fail by simple crushing if $f_c S$ is less than P_1 , but by bending if $f_c S$ is greater than P_1 . Hence with a given material and form of section the ideal strut will fail by direct crushing if the length is less than a certain multiple of the least breadth (easily calculated from the expression for P_1), and in that case its strength will be independent of the length; when the length is greater than this the strut will yield by bending, and its strength diminishes rapidly as the length is increased.

But the conditions which the above theory assumes are never realized in practice. The load is never strictly axial, nor the strut absolutely straight to begin with, nor the elasticity uniform. The result is that the strength is in all cases less than either $f_c S$ or P_1 , and the results of experiments are best expressed by means of a formula, which is in part empirical, giving continuous values for struts of any length. For very short struts we have seen that the ideal breaking load is $f_c S$, and for very long struts it is $\pi^2 EI / L^2$. If we write $P = f_c S / (1 + f_c S L^2 / \pi^2 EI)$, we have a formula which gives correct values in these two extreme cases, and intermediate values for struts of medium length. By writing this $P = f_c S / (1 + c S L^2 / I)$, and treating f and c as empirical constants, we have a practical formula which fits in well with experimental results and is applicable to struts of any length when the ends are free to rock. For fixed ends $\frac{1}{2}c$ is to be taken in place of c .

Bursting Strength of Circular Cylinders and Spheres.—Space remains for the consideration of only one other mode of stress, of great importance from its occurrence in boilers, pipes, hydraulic and steam cylinders and guns. The material of a hollow cylinder, subjected to pressure from within, is thrown into a stress of circumferential pull. When the thickness t is small compared with the radius R , we may treat this stress as uniformly distributed over the thickness. Let p be the intensity of fluid pressure within a hollow circular cylinder, and let f be the intensity of circumferential stress. Consider the forces on a small rectangular plate (fig. 41), with its sides parallel and perpendicular to the direction of the axis, of length l and width $R\delta\theta$, $\delta\theta$ being the small angle it subtends at the axis. Whatever forces act on this plate in the direction of the axis are equal and opposite. The remaining forces, which are in equilibrium,

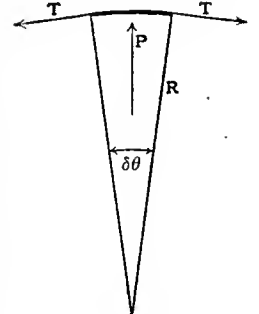

FIG. 41.

are P , the total pressure from within, and a force T at each side due to the circumferential stress. $P = pR\delta\theta$ and $T = flt$. But by the triangle of forces (fig. 42) $P = T\delta\theta$. Hence $f = pR/l$.

The ends of the cylinder may or may not be held together by longitudinal stress in the cylinder sides; if they are, then, whatever

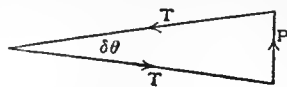

FIG. 42.

be the form of the ends, a transverse section, the area of which is $2\pi Rl$, has to bear a total force $p\pi R^2$. Hence, if f' be the intensity of longitudinal stress, $f' = pR/2l = \frac{1}{2}f$.

A thin hollow sphere under internal pressure has equal circumferential pull in all directions. To find its value consider the plate of fig. 42. There are now four equal forces T , on each of the four sides, to equilibrate the radial force P . Hence $P = 2T\delta\theta$ and $f = pR/2l$.

Thick Cylinder.—When the thickness is not small compared with the radius, the radial pressure is transmitted from layer to layer with reduced intensity, and the circumferential pull diminishes towards the outside. In the case of a thick cylinder with free ends¹ we have to deal at any point with two principal stresses, radial and circumferential, which may be denoted by p and p' respectively. Supposing (as we may properly do in dealing with a cylinder which is not very short) that a transverse section originally plane remains plane, the longitudinal strain is uniform. Since there is no longitudinal stress this strain is due entirely to the lateral action of the stresses p and p' , and its amount is $(p+p')/\sigma E$. Hence at all points $p+p' = \text{constant}$.² Further, by considering the equilibrium of any thin layer, as we have already considered that of a thin cylinder, we have $\frac{d}{dr}(pr) = p'$.

These two equations give by integration, $p = C + C'/r^2$, and $p' = C - C'/r^2$.

If r_1 be the external and r_2 the internal radius, and p_0 the pressure on the inner surface, the conditions that $p = p_0$ when $r = r_2$ and $p = 0$ when $r = r_1$ give $C = -p_0 r_2^2 / (r_1^2 - r_2^2)$ and $C' = -C r_1^2$. Hence the circumferential stress at any radius r is $p' = -p_0 r_2^2 (1 + r_1^2/r^2) / (r_1^2 - r_2^2)$. At the inside, where this is greatest, its value is $-p_0 (r_1^2 + r_2^2) / (r_1^2 - r_2^2)$ —a quantity always greater than p_0 , however thick the cylinder is.

In the construction of guns various devices have been used to equalize the circumferential tension. With cast guns a chilled core has been employed to make the inner layers solidify and cool first, so that they are afterwards compressed by the later contraction of the outer layers. In guns built up of wrought-iron or steel hoops the hoops are bored small by a regulated amount and are shrunk on over the barrel or over the inner hoops. In J. A. Longridge's system, largely used for heavy ordnance, the gun is made by winding steel wire or ribbon, with suitable initial tension, on a central steel tube.

The circumferential stress at any point of a thick hollow sphere exposed to internal fluid pressure is found, by a process like that of the last paragraph, to be $-p_0 r_2^3 (1 + r_1^3/2r^3) / (r_1^3 - r_2^3)$, which gives, for the greatest tension, the value

$$-p_0 (r_1^3 + 2r_2^3) / 2(r_1^3 - r_2^3). \quad (\text{J. A. E.})$$

STRESA, a village of Piedmont, Italy, in the province of Novara, situated on the west side of Lago Maggiore, on the Simplon railway, 10 m. N. of Arona, 673 ft. above sea-level. Pop. (1901), 1477. It is remarkable for the beauty of its scenery and for its fine villas, and is a favourite resort in spring, summer and autumn.

STRICKLAND, AGNES (1806–1874), English historical writer, was born in 1806, the third daughter of Thomas Strickland, of Reydon Hall, Suffolk. Her first literary efforts were historical romances in verse in the style of Walter Scott—*Worcester Field* (published without date), *Demetrius and other Poems* (1833). From this she passed to prose histories, written in a simple style for the young. A picturesque sketch of the *Pilgrims of Walsingham* appeared in 1835, two volumes of *Tales and Stories from History* in the following year. Then, with the assistance of her sister, she projected a more ambitious work, *The Lives of the Queens of England*, from Matilda of Flanders to Queen Anne. The first volume appeared in 1840, the twelfth and last in 1840. Miss Strickland was a warm partisan on the side of royalty and

¹This condition is realized in practice when the fluid causing internal pressure is held in by a piston, and the stress between this piston and the other end of the cylinder is taken by some other part of the structure than the cylinder sides.

²The solution which follows in the text is applicable even when there is longitudinal stress, provided that the longitudinal stress is uniformly distributed over each transverse section. If we call this stress p'' , the longitudinal strain is $p''/E + (p+p')/\sigma E$. Since the whole strain is uniform, and p'' is uniform, the sum of p and p' is constant at all points, as in the case where the ends are free.

the church, but she made industrious study of "official records and other public documents," gave copious extracts from them, and drew interesting pictures of manners and customs. While engaged on this work she found time in 1843 to edit the *Letters of Mary, Queen of Scots*, whose innocence she championed with enthusiasm. In 1850 she followed up her *Queens of England* with the *Lives of the Queens of Scotland*, completing the series in eight volumes in 1859. Unresting in her industry, she turned next to the *Bachelor Kings of England*, about whom she published a volume in 1861. The *Lives of the Seven Bishops* followed in 1866—after a longer interval, part of which was employed in producing an abridged version of her *Queens of England*. Her last work was the *Lives of the Last Four Stuart Princesses*, published in 1872. In 1871 she obtained a civil-list pension of £100 in recognition of her merits. She died on the 8th of July 1874.

A *Life* by her sister, Jane Margaret Strickland, appeared in 1887.

STRICKLAND, HUGH EDWIN (1811–1853), English naturalist and geologist, was born at Righton, in the East Riding of Yorkshire, on the 2nd of March 1811, and was grandson of Sir George Strickland, Bart. As a lad he acquired a taste for natural history which dominated his life. He received his early education from private tutors and in 1829 entered Oriel College, Oxford. He attended the anatomical lectures of Dr John Kidd and the geological lectures of Dr W. Buckland and he became greatly interested both in zoology and geology. He graduated B.A. in 1831, and proceeded to M.A. in the following year. Returning to his home at Cracombe House, near Tewkesbury, he began to study the geology of the Vale of Evesham, communicating papers to the Geological Society of London (1833–1834). He also gave much attention to ornithology. Becoming acquainted with Murchison he was introduced to William John Hamilton (1805–1867) and accompanied him in 1835 in a journey through Asia Minor, the Thracian Bosphorus and the Island of Zante. Mr Hamilton afterwards published the results of this journey and of a subsequent excursion by himself to Armenia in *Researches in Asia Minor, Pontus and Armenia* (1842). After his return in 1836 Strickland brought before the Geological Society several papers on the geology of the districts he had visited in southern Europe and Asia. He also described in detail the drift deposits in the counties of Worcester and Warwick, drawing particular attention to the fluviatile deposits of Crothorne in which remains of hippopotamus, &c., were found. With Murchison he read before the Geological Society an important paper "On the Upper Formations of the New Red Sandstone System in Gloucestershire, Worcestershire and Warwickshire" (*Trans. Geol. Soc.*, 1840). In other papers he described the Bristol Bone-bed near Tewkesbury and the Ludlow Bone-bed of Woolhope. He was author likewise of ornithological memoirs communicated to the Zoological Society, the *Annals and Magazine of Natural History* and the *British Association*. He also drew up the report, in 1842, of a committee appointed by the British Association to consider the rules of zoological nomenclature. He was one of the founders of the Ray Society suggested in 1843 and established in 1844, the object being the publication of works on natural history which could not be undertaken by scientific societies or by publishers. For this society Strickland corrected, enlarged and edited the MS. of Agassiz for the *Bibliographia Zoologica et Geologica* (1848). In 1845 he edited with J. Buckman a second and enlarged edition of Murchison's *Outline of the Geology of the neighbourhood of Cheltenham*. In 1846 he settled at Oxford, and two years later he issued in conjunction with Dr A. G. Melville a work on *The Dodo and its kindred*. In 1850 he was appointed deputy reader in geology at Oxford during the illness of Buckland, and in 1852 he was elected F.R.S. In the following year, after attending the meeting of the British Association at Hull, he went to examine the cuttings from the Manchester, Sheffield & Lincolnshire railway near Retford, and he was there knocked down and killed by a train on the 14th of September 1853. He was buried at Deerhurst church near Tewkesbury, where a memorial window was erected.

See *Memoirs of H. E. Strickland*, by Sir William Jardine, Bart. (1858).

STRIEGAU, a town of Germany, in the Prussian province of Silesia, on the Striegau Water (*Striegauer Wasser*), 30 m. by rail S.W. of Breslau. Pop. (1905), 13,427. It contains four Roman Catholic churches, among which is that of St Peter and St Paul, with a vaulted roof 100 ft. in height, the highest in Silesia; a Protestant church and numerous educational and charitable institutions. The chief industries of the place are the making of cigars, malt and machinery; also of albums, portfolios and other articles in leather. Granite is quarried in the neighbourhood and there is an extensive trade in grain. It was near Striegau that Frederick the Great gained the important victory usually named after the village of Hohenfriedberg, on the 4th of June 1745. The town rights of Striegau date from 1242.

STRIKES AND LOCK-OUTS. A strike, in the labour sense, is a stoppage of work by common agreement on the part of a body of work-people for the purpose of obtaining or resisting a change in the conditions of employment. The body of work-people may be large or small, and the cessation of work may be simultaneous or gradual; e.g. if the notices to cease work happen to expire at different dates, the cessation may nevertheless be a strike, provided it takes place as the result of a common agreement. It will be seen from the above definition that a strike, though the immediate result of an agreement, formal or tacit, on the part of work-people to withhold their labour, may originate in a demand on the part of the employer as well as on the part of the employés. In the former case the stoppage is often (though loosely) termed a "lock-out." It is obvious, however, that to distinguish stoppages as strikes or lock-outs according to the source of the original demand for a change of conditions would lead to a very arbitrary and misleading classification. Frequently it is not easy to say which side made the original demand to which the dispute is to be attributed, and frequently a stoppage is the result of a break-down of negotiations in the course of which demands have been made by both sides. Moreover, in so far as the distinction can be drawn, it would lead to the result that in almost all cases a dispute in times of improving trade would be termed a strike, and in times of declining trade a lock-out. It is not possible to frame an entirely satisfactory definition of a lock-out which shall enable it always to be discriminated from a strike. It may be noticed that the attempt to make this distinction has been abandoned in the board of trade statistics since 1894, both kinds of stoppages being now included under the comprehensive title of "trade disputes."

The only basis of distinction between a "strike" and a "lock-out," which is sufficiently definite for precise or statistical purposes, is the source from which the actual notice to cease work emanates, cessations resulting from notices given by the employers being termed "lock-outs," while those which either result from notices given by the men, or from their withdrawal from work without notice, would be termed "strikes." But whether the term "lock-out" be restricted as above, or applied, as in the popular use of the term, to any dispute in which the employers appear to be the aggressors, the distinction does not afford a sound basis for the statistical classification of disputes. The source of the actual notices to leave work is often quite an unimportant matter; while, on the other hand, if the ordinary current use of the terms be followed, there will be many disputes which, according to the workmen's view, should be termed lock-outs, and, according to the employers, should be termed strikes—a difficulty which was well illustrated in the controversy as to whether the "strike clauses" in admiralty contracts could be invoked in the case of work stopped through the engineering dispute of 1897. In the present article, therefore, no distinction is drawn for statistical purposes between a strike and a lock-out.

Another distinction, perhaps of greater importance than the above, but which in practice it is sometimes difficult to draw, is between a stoppage in pursuance of a trade dispute and a stoppage due to a bona-fide dismissal or change of employment arising from the intention of an employer to cease to employ a particular set of men, or of a group of workmen to cease to work for a particular employer. Generally speaking, a stoppage may rightly be termed a trade dispute if there be an

intention on the part of both parties (at least at the beginning) to resume the relations of employer and employed on the satisfaction of certain specified conditions. Where the willingness to resume this relation exists on one side only the question is more difficult, and accordingly it is not uncommon for an employer to deny the existence of a trade dispute, although the men formerly in his employ may be actually drawing "strike pay" from their unions and "picketing" his works to prevent their places being filled. Such cases sometimes arise when the workmen consider that the dismissal of some of their colleagues is due not to personal faults or slackness of employment, but to some collective action which they have taken, or to their membership of some organization. Broadly speaking, however, the distinction is that a trade dispute is a temporary stoppage entered into to obtain or to resist a change of conditions of employment.

The essence of a strike or lock-out is a refusal on the part of a number of workmen collectively or of an employer to renew contracts of employment except on certain changed conditions. This simple situation may be complicated by actual breaches of contract, as when a body of work-people leave work without notice, or by attempts on their part to prevent other persons from entering into contracts of service, or to persuade other persons to terminate or break their contracts. But such features as these, though common to many strikes, are not essential. The question of the legal position of strikes, and of the methods adopted for the conduct of strikes, is discussed below. Here it is only necessary to point out that strikes, as such, are incidents arising out of the modern relationship of free contract as between employers and workmen, and have little real analogy with the revolts of servile or semi-servile labour in ancient or medieval times.

Trade Disputes in the United Kingdom.

Since 1888 the board of trade have kept a record of strikes and lock-outs in the United Kingdom. The following table, based on the official returns published by that department, shows the number and importance of these stoppages in the United Kingdom from 1893 to 1907:—

Year.	Number of Disputes.	Number of Work-people affected.			Aggregate Duration in Working Days.
		Directly.	Indirectly.	Total.	
1893	615	594,149	40,152	634,301	30,467,765
1894	929	257,314	67,934	325,248	9,529,010
1895	745	207,239	55,884	263,123	5,724,670
1896	926	147,950	50,240	198,190	3,746,368
1897	864	167,453	62,814	230,267	10,345,523
1898	711	200,769	53,138	253,907	15,289,478
1899	719	138,058	42,159	180,217	2,516,416
1900	648	135,145	53,393	188,538	3,152,694
1901	642	111,437	68,109	179,546	4,142,287
1902	442	116,824	139,843	256,667	3,479,255
1903	387	93,515	23,386	116,901	2,338,668
1904	355	56,380	30,828	87,208	1,484,220
1905	358	67,653	25,850	93,503	2,470,189
1906	486	157,872	59,901	217,773	3,028,816
1907	601	100,728	46,770	147,498	2,162,151

It should be noted that by "indirectly affected" are meant the work-people employed in the same establishments as those on strike, who are thrown out of employment owing to the strike, but are not themselves engaged in it. The board of trade statistics do not take into account the persons employed in kindred trades who are indirectly affected.

An important thing to note about the above statistics is that in many years they are dominated by a few large disputes. Some of the larger cases are shown on the following page.

In 1907 487 of the recorded disputes (or about four-fifths of the whole number) accounted for less than one-third of the total time lost, and this, it is to be remembered, is after the very small disputes have been excluded.

By "aggregate duration" or "time lost" is meant the product of the number affected multiplied by the duration of the dispute in working days, with some allowance for those

who have found work elsewhere or been replaced by others. Though this figure is the best general index of the importance of the disputes of each year, it is but a rough approximation to the time actually lost through disputes.

when there is most room for bona-fide disagreement as to the conditions of the labour market. These are undoubtedly the most critical times in the relations of employers and employed, but the disturbing influence of accidental causes is too great

Year.	Principal Disputes of the Year.			All other Disputes.		
	Trade and Locality.	Number of Work-people affected.	Aggregate Duration in Working Days.	Number of Disputes.	Number of Work-people affected.	Aggregate Duration in Working Days.
1893	{ Coal Miners (Federated Districts)	300,000	21,137,000	} 613	244,301	7,830,765
	{ Coal Miners (South Wales and Monmouth)	90,000	1,500,000			
1894	Coal Miners (Scotland)	70,000	5,600,000	928	255,248	3,929,010
1895	Boot and Shoe Operatives	46,000	1,564,000	744	217,123	4,160,670
1897	Engineers, Machinemen and others.	} 47,500	} 5,731,000	863	182,767	4,614,523
1898	{ Engineers, Machinemen and others—continued } { Coal Miners (South Wales and Monmouth)			100,000	11,650,000	710

For example, if a strike causes a postponement or accumulation of work, the extra demand for labour, and the overtime worked after its conclusion, may partially compensate for the stoppage. On the other hand, if a dispute should drive away trade or cause the closing of works, it may lessen the field of employment for a long period after its termination, and such lost time cannot be taken into account in the estimates of "aggregate duration."

For these reasons all estimates of wages lost through disputes are somewhat fallacious. The real importance of strikes lies less in the value of the actual time consumed by their duration, than in their indirect effects on the organization and effectiveness of the industry, and on the relations of employer to employed, and also in their reaction on the conditions of allied trades. The comparative insignificance of the actual loss

to enable any regular law of variations in disputes to be established by statistical evidence. It is to be remembered that in recent years there has been a great development in the means available for avoiding stoppages by conciliatory action (see ARBITRATION AND CONCILIATION), and this of itself would greatly complicate the task of tracing any correspondence between the prevalence of actual stoppages and the state of employment. Broadly it may be said that the great majority of upward and downward changes of wages are settled nowadays without strikes, and in many trades actual stoppages, instead of being a normal feature in the relations between employer and employed, are rather to be looked on as cases of accidental breakdown of the recognized machinery of negotiation.

The causes of disputes are of course very varied, embracing

Group of Trades.	Mean Annual			Percentage of Total Number employed who were affected by Disputes.	Percentage of Aggregate Working Time occupied by Disputes.
	Number of Disputes.	Number of Work-people affected (directly and indirectly).	Aggregate Duration in Working Days.		
Building	43	5,260	234,651	0.5	0.07
Mining and Quarrying	133	87,509	1,348,289	8.7	0.45
Metal, Engineering and Shipbuilding	95	22,470	534,549	1.6	0.13
Textile	90	27,736	326,468	2.3	0.09
Clothing	36	4,992	104,619	0.7	0.05
Other	72	9,047	180,793	0.2	0.01
All Industries, except Agricultural Labourers, Seamen and Domestic Servants	469	157,014	2,729,369	1.6	0.09

all the matters relating to conditions of employment on which differences may arise between employers and employed. Experience shows, however, that the great bulk of disputes relate to questions of wages, a much smaller proportion to hours of labour, and the balance to a large number of miscellaneous questions, such as the employment of persons or classes obnoxious to the strikers on the ground that they do not belong to their union, or have worked against its interests, or because they are held to have no "right" to the particular occupation on which they are employed, either on account of not having gone through the recognized training or of belonging to another trade.

to production owing to the mere loss of time caused by strikes will be seen from the fact that the total duration of strikes during the seven years 1901-1907, if spread over the entire adult male working population, would be equivalent to less than the loss of one-third of a day per head per annum. As a matter of fact, however, the loss owing to strikes is very unequally distributed over the industrial population. In large groups of industries, e.g. agriculture, strikes are of rare occurrence. In others, such as the building trades, they are frequent, but mostly small and local; while in mining they are not only frequent and often prolonged, but in many cases they involve large numbers of persons and extend over wide areas. Thus on an average of the seven years 1901-1907 there were 43 disputes annually in the building trades, and 133 in mining and quarrying, but the latter disputes have involved nearly seventeen times as many persons and had an aggregate duration nearly six times as great. Intermediate between these groups of trades is the metal, engineering and shipbuilding group, in which, more perhaps than in any other group, the importance of disputes varies according to the state of trade.

Among this class of strikes are to be included the so-called "demarcation" disputes between two bodies of workmen as to the limits of their trades, which frequently cause suspension of work by both groups, to the great inconvenience of the employer. Strikes are also not uncommon on the question of trade unionism pure and simple—i.e. to obtain or defend freedom to belong to a union, or to act through its agency in negotiations with employers. This question enters more or less as a factor into a large number of disputes, most usually, however, as a secondary cause or object, so that it does not appear prominently in the tabulation of causes in the board of trade statistics, which is based on principal causes only. Thus the formulated demands of the strikers are usually for improved conditions of work, the question of "recognition" of the trade union only arising incidentally when the parties attempt to negotiate as to these demands. The following table, showing the principal causes of disputes for the seven years 1901-1907, is based on the official statistics:—

Percentage Proportion of Work-people directly affected by Disputes in the seven years, 1901-1907, relating to				
Questions of Wages.	Questions of Hours.	Employment of particular Classes or Persons.	Trade Unionism.	Other Causes.
54.5	3.6	9.2	18.2	14.5

The principal facts relating to the distribution of trade disputes among the more important groups of trades are given in the above table for the mean of the seven years 1901-1907.

It would be natural to expect that trade disputes would be most prevalent at or just after a turn in the tide of employment,

The results of trade disputes are nearly as varied as their causes. Sometimes a strike goes on until the employer is ruined or retires from business, and is only ended by the permanent closing of the works; sometimes, especially when trade is slack and the dispute not large, the places of the men are almost immediately filled, and the only economic result of the strike is to replace one body of men by another without perceptible interruption of business. There have been frequent cases of this kind in strikes of unskilled labourers. Sometimes, on the other hand, the demand for labour is so active that the whole of the strikers immediately find work elsewhere, and the only economic result is to transfer a body of men from one set of employers to another with little or no interruption of their employment. In years of active employment the building trades have afforded many examples of this issue of a trade dispute. In other cases, after a more or less prolonged stoppage, the disputes end by the permanent "blocking" of an employer's establishment by a union, or the permanent refusal of the employer to take back any of his former employés. All these, however, are extreme, and on the whole exceptional cases. The vast majority of trade disputes are settled by mutual arrangement, and whether such arrangement is wholly in favour of one or other party, or involves a compromise, its terms provide that the whole or part of the body of work-people whose labour was withheld or excluded shall return on agreed conditions to their former employment.

During the period 1901 to 1907 there were on an average 465 disputes settled annually, affecting directly and indirectly 156,800 work-people, and of these only 44 disputes, involving 15,700 work-people, were ended by the return to work of the strikers on their employers' terms without negotiation of any kind, and 69 disputes involving 5500 persons by replacement of the work-people or by the closing of works. All the remaining disputes, 352 in number, involving 135,600 persons, were concluded by negotiation between the parties either with, or more usually without, the aid of an outside mediator or arbitrator.

The following figures for 1901-1907 (which practically coincide with those of the previous decennial average) show the comparative results of trade disputes. The percentages refer to the proportion of work-people directly involved in disputes which resulted in the manner indicated:—

Year.	In favor of Work-people.	In favor of Employers.	Com-promised.	Indefinite.	Total.
1901	27.5	34.7	37.3	0.5	100.0
1902	31.8	31.8	36.1	0.3	100.0
1903	31.2	48.1	20.7	0.0	100.0
1904	27.3	41.7	30.9	0.1	100.0
1905	24.7	34.0	41.2	0.1	100.0
1906	42.5	24.5	33.0	0.0	100.0
1907	32.6	27.0	40.1	0.3	100.0
Mean of 7 years	31.1	34.5	34.2	0.2	100.0

It is, of course, to be understood that the figures in the above table only relate to the *immediate* results, as determined by the relative extent to which one or other of the parties succeed in enforcing their demands. The question of the ultimate effect of the stoppages on the welfare of the parties or of the community generally is an entirely different question.

Organization of Strikes and Lock-outs.

In the great majority of cases strikes are organized and controlled by trade unions. It does not, however, follow from this that the growth of trade unionism has always fostered and encouraged strikes, there being evidence that in many trades the strengthening of organization has had the effect, not only of restraining ill-considered partial stoppages, but also of preventing more serious dislocations of industry by providing a channel for the expression of grievances and a recognized means of negotiating with employers. Much of the evidence given before the Royal

Commission on Labour (1891-1894) tended to show that the growth of trade unions has the effect on the whole of lessening the frequency, though of widening the area, of disputes. The commission, moreover, laid down that the stage of industry in which disputes are likely to be most frequent and bitter is that in which it is emerging from the "patriarchal" condition, in which each employer governs his establishment and deals with his own men with no outside interference, but has not fully entered into that other condition in which transactions take place between strong associations fully recognizing each other. In this state of industrial organization bitterness is often caused by the insistence of the work-people on the "recognition" of their unions, and by the treatment of these unions by the employers as outside parties interfering and causing estrangement between them and the work-people actually in their employ.

Probably next to the patriarchal stage, in which each factory is a happy family, the industrial conditions most favourable to peace are when a powerful trade union is face to face with a representative employers' association, both under the guidance of strong but moderate leaders and neither feeling it beneath its dignity to treat on equal terms with the other. When, on the other hand, some or all of these conditions are absent, the growth of combinations may tend to war rather than peace.

Whether, however, trade unionism tends generally to encourage or to restrain strikes, the organization and policy of all trade-unions, as at present constituted, are based on the possibility of a collective withdrawal from work in the last resort. Dispute pay is consequently the one universal form of trade-union benefit. Though, however, in most of the disputes recorded the strikers are financially supported by some trade union, this is by no means always the case. Many strikes have been entirely carried out without the instrumentality of a permanent combination, the work-people affected belonging to no union and merely improvising a more or less representative strike committee to control the movement. It is not uncommon, however, for a permanent union to originate in a strike of non-unionists. In other cases (*e.g.* in the London dock strike of 1889) an insignificant trade union may initiate a strike movement involving several thousands of labourers outside its membership. In the case quoted the membership of the Dockers' Union rose during the few weeks of strike from 800 to over 20,000. A conspicuous case of a widespread strike of workmen not belonging to a trade union was the South Wales coal-miners' dispute of 1898. Of the 100,000 men affected, probably not more than 12,000 belonged at the time to any trade union, but the workmen's representatives on the committee of the sliding scale (against which the movement was directed) formed the nucleus of a strike committee, and one result of the strike was the formation of the "South Wales Miners' Federation," affiliated to the Miners' Federation. In the case of strikes of non-unionists, the strikers, of course, have to depend for their maintenance on their own resources or on the proceeds of public subscriptions. Frequently grants are made in their aid by sympathetic trade unions, and in the case of the South Wales dispute above referred to, several boards of guardians gave outdoor relief illegally to strikers who had exhausted their resources.

The majority of strikers, however, belong to trade unions and receive "dispute benefit," which usually consists of a weekly payment of from 10s. to 15s. In 1906 the sum expended by 100 of the principal trade unions in support of men engaged in disputes was £212,000. In years of big disputes this sum has been largely exceeded.

Although most strikes are controlled by trade unions, cases are comparatively rare in this country in which the central committee of a trade union takes the initiative and directs its members to cease work. More usually a local strike movement is initiated by the local workmen, and the central committee is generally empowered by the rules to refuse its sanction to a strike and to close it at its discretion, but has no authority to order it. In many unions a ballot is taken of the members of the districts affected before a strike is authorized, and a two-thirds (or even greater) majority, either of members or of

branches, in favour of a stoppage may be required before the sanction of the central executive is granted. Some unions in their rules draw a distinction between strikes to enforce new conditions (e.g. a rise of wages, a restriction of hours or of overtime) and strikes to oppose the introduction of new conditions by the employers, greater freedom being allowed to the local members in the case of "defensive" than of "offensive" strikes.

Sometimes also the executive committee, while refusing their official sanction to a strike, and declining to allow the funds of the society to be used to support the strikers, may tacitly permit a local committee to take what action it pleases and to collect funds for the purpose. Some strong unions, however, especially those which have entered into general agreements with employers' associations, not only refuse financial support to an unauthorized strike, but even expel from their society strikers who refuse to obey their order to return to work. The Boilermakers' and Iron Shipbuilders' Union has more than once taken drastic action of this kind, even to the extent of fining or superseding recalcitrant members and officials. In 1899 the National Union of Boot and Shoe Operatives, which is a party to an agreement with the Employers' Federation (known as the "Terms of Settlement") was fined £300 by the umpire under that agreement for failing to expel or to induce to return to work certain of their members who took part in a strike contrary to the provisions of the agreement. It sometimes happens, however, that the central committee of a trade union is not strong enough to withhold financial support even from an unauthorized strike.¹

When a strike has been authorized by the executive, the conduct of it is frequently entrusted to a "strike committee," appointed *ad hoc*, one reason being that a strike of any considerable dimensions often affects members of several unions, so that the common action necessary in a conflict with employers can only be attained by a committee representing all the societies involved. A strike committee has often no power to draw on the funds of the unions represented, each of which pays dispute pay in accordance with its rules to its own members, the financial power of the strike committee being limited to the support of non-unionists out of any funds available for the purpose, or the collection and administration of funds in case of the exhaustion of the resources of any of the unions represented.

The financial support of a local or sectional strike imposes but little strain on the resources of a large society, but where a considerable proportion of the members are affected it is usual for a union to replenish its funds by imposing a "levy" or special contribution on members remaining at work. During the engineering dispute of 1897-1898 the levies imposed by the Amalgamated Society of Engineers rose to 2s. 6d. per week, and one of the main objects of the federated employers was to diminish the revenue obtained from this source by enlarging the area of the dispute.

When there is no regular provision for the financial support of strikers, or when this provision is exhausted, the strike leaders have a much more difficult task in preventing the return to work of some of their followers; and it is in these cases that intimidation and violence are most to be apprehended. In all strikes, however, except in the few cases in which the whole of the workmen in the trade are in the union, and the skill required is such that no new labour can enter the trade during the dispute, there is the possibility of the strikers being replaced by other labour, and the efforts of the strike organizers are largely directed to the prevention of this by all means in their power. The chief method employed has generally been that known as "picketing," viz. the placing of members of the union to watch the approaches to the works or factories affected, to give information as to the strike to any workmen who attempt to enter, and to endeavour to dissuade them from accepting employment.

Other methods of preventing workmen from taking the place of strikers may also be adopted or attempted, ranging from the

¹ Noteworthy in this respect was the strike of boilermakers on the Tyne in 1910, in defiance of their executive.

publication of information in leaflets or otherwise as to the existence of a dispute, or appeals to workmen to avoid the works affected, to systematic annoyance or intimidation of workmen who take or retain employment during a stoppage by threats or by actual violence and outrage.

The methods adopted by strikers and strike organizers naturally suggest the counter measures adopted by employers. To break down the resistance of a body of work-people supplied with a weekly strike allowance by a powerful trade union employers sometimes have recourse to some method of mutual indemnification by which the financially weaker of their number are temporarily subsidized by the stronger, whether through the machinery of a permanent employers' association or of an emergency committee. Employers' associations being usually composed of much smaller numbers than trade unions, are, as a rule, able to act in concert with greater secrecy and less formality than is possible in a workmen's union. Apart from any financial support which employers may guarantee their colleagues when attacked by a trade union, they have in some cases formed or aided organizations for the systematic provision of a reserve of "free labourers" available to replace men on strike. By "free labourers" is meant not necessarily non-unionist, but labourers pledged to work amicably with others whether members of a union or not. The Shipping Federation, an organization of shipowners and shipowners' associations which was formed in 1890 to combat the strikes than prevalent among seamen, arranged a system of shipping offices at which seamen could be engaged who were prepared to give a pledge that they would work with non-unionists. They also opened similar offices for shore labourers in some ports. Other independent agencies exist for supplying employers with labour during a dispute. It is not uncommon, in disputes in which there is any apprehension of intimidation or violence, for employers to board and lodge the imported work-people. Another method on which employers in recent years showed an increased tendency to rely was the institution of legal proceedings to restrain individual strikers or the union to which they belong from taking wrongful action injurious to their business. This led to the passage of the Trade Disputes Act of 1906 legalizing several forms of action by strikers which the courts had declared illegal (see below). There has been no attempt in England to induce the courts to restrain bodies of work-people from striking by injunction, as has been frequently done in American strikes affecting inter-state commerce. In many disputes the attitude of public opinion is of some importance in determining the results, and accordingly both sides frequently issue statements or manifestoes giving their versions of the difference, and in other ways (e.g. by an offer of arbitration) one party or the other endeavours to enlist public opinion on its side.

Public Action with regard to Strikes and Lock-outs.

Though the majority of labour disputes have little importance for third parties, stoppages of this kind sometimes acquire a special interest for the general public either by reason of the large number of work-people whose livelihood is affected, or of their indirect effects on employment in kindred trades, or of the danger and inconvenience that may be caused to the public, or of the fear that industry may be diverted abroad, or that a breach of the peace may be caused by attempts on the part of the strikers to coerce persons outside their combinations. For these and other reasons, strikes and lock-outs are usually regarded as a class of disputes in which legislative interference has more justification than in the case of other kinds of industrial and commercial differences.

Legislative action, with the view of providing alternative methods of adjusting labour difficulties, is discussed in the article ARBITRATION AND CONCILIATION. It is there shown that in New Zealand, New South Wales, Western Australia, the commonwealth of Australia and Canada (for certain industries) alternative methods have been made compulsory, but there are indications that the great majority of employers

and workmen in Great Britain would not be prepared for such measures, involving as they would the surrender by those directly concerned of their freedom to arrange these matters by voluntary agreement or by a trial of strength. Without the provision of some alternative by the state, it would be impossible in a free country to prohibit altogether the termination of labour contracts by collective agreement among work-people or employers.

The law, however, may and does restrict or prohibit the use of some of the methods of promoting or carrying on strikes which interfere with the liberty of other labourers, or inflict a wrong on employers, or injuriously affect the public interest.

The relation of the law in the United Kingdom to strikes and lock-outs is briefly as follows. Since the legislation of 1871 and 1875 there has been no question of the legality of a strike as such, viz. of a combined abstention from work in order to influence the conditions of employment, but the method in which the strike is carried out may subject the strikers either to criminal or civil liabilities. In this connexion the chief questions of interest relate to the limits within which strikers may lawfully act for the purpose of inducing other persons not to take their places, and for the purpose of bringing indirect pressure to bear upon the employer by influencing others not to work for or deal with him; and, on the other hand, the limits within which employers may act in inducing other employers to abstain from employing workmen or members of a trade union with whom they have a dispute.

Strikers are necessarily liable to the general criminal law, but the Conspiracy and Protection of Property Act 1875 enacted that an agreement or combination by two or more persons to do, or procure to be done, any act in contemplation or furtherance of a trade dispute between employers and workmen shall not be indictable as a conspiracy if such act is committed by one person would not be punishable as a crime, namely, on indictment or on summary conviction with the statutory liability of imprisonment either absolutely or alternatively for some other punishment. The Trade Disputes Act 1906 extended the exemption to *civil* liability providing that an act done in pursuance of an agreement or combination in contemplation or furtherance of a trade dispute shall not be actionable unless the act is done without such agreement or combination would be actionable. This act also extended the definition of trade dispute so as to include disputes between workmen and workmen, and also to make it clear that the workmen referred to need not necessarily be in the employment of the employer with whom a trade dispute arises.

The act of 1875 does not affect any conspiracy punishable by statute nor the law relating to riot, unlawful assembly, breach of the peace or sedition, or any offence against the state or sovereign. The act also does not apply to seamen, or to apprentices to the sea service.

Sudden breach of contract of service in gas and water undertakings, or under circumstances likely to endanger human life or cause serious bodily injury, or expose valuable property to destruction or serious injury, are made punishable offences by special sections, but the miscellaneous provisions of the act are the most important in trade disputes. These provisions, as amended by the act of 1906, subject to a penalty of fine or imprisonment every person who, with a view to compel any other person to abstain from doing, or to do any act which such other person has a legal right to do or abstain from doing, wrongfully and without legal authority,

1. Uses violence to or intimidates such other person, or his wife or children, or injures his property; or
2. Persistently follows such other person about from place to place; or
3. Hides any tools, clothes or other property owned or used by such other person, or deprives him of or hinders him in the use thereof; or
4. Watches or besets the house or other place where such person resides, or works, or carries on business, or happens to be, or the approach to such house or place; or
5. Follows such other person with two or more other persons in a disorderly manner in or through any street or road.

It has, however, expressly provided by § 2 of the act of 1906 that "it shall be lawful for one or more persons, acting on their own behalf or on behalf of a trade union or of an individual employer or firm in contemplation or furtherance of a trade dispute, to attend at or near a house or place where a person resides or works or carries on business or happens to be, if they so attend merely for the purpose of peacefully obtaining or communicating information, or of peacefully persuading any person to work or abstain from working."

The above amendment of the law introduced by the act of 1906 was intended to nullify the effect of a series of recent decisions (of which *Lyons v. Wilkins*, 1896 and 1899, was the most important), which interpreted the act of 1875 to mean that all picketing was illegal except such as was merely for the purpose of obtaining or communicating information. Until recently it was supposed that for wrongs committed in strikes only the individual wrong-doers

could be made responsible. But the decision of the House of Lords in the Taff Vale railway case (1901) showed that a trade union could be sued in tort for acts done by its agents within the scope of their authority and might be sued in its collective capacity, and execution of any damages recovered could be enforced against its general funds. The effect of this decision was nullified by § 4 (1) of the Trade Disputes Act of 1906, which expressly forbids any court to entertain any action against a trade union on behalf of all the members of the union in respect of any tortious act alleged to have been committed by or on behalf of the union.

Economic Effects.

The question of the effectiveness or otherwise of strikes and lock-outs for the purpose of influencing the conditions of employment is part of the wider question of the economic effect of combinations, the strike or lock-out being only one of many methods adopted by combinations of workmen or employers to enforce their demands. (This matter is discussed in the article TRADE UNIONS.) Apart, however, from the question of the extent of the immediate advantage, if any, which one party or the other is able to obtain from a stoppage, we have to consider generally the economic effects of strikes and lock-outs to the community as a whole. Stoppages of work are in their nature wasteful. Time, which might be employed in work yielding wages to the work-people and profits to the employers, is lost never to be recovered, while many forms of fixed capital deteriorate during idleness. In attempting, however, to estimate the utility or disadvantage of strikes and lock-outs, whether to the parties themselves or to the industrial community as a whole, it is insufficient to take into account the value of the wages and profits foregone during the stoppage, and to balance these against the gains made by one party or the other. Attempts have often been made to measure the loss or gain due to strikes in this way, but even as applied to particular stoppages, looked at purely from the point of view of one or other of the parties involved, the method is unsatisfactory. On the one hand, the time and work apparently lost may be afterwards partially recouped by overtime, or some of the strikers may be replaced by others, or may themselves find work elsewhere, so that the actual interruption of production may be less than would appear from the magnitude of the dispute. On the other hand, the total loss due to the stoppage may be augmented by the diversion of trade for a longer or shorter period after the resumption of work. Again, the ultimate effect of the forced concession of excessive demands may be damaging instead of advantageous to the nominal victors, by contracting the field of employment or by lowering the efficiency of the labour. If, however, the arithmetical computation of the value of the time lost compared with the value of the terms gained is an unsatisfactory test of the benefit or disadvantage of a particular strike to the parties concerned, it is wholly fallacious as a method of estimating the social utility or otherwise of strikes and lock-outs as instruments for effecting changes in the condition of employment. For any satisfactory consideration of this wider question we must look not merely to the actual strike, but to the whole process of free bargaining between employers and organized bodies of work-people, of which, as already shown, the strike may be regarded as merely an untoward incident. The actual cessation of work is a symptom that for the time there is a deadlock, and frequency of such cessations in any trade is a sign of the imperfection of means of negotiation. In many trades in which both employers and workmen are strongly organized various forms of machinery have been brought into existence for the purpose of minimizing the chance of stoppages (see ARBITRATION AND CONCILIATION). But wherever there is free combined negotiation there is always in the background the possibility of combined stoppage. This being understood, the question of the utility of strikes as an industrial method resolves itself into the questions: (1) Whether the process of settling the terms of employment by agreements affecting considerable bodies of work-people and employers is superior to the method of individual settlements of labour contracts, or, at least, whether its advantages are sufficient to outweigh the cost of strikes

and lock-outs; (2) whether free collective negotiation could be replaced with advantage by any other method of settling the conditions of employment of bodies of work-people, which would dispense with the necessity of testing the labour market by a suspension of work.

1. The first of these questions is virtually the question of the advantages and disadvantages to the community of combinations of workmen and employers, which is discussed at length in the article TRADE UNIONS. As regards the question of the direct cost of strikes and lock-outs, it is proper to remember that individual bargaining does not do away with stoppages; in fact, the aggregate amount of time lost in the process of adjusting ten thousand separate labour contracts may be considerable—possibly not less than that consumed on an average in effecting a single agreement involving the whole body, even if the chance of a collective stoppage of work occurring during the process of combined bargaining be taken into account.

While, then, the strikes and lock-outs which accompany the system of combined bargaining are rightly to be described as wasteful, this is not so much because of the excessive amount of working time which they consume, as because of the disturbance and damage done to industry by the violent breach of continuity—a breach which may dislocate trade to an extent quite disproportionate to the actual loss of time involved, and the fear of which undoubtedly affects the minds of possible customers and hampers enterprise on the part of employers. The extent of the injury directly inflicted on the consuming public by a strike varies greatly in different cases, being at its maximum in the case of industries having the total or partial monopoly of supplying some commodity or service of prime necessity, e.g. gas-works, water-works, railway or tramway service; and least in the case of a local stoppage in some widely-spread manufacturing or constructive industry open to active competition from other districts.

In speaking above of the loss occasioned by strikes and lock-outs attention has only been paid to the effects of the actual stoppage as such, and not to the particular methods adopted by the strikers to make the stoppage effective. The evils arising from the practice of intimidation or violence towards other workmen, or from the increase of class-hatred and bitterness engendered by the strike between employer and employed, are patent to all, though they cannot be estimated from an economic point of view.

2. As to the second question, viz. the possibility of maintaining combined negotiation, but of substituting some better method than strikes of resolving a deadlock, it is hardly necessary to say that so far as such substitution can be voluntarily carried out with the assent of both parties, whether by the establishment of wages boards or joint-committees, or by agreements to refer differences to third parties, the result is an economic as well as a moral advantage.

But the increasing adoption of these voluntary expedients for diminishing the chance of industrial friction lends no countenance to the expectation that a satisfactory universal substitute for strikes and lock-outs can be devised except at the price of economic liberty. Compulsory reference of disputes to a state tribunal cannot be reconciled with freedom of voluntary negotiations.

Unless, then, we are prepared for a scheme of compulsory regulation of industry by the state, strikes and lock-outs must be accepted as necessary evils, but their frequency may be greatly diminished with the improvement of means of information as to the true condition of the labour market, and the influences by which it is determined. Many disputes arising purely from mismanagement and misunderstanding are wholly avoidable. While there is no warrant for expecting the total abolition of strikes and lock-outs, it is not unreasonable to hope that the spread of education and the means of rapidly obtaining information, the improvement of class relations, and the adoption, where practicable, of conciliatory methods, may gradually tend to confine actual stoppages to the comparatively few cases

in which there is a genuine and serious difference of principle between the parties.

Important British Strikes and Lock-outs.

Some of the more important labour disputes which have occurred in various groups of trades in the United Kingdom are noted below. With regard to the statistics given, it may here be noted that although for the sake of brevity it is stated in some places that a certain number of men were idle for a specified number of days, it must not be supposed that in all cases the whole number affected were idle for the whole number of days.

Coal-Mining is an industry which has always been more convulsed by labour disputes than any other, probably owing to the violent oscillations of prices and wages, and to the varied and ever-changing conditions under which work is carried on. Several of the earliest recorded disputes among coal-miners, however, referred to the term of engagement rather than the rate of wages. In 1765 the Northumberland miners struck for several weeks unsuccessfully against the system of a yearly bond of service, which was then prevalent. In 1810 a strike of seven weeks in the same district against a variation of the yearly bond ended in a compromise. Turbulent strikes in Northumberland and Durham are also recorded in 1831 and 1832; the former, in which the men were successful, for a general removal of grievances, and the latter, in which they were defeated, for the maintenance of the union. These strikes were attended with violence and destruction of property. In 1844 still another prolonged strike took place in the north of England to enforce alterations in the terms of the yearly bond. From 30,000 to 40,000 men were out for 18 weeks. New men, however, were obtained, and there were many evictions. In 1864 widespread strikes took place in South Yorkshire and South Staffordshire, the one for an advance and the other against a reduction of wages. The Yorkshire strike is said to have affected 37,000 men, and the Staffordshire strike 20,000. The latter lasted over four months.

The rapid fall in the price of coal after the abnormal inflation in 1871-1872 produced a series of obstinate strikes and lock-outs arising out of reductions of wages, in which the men were usually defeated. The South Wales miners, to the number of 70,000, were out for 11 weeks in 1873 and for 19 weeks in 1875, the latter dispute being a combined strike and lock-out, and leading to the formation of the first of the series of sliding scales under which the industry in South Wales was regulated until the end of the year 1902. In 1877 the West Lancashire miners (30,000) were out for 6 weeks, and the Northumberland men (14,000) for 8 weeks. The last-mentioned dispute was terminated by an arbitration award in the miner's favour. In 1879, 70,000 Durham men were out for 6 weeks, the dispute being terminated by an arbitration award giving half the reduction claimed by the coal-owners. The introduction of sliding scales in Durham and Northumberland in 1877 and 1879 did something to preserve peace in those districts, though the Durham scale did not prevent the dispute of 1879 mentioned above. Both scales, however, were terminated by the men in 1889 and 1887 respectively. In 1880-1881 the Lancashire coal-mining industry was stopped for 7 weeks by a strike of 50,000 to 60,000 men against "contracting out" of the Employers' Liability Act of 1880.

The fall of prices after 1890 led to a renewal of disputes. In 1892 there was a prolonged stoppage in the Durham coalfield, 75,000 men being out for about 11 weeks.

In 1893 the greatest dispute took place that has ever been recorded in the coal-mining industry, affecting the whole area covered by the Miners' Federation, viz. Yorkshire, Lancashire and Cheshire, and the Midlands. During the years 1891 and 1892 most of the districts covered by the Miners' Federation submitted to reductions of wages varying from 15% off the standard in Durham to 42½% in South Wales and 50% in Scotland, where the previous rise had been greatest. The Miners' Federation, however, refused to recognize the principle that wages should follow prices, and put forward instead the theory that a minimum or "living wage" should be fixed and prices left to adjust themselves to this rate. They declined altogether to agree to any reduction, and so strong was their combination that the coal-owners deferred any definite action until the middle of 1893, when they considered that some reduction was absolutely necessary to enable the trade to be carried on. On the 30th of June they passed a resolution after a conference with the men, demanding a reduction of 25% off the "standard" (equivalent to about 18% off current rates of wages), and offered arbitration as an alternative; but the federation absolutely refused any reduction, and the contest began. Shortly before the beginning of the dispute Northumberland and Durham had become affiliated to the federation, but these districts were not threatened by a reduction, and they seceded from the federation sooner than strike, as demanded by that body to obtain the return of the reductions sustained since 1891. These districts consequently remained at work throughout the dispute, as well as Scotland and (except for a part of August and September) South Wales, reaping the advantage of the increased prices and wages resulting from the restriction of production due to the stoppage.

Within the federation districts proper there were some localities in which no notices of reduction were posted, but the policy of the Miners' Federation was to make the stoppage as universal as possible, and all its members were required to leave work. The Cumberland miners, however, though members of the federation, were for special reasons permitted to continue at work. By the middle of August nearly 300,000 men were idle, or nearly half the total number of coal-miners in the United Kingdom. The early stages of the dispute were uneventful, but as the funds of the unions affiliated to the federation became exhausted, and the pinch of distress was felt, feeling ran high, and in some districts deplorable acts of violence were committed. At Featherstone, in Yorkshire, an attack was made on a colliery, in the course of which the military fired on the rioters, two of whom were killed.

The decision of the federation requiring all its members to leave work, whether under notice of reduction or not, had from the beginning met with considerable opposition in certain districts, and this opposition naturally grew stronger as the distress caused by the stoppage increased. At the end of August a ballot on the question showed a small majority still in favour of a universal stoppage, but the experience of another month led to a formal reversal of policy in this respect, a meeting of the federation at Chesterfield on the 29th of September deciding to allow all men to return to work who could do so at the old rates of pay, such men to pay a levy of 1s. a day in aid of those still on strike. Up to October no step was taken towards a settlement beyond an offer on the part of the miners on the 22nd of August to pledge themselves not to ask for an advance until prices reached the 1890 level, and also to assist the employers to prevent underselling—an offer which was rejected by the coal-owners. On the 9th of October a meeting of the representatives of the parties was held at Sheffield, at the invitation of the mayors of six important towns affected, but without definite result, beyond leading to an amended proposal on the part of the coal-owners for an immediate 15% reduction, and the regulation of future changes in wages by a conciliation board. The men, however, still refused all reduction, and during October a number of coal-owners, especially in the Midlands, threw open their pits at the old rate of wages.

A further advance towards a compromise was made by the owners on the 25th of October, when they offered that the proposed 15% reduction should be returned to the men in the event of the conciliation board (with an independent chairman) deciding in their favour. In consequence of this offer a meeting was held between the representatives of the owners and the men in London on the 3rd and 4th of November, but without arriving at a settlement. Matters had now reached a deadlock, and accordingly, on the 13th of November, the government addressed an invitation to both parties to be represented at a conference under the presidency (without a casting vote) of Lord Rosebery, who was then foreign secretary. The conference took place at the foreign office on the 17th of November, and resulted in a settlement, the men to resume work at once at the old rate of wages, to be continued until the 1st of February 1894, from which date wages were to be regulated by a conciliation board, consisting of fourteen representatives of the coal-owners' and miners' federations respectively, with a chairman mutually elected, or in default nominated by the Speaker of the House of Commons, the chairman to have a casting vote.

This agreement terminated the dispute. The Speaker appointed Lord Shand as chairman of the board. In the middle of the following year, by mutual arrangement, the constitution of the conciliation board was modified so as to provide for limits below and above which wages should not move during a definite period. These limits have since been modified from time to time, but (with a gap from July 1896 to January 1899) the conciliation board continued to regulate miners' wages in the federated districts, and its formation has been followed by the institution of conciliation boards in most of the other important centres of the mining industry.

During the summer of 1893 there was also a strike of about 90,000 men in South Wales, which lasted about 5 weeks. 1894 saw a prolonged dispute in the Scottish coal-mining industry, the men vainly attempting to resist the fall of wages which followed the fall of coal prices from the abnormal level to which they had risen during the English stoppage of the previous year; 70,000 men were out from 15 to 16 weeks. In 1898 there was an unsuccessful stoppage lasting 25 weeks in South Wales and Monmouth affecting 100,000 men, for the abolition or amendment of the sliding scale agreement. In 1902 the dissatisfaction of the pit-lads with a reduction of wages awarded by the conciliation board threw a large body of miners idle for some time in various parts of the "federated districts." In 1906 a series of local strikes occurred in South Wales in order to compel non-unionists to join the Miners' Union, while in 1910 strikes in the Tonypandy district led to much rioting.

The record of strikes and lock-outs in the *Cotton Trade* goes back to a time before the repeal of the Combination Laws. Thus the year 1810 was marked by lock-outs of spinners in Lancashire and Glasgow, the former caused by a strike in the Stalybridge district to enforce Manchester rates of wages, and the latter having for its object the break-up of the men's union. In both cases the employers were successful. In 1812 there was a stoppage of

40,000 looms in Scotland for some weeks, arising out of a wages dispute, in which the men were beaten, their union broken up, and their leaders imprisoned. Another unsuccessful strike attended with imprisonment of the men's leaders took place among the Manchester spinners in 1818, when 20,000 to 30,000 men were out for three or four months to obtain an advance of wages and reduction of hours. The year 1853 was one of great disturbance in the Lancashire cotton-spinning trade. For seven months 20,000 to 30,000 spinners in the Preston district were engaged in an unsuccessful strike for an advance of wages, and in the same year there was a stoppage of 65,000 spinners in Lancashire generally. The period of bad trade culminating in 1879 was marked by bitter disputes in the cotton trade, the men vainly trying to resist the reductions of wages which marked that period. Partial disputes at Bolton in 1877, and Oldham in 1878 were followed in the latter year by a general stoppage in north and north-east Lancashire affecting 70,000 persons for 9 weeks. The general dispute was attended with violent riots, and 68 persons were tried and convicted. The next important dispute was a strike of 18,000 weavers in north-east Lancashire in 1884 against a reduction of wages, which ended after 8 weeks in a compromise. Next year there was a strike at Oldham against a reduction of wages affecting 24,000 persons in the spinning and weaving branches. The dispute ended in a compromise, half the proposed reduction of 10% being agreed to. In 1892-1893 a great dispute in the cotton-spinning trade took place, 50,000 persons in the Oldham and surrounding districts being out for 20 weeks against a proposed reduction of 5%. The dispute was ended by the so-called "Brooklands Agreement," which provided for a reduction of about 3%, and also contained rules for the settlement of future disputes by conciliatory methods. These rules do not, however, provide for a final appeal in cases of deadlock. A considerable strike in 1910, brought about by a dispute as to the allocation of duties of a single operative, was terminated by the intervention of the board of trade.

The *Building Trades* have in most years been characterized by a large number of local and sectional disputes sometimes affecting comparatively small bodies of men. Often, however, all branches of building trades in a given district have been stopped simultaneously, but few of the building trade stoppages have affected a sufficiently large body of men to be noticed here as important disputes except in London. The years 1810 and 1816 were marked by strikes on the part of the London carpenters, the first being a successful attempt to obtain a rise in wages, the second an unsuccessful resistance to a fall. In 1833 an important dispute laid idle the building trades of Liverpool and Manchester. The dispute arose out of the objection of the men to the contract system, and led to a general lock-out to compel the men to leave their unions, in which the employers were generally successful. In 1859-1860 a partial strike in London against the discharge of a delegate led to a lock-out of 25,000 building operatives for 7 months, and in 1861-1862 a renewed strike for a reduction of hours resulted in a compromise. In 1872 there was a successful strike of 10,000 London building operatives for a rise of wages, a shortening of hours being also obtained. In 1891 there was an unsuccessful strike of carpenters in London for a rise in wages, affecting 9000 men and lasting 24 weeks.

Engineering, Shipbuilding and Metal Trades.—Among the most noteworthy disputes in the engineering trade was that in 1852, soon after the formation of the Amalgamated Society of Engineers by the fusion of a number of local and sectional societies. The dispute originated in Lancashire, and turned on demands from the men for the abolition of piecework and overtime, the dispute being further complicated by questions relating to the employment of labourers in working machines. The men ceased working overtime, and were locked out to the number of over 13,000 for periods ranging from three to nine months. The men were completely beaten, and many engineering shops required the men to leave the union before resuming work. In 1871 a strike of 8000 to 9000 men in the north of England for a reduction of hours from 59 to 54 was successful after a stoppage of 20 weeks, and led to the general introduction of the nine-hour-day throughout the country.

In 1897-1898 there was a widespread and prolonged dispute turning on questions of hours and of freedom of management of works, which lasted 29 weeks and affected 47,500 men. The immediate occasion of the stoppage was a demand on the part of the men for an eight-hour-day in London workshops, but this issue was soon overshadowed in importance by other questions relating to the freedom of employers from interference by the unions in the management of their business, especially in such matters as piecework, overtime, selection and training of workmen to work machines, employment of unionists and non-unionists, and other matters affecting the relations of employer and employee generally throughout the United Kingdom. For some time previous to the general dispute there had been a growing dissatisfaction on the part of the employers with the encroachments of the Amalgamated Society of Engineers and other societies in kindred trades on matters affecting the management of business, which the employers considered to be outside the legitimate functions of trade unions. In the absence of any general combination of employers, the unions were able to bring their whole force to bear on employers in particular localities,

with the result that the stringency of the conditions and restrictions enforced varied very greatly in different districts, according to the comparative strength of the unions in those districts. Employers complained of being subject to vexatious restrictions not imposed on their competitors, and they declared that they were severely handicapped as compared with America and other countries, where engineering employers had much more complete control over the management of their business. In 1895 was formed the Federation of Engineering Employers by the coalition of the local associations on the Clyde and in Belfast, and this federation gradually spread to other districts until it finally embraced the United Kingdom generally. The policy of the federation was to defeat the attempts of the unions to put pressure on particular individuals or localities by the counter-threat of a general lock-out of trade unionists over a wide area in support of the employers thus attacked. The lock-out notices were framed in such a way that 25% of the trade unionists employed were to be discharged at the end of each week until the whole were locked out. Lock-out notices of this kind were twice posted—in August of 1896 and in the spring of 1897—before the general dispute, but in each case the dispute was averted before the notices took effect. But the conferences which took place in April 1897 between the representatives of employers and unions led to no agreement except on comparatively unimportant points. When, therefore, in June 1897 the London employers, threatened with a strike for an eight-hour-day, put their case in the hands of the Employers' Federation, and the federation determined to support them by a general lock-out, it was understood that this lock-out was enforced, not only in order to resist the reduction of hours in London, but to obtain a settlement of all the important questions at issue between the federation and the unions as a whole. The engineers replied to the notices of a gradual lock-out by withdrawing the whole of their members from work in federated workshops. At first the lock-out affected some 25,000 men employed in 250 establishments, but by the close of the dispute the number of employers involved had risen to 702, and of work-people to 47,500.

Until November no meeting between the parties took place, but on the 24th of November and following days a conference was held in pursuance of negotiations with the parties by the board of trade, each side having its own chairman. The main point for which the employers contended was freedom on the part of each employer to introduce into his workshop any condition of labour under which any members of the trade unions were working in any of the federated workshops at the beginning of the dispute, except as regards rates of wages and hours of labour. Arising out of this general principle of freedom of management, a number of special points were discussed and subsequently embodied in separate articles of the provisional agreement, and a system of local and general conferences for the settlement and avoidance of future disputes was also included therein. The employers absolutely declined to grant any reduction of hours of labour. The negotiations dragged on for a considerable time, and were at one time broken off owing to the refusal of the men to ratify the provisional agreement. By the end of the year, however, it was evident that the position of the men was very much weakened owing to the depletion of their funds, while that of the employers was stronger than ever. On the 13th of January the London demand for an eight-hour-day was formally withdrawn, and after some further negotiation, and the embodiment in the agreement of the notes and explanations published by the employers, a settlement was arrived at and ratified by more than a two-thirds majority of the men, the final agreement being signed on the 28th of January.

The victory of the employers was complete, but the use made of it was moderate, and the relations between employers and workmen in the engineering trades on the whole improved, all matters likely to cause dispute being now amicably discussed between the representatives of the respective associations.

In 1866 a strike of 3000 shipwrights on the Clyde led to a general lock-out of shipbuilders in the district. In 1877, 25,000 iron shipbuilders on the Clyde struck for 23 weeks for an advance of wages, the dispute being settled by arbitration.

In 1906 the shipbuilders in the Clyde district struck work for about 7 weeks to obtain an advance of wages of 1s. 6d. a week. The dispute ended in their defeat, about 15,000 men being affected.

In 1891 a prolonged dispute took place between the plumbers and engineers engaged in shipyards on the Tyne as to "demarcation"; 2460 men were idle from 7 to 8 weeks, the result being the drawing up of an elaborate list of apportionment applicable to the Tyne and Wear. The shipbuilding trades have from early times been marked by numerous "demarcation" disputes, mostly of a local character, as to the limits of the work of the various bodies of work-people—e.g. between shipwrights and boatbuilders; shipwrights and joiners; shipwrights and boilermakers; joiners and cabinetmakers; boilermakers and engineers; engineers and plumbers; engineers and brassfinishers. Some of these matters are now dealt with by joint trade boards (see ARBITRATION AND CONCILIATION).

Among the more important disputes in the iron trade are to be mentioned a strike and lock-out of 30,000 ironworkers in Staffordshire in 1865, in which the men were beaten after a costly stoppage of 18 weeks; an unsuccessful strike of 12,000 ironworkers in Middlesbrough for 18 weeks in 1866; and an unsuccessful strike of 20,000

ironworkers in Staffordshire for 4 weeks in 1883 against a reduction of wages, attended by rioting and destruction of plant.

The nailmakers in the Dudley district engaged in widespread disputes in 1840, 1881 and 1887. The strike of 1840 against a reduction of wages was unsuccessful. Those of 1881 and 1887 were for advance of wages; the former was wholly, the latter partially successful. The women chain-makers of Cradley Heath successfully struck in 1910 for an increase of wages.

Other Trades.—Among other noteworthy disputes are to be mentioned:—

1. A successful strike of 14,000 persons in the Leicester hosiery trade in 1819 for an advance in wages.

2. An unsuccessful strike of 13,000 or more tailors in London in 1834 for a rise of wages and reduction of hours, lasting several months.

3. A dispute among the pottery workmen in the Midlands in 1836 against the terms of yearly hiring, leading to a general lock-out of over 15,000 men for 10 weeks, which ended in the defeat of the men.

4. A series of disputes among agricultural labourers in 1872–1874 for increases of wages and other improvements in the conditions of employment, in which the men were mostly successful. These disputes, which are almost the only widespread disputes recorded in agriculture, evoked much public interest.

5. In 1889 there was a prolonged strike of dock and waterside labourers in London for a rise in wages and other alterations in conditions of employment, which was successful, mainly through the financial support received from the Australian trade unions and from the general public. It began on the 13th of August with a small local dispute at the West India Docks about the wages earned for discharging a certain cargo, but spread rapidly among all classes of dock labourers in the port, who took the opportunity of demanding an increase in the rate of pay for time work from 5d. to 6d., the abolition of contract and piece-work, and the remedy of other grievances. They were joined by the stevedores and lightermen, who came out "in sympathy," though the latter class of men soon formulated a set of demands of their own. Employment was brisk, the weather fine, and the public sympathetic, and in a few days' time not less than 16,000 men were idle. For the most part they were unconnected with trade unions which could give them strike pay, but during the month that the strike lasted the public at home and abroad subscribed nearly £50,000 in support of the strikers. Of this total over £30,000 came from Australia, where from the 29th of August onwards a series of meetings were held for the purpose of raising funds to assist the London labourers. The Australian subscriptions practically decided the issue of the contest. On the very day on which the first Australian meeting was held at Brisbane the leaders of the strike attempted by means of a "no-work manifesto" to widen the area of the dispute and cause a general stoppage of industry. Though this attempt was soon abandoned it caused considerable alarm and threatened to alienate public sympathy from the men. Early in September many of the wharfingers made separate settlements with the strikers, and the shipowners attempted to put pressure on the dock companies to allow them to employ labour direct within the docks. The apprehensions of the public led to the formation of a conciliation committee at the Mansion House, including the Lord Mayor, the bishop of London, Cardinal Manning, Sir John Lubbock (Lord Avebury), and others, who mediated between the strikers and the dock directors, with the result that after one abortive attempt at a settlement, the terms of which were rejected by the men, an agreement was arrived at on the 14th of September, under which the dock labourers obtained the greater part of their demands. From the 4th of November the rate of hourly wages for time work was raised to 6d., with 8d. overtime; contract work was converted into piece-work, with a minimum rate of 6d., and other points in dispute were settled. Though during the strike cases of intimidation and violence on the part of pickets were by no means absent, the police-court charges arising out of the dispute were remarkably few. By the end of the year the Dock Labourers' Union (which had previously been known as the Tea Operatives and General Labourers' Union, and at the beginning of the dispute numbered about 800 members) had increased its membership in London to over 20,000—a number which was afterwards further increased by the formation of provincial branches. In London, however, the membership rapidly declined during the following years of depression of trade. The stevedores, who, as above remarked, came out "in sympathy" with the dock labourers, returned to work as soon as the latter were satisfied, but the lightermen's demands were adjusted by an award of Lord Brassey before they returned to work.

6. The organization of labour at the principal ports which followed this dispute led to a series of struggles between the new unions and the shipowners, who formed an organization called the Shipping Federation Limited, and successfully established their right to employ "free labour" in opposition to the unions of scamen and other bodies of labourers. The last of these disputes on a large scale occurred at Hull in 1893, and ended in the defeat of the dock labourers after a stoppage affecting 11,000 men for 6 weeks.

7. In 1895 a general stoppage of 46,000 boot and shoe operatives was terminated, after a stoppage of 6 weeks, by a settlement effected through the board of trade. The issues of this dispute were of

interest as involving the scope and limits of the functions of trade union action and of arbitration in relation to the management of business. The terms of settlement, which were of an elaborate character, are still in operation.

8. Two prolonged disputes at Lord Penrhyn's slate quarries in North Wales in 1896 and 1900 attracted public notice from the obstinacy with which the contests were conducted on both sides. About 2500 work-people were affected, and the questions at issue were the recognition of the men's combination and the remedy of a number of alleged grievances, including the abolition of the contract system. After 48 weeks' stoppage, during which the board of trade vainly tried to mediate, the first dispute was ended by a compromise; but in 1900 another struggle began which was persisted in by many of the men until November 1903, but without success.

Foreign Countries.

Below is given a brief account of the most recent strike statistics in the principal countries other than the United Kingdom, except those of the United States, which are dealt with in a separate section.

France.—Detailed statistics of strikes and lock-outs in France have been published annually since 1890 by the French office du travail. The following are the figures for 1900-1906:—

Year.	Number of Disputes.	Number of Work-people directly affected.	Aggregate Duration in Working Days.
1900	903	222,769	3,761,227
1901	523	111,414	1,862,050
1902	512	212,704	4,675,081
1903	571	123,957	2,443,219
1904	1,028	271,267	3,936,774
1905	835	178,252	2,785,167
1906	1,314	439,280	9,445,420
Mean of 7 yrs.	812	222,806	4,129,848

The principal groups of industries affected by disputes were in 1900 and 1901 the transport, involving 47,125 and 36,636 work-people respectively; in 1902 the mining and quarrying, involving 119,181 work-people; in 1903 the textile manufacturing

	1901.	1902.	1903.	1904.	1905.	1906.	1907.
Number of strikes	117	73	70	81	133	220	227
Number of work-people directly affected by strikes	43,814	10,477	7,649	12,375	75,672	26,858	46,908

industry, involving 76,376 work-people; in 1904 the textile manufacturing industry, involving 76,293 work-people; the transport, involving 69,293 work-people, and the agricultural, forestry and fishing group, involving 52,333 work-people; in 1905 the building and metal trade groups of industries, involving about 32,000 work-people in each; and in 1906 the building, metal and mining quarrying groups of industries, involving about 90,000 work-people in each.

In the French statistics of causes of disputes a dispute due to several causes is entered as many times as there are causes, not merely under its principal cause, as in the United Kingdom statistics. It would be possible to summarize the relative prevalence of different groups of causes of trade disputes by the numbers involved, but it is sufficient to say that the results during the period 1900 to 1906 were as follows: 12% in favour of the work-people, 25% in favour of the employers, and 63% compromised. A general strike of railway employees all over France in 1910 threatened to spread to other industries and caused an acute political crisis, but the energetic measures taken by M. Briand's government, especially the issue of mobilization orders to all the reservists on the affected lines, brought about its collapse in little more than a week.

Germany.—Before 1899 there were no official statistics of strikes and lock-outs throughout the German Empire, but certain figures were collected and published by the committee of the "Gewerkschaften," or Social Democratic trade unions, in their *Correspondenzblatt*. These figures, however, were admittedly incomplete. From 1899, however, statistics have been published by the German imperial statistical office for strikes and lock-outs other than in agriculture.

The figures from 1901 are summarized below:—

Year.	Number of Disputes terminating in the year.	Number of Work-people directly and indirectly affected.
1901	1091	68,191
1902	1106	70,696
1903	1444	135,522
1904	1990	145,480
1905	2657	542,564
1906	3626	376,415
1907	2512	286,016

In 1905, 232,425 work-people employed in the mining and smelting group were involved in disputes, and in 1906 and 1907 102,888 and 90,890 work-people employed in the building group of trades were so involved.

In the German statistics disputes are counted more than once if due to more than one separate cause. Of the total number of disputes tabulated in this way during the period 1901-1907, 56% were on questions of wages, 15% on questions of hours, 10% on questions of the employment of particular classes of persons and the balance on questions of working rules and other causes.

During the same period 20% of the disputes were settled in favour of the work-people, 45% in favour of the employers, and 35% were compromised.

Belgium.—The following figures are based on reports published by the Belgian labour department.

The table given below shows the number of strikes and the number of work-people directly affected by strikes in each of the years 1901 to 1907.

The mining industry and the transport trades accounted for 20,813 and 15,063 of the work-people affected in 1901, and the mining industry and the textile industry accounted for 59,168 and 7975 of the work-people in 1905. In 1906 the mining industry accounted for 12,189 of the work-people affected, and in 1907 the transport trades accounted for 10,660, the mining

industry for 9626 and the textile industry for 7961 of the work-people affected. The causes of the strikes during the period were mainly questions of wages, nearly 80% of the work-people being involved on this account, and the results were mainly in favour of the employers, viz. 71%. Of the total number of work-people affected by strikes in the period 1901-1905 68% returned to work on employers' terms without negotiation. From 1906 particulars are given of lock-outs and of the number of work-people indirectly affected by strikes.

In 1906 five lock-outs were recorded, all in the textile industry, affecting 23,621 work-people, and in 1907 four lock-outs were recorded affecting 16,274 work-people (one of these lock-outs affecting 16,000 work-people employed in the transport trade).

The number of work-people indirectly affected by strikes was 11,468 in 1906 and 19,248 in 1907.

Sweden.—The Swedish labour department has published statistics of strikes since 1903. There were in 1903 142 disputes directly affecting 22,568 work-people, in 1904 215 disputes directly affecting 11,485 work-people, in 1905 175 disputes directly affecting 32,368 work-people, in 1906 277 disputes directly affecting 18,612 work-people, and in 1907 298 disputes directly affecting 21,722 work-people. Of the 1107 disputes recorded in the five years 691 were caused by questions of wages. Of the 1107 disputes 362 ended in favour of the work-people, 272 in favour of the employers, and 395 in a compromise. In 1909 there was a great national strike involving almost every industry, and lasting some six months.

Denmark.—The statistics of disputes in Denmark are published by the Danish statistical bureau. During the period 1900 to 1906 the number of disputes varied from 57 in 1901

to 89 in 1906, and the number of work-people directly affected, from 7606 (involved in 68 disputes) in 1900 to 1148 (involved in 43 disputes) in 1903. The number of work-people shown is the maximum number affected at any one time, but the number involved is not obtained for all disputes. Of the total number of disputes which took place during the seven years' period 1900-1906, viz. 518, 53% were caused by questions of wages, 3% by hours of labour, 7% by working arrangements, rules, &c., 6% by questions of trade unionism, and 31% by other causes or causes unknown.

Holland.—Statistics of disputes in Holland are published by the central statistical bureau. During the three years 1904, 1905 and 1906 the number of disputes recorded were 102, 132 and 181 respectively, and the number of work-people directly affected 11,186, 7364 and 18,858 respectively, but the number of work-people affected was not ascertained in every dispute. The causes of disputes are measured by the number of days lost by the work-people directly affected (though these particulars were not obtained for all disputes), and the days lost by disputes which had more than one cause are included under each cause or object. In 1904 25%, in 1905 53% and in 1906 51% of the time lost was caused by questions of wages. The results of disputes in the three years are shown in the following table:—

Result.	Number of Disputes.		
	1904.	1905.	1906.
In favour of work-people	24	25	35
In favour of employers	43	49	63
Compromised	31	55	68
Indeterminate or unknown	4	3	7
Total	102	132	173

The figure for 1906 does not include 8 "sympathetic" disputes which came to an end when the original dispute terminated in connexion with which they occurred.

Austria.—Particulars of strikes and lock-outs are published by the Austrian labour department.

The following table shows the number of strikes, the number of strikers and non-strikers affected, the number of working days lost by strikers, and the number of lock-outs and work-people involved in each of the seven years 1900 to 1906.

	1900.	1901.	1902.	1903.	1904.	1905.	1906.
Number of strikes	303	270	264	324	414	686	1,083
Number of work-people taking part in strikes	105,128	24,870	37,471	46,215	64,227	99,591	153,688
Number of non-strikers affected	7,737	2,846	6,354	5,245	9,301	11,340	13,098
Number of working days lost by strikers	3,483,963	1,577,444	284,046	500,567	606,629	1,151,310	2,191,815
Number of lock-outs	10	3	8	8	6	17	50
Number of work-people directly involved in lock-outs	4,036	302	1,050	1,334	23,742	11,197	67,872

In the tabulation of causes or objects of disputes the work-people are entered as many times as there are causes. During the period 1900 to 1906 questions of wages were the predominating cause of dispute.

Twenty-five% of the work-people were involved in disputes during 1900 to 1906 which resulted in favour of the employers, 13% in disputes which resulted in favour of the work-people, and 62% in disputes which were compromised.

The British Colonies.

Canada.—Statistics of disputes are published by the department of labour. During the seven years 1901 to 1907 the total number of disputes recorded was 859, the number each year being as follows:—

1901.	1902.	1903.	1904.	1905.	1906.	1907.
104	123	160	103	87	138	144

In 1904 the number of work-people involved was 15,665; in 1905, 16,127; in 1906, 26,014 and in 1907, 34,972. The number

of working days lost during the same four years were 278,956, 284,140, 489,775 and 613,986 respectively. Of the total number of disputes in the seven years (859), 208 occurred in the building trades, 139 in the metal trades, 79 in the clothing trades, 62 in the mining industry, 60 in the transport trades and 48 in the food and tobacco preparation industry. Of the 740 disputes occurring in the same period for which a cause could be tabulated, 248 were for an increase in wages, 94 against the employment of particular persons, 64 were for both an increase in wages and a decrease in hours of labour, and 45 against a reduction in wages; and of the 841 disputes for which the result could be tabulated, 293 were in favour of the employers, 250 were in favour of the work-people, 200 were settled by compromise, and the balance (98) were indefinite in their settlement. Four of the Canadian provinces, Ontario, Nova Scotia, British Columbia and Quebec, and the Dominion government have enacted laws with a view to the peaceful settlement of industrial disputes. Under the Industrial Disputes Investigation Act of 1907 strikes and lock-outs are unlawful in industries termed public utilities prior to or during a reference of such dispute to a board of conciliation, a provision which is enforced by heavy penalties. Thirty days' notice of intended changes in wages or hours have to be given under the act.

Australia and New Zealand.—Four of the Australian states (Victoria, New South Wales, South Australia and Western Australia) and the Commonwealth as a whole have enacted laws with a view to the peaceable settlement of disputes between employers and work-people, but the laws of Victoria and South Australia are inoperative though unrepealed. These two states and Queensland have, however, established wages boards which tend to prevent disputes on the question most frequently the cause of strikes or lock-outs. The original inspiration of the conciliation and arbitration laws arose from the great strikes of 1890 to 1892, which turned to a great extent on the attempt of labour unions to secure a monopoly of employment. They all ended in the defeat of the work-people and in a great weakening of trade unionism in the colony.

In New Zealand a law has also been in force since 1894 for the encouragement of the formation of industrial unions and associations, and to facilitate the settlement of industrial disputes. Strikes and lock-outs are now illegal in New Zealand.

AUTHORITIES.—The following are among the more important official publications on strikes and lock-outs: Reports of the Chief Labour Correspondent of the Board of Trade on Strikes and Lock-outs (annually from 1888); *Labour Gazette* (Board of Trade, monthly from May 1893); Reports of Royal Commission on Labour (1891-1894); Report of the Royal Commission on Trade Disputes and Trade Combinations (1906); Third Abstract of Foreign Labour Statistics (Board of Trade, 1906—Section on Trade Disputes), and the publication of the offices given as the authorities for the strike statistics of the various foreign countries and colonies. (See also list of authorities on TRADE UNIONS and ARBITRATION AND CONCILIATION.)

United States.

The first recourse to a strike in the United States occurred in 1740 or 1741, when a combined strike of journeymen bakers occurred in New York City. An information was filed in 1741 against the strikers for conspiracy not to bake until their wages were raised. On this they were tried and convicted, but it does not appear that any sentence was ever passed. In May 1796 an association of journeymen shoemakers in Philadelphia ordered a "turn-out" or strike to secure an increase of wages, and again in 1798, for the same purpose, both strikes being

successful. In 1799 the shoemakers of Philadelphia struck against a reduction of wages, the strike lasting about ten weeks, and being only partially successful. These four are the only strikes to which any reference can be found that occurred in the United States prior to the 19th century. The conditions of industry generally during the colonial days was not conducive to strikes. The factory system had not taken deep root, masters and men worked together, and so there was no opportunity for concerted action.

The first notable American strike occurred in November 1803, in the city of New York, and is commonly known as the *Notable Early Strikes* "sailors' strike." The sailors in New York had been receiving \$10 per month. They demanded an increase to \$14. In carrying out their purpose they formed in a body, marched through the city, and compelled other seamen who were employed at the old rates to leave their ships and join the strike. The strikers were pursued and dispersed by the constables, who arrested their leader and lodged him in gaol, the strike thus terminating unsuccessfully. In 1805 the Journeymen Shoemakers' Association of Philadelphia again turned out for an increase of wages. The demands ranged from 25 to 75 cents per pair increase. This strike lasted six or seven weeks and was unsuccessful. The strikers were tried for conspiracy, the result of the trial being published in a pamphlet which appeared in 1806. An account of this trial may be found in the United States Supreme Court library. In November 1809 a strike among the cordwainers occurred in the city of New York. The proprietors quietly took their work to other shops, and by this stratagem defeated the strikers; but the action being discovered, a general turn-out was ordered by the Journeymen Cordwainers' Association against all the master workmen of the city, nearly 200 men being engaged in the strike. At that time a stoppage of work in one shop by the journeymen was called a "strike"; a general stoppage in all shops in a trade was known as a "general turn-out." A member of a journeymen's association who did not keep his obligations to the organization was denominated a "scab."

In 1815 some of the journeymen cordwainers of Pittsburg, Pennsylvania, were tried for conspiracy on account of their connexion with a strike, and were convicted. In 1817 a peculiar labour difficulty occurred at Medford, Massachusetts. Thacher Magoun, a ship-builder of that town, determined to abolish the grog privilege customary at that time. Mr Magoun gave notice to his people that no liquor should be used in his shipyard, and the words "No rum!" "No rum!" were written on the clapboards of the workshop and on the timbers in the yard. Some of Mr Magoun's men refused to work; but they finally surrendered, and a ship was built without the use of liquor in any form.

The period from 1821 to 1834 witnessed several strikes, but rarely more than one or two in each year. These strikes occurred among the compositors, hatters, ship carpenters and caulkers, journeymen tailors, labourers on the Chesapeake & Ohio Canal, the building trades, factory workers, shoemakers and others. One of the most notable of these, for its influence upon succeeding labour movements, occurred in 1834, in the city of Lynn, Massachusetts. During the latter part of the preceding year the female shoebinders of that town began to agitate the question of an increase of wages. The women engaged in this work usually took the materials to their homes. The manufacturers were unwilling to increase the prices paid, so a meeting for consultation was held by more than one thousand binders. This was on the 1st of January 1834. The binders resolved to take out no more work unless the increase was granted. The employers, however, steadily refused to accede to the demands, as they found no difficulty in having their work done in neighbouring towns at their own prices. The strike, after three or four weeks, came to an unsuccessful termination. In February of the same year a disturbance of short duration occurred at Lowell, Mass., among the female factory operatives. Their strike was to prevent a reduction of wages. During the

year 1835 there was a large number of strikes throughout the country, instigated by both men and women. The number of strikes by dissatisfied employees had at this time become so numerous as to call forth protests from the public press, the *New York Daily Advertiser* of the 6th of June 1835 declaring that "strikes are all the fashion," and suggesting that it was "an excellent time for the journeymen to come from the country to the city."

The United States government, through the census office and the department (now bureau) of labour, has investigated the question of strikes, the result being a fairly continuous record from 1880 to the 31st of December 1905 inclusive. In 1880, according to the tenth census, there were 610 strikes, but the number of establishments involved in them was not reported; the record must therefore commence with 1881, and since then the facts have been continuously and uniformly reported by the department (now bureau) of labour. This record, so far as numbers are concerned, is shown in the following table:—

Investigations.

Year.	Strikes.			Lock-outs.	
	Number of strikes.	Establishments involved.	Employees thrown out of employment.	Establishments involved.	Employees thrown out of employment.
1881	471	2,928	129,521	9	655
1882	454	2,105	154,671	42	4,131
1883	478	2,759	149,763	117	20,512
1884	443	2,367	147,054	354	18,121
1885	645	2,284	242,705	183	15,424
1886	1,432	10,053	508,044	1,509	101,980
1887	1,436	6,589	379,676	1,281	59,630
1888	906	3,506	147,704	180	15,176
1889	1,075	3,786	249,559	132	10,731
1890	1,833	9,424	351,944	324	21,555
1891	1,717	8,116	298,939	546	31,014
1892	1,298	5,540	206,671	716	32,014
1893	1,305	4,555	265,914	305	21,842
1894	1,349	8,196	660,425	875	29,619
1895	1,215	6,973	392,403	370	14,785
1896	1,026	5,462	241,170	51	7,668
1897	1,078	8,492	408,391	171	7,763
1898	1,056	3,809	249,002	164	14,217
1899	1,797	11,317	417,072	323	14,817
1900	1,779	9,248	505,066	2,281	62,653
1901	2,924	10,908	543,386	451	20,457
1902	3,162	14,248	659,792	1,304	31,715
1903	3,494	20,248	656,055	3,288	131,779
1904	2,307	10,202	517,211	2,316	56,604
1905	2,077	8,292	221,686	1,255	80,748
Total	36,757	181,407	8,703,824	18,547	825,610

Statistics of Strikes.—Out of the total of 181,407 establishments at which strikes took place during the period named, 69,899 were in building trades, 17,025 in coal and coke, 7381 in tobacco, 20,914 in clothing, 4450 in stone-quarrying and cutting, 1555 in boots and shoes, 1551 in furniture, 1476 in brick-making, 2999 in printing and publishing, and 1086 in cooperage. These ten industries supplied 128,336, or 70·74% of the whole number of establishments in which strikes occurred during the twenty-five years. In the lock-outs occurring during the same time five industries bore a very large proportion of the burden, involving 13,716, or 73·95% of the whole number of establishments, which was 18,547. The industries affected were: building trades, 10,142; clothing, 1943; stone-quarrying and cutting, 901; boots and shoes, 337; tobacco 393. The whole number of persons thrown out of employment by strikes was 8,703,824, of whom 90·57% were males and 9·43% were females; and the total number thrown out of employment by lock-outs during the same period was 825,610, of whom 84·18% were males and 15·82% were females. About 70% of the whole number of strikes were ordered by labour organizations; and of the number so ordered (25,353) 49·48% succeeded, 15·87% succeeded partly, and 34·65% failed. Of the whole number of strikes, 47·94% succeeded, 15·28% succeeded partly and 36·78% failed. Of the lock-outs, 50·79% succeeded, 10·71% succeeded partly and 32·09% failed. The average duration

STRIKES AND LOCK-OUTS

of the strikes for the whole period was 25.4 days, and of the lock-outs 84.6 days.

More strikes were occasioned by demands for increase of wages than for any other one cause, 32.24% of all strikes being for this cause, but this in combination with other causes attributable in whole or in part to demands for increase of wages brings the demands up to 40.72%.

The next most fruitful cause of strikes is disagreement concerning the recognition of the union and union rules. For this 18.84% of strikes were declared, and both alone and combined with other causes produced 32.35%. Objection to reduction of wages caused 11.90% while demands for reduction of hours alone and combined with other causes produced 9.78% of strikes.

Of the total number of establishments involved in strikes 57.91% were involved for causes either in whole or in part due to demands for increase of wages. The most important cause of lock-outs during the twenty-five years was disputes concerning the recognition of the union and union rules and employees' organizations, which alone and combined with various causes, produced nearly one-half of all lock-outs and more than one-half of all establishments involved in lock-outs. The United States government's account of losses from strikes is for the period from January 1881 to the 31st of December 1900, the five years from 1901 to 1905 inclusive not being included in that account. It is difficult to ascertain exactly the losses of employees and employers resulting from strikes and lock-outs. Differences may counterbalance each other, so that the results given below for the period named may be considered as fairly accurate.

The total loss to employees and employers alike in the establishments in which strikes and lock-outs occurred, for the period of twenty years, was thus \$468,968,581. The number of establishments involved in strikes during this period was 117,509, making an average wage loss of \$2194 to employees in each establishment in which strikes occurred. The number of persons thrown out of employment by reason of strikes was 6,105,694, making an average loss of \$42 to each person involved. The number of establishments involved in lock-outs was 9933, making an average loss of \$4915 to employees in each establishment in which lock-

the number of establishments involved was 127,442, while 6,610,001 persons were thrown out of employment. These figures show an average wage-loss of \$2406 to the employees in each establishment, and an average loss of \$46 to each person involved. The assistance given to strikers by labour organizations during the period was \$16,174,793; to those involved in lock-outs, \$3,451,461, or a total of \$19,626,254. This sum represents but 6.40% of the total wage-loss incurred in strikes and lock-outs, and is probably too low. Much assistance was also furnished by outside sympathizers, the amount of which cannot be readily ascertained. The total loss to the establishments or firms involved in strikes and lock-outs during this period was \$142,659,104.

The states of Illinois, Massachusetts, New York, Ohio and Pennsylvania, being the leading manufacturing states, necessarily experienced the largest number of strikes. Out of 117,509 establishments having strikes during the period named, 87,878, or 74.78% of the whole, were in these five states; and out of 9933 establishments having lock-outs, 8424, or 84.81% were in these states. In 1900 these states contained 45.02% of all the manufacturing establishments in the United States, and employed 55.15% of the entire capital invested in mechanical industries.

A significant feature of the report for the twenty-five year period relates to efforts to settle strikes, during the years 1901 to 1905 inclusive, a feature which had not been embodied before. The results are shown in the following table:—

Year.	Strikes.			Lock-outs.		
	Number.	Number settled by joint agreement.	Number settled by arbitration.	Number.	Number settled by joint agreement.	Number settled by arbitration.
1901	2,924	149	49	88	10	2
1902	3,162	204	58	78	11	1
1903	3,494	246	66	154	18	3
1904	2,307	130	23	112	17	2
1905	2,077	74	27	109	10	3
Total	13,964	803	223	541	66	11

The figures given relate to all strikes, of whatever magnitude, occurring in the United States from 1881 to the 31st of December 1900 inclusive.

Year.	Strikes.			Lock-outs.		
	To date when Strikers were re-employed or employed elsewhere.		Loss of Employers.	To date when Employees locked out were re-employed or employed elsewhere.		Loss of Employers.
	Wage-loss of Employees.	Assistance to Employees by Labour Organizations.		Wage-loss of Employees.	Assistance to Employees by Labour Organizations.	
	\$	\$	\$	\$	\$	\$
1881	3,372,578	287,999	1,919,483	18,519	3,150	6,960
1882	9,864,228	734,339	4,269,094	466,345	47,668	112,382
1883	6,274,480	461,233	4,696,027	1,069,212	102,253	297,097
1884	7,666,717	407,871	3,393,073	1,421,410	314,027	640,847
1885	10,663,248	465,827	4,388,893	901,173	89,488	455,477
1886	14,992,453	1,122,130	12,357,808	4,281,058	549,452	1,949,498
1887	16,560,534	1,121,554	6,698,495	4,233,700	155,846	2,819,736
1888	6,377,749	1,752,668	6,509,017	1,100,057	85,931	1,217,199
1889	10,409,686	592,017	2,936,752	1,379,722	115,389	307,125
1890	13,875,338	910,285	5,135,404	957,966	77,210	486,258
1891	14,801,505	1,132,557	6,176,688	883,709	50,195	616,888
1892	10,772,622	833,874	5,145,691	2,856,013	537,684	1,695,080
1893	9,938,048	563,183	3,406,195	6,659,401	364,268	1,034,420
1894	37,145,532	931,052	18,982,129	2,022,769	160,244	982,584
1895	13,044,830	559,165	5,072,282	791,703	67,701	584,155
1896	11,098,207	462,165	5,304,235	690,945	61,355	357,535
1897	17,468,904	721,164	4,868,687	583,606	47,326	298,044
1898	10,037,284	585,228	4,596,462	880,461	47,098	239,403
1899	15,157,965	1,096,030	7,443,407	1,485,174	126,957	379,365
1900	18,341,570	1,434,452	9,431,299	16,136,802	448,219	5,447,930
Total	257,863,478	16,174,793	122,731,121	48,819,745	3,451,461	19,927,983

outs occurred, while the number of employees thrown out was 504,307, making an average loss of \$97 to each person involved. Combining the figures for strikes and lock-outs, it is seen that

Historic Strikes.

what may be called historic strikes, the first of which was in 1877, though of course many very severe strikes had taken place prior to that year. The great railway strikes of 1877 began on the Baltimore & Ohio Railroad at Martinsburg, West Virginia, the immediate cause of the first strike being a 10% reduction of wages of all employees. This, however, was but one of many grievances. There was irregular employment. Men with families were permitted to work only three or four days per week, the remainder of the time being forced to spend away from home at their own expense, leaving them but little money for domestic use. Wages, payable monthly, were often retained several months. The tonnage of trains was increased, and the men were paid only for the number of miles run, irrespective of the time consumed. So there were many alleged causes for the great strikes of 1877. Riot, destruction of property and loss of life occurred at Martinsburg, Baltimore and various places in Pennsylvania. The state militia at Martinsburg and Pittsburg sympathized with the strikers,

affiliated with them and refused to fire upon them. United States troops were ordered from Eastern garrisons, and they dispersed the mobs. In Cincinnati, Toledo and St Louis mobs of roughs and tramps collected, and succeeded in closing most of the shops, factories and rolling-mills in those cities. There were also formidable demonstrations in Chicago, as well as in Syracuse, Buffalo, West Albany and Hornell, New York, where mobs were dispersed by the state militia without violence or destruction of property.

The Pennsylvania Railroad also had a memorable strike, accompanied by riots and much violence and destruction of property, during the same year, the strike being ordered on account of a general reduction in wages and some other causes which came in to create the difficulty. The complete story of this strike is too long to relate here, but from the beginning the strikers had the active sympathy of a large proportion of the people of Pittsburg, where the chief movements occurred. The actual loss to the Pennsylvania Company, not including freight, has been estimated at \$2,000,000, while the loss of property and loss of business at Pittsburg amounted to \$5,000,000. Claims were presented before the courts in Allegheny county to the amount of over \$3,500,000, while the actual amount paid by compromise and judgments was over \$2,750,000. Both the foregoing strikes were unsuccessful.

The next great strike was that of the telegraphists, which occurred in the year 1883. This strike was inaugurated to secure the abolition of Sunday work without extra pay, the reduction of day-turns to eight hours, and the equalization of pay between the sexes for the same kind of work. Universal increase of wages was also demanded. The strike commenced on the 19th of July and ended on the 23rd of August 1883, although it was declared off on the 17th of the latter month. It was unsuccessful, the employees losing \$250,000 and expending \$62,000 in assistance to destitute fellow operators. The employers lost nearly \$1,000,000.

Another historic strike, only partially successful, was that on the South-Western or Gould system of railways in the years 1885-1886, but the most prominent labour controversies in the 19th century were those at Homestead, Pa., in July 1892, and at Chicago in 1894, concerning which a more detailed account is given below. Other great labour convulsions have occurred which help to identify the decade beginning 1890 with the great strike era of the century. Among them may be named the Lehigh Valley railroad strike in December 1893, the American Railway Union strike on the Great Northern railway in April 1894; the great coal strike, which occurred in the same month; the difficulties at Latimer, Pa.; and those in the Coeur d'Alene district of Idaho.

In July 1892 there occurred a most serious affair between the Carnegie Steel Company and its employees at what is known as the **Homestead Strike or Riot.** Homestead Works, near Pittsburg, growing out of a disagreement in the previous month in regard to wages. The parties were unable to come to an agreement, and the company closed its works on the 30th of June and discharged its men. Only a small portion of the men were affected by the proposed adjustment of wages. The larger portion of them, who were members of the Amalgamated Association of Iron and Steel Workers, were not affected at all, nor was the large force of employees, some three thousand in number, who were not members of that association. The company refused to recognize the association as an organization, or to hold any conference with its representatives. Upon the failure to arrive at an adjustment of the wage difficulty the company proposed to operate its works by the employment of non-union men. The men, who could not secure recognition, refused to accept the reduced rates of wages, and also came to the determination that they would resist the company in every attempt to secure non-union workers.

The history of the events at Homestead shows that the lodges composing the Amalgamated Association proceeded to organize what was styled an "advisory committee" to take charge of affairs for the strikers. All employees of the company were directed to break their contracts and to refuse to work until the Amalgamated Association was recognized and its terms agreed to. The works were shut down two days prior to the time provided by the contract under which the men were working, and, as alleged, because the workmen had seen fit to hang the president of the company in effigy. On the 4th of July the officers of the company asked the sheriff of the county to appoint deputies to protect the works while they carried out their intention of making repairs. The employees, on their part organized themselves to defend the works against what they called encroachments or demands to enter; in fact, they took possession of the Homestead Steel Works. When the sheriff's men approached, the workmen, who were assembled in force, notified them to leave the place, as they did not intend to create any disorder, and would not allow any damage to be done to the property of the company. They further offered to act as deputies, an offer which was declined. The advisory committee, which had been able to preserve the peace thus far, dissolved on the rejection of their offer to serve as deputies and conservators of the peace, and all of their records were destroyed. The immediate cause of the fighting which subsequently took place at Homestead was the approach of a body of Pinkerton's detectives, who were gathered in two barges on the

Ohio river, some miles below the works. When the Pinkertons arrived the workmen broke through the mill fence, entrenching themselves behind the steel billets, and made all preparations to resist the approach of the Pinkerton barges; and they resisted all attempts to land, the result being a fierce battle, brought on by a heavy volley of shots from the strikers. The Pinkertons were armed with Winchester's, but they were obliged to land and ascend the embankment single file, and so were soon driven back to the boats, suffering severely from the fire of the strikers. Many efforts were made to land, but the position of the men they were attacking, behind their breastworks of steel rails and billets, was very strong, and from this place of safe refuge the detectives were subjected to a galling fire. This opening battle took place on the 5th of July, about four o'clock in the morning, and was continued in a desultory way during the day. It was renewed the following day. A brass ten-pound cannon had been secured by the strikers, and planted so as to command the barges moored at the banks of the river. Another force of one thousand men had taken up a position on the opposite side of the river, where they protected themselves and a cannon which they had obtained by a breastwork of railway ties. A little before nine o'clock a bombardment commenced, the cannon being turned on the boats, and the firing was kept up for several hours. The boats were protected by heavy steel plates inside, so efforts were made to fire them. Hose was procured and oil sprayed on the decks and sides, and at the same time many barrels of oil were emptied into the river above the mooring place, the purpose being to ignite it and then allow it to float against the boats. Under these combined movements the Pinkertons were obliged to throw out a flag of truce, but it was not recognized by the strikers. The officers of the Amalgamated Association, however, interfered, and a surrender of the detectives was arranged. It was agreed that they should be safely guarded, under condition that they left their arms and ammunition; and, having no alternative, they accepted the terms. Seven had been killed and twenty or thirty wounded. On the 10th of July, after several days' correspondence with the state authorities, the governor sent the entire force of the militia of the state to Homestead. On the 12th the troops arrived, the town was placed under martial law, and order was restored. There had been much looting, clubbing and stoning, and as the detectives, after surrender, passed through the streets they were treated with great abuse. Eleven workmen and spectators were killed in the fights.

Congress made an investigation of this strike, but no legislative action was ever taken. Some indictments were made and lawsuits ensued. The mills were gradually supplied with new people, but the strike was not declared off until the 20th of November 1892. The Homestead strike must be considered as the bitterest labour war in the United States prior to the Chicago strike in 1894. It was unsuccessful.

Probably the most expensive and far-reaching labour controversy which can properly be classed among the historic controversies of this generation was the Chicago strike of June and July 1894. Beginning with a private strike at the **The Chicago or Pullman Strike.** works of Pullman's Palace Car Company at Pullman, a suburb of Chicago, it ended with a practical insurrection of the labour employed on the principal railways radiating from Chicago and some of their affiliated lines, paralysing internal commerce, putting the public to great inconvenience, delaying the mails, and in general demoralizing business. Its influences were felt all over the country, to greater or less extent, according to the lines of traffic and the courses of trade. The contest was not limited to the parties with whom it originated, for soon there were brought into it two other factors or forces. The original strike grew out of a demand of certain employees of the Pullman Company in May 1894 for a restoration of the wages paid during the previous year. The company claimed that the reduction in the volume of business, owing to business depression, did not warrant the payment of the old wages. On account of the increased production of rolling-stock to meet the traffic incident to the World's Fair in 1893, orders for building cars were not easily obtainable, a large portion of the business of the Pullman Company being contract business in the way of building cars for railway companies generally. This state of affairs resulted in a partial cessation of car-building everywhere in the country, the Pullman Company suffering with all others. The demand of the employees therefore was not acceded to, and on the 11th of May 1894 a strike was ordered. Several minor grievances were claimed to have existed and to have led to the action of the strikers, who had joined the American Railway Union, an association of railway employees which had achieved a partial success in a contest with the Great Northern Railway a few weeks previous to the Pullman strike. The Railway Union espoused the cause of the Pullman employees on the ground that they were members thereof. This union was said to number about 150,000 members. It undertook to force the Pullman Company to accede to the demands of its employees by boycotting Pullman cars; that is to say, they declared that they would not handle Pullman cars on the railways unless the Pullman Company would accede to the demands made upon it. The immediate antagonist of the Pullman Company in the extended controversy was therefore the American Railway Union.

Another force was soon involved in the strike, which was, very naturally, an ally of the Pullman Company. This was the General Managers' Association, a body of railway men representing all the roads, twenty-four in number, radiating from Chicago, and it was said to be the necessity of protecting the traffic of its lines that brought about its struggle with the American Railway Union. These roads represented a combined capital of more than \$2,000,000,000, and they employed more than one-fourth of all the railway employees in the United States. These three great forces, therefore, were engaged in a battle for supremacy, and that rivalry alone, without reference to the conditions and circumstances attending the strike or accompanying it, makes this one of the historic strikes of the period.

According to the testimony of the officials of the railways involved, they lost in property destroyed, hire of United States deputy marshals and other incidental expenses, at least \$685,308. The loss of earnings of these roads on account of the strike is estimated at nearly \$5,000,000. About 3100 employees at Pullman lost in wages, as estimated, probably \$350,000. About 100,000 employees upon the twenty-four railways radiating from Chicago, all of which were more or less involved in the strike, lost in wages, as estimated, nearly \$1,400,000. Beyond these amounts very great losses, widely distributed, were suffered incidentally throughout the country. The suspension of transportation at Chicago paralysed a vast distributive centre, and imposed many hardships and much loss upon the great number of people whose manufacturing and business operations, employment, travel and necessary supplies depend upon and demand regular transportation to, from and through Chicago. The losses to the country at large are estimated by Bradstreets to be in the vicinity of \$80,000,000. Whatever they are, whether more or less, they teach the necessity of preventing such disasters, and the strike illustrates how a small local disturbance, arising from the complaints of a few people, can affect a whole country. When the American Railway Union took up the cudgels for the Pullman strikers and declared their boycott against Pullman cars, and the General Managers' Association took every means to protect their interests and prevent the stoppage of transportation, the sympathies and antagonisms of the whole country were aroused. An unsuccessful attempt was made to induce all trades in Chicago to join in a great sympathetic strike.

The inevitable accompaniments of a great strike were brought into play at Chicago. Riots, intimidations, assaults, murder, arson and burglary, with lesser crimes, attended the strike. In this, as in some of the other historic strikes, troops were engaged. The city police, the county sheriffs, the state militia, United States deputy marshals and regulars from the United States army were all brought into the controversy. The United States troops were sent to Chicago to protect Federal property and to prevent obstruction in the carrying of the mails, to prevent interference with interstate commerce, and to enforce the decrees and mandates of the Federal courts. They took no part in any attempt to suppress the strike, nor could they, as such matters belong to the city and state authorities. The police of the city were used to suppress riots and protect the property of citizens, and the state militia was called in for the same service. The total of these forces employed during the strike was 14,186.

Many indictments and law-suits originated in the difficulties occurring in Chicago. But all the attending circumstances of the strike point to one conclusion—that a share of the responsibility for bringing it on belongs in some degree to each and every party involved. The strike generated a vast deal of bitter feeling—so bitter that neither party was ready to consider the rights of the other. The attacking parties claimed that their grievances warranted them in adopting any means in their power to force concessions. This is the attitude of all strikers. The other parties, on the other hand, claimed that they were justified in adopting any means in their power to resist the demands of the attacking party. The probability is that neither recognized the rights of the public to such an extent as to induce them to forbear bringing inconvenience and disturbance to it. It was the most suggestive strike that has ever occurred in the United States, and if it only proves a lesson sufficiently severe to teach the public its rights in such matters, and to teach it to adopt measures to preserve these rights, it will be worth all it cost. It was unsuccessful, and resulted ultimately in the downfall of the American Railway Union.

The so-called steel strike of the year 1901 was a contest between the Amalgamated Association of Iron, Steel and Tin Workers and the United States Steel Corporation. It began on the first day of July, and lasted until the 15th of September 1901, when work was resumed in accordance with an adjustment agreed to on the 13th of the latter month. The difficulty grew out of an attempt to adjust a sliding scale of wages with some of the constituent companies of the United States Steel Corporation, a new company having \$1,404,000,000 capitalization. This corporation was perfected after the difficulties really began, so the Amalgamated Association ultimately had to confront the new powerful corporation. The real nut of the difficulty was not a question of wages, hours of labour, or rules or conditions of work, but a contest for recognition of the right of the association

to demand the unionizing of mills, a demand, of course, which was positively refused by the United States Steel Corporation. There were no grievances, as intimated; it was clearly and solely a conflict on the demand for recognition in the trade-union sense, and it was the first great struggle in the United States that was conducted solely on this issue. This issue has been contested many times, but usually in conjunction with some grievance or complicated with some demand as to wages or other economic conditions. The result was that the Amalgamated Association did not secure the terms demanded; and it lost further, because some of the mills which were subject to the union's rules were taken out and made non-union mills. The strike was conducted without any of the dramatic and tragic circumstances which attended the Homestead affair in 1892, in which the Amalgamated Association was one of the parties. In the contest of 1901 the association did not have the hearty endorsement of a large number of workmen, as it was not a movement to redress any grievance. It was fought for a principle, but the movers did not consider the power against which they were obliged to contend. Officers of the Amalgamated Association estimated that the number of men out of employment during the strike averaged 30,000 per day. At a conservative estimate there must have been a loss of more than \$4,000,000 in wages. The steel company through its officers claimed that it experienced no great loss as the result of the strike.

A strike affecting more individual interests than any preceding it was the anthracite coal strike of 1902, which formally began on the 12th of May. It was ordered at a convention held at Hazleton, Pa., on the 15th of May, by a vote of 461 to 349. The leaders of the miners, with one or two exceptions, opposed the strike. It was therefore a strike of the workers themselves. Grievances had existed in the anthracite coal region for many years, but more especially since the strike of 1900. An attempt was made in 1901 to secure some concessions, but the operating railways declined even to enter into a conference. This, of course, caused irritation, and constant appeals were made to the officers of the union to make new demands, and failing to secure concessions, to organize a strike. The demands of the miners were as follows: (1) An increase of 20% to those miners who are paid by the ton; (2) a reduction of 20% in the time of per diem employees; (3) that 2240 lb constitute the ton on which payment is made for coal mined by weight. No grievances were presented. The powder question was practically settled in 1900. The miners' demands being rejected by the operators, the demands were subsequently reduced one-half; i.e. 10% increase per ton where mining is paid by the ton, and 10% decrease in the working day. The miners also voted to leave the whole matter to arbitration and investigation, and to accept the results. They were willing to make a three years' contract on the terms proposed. The fundamental difficulty on the part of the operators related to efforts to secure and preserve discipline. They claimed that every concession already made had defeated this. The strike involved nearly 150,000 employees, and affected the consumers of anthracite coal throughout the eastern states.

After the most strenuous efforts of both parties to this strike, the president of the United States, at the request of the great coal operators and the officers of the Miners' Union, appointed a commission to adjust their differences, and after five months of hearings, listening to nearly six hundred witnesses, the commission submitted an award which was to be in effect three years from the 1st of April 1903. Both parties had agreed to abide by the award, whatever it might be. After the three years had expired, that is, the 31st of March 1906, the miners concluded to strike again, but after some negotiations both parties again unanimously agreed to extend the award made by the commission for three years more, i.e. until the 31st of March 1909.

After the coal strike of 1902 many very important disturbances occurred. There was one among the silver miners at Cripple Creek, Colorado, 1894, at Leadville, 1896-1897, at Lake City, 1899, and at Telluride in 1901; also another at Colorado City in 1903. All these strikes were attended with a great deal of violence, the militia was ordered out, many murders took place, and in three counties of Colorado there was a reign of terror, but on the whole the strikes were unsuccessful. The Western Federation of Miners was seriously crippled in these affairs.

It is gratifying to note the reduction in the number of strikes as shown by recent statistics. In 1903 the number of establishments was 20,248, but it had dropped to 8292 in 1905.

AUTHORITIES.—U. S. Commissioner of Labor, Twenty-first Annual Report (1906); reports of various State Bureaus of Labor Statistics; Pennsylvania Bureau of Industrial Statistics, Twentieth Annual Report (1892); U.S. House of Representatives, "Employment of Pinkerton Detectives at Homestead, Pa.," Report No. 2447, 52nd Congress, 2nd Session (1892); United States Strike Commission, Report on Chicago Strike, Senate Ex. Doc. No. 7, 53rd Congress, 3rd Session (1894); "The Amalgamated Association of Iron and Steel Workers," *Quarterly Report of Economics* for November 1901; *Industrial Evolution of United States*, chs. xxv. and xxvi.; *Report of the Anthracite Coal Strike Commission*; *U.S. Bulletin of Labor* (May

1903); *Report of Commissioner of Labor* (1905) on labour disturbances in Colorado. (C. D. W.)

STRINDBERG, AUGUST (1849–), Swedish author, was born at Stockholm on the 22nd of January 1849. He entered the university of Upsala in 1867, but was compelled by poverty to interrupt his studies, which were resumed in 1870. His gloomy experiences of student life are reflected in a series of sketches named after two districts of Upsala, *Från Fjerdlingen och Svartbäcken* (1877), which aroused great indignation at the time. After various experiments as schoolmaster, private tutor and actor, he turned to journalism, and afterwards more than avenged himself for the triviality and narrowness of his new surroundings in his famous *Röda rummet* ("The Red Room," 1879), described in the sub-title as sketches of literary and artistic life. The "red room" was the meeting-place in a small café in Stockholm of a society of needy journalists and artists, whose failure and despair are shown off against the prosperity of a typical bourgeois couple. In these stories Strindberg's fanatic hatred of womankind already makes its appearance, the disasters of the principal figures being precipitated by the selfishness and immorality of the women. In 1874 some friends procured him a place in the Royal library at Stockholm where he was employed until 1882. He was already an ardent student of physical science; he now gave proof of his versatility by learning Chinese in order to catalogue the Chinese MSS. in the library; and his French monograph on the early relations of Sweden with the Far East was read in 1879 before the Academy of Inscriptions in Paris. He continued to write for the newspapers and for the theatre. His first important drama, *Mäster Olof*, which had been refused in 1872 by the theatrical authorities, was produced after repeated revision in 1878. Although real historical personages—Gustavus Vasa, Olaus Petri the reformer and Gerdt the Anabaptist—figure as leading characters, they are made symbolic of the present-day forces of progress and reaction. The production of *Mäster Olof* marked the beginning of the new movement in Swedish literature, and the *Red Room* and the collection of satirical sketches entitled *Det nya riket* ("The New Kingdom," 1882) increased the growing hostility to Strindberg. Two comedies drawn from medieval subjects, *Gillet hemlighet* ("The Secret of the Guild," 1880) and *herr Bengt's Hustru* ("Bengt's Wife," 1882), were followed by the legendary drama of *Lycko Pers resa* ("The Journal of Lucky Peter"), written in 1882 and produced with great success on the stage a year later.

In 1883 Strindberg left Sweden with his family, to travel in Germany, Italy, France and Denmark, writing for foreign reviews and producing various volumes of stories and articles. Meanwhile he had been developing his attack on the feminist movement, which had received a great stimulus in Scandinavia from the dramas of Ibsen. In *Giftas* ("Married," 1884) he produced twelve stories of married life to support his view of the sex question; this was followed in 1886 by a second collection with the same title, which was written in a more violent tone and lacked some of the art of the earlier attack. He was prosecuted for assailing the dogma of the communion, but he returned to Sweden to defend himself, and was acquitted. Strindberg's mastery of the art of description is perhaps seen at its best in the novels of life in the Swedish archipelago, in *Hemsöborna* ("The Inhabitants of Hemsö, 1887), one of the best existing novels of popular Swedish life, and *Skärkarlslif* ("Life of an Island Lad," 1890). *Tschaudala* (1889) and *I hafsbundet* ("In the Bond of the Sea," 1890) show the influence of a study of Nietzsche. In 1887 he returned to drama with the powerful tragedy *Fadren*, produced in Paris also as *Le père*; this was followed in 1888 by *Fröken Julie*, described as a naturalistic drama, to which he wrote a preface in the nature of a manifesto, directed against critics who had resented the gloom of *Fadren*. *Kamraterna* ("Comrades," 1888), which belongs to the same group of six plays, was followed by *Himmelriketsnycklar* ("The Keys of the Kingdom of Heaven," 1892), a legendary drama, and by the historical dramas of *Erik XIV.* (1899), *Gustav Adolf* (1900), and *Gustav Vasa* (1899); *Till*

Damascus (1898) indicated a return in the direction of religion; *Folkungasagan* (1899) was represented in 1901; and the two plays *Avent* ("Advent") and *Brott och brott* ("Crime for Crime"), printed together in 1899, were successfully represented in 1900, both in Sweden and Germany.

Strindberg has provided a quantity of what is really autobiographical material, with an account of the origin of his various books, in the form of a novel, *Tjenstestevinnans son* ("The Son of a Servant," 1886–1887), with the sub-title of "A Soul's Development." The revelations of this book explain much of the bitterness of his work, and it was followed in 1893 by a fourth part in German, *Die Beichte eines Thoren* ("A Fool's Confession"), the printing of which was forbidden in Sweden. With these should be classed his *Inferno* (1897) and *Sömnängarnätter* ("The Nights of a Somnambulist," 1900). Strindberg's first marriage was an unfortunate one, and was dissolved in 1893. He then married an Austrian lady, from whom he was separated in 1896. In 1901 he married the Swedish actress Harriet Bosse, from whom he was amicably separated soon afterwards. He suffered at different times from mental attacks, of which he gave analytic accounts on his recovery.

A number of criticisms on Strindberg from eminent hands are collected in *En bok om Strindberg* (Karlstad, 1894).

STRING, a general term for thin cord, or stout thread, a line or cord on which objects are strung. The O. Eng. word is *streng*, cf. Dan. *streng*, Ger. *Strang*, and meant that which is strongly or tightly twisted; it is related to "strong," and is to be referred to the root seen also in Lat. *stringere*, to draw tight, whence "stringent" and "strict," and in Gr. *σπαραγάλη*, a halter, whence comes "strangle," to choke, throttle. The word is particularly used of the cord of a bow, and of the stretched cords of gut and wire upon a musical instrument, the vibration of which produces the tones (see STRINGED INSTRUMENTS below). In architecture the term "string-course" is applied to the projecting course or moulding running horizontally along the face of a building.

STRINGED INSTRUMENTS (Fr. *instruments à cordes*; Ger. *Saiteninstrumente*; Ital. *strumenti a corde*), a large and important section of musical instruments comprising subdivisions classed (A) according to the method in which the strings are set in vibration (B) according to certain structural characteristics of the instruments themselves.

Section A.—This includes instruments with strings (1) plucked by fingers or plectrum; (2) struck by hammers or tangents; set in vibration (3) by friction of the bow, (4) by friction of a wheel or (5) by the wind. In all these classes we are also concerned with the manner in which the strings are stretched in order to ensure resonance, and with the measures taken to obtain more than one sound from each string.

1. *Strings plucked by Fingers or Plectrum.*—Twanging the strings by the fingers is the most primitive method, probably suggested by the feeble note given out by the tense string of the hunters' bow, which was the prototype of the harp. In this ancient instrument, popular in all ages and lands, the strings are stretched *à vide* between two supports of a frame, the lower of which acts as a soundboard from which the strings rise perpendicularly. The scale of all harp-like instruments is produced by means of one string for each note, difference in pitch being obtained by varying the length of the strings. In the modern pedal harp with double action the strings can be shortened sufficiently to raise the pitch a semitone or a tone by means of an ingenious system of levers set in motion by the pedals, which cause disks, each furnished with two studs, to turn and grasp the string, thus shortening the vibrating length. This device may be regarded as an infringement of the principle of the harp, whereas in the chromatic harp (Pleyel Wolff & Co.) the same object has been obtained without violating the principle by ingeniously increasing the number of strings. The *nanga* of the ancient Egyptians, of which specimens are preserved in the British Museum, an instrument having a boat-shaped body with a long curved neck from which the strings stretch at right angles to the soundboard, is the only link as yet discovered between the bow and the harp. The next step observed is the device of stretching the strings partly over a soundboard and partly *à vide*, as in the cithara, the lyre, the rotta, the crwth, &c.

The strings lying parallel with the soundboard are slightly raised over a bridge, by means of which the vibrations are communicated to the belly of the instrument. Between the soundboard and the

cross-bar, upheld by two arms springing from the body of the instrument, the strings at first bridged an open space for greater convenience in twanging them with both hands. The gradual closing up of this open space marks the various steps in the transition from cithara to fiddle. In the Egyptian cithara the harp-like arrangement of the strings was maintained by making the cross-bar oblique. In the Assyrian and later in the Greek and Roman citharas and lyres all the strings were of the same length, difference in pitch being secured by varying the thickness of the strings.

A later development consisted in discarding the open space altogether, whereby the third method of stretching the strings was evolved. In these new instruments the strings lay over the sound-chest, raised on bridges which determined their vibrating length according to the method of stringing the harp or the cithara. As examples of this type may be cited the psalterion or psaltery and in the middle ages the zither.

The addition of a keyboard to the psaltery, as a means of increasing its scope, created a new class of instruments of which the principal members were the clavicymbalum, the virginal, spinet and the harpsichord. In these the principle of plucking the strings by means of a plectrum or quill was preserved, but the quill was fixed in the pivoted tongue of a piece of wood, known as a "jack," which rested on the end of a balanced key. The jack worked easy through a rectangular hole in the soundboard, and when the key was pressed down the jack was thrown up, the quill catching the string and plucking it. The string thus plucked vibrated over the whole length from hitch-pin to belly-bridge (cf. the effect of the tangent in the clavichord).

When the principle of stopping strings by pressing them against a fingerboard in order to obtain several sounds from each had been discovered and applied by adding a neck to the body, a new subdivision was created in this class of instruments. The exact division of the strings necessary to produce the required intervals was measured off and indicated by ligatures of hide or gut (called frets), bound round the neck, against which the strings were pressed by the fingers. This principle involved a very great advance in technique, and produced the two great families of guitar and lute. During the middle ages, the bass lute (theorbo or barbiton) and the double-bass lutes (archlute and chitarrone) had, in addition to the strings stretched over the finger-board, for which the pegs were placed half-way up the neck, a complement of bass strings stretched *à vide* from the bridge tail-piece to the end of the neck, where a second peg-box was provided. In the chitarrone these bass strings, each of which produced but one note, were about 5 ft. long; the archlute of similar construction was in size between the former and the theorbo.

The plectrum was used to pluck the strings in classic Greece and Rome, in order to provide an additional effect of brilliancy for joyous or martial themes. If the music gained in brilliancy, the instrument lost the power of expressing the performer's emotions. During the middle ages the use of wire and spun strings in some instruments, such as the mandola, rendered the use of the plectrum a necessity.

2. *Strings struck by Hammers or Tangents.*—The earliest known instrument thus played was the Assyrian dulcimer, or *psantir*, represented on some of the stone slabs brought by Sir A. H. Layard from the mound of Kuyunjik, and preserved at the British Museum among scenes from the history of Sardanapalus; it is the instrument erroneously rendered *psaltery* in Dan. iii. 5, while the instrument rendered dulcimer in the Authorized Version of the Bible should be bagpipe.

In the dulcimer the strings, as in the psaltery, were stretched over a rectangular or trapezoid sound-chest, the vibrating length being determined by means of two bridges. The strings were struck by means of two curved sticks, or by hammers, with an elastic wrist action, which produced clear, bell-like tones. The dulcimer has survived in the *cembalo* or *cimbalom* of the Hungarian gipsies. The application of the keyboard to the dulcimer produced the clavichord and later the pianoforte. In the earliest clavichords, known as fretted (Ger. *gebunden*), one string was made to do duty for several notes. The tangent or upright blade of brass tapering towards the bottom, where it was fastened into the end of the key, replaced the hammer of the dulcimer, for which it was hardly a substitute for the following reason. The function of the tangent constitutes the main technical innovation; instead of giving a sharp blow and rebounding instantly from the string, like the hammer on the strings of the dulcimer, the tangent remained on the string as long as the key was pressed down, and as it rose cloth dampers stopped the vibration. It is usual to compare the tangent of the clavichord to the hammer of the dulcimer, but the action of the tangent more nearly resembles the pressure of the finger on the string of the violin. Just as the finger determines the vibrating length of the violin string from the bridge, so the tangent sets the string vibrating from the point of impact to the belly-bridge. By twisting the key levers, the tangents belonging to three or four different keys were brought to bear on the same string or group of unisons at different points, all the strings being of the same length. It was not until the 18th century that fret-free or *bund-frei* clavichords were invented; they had throughout the compass a key and a tangent to each pair of unisons. The action

of the hammer of the dulcimer reappeared in the pianoforte. Owing to the peculiar action of the tangent it was possible to produce on the clavichord the *vibrato* effect (*Bebung*) as in the violin, an effect which is impracticable on any other keyboard instrument.

3. *Strings set in Vibration by Friction of the Bow.*—Although used with various other instruments, such as the Oriental rebab and its European successor the rebec, with the oval vielle, the guitar or troubadour-fiddle and the viols, it is with the effect of the bow on the perfected type represented by the violin family that we are mostly concerned. The strings in this case are all of the same length, difference in pitch being secured by thickness and tension. The fingers, by pressing the strings, produce a variety of notes from each string at will by shortening the vibrating section as the position of the fingers shift in the direction of the bridge. The friction of the bow on the string induces a twofold vibration, the actual longitudinal vibration of the string and the molecular, both of which are transmitted by the bridge to the soundboard, whereby they become intensified or reinforced. To this class belong also the Welsh crwth and the tromba marina.

4. *Strings set in Vibration by Friction of a Wheel.*—This class is small, being represented mainly by the organistrum and the hurdy-gurdy and a few sostenente keyboard instruments. In these instruments the rosined wheel performs mechanically the function of the bow, setting the strings in vibration as it revolves. A row of ten or twelve keys controlling wooden tangents performs the function of the fingers in stopping the strings. Two or more strings outside the range of the tangents always sound the same drone bass, the fingers playing the melody on the treble strings.

5. *Strings set in Vibration by the Wind.*—An example is the aeolian harp. Here the eight strings of different thickness, but tuned strictly in unison and left slack, are set in vibration by a current of air passing obliquely across them, causing the strings to divide into aliquot parts, thus producing various harmonics.

Section B.—There are, besides, certain structural features in the instruments independent of the strings, which influence the quality of tone to a greater or lesser degree. First, the construction of the sound-chest, the box form consisting of back and belly or soundboard, joined by ribs of equal width, giving the best results in classes 1 and 3. The sound-chest, consisting of a vaulted back to which is glued a flat soundboard, gives very poor results in class 3, but is eminently suitable for class 1. The position and shape of the sound-holes on each side of the strings for bowed instruments, and in the centre for those of which the strings are plucked, are not without influence on the tone. (K. S.)

STRIP, to remove or tear off the outer covering of anything, hence to rob or plunder; also a narrow long piece of stuff or material, or a mark or division narrow in proportion to its length distinguished from its ground or surroundings by colour or other variation of texture, character, &c.; a stripe; this last word is a variant of "strip," a particular meaning, that of a stroke or lash of a whip, is either due to the original meaning of "strip," to flay, or to the long narrow mark or wheel left by a blow. The O. Eng. *strypan*, to strip, is cognate with Du. *stroopen*, Ger. *streifen*, and the root is possibly seen in "strike," Lat. *stringere*. "To strip" has many technical meanings, e.g. to separate the tobacco leaf from the stems, to remove the overlying soil from a mineral deposit before opening and working it, to turn a gun-barrel in a lathe, &c. In architecture, a "strip-pilaster" is a narrow pilaster such as is found in Saxon work and in the Italian Romanesque churches. "Stripling," a youth, is apparently a diminutive of "strip," in the sense of a young growing lad.

STRODE, RALPH (fl. 1350-1400), English schoolman, was probably a native of the West Midlands. He was a fellow of Merton College, Oxford, before 1360, and famous as a teacher of logic and philosophy and a writer on educational subjects. He belonged, like Thomas Aquinas and Bonaventura, to that "School of the Middle" which mediated between realists and nominalists. Besides his *Logica*, which has not survived, he wrote *Consequentiae*, a treatise on the syllogism, and *Obligationes* or *Scholastica militia*, a series of "formal exercises in scholastic dialectics." He had some not unfriendly controversy with his colleague John Wyclif, against whom he defended the possession of wealth by the clergy, and held that in the Church abuses were better than disturbance. He also attacked Wyclif's doctrine of predestination. His positions are gathered from Wyclif's *Responiones ad Rodolphum Strodum* (MS. 3926,

Vienna Imperial Library). Strode is also associated with John Gower in Chaucer's dedication of *Troilus and Cryseyde*, and Strode himself, according to the 15th-century *Vetus catalogus* of fellows of Merton, was a "poeta nobilis." Leland and Bale confirm this testimony, and Professor I. Gollancz has suggested the identification of the *Phantasma Radulphi* attributed to Strode in the *Vetus catalogus* with the beautiful 14th-century elegiac poem *The Pearl*. If this hold good, Strode wrote also *Cleanness*, *Patience*, and *Sir Gawayne and the Green Knight*. From 1375 to 1385 this Strode or another of the same name was common sergeant of the city of London; he died in 1387.

See Prantl, *Geschichte der Logik*; for an attempt to distinguish between Strode the schoolman and Strode the poet, see J. T. T. Brown, in *The Scottish Antiquary* (1897), vol. xii.

STRODE, WILLIAM (1598-1645), English parliamentarian, second son of Sir William Strode, of Newnham, Devonshire (a member of an ancient family long established in that county, which became extinct in 1897), and of Mary, daughter of Thomas Southcote of Bovey Tracey in Devonshire, was born in 1598. He was admitted as a student of the Inner Temple in 1614, matriculated at Exeter College, Oxford, in 1617, and took the degree of B.A. in 1619. He was returned to parliament in 1624 for Beerlston, and represented the borough in all succeeding parliaments till his death. He from the first threw himself into opposition to Charles I. and took a leading part in the disorderly scene of the 2nd of March 1629, when the speaker, Sir John Finch, refusing to put the resolution of Sir J. Eliot against arbitrary taxation and innovations in religion, was held down in the chair (see HOLLES, DENZIL). Prosecuted before the star chamber, he refused "to answer anything done in the House of Parliament but in that House." On the 7th of May a fresh warrant was issued, and a month later, to prevent his release on bail, he was sent by Charles with two of his fellow members to the Tower. Refusing to give a bond for his good behaviour, he was sentenced to imprisonment during the king's pleasure, and was kept in confinement in various prisons for eleven years. In January 1640, in accordance with the king's new policy of moderation, he was liberated; and on the 13th of April took his seat in the Short Parliament, with a mind embittered by the sense of his wrongs. In the Long Parliament, which met on the 3rd of November 1640, he was the first to propose the control by parliament over ministerial appointments, the militia, and its own duration; supported the Grand Remonstrance of the 7th of November 1641; and displayed a violent zeal in pursuing the prosecution of Strafford, actually proposing that all who appeared as the prisoner's counsel should be "charged as conspirators in the same treason." As a result he was included among the five members impeached by Charles of high treason on the 3rd of January 1642. (See PYM, JOHN; ELIOT, SIR JOHN; HAMPDEN, JOHN; HESIBRIGE, SIR ARTHUR; and CHARLES I.). He opposed all suggestions of compromise with Charles, urged on the preparations for war, and on the 23rd of October was present at the battle of Edgehill. In the prosecution of Laud he showed the same relentless zeal as he had in that of Strafford, and it was he who, on the 28th of November 1644, carried up the message from the Commons to the Lords, desiring them to hasten on the ordinance for the archbishop's execution. Strode did not long survive his victim. He is mentioned as having been elected a member of the assembly of divines on the 31st of January 1645. He died on the 9th of September of the same year, and by order of parliament was accorded a public funeral in Westminster Abbey. The body was exhumed after the Restoration. Strode was a man of strong character, but of narrow, though clear and decided judgment, both his good and his bad qualities being exaggerated by the wrongs he had suffered. Clarendon speaks of him as a man "of low account and esteem," who only gained his reputation by his accidental association with those greater than himself; but to his own party his "insuperable constancy" gave him a title to rank with those who had, at a time when the liberties of England hung in the balance, deserved best of their country.

The identity of the W. Strode imprisoned in 1628 and of the W. Strode impeached in 1642 has been questioned, but is now established (J. Forster, *Arrest of the Five Members*, p. 198, note; *Life of Sir J. Eliot*, ed. 1872, ii. 237, note; J. L. Sanford, *Studies*, p. 397; Gardiner, *Hist. of England*, ix. 223). On the other hand he is to be distinguished from Colonel Wm. Strode of Barrington, also parliamentarian and M.P., who died in 1666; and from William Strode (1602 or 1600-1645), the orator, poet and dramatist, whose poetical works were edited, with a memoir, by Bertram Dobell in 1907.

STROMNESS, a police burgh and seaport, in the island of Pomona, county of Orkney, Scotland. Pop. (1901), 2450. It is situated on the side of a well-sheltered bay, 14 m. by steamer west of Kirkwall. Many of the houses are within tidal limits and furnished with quays and jetties. The harbour admits vessels of all sizes and is provided with a pier and slips. The deep-sea fishery attracts hundreds of boats from the north of Scotland, and most of the catch is cured for the English, German and Dutch markets. Stromness is in daily communication with Scrabster pier (Thurso), and at frequent intervals with Kirkwall by coach and also by steamer. It is a port of call for ships trading with the north of Europe as well as for vessels outward bound to the Arctic regions, Hudson Bay and Canada. The magnificent scenery of the west coast of Pomona is commonly visited from Stromness. The tour includes Black Craig (400 ft.), on which the schooner "Star of Dundee" was wrecked in 1834; the grand stacks of North Gaulton Castle and Yesnaby Castle; the Hole of Row, a natural arch carved out by the ocean; Birsay, where are the ruins of the palace built by Robert Stewart, earl of Orkney (d. 1592), natural son of James V., the traces of a church which is believed to have been built by Jarl Thorfinn on his return from Rome, in which the remains of St Magnus reposed until their burial in Kirkwall Cathedral, and, on the Broch of Birsay (95 ft. high), the ruins of St Peter's church.

STRONGYLION, a Greek sculptor, the author of a bronze figure of a horse set up on the Acropolis of Athens late in the 5th century B.C., which represented the wooden horse of Troy with the Greek heroes inside it and looking forth. The inscribed basis of this figure has been found. Other works of the sculptor were a figure of Artemis at Megara, a group of the Muses, and an Amazon which was greatly admired by the emperor Nero.

STRONTIANITE, a mineral consisting of strontium carbonate, SrCO₃. It takes its name from Strontian in Argyllshire, where it appears to have been known as far back as 1764, but it was not recognized as a distinct mineral until later, when the examination of it led to the discovery of the element strontium. It crystallizes in the orthorhombic system and is isomorphous with aragonite and witherite. Distinctly developed crystals are, however, of rare occurrence; they are usually acicular with acute pyramid-planes and are repeatedly twinned on the prism. Radiating, fibrous or granular aggregates are more common. The colour is white, pale green or yellowish brown. The hardness is 3½ and the specific gravity 3.7. Strontium is sometimes partly replaced by an equivalent amount of calcium. The mineral occurs in metalliferous veins in the lead mines of Strontian in Argyllshire, Pateley Bridge in Yorkshire, Bräunsdorf near Freiberg in Saxony; abundantly in veins in calcareous marl near Münster and Hamm in Westphalia; and in limestone at Schoharie in New York. It is used for producing red fire in pyrotechny and for refining sugar. (L. J. S.)

STRONTIUM [Symbol Sr, atomic weight 87.62 (O=16)], a metallic chemical element belonging to the alkaline earth group. It is found in small quantities very widely distributed in various rocks and soils, and in mineral waters; its chief sources are the minerals strontianite, celestine and barytocelestine. The metal was detected in the mineral strontianite, found at Strontian in Argyllshire, by Cruikshank in 1787, and by Crawford in 1790; and the discovery was confirmed by Hope in 1792 and by Klaproth in 1793. The metal was isolated in 1807 by Sir H. Davy by electrolysis of the moist hydroxide or chloride, and has been obtained by A. Guntz and Roederer (*Comptes rendus*, 1906, 142, p. 400) by heating the hydride in a vacuum to 1000°. By electrolysis of an aqueous solution of the chloride with a mercury cathode, a liquid and a solid amalgam, SrHg₁₁, are obtained;

the latter on heating gives a mixture of Sr_2Hg_3 and SrHg_6 , and on distillation an amalgam passes over, and not the metal. It is a silver-white ductile metal (of specific gravity 2.54) which melts at 800° . It oxidizes rapidly when exposed to air, and burns when heated in air, oxygen, chlorine, bromine or sulphur vapour. With dry ammonia at 60° the metal forms strontium ammonium, which slowly decomposes in a vacuum at 20° giving $\text{Sr}(\text{NH}_3)_2$; with carbon monoxide it gives $\text{Sr}(\text{CO})_2$; with oxygen it forms the monoxide and peroxide, and with nitric oxide it gives the hyponitrite (Roederer, *Bull. soc. chim.*, 1906 [iii.], 35, p. 715).

The *hydride*, SrH_2 , was obtained by Guntz on heating strontium amalgam in a current of hydrogen. It is a white solid, which readily decomposes water in the cold and behaves as a strong reducing agent. It dissociates when heated to a high temperature and is not affected by oxygen. The *monoxide* or *strontia*, SrO , is formed by strongly heating the nitrate, or commercially by heating the sulphide or carbonate in superheated steam (at about 500 – 600° C.). It is a white amorphous powder which resembles lime in its general character. By heating the amorphous form in the electric furnace H. Moissan succeeded in obtaining a crystalline variety. The amorphous form readily slakes with water, and the aqueous solution yields a crystalline hydrated hydroxide approximating in composition to $\text{Sr}(\text{OH})_2 \cdot 8\text{H}_2\text{O}$ or $\text{Sr}(\text{OH})_2 \cdot 9\text{H}_2\text{O}$, which on standing in vacuo loses some of its water of crystallization, leaving the monohydrated hydroxide, $\text{Sr}(\text{OH})_2 \cdot \text{H}_2\text{O}$. The ordinary hydrated variety forms quadratic crystals and behaves as a strong base. It is used in the extraction of sugar from molasses, since it combines with the sugar to form a soluble saccharate, which is removed and then decomposed by carbon dioxide. A hydrated *dioxide*, approximating in composition to $\text{SrO}_2 \cdot 8\text{H}_2\text{O}$, is formed as a crystalline precipitate when hydrogen peroxide is added to an aqueous solution of strontium hydroxide.

Strontium fluoride, SrF_2 , is obtained by the action of hydrofluoric acid on the carbonate, or by the addition of potassium fluoride to strontium chloride solution. It may be obtained crystalline by fusing the anhydrous chloride with a large excess of potassium hydrogen fluoride or by heating the amorphous variety to redness with an excess of an alkaline chloride. *Strontium chloride*, $\text{SrCl}_2 \cdot 6\text{H}_2\text{O}$, is obtained by dissolving the carbonate in hydrochloric acid, or by fusing the carbonate with calcium chloride and extracting the melt with water. It crystallizes in small colourless needles and is easily soluble in water; the concentrated aqueous solution dissolves bromine and iodine readily. By concentrating the aqueous solution between 90 – 130° C., or by passing hydrochloric acid gas into a saturated aqueous solution, a second hydrated form of composition, $\text{SrCl}_2 \cdot 2\text{H}_2\text{O}$, is obtained. The anhydrous chloride is formed by heating strontium or its monoxide in chlorine, or by heating the hydrated chloride in a current of hydrochloric acid gas. It is a white solid, which combines with gaseous ammonia to form $\text{SrCl}_2 \cdot 8\text{NH}_3$, and when heated in superheated steam it decomposes with evolution of hydrochloric acid.

Strontium sulphide, SrS , is formed when the carbonate is heated to redness in a stream of sulphuretted hydrogen. It phosphoresces very slightly when pure. *Strontium sulphate*, SrSO_4 , found in the mineral kingdom as celestine, is formed when sulphuric acid or a soluble sulphate is added to a solution of a strontium salt. It is a colourless, amorphous solid, which is almost insoluble in water, its solubility diminishing with increasing temperature; it is appreciably soluble in concentrated sulphuric acid. When boiled with alkaline carbonates it is converted into strontium carbonate.

Strontium nitride, Sr_3N_2 , is formed when strontium amalgam is heated to redness in a stream of nitrogen or by igniting the oxide with magnesium (H. R. Ellis, *Chem. News*, 1909, 99, p. 4). It is readily decomposed by water, with liberation of ammonia. *Strontium nitrate*, $\text{Sr}(\text{NO}_3)_2$, is obtained by dissolving the carbonate in dilute nitric acid. It crystallizes from water (in which it is very soluble) in monoclinic prisms which approximate in composition to $\text{Sr}(\text{NO}_3)_2 \cdot 4\text{H}_2\text{O}$ or $\text{Sr}(\text{NO}_3)_2 \cdot 5\text{H}_2\text{O}$. When heated it fuses in its own water of crystallization and becomes anhydrous at 110° C. It is used in pyrotechny for the manufacture of red-fire. A *strontium boride*, SrB_6 , was obtained as a black crystalline powder by H. Moissan and P. Williams (*Comptes rendus*, 1897, 123, p. 633) by reducing the borate with aluminium in the electric furnace.

Strontium carbide, SrC_2 , is obtained by heating strontium carbonate with carbon in the electric furnace. It resembles calcium carbide, decomposing rapidly with water, giving acetylene. *Strontium carbonate*, SrCO_3 , found in the mineral kingdom as strontianite, is formed when a solution of a carbonate is added to one of a strontium salt. It is an amorphous solid, insoluble in water, but its solubility is increased in the presence of ammonium nitrate. It loses carbon dioxide when heated to high temperature.

Strontium salts may be recognized by the characteristic crimson colour they impart to the flame of the Bunsen burner and by the precipitation of the insoluble sulphate. On the preparation of

pure strontium salts, see Adrian and Bougarel, *Journ. pharm. chem.*, 1892 (5), p. 345; and S. P. L. Soerenoen, *Zeit. anorg. chem.*, 1895, 11, p. 305. Recent determinations of the atomic weight of strontium are due to T. W. Richards (*Zeit. anorg. Chem.*, 1905, 47, p. 145), who, by estimating the ratios of strontium bromide and chloride to silver, obtained the values 87.663 and 87.661.

STROPHANTHUS, a genus of plants of the natural order Apocynaceae, deriving its name from the long twisted thread-like segments of the corolla, which in one species attain a length of 12 or 14 inches. The genus comprises about 30 species, mainly tropical African, extending into South Africa, with a few species in Asia, from farther India to the Philippines and China. Several of the African species furnish the natives with the principal ingredient in their arrow poisons. The *inéc* or *onaye* poison of the Gaboon, the *kombé* of equatorial North Africa, the *arqah* of the banks of the Niger and the *wanika* of Zanzibar are all derived from members of this genus. The exact species used in each case cannot be said to be accurately known. There is no doubt, however, that *S. hispidus* and *S. kombé* are those most frequently employed.

Both *S. hispidus* and *S. kombé* have hairy seeds with a slender thread-like appendage, terminating in a feathery tuft of long silken hairs, the seeds of the former being coated with short appressed brown hairs, and those of the latter with white hairs; but in the species used at Delagoa Bay and called "umtsuli" the thread-like appendage of the seed is absent. The natives pound the seeds into an oily mass, which assumes a red colour, portions of this mass being smeared on the arrow immediately behind the barb.

Under the name of *strophanti semina*, the dried ripe seeds of *Strophanthus kombé*, freed from awns, are official in the British and many other pharmacopœias. The seeds must be mature. They are about $\frac{3}{8}$ in. long, $\frac{1}{8}$ in. broad, greenish fawn, covered with flattened silky hairs, and oval-acuminate in shape. They are almost odourless, but have an intensely bitter taste. The chief constituent is a white microcrystalline glucoside, known as *strophanthin*, freely soluble in water and alcohol, but not in chloroform or ether, and melting at about 173° C. It constitutes about 50% of the mature cotyledons of the seed, the proportion rising as maturity is reached. It is very similar to, but not identical with, *onabain*. It is split up by acids into *strophanthidin* and a methyl-ether of a peculiar sugar. The seeds also contain an active principle, *inein*, a body known as *kombic acid*, fat, resin and starch. The resin is contained in the husk, and occurs in the alcoholic tincture of *strophanthus*, its presence tending to cause digestive disturbance and diarrhoea. When the seeds are treated with sulphuric acid and heat is applied, a violet-coloration is produced. A section of the seed yields a green colour with cold sulphuric acid.

The British Pharmacopœia contains two preparations of this important and valuable drug, a dry extract and a tincture. The former is hardly ever prescribed. The official tincture is much inferior to that originally recommended by Sir Thomas Fraser, who introduced the drug into medical practice, in being much too weak, and in being prepared with alcohol instead of ether, which differs from alcohol in not dissolving the resin contained in the husks. It is therefore advisable to order the tincture of the British Pharmacopœia of 1885, or to prescribe the current tincture in double the official dose and combined with cardamoms, ginger or capsicum, in order to counteract the irritant properties of the resin which it contains.

Strophanthin itself may be injected hypodermically in doses of $\frac{5}{16}$ to $\frac{1}{16}$ grain. Unfortunately the injections usually cause some temporary local irritation. This method of exhibiting *strophanthus* is the only one of any avail when a result is wanted at once or even within several hours. Precisely the same observation applies to *digitalis*, the other great cardiac tonic.

Pharmacology.—The drug has no external actions. Taken internally it tends, after the repetition of large doses, to produce some gastric irritation. This is unquestionably less, however, than that produced by *digitalis*, and is probably due not at all to the active principle but entirely to the resin contained in the seed-husk. As ordinarily administered, the drug acts on the heart before influencing any other organ or tissue. Often indeed no other action can be observed. This is readily explained by the fact that the drug is carried by the coronary arteries to the cardiac muscle before it reaches any other part of the systemic circulation.

It is almost certain that *strophanthus* acts directly on no other cardiac structure than the muscle-fibre. No action can certainly be demonstrated either upon the terminals of the vagus nerves nor upon the intra-cardiac nervous ganglia. The muscular force is increased in a very marked degree. A secondary consequence of

this is that the diastole is prolonged, and the pulse thus rendered less frequent. If the heart is beating irregularly the drug tends to make it more regular. The action is similar to that of digitalis—and fifty years ago both these drugs would thus have been regarded, as indeed digitalis was, as cardiac sedatives. As the cardiac muscle receives its blood supply only during diastole, it follows that strophanthus, while increasing the force of each beat, yet lengthens the period during which the muscle rests and is fed—thus being, in a paradoxical sense, a sedative as well as a stimulant. In fatal cases of strophanthus poisoning death is brought about by the arrest of the heart in systole, *i.e.* in a state of tetanic spasm from overstimulation. This of course is a striking exception to the natural rule that death finds the heart in a state of relaxation and inability to contract. Strophanthus markedly raises the blood-pressure, but this action is proportional to and almost entirely due to the increased force of the heart; not, as in the case of digitalis, to constriction of the arterioles.

Its action on the heart causes strophanthus to exert a powerful diuretic action, especially in cases of dropsy of cardiac origin. It is a less powerful diuretic than digitalis as a rule. The drug has no action on the nervous system, but in toxic doses it powerfully affects the voluntary striped muscles. This action may be correlated with that exerted upon the cardiac muscle, which is striped, though not voluntary, and contrasted with its want of action upon the muscular fibre of the arteries, which is involuntary and non-striped.

The drug, like onabain, has a slight anaesthetic action when locally applied to the eyeball, and also causes contraction of the pupil.

Strophanthin is one of the most active and lethal of all known substances. One-hundredth of a grain will kill a mammal weighing four pounds, and one-third of a grain will kill a man of average weight. Serum containing one part of strophanthin in ten millions will arrest the frog's heart in systole.

Strophanthus is used therapeutically only as a cardiac stimulant. When given by the mouth it acts somewhat more rapidly than digitalis, being more soluble; but it is of course far less speedy in action than ether, ammonia or such a pseudo-stimulant as ethyl alcohol. In mitral disease of the heart especially strophanthus is an invaluable drug. It frequently succeeds when digitalis has failed; occasionally it fails where digitalis succeeds. It has the great advantage over digitalis of being non-cumulative, and can be administered continually for many weeks or even months at a time. It is never to be given in acute Bright's disease, but is frequently of use in chronic Bright's disease, where digitalis, owing to its influence on the already over-contracted arterioles, is absolutely contra-indicated.

STROPHE (Gr. *στροφή*, from *στρέφειν*, to turn), a term in versification which properly means a turn, as from one foot to another, or from one side of a chorus to the other. In its precise choral significance a strophē was a definite section in the structure of an ode, when, as in Milton's famous phrase in the preface to *Samson Agonistes*, "strophe, antistrophe and epode were a kind of stanzas framed only for the music." In a more general sense the strophe is a collection of various prosodical periods combined into a structural unit. In modern poetry the strophe usually becomes identical with the stanza, and it is the arrangement and the recurrence of the rhymes which give it its character. But the ancients called a combination of verse-periods a system, and gave the name *strophe* to such a system only when it was repeated once or more in unmodified form. It is said that Archilochus first created the strophe by binding together systems of two or three lines. But it was the Greek ode-writers who introduced the practice of strophe-writing on a large scale, and the art was attributed to Stesichorus, although it is probable that earlier poets were acquainted with it. The arrangement of an ode in a splendid and consistent artifice of strophe, antistrophe and epode was carried to its height by Pindar (see ODE). With the development of Greek prosody, various peculiar strophe-forms came into general acceptance, and were made celebrated by the frequency with which leading poets employed them. Among these were the Sapphic, the Elegiac, the Alcaic and the Asclepiadean strophe, all of them prominent in Greek and Latin verse. The briefest and the most ancient strophe is the dactylic distich, which consists of two verses of the same class of rhythm, the second producing a melodic counterpart to the first. The forms in modern English verse which reproduce most exactly the impression aimed at by the ancient ode-strophe are the elaborate rhymed stanzas of such poems as the "Nightingale" of Keats or the "Scholar-Gypsy" of Matthew Arnold (see VERSE).

STROSSMAYER, JOSEPH GEORGE [JOŠIP JURAJ ŠTROSSMAJER] (1815–1905), Croatian bishop and politician, was born at Esseg in Croatia-Slavonia on the 4th of February 1815. Strossmayer was of German descent and his parents had emigrated from Linz in Austria. He was educated at the Roman Catholic seminary of Djakovo, in his native country, and at Budapest, where he studied theology. In 1838 he took holy orders, and during the next ten years became lecturer on theology at Djakovo, chaplain to the Austrian emperor, and director of the Augustinian body at Rome. In 1849 he was consecrated bishop of Djakovo, with the official title "Bishop of Bosnia, Slavonia and Sirmium." He fostered the growth of Slavonic nationalism in Croatia-Slavonia, in Dalmatia, and among the Slovenes of south Austria, aiding the Ban Jellačić in his campaigns against Hungary (1848–49), and subsequently becoming a recognized leader of the opposition to Hungarian predominance (see CROATIA-SLAVONIA). Besides being foremost among the founders of the South Slavonic Academy in 1867, and of Agram University in 1874, he helped to reorganize the whole educational system of Dalmatia and Croatia-Slavonia. He built a palace and cathedral at Djakovo, founded a seminary for the Bosnian Croats, presented the South Slavonic Academy with a gallery of valuable pictures, and published collections of national songs and tales. He also aided Augustin Theiner, then librarian at the Vatican, to compile his *Vetera monumenta Slavorum meridionalium historiam illustrantia* (Rome, 1863). As a theologian, Strossmayer became prominent by his energetic opposition to the dogma of infallibility at the Vatican council of 1870, and by his denunciation of the Jesuits, while they in return charged him with allowing Roman Catholics to adopt the orthodox Greek confession. For years he refused to accept the doctrine of infallibility, but ultimately he yielded. Despite this attitude, he enjoyed the confidence of Pope Leo XIII. He headed the Slavonic deputations which visited Rome in 1881 and 1888, and won for them the retention of a Slavonic liturgy by the Roman Catholics of Illyria. Strossmayer withdrew from political life in 1888, in consequence of a rebuke administered to him by the emperor for his public expression of sympathy with Russia and his consistent hostility to Hungary. He died in his ninety-first year, on the 10th of April 1905. He was a count of the Holy Roman Empire, a bishop of the pontifical throne, and a member of the theological faculties of Budapest and Vienna. By Leo XIII. he was decorated with the archiepiscopal pallium.

STROUD, a market town in the Stroud parliamentary division of Gloucestershire, England, 102½ m. W. by N. of London. Pop. of urban district (1901), 9153. It is served by the Great Western railway and a branch of the west-and-north line of the Midland. It lies on the steep flank of a narrow and picturesque valley and traversed by the Thames and Severn and the Stroudwater canals, which unite at Wallbridge close by. The church of St Lawrence is modern excepting the tower and spire. The Elizabethan town-hall and the school of science and art, commemorating Queen Victoria, are noteworthy. Stroud is the principal seat of the west of England cloth manufacture, the industry extending to Stonehouse and other places in the vicinity. Stroud has also silk-mills, dyeworks, breweries, foundries, and a manufacture of umbrellas and walking-sticks.

There is no evidence of the existence of Stroud before the Conquest, and in 1087 it was still part of the manor of Bisley, from which it was separated in the reign of Edward II. It became a centre of the cloth trade in the Tudor period, and in 1607 Henry, Lord Danvers, lord of the manor, obtained a charter from James I., authorizing a weekly market. During the 18th century the commercial importance of the town increased, though, owing to its distance from any of the great high-roads and to the localization of the clothing trade in scattered factories near water power, it was never a great centre of population. By the Reform Act of 1832 Stroud became a borough and returned two members to parliament until 1885, when it was merged in the Stroud division of Gloucestershire. The manufacture of very fine broadcloth and of scarlet-dyed cloth

has been carried on in the Stroud valley for centuries, the town being a distributing centre only, until the adoption of steam power and the erection of cloth factories in the town about 1830 led to considerable growth. Pin-making was introduced in 1835, carpet-weaving and iron-founding before 1850. Markets on Friday and Saturday are held under the grants of 1607 and 1832.

See *Victoria County History: Gloucestershire*; P. H. Fisher, *Notes and Recollections of Stroud* (1871); T. D. Fosbrooke, *Gloucestershire Records* (1807).

STROZZI, the name of an ancient and noble Florentine family, which was already famous in the 14th century. Palla Strozzi (1372-1462) played an important part in the public life of Florence, and founded the first public library in Florence in the monastery of Santa Trinita. Filippo Strozzi il Vecchio (1426-1491), son of Matteo and of Alessandra Macinghi, a famous literary woman, began to build the beautiful Strozzi palace in Florence. More celebrated was another Filippo Strozzi (1488-1538), who, although married to a Medici, opposed the hegemony of that house and was one of the leaders of the rising of 1527. On the final overthrow of the republic in 1530 Alessandro de' Medici attempted to win over Filippo Strozzi, but Strozzi had no faith in the tyrant and retired to Venice. After the murder of Alessandro he undertook the leadership of a band of republican exiles with the object of re-entering the city (1537); but having been defeated and captured and put to the torture, he committed suicide. His son Leone (1515-1554) was a distinguished admiral in the service of France and fought against the Medici; he died of a wound received while attacking Sarlino. Another Filippo (1541-1582) served in the French army, and was captured and killed by the Spaniards. Senator Carlo Strozzi (1587-1671) formed an important library and collected a valuable miscellany known as the *Carte Strozzi*, of which the most important part is now in the state archives of Florence; he was the author of a *Storietta della città di Firenze dal 1279 al 1292* (unpublished) and a *Storia della casa Barberini* (Rome, 1640). The Strozzi acquired by marriage the titles of princes of Forano, dukes of Bagnolo, &c. The Strozzi palace, which belonged to the family until 1907, was bequeathed by will to the Italian nation.

See A. Bardi, *Filippo Strozzi* (Florence, 1894); B. Niccolini, *Filippo Strozzi* (Florence); C. Guasti, *Le Carte Strozzi* (Florence, 1884-1891).

STRUENSEE, JOHAN FREDERICK (1731-1772), Danish political philosopher, was born at Halle in 1731. His father, subsequently superintendent-general of Schleswig-Holstein, was a rigid pietist; but young Struensee, who settled down in the 'sixties as a doctor at Altona, where his superior intelligence and elegant manners soon made him fashionable, revolted against the narrowness of his father's creed, became a fanatical propagandist of the atheism associated with the *Encyclopædie*, and scandalized his contemporaries by his frank licentiousness. But he was a clever doctor, and, having somewhat restored the king's health, and gained his affection, was retained as court physician, accompanied Christian VII. on a foreign tour and returned with him to Copenhagen. It had always been Struensee's ambition to play a great part in the world and realize his dream of reform. He had gathered from various Danish friends, most of them involuntary exiles of doubtful character, that the crazy, old-fashioned Dano-Norwegian state, misruled by an idiot, was the fittest subject in the world for the experiments of a man of superior ingenuity like himself; and he proceeded to worm his way to power with considerable astuteness.

First he reconciled the king and queen, for he calculated, shrewdly enough, that if the king was to be his tool he must needs make the queen his friend. At first Carolina Matilda disliked Struensee, but the unfortunate girl (she was scarce eighteen) could not fail to be deeply impressed by the highly gifted young doctor, who speedily and completely won her heart. By January 1770 he was notoriously her lover; a successful vaccination of the baby crown prince in May still further increased his influence; and when, in the course of the year, the king sank into a condition of mental torpor, Struensee's

authority became paramount. Previously to this, the capable minister of foreign affairs, J. H. E. Bernstorff (*q.v.*), was got rid of by a royal letter of the 13th of September 1770, and Struensee's disreputable friend, the exiled Count Rantzau-Ascheburg, was recalled to court; and with him came another Altona acquaintance of Struensee's, Enevold Brandt, who had also been living abroad under a cloud.

For a time Struensee kept himself discreetly in the background, though from henceforth he was the wirepuller of the whole political machine. But he soon grew impatient of his puppets. In December the council of state was abolished; and Struensee appointed himself *maitre de requêtes*. It was now his official duty to present to the king all the reports from the various departments of state; and, Christian VII. being scarcely responsible for his actions, Struensee dictated whatever answers he pleased. His next proceeding was to dismiss all the heads of departments, and to abolish the Norwegian stadholderships. Henceforth the cabinet, with himself as its motive power, was to be the one supreme authority in the state. Unfortunately, he had made up his mind to regenerate the benighted Danish and Norwegian nations on purely abstract principles, without the slightest regard for native customs and predilections, which in his eyes were prejudices. He was hampered, moreover, by not knowing a word of Danish. Many of his reforms, such, for instance, as the establishment of foundling hospitals, the abolition of capital punishment for theft and of the employment of torture in judicial process, the doing away with such demoralizing abuses as perquisites, and of "lackeyism," or the appointment of great men's domestics to lucrative public posts, were distinctly beneficial if not original. Unfortunately reform was not as much a principle as a mania with Struensee. The mere fact that a venerable institution still existed was a sufficient reason, in his eyes, for doing away with it. Changes which a prudent minister might have effected in a generation he rushed through in less than a fortnight. Between the 29th of March 1771 and the 16th of January 1772—the ten months during which he held absolute sway—he issued no fewer than 1069 cabinet orders, or more than three a day. In order to be sure of obedience he dismissed wholesale without pension or compensation the staffs of all the public departments, substituting for old and experienced officials nominees of his own, in many cases untried men who knew little or nothing of the country they were supposed to govern.

The dictator's manners were even worse than his morals. He habitually adopted a tone of insulting superiority, all the more irritating as coming from an ill-informed foreigner; and sometimes he seemed deliberately to go out of his way to shock the most sacred feelings of the respectable people. Nor was this all. His system of retrenchment, on which he particularly prided himself, was in the last degree immoral and hypocritical, for while reducing the number of the public officials, or clipping down their salaries to starvation points, he squandered thousands upon balls, masquerades, and other amusements of the court, and induced the imbecile king to present him and his friend Brandt with 60,000 rix-dollars apiece.

Still, in spite of all his blunders and brutalities, it is clear that, for a short time at least, middle-class opinion was, on the whole, favourable to him; and, had he been wise, he might perhaps have been able to defy any hostile combination. But such was his contempt for the Danish people that he cared not a jot whether they approved or disapproved of his reforms. What incensed the people most against him was the way in which he put the king completely on one side; and this feeling was all the stronger as, outside a very narrow court circle, nobody seems to have believed that Christian VII. was really mad, but only that his will had been weakened by habitual ill usage; and this opinion was confirmed by the publication of the cabinet order of the 14th of July 1771, appointing Struensee "gehejme kabinetsminister," with authority to issue cabinet orders which were to have the force of royal ordinances, even if unprovided with the royal sign-manual.

Nor were Struensee's relations with the queen less offensive to a nation which had a traditional veneration for the royal house of Oldenburg, while Caroline Matilda's shameless conduct in public brought the Crown into contempt. The society which daily gathered round the king and queen excited the derision of the foreign ambassadors. The unhappy king was little more than the butt of his environment, and once, when he threatened his keeper, Brandt, with a flogging for some impertinence, Brandt, encouraged by Struensee and the queen, actually locked him in his room and beat him with his fists till he begged for mercy. Things were at their worst during the winter of 1771. Struensee, who had, in the meantime, created himself a count, now gave full rein to his licentiousness and brutality. If, as we are assured, he publicly snubbed the queen, we may readily imagine how he treated common folk. Before long the people had an opportunity of expressing their disgust openly. In the summer of 1771 Caroline Matilda was delivered of a daughter, who was christened Louisa Augusta; and a proclamation commanded that a "Te Deum" in honour of the event should be sung in all the churches; but so universal was the belief that the child was Struensee's that, at the end of the ordinary services, the congregation rose and departed *en masse*.

The general ill will against Struensee, which had been smouldering all through the autumn of 1771, found expression at last in a secret conspiracy against him, headed by Rantzau-Ascheburg and others, in the name of the queen-dowager Juliana Maria. Early in the morning of the 17th of January 1772 Struensee, Brandt and the queen were arrested in their respective bedrooms, and "the liberation of the king," who was driven round Copenhagen by his deliverers in a gold carriage, was received with universal rejoicing. The chief charge against Struensee was that he had usurped the royal authority in contravention of the *Kongelov*. He defended himself with considerable ability and, at first, confident that the prosecution would not dare to lay hands on the queen, he denied that their *liaison* had ever been criminal. But, on hearing that she was also a prisoner of state, his courage evaporated, and he was base enough to betray her, though she did all in her power to shield him. On the 25th of April Struensee and Brandt were condemned first to lose their right hands and then to be beheaded; their bodies were afterwards to be drawn and quartered. Sentence of death was the least that Struensee had to expect. He had undoubtedly been guilty of *lèse-majesté* and gross usurpation of the royal authority, both capital offences according to pars. 7 and 26 of the *Kongelov*. The sentences were carried out on the 28th of April, Brandt suffering first.

See Élie Salomon François Reverdil, *Struensee et la cour de Copenhague 1760-1772* (Paris, 1858); Karl Wittich, *Struensee* (Leipzig, 1879); Peter Edward Holm, *Danmark-Norges Historie*, vol. iv. (Copenhagen, 1897-1905); Gustave Bascle De Lagrèze, *La Reine Caroline-Mathilde et le Comte Struensee* (Paris, 1887); Robert Nisbet Bain, *Scandinavia*, cap. xv. (Cambridge, 1905); William Henry Wilkins, *A Queen of Tears* (London, 1904); Georg Friedrich von Jenssen-Tusch, *Die Verschwörung gegen die Königin Karoline Mathilde und die Grafen Struensee und Brandt, nach bisher ungedruckten Originalakten* (Leipzig, 1864). (R. N. B.)

STRUTT, JEDEDIAH (1726-1797), British inventor and manufacturer, was born at South Normanton, Derbyshire, where his father occupied a farm, on the 28th of July 1726. He was educated at a good country school, with a view to becoming a farmer, but, showing great aptitude for mechanical arts, he was in 1740 articled for seven years to a wheelwright at Findern, near Derby. Here he lodged with a hosier, Woollatt, whose daughter he married in 1755. In the meantime he had inherited, from his uncle, the stock on a farm at Blackwell, near south Normanton, now, and probably then, the property of the duke of Devonshire. While in occupation of this farm his brother-in-law, William Woollatt, brought to his notice the efforts that had been unsuccessfully made to produce ribbed as well as plain goods on the stocking frame, and here he invented Strutt's Derby ribbing machine. Patents were taken out by Strutt and Woollatt in 1758 and 1759. Strutt went to live at

Derby, and with his brother-in-law started a factory, "Derby Patent Ribs" at once becoming popular. In 1762 Strutt and Woollatt joined Samuel Need, a hosier of Nottingham, and carried on there and at Derby a very successful business. In 1768 they were approached by Richard Arkwright (*q.v.*), who had been recommended by Messrs Wright, bankers of Nottingham, to consult Need as to the possibilities of his cotton-spinning frame. Strutt at once realized its value, and was able to solve one or two minor difficulties which had interrupted the smooth working of the new mechanism. The firm of Arkwright, Strutt & Need started their first cotton mill at Nottingham, with horse power. Later works were erected at Cromford and, about 1780, after Strutt dissolved partnership with Arkwright, he built himself the mills at Belper and Milford, the greater part of which are still used. The partnership with Need had terminated in 1773 with the expiration of the patents. Shortly before this Strutt had made the discovery, which revolutionized the manufacture of calico, that cotton could be used throughout in its making. To house the machinery for this new invention the first fire-proof mill in England was built at Derby. In order to be near his work Strutt built, from his own designs, Milford House, near Belper, where he lived until 1795, when ill health compelled him to return to Derby. Here he died in 1797. He left three sons and two daughters.

His eldest son, William Strutt (1756-1830), was also of great mechanical ability. It was he who designed the calico factory above mentioned; he applied himself to the house-heating problem and, finally, invented the Belper stove. He also devised a self-acting spinning mule, which had however no great success. He was a fellow of the Royal Society. His son, Edward Strutt (1801-1880), was for some time M.P. for Derby, and in 1856 was raised to the peerage with the title of Baron Belper of Belper.

STRUVE, FRIEDRICH GEORG WILHELM (1793-1864), German astronomer, the son of Jacob Struve (1755-1841), was born at Altona on the 15th of April 1793. In 1808 he entered the university of Dorpat (Yuriev), where he first studied philology, but soon turned his attention to astronomy. From 1813 to 1820 he was extraordinary professor of astronomy and mathematics at the new university and observer at the observatory, becoming in 1820 ordinary professor and director. He remained at Dorpat, occupied with researches on double stars and geodesy till 1839, when he removed to superintend the construction of the new central observatory at Pulkowa near St Petersburg, afterwards becoming director. Here he continued his activity until he was obliged to retire in 1861, owing to failing health. He died at St Petersburg on the 23rd of November 1864.

Struve's name is best known by his observations of double stars, which he carried on for many years. These bodies had first been regularly measured by W. Herschel, who discovered that many of them formed systems of two stars revolving round their common centre of gravity. After him J. Herschel (and for some time Sir James South) had observed them, but their labours were eclipsed by Struve. With the 9½-in. refractor at Dorpat he discovered a great number of double stars, and published in 1827 a list of all the known objects of this kind (*Catalogus novus stellarum duplicium*). His micrometric measurements of 2714 double stars were made from 1824 to 1837, and are contained in his principal work, *Stellarum duplicium et multiplicium mensuræ micrometricæ* (St Petersburg, 1837 seq.; a convenient summary of the results is given in vol. i. of the *Duncht Observatory Publications*, 1876). The places of the objects were at the same time determined with the Dorpat meridian circle (*Stellarum fixarum imprimis duplicium et multiplicium positiones mediæ*, St Petersburg, 1852 seq.). At Pulkowa he redetermined the "constant of aberration," but was chiefly occupied in working out the results of former years' work and in the completion of the geodetic operations in which he had been engaged during the greater part of his life. He had commenced them with a survey of Livonia (1816-1819), which was followed by the measurement of an arc of meridian of more than 3½° in the Baltic provinces of Russia (*Beschreibung der Breitengradmessung in den Ostseeprovinzen Russlands*, 2 vols. 4to, Dorpat, 1831). This work was afterwards extended by Struve and General Tenner into a measurement of a meridional arc from the north coast of Norway to Ismail on the Danube (*Arc du méridien de 25° 20' entre le Danube et la Mer Glaciale*, 2 vols. and 1 vol. plates, 4to, St Petersburg, 1857-1860). (See GEODESY; EARTH, FIGURE OF.)

His son OTTO WILHELM STRUVE (b. 1819), having studied at the academy at St Petersburg, became assistant at Pulkowa in 1839, and director in 1862 on his father's resignation. From 1847 to 1862 he was advising astronomer to the headquarters of the army and navy; chairman of the International Astronomical Congress from 1867-1878; acting president of the International Metric Commission in 1872; and president of the International Congress for a Photographic Survey of the Stars in 1887, in which year he was also made a privy councillor. His contributions to astronomy cover a wide field: a list of his publications is given in Poggendorff, *Biographisch-Literarische*, vols. 2, 3, 4.

Another son, HEINRICH WILHELM STRUVE (b. 1822), studied chemistry, and obtained a public appointment as chemical expert to the administration of the Caucasus.

Two of Otto Wilhelm Struve's sons have also been prominent in the world of science. KARL HERMANN STRUVE (b. 1854) studied mathematics at Dorpat, and became in 1883 assistant, and in 1890, on his father's retirement, astronomer at the observatory at Pulkowa. In 1895 he became professor at the Albertus University and director of the observatory at Königsberg; and in 1904 he was called to Berlin as professor and director of the observatory there. His investigation of the Saturnian system was crowned by the Royal Astronomical Society of London in 1903. GUSTAV WILHELM LUDWIG STRUVE (b. 1858) studied at Dorpat, Bonn and Leipzig, and became observer at the Dorpat observatory in 1886. This post he retained until 1894, when he migrated to the university of Cracow as extraordinary professor, becoming in 1897 ordinary professor of astronomy and geodesy.

STRYCHNINE, $C_{21}H_{22}N_2O_2$, an alkaloid discovered in 1818 by Pelletier and Caventou in St Ignatius's beans (*Strychnos Ignatii*); it also occurs in other species of *Strychnos*, e.g. *S. Nuxvomica*, *S. colubrina*, *S. Tietué*, and is generally accompanied by another alkaloid brucine, $C_{23}H_{26}N_2O_4 \cdot 4H_2O$, which was isolated by Pelletier and Caventou in 1819. Strychnine crystallizes from alcohol in colourless prisms, which are practically insoluble in water, and with difficulty soluble in the common organic solvents. Its taste is exceptionally bitter. It has an alkaline reaction, and is a tertiary monacid base. It is optically active, the natural form being laevorotatory. Brucine closely resembles strychnine, and is its dimethoxy derivative. The constitutions are unknown (see J. Schmidt, *Die Alkaloidchemie*, 1904; 1909).

Medicine.—The B.P. dose of strychnine is $\frac{1}{15}$ to $\frac{1}{5}$ gr. in solution or in pill form. A preparation is *syrupus ferri phosphatis cum quina et strychnina*, containing $\frac{3}{4}$ gr. of strychnine in each fluid drachm. *Strychninae hydrochloridum* is also used; it is much more soluble than strychnine. From it is prepared *liquor strychninae hydrochloridi*, containing 1 gr. of hydrochloride in 110 minims. The United States pharmacopoeia also contains *strychninae nitras* and *strychninae sulphas*. Strychnine is incompatible with liquor arsenicalis and potassium iodide.

Physiological Action.—Applied externally strychnine is a powerful antiseptic, but its poisonous nature prevents it from being used for this purpose. Brucine is a local anaesthetic. Strychnine enters the blood as such, being freely absorbed from mucous surfaces or when given hypodermically. Internally strychnine acts as a bitter, increasing the secretion of gastric juice and the intestinal peristalsis, being a direct stimulant to the muscular coat; in this manner it has a purgative action. The specific effects of the drug, however, are upon the central nervous system. It excites the motor areas of the spinal cord and increases their reflex irritability. Small doses increase the sensibility of touch, sight and hearing; large doses cause twitching of the muscles and difficulty in swallowing; while in overdose violent convulsions are produced. The cerebral convulsions remain unaffected, but the important centres of the medulla oblongata are stimulated. Not only is the respiratory centre stimulated but the cardiac centre is acted upon both directly by the drug and indirectly for a time by the enormous rise in blood pressure due to the contraction of the arterioles all over the body. Ordinary doses have no effect upon the temperature but in overdose the temperature rises during a convulsion. Strychnine is eliminated by the kidneys as strychnine and strychnic acid. It is excreted very slowly and therefore accumulates in the system.

Therapeutics.—Strychnine is chiefly used as a stimulant. It is

indicated in paralyses (chiefly functional), and is most valuable in the treatment of post-diphtheritic paralysis. In progressive lead palsy, beri-beri, and the paralysis following acute alcoholism, fairly large doses are useful. In pneumonia and other acute disease, where the patient is liable to sudden collapse, a hypodermic injection of strychnine will often save the patient's life. In collapse following severe haemorrhage and in sudden and accidental arrest of the heart or respiration during chloroform narcosis an intramuscular injection of $\frac{1}{2}$ gr. of the hydrochloride may stimulate the cardiac action. In acute opium poisoning strychnine is very valuable. It is a physiological antagonist of chloral hydrate, morphine and physostigmine, and may be given in poisoning by these drugs. In dyspnoea due to emphysema, phthisis and asthma, strychnine is of service, given internally in doses of 1 to 3 minims of the liquor. The syrup of iron, quinine and strychnine is used as a tonic.

Toxicology.—The symptoms of strychnine poisoning usually appear within twenty minutes of the ingestion of a poisonous dose, starting with an uneasy sensation, stiffness at the back of the neck, twitching of the muscles and a feeling of impending suffocation. The patient is then seized with violent convulsions of a tetanic character; the arms are stretched out, respiration impeded, the muscles are rigid, the body is thrown into opisthotonos, i.e. it rests bow-form on the head and the heels (occasionally the body is flexed forward [emprosthotonos], the eyes remain wide open and fixed, and the mouth is drawn aside (*risus sardonicus*). After a minute the muscles relax, and the patient sinks back exhausted, consciousness being preserved throughout. Any noise, a draught of air or a touch may cause a convulsion. If the case is about to terminate fatally the spasms rapidly succeed each other and death usually occurs within two hours, either from asphyxia produced by spasm of the respiratory muscles or more rarely from exhaustion. After death the position of the body may or may not be flexed; usually rigor mortis develops rapidly. In cases which recover the convulsions diminish in severity, leaving the patient exhausted. Complications are infrequent. The average fatal dose for an adult is $\frac{1}{2}$ grs., but death has resulted in twenty minutes from $\frac{1}{2}$ grain. On the other hand, recovery has taken place after 5 and 10 and even 20 grains have been swallowed, but in the latter case an emetic was at once administered. Idiosyncrasy plays a considerable part in determining the effects, some people being particularly susceptible; death has occurred in five minutes from the appearance of the first symptoms, but when a narcotic has been administered at the same time as the poison the development is proportionately slow. Tetanus resembles strychnine poisoning, but the development of the symptoms in tetanus is usually much slower, death rarely occurring within 24 hours. In strychnine poisoning trismus or lockjaw is generally secondary to spasm of the other muscles, while in tetanus it is usually the first symptom, no relaxation taking place between the spasms.

The treatment of strychnine poisoning is to immediately evacuate the stomach with a stomach-pump or emetic, chloroform being administered to allay the spasms. If the patient can swallow, draughts of water containing tannic acid may be given. Nitrite of amyl inhalations are useful in the early stages when the respiratory muscles are freely movable. Chloral and potassium bromide may be given as physiological antidotes. If death from asphyxia appears imminent artificial respiration may be resorted to.

STRYETENSK, or **SRYETENSK**, a Cossack village of Asiatic Russia, in the province of Transbaikalia, 231 m. by rail E. of Chita, and a terminus of the Trans-Siberian railway. It is situated on both banks of the river Shilka, and its population of 8500 rises to over 10,000 during the season of navigation. Stryetensky has steam flour-mills and soap works.

STRYPE, **JOHN** (1643-1737), English historian and biographer, was born in Houndsditch, London, on the 1st of November 1643. He was the son of John Strype, or van Stryp, a member of a Brabant family who, to escape religious persecution, settled in London, in a place afterwards known as Strype's Yard in Petticoat Lane, as a merchant and silk throwster. The younger John was educated at St Paul's School, and on the 5th of July 1662 entered Jesus College, Cambridge; thence he proceeded to Catherine Hall, where he graduated B.A. in 1665 and M.A. in 1669. On the 14th of July of the latter year he became perpetual curate of Theydon Bois, Essex, and a few months afterwards curate and lecturer of Leyton in the same county. He was never instituted or inducted to the living of Leyton, but in 1674 he was licensed by the bishop of London to preach and expound the word of God, and to perform the full office of priest and curate while it was vacant, and until his death he received the profits of it. In 1711 he obtained from Archbishop Tenison the sinecure of West Tarring, Sussex, and he discharged the duties of lecturer at Hackney from 1689 till 1724. At the latter

place he spent his last years with a married granddaughter, the wife of a surgeon, Thomas Harris, dying there on the 11th of December 1737, at the age of ninety-four. He was buried in the church at Leyton.

Through his friendship with Sir William Hicks Strype obtained access to the papers of Sir Michael Hicks, secretary to Lord Burghley, from which he made extensive transcripts; he also carried on an extensive correspondence with Archbishop Wake and Bishops Burnet, Atterbury and Nicholson. The materials thus obtained formed the basis of his historical and biographical works, which relate chiefly to the period of the Reformation. The greater portions of his original materials have been preserved, and are included in the Lansdowne manuscripts in the British Museum. His works can scarcely be entitled original compositions, his labour having consisted chiefly in the arrangement of his materials, but on this very account they are of considerable value as convenient books of reference, easier of access and almost as trustworthy as the original documents. The most important of Strype's works are the *Memorials of Thomas Cranmer, Archbishop of Canterbury, 1694* (ed. for the Eccl. Hist. Soc., in 3 vols., Oxford, 1848–1854; and in 2 vols. with notes by P. E. Barnes, London, 1853); *Life of the learned Sir Thomas Smith* (1698); *Life and Acts of John Aylmer, Lord Bishop of London* (1701); *Life of the learned Sir John Cheke, with his Treatise on Superstition* (1705); *Annals of the Reformation in England* (4 vols.; vol. i. 1709 [reprinted 1725], vol. ii. 1725, vol. iii. 1728, vol. iv. 1731; 2nd ed., 1735, 4 vols.; 3rd ed., 1736–1738, 4 vols.); *Life and Acts of Edmund Grindal, Archbishop of Canterbury* (1710), of *Matthew Parker, Archbishop of Canterbury* (1711), and of *John Whitgift, Archbishop of Canterbury* (1718); *An Accurate Edition of Stow's Survey of London* (1720), a valuable edition of Stow, although its interference with the original text is a method of editing which can scarcely be reckoned fair to the original author; and *Ecclesiastical Memorials* (3 vols., 1721; 3 vols., 1733). His *Historical and Biographical Works* were reprinted in 19 vols. at the Clarendon Press, Oxford, between 1812 (*Cranmer*) and 1824 (*Annals*). A general index by R. F. Laurence in 2 vols. was added in 1828. Strype also published, besides a number of single sermons, an edition of John Lightfoot's *Works* (1684); and in 1700 *Some genuine Remains of John Lightfoot . . . with a large preface concerning the author*.

STUART, ARABELLA (1575–1615), daughter of Charles Stuart, earl of Lennox, younger brother of Lord Darnley and of Elizabeth, daughter of Sir William Cavendish and "Bess of Hardwick," is interesting historically as having been (by strict pedigree) next in succession to James VI. of Scotland to the thrones of England and Scotland, after Queen Elizabeth. Her father's mother was Margaret Douglas, the daughter of Henry VII.'s daughter, Queen Margaret of Scotland, and the earl of Angus. She was born in 1575 and early became the centre of the intrigues of those who in Elizabeth's reign refused to accept James as her successor. Various suitors for her hand were proposed, including Henry IV. of France, the earl of Northumberland, and Esmé Stuart, duke of Lennox. In 1590 a plot was formed by the moderate section of the Roman Catholics of marrying her to Ranuccio, eldest son of the duke of Parma, who was descended from John of Gaunt, and of raising her with Spanish support to the throne. She was in consequence regarded with suspicion and disfavour by Elizabeth and closely watched and guarded at Hardwick by the dowager countess of Shrewsbury. In 1602 the queen's suspicions were increased by the discovery of a plot to marry Arabella to Edward, eldest son of Lord Beauchamp, who as grandson of Edward Seymour, earl of Hertford, and of Lady Catherine Grey (younger sister of Lady Jane Grey), was heir to the throne after Elizabeth according to the will of Henry VIII. According to other accounts the intended husband was Thomas Seymour, a younger son of the earl of Hertford. Arabella entered with ardour into the project, and planned an escape from Hardwick with the aid of her chaplain Starkey, who after its failure committed suicide. In December she wrote secretly to Lord Hertford proposing her marriage with his grandson, but the latter immediately informed the council. In February 1603 another attempt at escape failed, and she was then transferred to the care of the earl of Kent at Wrest House. The anxiety and anger aroused by her conduct was reputed to be the cause of Elizabeth's death the same year. When James I. had gained secure possession of the throne, Arabella was received at court and treated with favour, and she showed her fidelity to James by revealing a communication made to her by the conspirators

in the Main and Bye Plots, in which her name had been used without her sanction. Every effort, however, was made to prevent her marriage. She is described at this time by Scaramelli, Venetian secretary in London, as "of great beauty and remarkable qualities, being gifted with many accomplishments, among them being the knowledge of Latin, French, Spanish, Italian, besides her native English"; as having "very exalted ideas, having been brought up in firm belief that she would succeed to the crown," as limited in means, of the Puritan persuasion, and very proud, insisting on a precedence over the princesses, though ordered back by the master of the ceremonies and in consequence being expelled from the court. A little later she is called "a regular termagant" and in 1607 "not very beautiful."¹ In December 1609 she planned an escape with Sir George Douglas to Scotland, apparently with a view of arranging a marriage with Stephen Bogdan, pretender to Moldavia, and on the scheme being discovered she was arrested. She was, however, restored to favour, granted a pension of £1600 a year by James, and given 10,000 crowns to pay her debts. But on the 2nd of February 1610 she became engaged to William Seymour, younger brother of Edward, and grandson of Lord Hertford, a suitor especially forbidden by James. A promise was exacted from them by the privy council that they would not marry without the king's consent, but nevertheless they were secretly married on the 22nd of June at Greenwich. Immediately it was known the culprits were imprisoned, Arabella at Lambeth and her husband in the Tower. In 1611 she was placed in charge of the bishop of Durham. Her application for a writ of habeas corpus was refused, and on the 16th of March she left London, progressing however, on account of illness and prostration, only as far as Barnet. She escaped on the 3rd of June 1611 disguised in man's clothing, and succeeded in getting on board a ship bound for Calais. Meanwhile her husband had also effected his escape and was sailing towards the French coast. Their two ships were drawing together when "a great wind arose and prevented them from seeing each other ever more."² Soon afterwards the unfortunate Arabella was captured and brought back to the Tower, where she spent the rest of her unhappy career. James was deaf to all intercession in her favour, and is reported to have answered the queen when pleading for her that "she had eaten of the forbidden fruit." In November 1613 a new plot for her escape failed. Abandoning at last all hope she sank into melancholy, ill health, and, according to some accounts, insanity, and died a victim to state policy on or about the 25th of September 1615. She was buried in the tomb of Mary Queen of Scots in Henry VII.'s chapel in Westminster Abbey. There appears to be no support for the statement that a child was born to her.

Her husband, after awaiting her in vain at Ostend, went on to Paris. He returned to England in 1616 after his wife's death and was restored to favour. He married in 1618 Frances, daughter of Robert Devereux, earl of Essex, became earl of Hertford by the death of his grandfather in 1621, and marquess in 1640. He took an active part in the civil war in Charles I.'s reign, was governor of the prince of Wales, and at the Restoration the dukedom of Somerset was revived in his favour. He died in 1660, and, on the failure of his male descendants in the person of his son John, 4th duke, the dukedom of Somerset passed to the descendants of his brother, Francis, Baron Seymour of Trowbridge, and, on the extinction of the latter's male line to the elder branch of the Seymour family, descended from Sir Edward Seymour of Berry Pomeroy, Devon.

See also *The Life and Letters of Arabella Stuart*, by E. T. Bradley (1889), which supersedes the *Life* by E. Cooper (1866).

STUART, GILBERT (1755–1828), American artist, was born at North Kingstown, Rhode Island, on the 3rd of December 1755. He studied at Newport, Rhode Island, with Cosmo Alexander, and went with him to Scotland, but returned to America after Alexander's death and obtained many portrait

¹ *Cat. of State Papers, Venetian*, ix. 541, x. 42, 514.

² Lotti, Venetian secretary, writing on the 23rd of June. *Athenaeum*, vol. 97, ii. 353.

commissions. In 1775 he went to England, and became a pupil of Benjamin West in 1778. His work, however, shows none of the influence of West, and after four years Stuart set up a studio for himself in London, meeting with much success. Living beyond his means, he got into financial difficulties, and in 1788 escaped to Dublin. In London he had painted George III. and the future George IV., and in Paris had painted Louis XVI., and his success was no less great in Ireland. After five years he left Ireland for his native land in order to paint General Washington, who was said to be the only person in whose presence Stuart found himself embarrassed, and his first portrait Stuart felt was a failure; but Washington sat to him again, the result being the "Athenaeum" head on an unfinished canvas, showing the left side of the face. This remains the accepted likeness of Washington, of whom he also painted a full-length for Lord Lansdowne; of each of these portraits he executed many replicas. Among his portraits are those of Presidents Washington, John Adams, Thomas Jefferson, James Madison, James Monroe and John Quincy Adams, and John Jay, Governor Winthrop, Generals Gates and Knox, Bishop White, Chief Justice Shippen, John Singleton Copley, Sir Joshua Reynolds, Benjamin West, Lords Clinton, Lyndhurst, and Inchiquin, Sir Edward Thornton, Mme Patterson-Bonaparte and Horace Binney. Stuart's original colouring and technique, and his insight into character, make him not only one of the few great American artists, but one of the greatest portrait painters of his time. He settled at Boston in 1805, and died there on the 27th of July 1828.

See George C. Mason, *Life and Works of Gilbert Stuart* (New York, 1879).

STUART, JAMES EWELL BROWN (1833-1864), American soldier, was born in Virginia on the 6th of February 1833 and entered West Point military academy in 1850. Commissioned in 1854 second lieutenant of cavalry, he saw considerable service in Indian warfare, and took part also in the repression of civil disorder in Kansas. In 1855 he had married a daughter of Colonel Philip St George Cooke, who was regarded as the most capable cavalry officer in the United States service, and gave his son-in-law the benefit of his experience and judgment. In 1859 Stuart, while staying in Washington on official business, was sent to assist Colonel R. E. Lee in the suppression of the John Brown raid on Harper's Ferry. Two years later the Civil War presaged by the Kansas troubles and John Brown's expedition broke out, and when Virginia seceded Stuart resigned his commission in the United States army to share in the defence of his state. He had resigned as a lieutenant—a notification of his promotion to captain had actually crossed his letter of resignation in the post—but trained officers, especially of cavalry, were so scarce that he was at once made a colonel. With very little delay, and with the scantiest of formal training, his regiment was mustered into the Confederate army, and assigned to Joseph Johnston's force in the Shenandoah Valley. His men were mounted on their own horses, knew the country thoroughly, and in his capable hands soon made themselves proficient in outpost duty. In the opening campaign Stuart's command acted as a screen to cover Johnston's movement on Manassas, and at the first battle of Bull Run which followed, Stuart distinguished himself by his personal bravery. During the autumn and winter of 1861 he continued his outpost service and was somewhat severely handled by General Ord's force at the action of Dranesville. He was now promoted brigadier-general and placed in command of the cavalry brigade of the army of Northern Virginia. Just before the Seven Days' Battle (*q.v.*) he was sent out by Lee to locate the right flank of McClellan's army, and not only successfully achieved his mission, but rode right round McClellan's rear to deliver his report to Lee at Richmond. After the battle of Gaines's Mill on the 27th of June Stuart's cavalry raided McClellan's abandoned line of communication with White House, and his dismounted riflemen, aided by a light howitzer, successfully engaged a Federal gunboat on the Pamunkey. But such romantic and far-ranging raids on this occasion, as on several others, contributed little or nothing to the success of the army as a whole. In the next campaign,

it is true, he had the good fortune, in his raid against General Pope's communications, not only to burn a great quantity of stores, but also, what was far more important, to bring off the headquarters' staff document of the enemy, from which Lee was able to discover the strength and positions of his opponents in detail. Stuart, now a major-general and commander of the cavalry corps, was present at the second battle of Bull Run, and during the Maryland campaign he brilliantly defended one of the passes of South Mountain (Crampton's Gap), thus enabling Lee to concentrate his disseminated army in time to meet McClellan's attack. After this battle the indefatigable troopers embarked upon a fresh raid, which, though without any definite object, had its value as an assertion of unbroken courage after the quasi-defeat of Antietam, and in addition wore out the Federal cavalry in vain efforts to pursue them. On this occasion the swift Virginians covered 80 miles in 27 hours and escaped with the loss of but three men. At Fredericksburg Stuart's cavalry were as usual in the flank of the army, and his horse artillery under Major Pelham rendered valuable service in checking Franklin's attack on "Stonewall" Jackson's corps by diverting a whole infantry division that formed part of Franklin's command. At Chancellorsville Stuart was specially appointed by Lee to take over command of the II. army corps after Jackson had been wounded, and though unused to commanding so large a force of all arms he acquitted himself so well in the second day's fighting that many considered that a grave injustice was done to him by the promotion of Major-General Ewell, Jackson's principal lieutenant, to fill the position left vacant by Jackson's death. The next campaign, Gettysburg, was preluded by the cavalry battle of Brandy Station, in which for the first time the Federal cavalry showed themselves worthy opponents for Stuart and his men. The march to the Potomac was screened by the cavalry corps, which held the various approaches on the right flank of the army, but at the crisis of the campaign Stuart was absent on a raid, and although he attempted to rejoin Lee during the battle, he was met and checked some miles from the field by General Gregg, so that the skill and courage which might have turned the scale in favour of Lee on the first and second days of the great battle were employed only in covering his retreat. The cavalry took part in the war of manœuvre between Meade and Lee in the autumn of 1863, and then went into winter quarters. Very shortly after the opening of the campaign of 1864 Stuart's corps was drawn away from Lee's army by the Union cavalry under Sheridan, and part of it, with which was Stuart himself, was defeated at Yellow Tavern on the 10th of May. Stuart himself was killed.

Stuart possessed the ardent and resolute character of the true cavalry leader, and although he was fortunate enough to command brigades and regiments exclusively composed of men who were both born horsemen and natives of Virginia, and to be opposed, for the first two years, by docile but unenterprising squadrons which were recruited in a more ordinary way, yet it was undeniable that he possessed the gift, indeed the genius, of a great leader. That his energy was sometimes squandered on useless raids was but natural, considering the character of his forces, but in regard to his performances in the more exhausting and far more vital service of security and reconnaissance, General Johnston could ask "How can I sleep unless he is on the outpost?" and General Lee could say "He never brought me a false report." Stuart preserved under all circumstances the gaiety of a cavalry subaltern and the personal character of an earnest Christian, and the army regarded his loss as almost as heavy a blow to the Confederate cause as that of Jackson.

See *Life* by H. B. McClellan (1885).

STUART, SIR JOHN, COUNT OF MAIDA (1759-1815), British lieutenant-general, was born in Georgia. His father, Colonel John Stuart, was superintendent of Indian affairs in the southern district, and a prominent royalist in the War of Independence. Educated at Westminster School, young Stuart entered the 3rd Foot Guards in 1778, and almost immediately went to America with his regiment. He was present at the siege of

Charleston, the battles of Camden and Guildford court-house, and the surrender of Yorktown, returning a regimental lieutenant and an army captain, as was then usual in the Guards. Ten years later, as captain and lieutenant-colonel, he was present with the duke of York's army in the Netherlands and in northern France. He took part in the sieges and battles of the 1793 campaign, Valenciennes, Lincelles, Dunkirk and Lannoy. In the following year, now at the head of his battalion, he was present at Landrecies and at Pont-à-Chin or Tournay, and when the tide turned against the allies, he shared with his guards in the discomforts of the retreat. As a brigadier-general he served in Portugal in 1796, and in Minorca in 1799. At Alexandria, in 1801, his handling of his brigade called forth special commendation in general orders, and a year later he became substantive major-general. After two years in command of a brigade in Kent, Stuart went with Sir James Craig to the Mediterranean. The English were employed along with Lacy's Russians in the defence of the kingdom of Naples, but Austerlitz led to the recall of the Russian contingent, and the British soon afterwards evacuated Italy. Thus exposed, Naples fell to the advancing troops of Masséna, but Gaëta still held out for King Ferdinand, and Masséna's main force soon became locked up in the siege of this fortress. Stuart, who was in temporary command, realized the weakness of the French position in Calabria, and on the 1st of July 1806 swiftly disembarked all his available forces in the gulf of S. Euphemia. On the 4th the British, 4800 strong, won the celebrated victory of Maida over Reynier's detachment. Nothing, however, was done to follow up this success, as Stuart was too weak to shake Masséna's foothold in Naples. After besieging and taking the castle of Scylla, the little force returned to Messina. Besides the dignity of count of Maida from the court of Palermo, Stuart received the thanks of parliament and an annuity of £1000, as well as the K.C.B. Superseded by two other generals, Fox and Moore, the latter of whom was his junior, Stuart came home in 1806. A year later, however, as a lieutenant-general, he received the Mediterranean command, which he held until 1810. His operations were confined to south Italy, where Murat, king of Naples, held the mainland, and the British and Neapolitan troops held Sicily for the Bourbon king. Of the events of this time may be mentioned the failure to relieve Colonel Hudson Lowe at Capri, the expedition against Murat's gunboats in the bay of Naples and the second siege of Scylla. The various attempts made by Murat to cross the straits uniformly failed, though on one occasion the French actually obtained a footing in the island. In 1810 Stuart returned to England. He died at Clifton in 1815. Two months previously he had received the G.C.B.

STUART, JOHN M'DOUALL (1818-1866), South Australian explorer, was born at Dysart in Fifeshire, Scotland, in 1818, and arrived in the colony about 1839. He accompanied Captain Sturt's 1844-1845 expedition as draughtsman, and between 1858 and 1862 he made six expeditions into the interior, the last of which brought him on the 25th of July to the shores of the Indian Ocean at Van Diemen's Gulf, at the mouth of the Adelaide River. Stuart was not the first to cross the island continent from south to north; that honour belongs to the Burke and Wills expedition, which reached the Gulf of Carpentaria on the 6th of February 1861. Stuart returned to Adelaide exhausted and broken, and never recovered from the effects of the great privations which he suffered. He returned to England, where he died on the 5th of June 1866. Stuart was rewarded with £3000 and a grant of 1000 sq. m. of grazing country in the interior rent free for seven years. His name is perpetuated by Central Mount Stuart.

STUART, MOSES (1780-1852), American biblical scholar, was born in Wilton, Connecticut, on the 26th of March 1780. He was reared on a farm; graduated with highest honours at Yale in 1799; in 1802 was admitted to the Connecticut bar, and was appointed a tutor at Yale, where he remained for two years; and in 1806 became pastor of the Centre (Congregational) Church of New Haven. In 1810 he was appointed

professor of sacred literature in the Andover Theological Seminary, organized in 1808. Here he succeeded Eliphalet Pearson (1752-1826), the first preceptor of the Phillips (Andover) Academy and in 1786-1806 professor of Hebrew and Oriental languages at Harvard. Stuart himself then knew hardly more than the elements of Hebrew and not very much more Greek than Hebrew; in 1810-1812 he prepared for the use of his students a Hebrew grammar which they copied day by day from his manuscript; in 1813 he printed his *Grammar*, which appeared in an enlarged form, "with a copious syntax and praxis," in 1821, and was republished in England by Dr Pusey in 1831. He gradually made the acquaintance of German works in hermeneutics, first Schleusner, Seiler and Gesenius, and taught himself German, arousing much suspicion and distrust among his colleagues by his unusual studies. But his recognition soon came, partly as a result of his *Letter to Dr Channing on the Subject of Religious Liberty* (1830), but more largely through the growing favour shown to German philology and critical methods. In 1848 he resigned his chair at Andover. He died in Andover on the 4th of January 1852. He has been called the "father of exegetical studies in America." He contributed largely by his teaching to the renewal of foreign missionary zeal—of his 1500 students more than 100 became foreign missionaries, among them such skilled translators as Adoniram Judson, Elias Riggs and William G. Schauffler.

Among his more important publications were: *Winer's Greek Grammar of the New Testament* (1825), with Edward Robinson; *Commentary on the Epistle to the Hebrews* (1827-1828); *Commentary on the Epistle to the Romans* (1832); *Commentary on the Apocalypse* (1845); *Miscellanies* (1846); Gesenius's *Hebrew Grammar* (1846), a version which involved Stuart in a long controversy with T. J. Conant, the earlier, and possibly more scholarly, translator of Gesenius; *Commentary on Ecclesiastes* (1851), and *Commentary on the Book of Proverbs* (1852).

See the memorial sermons by Edwards A. Park (Boston, 1852) and William Adams (New York, 1852).

STUBBS [STUBBE], JOHN (c. 1543-1591), English pamphleteer, was born in Norfolk about 1543. He was educated at Trinity College, Cambridge, and after studying law at Lincoln's Inn, took up his residence at Thelveton, Norfolk. His views were Puritan, and he regarded with disgust the negotiations for a marriage between Queen Elizabeth and the duke of Anjou. In 1579 he put his opinions into a pamphlet entitled *The Discoverie of a Gaping Gulf wherein England is like to be Swallowed by another French Marriage*. The circulation of this pamphlet was prohibited, and Stubbs, his printer, and publisher were tried at Westminster, found guilty, and sentenced to have their right hands cut off. The printer was subsequently pardoned, but in the case of Stubbs and his publisher the sentence was duly carried out. Stubbs protested his loyalty from the first. His right hand having been cut off, he removed his hat with his left, and cried "God Save the Queen!" before fainting away. He was subsequently imprisoned for eighteen months. On being released he continued to write, publishing, among other pamphlets, a reply to Cardinal Allen's *Defence of the English Catholics*. He died in 1591 at Havre, France, where he seems to have gone to volunteer for military service under Henry of Navarre.

STUBBS [STUBBES], PHILIP (c. 1555-c. 1610), English pamphleteer, was born about 1555. He is reputed to have been a brother or near relation of John Stubbs (*q.v.*). He was educated at Cambridge and subsequently at Oxford, but did not take a degree, spending the greater portion of his time travelling about the country. He started writing about 1581, and in 1583 published *The Anatomie of Abuses*. This consisted of a virulent attack on the manners, customs, amusements and fashions of the period, and is still valuable for its copious information on those matters. In 1591 Stubbs published *A Christal Glass for Christian Women*, of which at least seven editions were called for, and he followed this with other semi-devotional works. He died, probably, about 1610.

STUBBS, WILLIAM (1825-1901), English historian and bishop of Oxford, son of William Morley Stubbs, solicitor, of Knaresborough, Yorkshire, was born on the 21st of June 1825, and was educated at the Ripon grammar school and Christ Church,

Oxford, where he graduated in 1848, obtaining a first-class in classics and a third in mathematics. He was elected a fellow of Trinity College, and held the college living of Navestock, Essex, from 1850 to 1866. He was librarian at Lambeth, and in 1862 was an unsuccessful candidate for the Chichele professorship of modern history at Oxford. In 1866 he was appointed regius professor of modern history at Oxford, and held the chair until 1884. His lectures were thinly attended, and he found them grievous interruptions to his historical work. Some of his statutory lectures are published in his *Lectures on Mediaeval and Modern History*. He was rector of Cholderton, Wiltshire, from 1875 to 1879, when he was appointed a canon of St Paul's. He served on the ecclesiastical courts commission of 1881-1883, and wrote the weighty appendices to the report. On the 25th of April 1884 he was consecrated bishop of Chester, and in 1889 was translated to the see of Oxford.

Until Bishop Stubbs found it necessary to devote all his time to his episcopal duties, he pursued historical study with unremitting diligence. He rejected the theory of the unity and continuity of history so far as it would obliterate distinctions between ancient and modern history, holding that, though work on ancient history is a useful preparation for the study of modern history, either may advantageously be studied apart. He urged that history is not to be treated as an exact science, and that the effects of individual character and the operations of the human will necessarily render generalizations vague and consequently useless. While pointing out that history has a utility as a mental discipline and a part of a liberal education, he recommended its study chiefly for its own sake, for the truth's sake and for the pleasure which it brings. It was in this spirit that he worked; and his intellectual character was peculiarly fitted for his work, for he was largely endowed with the faculty of judgment and with a genius for minute and critical investigation. He was eminent alike in ecclesiastical history, as an editor of texts and as the historian of the English constitution. His right to be held as an authority on ecclesiastical history was proved in 1858 by his *Registrum sacrum anglicanum*, which sets forth episcopal succession in England, by many other later works, and particularly by his share in *Councils and Ecclesiastical Documents*, edited in co-operation with the Rev. A. W. Haddan, for the third volume of which he was specially responsible. His place as a master in critical scholarship and historical exposition is decided beyond debate by the nineteen volumes which he edited for the Rolls series of *Chronicles and Memorials*. It is, however, by his *Constitutional History of England* that he is most widely known as a historian. The appearance of this book, which traces the development of the English constitution from the Teutonic invasions of Britain till 1485, marks a distinct step in the advance of English historical learning. Specialists may here and there improve on a statement or a theory, but it will always remain a great authority, a monument of patient and exhaustive research of intellectual power, and of ripe and disciplined judgment. Its companion volume of *Select Charters and other Illustrations of English Constitutional History*, admirable in itself, has a special importance in that its plan has been imitated with good results both in England and the United States.

Bishop Stubbs belongs to the front rank of historical scholars both as an author and a critic. Among Englishmen at least he excels all others as a master of every department of the historian's work, from the discovery of materials to the elaboration of well-founded theories and literary production. He was a good palaeographer, and excelled in textual criticism, in examination of authorship, and other such matters, while his vast erudition and retentive memory made him second to none in interpretation and exposition. His carefulness was exemplary, and his references are always exact. His merits as an author are often judged solely by his *Constitutional History*. The learning and insight which this book displays are unquestionable: it is well planned, and its contents are well arranged; but constitutional history is not a lively subject, and, in spite of the skill with which Stubbs handled it and the genius displayed in his narrative

chapters, the book does not afford an adequate idea of his place as a writer of history. What that is cannot be determined without taking into account the prefaces to some of the volumes which he edited for the Rolls series. Several of them contain monographs on parts, or the whole, of the author's work, written with remarkable literary skill. In these his language is vigorous and dignified; he states the results of his labour and thought with freshness and lucidity; tells numberless stories in a most delightful manner, and exhibits a wonderful talent for the representation of personal character; the many portraits of historic persons of all orders which he draws in these prefaces are as brilliant in execution as they are exact and convincing. Among the most notable examples of his work for the Rolls series are the prefaces to Roger of Hoveden, the *Gesta regum* of William of Malmesbury, the *Gesta Henrici II.*, and the *Memorials of St. Dunstan*. Both in England and America Bishop Stubbs was universally acknowledged as the head of all English historical scholars, and no English historian of his time was held in equal honour in European countries. Among his many distinctions he was D.D. and hon. D.C.L. of Oxford, LL.D. of Cambridge and Edinburgh, Doctor *in utroque jure* of Heidelberg; an hon. member of the university of Kiev, and of the Prussian, Bavarian and Danish academies; he received the Prussian order *Pour le mérite*, and was corresponding member of the Académie des sciences morales et politiques of the French Institute.

Stubbs was a High Churchman whose doctrines and practice were grounded on learning and a veneration for antiquity. His opinions were received with marked respect by his brother prelates, and he acted as an assessor to the archbishop in the trial of the bishop of Lincoln. His tastes were those of a student, and he did not disguise his dislike of public functions and the constant little journeys which take up so much of a bishop's time. Nevertheless he fulfilled all his episcopal duties with diligence, and threw all his heart into the performance of those of a specially spiritual nature, such as his addresses at confirmations and to those on whom he conferred orders. As a ruler of the Church he showed wisdom and courage, and disregarded any effort to influence his policy by clamour. In character he was modest, kind and sympathetic, ever ready to help and encourage serious students, generous in his judgment of the works of others, a most cheery companion, full of wit and humour. His wit was often used as a weapon of defence, for he did not suffer fools gladly. An attack of illness in November 1900 seriously impaired his health. He was able, however, to attend the funeral of Queen Victoria on the 2nd of February 1901, and preached a remarkable sermon before the king and the German emperor on the following day. His illness became critical on the 20th of April, and he died on the 22nd. In 1859 he had married Catherine, daughter of John Dollar, of Navestock, and had a numerous family.

See *Letters of William Stubbs, Bishop of Oxford*, ed. W. H. Hutton. (W. Hu.)

STUCCO (Ital. *stucco*, adapted from O.H.G. *stucchi*, crust, piece, patch, Ger. *Stück*, piece, allied to stock), a kind of plaster used for the covering of walls, or for decorative or ornamental features such as cornices, mouldings, &c., or for ceilings. The stucco used as an exterior covering for brick or stone work is coarse; a finer kind is used for decorative purposes. (See PLASTER-WORK.)

STUCK, FRANZ (1863-), German painter, was born at Tettenweis, in Bavaria, and received his artistic training at the Munich Academy. He first made a name with his illustrations for *Fliegende Blätter*, and vignette designs for programmes and book decoration. He did not devote himself to painting till after 1889, the year in which he achieved a marked success with his first picture, "The Warder of Paradise." His style in painting is based on a thorough mastery of design, and is sculptural rather than pictorial. His favourite subjects are of mythological and allegorical character, but in his treatment of time-worn motifs he is altogether unconventional. A statuette of an athlete, bronze casts of which are at the Berlin and Budapest

national galleries and the Hamburg Museum, affords convincing proof of his talent for plastic art. Among his paintings the best known are "Sin" and "War," at the Munich Pinakothek, "The Sphinx," "The Crucifixion," "The Rivals," "Paradise Lost," "Oedipus," "Temptation," and "Lucifer." Though Stuck was one of the leaders of the Munich *Sezession*, he enjoyed an appointment of professor at the academy.

STUCLEY (OR STUKELY), **THOMAS** (c. 1525-1578), English adventurer, son of Sir Hugh Stucley, of Affleton, near Ilfracombe, a knight of the body to King Henry VIII., was supposed by some of his contemporaries to have been an illegitimate son of the king. He was a standard-bearer at Boulogne from 1547 to 1550, entered the service of the duke of Somerset, and after his master's arrest in 1551 a warrant was issued against him, but he succeeded in escaping to France, where he served in the French army. His military talents brought him under the notice of Montmorency, and he was sent with a letter of recommendation from Henry II. of France to Edward VI. On his arrival he proceeded on the 16th of September 1552 to reveal the French plans for the capture of Calais and for a descent upon England, the furtherance of which had, according to his account, been the object of his mission to England. Northumberland evaded the payment of any reward to Stucley, and sought to gain the friendship of the French king by pretending to disbelieve Stucley's statements. Stucley, who may well have been the originator of the plans adopted by the French, was imprisoned in the Tower for some months. A prosecution for debt on his release in August 1553 compelled him to become a soldier of fortune once more, but he returned to England in December 1554 in the train of Philibert, duke of Savoy, after obtaining security against his creditors. He temporarily improved his fortunes by marrying an heiress, Anne Curtis, but in a few months had to return to the duke of Savoy's service. As early as 1558 he was summoned before the council on a charge of piracy, but was acquitted on the ground of insufficient evidence. In 1562 he obtained a warrant permitting him to bring French ships into English ports although England and France were nominally at peace. With six ships, one of which was supplied by Queen Elizabeth, he started buccaneering against French, Spanish and Portuguese ships, though his commission was concerned with an expedition to Florida. Repeated remonstrances on the part of the offended powers compelled Elizabeth to disavow Stucley, who surrendered in 1565, but his prosecution was merely formal.

He had met Shane O'Neill at the English court in the winter of 1561-1562, and was employed in 1566 by Sir Henry Sidney in a vain effort to induce the Irish chief to enter into negotiations with the government. Sidney desired to allow Stucley to purchase the estates and office of Sir Nicholas Bagnall, marshal of Ireland, for £3000, but Elizabeth refused to permit the transaction. Undeterred by this failure, Stucley bought lands and the office of seneschal of Wexford from Sir Nicholas Heron, but in June 1568 he was dismissed, and in the next year imprisoned in Dublin Castle on a charge of high treason, but was released in October. He now offered his services to Fenelon, the French ambassador in London, and was thenceforward continuously engaged in schemes against Elizabeth. Philip II. invited him to Madrid and loaded him with honours. He was known at the Spanish court by the curious title of "duke of Ireland," and was established with a handsome allowance in a villa near Madrid. He was knighted in 1571, and prepared to become a member of a religious order of knighthood. His credit with Spain was seriously injured by another Irish malcontent, Maurice Gibbon, archbishop of Cassel; but Stucley, who now desired to leave Spain, only obtained his passports after Elizabeth had demanded his dismissal. He commanded three galleys under Don John of Austria at the battle of Lepanto. His exploits restored him to favour at Madrid, and on the 2nd of March 1572 he was at Seville, offering to hold the narrow seas against the English with a fleet of twenty ships. In four years (1570-1574) he is said to have received over 27,000 ducats from Philip II. Wearing by the Spanish king's delays he sought more serious assistance from the new pope, Gregory XIII., who

aspired to make his illegitimate son, Giacomo Buoncompagno, king of Ireland. He set sail from Civita Vecchia in March 1578, but put into Lisbon, where he was to meet his confederate, James Fitzmaurice Fitzgerald, and to secure better ships before sailing for Ireland. There he was turned from his purpose by King Sebastian, with whom he sailed for Morocco. He commanded the centre in the battle of Alcazar on the 4th of August 1578, and was killed, in fair fight apparently, though tradition asserted that he was murdered by his Italian soldiers after the battle.

Stucley's adventurous career made considerable impression on his contemporaries. A play generally assigned to George Peele, *The Battell of Alcazar . . . with the Death of Captain Stukely*, printed by E. Alde in 1594, was probably acted in 1592, and is perhaps identical with a popular piece referred to by Henslowe as *Muley surnamed Abdelmlech*. It deals with Stucley's arrival in Lisbon and his Moorish expedition, but in a long speech before his death he recapitulates the events of his life. A later piece, *The Famous History of the Life and Death of Captain Thomas Stukeley*, printed for Thomas Panyer (1605), which is possibly the *Stewley* played, according to Henslowe, on the 11th of December 1596, is a biographical piece dealing with successive episodes, and seems to be a patchwork of older plays on Don Antonio and on Stucley. His adventures also form the subject of various ballads.

There is a detailed biography of Stucley, based chiefly on the English, Venetian and Spanish state papers, in R. Simpson's edition of the 1605 play (*School of Shakespeare*, 1878, vol. i.), where the Stucley ballads are also printed. References in contemporary poetry are quoted by Dyce in his introduction to the *Battle of Alcazar* in Peele's *Works*.

STUD. (1) A number of horses kept for the purpose of breeding, also the place or establishment where they are kept; similarly, a "stud horse," a stallion, "stud groom," the head groom of a stud, "stud-book," the register containing the pedigree of thoroughbred horses. The word in Old English is *stod*, and cognate forms are found in Icelandic and Danish, cf. also German *Gestüt*; steed, now a literary word for horse, meant in Old English (*steda*) a stud-horse, and is the same as stud in origin. The root to which the word is referred is *sta-*, to stand. A stud meant, therefore, an establishment. (2) A word which is used of many different objects, the primary meaning being a "prop" or support. The Old English word is *studu*, and cognates are found in Danish, Swedish and Icelandic. The ultimate origin is also the root *sta-*, to stand. The chief applications of the term are as follows: in architecture, to a post; quarter or upright in wooden partitions; to the transverse pieces of iron which strengthen the links of a chain; to a boss or knob inserted on a belt, collar, or piece of armour, often decorated and forming an ornamentation; and, particularly, to a species of button, consisting of a rounded head, neck and flat base, used for fastening a collar, shirt, &c.

STUDER, BERNHARD (1794-1887), Swiss geologist, was born at Buren, near Berne, in August 1794. Although educated as a clergyman, he became so interested in geology at the university of Göttingen that he devoted his life to its pursuit. He subsequently studied at Freiburg, Berlin and Paris, and in 1816 was appointed teacher of mathematics and physics in the Berne Academy. In 1825 he published *Beyträge zu einer Monographie der Molasse*. Later on he commenced his detailed investigations of the western Alps, and published in 1834 his *Geologie der westlichen Schweizer-Alpen*. In the same year, largely through his influence, the university of Berne was established and he became the first professor of mineralogy. His *Geologie der Schweiz* in two vols. (1851-1853), and his geological maps of Switzerland prepared with the assistance of Arnold Escher von der Linth, are monuments of his research. In 1859 he organized the geological survey of Switzerland, being appointed president of the commission, and retaining this position until the close of his life. It has been remarked by Marcou that Studer was present at the first meeting of the Société helvétique des sciences naturelles at Geneva on the 6th of October 1815, and remained a member during 72 years. He was awarded the Wollaston medal by the Geological Society of London, 1879. He died at Berne on the 2nd of May 1887.

Obituary by Jules Marcou, *Ann. rep. amer. acad. sci.* for 1888.

STUKELEY, WILLIAM (1687-1765), English antiquary, was born at Holbeach, Lincolnshire, on the 7th of November 1687, the son of a lawyer. After taking his M.B. degree at Cambridge, he went to London and studied medicine at St Thomas's Hospital. In 1710 he started in practice in Lincolnshire, removing in 1717 to London. In the same year he became a fellow of the Royal Society, and, in 1718, joined in the establishment of the Society of Antiquaries, acting for nine years as its secretary. In 1719 he took his M.D. degree and in 1720 became a fellow of the Royal College of Physicians, publishing in the same year his first contribution to antiquarian literature. His principal work, an elaborate account of Stonehenge, appeared in 1740, and he wrote copiously on other supposed Druid remains, becoming familiarly known as the "Arch-Druid." In 1729 he took holy orders, and, after holding two livings in Lincolnshire, was appointed rector of a parish in Bloomsbury, London. He died in London on the 3rd of March 1765.

STUMPF, JOHANN (1500-1576), one of the chief writers on Swiss history and topography, was born at Bruchsal (near Karlsruhe). He was educated there and at Strassburg and Heidelberg. In 1520 he was received as a cleric or chaplain into the order of the Knights Hospitallers or of St John of Jerusalem, was sent in 1521 to the preceptory of that order at Freiburg in Breisgau, ordained priest in Basel, and in 1522 placed in charge of the preceptory at Bubikon (north of Rapperswil, in the canton of Zürich). But Stumpf soon went over to the Protestants, was present at the great Disputation in Berne (1528), and took part in the first Kappel War (1529). He had carried over with him most of his parishioners whom he continued to care for, as the Protestant pastor at Bubikon, till 1543, then becoming pastor at Stammheim (same canton) till 1561, when he retired to Zürich (of which he had been made a burgher in 1548), where he lived in retirement till his death in 1576. In 1529 he married the first of his four wives, a daughter of Heinrich Brennwald (1478-1551), who wrote a work (still in MS.) on Swiss history, and stimulated his son-in-law to undertake historical studies. Stumpf made wide researches, with this object, for many years, and undertook also several journeys, of which that in 1544 to Engelberg and through the Valais seems to be the most important, perhaps because his original diary has been preserved to us. The fruit of his labours (completed at the end of 1546) was published in 1548 at Zürich in a huge folio of 934 pages (with many fine wood engravings, coats of arms, maps, &c.), under the title of *Gemeiner loblicher Eydgrossenschaft Stetten, Landen, und Volckeren chronikwirdiger Thaaten Beschreibung* (an extract from it was published in 1554, under the name of *Schwytzer Chronika*, while new and greatly enlarged editions of the original work were issued in 1586 and 1606). The woodcuts are best in the first edition, and it remained till Scheuchzer's day (early 18th century) the chief authority on its subject. Stumpf also published a monograph (very remarkable for the date) on the emperor Henry IV. (1556) and a set of laudatory verses (*Lobsprüche*) as to each of the thirteen Swiss cantons (1573). (W. A. B. C.)

STURDZA, or **STURZA**, the name of an ancient Rumanian family, of unknown origin, which probably came from Trebizond and settled in Moldavia. The Sturdza family has been long and intimately associated with the government first of Moldavia and afterwards of Rumania. Its members belong to two main divisions, which trace their descent respectively from John (Ioan) or from Alexander (Sandu), the sons of Kirak Sturdza, who lived in the 17th century, and may be regarded as the founder of the family.

1. To the first division belongs **MICHAEL** [Michail] **STURDZA** (1795-1884), who was prince of Moldavia from 1834 to 1849. A man of liberal education, he established the first high school, a kind of university, in Jassy. He brought scholars from foreign countries to act as teachers, and gave a very powerful stimulus to the educational development of the country. In 1844 he decreed the emancipation of the gipsies. Until then the gipsies had been treated as slaves and owned by the Church or by private landowners; they had been bought and sold in

the open market. Michael Sturdza also attempted the secularization of monastic establishments, which was carried out by Prince Cuza in 1864, and the utilization of their endowments for national purposes. He quelled the attempted revolution in 1848 without bloodshed by arresting all the conspirators and expelling them from the country. Under his rule the internal development of Moldavia made immense progress; roads were built, industry developed, and Michael is still gratefully remembered by the people.

See *Michel Stourdza et son administration* (Brussels, 1834); *Michel Stourdza, ancien prince regnant de Moldavie* (Paris, 1874); A. A. C. Sturdza, *Règne de Michel Sturdza, prince de Moldavie 1834-1849* (Paris, 1907).

2. **GREGORY** [Grigoric] **STURDZA** (1821-1901), son of the above, was educated in France and Germany, became a general in the Ottoman army under the name of Muklis Pasha, and afterwards attained the same rank in the Moldavian army. He was a candidate for the Moldavian throne in 1859, and subsequently a prominent member of the Russophil party in the Rumanian parliament. He wrote *Lois fondamentales de l'univers* (Paris 1891).

3. **JOHN** [Ioan] **STURDZA**, prince of Moldavia (1822-1828), was the most famous descendant of Alexander Sturdza. Immediately after the Greek revolution, Prince John Sturdza took an active part in subduing the roving bands of Greek Hetairists in Moldavia; he transformed the Greek elementary schools into Rumanian schools and laid the foundation for that scientific national development which Prince Michael Sturdza continued after 1834. In 1828 the Russians entered the country and took Prince John prisoner. He died in exile.

4. **ALEXANDER** [Alexandru] **STURDZA** (1791-1854), Russian publicist and diplomatist, was a member of the same family, born in Bessarabia and educated in Germany. After entering the Russian diplomatic service, he wrote *Betrachtungen über die Lehre und den Geist der orthodoxen Kirche* (Leipzig, 1817). His *Mémoire sur l'état actuel de l'Allemagne*, written at the request of the tsar during the congress of Aix-la-Chapelle, was an attack on the German universities, repeated in *Coup d'œil sur les universités de l'Allemagne* (Aix, 1818). His other important works are *La Grèce en 1821* (Leipzig, 1822) and *Œuvres posthumes religieuses, historiques, philosophiques et littéraires* (5 vols., Paris, 1858-1861).

5. **DEMETRIUS** [Dimitrie] **STURDZA**, Rumanian statesman, was born in 1833 at Jassy, and educated there at the Academia Michailiana. He continued his studies in Germany, took part in the political movements of the time, and was private secretary to Prince Cuza. Demetrius afterwards turned against Cuza, joined John Bratianu, and became a member of the so-called Liberal government. In 1899 he was elected leader of the party in succession to Bratianu and was four times prime minister (see *RUMANIA: History*). Though a man of great capacity for work, he represented the narrowest nationalism, and through his enmity to all that was "alien" did more than any other man to retard the political and industrial development of the country. He was appointed permanent secretary of the Rumanian Academy, and became a recognized authority on Rumanian numismatics. As secretary of the academy he was instrumental in assisting the publication of the collections of historic documents made by Hurmuzaki (30 vols., Bucharest, 1876-1897), and other acts and documents (Bucharest, 1900 sqq.), besides a number of minor political pamphlets of transitory value. (M. G.)

STURE, an ancient patrician family of Sweden, the most notable members of which were the following:—

1. **STEN GUSTAFSSON**, commonly called Sten Sture the Elder (1440-1503). In 1464 he came prominently forward in support of Bishop Kettil Karlsson Vasa in his struggle against Christian I. of Denmark, and showed great ability in winning over the peasants and making soldiers of them. In 1470 we find him in the forefront of the Swedish national leaders and victorious over both Erik Karlsson Vasa and King Christian himself. After the death of Karl Knutsson, commonly called Charles VIII., Sture was elected regent of Sweden, and from 1470 to 1497 displayed some

of the highest qualities of a statesman. In 1471 he again defeated Christian I. at the great battle of Brunkebjärg which materially strengthened his position in Sweden. In 1483 he was obliged to acknowledge Hans of Denmark and Norway as king; but the strife of factions enabled him to hold his own till the arrival of Hans in Sweden in 1497. His position had in the meantime been weakened by a ruinous war with Russia. He succeeded, however, in annexing Öland to Sweden. After the terrible defeat of Hans by the Dithmarschers in 1500 Sture was a second time elected regent, holding that office till his death.

2. SVANTE STURE (d. 1512) is mentioned as a senator in 1482. He was one of the magnates who facilitated King Hans's conquest of Sweden by his opposition to Sten Sture the Elder. Subsequently, however, he was reconciled to the latter and succeeded him as regent. He was by no means so imposing a figure as his predecessor, though, like him, Svante in his later years patriotically resisted the Danish claim of sovereignty. He died suddenly at Vesterås Castle.

3. STEN STURE, commonly called Sten Sture the Younger (1492-1520), the son of Svante. After his father's death he was elected regent by the majority of the lesser gentry to the exclusion of the candidate of the high aristocratic faction, Erik Trolle, whence the inextinguishable hatred of the two families. In 1513 the aged archbishop of Upsala, Jakob Ulfsson, resigned in favour of Gustaf Trolle, son of Erik Trolle, who was elected by the cathedral chapter and recommended to the pope by the regent on condition that the new archbishop should do him homage. Unfortunately these two masterful young men (Trolle was twenty-seven, Sture barely twenty-three), who represented respectively the highest ecclesiastical and the highest civil authority in Sweden, were only too prone to carry on the family feud. On the return of Trolle from Rome he refused to do homage to the regent till all his enemies had been punished, and allied himself with Christian II. of Denmark, who hastened to the archbishop's assistance when Sture besieged Trolle in his stronghold at Stäke (1516). Nevertheless Sture not only defeated Christian II. at Vedla, but took and razed Stäke to the ground, and shut up the archbishop in a monastery at Vesterås. A *riksmöte*, or national assembly, held at Stockholm in 1517, declared unanimously that Sweden would never recognize Trolle as archbishop because he had defied the regent and brought the enemy into the land. The war with Denmark was then vigorously resumed. On Midsummer Day 1518 Christian II. appeared before Stockholm with his fleet and landed an army, but was again defeated by Sten Sture at Bränkyrka. An attempt of the papal legate Arcimboldus to mediate between the two countries at Arboga (Dec. 1518) failed. In 1520 Christian, with a regular army, and armed with a papal bull excommunicating Sture, again invaded Sweden. The armies clashed near Börgerund on Lake Aarunden (Jan. 19). At the very beginning Sture was hit by a bullet and his peasant levies fled to the wild mountainous regions of Tiveden where they made a last desperate but unsuccessful stand. The mortally-wounded regent took to his sledge and posted towards Stockholm, but expired on the ice of Lake Mälaren two days later, in his 27th year.

See *Sveriges historia*, vol. i. (Stockholm, 1877-1878); K. O. Arnoldson, *Nordens Enhet och Kristian II.* (Stockholm, 1899). (R. N. B.)

STURGE, JOSEPH (1793-1859), English philanthropist and politician, was the son of a farmer in Gloucestershire. He was a member of the Society of Friends, and refused, in his business as a corn factor, to deal in grain used in the manufacture of spirits. He went to Birmingham in 1822, where he became an alderman in 1835. He was an active member of the Anti-Slavery Society, and made a tour in the West Indies, publishing on his return an account of slavery as he there saw it in *The West Indies in 1837* (London, 1837). After the abolition of slavery, to which, as Lord Brougham acknowledged in the House of Lords, he had largely contributed, Sturge started and generously supported schemes for benefiting the liberated negroes. In 1841 he travelled in the United States with the poet Whittier to examine the slavery question there. On his return to England he gave his support to the Chartist movement, and in 1842 was

candidate for Nottingham, but was defeated by John Walter, the proprietor of *The Times*. He then took up the cause of peace and arbitration, to support which he was influential in the founding of the *Morning Star* in 1855. The extreme narrowness of Sturge's views was shown in his opposition to the building of the Birmingham town-hall on account of his conscientious objection to the performance of sacred oratorio. He died at Birmingham on the 14th of May 1859. He married, first, in 1834, Eliza, daughter of James Cropper; and, secondly, in 1846, Hannah, daughter of Barnard Dickinson.

See Henry Richard, *Memoirs of Joseph Sturge* (London, 1864); John (Viscount) Morley, *Life of Richard Cobden* (London, 1881).

STURGEON (*Acipenser*), the name given to a small group of fishes, of which some twenty different species are known, from European, Asiatic and North American rivers. The distinguishing characters of this group, as well as its position in the system, are dealt with in the article TELEOSTOMES. They pass a great part of the year in the sea, but periodically ascend large rivers, some in spring to deposit their spawn, others later in the season for some purpose unknown; only a few of the species are exclusively confined to fresh water. None occur in the tropics or in the southern hemisphere.

Sturgeons are found in the greatest abundance in the rivers of southern Russia, more than ten thousand fish being sometimes caught at a single fishing-station in the fortnight during which the up-stream migration lasts. They occur in less abundance in the fresh waters of North America, where the majority are caught in shallow portions of the shores of the great lakes. In Russia the fisheries are of immense value. Early in summer the fish migrate into the rivers or towards the shores of freshwater lakes in large shoals for breeding purposes. The ova are very small, and so numerous that one female has been calculated to produce about three millions in one season. The ova of some species have been observed to hatch within a very few days after exclusion. Probably the growth of the young is very rapid, but we do not know how long the fry remain in fresh water before their first migration to the sea. After they have attained maturity their growth appears to be much slower, although continuing for many years. Frederick the Great placed a number of them in the Görland Lake in Pomerania about 1780; some of these were found to be still alive in 1866. Professor von Baer also states, as the result of direct observations made in Russia, that the Hausen (*Acipenser huso*) attains to an age of from 200 to 300 years. Sturgeons ranging from 8 to 11 ft. in length are by no means scarce, and some species grow to a much larger size.

Sturgeons are ground-feeders. With their projecting wedge-shaped snout they stir up the soft bottom, and by means of their sensitive barbels detect shells, crustaceans and small fishes, on which they feed. Being destitute of teeth, they are unable to seize larger prey.

In countries like England, where few sturgeons are caught, the fish is consumed fresh, the flesh being firmer than that of ordinary fishes, well flavoured, though somewhat oily. The sturgeon is included as a royal fish in an act of King Edward II., although it probably but rarely graces the royal table of the present period, or even that of the lord mayor of London, who can claim all sturgeons caught in the Thames above London Bridge. Where sturgeons are caught in large quantities, as on the rivers of southern Russia and on the great lakes of North America, their flesh is dried, smoked or salted. The ovaries, which are of large size, are prepared for caviare; for this purpose they are beaten with switches, and then pressed through sieves, leaving the membranous and fibrous tissues in the sieve, whilst the eggs are collected in a tub. The quantity of salt added to them before they are finally packed varies with the season, scarcely any being used at the beginning of winter. Finally, one of the best sorts of isinglass is manufactured from the air-bladder. After it has been carefully removed from the body, it is washed in hot water, and cut open in its whole length, to separate the inner membrane, which has a soft consistency, and contains 70% of glutin.

The twenty species of sturgeons (*Acipenser*) are nearly equally divided between the Old and New Worlds. The more important are the following:—

1. The common sturgeon of Europe (*Acipenser sturio*) occurs on all the coasts of Europe, but is absent in the Black Sea. Almost all the British specimens of sturgeon belong to this species; it crosses the Atlantic and is not rare on the coasts of North America. It reaches a large size (a length of 12 ft.), but is always caught singly or in pairs, so that it cannot be regarded as a fish of commercial importance. The form of its snout varies with age (as in the other species), being much more blunt and abbreviated in old than in young examples. There are 11–13 bony shields along the back and 29–31 along the side of the body.

2. *Acipenser guldenstädtii* is one of the most valuable species of the rivers of Russia, where it is known under the name "Ossétr"; it is said to inhabit the Siberian rivers also, and to range eastwards as far as Lake Baikal. It attains to the same large size as the common sturgeon, and is so abundant in the rivers of the Black and Caspian seas that more than one-fourth of the caviare and isinglass manufactured in Russia is derived from this species.

3. *Acipenser stellatus*, the "Seuruga" of the Russians, occurs likewise in great abundance in the rivers of the Black Sea and of the Sea of Azoff. It has a remarkably long and pointed snout, like the sterlet, but simple barbels without fringes. Though growing only to about half the size of the preceding species, it is of no less value, its flesh being more highly esteemed, and its caviare and isinglass fetching a higher price. In 1850 it was reported that more than a million of this sturgeon are caught annually.

4. The sturgeon of the great lakes of North America, *Acipenser rubicundus*, with which, in the opinion of American ichthyologists, the sea-going sturgeon of the rivers of eastern North America, *Acipenser maculosus*, is identical, has of late years been made the object of a large and profitable industry at various places on Lakes Michigan and Erie; the flesh is smoked after being cut into strips and after a slight pickling in brine; the thin portions and offal are boiled down for oil; nearly all the caviare is shipped to Europe. One firm alone uses from ten to eighteen thousand sturgeons a year, averaging 50 lb each. The sturgeons of the lakes are unable to migrate to the sea, whilst those below the Falls of Niagara are great wanderers; and it is quite possible that a specimen of this species said to have been obtained from the Firth of Tay was really captured on the coast of Scotland.

5. *Acipenser huso*, the "Hausen" of Germany, is recognized by the absence of osseous scutes on the snout and by its flattened, tape-like barbels. It is one of the largest species, reaching the enormous length of 24 ft. and a weight of 2000 lb. It inhabits the Caspian and Black seas, and the Sea of Azoff, whence in former years large shoals of the fish entered the large rivers of Russia and the Danube. But its numbers have been much thinned, and specimens of 1200 lb in weight have now become scarce. Its flesh, caviare and air-bladder are of less value than those of the smaller kinds.

6. The sterlet (*Acipenser ruthenus*) is one of the smaller species, which likewise inhabits both the Black and Caspian seas, and ascends rivers to a greater distance from the sea than any of the other sturgeons; thus, for instance, it is not uncommon in the Danube at Vienna, but specimens have been caught as high up as Ratisbon and Ulm. It is more abundant in the rivers of Russia, where it is held in high esteem on account of its excellent flesh, contributing also to the best kinds of caviare and isinglass. As early as the 18th century attempts were made to introduce this

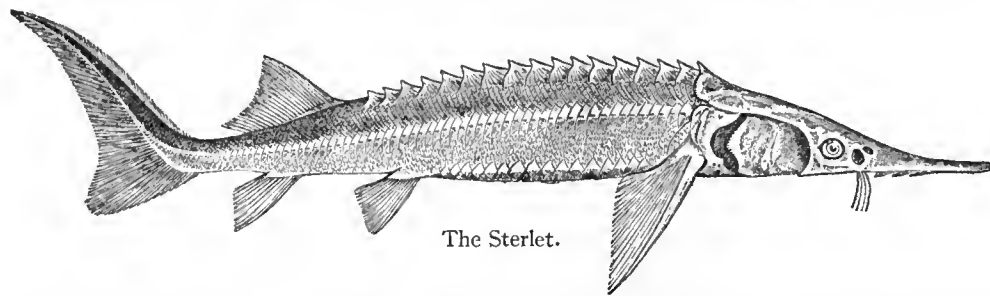

The Sterlet.

valuable fish into Prussia and Sweden, but without success. The sterlet is distinguished from the other European species by its long and narrow snout and fringed barbels. It rarely exceeds a length of 3 ft.

The family Acipenseridae includes one other genus, *Scaphirhynchus*, the shovel-head or shovel-nosed sturgeon, distinguished by the long, broad and flat snout, the suppression of the spiracles, and the union of the longitudinal rows of scales posteriorly. All the species are confined to fresh water. One of them is common in the Mississippi and other rivers of North America, the other three occur in the larger rivers of eastern Asia.

STURGIS, RUSSELL (1836–1909), American architect and art critic, was born in Baltimore county, Maryland, on the 16th of October 1836. He graduated from the Free Academy in New York (now the College of the City of New York) in 1856, and studied architecture under Leopold Eidlitz and then for two years in Munich. In 1862 he returned to the United States. He designed the Yale University chapel and the Farnham and Durfee dormitories at Yale, the Flower Hospital, the Farmers' and Mechanics' Bank of Albany, and many other buildings, but did comparatively little professional work after 1880. He was in Europe in 1880–1884; and for a short time after his return was secretary of the New York Municipal Civil Service Board. He was president of the Architectural League of New York in 1889–1893, was first president of the Fine Arts Federation in 1895–1897, and was a member of the National Society of Mural Painters, the National Sculpture Society, the National Academy of Design, and the New York chapter of the American Institute of Architects. He lectured on art at Columbia University, the Metropolitan Museum of Art in New York, the Peabody Institute of Baltimore and the Art Institute of Chicago; his lectures in Chicago being published under the title *The Interdependence of the Arts of Design* (1905). He is best known as a writer on art and architecture. He edited *A Dictionary of Architecture and Building* (3 vols., 1901–1902) and the English version of Wilhelm Luebbe's *Outlines of the History of Art* (2 vols., 1904), and he wrote *European Architecture* (1896), *How to Judge Architecture* (1903), *The Appreciation of Sculpture* (1904), *The Appreciation of Pictures* (1905), *A Study of the Artist's Way of Working in the Various Handicrafts and Arts of Design* (2 vols., 1905), and an unfinished *History of Architecture* (1906 sqq.). During his last years he was nearly blind. He died in New York on the 11th of February 1909.

STURM, JACQUES CHARLES FRANÇOIS (1803–1855), French mathematician, of German extraction, was born at Geneva on the 29th of September 1803. Originally tutor to the son of Mme de Staël, he resolved, with his schoolfellow Colladon, to try his fortune in Paris, and obtained employment on the *Bulletin universel*. In 1829 he discovered the theorem, regarding the determination of the number of real roots of a numerical equation included between given limits, which bears his name (see EQUATION, V.), and in the following year he was appointed professor of mathematics at the Collège Rollin. He was chosen a member of the Académie des Sciences in 1836, became "répétiteur" in 1838, and in 1840 professor in the École Polytechnique, and finally succeeded S. D. Poisson in the chair of mechanics in the Faculté des Sciences at Paris. His works, *Cours d'analyse de l'école polytechnique* (1857–1863) and *Cours de mécanique de l'école polytechnique* (1861), were published after his death at Paris on the 18th of December 1855.

STURM, JULIUS (1816–1896), German poet, was born at Köstritz in the principality of Reuss on the 21st of July 1816. He studied theology at Jena from 1837 to 1841, and was appointed preceptor to the hereditary prince Henry XIV. of Reuss. In 1851 he became pastor of Göschitz near Schleiz, and in 1857 at his native village of Köstritz. In 1885 he retired with the title of *Geheimkirchenrat*. He died at Leipzig on the

2nd of May 1896. Sturm was a writer of lyrics and sonnets and of church poetry, breathing a spirit of deep piety and patriotism.

His religious poems were published in *Fromme Lieder* (pt. i., Leipzig, 1852; 12th ed., 1893; pt. ii., 1858; pt. iii., 1892), *Zwei Rosen, oder das hohe Lied der Liebe* (Leipzig, 1854; 2nd ed., 1892), *Israelitische Lieder* (3rd ed., Halle, 1881) and *Palme und Krone* (Leipzig, 1888). His chief lyrics were issued in *Gedichte* (6th ed., Leipzig, 1892), *Neue Gedichte* (2nd ed., Leipzig, 1880), *Lieder und Bilder* (2nd ed., 1892), *Kampf- und Siegesgedichte* (Halle, 1870),

Neue Lieder (1880, 2nd ed., 1888), *Neue lyrische Gedichte* (Leipzig, 1894) and *In Freud und Leid, letzte Lieder* (1896).

See A. Hepding, *Julius Sturm* (Giessen, 1896); F. Hoffmann, *Julius Sturm* (Hamburg, 1898).

STURM VON STURMECK, JACOB (1489-1553), German statesman and reformer, was born at Strassburg, where his father, Martin Sturm, was a person of some importance, on the 10th of August 1489. He was educated at the universities of Heidelberg and Freiburg, and about 1517 he entered the service of Henry, provost of Strassburg (d. 1552), a member of the Wittelsbach family. He soon became an adherent of the reformed doctrines, and leaving the service of the provost became a member of the governing body of his native city in 1524. He was responsible for the policy of Strassburg during the Peasants' War; represented the city at the Diet of Spires in 1526; and at subsequent Diets gained fame by his ardent championship of its interests. As an advocate of union among the Protestants he took part in the conference at Marburg in 1529; but when the attempts to close the breach between Lutherans and Zwinglians failed, he presented the *Confessio tetrapolitana*, a Zwinglian document, to the Augsburg Diet of 1530. As the representative of Strassburg Sturm signed the "protest" which was presented to the Diet of Spires in 1529, being thus one of the original "Protestants." He was on friendly terms with Philip, landgrave of Hesse. Owing largely to his influence Strassburg joined the league of Schmalkalden in 1531. The troops of Strassburg took the field when the league attacked Charles V. in 1546; but in February 1547 the citizens were compelled to submit, when Sturm succeeded in securing very favourable terms from the emperor. He was also able to obtain for his native city some modification of the *Interim* issued from Augsburg in May 1548. Sturm is said to have been in the pay of Francis I. of France, but this seems very unlikely. He founded the *Bibliothek* and a gymnasium in Strassburg, where he died on the 30th of October 1553.

See H. Baumgarten, *Jakob Sturm* (Strassburg, 1876); A. Baum, *Magistral und Reformation in Strassburg bis 1529* (Strassburg, 1887); J. Rathgeber, *Strassburg im 16. Jahrhundert* (Stuttgart, 1871); O. Winckelmann, "Jakob Sturm," in the *Allgemeine deutsche Biographie*, Bd. xxxvii. (Leipzig, 1894); and Johannes Sturm, *Consolatio ad senatum argentinensem de morte . . . Jacobi Sturmii* (Strassburg, 1553).

STURT, CHARLES (d. 1869), English explorer in New South Wales and in South Australia, was born in England, and entered the army, reaching the rank of captain. Having landed in Australia with his regiment (the 30th), he became interested in the geographical problems which were exciting attention. A first expedition (1828) led to the discovery of the Darling river; and a second, from which the explorer returned almost blind, made known the existence of Lake Alexandrina. From his third journey (1844-1845), in which terrible hardships had to be endured, he returned quite blind, and he never altogether recovered his sight. He was appointed surveyor-general of South Australia in 1833, and subsequently chief secretary, which position he held until 1856 when responsible government was introduced, and Captain Sturt retired on a pension and went to live at Cheltenham, England, where he died on the 16th of June 1869, before he could be invested with the dignity of K.C.M.G. to which he had been designated.

STUTTGART, a city of Germany, capital of the kingdom of Württemberg. It lies in a basin watered by the Nesenbach just above its confluence with the Neckar, 115 m. N.W. from Munich, and at the centre of a network of railways placing it in direct communication with all the principal towns of south Germany. Pop. (1905), 249,443, of whom about one-half reside in the suburbs of Cannstatt, Berg, Gaisburg, Gablenburg and others. Charmingly situated among vine-clad and wooded hills, Stuttgart stands at a height of nearly 900 ft. above the sea and enjoys a healthy climate. It is intersected from south-west to north-east by the long and handsome Königsstrasse, dividing it into an upper and a lower town. In all its main features it is essentially a modern town, and few of its principal buildings are older than the 19th century. Many of them,

however, are of considerable architectural importance and the revival of the Renaissance style is perhaps illustrated nowhere better than in Stuttgart. The lower, or south-eastern, part contains both the small group of streets belonging to old Stuttgart, and also the most important part of the new town. Of the numerous churches in the city the most interesting are the Stiftskirche, with two towers, a fine specimen of 15th-century Gothic; the Leonhardskirche, also a Gothic building of the 15th century; the Hospitalkirche, restored in 1841, the cloisters of which contain the tomb of Johann Reuchlin; the fine modern Gothic church of St John; the new Roman Catholic church of St Nicholas; the Friedenskirche; and the English church. A large proportion of the most prominent buildings are clustered round the spacious Schlossplatz, with its fine promenades. Among these are the new palace, an imposing structure of the 18th century, finished in 1807; the old palace, a 16th-century building, with a picturesque arcaded court; the Königsbau, a huge modern building with a fine colonnade, containing ball and concert rooms; the so-called Akademie, formerly the seat of the Karlschule, where Schiller received part of his education, and now containing the royal library; and the court theatre, destroyed by fire in 1902, and subsequently rebuilt. In the centre of the Schlossplatz is the lofty jubilee column, erected in 1841 in memory of the king of Württemberg, William I., and in the courtyard of the old palace is a bronze equestrian statue of Duke Eberhard the Bearded. On or near the Schlossplatz also are the new courts of justice; the Wilhelmshaus and the palace of the crown prince; the large royal stables; the new post office; and the central railway station, one of the handsomest structures of the kind in Germany. The city contains a fine statue of Schiller, designed by Thorvaldsen; a bronze statue of Christopher, duke of Württemberg; a monument to the emperor William I.; an equestrian statue of King William I. in the court of the museum of the plastic arts; and a large monumental fountain in the Eugensplatte. Other prominent buildings are: the Queen Olga buildings, erected in 1893-1895 in the Renaissance style; the national industrial museum (1890-1896) in the late Renaissance style, flanked by two cupola-crowned towers and decorated with medallions of famous Swabians; the magnificent new town-hall; and the railway viaduct across the valley of the Neckar, 740 yds. long.

The art collections of Stuttgart are numerous and valuable. The museum of art comprises a picture gallery, a collection of casts of Thorvaldsen's works and a cabinet of engravings. The royal library contains about 400,000 printed volumes, including one of the largest collections of Bibles in the world, and also about 20,000 MSS., many of great rarity. To these may be added the industrial museum, the cabinet of coins, the museum of natural history, the collection of majolica vases in the new palace, and the Württemberg museum of antiquities. The city also contains numerous excellent educational establishments, although the state university is not here but at Tübingen, and its conservatorium of music has long been renowned. The technical high school, which since 1899 has possessed the right to confer the degree of doctor of engineering, practically enjoys academic status and so do the veterinary high school and the school of art.

Stuttgart is the centre of the publishing trade of south Germany, and it has busy industries in everything connected with the production of books. Its other manufactures include machinery, pianos and other musical instruments, cotton goods, cigars, furniture, leather, paper, colours and chemicals. Its trade also in books, hops, horses, and cloth is considerable, and a large banking and exchange business is done here. The beauty of its situation and its educational advantages attract numerous foreign residents, especially English and American. Stuttgart is the headquarters of the XIII. corps of the German army, and contains a fairly large garrison for which accommodation is provided in the extensive barracks in and around the city.

To the north-east of the new palace lies the beautiful palace park, embellished with statuary and artificial sheets of water, and extending nearly all the way to Cannstatt, a distance of

over two miles. Cannstatt, which was incorporated with Stuttgart in 1903, attracts numerous visitors owing to its beautiful situation on the Neckar and its saline and chalybeate springs. In the environs of Stuttgart and Cannstatt lie Rosenstein, Wilhelma and other residences of the royal family of Württemberg.

Stuttgart seems to have originated in a stud (Stuten Garten) of the early counts of Württemberg, and is first mentioned in a document of 1229. Its importance, however, is of comparatively modern growth and in the early history of Württemberg it was overshadowed by Cannstatt, the central situation of which on the Neckar seemed to mark it out as the natural capital of the country. After the destruction of the castle of Württemberg early in the 14th century, Count Eberhard transferred his residence to Stuttgart, which about 1500 became the recognized capital of Württemberg. But even as capital its growth was slow. At the beginning of the 19th century it did not contain 20,000 inhabitants, and its real advance began with the reigns of Kings Frederick and William I., who exerted themselves in every way to improve and beautify it. In 1849 Stuttgart was the place of meeting of the assembly called the *Rumpfparlament*.

See Pfaff, *Geschichte der Stadt Stuttgart* (2 vols., Stuttgart, 1845-1847); Wochner, *Stuttgart seit 25 Jahren* (Stuttgart, 1871); Seytler, *Unser Stuttgart, Geschichte, Sage und Kultur* (Stuttgart, 1903); J. Hartmann, *Chronik der Stadt Stuttgart* (Stuttgart, 1886); Barth, *Stuttgarter Handel in aller Zeit* (Stuttgart, 1896); Widmann, *Wanderung durch Stuttgart und Umgebung* (Stuttgart, 1896); M. Bach, *Stuttgarter Kunst 1794-1860* (Stuttgart, 1900); Weinberg, *Führer durch die Haupt- und Residenzstadt Stuttgart* (Stuttgart, 1906); M. Bach and C. Lotter, *Bilder aus Alt-Stuttgart* (Stuttgart, 1896); and the official *Chronik der Haupt- und Residenzstadt Stuttgart* (1898, seq.).

STUYVESANT, PETER (1592-1672), Dutch colonial governor, was born in Scherpenzeel, in southern Friesland, in 1592, the son of a minister. He studied at Franeker, entered the military service in the West Indies about 1625, and was director of the West India Company's colony of Curaçao from 1634 to 1644. In April 1644 he attacked the Portuguese island of Saint Martin and was wounded; he had to return to Holland, and there one of his legs was amputated. Thereafter he wore a wooden leg ornamented with silver bands. In May 1645 he was selected by the West India Company to supersede William Kieft as director of New Netherland. He arrived in New Amsterdam (later New York) on the 11th of May 1647, and was received with great enthusiasm. In response to the demand for self-government, in September 1647 he and the council appointed—after the manner then followed in Holland—from eighteen representatives chosen by the people a board of nine to confer with him and the council whenever he thought it expedient to ask their advice; three of the nine, selected in rotation, were permitted to sit with the council during the trial of civil cases; and six were to retire each year, their successors to be chosen by the director and council from twelve candidates nominated by the board. The leading burghers were, however, soon alienated by his violent and despotic methods, by his defence of Kieft, and by his devotion to the interests of the company; the nine men became (as early as 1649, when they sent the famous *Vertoogh*, or Remonstrance, to the states-general asking for burgher government and other reforms) the centre of municipal discontent; and a bitter quarrel ensued. In 1650 the states-general suggested a representative government to go into effect in 1653, but the company opposed it; in 1653, however, there was established the first municipal government for the city of New Amsterdam modelled after that of the cities of Holland. Stuyvesant also aroused opposition through his efforts to increase the revenues of the company, to improve the system of defence, and to prevent the sale of liquor and firearms to the Indians, and through his persecution of Lutherans and Quakers, to which the company finally put an end. He had a bitter controversy with the patroon of Rensselaerwyck, who claimed to be independent of the West India Company. In 1647 he seized a Dutch ship illegally trading at New Haven and claimed jurisdiction as far as Cape Cod; the New Haven authorities refused

to deliver to him fugitives from justice in Manhattan; he retaliated by offering refuge to runaways from New Haven; but finally he offered pardon to the Dutch fugitives and revoked his proclamation. In September 1650 he came to an agreement with the commissioners of the United Colonies of New England at Hartford upon the boundary between New Netherland and Connecticut, involving the sacrifice of a large amount of territory, the new boundary crossing Long Island from the west side of Oyster Bay to the Atlantic Ocean, and on the mainland north from a point west of Greenwich Bay, 4 m. from Stamford. On Long Island, during Stuyvesant's rule, Dutch influence was gradually undermined by John Underhill. Stuyvesant's dealings with the Swedes were more successful. With a force of seven hundred men he sailed into the Delaware in 1655, captured Fort Casimir (Newcastle)—which Stuyvesant had built in 1651 and which the Swedes had taken in 1654—and overthrew the Swedish authority in that region. He also vigorously suppressed Indian uprisings in 1655, 1658 and 1663. In March 1664 Charles II. granted to his brother, the duke of York, the territory between the Connecticut river and Delaware Bay, and Colonel Richard Nicolls with a fleet of four ships and about three or four hundred men was sent out to take possession. Misled by instructions from Holland that the expedition was directed wholly against New England, Stuyvesant made no preparation for defence until just before the fleet arrived. As the burghers refused to support him, Stuyvesant was compelled to surrender the town and fort on the 8th of September. He returned to Holland in 1665 and was made a scapegoat by the West India Company for all its failings in New Amsterdam; he went back to New York again after the treaty of Breda in 1667, having secured the right of free trade between Holland and New York. He spent the remainder of his life on his farm called the Bouwerie, from which the present "Bowery" in New York City takes its name. He died in February 1672, and was buried in a chapel, on the site of which in 1799 was erected St Mark's Church.

See Bayard Tuckerman, *Peter Stuyvesant* (New York, 1893), in the "Makers of America" Series; and Mrs Schuyler Van Rensselaer, *History of the City of New York in the Seventeenth Century* (2 vols., New York, 1909).

STY, an enclosed place or pen to keep pigs in. The word means properly a pen or enclosure for any domestic animal, as is seen from its occurrence in Scandinavian languages and in German, e.g. Swed. and Icel. *stia*, pen, *gässstia*, goose-pen, *swinstia*, pig-sty, Ger. *Sleige*, hen-coop, *Schweinsteige*, pig-sty. It is usual to refer the word to *stigan*, to climb, which would connect it with stair and stile and with the Gr. *στέλιον*. Some take the original meaning to be an enclosure raised on steps, others, in view of the Gr. *στοῖχος*, row, would take the basic sense to be a row of pales or stakes forming a pen or enclosure; cf. the use of *στοῖχος* for poles supporting nets to catch game in (Xen. *Cyn.* 6. 10). If the derivation from *stigan* is correct, the word is the same as that meaning a small inflamed swelling, tumour or abscess on the eyelid, the Old English word for which was *stigend*, i.e. short for *stigend eage*, a rising or swelling eye, hence in M. Eng. *styang*, taken as equivalent to "sty on eye."

STYLE (from Gr. *στῦλος*, a column; a different word from that used in literature, see below), in architecture, the term used to differentiate between its characteristics in various countries and at different periods (see ARCHITECTURE). The derivation of the word suggests that it was at first employed to distinguish the classic styles, in which the column played the chief part, and it would be more appropriate to speak of the Doric and Ionic styles than orders (*q.v.*). In the Assyrian, Sassanian and perhaps the Byzantine styles, the column was a secondary feature of small importance, whereas the Greek, Doric and Ionic styles are based completely on the column and the weight of the superstructure it was required to carry. In France the term is sometimes employed of the individuality of character which is found in an artist's work. For the use of the term "style" in botany see FLOWER.

STYLE, in literature a term which may be defined as language regarded from the point of view of the characteristics which it

reveals; similarly, by analogy, in other arts, a mode or method of working characterized by distinctive features. The word (which is different from that used in architecture, see above) is derived from the instrument *stilus* (wrongly spelled *stylus*), of metal, wood or ivory, by means of which, in classic times, letters and words were imprinted upon waxen tablets. By the transition of thought known as metonymy the word has been transferred from the object which makes the impression to the sentences which are impressed by it, and a mechanical observation has become an intellectual conception. To "turn the stylus" was to correct what had been written by the sharp end of the tool, by a judicious application of the blunt end, and this responds to that discipline and self-criticism upon which literary excellence depends. The energy of a deliberate writer would make a firm and full impression when he wielded the stylus. A scribe of rapid and fugitive habit would press more irregularly and produce a less consistent text. The varieties of writing induced by these differences of temperament would reveal the nature of the writer, yet they would be attributed, and with justice, to the implement which immediately produced them. Thus it would be natural for any one who examined several tablets of wax to say, "The writers of these inscriptions are revealed by their stylus"; in other words, the style or impression of the implement is the medium by which the temperament is transferred to the written speech.

If we follow this analogy, the famous phrase of Buffon becomes at once not merely intelligible but luminous—"le style est l'homme même." This axiom is constantly misquoted ("le style c'est l'homme"), and not infrequently misunderstood. It is usual to interpret it as meaning that the style of a writer is that writer's self, that it reveals the essence of his individuality. That is true, and the statement of it is useful. But it is probably not the meaning, or at least not the original meaning, that Buffon had in mind. It should be recollected that Buffon was a zoologist, and that the phrase occurs in the course of his great *Natural History*. He was considering man in the abstract, and differentiating him from other genera of the animal kingdom. Hence, no doubt, he remarked that "style was man himself," not as every reviewer repeats the sentence to-day, "the man." He meant that style, in the variety and elaboration of it, distinguished the language of a man (*Homo sapiens*) from the monotonous roar of the lion or the limited gamut of the bird. Buffon was engaged with biological, not with aesthetic ideas.

Nevertheless, the usual interpretation given to the phrase "le style est l'homme même" may be accepted as true and valuable. According to an Arab legend King Solomon inquired of a djinn, "What is language?" and received the answer, "a wind that passes." "But how," continued the wisest of men, "can it be held?" "By one art only," replied the djinn, "by the art of writing." It may be well to follow a little closely the processes of this art of writing. A human being in the artless condition, in whom, that is to say, the conception of personal expression has not been formed, uses written language to state primitive and general matters of fact. He writes, "The sea is rough to-day; the wind is cold." In these statements there is some observation, but as yet no personal note. We read them without being able to form the very smallest conjecture as to the character or condition of the writer. From these bald and plain words we may rise in degree until we reach Victor Hugo's celebrated parallel of the ocean with the genius of Shakespeare, where every phrase is singular and elaborate, and every element of expression redolent of Victor Hugo, but of no other person who ever lived. Another example, in its own way still more striking, is found in comparison of the famous paragraph which occurs in the *Cyrus-Garden* (1658) of Sir Thomas Browne. A primitive person would say, "But it is time to go to bed"; this statement is drawn out by Browne into the wonderful page beginning, "But the quincunx of Heaven runs low," and collects around it as it proceeds on its voluptuous course the five ports of knowledge, cables of cobwebs, the bed of Cleopatra, the ghost of a rose, the huntsmen of Persia, and a dozen other examples of prolific and ornamented style. In its final form

it is so fully characteristic of its author that it may be justly said that the passage is Browne himself.

It follows from what has just been said that style appeals exclusively to those who read with attention and for the pleasure of reading. It is not even perceived by those who read primarily for information, and these form the great majority of readers. Even these have a glimmering impression that we must not live by bread alone; that the human heart, with its imagination, its curiosity and sensitiveness, cannot be satisfied by bald statements of fact delivered on the printed page as messages are shouted along the telephone. This instinct it is which renders the untaught liable to fall into those errors of false style to which we shall presently call attention. In the untrained there yet exists a craving for beauty, and the misfortune is that this craving is too easily met by gaudy rhetoric and vain repetitions. The effect on the nature of a human being which is produced by reading or listening to a book, or a passage from a book, which that being greatly admires, is often so violent as to resemble a physical shock to the nerves. It causes a spasm of emotion, which is betrayed by tears or laughter or a heightened pulse. This effect could not be produced by a statement of the fact conveyed in language, but is the result of the manner in which that fact is presented. In other words, it is the style which appeals so vividly to the physical and moral system of the reader—not the fact, but the ornament of the fact. That this emotion may be, and often is, caused by bad style, by the mere tinsel of rhetoric and jangle of alliteration, is not to the point. The important matter is that it is caused by style, whether good or bad. Those juvenile ardours and audacities of expression which so often amuse the wise man and exasperate the pedant are but the effects of style acting on a fervid and unripe imagination. The deep delight with which a grown man of experience reads Milton or Dante is but the same phenomenon produced in different conditions.

It is, however, desirable at the outset of an inquiry into the elements of style to insist on the dangers of a heresy which found audacious expression towards the close of the 19th century, namely, that style is superior to thought and independent of it. Against this may be set at once another of the splendid apothegms of Buffon, "Les idées seules forment le fond du style." Before there can be style, therefore, there must be thought, clearness of knowledge, precise experience, sanity of reasoning power. It is difficult to allow that there can be style where there is no thought, the beauty even of some poems, the sequence of words in which is intentionally devoid of meaning, being preserved by the characteristics of the metre, the rhymes, the assonances, all which are, in their degree, intellectual in character. A confusion between form and matter has often confused this branch of our theme. Even Flaubert, than whom no man ever gave closer attention to the question of style, seems to dislocate them. For him the *form* was the work itself: "As in living creatures, the blood, nourishing the body, determines its very contour and external aspect, just so, to his mind, the *matter*, the basis, is a work of art, imposed, necessarily, the unique, the just expression, the measure, the rhythm, the *form* in all its characteristics." This ingenious definition seems to strain language beyond its natural limits. If the adventures of an ordinary young man in Paris be the *matter* of *L'Éducation sentimentale* it is not easy to admit that they "imposed, necessarily," such a "unique" treatment of them as Flaubert so superlatively gave. They might have been recounted with feeble rhythm by an inferior novelist, with bad rhythm by a bad novelist and with no rhythm at all by a police-news reporter. What makes that book a masterpiece is not the basis of adventure, but the superstructure of expression. The expression, however, could not have been built up on no basis at all, and would have fallen short of Flaubert's aim if it had risen on an inadequate basis. The perfect union is that between adequate matter and an adequate form. We will borrow from the history of English literature an example which may serve to illuminate this point. Locke has no appreciable style; he has only thoughts. Berkeley has thoughts which are as valuable as those of Locke, and he

has an exquisite style as well. From the artist's point of view, therefore, we are justified in giving the higher place to Berkeley, but in doing this we must not deny the importance of Locke. If we compare him with some pseudo-philosopher, whose style is highly ornamental but whose thoughts are valueless, we see that Locke greatly prevails. Yet we need not pretend that he rises to an equal height with Berkeley, in whom the basis is no less solid, and where the superstructure of style adds an emotional and aesthetic importance to which Locke's plain speech is a stranger. At the same time, an abstract style, such as that of Pascal, may often give extreme pleasure, in spite of its absence of ornament, by its precise and pure definition of ideas and by the just mental impression it supplies of its writer's distinguished vivacity of mind. The abstract or concrete style, moreover, what Rossetti called "fundamental brain-work," must always have a leading place.

When full justice has been done to the necessity of thought as the basis of style, it remains true that what is visible, so to speak, to the naked eye, what can be analysed and described, is an artistic arrangement of words. Language is so used as to awaken impressions of touch, taste, odour and hearing, and these are roused in a way peculiar to the genius of the individual who brings them forth. The personal aspect of style is therefore indispensable, and is not to be ignored even by those who are most rigid in their objection to mere ornament. Ornament in itself is no more style than facts, as such, constitute thought. In an excellent style there is an effect upon our senses of the mental force of the man who employs it. We discover himself in what he writes, as it was excellently said of Chateaubriand that it was into his phrases that he put his heart; again, D'Alembert said of Fontenelle that he had the style of his thought, like all good authors. In the words of Schopenhauer, style is the physiognomy of the soul. All these attempts at epigrammatic definition tend to show the sense that language ought to be, and even unconsciously is, the mental picture of the man who writes.

To attain this, however, the writer must be sincere, original and highly trained. He must be highly trained, because, without the exercise of clearness of knowledge, precise experience and the habit of expression, he will not be able to produce his soul in language. It will, at best, be perceived as through a glass, darkly. Nor can anyone who desires to write consistently and well, afford to neglect the laborious discipline which excellence entails. He must not be satisfied with his first sprightly periods; he must polish them, and then polish them again. He must never rest until he has attained a consummate adaptation of his language to his subject, of his words to his emotion. This is the most difficult aim which the writer can put before him, and it is a light that flits ever onward as he approaches. Perfection is impossible, and yet he must never desist from pursuing perfection. In this connexion the famous tirade of Tamburlaine in Marlowe's tragedy cannot be meditated upon too carefully, for it contains the finest definition which has been given in any language of style as the unapproachable fen-fire of the mind:—

"If all the pens that poets ever held
Had fed the feeling of their master's thoughts,
And every sweetness that inspired their hearts,
Their minds, and muses, on admirèd themes—
If all the heavenly quintessence they 'still
From their immortal flowers of poesy,
Wherein, as in a mirror, we perceive
The highest reaches of a human wit—
If those had made one poem's period,
And all combined in beauty's worthiness,
Yet should there hover in our restless heads
One thought, one grace, one wonder, at the least,
Which into words no virtue can digest."

Flaubert believed that every thought or grace or wonder had one word or phrase exactly adapted to express it, and could be "digested" by no other without loss of clearness and beauty. It was the passion of his life, and the despair of it, to search for this unique phrase in each individual case. Perhaps in this research after style he went too far, losing something of that simplicity and inevitability which is the charm of natural writing.

It is boasted by the admirers of Flaubert that his style is an enamel, and those who say this perhaps forget that the beauty of an enamel resides wholly in its surface and not at all in the substance below it. This is the danger which lies in wait for those who consider too exquisitely the value and arrangement of their words. Their style becomes too glossy, too highly varnished, and attracts too much attention to itself. The greatest writing is that which in its magnificent spontaneity carries the reader with it in its flight; that which detains him to admire itself can never rise above the second place. Forgetfulness of self, absence of conceit and affectation, simplicity in the sense not of thinness or poorness but of genuineness—these are elements essential to the cultivation of a noble style. Here again, thought must be the basis, not vanity or the desire to astonish. We do not escape by our ingenuities from the firm principle of Horace, "*scribendi recti sapere est et principium et fons.*"

In speaking of originality in style it must not be forgotten that memory exercises a strong and often an insidious effect upon writing. That which has been greatly admired will have a tendency to impregnate the mind, and its echo, or, what is worse, its cadence, will be unconsciously repeated. The *cliché* is the greatest danger which lies in wait for the rapid modern author, who is tempted to adopt, instead of the one fresh form which suits his special thought, a word or even a chain of words, which conventionally represents it. Thus "the devouring element" was once a striking variant for the short word "fire," and a dangerous hidden place was once well described as "a veritable death-trap," but these have long been *clichés* which can only be used by writers who are insincere or languid. Worse than these are continuous phrases, and even sentences, such as are met with in the leaders of daily newspapers, which might be lifted bodily from their places and inserted elsewhere, so completely have they lost all vitality and reality.

With regard to the training which those who wish to write well should resign themselves to undergo, there is some difference of opinion, based upon difference of temperament. There are those who believe that the gift of style is inborn, and will reveal itself at the moment of mental maturity without any external help. There are others who hold that no amount of labour is excessive, if it be directed to a study and an emulation of what are called "the best models." No doubt these theories are both admissible. If a man is not born to write well, no toil in the imitation of Addison or Ruskin will make his style a brilliant one; and a born writer will express himself with exactitude and fire even though he be but an idle student of the classics. Yet, on the other hand, the very large number of persons who have a certain aptitude for writing, yet no strong native gift, will undoubtedly cure themselves of faults and achieve skill and smoothness by the study of those writers who have most kinship with themselves. To be of any service, however, it seems that those writers must have used the same language as their pupils. Of the imitation of the ancients much has been written, even to the extent of the publication of manuals. But what is that imitation of the verse of Homer which leads today to Chapman and to-morrow to Pope? What the effect of the study of the prose of Theophrastus which results in the prose of Addison? The good poet or prose-man, however closely he studies an admirable foreign model, is really anxious to say something which has never before been said in his own language. The stimulus which he receives from any foreign predecessor must be in the direction of analogous or parallel effort, not in that of imitation.

The importance of words, indeed, is exemplified, if we regard it closely, in this very question, so constantly mooted, of the imitation of the ancients, by the loss of beauty fatally felt in a bad translation. The vocabulary of a great writer has been, as Pater says, "winnowed"; it is impossible to think of Sophocles or of Horace as using a word which is not the best possible for introduction at that particular point. But the translator has to interpret the ideas of these ancient writers into a vocabulary which is entirely different from theirs, and unless he has a genius of almost equal impeccability he will undo the winnowing work.

He will scatter chaff and refuse over the pure grain which the classic poet's genius had so completely fanned and freed. The employment of vague and loose terms where the original author has been eclectic, and of a flood of verbiage where he has been frugal, destroys all semblance of style, although the meaning may be correctly preserved.

The errors principally to be avoided in the cultivation of a pure style are confusion, obscurity, incorrectness and affectation. To take the earliest of these first, no fault is so likely to be made by an impetuous beginner as a mingling together of ideas, images, propositions which are not on the same plane or have no proper relation. This is that mass of "stunning sounds and voices all confused" which Milton deprecates. One of the first lessons to be learned in the art of good writing is to avoid perplexity and fatigue in the mind of the reader by retaining clearness and order in all the segments of a paragraph, as well as propriety of grammar and metaphor in every phrase. Those who have overcome this initial difficulty, and have learned to avoid a jumble of misrelated thoughts and sentences, may nevertheless sin by falling into obscurity, which, indeed, is sometimes a wilful error and arises from a desire to cover poverty of thought by a semblance of profundity. The meaning of "obscurity" is, of course, in the first instance "darkness," but in speaking of literature it is used of a darkness which arises from unintelligibility, not from depth of expression, but from cloudiness and fogginess of idea.

Of the errors of style which are the consequences of bad taste, it is difficult to speak except in an entirely empirical spirit, because of the absence of any absolute standard of beauty by which artistic products can be judged. That kind of writing which in its own age is extravagantly cultivated and admired may, in the next age, be as violently repudiated; this does not preclude the possibility of its recovering critical if not popular favour. Perhaps the most remarkable instance of this is the revolution made against the cold and stately Ciceronian prose of the middle of the 16th century by the so-called Euphuists. This occurred almost simultaneously in several nations, but has been traced to its sources in the Spanish of Guevara and in his English imitators, North and Pettie, whom Lyly in his turn followed with his celebrated *Euphues*. Along with these may not unfairly be mentioned Montaigne in France and Castiglione in Italy, for, although these men were not proficient in Guevara's artificial manner, his *estilo alto*, still, by their easiness and brightness, their use of vivid imagery and their graceful illumination, they marked the universal revulsion against the Ciceronian stiffness. Each of these new manners of writing fell almost immediately into desuetude, and the precise and classic mode of writing in another form came into vogue (Addison, Bossuet, Vico, Johnson). But what was best in the ornamental writers of the 16th century is now once more fully appreciated, if not indeed admired to excess. A facility in bringing up before the memory incessant analogous metaphors is the property, not merely of certain men, but of certain ages; it flourished in the age of Marino and is welcomed again in that of Meredith. A vivid, concrete style, full of colour and images, is not to be condemned because it is not an abstract style, scholastic and systematic. It is to be judged on its own merits and by its own laws. It may be good or bad; it is not bad merely because it is metaphorical and ornate. The amazing errors which lie strewn along the shore of criticism bear evidence to the lack of sympathy which has not perceived this axiom and has wrecked the credit of dogmatists. To De Quincey, a convinced Ciceronian, the style of Keats "belonged essentially to the vilest collections of wax-work filagree or gilt gingerbread"; but to read such a judgment is to encourage a question whether all discussion of style is not futile. Yet that particular species of affectation which encourages untruth, affectation, parade for the mere purpose of producing an effect, must be wrong, even though Cicero be guilty of it.

The use of the word "style," in the sense of the present remarks, is not entirely modern. For example, the early English critic Puttenham says that "style is a constant and continual

phrase or tenour of speaking and writing" (1589). But it was in France and in the great age of Louis XIV. that the art of writing began to be carefully studied and ingeniously described. Mme de Sévigné, herself mistress of a manner exquisitely disposed to reflect her vivacious, tender and eloquent character, is particularly fond of using the word "style" in its modern sense, as the expression of a complete and rich personality. She says, in a phrase which might stand alone as a text on the subject, "Ne quittez jamais le naturel, votre tour s'y est formé, et cela compose un style parfait." Her contemporary, Boileau, contributed much to the study, and spoke with just pride of "mon style, ami de la lumière." The expression to form one's style, *à se faire un style*, appears, perhaps for the first time, in the works of the abbé d'Olivet (1682-1768), who was addicted to rhetorical speculation. Two great supporters of the pure art of writing, Swift and Voltaire, contributed much to the study of style in the 18th century. The former declared that "proper words in proper places make the true definition of a style"; the latter, more particularly, that "le style rend singulières les choses les plus communs, fortifie les plus faibles, donne de la grandeur aux plus simples." Voltaire speaks of "le mélange des styles" as a great fault of the age in which he lived; it has come to be looked upon as a principal merit of that in which we live.

The problem of how to obtain a style has frequently been treated in works of more or less ephemeral character. In France the treatises of M. Albalat have received a certain amount of official recognition, and may be mentioned here as containing a good deal of sound advice mixed with much that is jejune and pedagogic. If M. Albalat distributes a poison, the antidote is supplied by the wit of M. Remy de Gourmont; the one should not be imbibed without the other.

See Walter Pater, *An Essay on Style* (London, 1889); Walter Raleigh, *Style* (London, 1897); Antoine Albalat, *L'Art d'écrire enseigné en vingt leçons* (Paris, 1898), and *De la Formation du style par l'assimilation des auteurs* (Paris, 1901); Remy de Gourmont, *Le Problème du style* (Paris, 1902). Also Goyer-Linguet, *Le Génie de la langue française* (Paris, 1846), and "Loyson-Bridet" (i.e. Marcel Schwob), *Mœurs des diurnales* (Paris, 1902), a satire on the principal errors to which modern writers in all languages are liable. (E. G.)

STYLOBATE (Gr. *στῦλος*, a column, and *βάσις*, a base), the architectural term given to the upper step of the Greek temple on which the columns rest, and generally applied to the three steps.

STYRIA (German, *Steiermark* or *Steyermark*), a duchy and crownland of Austria, bounded E. by Hungary and Croatia, S. by Carniola, W. by Carinthia and Salzburg, and N. by Upper and Lower Austria. It has an area of 8670 sq. m. Almost all the district is mountainous, and is distinguished by the beauty of its scenery and by its mineral wealth. Geographically it is divided into northern or Upper Styria, and southern or Lower Styria, and is traversed by various ramifications of the eastern Alps. To the north of the Enns are ramifications of the Salzkammergut and Enns Alps, which include the Dachstein (9830 ft.), and the Grimming (7713 ft.), and the groups of the Todtes Gebirge (6890 ft.) and of the Pyrgas with the Grosser Pyrgas (7360 ft.). The last two groups are separated by the Pyhrn Pass (3100 ft.), traversed by a road constructed in the Roman period. Then comes the Buchstein group with the Grosser Buchstein (7294 ft.). This group forms the northern flank of the celebrated Gesäuse, a defile 12 m. long, between Admont and Hieflau, through which the Enns forces its course, forming a series of rapids. The southern flank is formed by the massif of the Reichensteiner Gebirge, which culminates in the Hochthor (7780 ft.) and belongs to the north Styrian Alps, also called Eisenerzer Alps. This group extends east of the Enns, and contains the Erzberg (5000 ft.) celebrated for its iron ores. Other groups of the north Styrian Alps are the Hochschwab, with the highest peak the Hochschwab (7482 ft.) and the Hochveitsch with the Hohe Veitsch (6501 ft.). Then come the Lower Austrian Alps with the groups of the Voralpe (5800 ft.), of the Schneealpe (6245 ft.), and the Raxalpe, with the Heukuppe (6950 ft.). All

these mountains belong to the northern zone of the eastern Alps. South of the Enns, Styria is traversed by groups of the central zone of the eastern Alps: the Niedere Tauern, the primitive Alps of Carinthia and Styria and the Styrian Nieder Alps. The principal divisions of the Niedere Tauern are: the Radstädter Tauern with the Hochgolling (9390 ft.), the Wölzer Alps with the Predigtstuhl (8349 ft.), the Rottenmanner Tauern with the Grosser Bösenstein (8032 ft.), and the Seckauer Alps or Zinken group, which culminates in the Zinkenkogel (7865 ft.). The principal ramifications of the primitive Alps of Carinthia and Styria are: the Stang Alps with the Königsstuhl (7646 ft.) and Eisenhut (8007 ft.), the Judenburger or Seethaler Alps with the Zirbitzkogel (7862 ft.), and the Koralpen which culminates in the Grosser Speikkogel (7023 ft.). The Styrian Nieder Alps cover the country north and east of the Mur, and contain the Fischbacher Alps with the Hochlantsch (5646 ft.), the Wechsel group (5700 ft.), and the small Semmering group with the Stuhleck or Spitaler Alpe (5847 ft.), and the Sonnenwendstein (4994 ft.). In this group is the famous Semmering Pass, which leads from Lower Austria into Styria and is crossed by the Semmering railway. This railway, which was completed in 1854, is the oldest of the great continental mountain railways, and is remarkable for its numerous and long tunnels, its viaducts and galleries. It has a length of 35 m., beginning at Gloggnitz in Lower Austria and ending at Mürzzuschlag in Styria, and passes through some exceedingly beautiful scenery. The whole region is now a favourite summer resort. South of the Drave Styria is traversed by the following ramifications of the southern zone of the eastern Alps: the Bacher Gebirge with the Cerni Vrch or Schwarzer Berg (5078 ft.), and the Santhaler or Steiner Alps with the Oistriza (7709 ft.) and the highest peak of the group, the Grintovc or Grintouz (8429 ft.), which is situated on the threefold boundary of Carinthia, Carniola and Styria. Here is also the mountain country of Cilli, with the highest peak, the Wachberg (3364 ft.). The mountains decrease in height from west to east, and the south-east of Styria may be described as hilly rather than mountainous. This part is occupied by the eastern outliers of the Alps, known as the Styrian hill country, and by the Windisch Büheln, which is one of the most renowned vine districts in the whole of Austria. Styria belongs to the watershed of the Danube and its principal rivers are: the Enns with its affluent the Salza, the Raab with the Feistritz, the Mur with the Mürz, the Drau or Drave, and the Sau or Save, which receives the Sann and the Sotla. Styria has numerous small Alpine lakes of which the most important are the Grundel-see, the Töplitz-see, and the Leopoldsteiner-see. There is a mean annual difference of about 9° F. between the north-west and the south-east. The best known mineral springs are the alkaline springs of Rohitsch and Gleichenberg, the brine springs of Aussee, and the thermal springs of Tüffer, Neuhaus and Tobelbad.

In spite of the irregular nature of the surface, but little of the soil can be called unproductive. Of its total area 47-49% is covered with fine forests. About 19% is arable land, 12% pastures, 5.60% meadows, while 1.06% is occupied by gardens and 1.4% by vineyards which produce wine of a good quality. Cattle-rearing has taken a great development and also dairy-farming in the Alpine fashion. A good race of horses is bred in the valley of the Enns, while poultry-rearing and bee-keeping are carried on in the south. Fish and game are also plentiful. The great wealth of Styria, however, lies underground. Its extensive iron mines, mostly at Erzberg, which were worked during the Roman period, yield nearly half of the total production of iron in Austria. The principal foundries are at Eisenerz, Vordernberg, Trofaiach, Hieflau, Zeltweg and Neuberg. Next in importance comes the mining of brown coal, which has also been carried on for a long time. The richest coalfields are situated near Leoben, near Voitsberg and Köflach, near Eibiswald and Wies, and round Trifail, Tüffer and Hrastnig. Its other mineral resources include graphite, copper, zinc, lead, salt, alum, potter's clay, marble and good mill and building stones. Iron-foundries, machine-shops and manufactures of various kinds of iron and steel goods are very numerous. A special

branch is the making of scythes and sickles which are exported in large quantities. Among its other industrial products are glass, paper, cement, cotton goods, chemicals and gunpowder. Linen-weaving is a household industry.

The population of Styria in 1900 was 1,356,058, which is equivalent to 156 inhabitants per square mile. This proportion is considerably above the rate in the other mountainous regions of Austria. Nearly all (98.74%), profess the Roman Catholic faith and are under the bishops of Seckau and of Lavant. The Protestants number only a little over 13,000, while there are about 2500 Jews. Two-thirds of the inhabitants are Germans; the remainder, chiefly found in the valleys of the Drave and Save, are Slavs (Slovenes). At the head of the educational institutions of the province stands the university of Graz. The local Diet, of which the two Roman Catholic bishops and the rector of the university of Graz are members *ex officio*, is composed of 63 members, while Styria sends 27 deputies to the Reichsrat at Vienna. For administrative purposes, the province is divided into 21 districts and 4 towns with autonomous municipalities, namely Graz (pop. 138,370), the capital, Cilli (6743), Marburg (24,501) and Pettau (4227). Other important places are Leoben (10,204), Bruck on the Mur (7527), Mariazell (1263), Mürzzuschlag (4856), Eisenerz (6494), Vordernberg (3111), Judenburg (4901), Trifail (10,851), Eggenberg (9570), Donawitz (13,093), Köflach (3345) and Voitsberg (3321).

In the Roman period Styria, which even thus early was famed for its iron and steel, was inhabited by the Celtic Taurisci, and divided geographically between Noricum and Pannonia. Subsequently it was successively occupied or traversed by Visigoths, Huns, Ostrogoths, Langobardi, Franks and Avars. Towards the end of the 6th century the last-named began to give way to the Slavs, who ultimately made themselves masters of the entire district. Styria was included in the conquests of Charlemagne, and was henceforth comprised in the German marks erected against the Avar and the Slav. At first the identity of Styria is lost in the great duchy of Carinthia, corresponding more or less closely to the Upper Carinthian mark. This duchy, however, afterwards fell to pieces, and a distinct mark of Styria was recognized, taking its name from the margrave Ottocar of Steier (1056). A century or so later it was created a duchy. In 1192 the duchy of Styria came by inheritance to the house of Austria, and from that time it shared the fortunes of Upper and Lower Austria, passing like them to the Habsburgs in 1282. The Protestant Reformation met an early and general welcome in Styria, but the dukes took the most stringent measures to stamp it out, offering their subjects recantation or expatriation as the only alternatives. At least 30,000 Protestants preferred exile, and it was not till the edict of tolerance of 1781 granted by Joseph II. that religious liberty was recognized.

See *Die Österreichisch-ungarische Monarchie in Wort und Bild*, vol. vii. (24 vols., Wien, 1885-1902); A. von Muchar, *Geschichte des Herzogtums Steiermark* (8 vols., Graz, 1844-1867). It treats the history till 1558. F. M. Mayer, *Geschichte der Steiermark mit besonderer Rücksicht auf das Kulturleben* (Graz, 1898); J. von Zahn, *Styriaca* (Graz, 1894-1896).

STYROLENE, $C_6H_5 \cdot CH:CH_2$, also known as phenylethylene or vinylbenzene, an aromatic hydrocarbon found to the extent of 1 to 4% in storax; it also occurs with crude xylene in coal tar fractions. It may be obtained from storax by distillation with water, and synthetically by heating cinnamic acid with lime, by the action of aluminium chloride on a mixture of vinyl bromide and benzene, by removing the elements of hydrobromic acid from bromethylbenzene by means of alcoholic potash, or, best, by treating β -bromhydrocinnamic acid with soda, when it yields styrolene, carbon dioxide and hydrobromic acid. It also results on condensing acetylene, and on reducing phenylacetylene by zinc dust and acetic acid. It is a clear, strongly refractive liquid, which has a pleasant odour; it boils at 144° and has a specific gravity of 0.925 at 0°. Styrolene is oxidized by nitric or chromic acids to benzoic acid; reduction gives ethylbenzene; hydrochloric and hydrobromic acids yield α -haloid ethylbenzenes, e.g. $C_6H_5 \cdot CHCl \cdot CH_3$; whilst chlorine and bromine give $\alpha\beta$ -dihaloid ethylbenzenes, e.g. $C_6H_5 \cdot CHCl \cdot CH_2Cl$.

Styrolene gives origin to three series of derivatives, two of which contain the substituents in the side chain, e.g. $C_6H_5 \cdot CCl:CH_2$ or α -compounds, and $C_6H_5 \cdot CH:CHCl$, or ω -compounds, whilst in the third the benzene nucleus is substituted. The α -halogen compounds are obtained by heating styrolene chloride (or bromide) with lime or alcoholic potash; they are liquids which have a penetrating odour, and yield acetophenone when heated with water to 180° . The ω -chlor compound results when β -phenyl- α -chlorolactic acid (from hypochlorous acid and cinnamic acid) is heated with water; it has a hyacinthine odour and yields phenylacetaldehyde when heated with water. Nitrostyrolene results when styrolene is treated with fuming nitric acid.

Related to styrolene is phenylacetylene, $C_6H_5 \cdot C:CH$, which results when α -bromstyrolene or acetophenone chloride are heated to 130° with alcoholic potash, or phenylpropionic acid with water to 120° . It is a liquid, boiling at 139° and having a pleasant odour. It resembles acetylene in yielding metallic derivatives with ammoniacal copper and silver solutions. On solution in sulphuric acid, followed by dilution with water, it yields acetophenone.

Stilbene or toluylene, $C_6H_5 \cdot CH:CH \cdot C_6H_5$, is symmetrical diphenylethylene. It may be obtained by distilling benzyl sulphide for disulphide, by the action of sodium on benzaldehyde or benzal chloride, by distilling fumaric and cinnamic phenyl esters: $C_6H_5O \cdot OC \cdot CH:CH \cdot CO \cdot OC_6H_5 \rightarrow CO_2 + C_6H_5 \cdot CH:CH \cdot CO \cdot OC_6H_5 \rightarrow 2CO_2 + C_6H_5 \cdot CH:CH \cdot C_6H_5$ (*Ber.*, 18, p. 1945), and from chlorasymmetrical diphenylethane derivatives which undergo a rearrangement when heated (*Ber.*, 7, p. 1409). Stilbene (from Gr. *στύλβεν*, to glisten) crystallizes in large, colourless, glistening monoclinic plates, which melt at 124° and boil at 306° . On passing the vapour through red-hot tubes it yields anthracene and toluene. Reduction with hydriodic acid gives dibenzyl, and heating with sulphur gives tetraphenylthiophene or thionessal. Many derivatives are known, some of which exist in two structural forms, exhibiting geometrical isomerism after the mode of fumaric and maleic acids. Those substituted in the benzene nucleus are obtained by condensing two molecules of a substituted benzyl and benzal chlorides. The diortho and dipara dinitro compounds result from the action of alcoholic potash on ortho- and para-nitrobenzyl chlorides. The latter on reduction yields a diamino compound, the disulphonic acid of which on diazotization and coupling with a phenol, &c., gives valuable substantive cotton dyes after the type yielded by Benzidine. Stilbene bromide when treated with alcoholic potash gives diphenyl acetylene or tolane, $C_6H_5 \cdot C:C \cdot C_6H_5$.

STYX, in Greek mythology, a river which flowed seven times round the world of the dead. In the *Iliad* it is the only river of the underworld; in the *Odyssey* it is coupled with Cocytus and Pyriphlegethon, which flow into the chief river Acheron. Hesiod says that Styx was a daughter of Ocean, and that, when Zeus summoned the gods to Olympus to help him to fight the Titans, Styx was the first to come and her children with her; hence as a reward Zeus ordained that the most solemn oath of the gods should be by her and that her children (Emulation, Victory, Power and Force) should always live with him. Again, Hesiod tells us that if any god, after pouring a libation of the water of Styx, forswore himself, he had to lie in a trance for a year without speaking or breathing, and that for nine years afterwards he was excluded from the society of the gods. In historical times the Styx was identified with a lofty waterfall near Nonacris in Arcadia. Pausanias (viii. 17, 6) describes the cliff over which the water falls as the highest he had ever seen, and indeed the fall is the highest in Greece. The ancients regarded the water as poisonous, and thought that it possessed the power of breaking or dissolving vessels of every material, with the exception of the hoof of a horse or a mule. Considering the undoubted importance attached by the ancients to an oath by the water of the Styx (cf. Herodotus vi. 74), and the supposed fatal result of breaking it, it is probable that drinking the water originally formed a necessary part of the oath, and that we have to do with the tradition of an ancient poison ordeal, common amongst barbarous peoples (for the geography and similar ceremonies see Frazer's *Pausanias*, iv., pp. 250-255). The people in the neighbourhood, who call it Mavro Neró (the Black Water), still think that it is unwholesome, and that no vessel will hold it.

SUAKIN, or **SAWAKIN**, a seaport of the Anglo-Egyptian Sudan on the west side of the Red Sea in $19^\circ 7' N.$, $37^\circ 20' E.$ Pop. (1905), 10,500. Suakin stands on a coralline islet connected with the suburb of El-Kef on the mainland by a causeway and a viaduct. Access is gained to the harbour through a winding and dangerous passage over 2 m. long, terminating in a deep oval-shaped basin several acres in extent, and completely sheltered

from all winds. For centuries the chief port of the eastern Sudan, Suakin has been since 1906 to some extent superseded by Port Sudan (*q.v.*), a harbour 36 m. to the north. The custom-house and government offices present an imposing frontage to the sea, and the principal houses are of white coral stone three storeys high. The mosques are not remarkable. The mainland part of the town is surrounded by a high coral wall, built in 1884 to resist dervish attacks. About a mile beyond is a line of outer forts. The climate is very hot, damp and unhealthy, and in the summer months the government headquarters are removed to Erkowit 35 m. west of Suakin, on a plateau 3000 ft. above the sea.

Suakin is less conveniently situated than some neighbouring points (e.g. Port Sudan) for the trade with the Nile Valley. The island is without water and the harbour indifferent; yet the settlement is ancient. Here, as at Massawa, traders were presumably attracted by the advantages of an island site which protected them from the raids of the nomad Arabs of the mainland. The country inland belonged in the middle ages to the Beja (*q.v.*), but the trading places seem to have been always in the hands of foreigners since Ptolemais Theron was established by Ptolemy Philadelphus for intercourse with the elephant hunters. After the rise of Mahomedanism many Arabs settled on the coast and mixed with the heathen Beja, whose rule of kinship and succession in the female line helped to give the children of mixed marriages a leading position (Makrizi, *Khitat*, i. 104 seq., translated in Burckhardt's *Travels in Nubia*, app. iii.). Thus in 1330 Ibn Batuta found a son of the amir of Mecca reigning in Suakin over the Beja, who were his mother's kin. Makrizi says that the chief inhabitants were nominal Moslems and were called Hadarib. The amir of the Hadarib was still sovereign of the mainland at the time of J. L. Burckhardt's visit (1814), though the island had an aga appointed by the Turkish pasha of Jidda. The place was seized in 1517 by the Turks under Selim the Great, but Turkish control did not extend inland. Mehemet Ali after the conquest of the Sudan leased Suakin from Turkey. This lease lapsed with the pasha's death, but in 1865 Ismail Pasha reacquired the port for Egypt. Till the suppression of the slave trade Suakin was an important slave port and it has always been the place of embarkation for Sudan pilgrims to Mecca. Legitimate commerce, rapidly growing before the revolt of the mahdi (1881), was greatly crippled during the continuance of the dervish power, though the town itself never fell into their hands. After the fall of the khalifa trade revived, the imports in 1899 being valued at £180,000, as against £170,000 in 1880. In 1906 the figures were: imports, £324,000; exports, £113,000. Pearl fishing is an important industry and cotton is cultivated in the neighbourhood.

Suakin was the headquarters of the Egyptian and British troops operating in the eastern Sudan against the dervishes under Osman Digna (see *EGYPT, Military Operations*, 1884, seq.). When these operations were begun a project for linking Suakin to Berber by railway, first proposed during Ismail's viceroyalty, was revived and a few miles of rails were laid in 1884. Then the Sudan was abandoned and the railway remained in abeyance until 1905-1906, when the line was at length built. The railway has a terminus at Suakin, but Port Sudan was chosen as the principal entrepôt of the commerce carried by the railway. Notwithstanding the rivalry of its newly created neighbour, the trade of Suakin continued to develop. The port is connected by submarine cables with Suez and Aden and with Jidda, which lies 200 m. north-east on the opposite coast of the Red Sea (see *SUDAN*, § *Anglo-Egyptian*).

SUARDI, **BARTOLOMMEO** (c. 1455-c. 1536), Italian painter and architect, frequently called Bramantino, was born in Milan, the son of Alberto Suardi. He executed a number of paintings containing portraits of celebrated personages for the Vatican. In 1508 he was engaged in Rome. Bramante d'Urbino taught Bramantino architecture, and the pupil assisted the master in the execution of the interior of the church of San Satiro, Milan. In 1525 Bramantino was appointed architect to the court by Duke Francis (II.) Sforza, and his aid as an engineer in the defence of Milan brought him a multitude of rewards.

Bartolommeo Suardi has been much confused with a certain Bramantino da Milano, of whom Vasari makes frequent and specific mention in his life of Piero della Francesca, his observations on Benvenuto Garofalo and Girolamo da Carpi, and his life of Jacopo Sansovino. The Bramantino of Vasari, if he existed at all, worked for Pope Nicolas V. between 1450 and 1455.

SUAREZ, FRANCISCO (1548-1617), Spanish theologian and philosopher, was born at Granada on the 5th of January 1548, and educated at Salamanca. Influenced by the Jesuit John Ramirez he entered the Society of Jesus in 1564, and after teaching philosophy at Segovia, taught theology at Valladolid, at Alcala, at Salamanca, and at Rome successively. After taking his doctorate at Evora, he was named by Philip II. principal professor of theology at Coimbra. Suarez may be considered almost the last eminent representative of scholasticism. In philosophical doctrine he adhered to a moderate Thomism. On the question of universals he endeavoured to steer a middle course between the pantheistically inclined realism of Duns Scotus and the extreme nominalism of William of Occam. The only veritable and real unity in the world of existences is the individual; to assert that the universal exists separately *ex parte rei* would be to reduce individuals to mere accidents of one indivisible form. Suarez maintains that, though the humanity of Socrates does not differ from that of Plato, yet they do not constitute *realiter* one and the same humanity; there are as many "formal unities" (in this case, humanities) as there are individuals, and these individuals do not constitute a factual, but only an essential or ideal unity ("ita ut plura individua, quae dicuntur esse ejusdem naturae, non sint unum quid veritate quae sit in rebus, sed solum fundamentaliter vel per intellectum"). The formal unity, however, is not an arbitrary creation of the mind, but exists "in natura rei ante omnem operationem intellectus." In theology, Suarez attached himself to the doctrine of Luis Molina, the celebrated Jesuit professor of Evora. Molina tried to reconcile the doctrine of predestination with the freedom of the human will by saying that the predestination is consequent upon God's foreknowledge of the free determination of man's will, which is therefore in no way affected by the fact of such predestination. Suarez endeavoured to reconcile this view with the more orthodox doctrines of the efficacy of grace and special election, maintaining that, though all share in an absolutely sufficient grace, there is granted to the elect a grace which is so adapted to their peculiar dispositions and circumstances that they infallibly, though at the same time quite freely, yield themselves to its influence. This mediating system was known by the name of "congruism." Suarez is probably more important, however, as a philosophical jurist than as a theologian or metaphysician. In his extensive work *Tractatus de legibus ac deo legislatore* (reprinted, London, 1679) he is to some extent the precursor of Grotius and Samuel Pufendorf. Though his method is throughout scholastic, he covers the same ground, and Grotius speaks of him in terms of high respect. The fundamental position of the work is that all legislative as well as all paternal power is derived from God, and that the authority of every law resolves itself into His. Suarez refutes the patriarchal theory of government and the divine right of kings founded upon it—doctrines popular at that time in England and to some extent on the Continent. Power by its very nature belongs to no one man but to a multitude of men; and the reason is obvious, since all men are born equal. It has been pointed out that this accords well with the Jesuit policy of depreciating the royal while exalting the papal prerogative. But Suarez is much more moderate on this point than a writer like Mariana, approximating to the modern view of the rights of ruler and ruled. In 1613, at the instigation of Pope Paul V., Suarez wrote a treatise dedicated to the Christian princes of Europe, entitled *Defensio catholicae fidei contra anglicanae sectae errores*. This was directed against the oath of allegiance which James I. exacted from his subjects. James caused it to be burned by the common hangman, and forbade its perusal under the severest penalties, complaining bitterly at the same

time to Philip III. that he should harbour in his dominions a declared enemy of the throne and majesty of kings. Suarez lived a very humble and simple life. He died after a few days' illness on the 25th of September 1617 at Lisbon.

The collected works of Suarez have been printed at Mainz and Lyons (1630), at Venice (1740-1751), at Besançon (1856-1862) and in the collection of the Abbé Migne. His life has been written by Deschamps (*Vita Fr. Suesesii*, Perpignan, 1671). The chief modern authorities are K. Werner's *Franz Suarez u. die Scholastik der letzten Jahrhunderte* (Regensburg, 1861), and Stöckl's *Geschichte der Philosophie des Mittelalters*, iii. 643 seq.

SUBIACO (anc. *Sublaqueum*), a town of Italy, in the province of Rome, from which it is 47 m. E. by rail, picturesquely situated on the right bank of the Anio, 1339 ft. above sea-level. Pop. (1901), 7076 (town), 8003 (commune). It has ironworks and paper-mills. Sublaqueum was so called from its position under the three artificial lakes constructed in the gorge of the Anio in connexion with the aqueduct of the Anio Novus, which had its intake at the lower end of the lowest of them (the *Simbruina stagna* of Tacitus). On the banks of this lake Nero constructed a villa, in the remains of which was found the beautiful headless statue of a youth kneeling, now in the Museo delle Terme at Rome. There is no mention of the villa after Nero's time. The lakes gradually ceased to exist owing to the action of the Anio, the last dam being washed away in 1305. In 494 St Benedict retired to this spot, then already deserted, and took up his abode as a hermit in a cave (Sacro Speco) above the lakes of the Anio. In 505, probably, he founded the first of his twelve monasteries, completing their number between 510 and 529, when he went to Cassino. The chronicles state that the principal monastery was devastated by the Lombards in 601, and rebuilt in 705; but there is little foundation for these statements. The first authentic document that we have is the mention in the *Liber pontificalis* of the gift of vestments by Leo IV. (847-855) to the monastery of S. Silvester, S. Benedict and S. Scholastica, and to the church of SS. Cosmas and Damian. The former is probably that at the Sacro Speco. The monastery was confirmed in its possessions by Pope Gregory I.¹ and his successors, and had by the 10th century very considerable landed properties with feudal jurisdiction enumerated in several documents, the first dating from 926, and an inscription of 1052 (cf. *Regesto sublacense*, Rome, 1891). The church dedicated to S. Scholastica, S. Benedict's sister, was erected in 981, according to an inscription belonging to a later date, but carved upon a slab decorated with reliefs of the end of the 8th, or the beginning of the 9th, century.

In 1053 the church was restored and a campanile built, which still exists; and in the middle of the 13th century the church was rebuilt in the Gothic style. Other buildings grew up round it; the cloister on the right is a fine Romanesque arcaded court with twisted columns and mosaics, the south side of which was constructed by Lorenzo, the first of the family of the Cosmati, early in the 13th century, while the other three sides are due to his son Jacopo and to Jacopo's sons Luca and Jacopo, who worked here in the time of the abbot Lando (1227-1243). The irregular atrium in front of the church is probably contemporary with its reconstruction in the Gothic style about 1274, while the outer court dates from the end of the 16th century. The church, with the exception of the campanile, was modernized in 1771-1777. The right of the monks to elect their own abbot, who had by that time obtained a position of great importance, was cancelled in 1388, and in 1455 the abbot was suspended, and the administration handed over to the Spanish cardinal, Giovanni Torquemada. For the whole of the 16th century it was in the hands of the Colonna family, who were commendatories of it. During the 17th century, the Barberini held it, but in 1753 Benedict XIV. separated the spiritual and temporal dominions, placing the latter under officials directly dependent on the papacy. The commendatories were as a rule cardinals. As regards monastic discipline, the abbey had since 1514 been subject to the rule of Monte Cassino, and it was only in 1872 that it regained from

¹ The bull of 596 attributed to him is, however, now recognized as apocryphal.

Pius IX. its independence and became an autonomous congregation. Arnold Pannartz and Conrad Schweinheim, two German ecclesiastics, set up here the first printing press in Italy, issuing an edition of Donatus (1465), followed by one of Cicero (1465) and of Lactantius (1465). Copies of the Lactantius, of the Augustine of 1467, which was probably printed not here but in Rome, whither the printers migrated in that year, and of other rare *incunabula* are still preserved here. Still more interesting is the monastery of the Sacro Speco, higher up the hill, dating, it would seem, from the 9th century, though little earlier than the 13th remains. The Grotta dei Pastori contains some frescoes of the 9th century, while the Sacro Speco, or cave of St Benedict, contains frescoes of the 13th, and so does the lower church, the latter having been decorated in the first twenty years of the 13th century, and in part repainted in the latter half of the same century by an otherwise unknown master Conxolus. The upper church contains scenes from the life of Christ by an unknown Siene master of the end of the 14th century, to whom is also attributable a remarkable fresco of the triumph of death, on the stairs from the tower church to the Cappella dei Pastori, and some 15th-century work, and in the chapel of S. Gregory a remarkable portrait of St Francis of Assisi (who was perhaps here in 1218), probably painted before 1228, as it lacks the halo and the stigmata. The whole group of buildings is constructed against the rocky sides of the gorge, part of it on massive substructions. The town contains various buildings constructed by Pius VI., who as cardinal was commendatory abbot of Subiaco. It is crowned by a medieval castle constructed originally by Gregory VII.

See P. Egidi, G. Giovannoni, F. Hermanin, V. Federici, *I Monasteri di Subiaco* (Rome, 1904); A. Colasanti, *L'Aniene* (Bergamo, 1906). (T. As.)

SUBINFEUDATION, in English law, the practice by which tenants, holding land under the king or other superior lord, carved out in their turn by subletting or alienating a part of their lands new and distinct tenures. The tenants were termed "mesne-lords," with regard to those holding from them, the immediate tenant being tenant *in capite*. The lowest tenant of all was the freeholder, or, as he was sometimes termed tenant paravail. The Crown, who in theory owned all lands, was lord paramount.¹ The great lords looked with dissatisfaction on the increase of such subtenures. Accordingly in 1290 a statute was passed, *Quia emptores*, which allowed the tenant to alienate whenever he pleased, but the alienee or person to whom he granted was to hold the land not of the alienor but of the same immediate lord, and by the same services as the alienor held it before. (See further, MANOR.)

SUBJECTIVISM, a philosophical term, applied in general to all theories which lay stress on the purely mental sides of experience opposed to objectivism. In the narrowest sense subjectivism goes to the logical extreme of denying that mind can know objects at all (cf. SOLIPSISM). The doctrine originates in the fact that the most elementary psychic phenomena presuppose in addition to the data of the senses (which as such are momentary) a combining action of the mind. (See IDEALISM.)

SUBLEYRAS, PIERRE (1699-1749), French painter, was born at Uzès (Gard) in 1699. He left France for Italy in 1728, having carried off the *grand prix*. He there painted for the Canons of Asti "Christ's Visit to the House of Simon the Pharisee" (Louvre, engraved by Subleyras himself), a large work, which made his reputation and procured his admission into the Academy of St Luke. Cardinal Valenti Gonzaga next obtained for him the order for "Saint Basil and the Emperor Valens" (small study in Louvre), which was executed in mosaic for St Peter's. Benedict XIV. and all the princes of Rome sat to him, and the pope himself commanded two great paintings—the "Marriage of St Catherine" and the "Ecstasy of St Camilla"—which he placed in his private apartments. Subleyras shows greater individuality in his curious genre pictures, which he produced in considerable number (Louvre). In his illustrations of La

¹ *Paramount* and *paravail* are derived from the Latin *ad montem* and *ad vallem*, signifying the highest and lowest, respectively.

Fontaine and Boccaccio his true relation to the modern era comes out; and his drawings from nature are often admirable (see one of a man draped in a heavy cloak in the British Museum). Exhausted by overwork, Subleyras tried a change to Naples, but returned to Rome at the end of a few months to die (May 28, 1749). His wife, the celebrated miniature painter, Maria Felice Tibaldi, was sister to the wife of Trémollière.

SUBLIME (Lat. *sublimis*, exalted), in aesthetics, a term applied to the quality of transcendent greatness, whether physical, moral, intellectual or artistic. It is specially used for a greatness with which nothing else can be compared and which is beyond all possibility of calculation or measurement. Psychologically the effect of the perception of the sublime is a feeling of awe or helplessness. The first study of the value of the sublime is the treatise ascribed to Longinus (*q.v.*), *On the Sublime* (strictly *Περὶ ὑψους*). Burke and Kant both investigated the subject (cf. Burke's *Essay on the Sublime and Beautiful*, 1756) and both distinguished the sublime from the beautiful. Later writers tend to include the sublime in the beautiful (see AESTHETICS).

SUBLIMINAL SELF. The phrase "subliminal self," which is one that has figured largely of recent years in discussions of the problems of "Psychical Research," owes its wide currency to the writings of F. W. H. Myers, especially to his posthumous work *Human Personality and its survival of Bodily Death*. It is used in a wider, looser sense and a narrower, stricter sense, which two senses are often confused in a way very detrimental to clear thinking. In the stricter usage the phrase implies the peculiar conception of human personality expounded at great length and with a wealth of learning and eloquence by Myers; it stands for an hypothesis which seemed to its author to bring almost all the strange facts he and his associates observed, as well as many alleged facts whose reality still remains in dispute, under one scheme of explanation and to bring them also into intelligible relation with the body of generally accepted scientific principles. But the phrase "Subliminal Self" is now often used by those who do not fully accept Myers's hypothesis, as a convenient heading to which to refer all the facts of many different kinds that seem to imply subconscious or unconscious mental operations. This article is only concerned to expound the meaning of the phrase as it was employed by Myers, and it is much to be wished that it should only be used in this stricter sense.

In the speculations of Schopenhauer and of Eduard von Hartmann, the "Unconscious" played a great part as a metaphysical principle explanatory of the phenomena of the life and mind of both men and animals. But with these exceptions, the philosophers and psychologists of the 19th century showed themselves in the main reluctant to admit the propriety of any conception of unconscious or subconscious mental states or operations. The predominant tendency was to regard as the issue of "automatic" nervous action or of "unconscious cerebration" whatever bodily movements seemed to take place independently of the consciousness and volition of the subject, even if those movements seemed to be of an intelligent and purposeful character. This attitude towards the subconscious is still maintained by some of the more strictly orthodox scientists; but it is now very widely accepted that we must recognize in some sense the reality of subconsciousness or of subliminal psychical process. The conception of a *limen* (threshold) of consciousness, separating subconscious or subliminal psychical process from supraliminal or conscious psychical process, figured prominently in the works of G. T. Fechner, the father of psycho-physics, and by him was made widely familiar. Fechner sought to prove that a sensory stimulus too feeble to affect consciousness produces nevertheless a psychical effect which remains below the threshold of consciousness, and he tried to show ground for believing in the existence of a vast realm of such subliminal psychical processes. But his arguments, founded though they were on epoch-making experiments, have failed to carry conviction; and it is in the main on other grounds than those adduced by Fechner that the reality of modes of mental operation which may properly be called subconscious or

subliminal is now generally admitted. During the last quarter of the 19th and the opening years of the 20th century, there has been accumulated a mass of observations which suffices, in the opinion of many of those best qualified to judge, to establish the reality of processes which express themselves in purposeful actions and which bear all the marks from which we are accustomed to infer conscious cognition and volition, but of which nevertheless the subject or normal personality has no knowledge or awareness other than such as may be shared by any second person observing his actions.

Among the commonest and most striking of such manifestations is the "automatic writing" which a considerable proportion of normal persons are capable of producing. A person who has this power may sit absorbed in reading or in conversation, while his hand produces written words or sentences, of which he knows nothing until he afterwards reads them. The matter so written varies in different cases from illegibly scrawled fragments of words and sentences to long, connected, sometimes eloquent, frequently more or less dramatic, disquisitions. In some cases the "automatically" writing hand can be induced to make intelligible replies to questions whispered or otherwise put to the subject in such a way as not to draw his attention from some other object or topic with which it seems to be fully occupied. In some cases the matter so written states facts previously known to the subject but which he is unable to recollect by any voluntary effort. And in rare cases the matter written seems to imply knowledge or capacities which the subject was not believed to possess either by himself or by his friends. Other actions, including connected speech, may be produced in a similar fashion, and in the last case the subject hears and understands the words uttered from his own mouth in the same way only as those from the mouth of another person. "Table-tilting," "planchette-writing," and the various similar modes of spelling out by the aid of a code intelligible replies to questions, which have long been current in spiritistic circles and which, by those who practise them, are often regarded as the operations of disembodied intelligences, seem to belong to the same class of process. In extreme cases the manifestations of such subconscious or (better) co-conscious operations are so frequent, exhibit so much continuity and express so clearly a train of thought, purpose and memory, that they compel us to infer an organized personality of which they are the expression; such are the cases of double or multiple consciousness or personality. Very similar manifestations of a "co-consciousness" may be produced in a considerable proportion of apparently normal persons by means of post-hypnotic suggestion; as when suggestions are made during hypnosis, which afterwards the subject carries out without being aware of the actions, or of the signals in response to which he acts, and without any awareness or remembrance of the nature of the suggestions made to him. The more sober-minded of the investigators of these phenomena have sought to display all such cases as instances of division of the normal personality, and as explainable by the principle of cerebral dissociation (see HYPNOTISM); the more adventurous, concentrating their attention on the more extreme instances, regard all such manifestations as instances of the possession and control (partial or complete) of the organism of one person by the spirit or soul of another, generally a deceased person. Myers's hypothesis of the subliminal self was a brilliant attempt to follow a middle way in the explanation of these strange cases, to reconcile the two kinds of explanation with one another, and at the same time to bring into line with these other alleged facts of perplexing character, especially veridical hallucinations (*q.v.*), various types of communication at a distance (see TELEPATHY), and all the more striking instances of the operation of suggestion and of hypnosis, including the exaltation of the powers of the senses, of the memory and of control over the organic processes.

Myers conceived the soul of man as capable of existing independently of the body in some super-terrestrial or extra-terrestrial realm. He regarded our normal mental life as only a very partial expression of the capacities of the soul, so much

only as can manifest itself through the human brain. He regarded the brain as still at a comparatively early stage of its evolution as an instrument through which the soul operates in the material world. So much of the life of the soul as fails to find expression in our conscious and organic life through its interactions with this very inadequate material mechanism remains beneath the threshold of consciousness and is said to constitute the subliminal self. The subliminal self as thus conceived would be better described as the subliminal part of the self, a part which surpasses the supraliminal or normal conscious self to an indefinitely great degree as regards its range of psychical faculties. It was further conceived as being in touch with a realm of psychical forces from which it is able to draw supplies of energy which it infuses into the organism, normally in limited quantities, but, in exceptionally favourable circumstances, in great floods, which for the time being raise the mental operations and the powers of the mind over the body to an abnormally high level.

It is a leading feature of this protean conception, that many of the abnormal mental manifestations that have commonly been regarded as symptoms of mental or nervous disease or degeneration are by its aid brought into line with mental processes that are by common consent of an unusually high type, the intuitions of genius, the outbursts of inspired poesy, the emotional fervour or the ecstasy that carries the martyr triumphantly through the severest trials, the enthusiasm that enables the human organism to carry through incredible labours. Myers's hypothesis thus boldly inverts the dominant view, which sees in all departures from the normal symptoms of weakness and degeneracy and which seeks to bring genius and ecstasy down to the level of madness and hysteria; the hypothesis of the subliminal self seeks to level up, rather than to level down, and to display many of these departures from normal mental life as being of the same nature as the operations of genius, as being, in common with these, uprushes of the subliminal self, which temporarily acquires a more complete control of the organism and therefore achieves at such times a more complete expression of its powers. And these rare displays of subliminal capacities are held to foreshadow the further course of mental evolution, to afford us a glimpse of the higher plane on which the mind of man may habitually and normally live, if further evolution of the nervous system shall render it a less inadequate medium for the exercise of the spiritual faculties and for the influx of the psychical energies which at present, owing to its imperfections, are for the most part latent or confined to the subliminal self.

This bold and far-reaching hypothesis has not up to the present time been accepted by any considerable number of professional psychologists, though its author's great literary power has secured for him a respectful hearing. The comparative indifference shown to it by the scientific and philosophical world must be ascribed to considerations of two kinds. In the first place, it is rightly felt that a very large proportion of the alleged facts which it is designed to explain are not yet supported by evidence of such a nature as warrants an unreserved acceptance of them. Secondly, even if further investigations of the type of those carried on by the Society for Psychical Research should prove Myers's belief in the reality of all or most of these facts to have been well-founded, there will remain difficulties and weaknesses intrinsic to the hypothesis, which at present seem very serious. In addition to all the great difficulties that must attach to any conception of human personality as a spiritual entity capable of existing independently of the body, Myers's conception raises many difficulties peculiar to itself, the chief of which may be briefly indicated. First, the conception of the relation of the subliminal to the normal or supraliminal self is in Myers's presentation extremely vacillating and uncertain, and it is probably radically incapable of definition and consistency. Secondly, two alleged supernormal phenomena, to the establishment of which "psychical research" has been devoted most energetically and (in the view of many of the workers) with the greatest success, and which from every point of view are the most important and interesting, are supernormal communications

between the living (telepathy) and communication between the dead and the living. Now, if either or both of these modes of communication should eventually prove to be facts of nature, neither will need the hypothesis of the subliminal self for its explanation. Such evidence as we have of the latter kind of communication is almost wholly of the form of messages written or spoken by entranced persons (see TRANCE) which claim to be sent by the souls of the dead to friends still living, and these messages (if they are what they claim to be) imply, and were held by Myers himself to imply, possession or control of the brain of the living medium by the soul of the dead who transmits the message. Both phenomena need, then, for their explanation only the two great assumptions—first, that the soul is an entity capable of disembodied existence; second, that in its psychophysical interactions any soul is not strictly confined to interaction with one particular brain.

The third great difficulty is of an emotional order. All the laborious research whose results Myers has sought to harmonize by means of his conception of the "subliminal self" has been

initiated and sustained by the desire of proving the continued existence of the human personality after the death of the body. But, if Myers's doctrine is true, that which survives the death of the body is not the normal self-conscious personality of a man such as is known and valued by his friends, but a personality of which this normal personality is but a stunted distorted fragment; and it would therefore seem that according to this doctrine death must involve so great a transformation that such slight continuity as obtains must be insufficient to yield the emotional satisfaction demanded. The hypothesis would thus seem to destroy in great measure the value of the belief which it seeks to justify and establish.

See F. W. H. Myers, *Human Personality and its Survival of Bodily Death* (1st ed., London, 1903; 2nd ed., abridged and edited by L. H. Myers, London, 1907); Morton Prince, *The Dissociation of a Personality* (London, 1906); J. Jastrow, *The Subconscious* (London, 1906). See also many papers by various hands in *Proceedings of the Society for Psychical Research*, especially in part xlvi., vol. xviii., and the literature referred to under TRANCE. (W. MCD.)

END OF TWENTY-FIFTH VOLUME

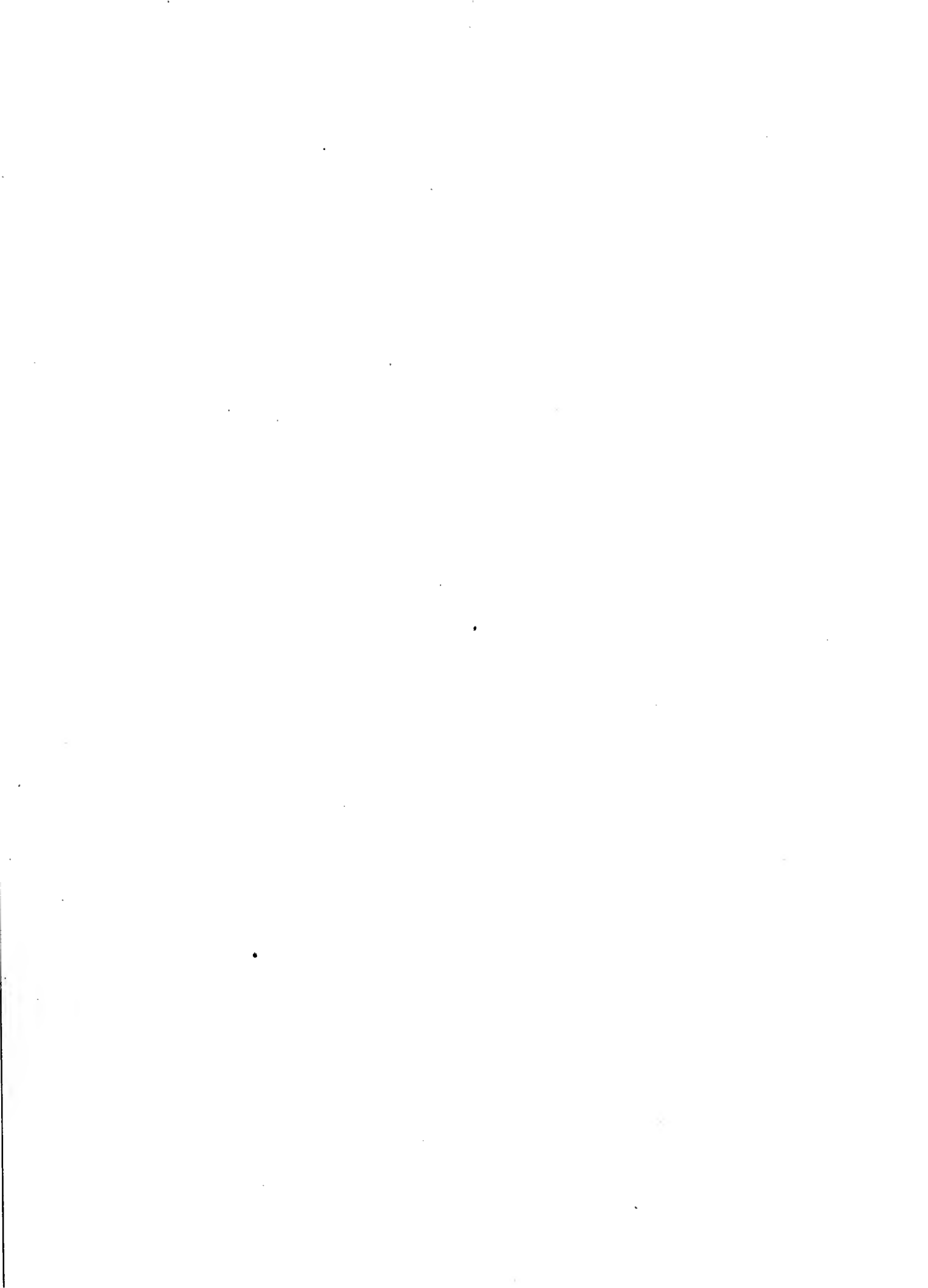



THE
ENCYCLOPEDIA
BRITANNICA

ELEVENTH
EDITION

VOL. XXV
SHU TO SUB