

1960



EPPESONION





Digitized by the Internet Archive  
in 2017 with funding from  
North Carolina Digital Heritage Center

[https://archive.org/details/eppesonion19601960cmep\\_0](https://archive.org/details/eppesonion19601960cmep_0)





This is our School  
and we Present

# THE 1960 EPPESONION

The Senior Class  
C. M. Eppes High School  
Greenville, North Carolina



## In Memoriam

The absence of Verna Stokes, a former member of the class of 1961, who passed away November 23, 1959, is yet felt by the entire school.

Because she was an excellent scholar and because she exhibited admirable traits of character, dignity, charm, and kindness, it is hard to believe that she is gone, but much easier to adhere to the illusion that she is still among us.

We, the Senior Class of 1960, therefore, proudly set aside this page in her memory.



## Dedication

In sincere appreciation for an ingenious devotion to our students; for superb qualities - as an instructor, a basketball coach, a guidance counselor, an assistant principal; and for an endeavor to develop a bond of understanding for our shortcomings, we, the graduating class of 1960, humbly dedicate this issue of the EPPESONION to MR. A. E. MURRELL.



## And this is Our Principal

A profound devotion to the interests of the students and graduates of Eppes and a staunch idealism of how a school should be managed are but two things that make our principal, W. H. Davenport, an exceptionally strong leader.







MR. A. E. MURRELL  
Assistant Principal  
Mathematics  
Physics

MRS. E. B. GRAVES  
Senior Advisor  
English

MISS R. M. STATON  
Senior Advisor  
Commerce

MRS. O. B. MYERS  
English

## Our Faculty



MRS. S. L. DAVENPORT  
French  
Music  
MISS S. F. WILCOX  
French  
English  
MRS. M. G. THOMPSON  
Social Studies

MR. J. B. SMITH  
Mathematics

MR. L. R. FOSTER  
Biology  
Mathematics

MRS. L. M. FOSTER  
English  
Social Studies

MRS. JESSICA WINSLOW  
Librarian





MISS E. C. STAPLEFOOTE  
Home Economics



MR. OSBORNE METEYE  
Physical Education



MISS CHARLOTTE JENKINS  
Physical Education



MR. HERMAN FOUST  
Masonry



MR. C. Z. DAVIS  
Chemistry  
General Science



MR. D. A. BARNHILL  
English



MRS. B. S. HEMBY  
History

MISS P. O. DUNN  
Science



MR. L. R. HUDSON  
Mathematics



MR. J. A. WOOTEN  
Band



MISS B. B. ARNOLD  
Music





MISS L. L. GRAYE  
Grade 7

MR. F. R. SANDERS  
Grade 7

MR. J. W. GRIMES  
Grade 7

MR. P. L. DANIELS  
Grade 6



MRS. L. V. FOREMAN  
Grade 6

MISS J. L. MITHCELL  
Grade 6

MR. C. B. GRAYE  
Grade 6

MRS. M. G. DUDLEY  
Grade 5

MRS. P. G. GRIMES  
Grade 5

MRS. F. P. JOYNER  
Grade 5

MRS. C. B. BURNETT  
Grade 5

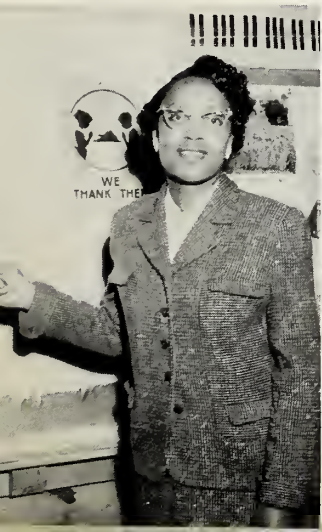



JAMES WHITE  
Advertising Manager

BARBARA WILSON  
Circulation Manager

JAMES HARRINGTON  
Art Editor

SADIE CLARK  
Business Manager

ROOSEVELT GERMAN  
Photographic Manager

## Our Staff

EVELYN SIMPSON  
Editor-in-Chief



JOEL STREETER  
FREDERICK STATON  
JOHN SLEDGE  
DAVID RAWLINS  
Assistant Advertising Managers

EVELYN SIMPSON  
Editor-in-Chief

NAOMI JENKINS  
QUINTON BAKER  
JESSIE GRIMES  
Typists



S  
E  
N  
I  
O  
R  
S

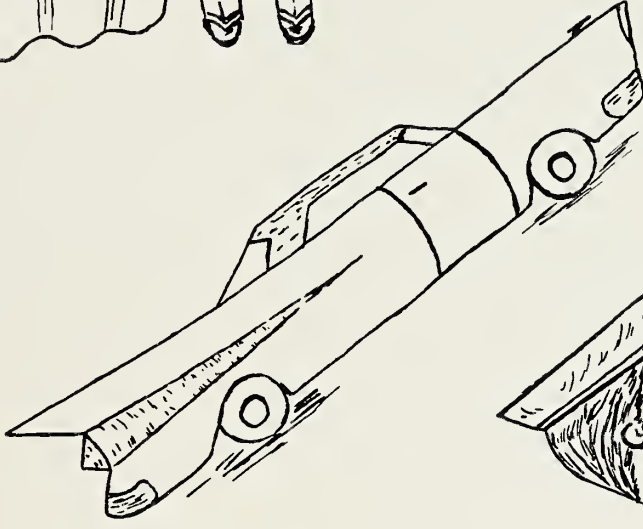
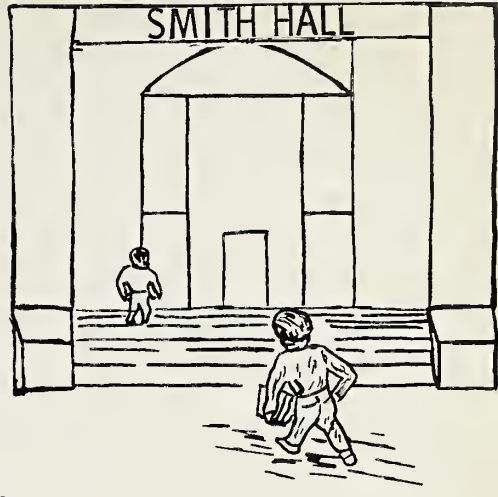

AIR FORCE



ARMY

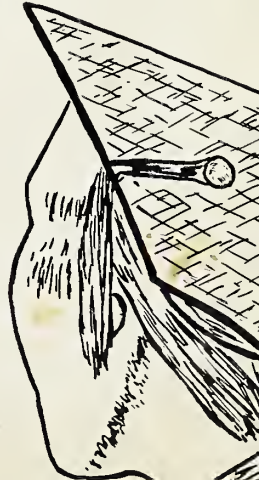



## Senior Class Officers

ISAAC ARTIS..... President  
 JACKIE OUTERBRIDGE..... Recording Secretary  
 EVELYN SIMPSON..... Financial Secretary  
 JOHN SLÉDGE..... Vice-President  
 ROOSEVELT GERMAN..... Treasurer

JOEL STREETER..... Chaplain  
 FREDERICK STATON..... Parliamentarian  
 QUINTON BAKER..... Business Manager  
 DAVID FOREMAN..... Sergeant at Arms



ALLEN, DOROTHY JEAN  
 "Kinkie"

"Love is a sacrifice shared with enternal gain."  
 Band 4; Class Officer 1; F. B. L. A. 4; Glee Club 4; Lib-  
 rary Club 1, 2, 3, 4; N. H. A. 1; Safety Patrol 2; Tri-Hi-  
 Y 4.



ARMWOOD, MAGALENE  
 "Mag"

"We never know how high we are till we are called to  
 rise; And then, if we are true to plan, our statures touch  
 the skies."

Band 2; Class Officer 1, 2; Glee Club 2, 3; Le Cercle  
 Francais 3, 4; Library Club 3, 4; Tri-Hi-Y 4.

ARTIS, ISAAC AMOS, JR.  
 "Ike"



"Simplicity is the most deceitful mistress that ever be-  
 trayed man."

Band 1, 2; Chemistry Club 3; Class Officer 2, 3, 4; Dra-  
 matics 4; F. B. L. A. 3; Le Cercle Francais 3, 4; Library  
 Club 1, 2, 3, 4; Marshal 3; Teen-Age Club 2.

BAKER, QUINTON EARL

"Quint"

"The supreme happiness of life is the conviction that we are loved."

Annual Staff 4; Class Officer 1, 2, 4; Dramatics 4; F. B. L. A. 4; Glee Club 2, 3, 4; Hi-Y 4; K. K. C. 2; Le Cercle Francais 3, 4; Library Club 1; Teen-Age Club 2; Student Council 4.

BOYD, MARY DEE

"D. D."

"When you are no longer criticized, you have finished, and the world will soon forget you."

Band 2; Class Officer 1, 2; Glee Club 1, 2, 3; Le Cercle Francais 3, 4; Library Club 3, 4; Marshal 3; Tri-Hi-Y 2, 4.

BREWINGTON, WILLIE OWEN

"W. O."

"Intelligence is a luxury, sometimes useless, sometimes fatal. It is a torch or firebrand according to the use one makes of it."

Art 1, 2; Band 1, 2, 3, 4; F. B. L. A. 1; Football 3, 4; Glee Club 4; Hi-Y 3, 4; Le Cercle Francais 3, 4.

BROCKETT, BARBARA ANN

"Babs"

"Nothing is so popular as kindness."

Art 3; Band 2; Dramatics 4; F. B. L. A. 3; Le Cercle Francais 3, 4; Library Club 2; Senior Girl Scouts 3; Tri-Hi-Y 4.



CLARK, SADIE MARIE

"Not education, but character, is man's greatest need and man's greatest safeguard."

Annual Staff 4; Band 2, 3; Class Officer 1, 2; F. B. L. A. 3; Glee Club 2, 3, 4, Officer 4; Le Cercle Francais 3, 4; Student Council 4; Tri-Hi-Y 4.

COREY, GEORGE

"Peanut"

"As are families, so is society."

Chemistry Club 3; Class Officer 3; Glee Club 2, 3, 4; Hi-Y 3, 4; Le Cercle Francais 3, 4.



DELOATCH, CALVIN

"Lafayette"

"For what ye seeketh in the future, work hard, have faith in God, and ye shall find it."

Band 1; Chemistry Club 3; Dramatics 3, 4; Hi-Y 4; Library Club 3, 4; Safety Patrol 2.

DUPREE, JOHN THOMAS

"Freddie Frog"

"A friend is never known, till a man have need."

Glee Club 1, 2, 3; Shop 1, 2; Teen-Age Club 1, 2.

**EBRON, ANNIE PEARL**

"What people say you cannot do, you try and find that you can."

Le Cercle Francais 3, 4; Library Club 3, 4; Senior Girl Scouts 1, 2, 3; Tri-Hi-Y 2, 3, 4.

**EDWARDS, ELEANOR**

"Shorty"

"Life is not long, and too much of it must not pass in idle deliberation how it shall be spent."

Dramatics 4; Glee Club 2; Le Cercle Francais 3, 4; Library Club 4; Tri-Hi-Y 4.



**FLEMING, BETTYE JEAN**

"Bet"

"Nothing is so dear and precious as time."

Le Cercle Francais 3, 4; Library Club 3, 4.

**FLOYD, ANNIE OLIVIER**

"Ann"

"If a man empties his purse into his head, no man can take it away from him. An investment in knowledge always pays the best interest."

Band 1, 4; Dramatics 4; F.B.L.A. 3, 4; Le Cercle Francais 3, 4; Library Club 1; Senior Girl Scouts 3; Tri-Hi-Y 4.

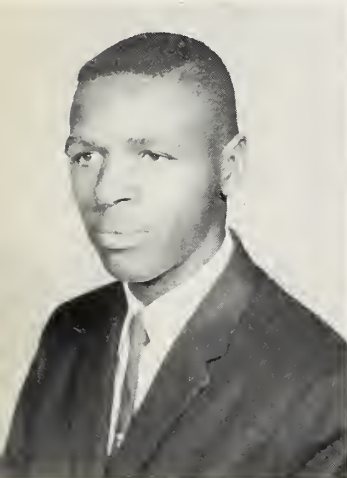

**FORBES, ERROL FLYNN**

"Huck-Hound"

"You never miss the water until the well runs dry."

Art 1, 2, 3; Chemistry Club 3; Class Officer 3, 4; Glee Club 4; Hi-Y 3, 4; Le Cercle Francais 3, 4; Student Council 1.

**FOREMAN, DAVID**

"Shorty"

"We too often forget that not only is there a 'soul of goodness in things evil,' but very generally a soul of truth in things erroneous."

Hi-Y 4.

**FOUST, BRENDA VERNEAR**

"Shortie"

"Aide-toi, le ciel t'aidera."

Band 1; Glee Club 1, 2, 3; Le Cercle Francais 3, 4; Library Club 3, 4; N.H.A. Club 1; Senior Girl Scouts 3.

**GERMAN, ROOSEVELT**

"R. G-Man"

"The only thing we have to fear is fear itself."  
Annual Staff 4; Art 1; Chemistry Club 3; Class Officer 1, 2, 4; Football 2; Hi-Y 4; Le Cercle Francais 3, 4; Sportswriter 2, 3, 4; Teen-Age Club 2.





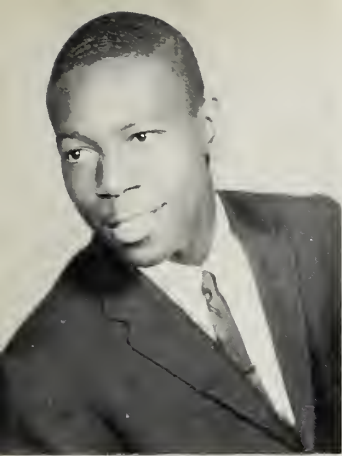

GRAHAM JAMES EDWARD

"Rabbit"

"Well-ordered words are as a honeycomb; sweet to the soul, and health to the bones."

Chemistry Club 3; Hi-Y 3, 4; Teen-Age Club 1, 2.

GRIMES, JESSIE MAE

"Little Bit"

"Outside show is a poor substitute for inner worth."

Annual Staff 4; Band 1, 2, 3, 4; Class Officer 1; F. B. L. A. 3, 4; Le Cercle Francais 3, 4; Library Club 1.

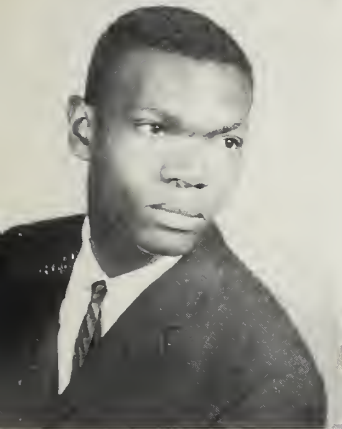

HARRINGTON, JAMES

"The way is open to those who are willing."

Annual Staff 4; Art 3; Chemistry Club 3; Hi-Y 4; Le Cercle Francais 3, 4.

HEMBY, ANNIE LOUISE

"Bozzie"

"The wise shall inherit glory; but shame shall be the promotion of fools."

Art 1, 2; Band 3, 4; F. B. L. A. 4; Le Cercle Francais 3, 4; Library Club 4; N. H. A. 2, 3, 4; Tri-Hi-Y 3.

HOPKINS, JOYCE ANN

"Joy"

"He that rejecteth wisdom and discipline is unhappy; and his hope is in vain, and his labour without fruit, and his work is unprofitable."

Band 1; Basketball 2, 3; Class Officer 2; Glee Club 2, 3, 4; Le Cercle Francais 3, 4; Library Club 4; Tri-Hi-Y 2.

HUGGINS, RUFUS

"Bobo"

"We become wiser by adversity; prosperity destroys our appreciation of the right."

Basketball 3; Football 1, 2, 3, 4; Hi-Y 3, 4.

JAMES, JOHN ALFONZO

"Baby Brother"

"All I am, and hope to be, I owe to my angel mother."

Chemistry Club 3; Dramatics 4; Glee Club 2, 3, 4.

JENKINS, NAOMI

"Red"

"He that is of the opinion that money will do everything may well be suspected of doing everything for money."

Annual Staff 4; Band 1, 2, 4; Class Officer 2, 3; Dramatics 3, 4; F. B. L. A. 3, 4; Le Cercle Francais 3, 4; Library Club 2, 3, 4; Safety Patrol 3; Senior Girl Scouts 3, 4; Teen-Age Club 2; Tri-Hi-Y 2, 4.

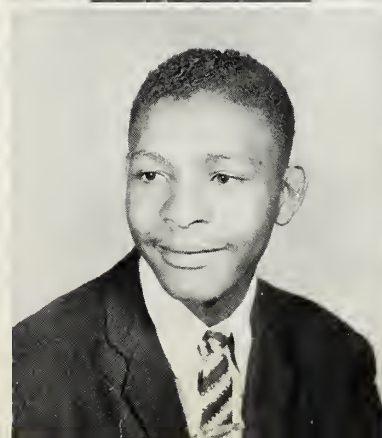



LITTLE, GERALDINE

"Cookie"

"A good leader is concerned with others, not himself."  
F. B. L. A. 4; Senior Girl Scouts 3; Glee Club 2; Le Cercle Francais 3, 4.

MILLER, ANNIE IRISTINE

"Tine"

"Keep your spirits up and discouragement won't get a chance to knock you down."  
Basketball 3, 4; Dramatics 4; Library Club 2, 3, 4; N. H. A. 1; Teen-Age Club 1; Tri-Hi-Y 4.



MOORE, NAOMI FAYE RUTH

"Ruth"

"The Lord is my light and my salvation; whom shall I fear? The Lord is the strength of my life; of whom shall I be afraid?"

Chemistry Club 3; Class Officer 1, 2, 3; Dramatics 1, 2, 3, 4; Le Cercle Francais 3, 4; Library Club 1, 2, 3, 4; Safety Patrol 3; Tri-Hi-Y 2, 3, 4.

MOORING, CALVIN THOMAS

"Cluck"

"Behavior is a mirror in which everyone displays his image."

Band 1, 2, 3, 4; Class Officer 1; F. B. L. A. 3; Glee Club 4; Safety Patrol 1.

MURPHY, JULIUS, JR.

"Jay Bird"

"Better the feet slip than the tongue."

Chemistry Club 3; Class Officer 2; Football 1, 2, 3; Hi-Y 1, 2, 3, 4; Le Cercle Francais 3, 4.

MYERS, DORIS JEAN

"Dot"

"No man ruleth safely but he that is willingly ruled."  
Art 1, 2; F. B. L. A. 1; Library Club 1; Teen-Age Club 1, 2, 3; Tri-Hi-Y 1, 2, 3.



OUTTERBRIDGE, JACKIE ANN

"Jack"

"Too many of us conduct our lives on the cafeteria plan—self-service only."

Art 2; Band 1, 2, 3, 4; Basketball 2, 3; Class Officer 2, 4; Dramatics 4; F. B. L. A. 3; Glee Club 1, 2, 3, 4; Library Club 4; Teen-Age Club 1; Tri-Hi-Y 2.

PARKER, EULA

"Speech is the index of the mind."

Art 2; F. B. L. A. 4; Le Cercle Francais 3, 4; Tri-Hi-Y 4.



PERKINS, CAROL BRUCE

"Pee Wee" "Cal"

"A mind only grows when it is kept open."

Art 1; Cheering Squad 2; Dramatics 4; Le Cercle Francais 3, 4; Library Club 3; Teen-Age Club 1; Tri-Hi-Y 4.

RANDOLPH, HAZEL MAE

"Nan"

"No one means all he says, and yet very few say all they mean, for words are slippery and thought is vicious."

Dramatics 4; Glee Club 2; Le Cercle Francais 3, 4; Library Club 1, 2, 3, 4; Teen-Age Club 1, 2, 3; Tri-Hi-Y 4.



RAWLINS, DAVID EARL

"Buddy"

"A little thing in hand is worth more than a great thing in prospect."

Annual Staff 4; Chemistry Club 3; Class Officer 1; Hi-Y 4; Le Cercle Francais 3, 4.

REEVES, ALLIE MAMIE

"Al" "Little Baby"

"Character is the real foundation of all worthwhile success."

Band 1, 2, 3, 4; Basketball 2, 3; Dramatics 4; F. B. L. A. 3; Senior Girl Scouts 1, 3; Le Cercle Francais 3, 4; Library Club 2, 3; N. H. A. 1, 2, 3, 4; Student Council 3; Teen-Age Club 2; Tri-Hi-Y 2, 3.

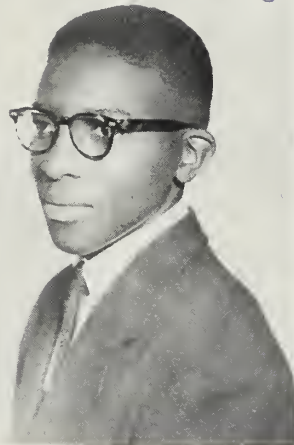

ROBERSON, ROOSEVELT

"Professor" "Roosie"

"Next to excellence is the appreciation of it."

Art 1, 2, 3; Class Officer 2; Dramatics 4; F. B. L. A. 1; Football 1, 2, 3, 4; Hi-Y 4; Le Cercle Francais 3, 4; Teen-Age Club 2, 3.

SCOTT, MARY ANN

"Fats" "Scottie"

"It never matters not how a man dies, but how he lives."

Dramatics 3, 4; Glee Club 1, 2, 3, 4; Le Cercle Francais 3, 4; Library Club 2, 4; Tri-Hi-Y 3.

SHERROD, MILDRED

"Chop Chop" "Porkie"

"When you use your sense of humor, be sure to use sense as well as humor."

Art 1, 2; Dramatics 4; F. B. L. A. 4; Library Club 4; Le Cercle Francais 3, 4; Tri-Hi-Y 4.

SIMPSON, EVELYN JEAN

"Jeano"

"Outside show is a poor substitute for inner worth." Annual Staff 4; Band 1, 2, 3, 4; Chemistry Club 3; Class Officer 1, 2, 3, 4; Dramatics 4; F. B. L. A. 3; Le Cercle Francais 3, 4; Library Club 3, 4; Literary Club 4; Marshal 3; N. H. A. 2, 3; Physics Club 4; Safety Patrol 3; Senior Girl Scouts 3; Student Council 2, 3; Teen-Age Club 2; Tri-Hi-Y 2, 3.



SLEDGE, JOHN FREDERICK

"If you wish success in life, make perseverance your bosom friend, experience your wise counsellor, caution your elder brother, and hope your guardian genius."

Annual Staff 4; Band 1, 2, 3, 4; Chemistry Club 3; Class Officer 1, 4; Football 1, 2, 3; Hi-Y 3, 4; Library Club Officer 4; Le Cercle Francais 3, 4; Marshal 3; Student Council 3.

STANCIL, MARY

"Red"

"Every man for himself and God for us all."

Art 1, 2; Class Officer 1, 2; F. B. L. A. 4; Library Club 4; N. H. A. 2, 3.

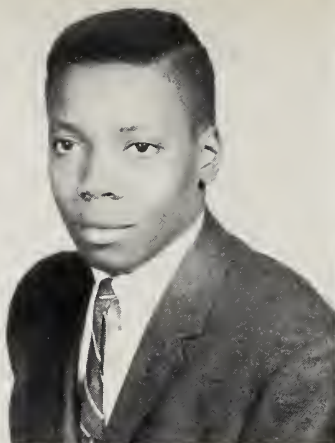

STATON, FREDERICK

"Brains" "Feet"

"It is hard for an empty sack to stand upright."

Annual Staff 4; Band 1, 2, 3, 4; Chemistry Club 3; Basketball 4; Class Officer 1, 2, 3, 4; Dramatics 4; Football 3, 4; F. B. L. A. 3; Glee Club 4; Hi-Y 2, 3, 4; Le Cercle Francais 3, 4; Library Club 1, 2, 3, 4; Safety Patrol 2, 3; Student Council 3.

STREETER, JOEL TYRONE

"Keep your spirits up and discouragement won't get a chance to knock you down."

Annual Staff 4; Basketball 1, 2; Class Officer 1, 2; Chemistry Club 3; Football 1, 2; Hi-Y 2, 3, 4; Junior Red Cross Council 4; Le Cercle Francais 3, 4; Library Club 4; Safety Patrol 1, 2, 3, 4; Student Council 1, 2; Teen-Age Club 1, 2, 3.

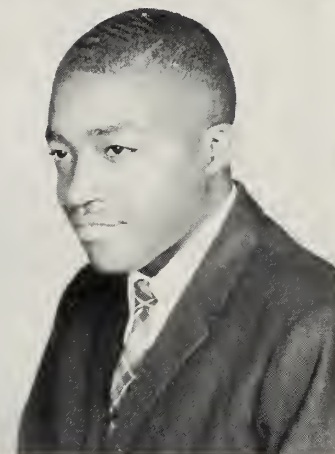

TAFT, DELORES

"Lois"

"What's the use of worrying? It never was worth while, so pack up your troubles in your old kit-bag and smile, smile, smile."

Art 1, 2; F. B. L. A. 4; Library Club 4; N. H. A. 1.

TUCKER, MAMIE RUTH

"Chicken Leg"

"Doing what's right is no guarantee against misfortune." Dramatics 3; Library Club 2, 3, 4; N. H. A. 1; Teen-Age Club 1; Tri-Hi-Y 4.

TYSON, ARCHIE LEE

"Brother" "Blue"

"A prosperous future lies ahead for me; for this I thank Thee."

Glee Club 2, 3, 4; Hi-Y 4; Library Club 1.

TYSON, JAMES EARL

"Tyte"

"A closed mouth is often evidence of an open mind." Chemistry Club 3; Hi-Y 2; Le Cercle Francais 3; Teen-Age Club 1, 2, 3, 4.

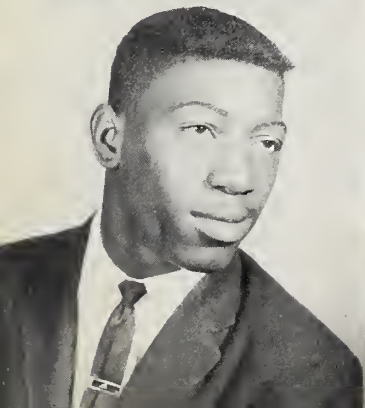



WHITE, JAMES DOUGLAS

"Ajax" "Napoleon"

"Keep cool and you command everybody."

Annual Staff 4; Chemistry Club 3; Class Officer 1, 2, 3; Hi-Y 3, 4; K. K. C. 2; Le Cercle Francais 3, 4; Library Club 4; Marshal 3; Physics Club 4; Literary Club 4; Student Council 3, 4; Safety Patrol 3; Teen-Age Club 1, 2, 3.

WHITE, LILLIE MAE

"Li"

"I judge myself by what I think I am capable of doing; others judge me by what I have already done." Glee Club 4; Le Cercle Francais 3, 4; Library Club 2, 3; Senior Girl Scouts 2, 3; Tri-Hi-Y 4.



WILKINS, BOBBY JEAN

"Doll" "Bar-Be-Que"

"O, let America be America again, the land that never has been yet-and yet must be-the land where every man is free."

Class Officer 3, 4; F. B. L. A. 3; Glee Club 1, 2, 3, 4; Le Cercle Francais 3, 4; N. H. A. 1, 2; Senior Girl Scouts 3.

WILLIAMS, DIANN

"Deedy" "Di"

"Love thyself last: Cherish those hearts that hate thee."

Dramatics 4; Le Cercle Francais 3, 4; Library Club 2, 3, 4; Safety Patrol 1; Senior Girl Scouts 3; Tri-Hi-Y 2, 3, 4.

WILLIAMS, JESSE LE

"Jocko"

"Kid them all, fool them all, have no worry."

Annual Staff 4; Homeroom Officer 4; Hi-Y 3; Le Cercle Francais 3, 4; Teen-Age Club 1, 2.

WILSON, BARBARA ANNIL

"Babs"

"God give them wisdom that have it; and those that are fools, let them use their talents."

Class Officer 1, 2, 3, 4; Chemistry Club 3; Dramatics 4; Glee Club 2, 3, 4; Library Club 3, 4; Le Cercle Francais 3, 4.

WILSON, WOODROW

"Woody"

"A mind only grows when it is kept open."

Art 1, 2; Chemistry Club 3; Class Officer 1, 2; Football 1, 2, 3, 4; Hi-Y 1, 2, 3, 4; Le Cercle Francais 3, 4; Student Council 2; Safety Patrol 2; Teen-Age 3.

WOOTEN, DAVIE EARL

"Dee"

"The harder the conflict, the more glorious the triumph."

Class Officer 3, 4; Teen-Age Club 1, 2, 3, 4.

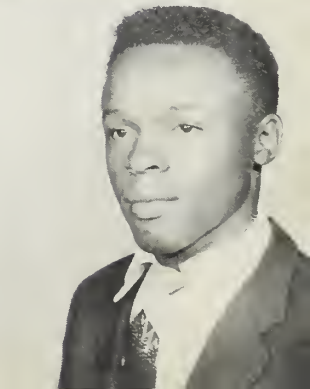

# Senior Superlatives



**MOST INTELLECTUAL**  
Isaac Artis and Evelyn Simpson



**MOST LIKELY TO SUCCEED**  
Sadie Clark and Roosevelt German



**MOST VERSATILE**  
James White and Jackie Outerbridge



**MOST DEPENDABLE**  
Quinton Baker and Faye Moore

# Senior Superlatives



WITTIEST  
Frederick Staton and Eleanor Edwards



BEST DRESSED  
Barbara Wilson and John Sledge



MOST ATTRACTIVE  
Calvin Deloatch and Hazel Randolph



MOST ATHLETIC  
Woodrow Wilson and Allie Reeves

# A Bit of Our History



Drafting of EPPESONION - 1960



Senior Class Meeting  
1960

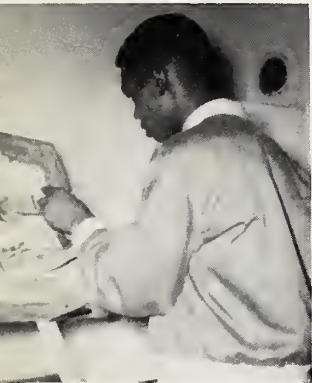

Hallmark Award Winner  
1959



Commencement - 1959



Lance's Sales - 1960

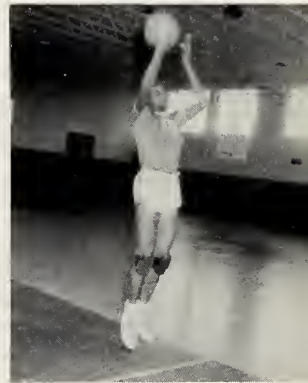

Staton Shoots - 1960



Chemistry was Fun - 1959



Queen's Coronation - 1958

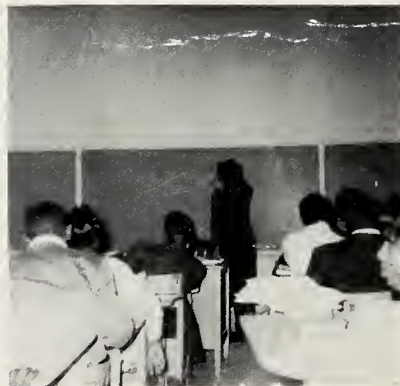

Geometry was Fun - 1959



Eligible to Enter  
Morehouse College  
1959



Sophomore Hop - 1958

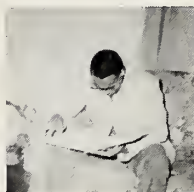

Admitted early to  
Morehouse College  
1958



After  
Commencement  
1959



End of Junior Year  
1959



J  
U  
N  
I  
O  
R  
S

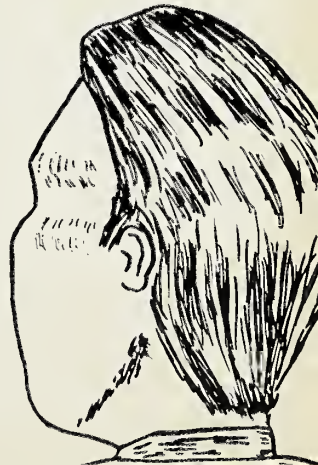
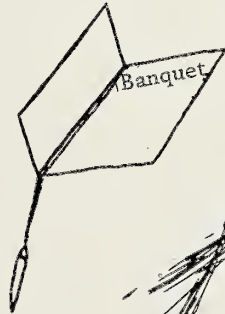



## Junior Class Officers

BENNIE MOORE..... President  
 EDWARD LOVE..... Vice-President  
 ELOIS SMITH..... Secretary  
 LILLIE HARDY..... Assistant Secretary

LUCILLE GORHAM.....Treasurer  
 FREDDY WATSON..... Business Manager  
 FRED HARRIS.....Parliamentarian

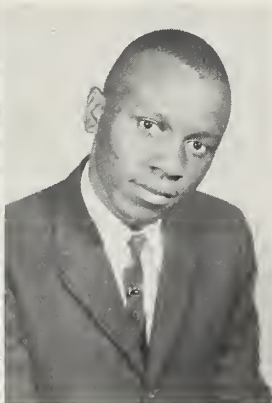
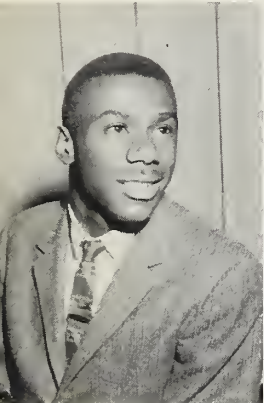

Adams, Marvin  
 Anderson, Willie  
 Arthur, Margaret



Barghen, Barbara  
 Barnes, Barbara  
 Barrett, James  
 Batts, Jessie

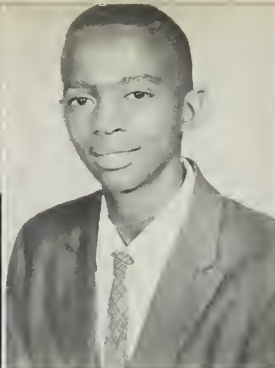

Bell, Louis  
Best, Artis



Forbes, Patricia  
Foust, Barbara

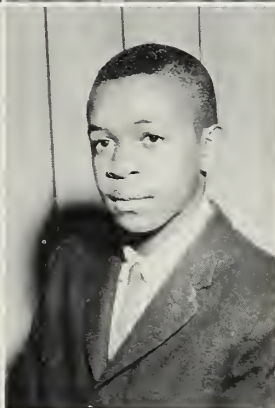
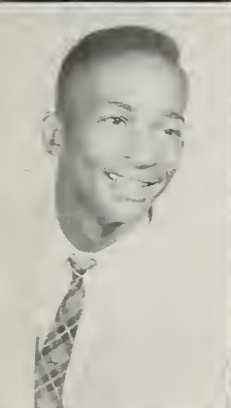

Best, Charlie  
Boyd, Marvin



Foust, Margaret  
Garrett, Marvin

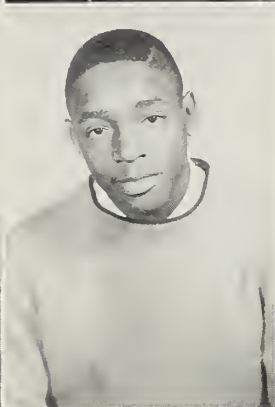

Brimage, Alexander  
Brown, David

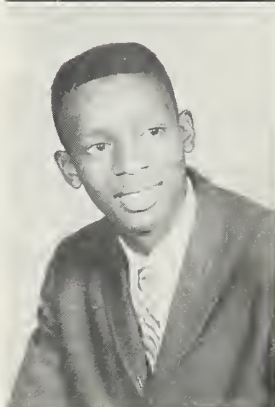

Gatlin, Calvin  
German, Marvin

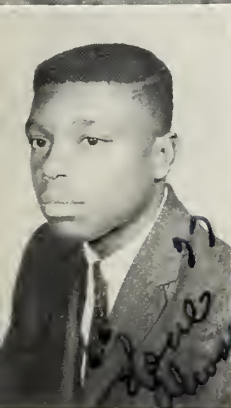

Cox, Leslie  
Davis, Alton



Gorham, Lucille  
Grady, Esther

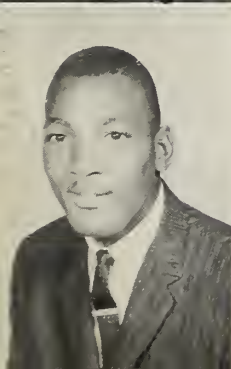

Duncan, James  
Dyer, Barbara

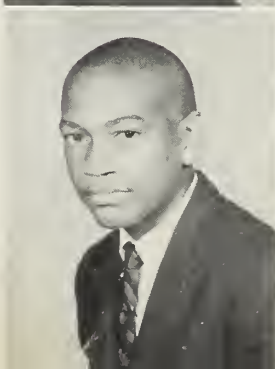

Graye, Charles  
Greene, Charles



Grimes, Jamesena  
Grimes, Leon



Hines, Dorothy  
Hines, Thomas

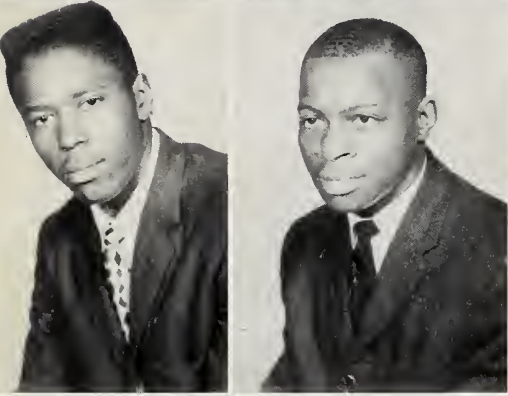

Hardison, Linwood  
Hardy, Larry



Hunt, Carolyn  
Jones, Polly

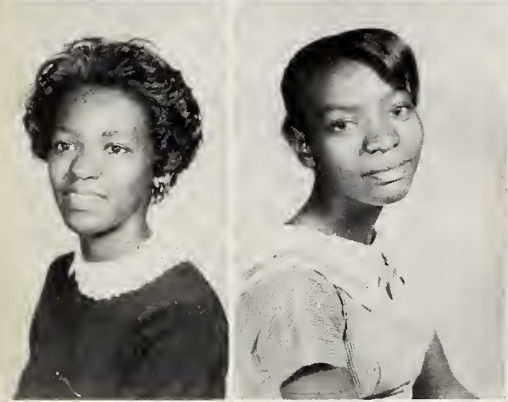

Hardy, Lillie  
Harrington, Lillie



Joyner, Joyce  
Joyner, Marine



Harris, Eric  
Harris, Fannie



Knox, Rosa  
Laughinghouse,  
Janzilean



Harris, Fred  
Hester, Cherry

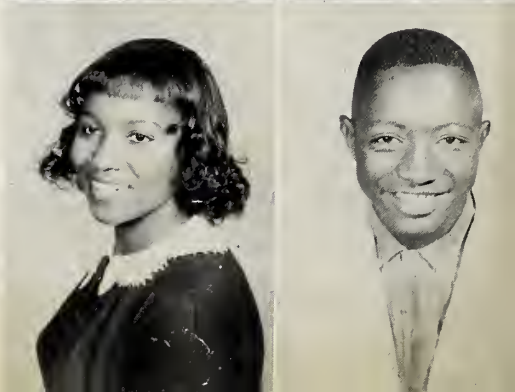

Leary, Phyllis  
Little, Billy



Little, Patricia  
Lofton, Delois



Moore, Arva  
Moore, Bennie

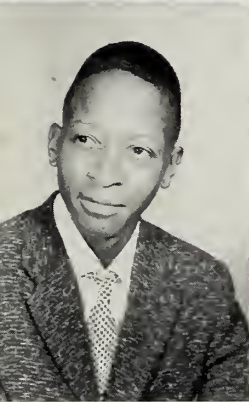

Lofton, Lemuel  
Love, Bertha

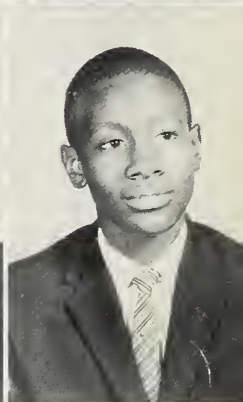

Moore, Evelyn  
Murrell, Alan



Love Edward  
Mann, Paul

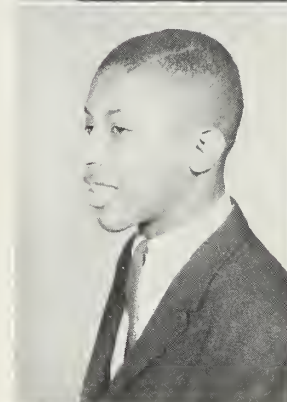

Myers, Robert  
Newton, David



May, Helen  
May, Mary



O'Neal, Floyd  
Parker, Margie



Miller, Coristine  
Moore, Arthur



Rasbury, Trevor  
Reaves, Jacquelyn



Short, David  
Short, Lucy



Stokes, Verna\*  
Streeter, Julius

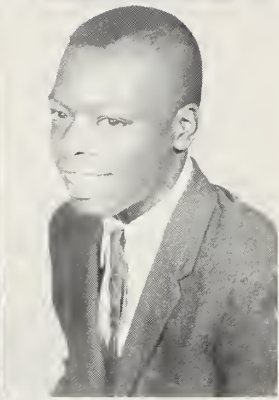

Short, Mamie  
Simmons, Alfonzo

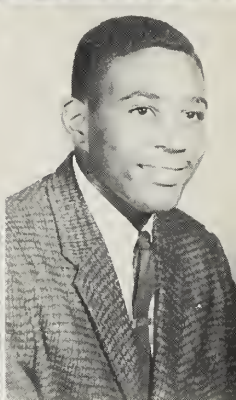
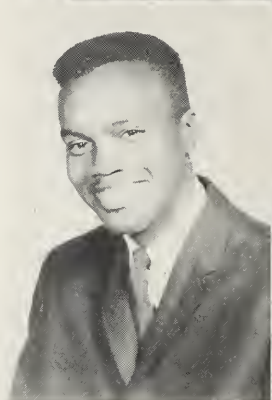

Thigpen, Rufus  
Tyson, Joe



Simmons, Samuel  
Smith, Arthur

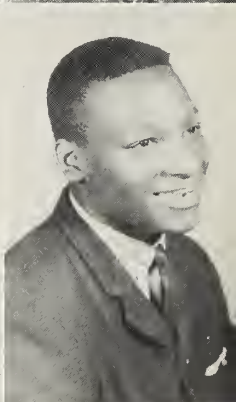

Wallace, Ethel  
Watson, Freddy

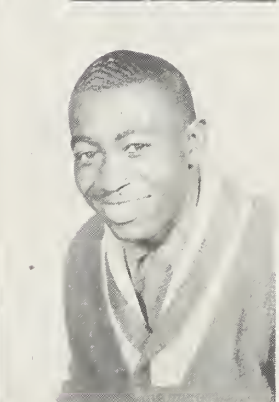

Smith, Elois  
Smith, Wilbert

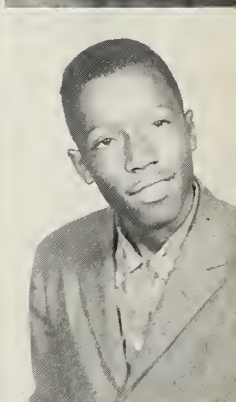

Whitehurst, Virginia  
Williams, Earl

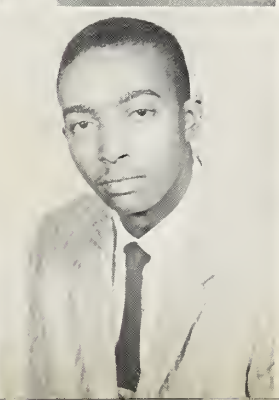

Sparkman, Johnnie  
Spruill, Linwood

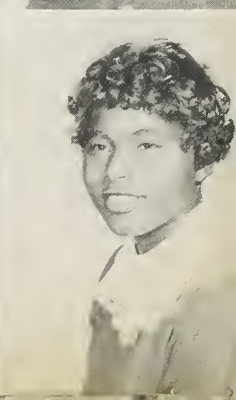

Williams, Jane  
Williams, Lena

\*Deceased  
26



Willoughby, Lawrence  
Wilson, Annie

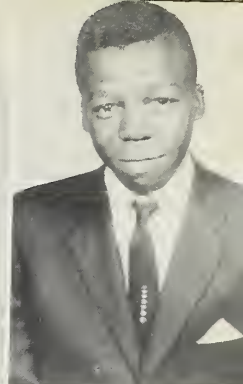

Wilson, Barbara  
Wooten, Norris

Not  
Pictured

Not  
Pictured

Not  
Pictured



Yarrell, Leander

Not  
Pictured

Not  
Pictured

NOT PICTURED:  
Adams, Willie  
Davis, Dalton  
Eaton, Ernest  
Pitt, Charles  
Tyson, James





Mary Daniels, President; James Ebron, Vice-President; Rosa Brewington, Secretary; Robert Gorham, Assistant Secretary; Calvin Forbes, Business Manager; Dennison Garrett, Treasurer.



Johnny Tyson, President; James Chapman, Vice-President; Jane Teel, Secretary; Mable Worthington, Assistant Secretary; Sarah Mouning, Treasurer.



S  
o  
p  
h  
o  
m  
o  
r  
e  
s



Mary Knox, President; Shirley Dupree, Vice-President; Delores Ross, Secretary; Sandra Grimes, Assistant Secretary; Lillian Savage, Treasurer.





Ronnie Teel, President; Jo Ann Bradley, Vice-President; Gloria Clemmons, Secretary; Barbara Tucker, Assistant Secretary; Frederick Bush, Treasurer; Billy Tucker, Business Manager.



Ella Tyson, President; Bennie Teel, Vice-President; Jackie Sparkman, Secretary; Carolyn Harris, Assistant Secretary; Nellie Ross, Treasurer; June Staton, Reporter; Alton Harris, Sergeant at Arms.

F  
r  
e  
s  
h  
m  
e  
n



Erma Baker, President; Christopher Anderson, Vice-President; Olive Armwood, Secretary; Lillian Tucker, Assistant Secretary; Leatha Jenkins, Treasurer; Willie Burton, Business Manager.



Joseph Wooten, President; Charles McWhorters, Vice-President; Joyce Chance, Secretary; Bettie Rasbury, Assistant Secretary; Jo Ann Laughinghouse, Treasurer; Ernestine Morris, Business Manager.

# Krazy Kaptions

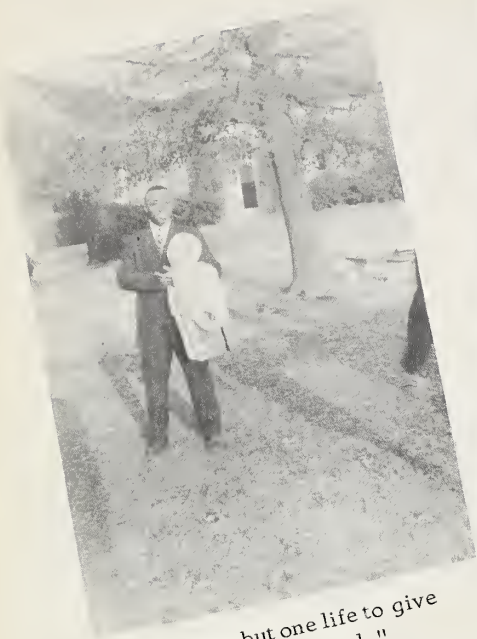

"I have but one life to give  
for my school."



"Now, I know I left that  
note somewhere in here."



"Hey! I can't find Dick  
Tracy in this paper."



"Do you want onions on  
your hot dog?"



"I think I have enough to  
buy her a soda."



"Say, man, can you tell me  
where Shakespeare's Mac-  
beth is?"



"I know I can find a mistake in this book."

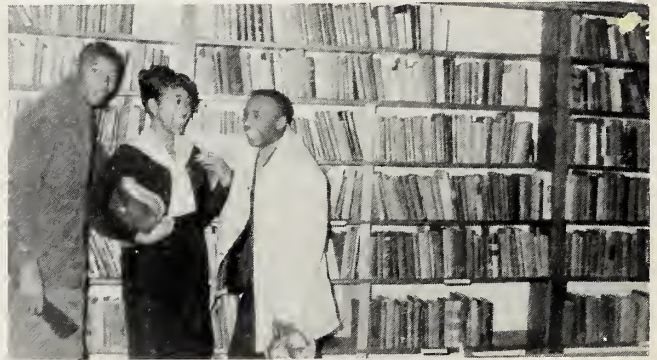

"They all said I had what it takes."

# A C T I V I T I E S



# Our Student Council



QUINTON BAKER  
President



James White, Vice-President; Sadie Clark, Secretary; Ella Tyson, Assistant Secretary; Mary Boyd, Treasurer; Linda Adams, Sergeant at Arms; Charles Greene, Business Manager; Willie Anderson, Chaplain.

MRS. M. G. THOMPSON  
Advisor



Barbara Barrow, Walter Murrell, Rosa Edwards, Robert White, James Mitchell, Magalene Armwood, Janzilean Laughinghouse, Ada Stocks, Sadie Clark, Ella Tyson, Gloria James, Sandra Grimes, Linda Adams, Willie Anderson, Charles Greene, John Lloyd.





## Our High School Glee Club

JACKIE OUTTERBRIDGE.....President  
CHARLES GREENE.....Vice-President  
QUINTON BAKER.....Secretary  
SADIE CLARK.....Treasurer  
BOBBIE WILKINS, WILLIE BREWINGTON.....Business Managers



## Our Band

- |                        |                     |
|------------------------|---------------------|
| JOHN SLEDGE.....       | BETTY WILKES.....   |
| FREDERICK STATION..... | SARAH DIXON.....    |
| MARY KNOX.....         | EVELYN SIMPSON..... |
|                        | Assistant Secretary |
|                        | Treasurer           |
|                        | Business Manager    |





# Our Drama Group



Getting Started



"Sunday Costs Five Pesos"



"The Answer"



The End



## Le Cercle Francais Deux

JULIUS MURPHY, JOEL STREETER.....Présidents  
 ANNIE EBRON, JAMES WHITE.....Vice-Présidents  
 MILDRED SHERROD, BETTYE FLEMING.....Secrétaires

MAGALENE ARMWOOD, ISSAC ARTIS..... Trésorieres  
 JAMES HARRINTON,  
 SADIE CLARK..... Chefs du Comité de Programme

## Le Cercle Francais Vn

FREDDIE WATSON, PHYLLIS LEARY.....Présidents  
 LARRY HARDY, BILLY ANDERSON.....Vice-Présidents  
 HELEN MAY, CAROLYN HUNT..... Secrétaires

DOROTHY HINES, ESTHER GRADY.....Trésorieres  
 BENNIE MOORE,  
 JAMESENA GRIMES..... Chefs du Comité de Programme





# Hi-Y

QUINTON BAKER.....	ERROL FORBES.....	Assistant Secretary
JAMES WHITE.....	LOUIS BELL.....	Treasurer
ISAAC ARTIS.....	JOHN SLEDGE.....	Business Manager

.....	President
.....	Vice-President
.....	Secretary



## Tri-Hi-Y

DORIS MYERS..... President  
 MARY MAY.....Vice-President  
 MAMIE SHORT.....Secretary  
 MARGARET FOUST..... Assistant Secretary

VIRGINIA WHITEHURST.....Treasurer  
 CAROL PERKINS..... Business Manager  
 TYREE WILKINS..... Sergeant at Arms  
 MARY BOYD..... Parliamentarian

## New Homemakers of America

SARAH DIXON..... President  
 GLORIA JAMES..... Vice-President  
 HELEN MAY..... Secretary

SANDRA GRIMES..... Assistant Secretary  
 NINA COREY.....Treasurer  
 ALLIE REEVES..... Business-Manager





## The Physics Club

JOEL STREETER..... President  
 JAMES WHITE..... Vice-President  
 EVELYN SIMPSON..... Secretary  
 JACKIE OUTERBRIDGE..... Assistant Secretary

FRED STATON..... Treasurer  
 JOHN SLEDGE..... Business Manager  
 JULIUS MURPHY..... Sergeant at Arms

## The Pen and Scroll Club

JOHN SLEDGE..... President  
 JAMES WHITE..... Vice-President  
 FAYE MOORE..... Secretary

EVELYN SIMPSON..... Assistant Secretary  
 ISAAC ARTIS..... Treasurer  
 JOEL STREETER..... Business Manager





QUINTON BAKER.....President  
MILDRED SHERROD.....Financial Secretary

JAMESENA GRIMES.....Recording Secretary  
BENNIE MOORE.....Treasurer

## Future Business Leaders of America

⓪⓪⓪⓪⓪⓪  
⓪⓪⓪⓪⓪⓪  
⓪⓪⓪⓪⓪⓪  
⓪⓪⓪⓪⓪⓪  
SPACE BAR





## Junior Red Cross Council

CAROLYN HUNT..... Chairman  
 JOEL STREETER..... Co-Chairman  
 JAMES FORBES..... Secretary

CAROLYN WATSON..... Assistant Secretary  
 JOSEPHINE JONES..... Treasurer

## Masonry

EDDIE HOLLOWAY..... President  
 LUKE WILLIAMS..... Vice-President

EARL WILLIAMS..... Secretary  
 DAVID WILKINS..... Treasurer

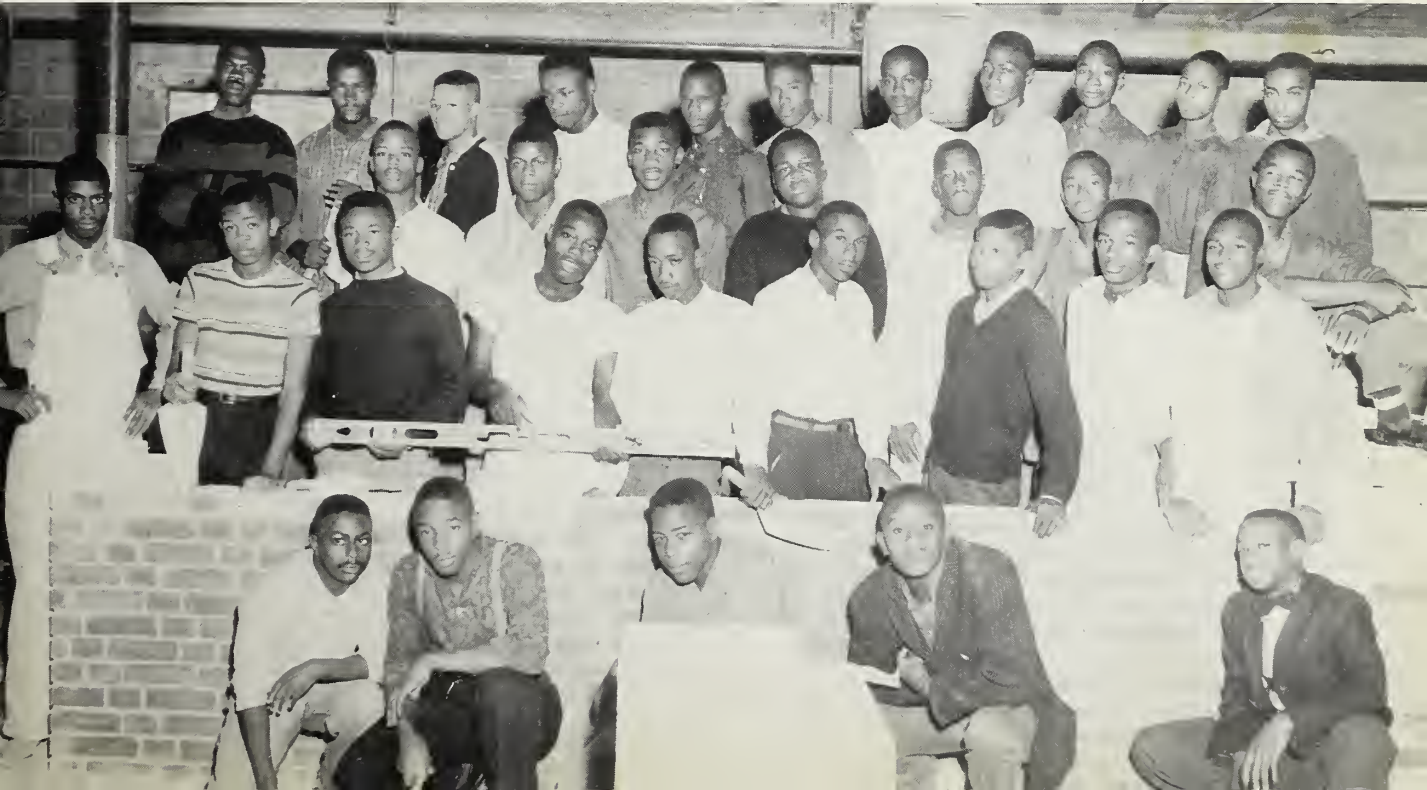



## Our Junior Drama Group

ROSA EDWARDS..... President  
 GERALDINE MAYE..... Vice-President  
 SANDRA EARLY..... Secretary

MAVIS GARDNER..... Treasurer  
 EDNA ADAMS..... Business Manager

## Our Elementary Chorus

EARL GARDNER..... President  
 PATRICIA LEE..... Vice-President  
 MITCHELL WILLIAMS..... Secretary

VICEY JONES..... Assistant Secretary  
 TER RHEE MOORE..... Treasurer  
 GWENDOLYN PIERCE..... Reporter







## Our Flutophone Orchestra

CAROLYN WATSON.....President  
 EARL GARDNER..... Vice-President  
 VICEY JONES..... Secretary

BARBARA HUNT..... Assistant Secretary  
 JOSETTA GODETTE..... Treasurer  
 CARRIE WILKES..... Business Manager

## Our Library Club

PATRICIA GRIMES..... President  
 LEMON BARNES..... Vice-President  
 ALMA MORRIS..... Secretary

WILLIE BURTON..... Assistant Secretary  
 ISAAC ARTIS..... Business Manager  
 ERROL FORBES..... Sergeant at Arms





# OUR ATHLETICS



EPPE'S FIGHT SONG

Our Boys will win this game tonight  
For Dear Ole Eppes;  
They will not shame the Blue and White  
Of Deal Ole Eppes!  
With a Rah! Rah! Rah! Rah!  
We'll stand with all our might,  
Teaming to win this fight -  
Our boys will win the game tonight  
For Dear Ole Eppes.

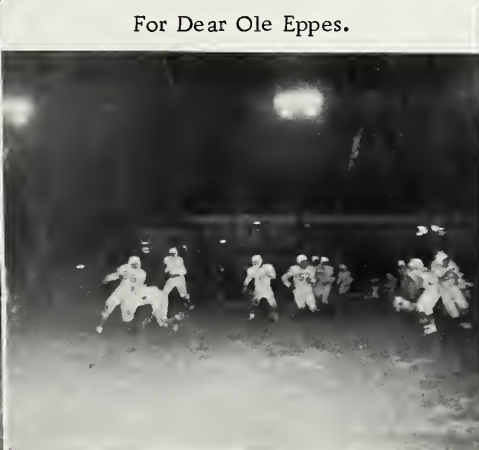

# Our Queens

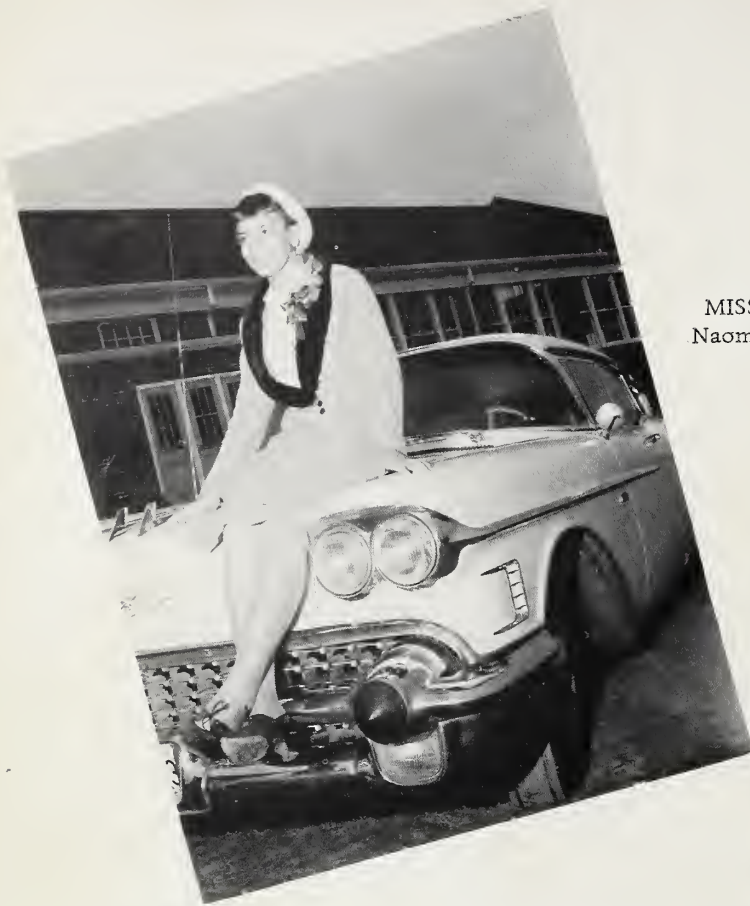

MISS EPPES  
Naomi Jenkins



MISS HOMECOMING  
Phyllis Leary



MISS SOPHOMORE  
Jane Teel

MISS FRESHMAN  
Eula Clemmons



# The Football Team

CALVIN GATLIN.....Captain  
 JOE TYSON.....Co-Captain

WALTER MURRELL.....Trainer





# Varsity Basketball

## Junior Varsity Basketball

JOE TYSON, CALVIN GATLIN.....Co-Captains  
MR. OSBORNE METEYE..... Coach

JOHNNY TYSON, HERBERT TUCKER..Co-Captains  
MR. C. Z. DAVIS..... Coach



# Senior Athletes

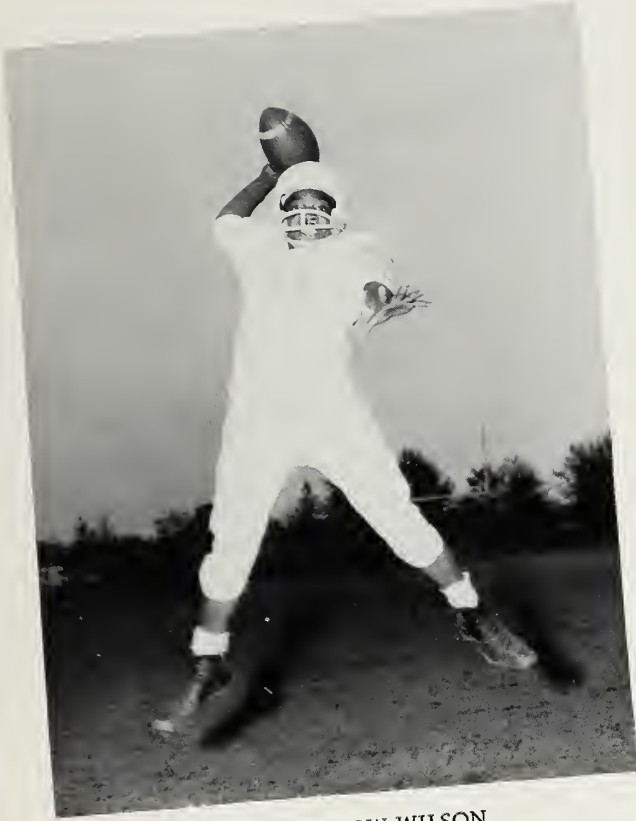

WOODROW WILSON

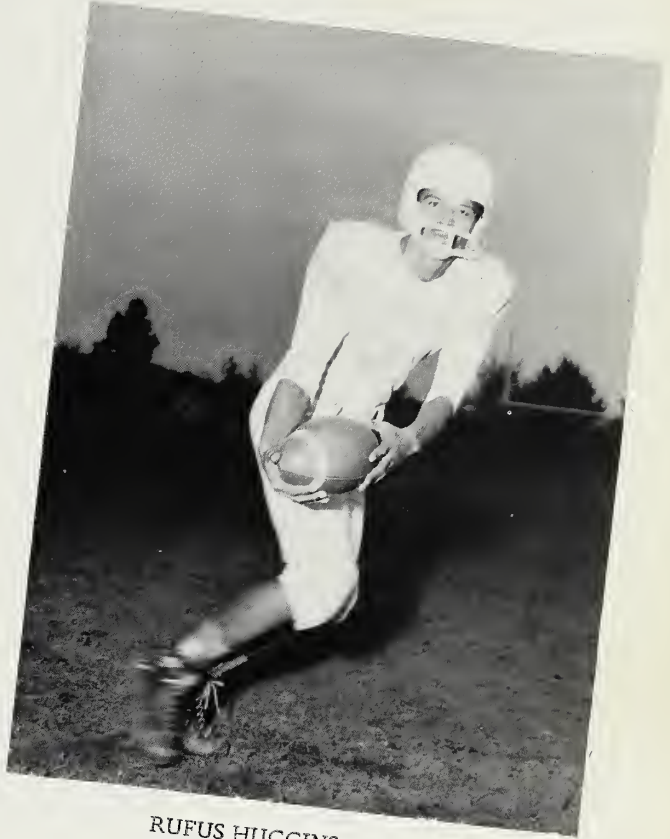

RUFUS HUGGINS



WILLIE BREWINGTON

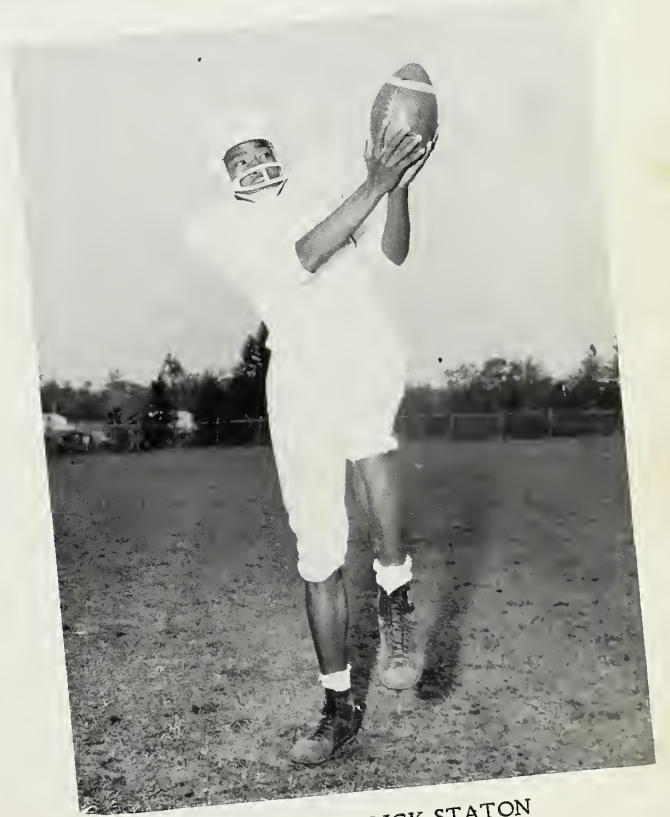

FREDERICK STATON



# Girls' Physical Education

MISS CHARLOTTE JENKINS  
Instructor







# Boys' Physical Education

MR. OSBORNE METEYE  
Instructor

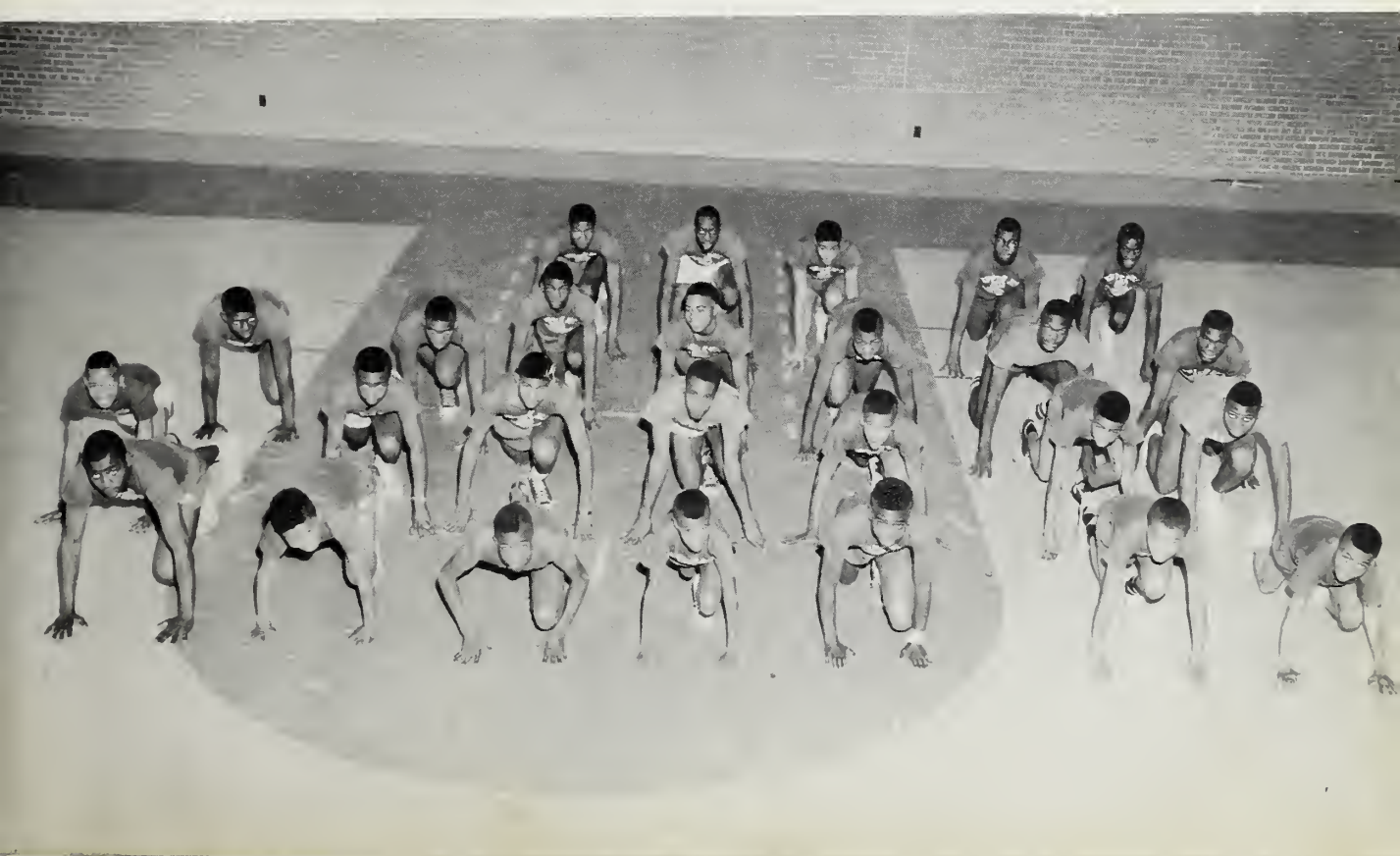



## Cheerleaders

Lucille Gorham, Jamesena Grimes, Jean Short, Elois Smith, Jean Bennett, Charles Greene, Captain; Shirley Dupree.

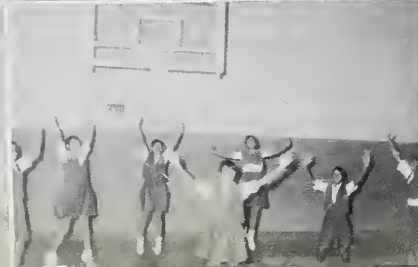

# OUR UNDERCLASSMEN

## Eighth Grades



ROSA EDWARDS.....President  
MILDRED LOVE..... Vice-President

GILDA LITTLE..... Secretary  
MILDRED DONALDSON..... Treasurer



SANDRA EARLY.....President  
JAMES NOBLES..... Vice-President  
DOROTHY BROWN..... Secretary

LAURAETTA TEEL.....Assistant Secretary  
LAURAETTA TEEL.....Treasurer  
ROSCOE HOPKINS..... Business Manager



JAMES MITCHELL ..... President  
 LARRY JOYNER ..... Vice-President  
 EVELYN HOWARD ..... Secretary

CHRISTINE HARRIS ..... Treasurer  
 FRANK ROLLINGS, BETTY REAVES...Sergeant at Arms  
 BARBARA TAFT .....Business Manager



JAMES BARNES ..... President  
 MAVIS GARDNER ..... Vice-President  
 BARBARA KEEL ..... Secretary  
 PATRICIA FORBES ..... Assistant Secretary

GLORIA BOYD ..... Treasurer  
 CALVIN FIELDS ..... Business Manager  
 THERESA PIERCE .....Reporter

# Seventh Grades



LILLIE HOPKINS ..... President  
 CAROLYN WATSON ..... Vice-President  
 JOHN ARMWOOD ..... Secretary  
 MARY THIGPEN ..... Assistant Secretary

PEGGIE WORTHINGTON ..... Treasurer  
 VANCE NEWTON ..... Sergeant at Arms  
 JIMMIE BLOUNT ..... Reporter



BARBARA WILKES ..... President  
 FREDERICK WILLIAMS ..... Vice-President  
 BARBARA HUNT ..... Secretary  
 ROSETTA WALLACE ..... Assistant Secretary

BEULAH CHANCE ..... Treasurer  
 LAURA BRADLEY ..... Sergeant at Arms  
 VERNA MOORE ..... Reporter



ANNIE BARROW ..... President  
 PATRICIA LEE ..... Vice-President  
 VICEY JONES ..... Secretary

JAMES McLAWHORN ..... Assistant Secretary  
 JOSETTA GODETTE ..... Treasurer

## Sixth Grades



LINDA SPELL ..... President  
 ANNIE MILLER ..... Vice-President  
 QUINNIE DANIELS ..... Secretary

FRANCES COREY ..... Assistant Secretary  
 SANDRA MYERS ..... Sergeant at Arms



DOROTHY WILKES ..... President  
 MARTHA WILKES ..... Vice-President  
 MARY BATTLE ..... Secretary

VIVIAN BRADLEY ..... Assistant Secretary  
 MITCHELL WILLIAMS ..... Treasurer



GWENDOLYN PIERCE ..... President  
 BETTIE EARLY ..... Secretary

BILLIE BARRETT ..... Business Manager  
 JOCELYN JONES ..... Treasurer



JAMES BROWN ..... President  
 JAMES LOFTON ..... Vice-President  
 IRENE WORTHINGTON ..... Secretary

GERALDINE PUGH ..... Assistant Secretary  
 ROOSEVELT JOHNSON ..... Treasurer  
 LOUIS WORTHINGTON ..... Business Manager

## Fifth Grades



BERNADETTE GREGORY ..... President  
 GWENDOLYN GOINES ..... Vice-President  
 BEULAH SHERROD ..... Secretary

JOE SMITH ..... Assistant Secretary  
 ARDRIA MURRELL ..... Treasurer





WILLIAM TUCKER ..... President  
 TRAVIS DUNCAN ..... Vice-President  
 MYRA BRADLEY ..... Secretary

ALLIE GATLIN ..... Assistant Secretary  
 JOHN WILKES ..... Treasurer



PATRICIA MOYE ..... President  
 SADIE BATTLE ..... Vice-President  
 LYDIA JOYNER ..... Secretary  
 JOYCE HEATH ..... Assistant Secretary

BARBARA TYSON ..... Treasurer  
 THOMAS THIGPEN ..... Reporter  
 FRANK MOYE ..... Sergeant at Arms



CALVIN SMITH ..... President  
 EDNA CORBETT ..... Vice-President  
 LUCETTE SMITH ..... Secretary

MATILDA KNIGHT ..... Assistant Secretary  
 SHIRLEY ADAMS ..... Treasurer



A  
D  
V  
E  
R  
T  
I  
S  
E  
M  
E  
N  
T  
S



# Our Friends

- Mr. and Mrs. Dixie Adams  
Mrs. Elsie Adams  
Mr. and Mrs. Ernest C. Adams  
Miss J.M. Alexander  
Mr. J.S. Alexander  
Mrs. Jean Allen  
Mrs. Lillie B. Allen  
Mrs. L.E. Averwart  
Mr. and Mrs. Herman Baker  
Mrs. D.A. Barnhill  
Mr. and Mrs. James Barnhill  
Mr. and Mrs. Joe Battle  
Mr. and Mrs. Charles Bell  
Miss Annie R. Bembyr  
Mrs. Mary Bennett  
Dr. Andrew A. Best  
Mr. and Mrs. Lester Best  
Mr. and Mrs. John H. Bizzell  
Mr. and Mrs. L.B. Blount  
Mr. Robert E. Blue  
Mr. and Mrs. Raymond Brewington  
Mrs. Sudie S. Briley  
Mr. Ralph S. Broughton  
Mr. and Mrs. James Brown  
Mrs. J.H. Brown  
Reverend and Mrs. R.D. Brown  
Mrs. Lucy Bryant  
Mrs. Julia Calhorne  
Mrs. Amelia Capehart  
Mrs. Martha Lee Carr  
Mrs. Beulah N. Chance  
Mrs. Claudia Chance  
Mr. Luther Chance  
Mr. and Mrs. Z.R. Chance  
Mr. Robert L. Chancy  
Miss Alice Chestnut  
Miss Christine B. Clark  
Reverend and Mrs. Shady Clark  
Mr. William A. Clark  
Mr. Mose Clemmons  
Mr. and Mrs. Charles Cobb  
Mrs. Hattie Mae Cobb  
Miss Mamie Ruth Corey  
Mr. A.F. Denese  
Miss Vera Dixon  
Mrs. Eula Donaldson  
Mr. and Mrs. Ulysses Dunn  
Mr. Andrew Dupree  
Mr. and Mrs. James Ebron  
Mr. and Mrs. W.E. Flanagan  
Mrs. Ed. Fleming  
Mrs. Olivier Floyd  
Mrs. Araminta Forbes  
Mr. Charlie Forbes  
Mr. and Mrs. James E. Forbes  
Mrs. Ruby Forbes  
Mr. Willie S. Forbes  
Miss Catherine Foreman  
Mr. and Mrs. Albert Foust, Jr.  
Mrs. Gertrude Gardner  
Mr. and Mrs. Rufus Gardner  
Mrs. Edna Glover  
Mr. Joseph L. Godette  
Mrs. Evangeline Gooden  
Mr. and Mrs. George Gorham  
Miss Magnolia Gorham  
Mr. and Mrs. Raymond Grady  
Dr. C.R. Graves  
Mrs. Helen Greene  
Mr. John H. Greene  
Mr. and Mrs. J. W. Griffin  
Mrs. Rebecca Griffin  
Mr. and Mrs. Jesse Grimes  
Mr. and Mrs. J.W. Grimes  
Mr. Lawrence B. Hagans  
Mr. H.S. Hardee  
Mrs. Nora Hardy  
Mr. David Harris  
Mr. and Mrs. Floyd Harris  
Mr. Frank Harris  
Miss Lillie Harris  
Mr. T.H. Harris  
Mr. Thomas Hazleton  
Mr. and Mrs. Willie Hester  
Mrs. Eula Highsmith  
Mr. and Mrs. A.C. Hill  
Mrs. Mae Belle Hines  
Mrs. Olivia Hines  
Mrs. Annie Holloman  
Mr. and Mrs. George Horne  
Mrs. Mary Hyman  
Mrs. Fannie Jackson  
Mrs. Bessie James  
Mrs. Fannie Jenkins  
Mrs. Mary Jenkins  
Mr. and Mrs. G.H. Jenkins  
Mr. and Mrs. J.C. Johnson  
Mrs. Odessa Johnson  
Mr. James Jones  
Mrs. Jimmy Jones  
Mr. and Mrs. William E. Jones  
Mrs. Lelia Joyner  
Mr. and Mrs. Robert Joyner  
Mr. Willie Joyner  
Miss Carolyn Keel  
Reverend S.T. Killibrew  
Miss Hattie King  
Miss Arie Virginia Knox  
Miss V.L. Langley  
Mr. Willie Langley  
Mr. and Mrs. J.C. Lawrence  
Mr. and Mrs. James O. Lee  
Mr. and Mrs. Matthew Lewis  
Mr. and Mrs. Lemon Little, Sr.  
Mr. and Mrs. Lemuel Little  
Mr. Roy Little  
Mr. and Mrs. John Lucas  
Mrs. C.K. Marshmond  
Mr. and Mrs. C.C. McGlone  
Mrs. Roy McKeithan  
Reverend and Mrs. M.N. Midgette  
Mr. W.D. Miller  
Mr. and Mrs. Thomas Mitchell  
Mrs. Priscilla Moore  
Mr. and Mrs. Willie B. Moore  
Mrs. Bessie Mosely  
Mr. Morris Moye  
Mrs. Naomia Mouning  
Miss Sarah Mumford  
Mr. and Mrs. William Nobles  
Mr. and Mrs. Frank Norris, Sr.  
Mr. David Lee Parker  
Miss Rosa Lee Parker  
Mr. and Mrs. Lawrence Perkins  
Mr. and Mrs. Walter Perkins  
Mrs. Edna M. Peterson  
Mr. and Mrs. Donovan Phillips  
Mr. and Mrs. R.M. Phillips  
Miss S.A. Phillips  
Mr. Norman Pollard  
Atty. and Mrs. Richard Powell  
Miss Hazel Power  
Mrs. Richard Powers  
Mrs. Florence Randolph  
Miss Lucille Rich  
Reverend and Mrs. Robert B. Richardson  
Reverend O.J. Rooks  
Mrs. Sadie T. Rooks  
Miss S.I. Saulter  
Mrs. S.L. Savage  
Mr. and Mrs. Joe T. Scott  
Mr. and Mrs. Lyman Scott  
Mr. and Mrs. Raymond Scott  
Miss Delois Sherrod  
Miss Geraldine Sherrod  
Mr. and Mrs. Ulycees Simpson  
Mrs. Gladys M. Smith  
Mrs. Mary Smith  
Mrs. Mattie Spain  
Mr. and Mrs. Noah Spain  
Mrs. Rosa Sparkman  
Miss Alberta Speight  
Mr. and Mrs. W.H. Spell  
Mrs. Dora Stancil  
Miss Cora Belle Stepherson  
Mr. and Mrs. Norman Sutton  
Mr. and Mrs. Collin Taft  
Mr. Johnny Taft  
Reverend and Mrs. John H. Taylor  
Mrs. L.R. Taylor  
Mrs. Louise Tucker  
Mr. and Mrs. Otis Tucker  
Mr. Robert Tucker  
Miss Frances Vines  
Mrs. Sallie Ann Walker  
Mr. Clarence Walters  
Mr. and Mrs. Herman Walters  
Miss Barbara J. Watson  
Miss Rubie Watson  
Mr. and Mrs. Ernest Whichard  
Mr. and Mrs. George R. Whitfield  
Mrs. Josephine Wyche  
Miss E.G. Wiggins  
Miss Vernie Wilder  
Mrs. Irene Williams  
Mrs. Jessie M. Williams  
Mrs. Mary Ruth Williams  
Mr. and Mrs. Ronald Wilson  
Mrs. J.E. Winslow  
Mrs. Virginia Winston  
Mr. and Mrs. Samuel Woodlary  
Mr. and Mrs. Moses Wooten  
Mrs. Olive Wooten  
Mr. and Mrs. Harry Worthington  
Miss Sylvia J. Yarell

Compliments of  
**NEW DEAL CLEANERS**

"Personalized Service"

Phone PL 2-4576  
911 West Fifth Street

Compliments of  
**THE DAILY REFLECTOR**

"Truth in Preference to  
Fiction"

Phone PL 2-6166  
209 Cotanche Street  
Greenville, North Carolina

**THREE GUYS FROM DIXIE**  
Clothes Sporting Goods  
Dial PL 2-4155  
629 Dickinson Avenue

Compliments of  
**HOME AND AUTO SUPPLY**  
"Your Sylvania Dealer"  
East Fifth Street

**EATON'S SHELL STATION**  
Dial PL 2-3850  
601 Albemarle Avenue

Compliments of  
**PITT HARDWARE**  
718 Dickinson Avenue

Compliments of  
**STELENS**  
"Clothes for Every Woman"  
323 Evans Street

Best Wishes from  
**LARRY'S SHOE STORE**  
431 Evans Street

**PERKINS-PROCTOR**  
"The House of Name Brands"  
Phone PL 8-1336  
201 East Fifth Street

**HARRISON'S DRUG STORE**  
Prescription Druggists  
Phone PL 2-2450  
908 Dickinson Avenue

Next Time Visit  
**BISSETTE'S DRUG STORE**  
"Where Spending Means Saving"

Phone PL 2-3131  
416 Evans Street

**PHILLIPS BROTHERS  
FUNERAL HOME**

Mutual Burial Association  
Phone Night Phone Night  
PL 2-5281 PL 2-4784  
Phone Day  
PL 2-2536  
614 McKinley Avenue

Compliments of  
BEST JEWELRY STORE  
"Eastern Carolina's Leading Jewelers"

Compliments of  
STATON BEAUTY SALON  
Phone PL 2-4166  
1115 Douglas Avenue  
Greenville, North Carolina

GEORGE PUGH'S  
Shell Service Station

Best Wishes from  
LANGLEY'S GROCERY  
Groceries Meats  
808 Fleming Street

SINCLAIR  
REFINING COMPANY

J.G. Clark, Marketer  
Phone PL 2-2341  
Greenville, North Carolina

ASKEW'S

"Your One-Stop  
Shopping Center"  
901 West Fifth Street  
Greenville, North Carolina

BEN'S AUTO REPAIR SERVICE  
*Speedometer  
Service*

Superior Auto Repair Service  
Our Work Guaranteed  
Ben Roberson, Prop.  
416 Hudson Street  
Phone PL 2-5946

Best Wishes from  
PEPSI-COLA BOTTLING  
COMPANY  
Greenville, North Carolina

Best Wishes  
H. L. HODGES & COMPANY  
Phone PL 2-4156  
210 East Fifth Street

GARRIS SUPPLY  
Furniture and Appliances  
505 Dickinson Avenue  
Greenville

Compliments of  
HOME FURNITURE STORE  
Phone PL 2-2879  
701 Dickinson Avenue

Compliments of  
CITIZENS ICE COMPANY  
506 Albemarle Avenue  
Greenville

Congratulations to The Class of 1960!

**BRODY'S**

422 Evans Street

Greenville, North Carolina

JEFFERSON  
FLORIST  
Dial PL 2-6195  
Greenville



Compliments of  
VANDYKE FURNITURE STORE  
531 Dickinson Avenue  
Phone PL 2-2654

Best Wishes  
from  
WHITE'S STORES

Compliments of  
WEST END TEA ROOM  
113 West Fifth Street

Compliments of

**BLOUNT-HARVEY DEPARTMENT STORE**

"Eastern Carolina's Shopping Center"

Congratulations to The Class of 1960!

**JACKSON'S SHOE STORE**

Home of  
"Red Goose Shoes"

Compliments of  
QUALITY CLEANERS

COLLINS-PRIDMORE  
DEPARTMENT STORE  
"Your All-Family Store"

Compliments of  
FISHER'S APPLIANCES  
926 Dickinson Avenue

Best Wishes  
GOOR'S SHOE SHOP  
"Your Worn-Out Heels  
and Soles Are Our Business"  
805 Dickinson Avenue

Best Wishes of

**SAAD'S SHOE SHOP**

133 Grande Avenue

Phone PL 8-1228

Phone PLaza 8-1226  
Cars Called For and Delivered

## JONES ESSO SERVICE

Open 'til Midnight  
Credit Cards Honored

500 Albemarle Avenue  
Greenville, North Carolina

M.N. Perkins  
Representing

## M. N. PERKINS COMPANY AND UNIVERSITY CAP AND GOWN CO.

Lawrence, Massachusetts

# Congratulations

to the class of 1960

## L. G. BALFOUR COMPANY

Makers of Class Jewelry

E.L. Smith, District Salesman

Goldsboro, North Carolina



Compliments of

**VAN'S HARDWARE**

1300 North Greene Street  
Greenville, North Carolina

**Belk-Tyler's**

Phone PL 8-2176  
115 East Fifth Street

"Clothing for Everyone"

Compliments of

**GUARANTY BANK AND TRUST COMPANY**

The Bank for YOUR Money

Congratulations to Seniors of '60!

**HARRIS SUPERMARKET**

Compliments of

**COX ARMATURE WORKS**

2255 South Dickinson Avenue

Phone PL 8-1185

Best Wishes from

**SCOTT'S DRY CLEANERS**

119 East Third Street

**FLEETWAY DRIVE-IN CLEANERS**

"The Cleanest Clean  
Ye Ever Seen"

Phone PL 2-4808  
1401 West Fifth Street

Next Time

Visit

**HOLLOWELL'S DRUG STORE**

Phone PL 2-7105  
918 Dickinson Avenue

Compliments of

**LANCE**

Products

Phone PL 8-1655

Congratulations  
and  
Best Wishes

**THE MODERNETTES SOCIAL  
CLUB**

**STEINBECK'S**

"The Very Latest Styles  
at Moderate Prices"

Phone PL 2-7076  
427 Evans Street

**D. D. GARRETT  
INSURANCE AGENCY**

"Every Home Needs  
Insurance Protection"

Dial PL 2-4476  
107 East Second Street

Best Wishes  
from

**GRANT BELL & SONS'  
ENTERPRISES**

Greenville

North Carolina

Compliments of

**NORTH CAROLINA MUTUAL  
LIFE INSURANCE COMPANY**

J. C. Lawrence

Staff Manager

Congratulations  
Seniors!

**THE ELCONIPS**

Best Wishes

**COZART'S SUPERMARKET**

"A Complete Food Store"

2105 Dickinson Avenue  
Greenville, North Carolina

DRUMS' HATCHERY  
AND FEED STORE  
N.C. - U.S. APPROVED  
Chicks - Seed - Hardware  
West End Circle

Compliments of  
SERVICE BARBER SHOP  
117 North Evans Street  
Greenville, North Carolina

V.A. MERRITT AND SONS  
"Your Quality Maytag Dealers"  
207 Evans Street  
Phone PL 2-3736

HOME BUILDERS SUPPLY  
COMPANY  
2000 Dickinson Avenue  
Greenville, North Carolina

Congratulations Seniors!

## ROYAL CROWN BOTTLING COMPANY

Airport Road

PL 8-1224

Compliments of  
HENDRIX-BARNHILL COMPANY  
2004 Dickinson Avenue

BARTLETT & SONS' GROCERY  
Fresh Meats and Vegetables  
Phone PL 8-1385  
509 Sheppard Street

FARROWS AUTO BODY WORKS  
Phone PL 2-3694  
105 Ione Street

Compliments of  
GREENVILLE MARBLE  
AND GRANITE WORKS  
West Dickinson Avenue

Compliments of

## CAROLINA DAIRY PRODUCTS

308 Washington Street

Compliments of  
BATTS GROCERY  
1117 West Third Street

Compliments of  
BARRETT'S SODA SHOP  
1300 West Fifth Street

Compliments of  
CIRCLE BARBER SHOP  
Phone PL 8-1921  
West End Circle

Compliments of  
PITT STREET TAXI  
Phone PL 8-2286 Greenville

Compliments of  
GRADY'S BEAUTY SALON  
Mrs. Esther Grady, Prop.  
1703 S. Pitt Street  
Phone PL 2-4163

GREENVILLE TV  
AND APPLIANCE CENTER  
Phone PL 2-2616  
921 Dickinson Avenue

Best Wishes  
from  
PITT COUNTY AUTO  
ASSOCIATION

## DIXON SCHOOL PHOTOGRAPHY

Telephone  
Office  
LI 7-7971

Office  
Hours  
8 A.M.  
to  
9 A.M.

Portraits  
of Distinction

FRANK DIXON

Norfolk, Virginia

Compliments of  
THE REVERENED E. T. FORBES

The EPPESONION STAFF wishes to thank all individuals, groups, and firms whose patronage and advertisements have helped to make this yearbook possible.







